





## Boren

HSS-boren

VHM boren

Ruimers

1

## Schroefdraad

Tappen

Circulair- en schroefdraadfrezen

Draadsnijgereedschappen

2

## Draaien

Draaigereedschappen

EcoCut

Steekgereedschappen

Miniatuur draaigereedschappen

3

## Frezen

VHM frezen

4

## Spannen

5

Materiaalvoorbeelden en  
artikelnr.-index

6

# Inhoudsopgave

Overzicht	2
Programma	3-32
Technische informatie	33

WNT MASTERTOOL  
PERFORMANCE

Premium-kwaliteitsgereedschappen voor de hoogste performance.

De premium-kwaliteitsgereedschappen uit de **WNT Mastertool Performance** productlijn zijn voor speciale toepassingen ontworpen en kenmerken zich door hun buitengewone efficiëntie. Indien u in uw productie de hoogste eisen aan performance stelt en de allerbeste resultaten wilt bereiken, dan bevelen wij u de premium gereedschappen uit deze productlijn aan.

## Overzicht

### Drukspantangen



→ 3-11

Drukspantangen voor het klemmen van de staf aan de hoofdspil, alsmede voor het klemmen aan de subspil

### Geleidebussen



→ 15-24

Garandeert de geleiding van de staf aan de hoofdspil

### Verlengde spantangen



→ 12-14

Met aangepaste voorkant voor beter overnemen van de werkstukken en voor betere toegankelijkheid aan de achterzijde

### Aanvoertangen



→ 25-32

Aanvoertangen voor laadmagazijnen van stangenladers

**i** Meer profielvormen en groottes, alsmede meer opties, op aanvraag leverbaar.

## Highlights

- Precisie „Made in Germany“ betrouwbare kwaliteit
- Hoogste rondloopnauwkeurigheden vermindert trillingen
- Verkrijgbaar in een gegroefde uitvoering verhoogt de klemkracht significant
- Alle relevante vlakken zijn „precisiegeslepen“ verhoogt de werkstuknauwkeurigheid
- Verkrijgbaar in een gladde uitvoering geen afdrukken in het werkstuk

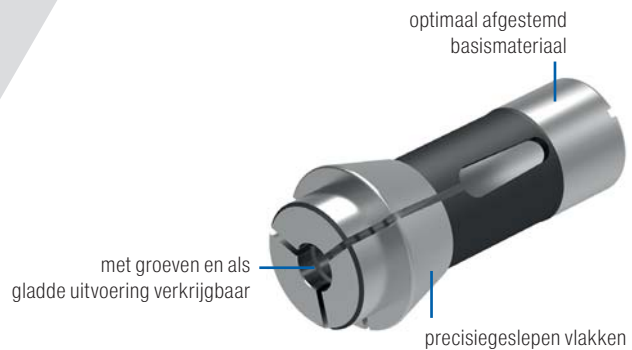

## Overzicht drukspantangen

Norm	bereik klemdiameter in mm	profiel	Uitvoering	pagina
116E	Ø 6,0 - 10,0	●	groeven	4
	Ø 1,0 - 10,0		glad	4
120E	Ø 6,0 - 12,0	●	groeven	4
	Ø 1,0 - 12,0		glad	4
F16	Ø 1,0 - 13,0	●	groeven	5
	Ø 6,0 - 13,0		glad	5
136E	Ø 6,0 - 16,0	●	groeven	6
	Ø 1,0 - 16,0		glad	6
138E	Ø 6,0 - 16,0	●	groeven	6
	Ø 1,0 - 16,0		glad	6
145E	Ø 6,0 - 20,0	●	groeven	7+8
	Ø 1,5 - 20,0		glad	7+8
F37	Ø 6,0 - 32,0	●	groeven	9-11
	Ø 1,0 - 32,0		glad	9-11
120E	SW 2,0 - 11,0	⬡	groeven*	4
138E	SW 2,0 - 14,0	⬡	groeven*	6
145E	SW 2,0 - 19,0	⬡	groeven*	7+8
F37	SW 3,0 - 27,0	⬡	groeven*	9-11
145E	SW 2,0 - 15,0	■	groeven*	7+8
F37	SW 3,0 - 23,0	■	groeven*	9-11

\* groeven pas vanaf SW 8

# Drukspantangen

omschrijving	d DGUI mm	D DFC mm	A DCLC mm	I LCLC mm	L <sub>1</sub> OAL mm	K°
116 E / F 13	13	19	13	6	64	16
120 E / F 15	15	21	15	6	64	16

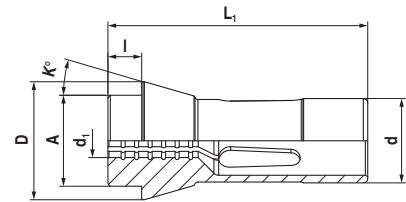

## 116 E / F 13

## 120 E / F 15



● groeven  
116 E / F 13

● glad  
116 E / F 13

● groeven  
120 E / F 15

● glad  
120 E / F 15

● groeven  
120 E / F 15

d <sub>1</sub> DCONWS mm	NEW Y8		NEW Y8	
	bestelnr. 81 000 ...	EUR	bestelnr. 81 002 ...	EUR
1,0			134,50	01000
1,5			134,50	01500
2,0			134,50	02000
2,5			134,50	02500
3,0			46,06	03000
3,5			46,06	03500
4,0			46,06	04000
4,5			46,06	04500
5,0			46,06	05000
5,5			46,06	05500
6,0	46,06	06000	65,73	06000
6,5	46,06	06500	65,73	06500
7,0	46,06	07000	65,73	07000
7,5	46,06	07500	65,73	07500
8,0	46,06	08000	65,73	08000
8,5	46,06	08500	65,73	08500
9,0	46,06	09000	65,73	09000
9,5	46,06	09500	65,73	09500
10,0	46,06	10000	65,73	10000

d <sub>1</sub> DCONWS mm	d <sub>1</sub> inch	NEW Y8		NEW Y8		NEW Y8	
		bestelnr. 81 003 ...	EUR	bestelnr. 81 005 ...	EUR	bestelnr. 81 031 ...	EUR
1,000				93,34	01000		
1,500				93,34	01500		
2,000				50,64	02000	178,30	02000 <sup>1)</sup>
2,500				50,64	02500		
3,000				30,88	03000	178,30	03000 <sup>1)</sup>
3,175	1/8					178,30	03175 <sup>1)</sup>
3,500				30,88	03500		
4,000				30,88	04000	94,97	04000 <sup>1)</sup>
4,500				30,88	04500		
5,000				30,88	05000	94,97	05000 <sup>1)</sup>
5,500				30,88	05500		
6,000		30,88	06000	50,64	06000	94,97	06000 <sup>1)</sup>
6,350	1/4					136,70	06350 <sup>1)</sup>
6,500		30,88	06500	50,64	06500		
7,000		30,88	07000	50,64	07000	94,97	07000 <sup>1)</sup>
7,500		30,88	07500	50,64	07500		
8,000		30,88	08000	50,64	08000	94,97	08000
8,500		30,88	08500	50,64	08500		
9,000		30,88	09000	50,64	09000	94,97	09000
9,500				50,64	09500		
10,000		30,88	10000	50,64	10000	114,10	10000
10,500		30,88	10500	50,64	10500		
11,000		30,88	11000	50,64	11000	198,70	11000
11,500		30,88	11500	50,64	11500		
12,000		30,88	12000	50,64	12000		

1) Zonder groeven

# Drukspantangen

omschrijving	d DGUI mm	D DFC mm	A DCLC mm	I LCLC mm	L <sub>T</sub> OAL mm	K°
F 16 / 1212 E	16	21	16	6	64	16

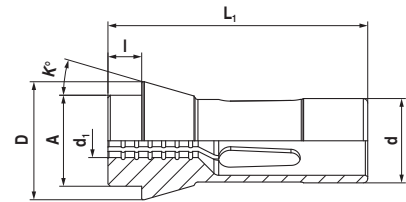

## F 16 / 1212 E



groeven  
F 16 / 1212 E
  glad  
F 16 / 1212 E

d <sub>1</sub> DCONWS mm	NEW Y8 bestelnr. 81 019 ... EUR		NEW Y8 bestelnr. 81 021 ... EUR	
	1,0			71,02
1,5			71,02	01500
2,0			71,02	02000
2,5			71,02	02500
3,0			46,06	03000
3,5			46,06	03500
4,0			46,06	04000
4,5			46,06	04500
5,0			46,06	05000
5,5			46,06	05500
6,0	46,06	06000	65,73	06000
6,5	46,06	06500	65,73	06500
7,0	46,06	07000	65,73	07000
7,5	46,06	07500	65,73	07500
8,0	46,06	08000	65,73	08000
8,5	46,06	08500	65,73	08500
9,0	46,06	09000	65,73	09000
9,5	46,06	09500	65,73	09500
10,0	46,06	10000	65,73	10000
10,5	46,06	10500	65,73	10500
11,0	46,06	11000	65,73	11000
11,5	46,06	11500	65,73	11500
12,0	46,06	12000	65,73	12000
12,5	46,06	12500	65,73	12500
13,0	46,06	13000	65,73	13000

# Drukspantangen

omschrijving	d DGUI mm	D DFC mm	A DCLC mm	I LCLC mm	L <sub>T</sub> OAL mm	K°
136 E / F 20-201	20	26	19	5	54	15
138 E / F20-87	20	28	21	7	67	16

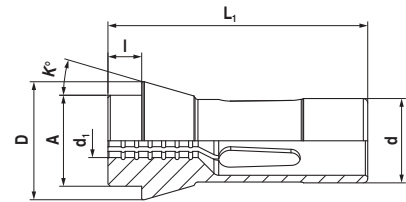

## 136 E / F 20-201

## 138 E / F20-87



d <sub>1</sub> DCONWS mm	136 E / F 20-201 groeven		136 E / F 20-201 glad	
	NEW Y8 bestelnr. 81 007 ... EUR		NEW Y8 bestelnr. 81 009 ... EUR	
1,0			115,20	01000
1,5			115,20	01500
2,0			75,00	02000
2,5			75,00	02500
3,0			46,06	03000
3,5			46,06	03500
4,0			46,06	04000
4,5			46,06	04500
5,0			46,06	05000
5,5			46,06	05500
6,0	46,06	06000	65,73	06000
6,5	46,06	06500	65,73	06500
7,0	46,06	07000	65,73	07000
7,5	46,06	07500	65,73	07500
8,0	46,06	08000	65,73	08000
8,5	46,06	08500	65,73	08500
9,0	46,06	09000	65,73	09000
9,5	46,06	09500	65,73	09500
10,0	46,06	10000	65,73	10000
10,5	46,06	10500	65,73	10500
11,0	46,06	11000	65,73	11000
11,5	46,06	11500	65,73	11500
12,0	46,06	12000	65,73	12000
12,5	46,06	12500	65,73	12500
13,0	46,06	13000	65,73	13000
13,5	46,06	13500	65,73	13500
14,0	46,06	14000	65,73	14000
14,5	46,06	14500	65,73	14500
15,0	46,06	15000	65,73	15000
15,5	46,06	15500	65,73	15500
16,0	46,06	16000	65,73	16000

d <sub>1</sub> DCONWS mm	d <sub>1</sub> inch	138 E / F20-87 groeven		138 E / F20-87 glad		138 E / F20-87 groeven	
		NEW Y8 bestelnr. 81 011 ... EUR		NEW Y8 bestelnr. 81 013 ... EUR		NEW Y8 bestelnr. 81 026 ... EUR	
1,00				117,20	01000		
1,50				117,20	01500		
2,00				64,40	02000	236,40	02000 <sup>1)</sup>
2,50				64,40	02500		
3,00				46,06	03000	112,10	03000 <sup>1)</sup>
3,50				46,06	03500		
4,00				46,06	04000	112,10	04000 <sup>1)</sup>
4,50				46,06	04500		
5,00				46,06	05000	112,10	05000 <sup>1)</sup>
5,50				46,06	05500		
6,00		46,06	06000	65,73	06000	112,10	06000 <sup>1)</sup>
6,35	1/4					154,30	06350 <sup>1)</sup>
6,50		46,06	06500	65,73	06500		
7,00		46,06	07000	65,73	07000	88,65	07000 <sup>1)</sup>
7,50		46,06	07500	65,73	07500		
8,00		46,06	08000	65,73	08000	88,65	08000
8,50		46,06	08500	65,73	08500		
9,00		46,06	09000	65,73	09000	88,65	09000
9,50		46,06	09500	65,73	09500		
10,00		46,06	10000	65,73	10000	88,65	10000
10,50		46,06	10500	65,73	10500		
11,00		46,06	11000	65,73	11000	88,65	11000
11,50		46,06	11500	65,73	11500		
12,00		46,06	12000	65,73	12000	88,65	12000
12,50		46,06	12500	65,73	12500		
13,00		46,06	13000	65,73	13000	88,65	13000
13,50		46,06	13500	65,73	13500		
14,00		46,06	14000	65,73	14000	88,65	14000
14,50		46,06	14500	65,73	14500		
15,00		46,06	15000	65,73	15000		
15,50		46,06	15500	65,73	15500		
16,00		46,06	16000	65,73	16000		

1) Zonder groeven

# Drukspantangen

omschrijving	d DGUI mm	D DFC mm	A DCLC mm	I LCLC mm	L <sub>1</sub> OAL mm	K°
145 E / F 25	25	35	27	10	77	16

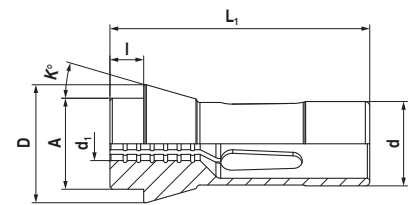

## 145 E / F 25



d <sub>1</sub> DCONWS mm	d <sub>1</sub> inch	● groeven 145 E / F 25		● glad 145 E / F 25		◈ groeven 145 E / F 25		■ groeven 145 E / F 25	
		NEW Y8 bestelnr. 81 015 ... EUR		NEW Y8 bestelnr. 81 017 ... EUR		NEW Y8 bestelnr. 81 027 ... EUR		NEW Y8 bestelnr. 81 029 ... EUR	
1,500				77,55	01500				
1,501 - 1,999				90,69	xxxxx <sup>2)</sup>				
2,000				77,55	02000	258,80	02000 <sup>1)</sup>	327,10	02000 <sup>1)</sup>
2,001 - 2,499				90,69	xxxxx <sup>2)</sup>				
2,500				77,55	02500				
2,501 - 2,999				90,69	xxxxx <sup>2)</sup>				
3,000				55,23	03000	198,70	03000 <sup>1)</sup>	163,00	03000 <sup>1)</sup>
3,001 - 3,499				90,69	xxxxx <sup>2)</sup>				
3,500				55,23	03500				
3,501 - 3,999				90,69	xxxxx <sup>2)</sup>				
4,000				55,23	04000	153,90	04000 <sup>1)</sup>	117,20	04000 <sup>1)</sup>
4,001 - 4,499				90,69	xxxxx <sup>2)</sup>				
4,500				55,23	04500				
4,501 - 4,999				90,69	xxxxx <sup>2)</sup>				
5,000				55,23	05000	117,20	05000 <sup>1)</sup>	117,20	05000 <sup>1)</sup>
5,001 - 5,499				90,69	xxxxx <sup>2)</sup>				
5,500				55,23	05500				
5,501 - 5,999				90,69	xxxxx <sup>2)</sup>				
6,000				55,23	06000	117,20	06000 <sup>1)</sup>	117,20	06000 <sup>1)</sup>
6,001 - 6,349				90,69	xxxxx <sup>2)</sup>				
6,350	1/4			90,69	06350	159,10	06350 <sup>1)</sup>		
6,351 - 6,499				90,69	xxxxx <sup>2)</sup>				
6,500				55,23	06500	75,00	06500		
6,501 - 6,999				90,69	xxxxx <sup>2)</sup>				
7,000				55,23	07000	75,00	07000	91,00	07000 <sup>1)</sup>
7,001 - 7,499				90,69	xxxxx <sup>2)</sup>			91,00	07000 <sup>1)</sup>
7,500				55,23	07500	75,00	07500		
7,501 - 7,937				90,69	xxxxx <sup>2)</sup>				
7,938	5/16			90,69	07938	73,60	07938		
7,939 - 7,999				90,69	xxxxx <sup>2)</sup>				
8,000				55,23	08000	75,00	08000	91,00	08000
8,001 - 8,499				90,69	xxxxx <sup>2)</sup>			91,00	08000
8,500				55,23	08500	75,00	08500		
8,501 - 8,999				90,69	xxxxx <sup>2)</sup>				
9,000				55,23	09000	75,00	09000	91,00	09000
9,001 - 9,499				90,69	xxxxx <sup>2)</sup>			91,00	09000
9,500				55,23	09500	75,00	09500		
9,501 - 9,999				90,69	xxxxx <sup>2)</sup>				
10,000				55,23	10000	75,00	10000	91,00	10000
10,001 - 10,499				90,69	xxxxx <sup>2)</sup>			91,00	10000
10,500				55,23	10500	75,00	10500		
10,501 - 10,999				90,69	xxxxx <sup>2)</sup>				
11,000				55,23	11000	75,00	11000	91,00	11000

1) Zonder groeven

2) Geen voorraadartikel, ruilen of teruggave is niet mogelijk / Levertijd 7 werkdagen

**i** Voor xxxx gelieve bij bestelling de gewenste diameter aangeven (bv. Ø 6,789 – bestelnummer 81 015 06789)!



# 145 E / F 25



d <sub>1</sub> DCONWS mm	d <sub>1</sub> inch	● groeven 145 E / F 25		● glad 145 E / F 25		● groeven 145 E / F 25		■ groeven 145 E / F 25	
		NEW bestelnr. 81 015 ... EUR	Y8 xxxxx <sup>2)</sup>	NEW bestelnr. 81 017 ... EUR	Y8	NEW bestelnr. 81 027 ... EUR	Y8	NEW bestelnr. 81 029 ... EUR	Y8
11,001 - 11,112		90,69	xxxxx <sup>2)</sup>						
11,113	7/16	90,69	11113	75,00	11113				
11,114 - 11,499		90,69	xxxxx <sup>2)</sup>						
11,500		55,23	11500	75,00	11500				
11,501 - 11,999		90,69	xxxxx <sup>2)</sup>						
12,000		55,23	12000	75,00	12000	91,00	12000	91,00	12000
12,001 - 12,499		90,69	xxxxx <sup>2)</sup>						
12,500		55,23	12500	75,00	12500				
12,501 - 12,699		90,69	xxxxx <sup>2)</sup>						
12,700	1/2	90,69	12700	75,00	12700	91,00	12700		
12,701 - 12,999		90,69	xxxxx <sup>2)</sup>						
13,000		55,23	13000	75,00	13000	91,00	13000	91,00	13000
13,001 - 13,499		90,69	xxxxx <sup>2)</sup>						
13,500		55,23	13500	75,00	13500				
13,501 - 13,999		90,69	xxxxx <sup>2)</sup>						
14,000		55,23	14000	75,00	14000	91,00	14000	91,00	14000
14,001 - 14,499		90,69	xxxxx <sup>2)</sup>						
14,500		55,23	14500	75,00	14500				
14,501 - 14,999		90,69	xxxxx <sup>2)</sup>						
15,000		55,23	15000	75,00	15000	91,00	15000	163,00	15000
15,001 - 15,499		90,69	xxxxx <sup>2)</sup>						
15,500		55,23	15500	75,00	15500				
15,501 - 15,999		90,69	xxxxx <sup>2)</sup>						
16,000		55,23	16000	75,00	16000	91,00	16000		
16,001 - 16,499		90,69	xxxxx <sup>2)</sup>						
16,500		55,23	16500	75,00	16500				
16,501 - 16,999		90,69	xxxxx <sup>2)</sup>						
17,000		55,23	17000	75,00	17000	91,00	17000		
17,001 - 17,499		90,69	xxxxx <sup>2)</sup>						
17,500		55,23	17500	75,00	17500				
17,501 - 17,999		90,69	xxxxx <sup>2)</sup>						
18,000		55,23	18000	75,00	18000	198,70	18000		
18,001 - 18,499		90,69	xxxxx <sup>2)</sup>						
18,500		55,23	18500	75,00	18500				
18,501 - 18,999		90,69	xxxxx <sup>2)</sup>						
19,000		55,23	19000	75,00	19000	198,70	19000		
19,001 - 19,049		90,69	xxxxx <sup>2)</sup>						
19,050	3/4	90,69	19050						
19,051 - 19,499		90,69	xxxxx <sup>2)</sup>						
19,500		55,23	19500	75,00	19500				
19,501 - 19,999		90,69	xxxxx <sup>2)</sup>						
20,000		55,23	20000	75,00	20000				

- 1) Zonder groeven
- 2) Geen voorraadartikel, ruilen of teruggave is niet mogelijk / Levertijd 7 werkdagen

**i** Voor xxxxx gelieve bij bestelling de gewenste diameter aangeven (bv. Ø 6,789 – bestelnummer 81 015 06789)!

# Drukspantangen

omschrijving	d DGUI mm	D DFC mm	A DCLC mm	I LCLC mm	L <sub>1</sub> OAL mm	K°
F 37 / 1536 E	37	47	40	10	92	16

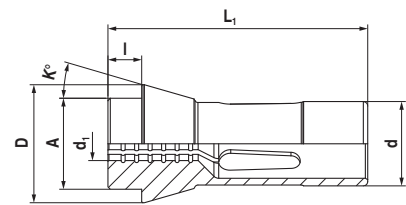

## F 37 / 1536 E



d <sub>1</sub> DCONWS mm	d <sub>1</sub> inch	● groeven F 37 / 1536 E		● glad F 37 / 1536 E		◻ groeven F 37 / 1536 E		◻ groeven F 37 / 1536 E	
		NEW Y8 bestelnr. 81 023 ... EUR		NEW Y8 bestelnr. 81 025 ... EUR		NEW Y8 bestelnr. 81 028 ... EUR		NEW Y8 bestelnr. 81 030 ... EUR	
1,000				107,00	01000				
1,001 - 1,499				113,10	xxxxx <sup>2)</sup>				
1,500				107,00	01500				
1,501 - 1,999				113,10	xxxxx <sup>2)</sup>				
2,000				107,00	02000				
2,001 - 2,499				113,10	xxxxx <sup>2)</sup>				
2,500				107,00	02500				
2,501 - 2,999				113,10	xxxxx <sup>2)</sup>				
3,000				77,55	03000	248,60	03000 <sup>1)</sup>	198,70	03000 <sup>1)</sup>
3,001 - 3,499				113,10	xxxxx <sup>2)</sup>				
3,500				77,55	03500				
3,501 - 3,999				113,10	xxxxx <sup>2)</sup>				
4,000				77,55	04000	127,40	04000 <sup>1)</sup>	198,70	04000 <sup>1)</sup>
4,001 - 4,499				113,10	xxxxx <sup>2)</sup>				
4,500				77,55	04500				
4,501 - 4,999				113,10	xxxxx <sup>2)</sup>				
5,000				77,55	05000	127,40	05000 <sup>1)</sup>	198,70	05000 <sup>1)</sup>
5,001 - 5,499				113,10	xxxxx <sup>2)</sup>				
5,500				77,55	05500				
5,501 - 5,999				113,10	xxxxx <sup>2)</sup>				
6,000				77,55	06000	127,40	06000 <sup>1)</sup>	198,70	06000 <sup>1)</sup>
6,001 - 6,349				113,10	xxxxx <sup>2)</sup>				
6,350	1/4			113,10	06350	97,31	06350	168,10	06350 <sup>1)</sup>
6,351 - 6,499				113,10	xxxxx <sup>2)</sup>				
6,500				77,55	06500	97,31	06500		
6,501 - 6,999				113,10	xxxxx <sup>2)</sup>				
7,000				77,55	07000	97,31	07000	127,40	07000 <sup>1)</sup>
7,001 - 7,499				113,10	xxxxx <sup>2)</sup>			198,70	07000 <sup>1)</sup>
7,500				77,55	07500	97,31	07500		
7,501 - 7,999				113,10	xxxxx <sup>2)</sup>				
8,000				77,55	08000	97,31	08000	127,40	08000
8,001 - 8,499				113,10	xxxxx <sup>2)</sup>			198,70	08000
8,500				77,55	08500	97,31	08500		
8,501 - 8,999				113,10	xxxxx <sup>2)</sup>				
9,000				77,55	09000	97,31	09000	127,40	09000
9,001 - 9,499				113,10	xxxxx <sup>2)</sup>			198,70	09000
9,500				77,55	09500	97,31	09500		
9,501 - 9,524				113,10	xxxxx <sup>2)</sup>				
9,525	3/8			113,10	09525				
9,526 - 9,999				113,10	xxxxx <sup>2)</sup>				
10,000				77,55	10000	97,31	10000	127,40	10000
10,001 - 10,499				113,10	xxxxx <sup>2)</sup>			198,70	10000
10,500				77,55	10500	97,31	10500		

1) Zonder groeven

2) Geen voorraadartikel, ruilen of teruggave is niet mogelijk / Levertijd 7 werkdagen

**i** Voor xxxx gelieve bij bestelling de gewenste diameter aangeven (bv. Ø 6,789 – bestelnummer 81 023 06789)!

5

# F 37 / 1536 E



d <sub>1</sub> DCONWS mm	d <sub>1</sub> inch	● groeven F 37 / 1536 E		● glad F 37 / 1536 E		◻ groeven F 37 / 1536 E		◻ groeven F 37 / 1536 E	
		NEW Y8 bestelnr. 81 023 ... EUR	XXXXX <sup>2)</sup>	NEW Y8 bestelnr. 81 025 ... EUR		NEW Y8 bestelnr. 81 028 ... EUR		NEW Y8 bestelnr. 81 030 ... EUR	
10,501 - 10,999		113,10	XXXXX <sup>2)</sup>						
11,000		77,55	11000	97,31	11000	127,40	11000	198,70	11000
11,001 - 11,499		113,10	XXXXX <sup>2)</sup>						
11,500		77,55	11500	97,31	11500				
11,501 - 11,999		113,10	XXXXX <sup>2)</sup>						
12,000		77,55	12000	97,31	12000	127,40	12000	198,70	12000
12,001 - 12,499		113,10	XXXXX <sup>2)</sup>						
12,500		77,55	12500	97,31	12500				
12,501 - 12,699		113,10	XXXXX <sup>2)</sup>						
12,700	1/2	113,10	12700	97,31	12700	168,10	12700	198,70	12700
12,701 - 12,999		113,10	XXXXX <sup>2)</sup>						
13,000		77,55	13000	97,31	13000	127,40	13000	198,70	13000
13,001 - 13,499		113,10	XXXXX <sup>2)</sup>						
13,500		77,55	13500	97,31	13500				
13,501 - 13,999		113,10	XXXXX <sup>2)</sup>						
14,000		77,55	14000	97,31	14000	127,40	14000	198,70	14000
14,001 - 14,499		113,10	XXXXX <sup>2)</sup>						
14,500		77,55	14500	97,31	14500				
14,501 - 14,999		113,10	XXXXX <sup>2)</sup>						
15,000		77,55	15000	97,31	15000	127,40	15000	198,70	15000
15,001 - 15,499		113,10	XXXXX <sup>2)</sup>						
15,500		77,55	15500	97,31	15500				
15,501 - 15,999		113,10	XXXXX <sup>2)</sup>						
16,000		77,55	16000	97,31	16000	127,40	16000	198,70	16000
16,001 - 16,499		113,10	XXXXX <sup>2)</sup>						
16,500		77,55	16500	97,31	16500				
16,501 - 16,999		113,10	XXXXX <sup>2)</sup>						
17,000		77,55	17000	97,31	17000	127,40	17000	198,70	17000
17,001 - 17,499		113,10	XXXXX <sup>2)</sup>						
17,500		77,55	17500	97,31	17500				
17,501 - 17,999		113,10	XXXXX <sup>2)</sup>						
18,000		77,55	18000	97,31	18000	127,40	18000	198,70	18000
18,001 - 18,499		113,10	XXXXX <sup>2)</sup>						
18,500		77,55	18500	97,31	18500				
18,501 - 18,999		113,10	XXXXX <sup>2)</sup>						
19,000		77,55	19000	97,31	19000	127,40	19000	198,70	19000
19,001 - 19,049		113,10	XXXXX <sup>2)</sup>						
19,050	3/4	113,10	19050	97,31	19050				
19,051 - 19,499		113,10	XXXXX <sup>2)</sup>						
19,500		77,55	19500	97,31	19500				
19,501 - 19,999		113,10	XXXXX <sup>2)</sup>						
20,000		77,55	20000	97,31	20000	127,40	20000	198,70	20000
20,001 - 20,499		113,10	XXXXX <sup>2)</sup>						
20,500		77,55	20500	97,31	20500				
20,501 - 20,999		113,10	XXXXX <sup>2)</sup>						
21,000		77,55	21000	97,31	21000	127,40	21000	198,70	21000
21,001 - 21,499		113,10	XXXXX <sup>2)</sup>						
21,500		77,55	21500	97,31	21500				
21,501 - 21,999		113,10	XXXXX <sup>2)</sup>						
22,000		77,55	22000	97,31	22000	127,40	22000	198,70	22000
22,001 - 22,224		113,10	XXXXX <sup>2)</sup>						
22,225	7/8	113,10	22225						
22,226 - 22,499		113,10	XXXXX <sup>2)</sup>						

1) Zonder groeven

2) Geen voorraadartikel, ruilen of teruggave is niet mogelijk / Levertijd 7 werkdagen

**i** Voor xxxx gelieve bij bestelling de gewenste diameter aangeven (bv. Ø 6,789 – bestelnummer 81 023 06789)!

# F 37 / 1536 E



d <sub>1</sub> DCONWS mm	d <sub>1</sub> inch	● groeven F 37 / 1536 E		● glad F 37 / 1536 E		◈ groeven F 37 / 1536 E		■ groeven F 37 / 1536 E	
		NEW Y8 bestelnr. 81 023 ... EUR	22500	NEW Y8 bestelnr. 81 025 ... EUR	22500	NEW Y8 bestelnr. 81 028 ... EUR	23000	NEW Y8 bestelnr. 81 030 ... EUR	23000
22,500		97,31	22500	77,55	22500				
22,501 - 22,999		113,10	xxxxx <sup>2)</sup>						
23,000		97,31	23000	77,55	23000	127,40	23000	198,70	23000
23,001 - 23,499		113,10	xxxxx <sup>2)</sup>						
23,500		97,31	23500	77,55	23500				
23,501 - 23,999		113,10	xxxxx <sup>2)</sup>						
24,000		97,31	24000	77,55	24000	127,40	24000		
24,001 - 24,499		113,10	xxxxx <sup>2)</sup>						
24,500		97,31	24500	77,55	24500				
24,501 - 24,999		113,10	xxxxx <sup>2)</sup>						
25,000		77,55	25000	97,31	25000	127,40	25000		
25,001 - 25,499		113,10	xxxxx <sup>2)</sup>						
25,400	1/1					168,10	25400		
25,500		77,55	25500	97,31	25500				
25,501 - 25,999		113,10	xxxxx <sup>2)</sup>						
26,000		77,55	26000	97,31	26000	127,40	26000		
26,001 - 26,499		113,10	xxxxx <sup>2)</sup>						
26,500		77,55	26500	97,31	26500				
26,501 - 26,999		113,10	xxxxx <sup>2)</sup>						
27,000		77,55	27000	97,31	27000	127,40	27000		
27,001 - 27,499		113,10	xxxxx <sup>2)</sup>						
27,500		77,55	27500	97,31	27500				
27,501 - 27,999		113,10	xxxxx <sup>2)</sup>						
28,000		77,55	28000	97,31	28000				
28,001 - 28,499		113,10	xxxxx <sup>2)</sup>						
28,500		77,55	28500	97,31	28500				
28,501 - 28,999		113,10	xxxxx <sup>2)</sup>						
29,000		77,55	29000	97,31	29000				
29,001 - 29,499		113,10	xxxxx <sup>2)</sup>						
29,500		77,55	29500	97,31	29500				
29,501 - 29,999		113,10	xxxxx <sup>2)</sup>						
30,000		77,55	30000	97,31	30000				
30,001 - 30,499		113,10	xxxxx <sup>2)</sup>						
30,500		77,55	30500	97,31	30500				
30,501 - 30,999		113,10	xxxxx <sup>2)</sup>						
31,000		77,55	31000	97,31	31000				
31,001 - 31,499		113,10	xxxxx <sup>2)</sup>						
31,500		77,55	31500	97,31	31500				
31,501 - 31,999		113,10	xxxxx <sup>2)</sup>						
32,000		77,55	32000	97,31	32000				

- 1) Zonder groeven
- 2) Geen voorraadartikel, ruilen of teruggave is niet mogelijk / Levertijd 7 werkdagen

**i** Voor xxxx gelieve bij bestelling de gewenste diameter aangeven (bv. Ø 6,789 – bestelnummer 81 023 06789)!

## Highlights

- Precisie „Made in Germany“ betrouwbare kwaliteit
- Verkrijgbaar in 1/100 maten de hoogste flexibiliteit
- In gladde uitvoering geen afdrukken in het werkstuk
- Alle relevante vlakken zijn „precisiegeslepen“ verhoogt de werkstuknauwkeurigheid
- Aangepaste verlenging maximale stabiliteit met minimaal botsingsgevaar

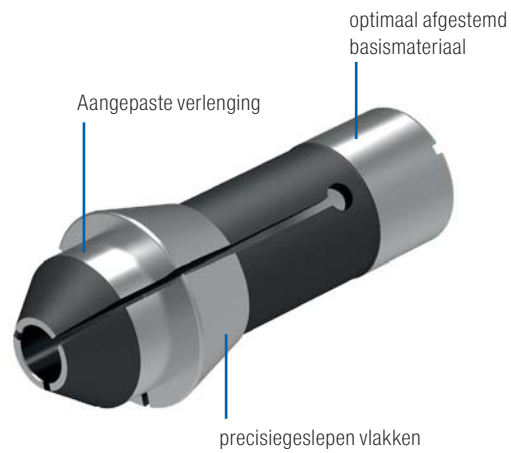

## Overzicht verlengde spantangen

Norm	bereik klemdiameter in mm	profiel	Uitvoering	pagina
116E	Ø 1,0 – 8,0	●	glad	<a href="#">13</a>
120E	Ø 1,0 – 8,0	●	glad	<a href="#">13</a>
F16	Ø 1,0 – 9,0	●	glad	<a href="#">13</a>
138E	Ø 1,0 – 12,0	●	glad	<a href="#">13</a>
136E	Ø 1,0 – 14,0	●	glad	<a href="#">14</a>
145E	Ø 1,0 – 20,0	●	glad	<a href="#">14</a>
F37	Ø 1,0 – 28,0	●	glad	<a href="#">14</a>

# Verlengde spantangen

omschrijving	d DGUI mm	D DFC mm	A DCLC mm	I LCLC mm	L <sub>1</sub> OAL mm	K°	I <sub>1</sub> LFSF mm
116 E / F 13	13	19	13	12	70	16	6
120 E / F 15	15	21	15	13	71	16	7
120 E / F 15	15	21	15	15	73	16	9
F 16 / 1212 E	16	21	16	13	71	16	7
F 16 / 1212 E	16	21	16	15	73	16	9
138 E / F20-87	20	28	21	15	78	16	8
138 E / F20-87	20	28	21	20	80	16	13

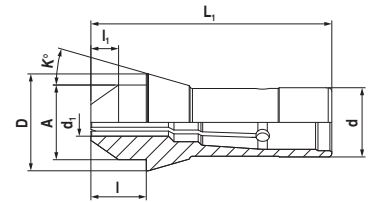

## 116 E / F 13



glad  
116 E / F 13

d <sub>1</sub> DCONWS mm	NEW Y8 bestelnr. 81 001 ... EUR
1	234,40 01000
2	234,40 02000
3	213,00 03000
4	213,00 04000
5	213,00 05000
6	213,00 06000
7	213,00 07000

## F 16 / 1212 E



glad  
F 16 / 1212 E  
I<sub>1</sub> = 7 mm

glad  
F 16 / 1212 E  
I<sub>1</sub> = 9 mm

d <sub>1</sub> DCONWS mm	NEW Y8 bestelnr. 81 020 ... EUR	NEW Y8 bestelnr. 81 022 ... EUR
1	235,40 01000	235,40 01000
2	235,40 02000	235,40 02000
3	216,00 03000	216,00 03000
4	216,00 04000	216,00 04000
5	216,00 05000	281,20 05000
6	216,00 06000	281,20 06000
7	216,00 07000	281,20 07000
8	216,00 08000	216,00 08000
9	216,00 09000	281,20 09000

## 120 E / F 15



glad  
120 E / F 15  
I<sub>1</sub> = 7 mm

glad  
120 E / F 15  
I<sub>1</sub> = 9 mm

d <sub>1</sub> DCONWS mm	NEW Y8 bestelnr. 81 004 ... EUR	NEW Y8 bestelnr. 81 006 ... EUR
1	235,40 01000	235,40 01000
2	235,40 02000	235,40 02000
3	216,00 03000	216,00 03000
4	216,00 04000	216,00 04000
5	216,00 05000	216,00 05000
6	216,00 06000	216,00 06000
7	216,00 07000	216,00 07000
8	216,00 08000	216,00 08000

## 138 E / F20-87



glad  
138 E / F20-87  
I<sub>1</sub> = 8 mm

glad  
138 E / F20-87  
I<sub>1</sub> = 13 mm

d <sub>1</sub> DCONWS mm	NEW Y8 bestelnr. 81 012 ... EUR	NEW Y8 bestelnr. 81 014 ... EUR
1	282,30 01000	282,30 01000
2	282,30 02000	282,30 02000
3	262,90 03000	262,90 03000
4	262,90 04000	262,90 04000
5	262,90 05000	262,90 05000
6	262,90 06000	262,90 06000
7	262,90 07000	262,90 07000
8	262,90 08000	262,90 08000
9	262,90 09000	262,90 09000
10	262,90 10000	262,90 10000
11	262,90 11000	262,90 11000
12	262,90 12000	262,90 12000

# Verlengde spantangen

omschrijving	d DGUI mm	D DFC mm	A DCLC mm	I LCLC mm	L <sub>1</sub> OAL mm	K°	I <sub>1</sub> LFSF mm
136 E / F 20-201	20	26	19	13	62	15	8
136 E / F 20-201	20	26	19	15	64	15	10
145 E / F 25	25	35	27	20	87	16	10
145 E / F 25	25	35	27	25	92	16	15
F 37 / 1536 E	37	47	40	25	107	16	15

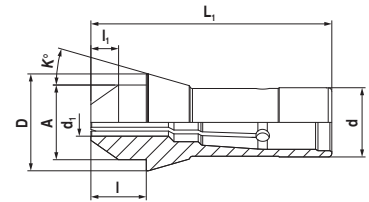

## 136 E / F 20-201

## F 37 / 1536 E



d <sub>1</sub> DCONWS mm	glad 136 E / F 20-201 I <sub>1</sub> = 8 mm		glad 136 E / F 20-201 I <sub>1</sub> = 10 mm	
	NEW Y8 bestelnr. 81 008 ...	EUR	NEW Y8 bestelnr. 81 010 ...	EUR
1	282,30	01000	282,30	01000
2	282,30	02000	282,30	02000
3	262,90	03000	262,90	03000
4	262,90	04000	262,90	04000
5	262,90	05000	262,90	05000
6	282,30	06000	262,90	06000
7	282,30	07000	262,90	07000
8	262,90	08000	262,90	08000
9	262,90	09000	262,90	09000
10	262,90	10000	262,90	10000
11	262,90	11000	262,90	11000
12	262,90	12000	262,90	12000
13			262,90	13000
14			262,90	14000

d <sub>1</sub> DCONWS mm	glad F 37 / 1536 E	
	NEW Y8 bestelnr. 81 024 ...	EUR
1	315,90	01000
2	315,90	02000
3	270,00	03000
4	270,00	04000
5	270,00	05000
6	270,00	06000
7	270,00	07000
8	270,00	08000
9	270,00	09000
10	270,00	10000
11	270,00	11000
12	270,00	12000
13	302,60	13000
14	270,00	14000
15	270,00	15000
16	270,00	16000
17	270,00	17000
18	270,00	18000
19	270,00	19000
20	270,00	20000
21	270,00	21000
22	270,00	22000
23	270,00	23000
24	270,00	24000
25	270,00	25000
26	270,00	26000
27	270,00	27000
28	270,00	28000

## 145 E / F 25



d <sub>1</sub> DCONWS mm	glad 145 E / F 25 I <sub>1</sub> = 10 mm		glad 145 E / F 25 I <sub>1</sub> = 15 mm	
	NEW Y8 bestelnr. 81 016 ...	EUR	NEW Y8 bestelnr. 81 018 ...	EUR
1	282,30	01000	282,30	01000
2	282,30	02000	282,30	02000
3	262,90	03000	262,90	03000
4	262,90	04000	262,90	04000
5	262,90	05000	262,90	05000
6	262,90	06000	262,90	06000
7	262,90	07000	262,90	07000
8	262,90	08000	262,90	08000
9	262,90	09000	262,90	09000
10	262,90	10000	262,90	10000
11	262,90	11000	262,90	11000
12	262,90	12000	262,90	12000
13	262,90	13000	262,90	13000
14	262,90	14000	262,90	14000
15	262,90	15000	262,90	15000
16	262,90	16000	262,90	16000
17	262,90	17000	262,90	17000
18	262,90	18000	262,90	18000
19	262,90	19000	262,90	19000
20	262,90	20000	262,90	20000

## Highlights

- Precisie „Made in Germany“ betrouwbare kwaliteit
- Standaardnorm met een hardmetalen geleiding langere levensduur
- In rond, vierkant of zeskant aanpassing aan het materiaal
- Alle relevante vlakken zijn „precisiegeslepen“ verhoogt de werkstuknauwkeurigheid
- Perfect op stafmateriaal instelbaar garandeert de hoogste werkstuknauwkeurigheden



## Overzicht verstelbare geleidebussen

Norm	bereik geleidebusdiameter in mm	profiel	Uitvoering	pagina
I353	Ø 1,0 - 10,5	●	hardmetalen geleiding	16
F853	Ø 1,0 - 13,0	●	hardmetalen geleiding	17
F391	Ø 1,0 - 18,0	●	hardmetalen geleiding	18
F605	Ø 1,0 - 17,0	●	hardmetalen geleiding	19
T223	Ø 1,0 - 22,0	●	hardmetalen geleiding	20
I357	Ø 2,0 - 22,0	●	hardmetalen geleiding	21
T227	Ø 1,0 - 25,0	●	hardmetalen geleiding	22
T229	Ø 2,0 - 32,0	●	hardmetalen geleiding	23
T223	SW 2,0 - 11,0	⬡	hardmetalen geleiding	20
T229	SW 2,0 - 14,0	⬡	hardmetalen geleiding	23
T223	SW 2,0 - 15,0	■	hardmetalen geleiding	20

## Overzicht flexible geleidebussen GBE

GBE 28	Ø 2,0 - 15,0	●	24
GBE 42	Ø 2,0 - 15,0	●	24



# Verstelbare geleidebussen

omschrijving	d DGUI mm	D DFC mm	L <sub>1</sub> OAL mm	K°	G THOD
I 353	16	19,5	59	16	M14 x 1

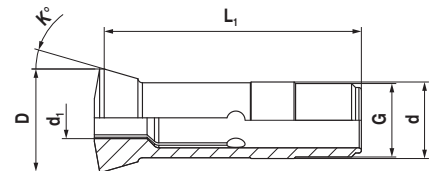

## I 353

- voor star\*-CNC-langdraaiautomaten
- met hardmetalen geleiding



I 353

**NEW** Y8

bestelnr.  
**81 035 ...**

EUR

d <sub>1</sub> DCONWS mm	EUR	
1,0	138,60	01000
1,5	127,40	01500
2,0	127,40	02000
2,5	127,40	02500
3,0	127,40	03000
3,5	127,40	03500
4,0	127,40	04000
4,5	101,90	04500
5,0	101,90	05000
5,5	113,10	05500
6,0	113,10	06000
6,5	120,20	06500
7,0	120,20	07000
7,5	127,40	07500
8,0	127,40	08000
8,5	131,50	08500
9,0	131,50	09000
9,5	136,60	09500
10,0	136,60	10000
10,5	141,60	10500

# Verstelbare geleidebussen

omschrijving	d DGUI mm	D DFC mm	L <sub>1</sub> OAL mm	K°	G THOD
F 853	18	22	60	30	M16 x 1

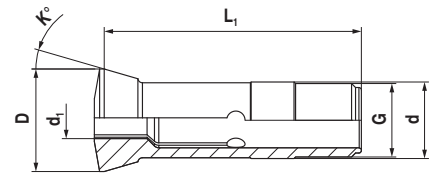

## F 853

- met hardmetalen geleiding



F 853

d <sub>1</sub> DCONWS mm	NEW Y8 bestelnr. 81 034 ... EUR
1,0	138,60 01000
1,5	127,40 01500
2,0	127,40 02000
2,5	127,40 02500
3,0	127,40 03000
3,5	127,40 03500
4,0	127,40 04000
4,5	101,90 04500
5,0	101,90 05000
5,5	113,10 05500
6,0	113,10 06000
6,5	120,20 06500
7,0	120,20 07000
7,5	127,40 07500
8,0	127,40 08000
8,5	131,50 08500
9,0	131,50 09000
9,5	136,60 09500
10,0	136,60 10000
10,5	141,60 10500
11,0	141,60 11000
11,5	147,80 11500
12,0	147,80 12000
12,5	154,90 12500
13,0	154,90 13000

# Verstelbare geleidebussen

omschrijving	d DGUI mm	D DFC mm	L <sub>1</sub> OAL mm	K°	G THOD
F 391	22	29	68	16	M22 x 1

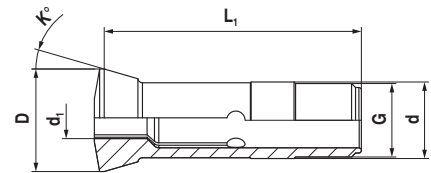

## F 391

- met hardmetalen geleiding



F 391

d <sub>1</sub> DCONWS mm	d <sub>1</sub> inch	NEW Y8 bestelnr. 81 032 ... EUR	
1,000		154,90	01000
1,001 - 1,499		166,10	xxxxx <sup>1)</sup>
1,500		130,40	01500
1,501 - 1,999		166,10	xxxxx <sup>1)</sup>
2,000		130,40	02000
2,001 - 2,499		166,10	xxxxx <sup>1)</sup>
2,500		105,00	02500
2,501 - 2,999		166,10	xxxxx <sup>1)</sup>
3,000		105,00	03000
3,001 - 3,499		166,10	xxxxx <sup>1)</sup>
3,500		99,76	03500
3,501 - 3,999		166,10	xxxxx <sup>1)</sup>
4,000		99,76	04000
4,001 - 4,499		166,10	xxxxx <sup>1)</sup>
4,500		106,00	04500
4,501 - 4,999		166,10	xxxxx <sup>1)</sup>
5,000		106,00	05000
5,001 - 5,499		166,10	xxxxx <sup>1)</sup>
5,500		117,20	05500
5,501 - 5,999		166,10	xxxxx <sup>1)</sup>
6,000		117,20	06000
6,001 - 6,349		166,10	xxxxx <sup>1)</sup>
6,350	1/4	166,10	06350
6,351 - 6,499		166,10	xxxxx <sup>1)</sup>
6,500		121,30	06500
6,501 - 6,999		166,10	xxxxx <sup>1)</sup>
7,000		121,30	07000
7,001 - 7,499		166,10	xxxxx <sup>1)</sup>
7,500		130,40	07500
7,501 - 7,999		166,10	xxxxx <sup>1)</sup>
8,000		130,40	08000
8,001 - 8,499		166,10	xxxxx <sup>1)</sup>
8,500		136,60	08500
8,501 - 8,999		166,10	xxxxx <sup>1)</sup>
9,000		136,60	09000
9,001 - 9,499		166,10	xxxxx <sup>1)</sup>
9,500		141,60	09500
9,501 - 9,999		166,10	xxxxx <sup>1)</sup>
10,000		141,60	10000
10,001 - 10,499		166,10	xxxxx <sup>1)</sup>
10,500		146,70	10500
10,501 - 10,999		166,10	xxxxx <sup>1)</sup>
11,000		146,70	11000
11,001 - 11,499		166,10	xxxxx <sup>1)</sup>
11,500		151,80	11500
11,501 - 11,999		166,10	xxxxx <sup>1)</sup>
12,000		151,80	12000

d <sub>1</sub> DCONWS mm	d <sub>1</sub> inch	NEW Y8 bestelnr. 81 032 ... EUR	
12,001 - 12,499		166,10	xxxxx <sup>1)</sup>
12,500		165,10	12500
12,501 - 12,699		166,10	xxxxx <sup>1)</sup>
12,700	1/2	214,00	12700
12,701 - 12,999		214,00	xxxxx <sup>1)</sup>
13,000		165,10	13000
13,001 - 13,499		214,00	xxxxx <sup>1)</sup>
13,500		169,20	13500
13,501 - 13,999		214,00	xxxxx <sup>1)</sup>
14,000		169,20	14000
14,001 - 14,499		214,00	xxxxx <sup>1)</sup>
14,500		178,30	14500
14,501 - 14,999		214,00	xxxxx <sup>1)</sup>
15,000		178,30	15000
15,001 - 15,499		214,00	xxxxx <sup>1)</sup>
15,500		192,60	15500
15,501 - 15,999		214,00	xxxxx <sup>1)</sup>
16,000		192,60	16000
16,001 - 16,499		214,00	xxxxx <sup>1)</sup>
16,500		200,70	16500
16,501 - 16,999		214,00	xxxxx <sup>1)</sup>
17,000		200,70	17000
17,001 - 17,499		214,00	xxxxx <sup>1)</sup>
17,500		210,90	17500
17,501 - 17,999		214,00	xxxxx <sup>1)</sup>
18,000		210,90	18000

1) Geen voorraadartikel, ruilen of teruggave is niet mogelijk / Levertijd 7 werkdagen

**i** Voor xxxxx gelieve bij bestelling de gewenste diameter aangeven (bv. Ø 6,789 – bestelnummer 81 032 06789)!

# Verstelbare geleidebussen

omschrijving	d DGUI mm	D DFC mm	L <sub>1</sub> OAL mm	K°	G THOD
F 605	24	29,5	61	30	M24 x 1

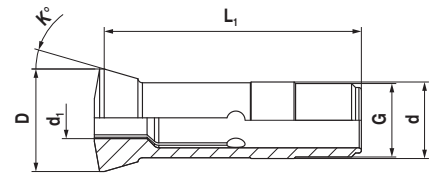

## F 605

▪ met hardmetalen geleiding



F 605

d <sub>1</sub> DCONWS mm	d <sub>1</sub> inch	NEW Y8 bestelnr. 81 033 ... EUR	
1,000		153,00	01000
1,001 - 1,499		153,90	xxxxx <sup>1)</sup>
1,500		130,40	01500
1,501 - 1,999		153,90	xxxxx <sup>1)</sup>
2,000		130,40	02000
2,001 - 2,499		153,90	xxxxx <sup>1)</sup>
2,500		105,00	02500
2,501 - 2,999		153,90	xxxxx <sup>1)</sup>
3,000		105,00	03000
3,001 - 3,174		153,90	xxxxx <sup>1)</sup>
3,175	1/8	153,90	03175
3,176 - 3,499		153,90	xxxxx <sup>1)</sup>
3,500		99,76	03500
3,501 - 3,999		153,90	xxxxx <sup>1)</sup>
4,000		99,76	04000
4,001 - 4,499		153,90	xxxxx <sup>1)</sup>
4,500		106,00	04500
4,501 - 4,762		153,90	xxxxx <sup>1)</sup>
4,763	3/16	154,90	04763
4,764 - 4,999		154,90	xxxxx <sup>1)</sup>
5,000		106,00	05000
5,001 - 5,499		154,90	xxxxx <sup>1)</sup>
5,500		117,20	05500
5,501 - 5,999		154,90	xxxxx <sup>1)</sup>
6,000		117,20	06000
6,001 - 6,349		154,90	xxxxx <sup>1)</sup>
6,350	1/4	166,10	06350
6,351 - 6,499		166,10	xxxxx <sup>1)</sup>
6,500		121,30	06500
6,501 - 6,999		166,10	xxxxx <sup>1)</sup>
7,000		121,30	07000
7,001 - 7,499		166,10	xxxxx <sup>1)</sup>
7,500		130,40	07500
7,501 - 7,999		166,10	xxxxx <sup>1)</sup>
8,000		130,40	08000
8,001 - 8,499		166,10	xxxxx <sup>1)</sup>
8,500		136,60	08500
8,501 - 8,999		166,10	xxxxx <sup>1)</sup>
9,000		136,60	09000
9,001 - 9,499		166,10	xxxxx <sup>1)</sup>
9,500		141,60	09500
9,501 - 9,999		166,10	xxxxx <sup>1)</sup>
10,000		141,60	10000
10,001 - 10,499		166,10	xxxxx <sup>1)</sup>
10,500		146,70	10500
10,501 - 10,999		166,10	xxxxx <sup>1)</sup>
11,000		146,70	11000

d <sub>1</sub> DCONWS mm	d <sub>1</sub> inch	NEW Y8 bestelnr. 81 033 ... EUR	
11,001 - 11,499		166,10	xxxxx <sup>1)</sup>
11,500		151,80	11500
11,501 - 11,999		166,10	xxxxx <sup>1)</sup>
12,000		151,80	12000
12,001 - 12,499		166,10	xxxxx <sup>1)</sup>
12,500		165,10	12500
12,501 - 12,699		166,10	xxxxx <sup>1)</sup>
12,700	1/2	214,00	12700
12,701 - 12,999		214,00	xxxxx <sup>1)</sup>
13,000		165,10	13000
13,001 - 13,499		214,00	xxxxx <sup>1)</sup>
13,500		169,20	13500
13,501 - 13,999		214,00	xxxxx <sup>1)</sup>
14,000		169,20	14000
14,001 - 14,499		214,00	xxxxx <sup>1)</sup>
14,500		178,30	14500
14,501 - 14,999		214,00	xxxxx <sup>1)</sup>
15,000		178,30	15000
15,001 - 15,499		214,00	xxxxx <sup>1)</sup>
15,500		192,60	15500
15,501 - 15,999		214,00	xxxxx <sup>1)</sup>
16,000		192,60	16000
16,001 - 16,499		214,00	xxxxx <sup>1)</sup>
16,500		200,70	16500
16,501 - 16,999		214,00	xxxxx <sup>1)</sup>
17,000		200,70	17000

1) Geen voorraadartikel, ruilen of teruggave is niet mogelijk / Levertijd 7 werkdagen

**i** Voor xxxxx gelieve bij bestelling de gewenste diameter aangeven (bv. Ø 6,789 – bestelnummer 81 033 06789)!

# Verstelbare geleidebussen

omschrijving	d DGUI mm	D DFC mm	L <sub>1</sub> OAL mm	K°	G THOD
T 223	28	34	82	16	M25 x 1

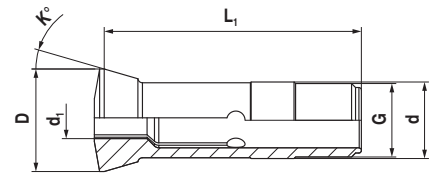

## T 223

▪ met hardmetalen geleiding



d <sub>1</sub> DCONWS mm		d <sub>1</sub> inch		T 223 NEW Y8 bestelnr. 81 037 ... EUR	T 223 NEW Y8 bestelnr. 81 038 ... EUR	T 223 NEW Y8 bestelnr. 81 039 ... EUR
1,000				153,00 01000		
1,001 - 1,499				166,10 xxxxx <sup>1)</sup>		
1,500				176,30 01500		
1,501 - 1,999				166,10 xxxxx <sup>1)</sup>		
2,000				130,40 02000		
2,001 - 2,499				166,10 xxxxx <sup>1)</sup>		
2,500				105,00 02500		
2,501 - 2,999				166,10 xxxxx <sup>1)</sup>		
3,000				105,00 03000	227,20 03000	339,30 03000
3,001 - 3,499				166,10 xxxxx <sup>1)</sup>		
3,500				99,76 03500		
3,501 - 3,999				166,10 xxxxx <sup>1)</sup>		
4,000				99,76 04000	222,10 04000	334,20 04000
4,001 - 4,499				166,10 xxxxx <sup>1)</sup>		
4,500				106,00 04500		
4,501 - 4,999				166,10 xxxxx <sup>1)</sup>		
5,000				106,00 05000	203,80 05000	314,90 05000
5,001 - 5,499				166,10 xxxxx <sup>1)</sup>		
5,500				117,20 05500		
5,501 - 5,999				166,10 xxxxx <sup>1)</sup>		
6,000				117,20 06000	225,20 06000	337,30 06000
6,001 - 6,349				166,10 xxxxx <sup>1)</sup>		
6,350	1/4			166,10 06350	268,80 06350	381,10 06350
6,351 - 6,499				166,10 xxxxx <sup>1)</sup>		
6,500				121,30 06500		
6,501 - 6,999				166,10 xxxxx <sup>1)</sup>		
7,000				121,30 07000	236,40 07000	348,50 07000
7,001 - 7,499				166,10 xxxxx <sup>1)</sup>		
7,500				130,40 07500		
7,501 - 7,999				166,10 xxxxx <sup>1)</sup>		
7,938	5/16				283,00 07938	
8,000				130,40 08000	253,70 08000	364,80 08000
8,001 - 8,499				166,10 xxxxx <sup>1)</sup>		
8,500				136,60 08500		
8,501 - 8,999				166,10 xxxxx <sup>1)</sup>		
9,000				136,60 09000	262,90 09000	375,00 09000
9,001 - 9,499				166,10 xxxxx <sup>1)</sup>		
9,500				141,60 09500		
9,501 - 9,999				166,10 xxxxx <sup>1)</sup>		
9,525	3/8				308,80 09525	
10,000				141,60 10000	272,10 10000	384,20 10000
10,001 - 10,499				166,10 xxxxx <sup>1)</sup>		
10,500				146,70 10500		
10,501 - 10,999				166,10 xxxxx <sup>1)</sup>		
11,000				146,70 11000	282,30 11000	394,40 11000
11,001 - 11,499				166,10 xxxxx <sup>1)</sup>		
11,500				151,80 11500		

d <sub>1</sub> DCONWS mm	d <sub>1</sub> inch	NEW Y8 bestelnr. 81 037 ... EUR	NEW Y8 bestelnr. 81 038 ... EUR	NEW Y8 bestelnr. 81 039 ... EUR
11,501 - 11,999		166,10 xxxxx <sup>1)</sup>		
12,000		151,80 12000	294,50 12000	405,60 12000
12,001 - 12,499		166,10 xxxxx <sup>1)</sup>		
12,500		165,10 12500		
12,501 - 12,699		166,10 xxxxx <sup>1)</sup>		
12,700	1/2	214,00 12700	348,50 12700	
12,701 - 12,999		214,00 xxxxx <sup>1)</sup>		
13,000		165,10 13000	313,90 13000	425,90 13000
13,001 - 13,499		214,00 xxxxx <sup>1)</sup>		
13,500		169,20 13500		
13,501 - 13,999		214,00 xxxxx <sup>1)</sup>		
14,000		169,20 14000	322,00 14000	433,10 14000
14,001 - 14,499		214,00 xxxxx <sup>1)</sup>		
14,500		178,30 14500		
14,501 - 14,999		214,00 xxxxx <sup>1)</sup>		
15,000		178,30 15000	335,30 15000	
15,001 - 15,499		214,00 xxxxx <sup>1)</sup>		
15,500		192,60 15500		
15,501 - 15,999		214,00 xxxxx <sup>1)</sup>		
16,000		192,60 16000	352,60 16000	
16,001 - 16,499		214,00 xxxxx <sup>1)</sup>		
16,500		200,70 16500		
16,501 - 16,999		214,00 xxxxx <sup>1)</sup>		
17,000		200,70 17000	365,80 17000	
17,001 - 17,499		214,00 xxxxx <sup>1)</sup>		
17,500		210,90 17500		
17,501 - 17,999		214,00 xxxxx <sup>1)</sup>		
18,000		210,90 18000		
18,001 - 18,499		214,00 xxxxx <sup>1)</sup>		
18,500		220,10 18500		
18,501 - 18,999		214,00 xxxxx <sup>1)</sup>		
19,000		220,10 19000		
19,001 - 19,499		214,00 xxxxx <sup>1)</sup>		
19,500		224,20 19500		
19,501 - 19,999		214,00 xxxxx <sup>1)</sup>		
20,000		224,20 20000		
20,001 - 20,499		214,00 xxxxx <sup>1)</sup>		
20,500		237,40 20500		
20,501 - 20,999		214,00 xxxxx <sup>1)</sup>		
21,000		237,40 21000		
21,001 - 21,499		214,00 xxxxx <sup>1)</sup>		
21,500		246,60 21500		
21,501 - 21,999		214,00 xxxxx <sup>1)</sup>		
22,000		339,30 22000		

1) Geen voorraadartikel, ruilen of teruggave is niet mogelijk / Levertijd 7 werkdagen

**i** Voor xxxxx gelieve bij bestelling de gewenste diameter aangeven (bv. Ø 6,789 – bestelnummer 81 037 06789)!

# Verstelbare geleidebussen

omschrijving	d DGUI mm	D DFC mm	L <sub>1</sub> OAL mm	K°	G THOD
I 357	28	38	81	30	M25 x 1

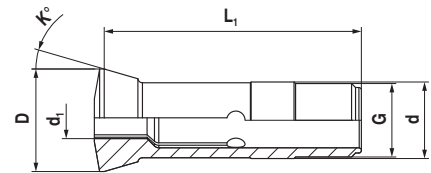

## I 357

▪ met hardmetalen geleiding



I 357

d <sub>1</sub> DCONWS mm	d <sub>1</sub> inch	NEW Y8 bestelnr. 81 036 ... EUR	
2,000		130,40	02000
2,001 - 2,499		153,90	xxxxx <sup>1)</sup>
2,500		130,40	02500
2,501 - 2,999		153,90	xxxxx <sup>1)</sup>
3,000		105,00	03000
3,001 - 3,174		153,90	xxxxx <sup>1)</sup>
3,175	1/8	153,90	03175
3,176 - 3,499		153,90	xxxxx <sup>1)</sup>
3,500		99,76	03500
3,501 - 3,999		153,90	xxxxx <sup>1)</sup>
4,000		99,76	04000
4,001 - 4,499		153,90	xxxxx <sup>1)</sup>
4,500		106,00	04500
4,501 - 4,999		153,90	xxxxx <sup>1)</sup>
5,000		106,00	05000
5,001 - 5,499		153,90	xxxxx <sup>1)</sup>
5,500		117,20	05500
5,501 - 5,999		153,90	xxxxx <sup>1)</sup>
6,000		117,20	06000
6,001 - 6,499		153,90	xxxxx <sup>1)</sup>
6,500		121,30	06500
6,501 - 6,999		153,90	xxxxx <sup>1)</sup>
7,000		121,30	07000
7,001 - 7,143		153,90	xxxxx <sup>1)</sup>
7,144	9/32	170,20	07144
7,145 - 7,499		170,20	xxxxx <sup>1)</sup>
7,500		130,40	07500
7,501 - 7,999		170,20	xxxxx <sup>1)</sup>
8,000		130,40	08000
8,001 - 8,499		170,20	xxxxx <sup>1)</sup>
8,500		136,60	08500
8,501 - 8,999		170,20	xxxxx <sup>1)</sup>
9,000		136,60	09000
9,001 - 9,499		170,20	xxxxx <sup>1)</sup>
9,500		141,60	09500
9,501 - 9,999		170,20	xxxxx <sup>1)</sup>
10,000		141,60	10000
10,001 - 10,499		170,20	xxxxx <sup>1)</sup>
10,500		146,70	10500
10,501 - 10,999		170,20	xxxxx <sup>1)</sup>
11,000		146,70	11000
11,001 - 11,499		170,20	xxxxx <sup>1)</sup>
11,500		151,80	11500
11,501 - 11,999		170,20	xxxxx <sup>1)</sup>
12,000		151,80	12000
12,001 - 12,499		170,20	xxxxx <sup>1)</sup>
12,500		165,10	12500

d <sub>1</sub> DCONWS mm	d <sub>1</sub> inch	NEW Y8 bestelnr. 81 036 ... EUR	
12,501 - 12,699		214,00	xxxxx <sup>1)</sup>
12,700	1/2	214,00	12700
12,701 - 12,999		214,00	xxxxx <sup>1)</sup>
13,000		165,10	13000
13,001 - 13,499		214,00	xxxxx <sup>1)</sup>
13,500		169,20	13500
13,501 - 13,999		214,00	xxxxx <sup>1)</sup>
14,000		169,20	14000
14,001 - 14,499		214,00	xxxxx <sup>1)</sup>
14,500		178,30	14500
14,501 - 14,999		214,00	xxxxx <sup>1)</sup>
15,000		178,30	15000
15,001 - 15,499		214,00	xxxxx <sup>1)</sup>
15,500		192,60	15500
15,501 - 15,999		214,00	xxxxx <sup>1)</sup>
16,000		192,60	16000
16,001 - 16,499		214,00	xxxxx <sup>1)</sup>
16,500		200,70	16500
16,501 - 16,999		214,00	xxxxx <sup>1)</sup>
17,000		200,70	17000
17,001 - 17,499		214,00	xxxxx <sup>1)</sup>
17,500		210,90	17500
17,501 - 17,999		214,00	xxxxx <sup>1)</sup>
18,000		210,90	18000
18,001 - 18,499		214,00	xxxxx <sup>1)</sup>
18,500		220,10	18500
18,501 - 18,999		214,00	xxxxx <sup>1)</sup>
19,000		220,10	19000
19,001 - 19,499		214,00	xxxxx <sup>1)</sup>
19,500		224,20	19500
19,501 - 19,999		214,00	xxxxx <sup>1)</sup>
20,000		224,20	20000
20,001 - 20,499		214,00	xxxxx <sup>1)</sup>
20,500		237,40	20500
20,501 - 20,999		214,00	xxxxx <sup>1)</sup>
21,000		237,40	21000
21,001 - 21,499		214,00	xxxxx <sup>1)</sup>
21,500		246,60	21500
21,501 - 21,999		214,00	xxxxx <sup>1)</sup>
22,000		246,60	22000

1) Geen voorraadartikel, ruilen of teruggave is niet mogelijk / Levertijd 7 werkdagen

**i** Voor xxxx gelieve bij bestelling de gewenste diameter aangeven (bv. Ø 6,789 – bestelnummer 81 036 06789)!

# Verstelbare geleidebussen

omschrijving	d DGUI mm	D DFC mm	L <sub>1</sub> OAL mm	K°	G THOD
T 227	34	41	87,5	10	M34 x 1

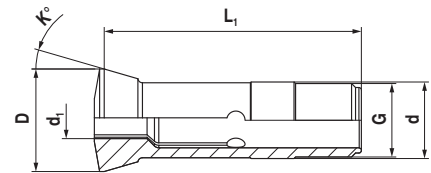

## T 227

▪ met hardmetalen geleiding



T 227

d <sub>1</sub> DCONWS mm	d <sub>1</sub> inch	NEW Y8 bestelnr. 81 040 ... EUR	
1,000		153,00	01000
1,001 - 1,499		166,10	xxxxx <sup>1)</sup>
1,500		153,00	01500
1,501 - 1,999		166,10	xxxxx <sup>1)</sup>
2,000		130,40	02000
2,001 - 2,499		166,10	xxxxx <sup>1)</sup>
2,500		105,00	02500
2,501 - 2,999		166,10	xxxxx <sup>1)</sup>
3,000		105,00	03000
3,001 - 3,499		166,10	xxxxx <sup>1)</sup>
3,500		99,76	03500
3,501 - 3,999		166,10	xxxxx <sup>1)</sup>
4,000		99,76	04000
4,001 - 4,499		166,10	xxxxx <sup>1)</sup>
4,500		106,00	04500
4,501 - 4,999		166,10	xxxxx <sup>1)</sup>
5,000		106,00	05000
5,001 - 5,499		166,10	xxxxx <sup>1)</sup>
5,500		117,20	05500
5,501 - 5,999		166,10	xxxxx <sup>1)</sup>
6,000		117,20	06000
6,001 - 6,349		166,10	xxxxx <sup>1)</sup>
6,350	1/4	166,10	06350
6,351 - 6,499		166,10	xxxxx <sup>1)</sup>
6,500		121,30	06500
6,501 - 6,999		166,10	xxxxx <sup>1)</sup>
7,000		121,30	07000
7,001 - 7,499		166,10	xxxxx <sup>1)</sup>
7,500		130,40	07500
7,501 - 7,999		166,10	xxxxx <sup>1)</sup>
8,000		130,40	08000
8,001 - 8,499		166,10	xxxxx <sup>1)</sup>
8,500		136,60	08500
8,501 - 8,999		166,10	xxxxx <sup>1)</sup>
9,000		136,60	09000
9,001 - 9,499		166,10	xxxxx <sup>1)</sup>
9,500		141,60	09500
9,501 - 9,999		166,10	xxxxx <sup>1)</sup>
10,000		141,60	10000
10,001 - 10,499		166,10	xxxxx <sup>1)</sup>
10,500		146,70	10500
10,501 - 10,999		166,10	xxxxx <sup>1)</sup>
11,000		146,70	11000
11,001 - 11,499		166,10	xxxxx <sup>1)</sup>
11,500		151,80	11500
11,501 - 11,999		166,10	xxxxx <sup>1)</sup>
12,000		151,80	12000
12,001 - 12,499		166,10	xxxxx <sup>1)</sup>
12,500		165,10	12500

d <sub>1</sub> DCONWS mm	d <sub>1</sub> inch	NEW Y8 bestelnr. 81 040 ... EUR	
12,501 - 12,699		166,10	xxxxx <sup>1)</sup>
12,700	1/2	214,00	12700
12,701 - 12,999		214,00	xxxxx <sup>1)</sup>
13,000		165,10	13000
13,001 - 13,499		214,00	xxxxx <sup>1)</sup>
13,500		169,20	13500
13,501 - 13,999		214,00	xxxxx <sup>1)</sup>
14,000		169,20	14000
14,001 - 14,499		214,00	xxxxx <sup>1)</sup>
14,500		178,30	14500
14,501 - 14,999		214,00	xxxxx <sup>1)</sup>
15,000		178,30	15000
15,001 - 15,499		214,00	xxxxx <sup>1)</sup>
15,500		192,60	15500
15,501 - 15,999		214,00	xxxxx <sup>1)</sup>
16,000		192,60	16000
16,001 - 16,499		214,00	xxxxx <sup>1)</sup>
16,500		200,70	16500
16,501 - 16,999		214,00	xxxxx <sup>1)</sup>
17,000		200,70	17000
17,001 - 17,499		214,00	xxxxx <sup>1)</sup>
17,500		210,90	17500
17,501 - 17,999		214,00	xxxxx <sup>1)</sup>
18,000		210,90	18000
18,001 - 18,499		214,00	xxxxx <sup>1)</sup>
18,500		220,10	18500
18,501 - 18,999		214,00	xxxxx <sup>1)</sup>
19,000		220,10	19000
19,001 - 19,499		214,00	xxxxx <sup>1)</sup>
19,500		224,20	19500
19,501 - 19,999		214,00	xxxxx <sup>1)</sup>
20,000		224,20	20000
20,001 - 20,499		214,00	xxxxx <sup>1)</sup>
20,500		237,40	20500
20,501 - 20,999		214,00	xxxxx <sup>1)</sup>
21,000		237,40	21000
21,001 - 21,499		214,00	xxxxx <sup>1)</sup>
21,500		246,60	21500
21,501 - 21,999		214,00	xxxxx <sup>1)</sup>
22,000		246,60	22000
22,001 - 22,499		214,00	xxxxx <sup>1)</sup>
22,500		253,70	22500
22,501 - 22,999		214,00	xxxxx <sup>1)</sup>
23,000		253,70	23000
23,001 - 23,499		214,00	xxxxx <sup>1)</sup>
23,500		261,90	23500
23,501 - 23,999		214,00	xxxxx <sup>1)</sup>
24,000		261,90	24000
24,001 - 24,499		214,00	xxxxx <sup>1)</sup>
24,500		264,90	24500
24,501 - 24,999		214,00	xxxxx <sup>1)</sup>
25,000		264,90	25000

1) Geen voorraadartikel, ruilen of teruggave is niet mogelijk / Levertijd 7 werkdagen

**i** Voor xxxxx gelieve bij bestelling de gewenste diameter aangeven  
(bv. Ø 6,789 – bestelnummer 81 040 06789)!



# Verstelbare geleidebussen

omschrijving	d DGUI mm	D DFC mm	L <sub>1</sub> OAL mm	K°	G THOD
T 229	42	49	82	16	M40 x 1

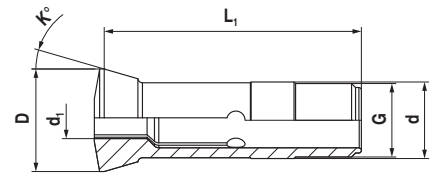

## T 229

▪ met hardmetalen geleiding



T 229

d <sub>1</sub> DCONWS mm	d <sub>1</sub> inch	NEW Y8 bestelnr. 81 041 ... EUR	NEW Y8 bestelnr. 81 042 ... EUR
2,000		196,50 02000	
2,001 - 2,499		206,90 xxxxx <sup>1)</sup>	
2,500		196,50 02500	
2,501 - 2,999		206,90 xxxxx <sup>1)</sup>	
3,000		192,60 03000	
3,001 - 3,499		206,90 xxxxx <sup>1)</sup>	
3,500		192,60 03500	
3,501 - 3,999		206,90 xxxxx <sup>1)</sup>	
4,000		169,20 04000	292,50 04000
4,001 - 4,499		206,90 xxxxx <sup>1)</sup>	
4,500		169,20 04500	
4,501 - 4,999		206,90 xxxxx <sup>1)</sup>	
5,000		154,90 05000	252,70 05000
5,001 - 5,499		206,90 xxxxx <sup>1)</sup>	
5,500		154,90 05500	
5,501 - 5,999		206,90 xxxxx <sup>1)</sup>	
6,000		158,00 06000	267,00 06000
6,001 - 6,349		206,90 xxxxx <sup>1)</sup>	
6,350		206,90 06350	310,20 06350
6,351 - 6,499		206,90 xxxxx <sup>1)</sup>	
6,500		158,00 06500	
6,501 - 6,999		206,90 xxxxx <sup>1)</sup>	
7,000		158,00 07000	273,10 07000
7,001 - 7,499		206,90 xxxxx <sup>1)</sup>	
7,500		158,00 07500	
7,501 - 7,999		206,90 xxxxx <sup>1)</sup>	
8,000		158,00 08000	281,20 08000
8,001 - 8,499		206,90 xxxxx <sup>1)</sup>	
8,500		158,00 08500	
8,501 - 8,999		206,90 xxxxx <sup>1)</sup>	
9,000		158,00 09000	285,30 09000
9,001 - 9,499		206,90 xxxxx <sup>1)</sup>	
9,500		158,00 09500	
9,501 - 9,524		206,90 xxxxx <sup>1)</sup>	
9,525		206,90 09525	
9,526 - 9,999		206,90 xxxxx <sup>1)</sup>	
10,000		158,00 10000	288,40 10000
10,001 - 10,499		206,90 xxxxx <sup>1)</sup>	
10,500		158,00 10500	
10,501 - 10,999		206,90 xxxxx <sup>1)</sup>	
11,000		163,00 11000	298,60 11000
11,001 - 11,499		206,90 xxxxx <sup>1)</sup>	
11,500		163,00 11500	
11,501 - 11,999		206,90 xxxxx <sup>1)</sup>	
12,000		163,00 12000	304,70 12000
12,001 - 12,499		206,90 xxxxx <sup>1)</sup>	
12,500		163,00 12500	
12,501 - 12,699		206,90 xxxxx <sup>1)</sup>	
12,700		210,90 12700	
12,701 - 12,999		210,90 xxxxx <sup>1)</sup>	
13,000		167,10 13000	315,90 13000
13,001 - 13,499		210,90 xxxxx <sup>1)</sup>	
13,500		167,10 13500	
13,501 - 13,999		210,90 xxxxx <sup>1)</sup>	
14,000		172,20 14000	324,00 14000
14,001 - 14,499		210,90 xxxxx <sup>1)</sup>	
14,500		172,20 14500	
14,501 - 14,999		210,90 xxxxx <sup>1)</sup>	
15,000		180,40 15000	336,30 15000
15,001 - 15,499		210,90 xxxxx <sup>1)</sup>	
15,500		180,40 15500	
15,501 - 15,999		210,90 xxxxx <sup>1)</sup>	
16,000		193,60 16000	354,60 16000

d <sub>1</sub> DCONWS mm	d <sub>1</sub> inch	NEW Y8 bestelnr. 81 041 ... EUR	NEW Y8 bestelnr. 81 042 ... EUR
16,001 - 16,499		210,90 xxxxx <sup>1)</sup>	
16,500		193,60 16500	
16,501 - 16,999		210,90 xxxxx <sup>1)</sup>	
17,000		201,80 17000	367,90 17000
17,001 - 17,499		210,90 xxxxx <sup>1)</sup>	
17,500		201,80 17500	
17,501 - 17,999		210,90 xxxxx <sup>1)</sup>	
18,000		213,00 18000	386,20 18000
18,001 - 18,499		210,90 xxxxx <sup>1)</sup>	
18,500		213,00 18500	
18,501 - 18,999		210,90 xxxxx <sup>1)</sup>	
19,000		218,10 19000	405,60 19000
19,001 - 19,049		210,90 xxxxx <sup>1)</sup>	
19,050		267,00 19050	
19,051 - 19,499		267,00 xxxxx <sup>1)</sup>	
19,500		218,10 19500	
19,501 - 19,999		267,00 xxxxx <sup>1)</sup>	
20,000		223,20 20000	417,80 20000
20,001 - 20,499		267,00 xxxxx <sup>1)</sup>	
20,500		223,20 20500	
20,501 - 20,999		267,00 xxxxx <sup>1)</sup>	
21,000		232,30 21000	437,20 21000
21,001 - 21,499		267,00 xxxxx <sup>1)</sup>	
21,500		232,30 21500	
21,501 - 21,999		267,00 xxxxx <sup>1)</sup>	
22,000		242,50 22000	453,50 22000
22,001 - 22,224		267,00 xxxxx <sup>1)</sup>	
22,225		291,40 22225	
22,226 - 22,499		291,40 xxxxx <sup>1)</sup>	
22,500		242,50 22500	
22,501 - 22,999		291,40 xxxxx <sup>1)</sup>	
23,000		253,70 23000	469,80 23000
23,001 - 23,499		291,40 xxxxx <sup>1)</sup>	
23,500		253,70 23500	
23,501 - 23,999		291,40 xxxxx <sup>1)</sup>	
24,000		258,80 24000	483,00 24000
24,001 - 24,499		291,40 xxxxx <sup>1)</sup>	
24,500		258,80 24500	
24,501 - 24,999		291,40 xxxxx <sup>1)</sup>	
25,000		262,90 25000	497,30 25000
25,001 - 25,499		291,40 xxxxx <sup>1)</sup>	
25,500		262,90 25500	
25,501 - 25,999		291,40 xxxxx <sup>1)</sup>	
26,000		269,00 26000	514,60 26000
26,001 - 26,499		291,40 xxxxx <sup>1)</sup>	
26,500		269,00 26500	
26,501 - 26,999		291,40 xxxxx <sup>1)</sup>	
27,000		283,30 27000	532,90 27000
27,001 - 27,499		291,40 xxxxx <sup>1)</sup>	
27,500		283,30 27500	
27,501 - 27,999		291,40 xxxxx <sup>1)</sup>	
28,000		299,60 28000	
28,001 - 28,499		291,40 xxxxx <sup>1)</sup>	
28,500		299,60 28500	
28,501 - 28,999		291,40 xxxxx <sup>1)</sup>	
29,000		313,90 29000	
29,001 - 29,499		291,40 xxxxx <sup>1)</sup>	
29,500		313,90 29500	
29,501 - 29,999		291,40 xxxxx <sup>1)</sup>	
30,000		322,00 30000	
30,001 - 30,499		291,40 xxxxx <sup>1)</sup>	
30,500		322,00 30500	
30,501 - 30,999		291,40 xxxxx <sup>1)</sup>	
31,000		333,20 31000	
31,001 - 31,499		291,40 xxxxx <sup>1)</sup>	
31,500		333,20 31500	
31,501 - 31,999		291,40 xxxxx <sup>1)</sup>	
32,000		343,40 32000	

1) Geen voorraadartikel, ruilen of teruggave is niet mogelijk / Levertijd 7 werkdagen

**i** Voor xxxxx gelieve bij bestelling de gewenste diameter aangeven (bv. Ø 6,789 – bestelnummer 81 041 06789)!



# Flexible geleidebussen

omschrijving	D DFC mm	L <sub>1</sub> OAL mm	K°
GBE 28	28	40	22,5
GBE 42	42	50	22,5

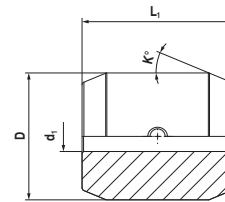

## GBE 28



GBE 28

d <sub>1</sub> DCONWS mm	d <sub>1</sub> inch	NEW Y8 bestelnr. 81 059 ... EUR
3,000		404,50 03000
4,000		404,50 04000
5,000		404,50 05000
6,000		404,50 06000
6,350	1/4	404,50 06350
7,000		404,50 07000
8,000		404,50 08000
9,000		404,50 09000
9,525	3/8	404,50 09525
10,000		340,40 10000
11,000		340,40 11000
12,000		340,40 12000
12,700	1/2	340,40 12700
13,000		340,40 13000
14,000		340,40 14000
15,000		340,40 15000
16,000		340,40 16000
17,000		340,40 17000
18,000		340,40 18000
19,000		340,40 19000
19,050	3/4	340,40 19050
20,000		340,40 20000

## GBE 42



GBE 42

d <sub>1</sub> DCONWS mm	d <sub>1</sub> inch	NEW Y8 bestelnr. 81 060 ... EUR
3,000		565,60 03000
4,000		565,60 04000
5,000		565,60 05000
6,000		565,60 06000
6,350	1/4	565,60 06350
7,000		565,60 07000
8,000		565,60 08000
9,000		565,60 09000
10,000		565,60 10000
11,000		501,40 11000
12,000		501,40 12000
12,700	1/2	501,40 12700
13,000		501,40 13000
14,000		501,40 14000
15,000		501,40 15000
15,875	5/8	501,40 15880
16,000		501,40 16000
17,000		501,40 17000
18,000		501,40 18000
19,000		501,40 19000
19,050	3/4	501,40 19050
20,000		501,40 20000
21,000		501,40 21000
22,000		501,40 22000
22,225	7/8	501,40 22225
23,000		501,40 23000
24,000		501,40 24000
25,000		501,40 25000
25,400	1/1	501,40 25400
26,000		501,40 26000
27,000		501,40 27000
28,000		501,40 28000
29,000		501,40 29000
30,000		501,40 30000
31,000		501,40 31000
32,000		501,40 32000

## Highlights

- Precisie „Made in Germany“ betrouwbare kwaliteit
- Als turbo & standaard verkrijgbaar de hoogste flexibiliteit
- In rond, vierkant of zeskant aanpassing aan het materiaal
- Alle relevante vlakken zijn „precisiegeslepen“ verhoogt de werkstuknauwkeurigheid



## Overzicht aanvoertangen

Norm	bereik buitendiameter in mm	bereik spandiameter	profiel	Uitvoering	pagina
S10		Ø 3,0 - 10,0	●		26
S12		Ø 3,0 - 11,0	●		26
S15		Ø 3,0 - 14,0	●		27
S16		Ø 3,0 - 15,0	●		28
S18		Ø 3,0 - 16,0	●		29
S20		Ø 4,0 - 19,0	●		30
S25		Ø 4,0 - 24,0	●		31
ST32 „Turbo“	32	Ø 5,0 - 32,0	●	Turbo	32
S10		SW 3,0 - 8,0	⬡		26
S12		SW 3,0 - 9,0	⬡		26
S15		SW 3,0 - 12,0	⬡		27
S16		SW 3,0 - 13,0	⬡		28
S18		SW 5,0 - 14,0	⬡		29
S20		SW 5,0 - 16,0	⬡		30
S25		SW 5,0 - 20,0	⬡		31
ST32 „Turbo“	32	SW 5,0 - 26,0	⬡	Turbo	32

# Aanvoertangen

omschrijving	schuiver Ø	D DFC mm	Z KWW mm	P <sub>H7</sub> DCOB mm	L <sub>1</sub> OAL mm
S 10 / 210 E	D 10	10	4	7	40
S 12 / 212 E	D 12	12	4	8	40

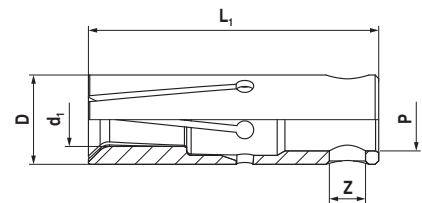

## S 10 / 210 E

▪ ook geschikt voor alle INDEX meerspindel machines



S 10 / 210 E (hex)

d <sub>1</sub> DCONWS mm	d <sub>1</sub> inch	NEW Y8	NEW Y8
		bestelnr. 81 043 ... EUR	bestelnr. 81 044 ... EUR
3,000		43,41 03000	92,63 03000
3,001 - 3,499		47,99 xxxxx <sup>1)</sup>	
3,500		43,41 03500	
3,501 - 3,999		47,99 xxxxx <sup>1)</sup>	
4,000		29,55 04000	75,81 04000
4,001 - 4,499		47,99 xxxxx <sup>1)</sup>	
4,500		29,55 04500	
4,501 - 4,999		47,99 xxxxx <sup>1)</sup>	
5,000		29,55 05000	75,81 05000
5,001 - 5,499		47,99 xxxxx <sup>1)</sup>	
5,500		29,55 05500	
5,501 - 5,999		47,99 xxxxx <sup>1)</sup>	
6,000		29,55 06000	75,81 06000
6,001 - 6,349		47,99 xxxxx <sup>1)</sup>	
6,350	1/4	47,99 06350	
6,351 - 6,499		47,99 xxxxx <sup>1)</sup>	
6,500		29,55 06500	
6,501 - 6,999		47,99 xxxxx <sup>1)</sup>	
7,000		29,55 07000	75,81 07000
7,001 - 7,143		47,99 xxxxx <sup>1)</sup>	
7,144	9/32	47,99 07144	
7,145 - 7,499		47,99 xxxxx <sup>1)</sup>	
7,500		29,55 07500	
7,501 - 7,937		47,99 xxxxx <sup>1)</sup>	
7,938	5/16	47,99 07938	
7,939 - 7,999		47,99 xxxxx <sup>1)</sup>	
8,000		29,55 08000	75,81 08000
8,001 - 8,499		47,99 xxxxx <sup>1)</sup>	
8,500		29,55 08500	
8,501 - 8,999		47,99 xxxxx <sup>1)</sup>	
9,000		43,41 09000	
9,001 - 9,499		47,99 xxxxx <sup>1)</sup>	
9,500		43,41 09500	
9,501 - 9,999		47,99 xxxxx <sup>1)</sup>	
10,000		43,41 10000	

1) Geen voorraadartikel, ruilen of teruggave is niet mogelijk / Levertijd 7 werkdagen

**i** Voor xxxxx gelieve bij bestelling de gewenste diameter aangeven (bv. Ø 6,789 – bestelnummer 81 043 06789)!

## S 12 / 212 E

▪ ook geschikt voor alle INDEX meerspindel machines



S 12 / 212 E (hex)

d <sub>1</sub> DCONWS mm	d <sub>1</sub> inch	NEW Y8	NEW Y8
		bestelnr. 81 045 ... EUR	bestelnr. 81 046 ... EUR
3,000		44,73 03000	96,60 03000
3,001 - 3,499		49,32 xxxxx <sup>1)</sup>	
3,500		44,73 03500	
3,501 - 3,999		49,32 xxxxx <sup>1)</sup>	
4,000		30,88 04000	77,44 04000
4,001 - 4,499		49,32 xxxxx <sup>1)</sup>	
4,500		30,88 04500	
4,501 - 4,762		49,32 xxxxx <sup>1)</sup>	
4,763	3/16	49,32 04763	
4,764 - 4,999		49,32 xxxxx <sup>1)</sup>	
5,000		30,88 05000	77,44 05000
5,001 - 5,499		49,32 xxxxx <sup>1)</sup>	
5,500		30,88 05500	
5,501 - 5,999		49,32 xxxxx <sup>1)</sup>	
6,000		30,88 06000	77,44 06000
6,001 - 6,349		49,32 xxxxx <sup>1)</sup>	
6,350	1/4	49,32 06350	102,10 06350
6,351 - 6,499		49,32 xxxxx <sup>1)</sup>	
6,500		30,88 06500	
6,501 - 6,999		49,32 xxxxx <sup>1)</sup>	
7,000		30,88 07000	77,44 07000
7,001 - 7,499		49,32 xxxxx <sup>1)</sup>	
7,500		30,88 07500	
7,501 - 7,937		49,32 xxxxx <sup>1)</sup>	
7,938	5/16	49,32 07938	
7,939 - 7,999		49,32 xxxxx <sup>1)</sup>	
8,000		30,88 08000	77,44 08000
8,001 - 8,499		49,32 xxxxx <sup>1)</sup>	
8,500		30,88 08500	
8,501 - 8,999		49,32 xxxxx <sup>1)</sup>	
9,000		30,88 09000	77,44 09000
9,001 - 9,499		49,32 xxxxx <sup>1)</sup>	
9,500		30,88 09500	
9,501 - 9,524		49,32 xxxxx <sup>1)</sup>	
9,525	3/8	49,32 09525	
9,526 - 9,999		49,32 xxxxx <sup>1)</sup>	
10,000		44,73 10000	
10,001 - 10,499		49,32 xxxxx <sup>1)</sup>	
10,500		44,73 10500	
10,501 - 10,999		49,32 xxxxx <sup>1)</sup>	
11,000		44,73 11000	

1) Geen voorraadartikel, ruilen of teruggave is niet mogelijk / Levertijd 7 werkdagen

**i** Voor xxxxx gelieve bij bestelling de gewenste diameter aangeven (bv. Ø 6,789 – bestelnummer 81 045 06789)!

# Aanvoertangen

omschrijving	schuiver Ø	D DFC mm	Z KWW mm	P <sub>H7</sub> DCOB mm	L <sub>1</sub> OAL mm
S 15 / 203 E	D 15	15	6	11	40

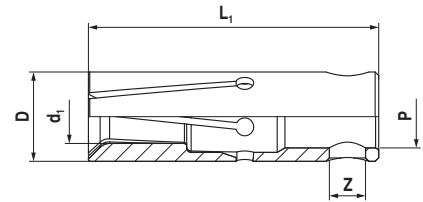

## S 15 / 203 E

ook geschikt voor alle INDEX meerspindel machines



S 15 / 203 E

S 15 / 203 E

d <sub>1</sub> DCONWS mm	d <sub>1</sub> inch	NEW Y8	NEW Y8
		bestelnr. 81 047 ... EUR	bestelnr. 81 048 ... EUR
3,000		47,99	03000
3,001 - 3,174		66,44	xxxxx <sup>1)</sup>
3,175	1/8	66,44	03175
3,176 - 3,499		66,44	xxxxx <sup>1)</sup>
3,500		47,99	03500
3,501 - 3,999		66,44	xxxxx <sup>1)</sup>
4,000		33,53	04000
4,001 - 4,499		66,44	xxxxx <sup>1)</sup>
4,500		33,53	04500
4,501 - 4,999		66,44	xxxxx <sup>1)</sup>
5,000		33,53	05000
5,001 - 5,499		66,44	xxxxx <sup>1)</sup>
5,500		33,53	05500
5,501 - 5,999		66,44	xxxxx <sup>1)</sup>
6,000		33,53	06000
6,001 - 6,349		66,44	xxxxx <sup>1)</sup>
6,350	1/4	51,97	06350
6,351 - 6,499		51,97	xxxxx <sup>1)</sup>
6,500		33,53	06500
6,501 - 6,999		51,97	xxxxx <sup>1)</sup>
7,000		33,53	07000
7,001 - 7,499		51,97	xxxxx <sup>1)</sup>
7,500		33,53	07500
7,501 - 7,937		51,97	xxxxx <sup>1)</sup>
7,938	5/16	51,97	07938
7,939 - 7,999		51,97	xxxxx <sup>1)</sup>
8,000		33,53	08000
8,001 - 8,499		51,97	xxxxx <sup>1)</sup>
8,500		33,53	08500
8,501 - 8,999		51,97	xxxxx <sup>1)</sup>
9,000		33,53	09000
9,001 - 9,499		51,97	xxxxx <sup>1)</sup>
9,500		33,53	09500
9,501 - 9,524		51,97	xxxxx <sup>1)</sup>
9,525	3/8	51,97	09525
9,526 - 9,999		51,97	xxxxx <sup>1)</sup>
10,000		33,53	10000
10,001 - 10,499		51,97	xxxxx <sup>1)</sup>
10,500		33,53	10500
10,501 - 10,999		51,97	xxxxx <sup>1)</sup>
11,000		33,53	11000
11,001 - 11,112		51,97	xxxxx <sup>1)</sup>
11,113	7/16	51,97	11113
11,114 - 11,499		51,97	xxxxx <sup>1)</sup>
11,500		33,53	11500
11,501 - 11,999		51,97	xxxxx <sup>1)</sup>
12,000		33,53	12000

d <sub>1</sub> DCONWS mm	d <sub>1</sub> inch	NEW Y8	NEW Y8
		bestelnr. 81 047 ... EUR	bestelnr. 81 048 ... EUR
12,001 - 12,499		51,97	xxxxx <sup>1)</sup>
12,500		33,53	12500
12,501 - 12,699		51,97	xxxxx <sup>1)</sup>
12,700	1/2	51,97	12700
12,701 - 12,999		51,97	xxxxx <sup>1)</sup>
13,000		33,53	13000
13,001 - 13,499		51,97	xxxxx <sup>1)</sup>
13,500		48,61	13500
13,501 - 13,999		51,97	xxxxx <sup>1)</sup>
14,000		48,61	14000

1) Geen voorraadartikel, ruilen of teruggave is niet mogelijk / Levertijd 7 werkdagen

**i** Voor xxxxx gelieve bij bestelling de gewenste diameter aangeven (bv. Ø 6,789 – bestelnummer 81 047 06789)!

# Aanvoertangen

omschrijving	schuiver Ø	D DFC mm	Z KWW mm	P <sub>H7</sub> DCOB mm	L <sub>1</sub> OAL mm
S 16	D 16	16	6	11	40

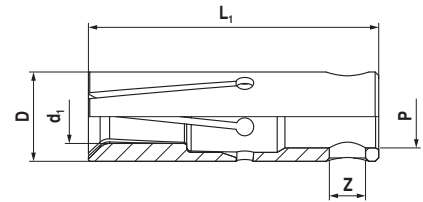

## S 16

ook geschikt voor alle INDEX meerspindel machines



S 16

S 16

d <sub>1</sub> DCONWS mm	d <sub>1</sub> inch	NEW Y8	NEW Y8
		bestelnr. 81 049 ... EUR	bestelnr. 81 050 ... EUR
3,000		47,99 03000	141,60 03000
3,001 - 3,499		51,97 xxxxx <sup>1)</sup>	
3,500		47,99 03500	
3,501 - 3,999		51,97 xxxxx <sup>1)</sup>	
4,000		33,53 04000	80,60 04000
4,001 - 4,499		51,97 xxxxx <sup>1)</sup>	
4,500		33,53 04500	
4,501 - 4,999		51,97 xxxxx <sup>1)</sup>	
5,000		33,53 05000	80,60 05000
5,001 - 5,499		51,97 xxxxx <sup>1)</sup>	
5,500		33,53 05500	
5,501 - 5,999		51,97 xxxxx <sup>1)</sup>	
6,000		33,53 06000	80,60 06000
6,001 - 6,349		51,97 xxxxx <sup>1)</sup>	
6,350	1/4	51,97 06350	
6,351 - 6,499		51,97 xxxxx <sup>1)</sup>	
6,500		46,34 06500	
6,501 - 6,999		51,97 xxxxx <sup>1)</sup>	
7,000		33,53 07000	80,60 07000
7,001 - 7,499		51,97 xxxxx <sup>1)</sup>	
7,500		33,53 07500	
7,501 - 7,999		51,97 xxxxx <sup>1)</sup>	
8,000		33,53 08000	80,60 08000
8,001 - 8,499		51,97 xxxxx <sup>1)</sup>	
8,500		33,53 08500	
8,501 - 8,999		51,97 xxxxx <sup>1)</sup>	
9,000		33,53 09000	80,60 09000
9,001 - 9,499		51,97 xxxxx <sup>1)</sup>	
9,500		33,53 09500	
9,501 - 9,524		51,97 xxxxx <sup>1)</sup>	
9,525	3/8	51,97 09525	
9,526 - 9,999		51,97 xxxxx <sup>1)</sup>	
10,000		33,53 10000	80,60 10000
10,001 - 10,499		51,97 xxxxx <sup>1)</sup>	
10,500		33,53 10500	
10,501 - 10,999		51,97 xxxxx <sup>1)</sup>	
11,000		33,53 11000	80,60 11000
11,001 - 11,112		51,97 xxxxx <sup>1)</sup>	
11,113	7/16	51,97 11113	
11,114 - 11,499		51,97 xxxxx <sup>1)</sup>	
11,500		33,53 11500	
11,501 - 11,999		51,97 xxxxx <sup>1)</sup>	
12,000		33,53 12000	116,20 12000
12,001 - 12,499		51,97 xxxxx <sup>1)</sup>	
12,500		33,53 12500	
12,501 - 12,699		51,97 xxxxx <sup>1)</sup>	
12,700	1/2	51,97 12700	

d <sub>1</sub> DCONWS mm	d <sub>1</sub> inch	NEW Y8	NEW Y8
		bestelnr. 81 049 ... EUR	bestelnr. 81 050 ... EUR
12,701 - 12,999		51,97 xxxxx <sup>1)</sup>	
13,000		33,53 13000	116,20 13000
13,001 - 13,499		51,97 xxxxx <sup>1)</sup>	
13,500		48,61 13500	
13,501 - 13,999		51,97 xxxxx <sup>1)</sup>	
14,000		48,61 14000	
14,001 - 14,287		51,97 xxxxx <sup>1)</sup>	
14,288	9/16	67,05 14288	
14,289 - 14,499		67,05 xxxxx <sup>1)</sup>	
14,500		48,61 14500	
14,501 - 14,999		67,05 xxxxx <sup>1)</sup>	
15,000		48,61 15000	

1) Geen voorraadartikel, ruilen of teruggave is niet mogelijk / Levertijd 7 werkdagen

**i** Voor xxxxx gelieve bij bestelling de gewenste diameter aangeven (bv. Ø 6,789 – bestelnummer 81 049 06789)!

# Aanvoertangen

omschrijving	schuiver Ø	D DFC mm	Z KWW mm	P <sub>H7</sub> DCOB mm	L <sub>1</sub> OAL mm
S 18 / 218 E	D 18	18	6	11	40

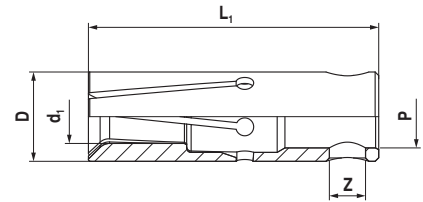

## S 18 / 218 E

ook geschikt voor alle INDEX meerspindel machines



S 18 / 218 E

S 18 / 218 E

d <sub>1</sub> DCONWS mm	d <sub>1</sub> inch	NEW Y8 bestelnr. 81 051 ... EUR	S 18 / 218 E	NEW Y8 bestelnr. 81 052 ... EUR	S 18 / 218 E
3,000		51,97	03000		
3,001 - 3,174		70,31	xxxxx <sup>1)</sup>		
3,175	1/8	70,31	03175		
3,176 - 3,499		70,31	xxxxx <sup>1)</sup>		
3,500		51,97	03500		
3,501 - 3,999		70,31	xxxxx <sup>1)</sup>		
4,000		51,97	04000		
4,001 - 4,499		70,31	xxxxx <sup>1)</sup>		
4,500		51,97	04500		
4,501 - 4,762		70,31	xxxxx <sup>1)</sup>		
4,763	3/16	70,31	04763		
4,764 - 4,999		70,31	xxxxx <sup>1)</sup>		
5,000		36,79	05000	84,58	05000
5,001 - 5,499		70,31	xxxxx <sup>1)</sup>		
5,500		36,79	05500		
5,501 - 5,999		70,31	xxxxx <sup>1)</sup>		
6,000		36,79	06000	84,58	06000
6,001 - 6,499		70,31	xxxxx <sup>1)</sup>		
6,500		36,79	06500		
6,501 - 6,999		70,31	xxxxx <sup>1)</sup>		
7,000		36,79	07000	84,58	07000
7,001 - 7,499		70,31	xxxxx <sup>1)</sup>		
7,500		36,79	07500		
7,501 - 7,937		70,31	xxxxx <sup>1)</sup>		
7,938	5/16	55,23	07938		
7,939 - 7,999		55,23	xxxxx <sup>1)</sup>		
8,000		36,79	08000	84,58	08000
8,001 - 8,499		55,23	xxxxx <sup>1)</sup>		
8,500		36,79	08500		
8,501 - 8,999		55,23	xxxxx <sup>1)</sup>		
9,000		36,79	09000	84,58	09000
9,001 - 9,499		55,23	xxxxx <sup>1)</sup>		
9,500		36,79	09500		
9,501 - 9,524		55,23	xxxxx <sup>1)</sup>		
9,525	3/8	55,23	09525		
9,526 - 9,999		55,23	xxxxx <sup>1)</sup>		
10,000		36,79	10000	84,58	10000
10,001 - 10,499		55,23	xxxxx <sup>1)</sup>		
10,500		36,79	10500		
10,501 - 10,999		55,23	xxxxx <sup>1)</sup>		
11,000		36,79	11000	120,20	11000
11,001 - 11,112		55,23	xxxxx <sup>1)</sup>		
11,113	7/16	55,23	11113		
11,114 - 11,499		55,23	xxxxx <sup>1)</sup>		
11,500		36,79	11500		
11,501 - 11,999		55,23	xxxxx <sup>1)</sup>		
12,000		36,79	12000	120,20	12000

d <sub>1</sub> DCONWS mm	d <sub>1</sub> inch	NEW Y8 bestelnr. 81 051 ... EUR	NEW Y8 bestelnr. 81 052 ... EUR
12,001 - 12,499		55,23	xxxxx <sup>1)</sup>
12,500		36,79	12500
12,501 - 12,699		55,23	xxxxx <sup>1)</sup>
12,700	1/2	55,23	12700
12,701 - 12,999		55,23	xxxxx <sup>1)</sup>
13,000		36,79	13000
13,001 - 13,499		55,23	xxxxx <sup>1)</sup>
13,500		36,79	13500
13,501 - 13,999		55,23	xxxxx <sup>1)</sup>
14,000		36,79	14000
14,001 - 14,287		55,23	xxxxx <sup>1)</sup>
14,288	9/16	55,23	14288
14,289 - 14,499		55,23	xxxxx <sup>1)</sup>
14,500		36,79	14500
14,501 - 14,999		55,23	xxxxx <sup>1)</sup>
15,000		36,79	15000
15,001 - 15,499		55,23	xxxxx <sup>1)</sup>
15,500		36,79	15500
15,501 - 15,874		55,23	xxxxx <sup>1)</sup>
15,875	5/8	55,23	15875
15,876 - 15,999		55,23	xxxxx <sup>1)</sup>
16,000		36,79	16000

1) Geen voorraadartikel, ruilen of teruggave is niet mogelijk / Levertijd 7 werkdagen

**i** Voor xxxxx gelieve bij bestelling de gewenste diameter aangeven (bv. Ø 6,789 – bestelnummer 81 051 06789)!

# Aanvoertangen

omschrijving	schuiver Ø	D DFC mm	Z KWW mm	P <sub>H7</sub> DCOB mm	L <sub>1</sub> OAL mm
S 20 / 225 E	D 20	20	8	14	65

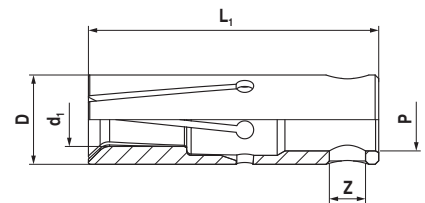

## S 20 / 225 E

ook geschikt voor alle INDEX meerspindel machines



d <sub>1</sub> DCONWS mm	d <sub>1</sub> inch	S 20 / 225 E		S 20 / 225 E	
		NEW Y8 bestelnr. 81 053 ... EUR		NEW Y8 bestelnr. 81 054 ... EUR	
4,000		51,97	04000		
4,001 - 4,499		70,31	xxxxx <sup>1)</sup>		
4,500		51,97	04500		
4,501 - 4,762		70,31	xxxxx <sup>1)</sup>		
4,763	3/16	70,31	04763		
4,764 - 4,999		70,31	xxxxx <sup>1)</sup>		
5,000		51,97	05000	87,02	05000
5,001 - 5,499		70,31	xxxxx <sup>1)</sup>		
5,500		51,97	05500		
5,501 - 5,999		70,31	xxxxx <sup>1)</sup>		
6,000		38,82	06000	87,02	06000
6,001 - 6,349		70,31	xxxxx <sup>1)</sup>		
6,350	1/4	57,17	06350	127,80	06350
6,351 - 6,499		57,17	xxxxx <sup>1)</sup>		
6,500		38,82	06500		
6,501 - 6,999		57,17	xxxxx <sup>1)</sup>		
7,000		38,82	07000	87,02	07000
7,001 - 7,499		57,17	xxxxx <sup>1)</sup>		
7,500		38,82	07500		
7,501 - 7,937		57,17	xxxxx <sup>1)</sup>		
7,938	5/16	57,17	07938		
7,939 - 7,999		57,17	xxxxx <sup>1)</sup>		
8,000		38,82	08000	87,02	08000
8,001 - 8,499		57,17	xxxxx <sup>1)</sup>		
8,500		38,82	08500		
8,501 - 8,999		57,17	xxxxx <sup>1)</sup>		
9,000		38,82	09000	87,02	09000
9,001 - 9,499		57,17	xxxxx <sup>1)</sup>		
9,500		38,82	09500		
9,501 - 9,524		57,17	xxxxx <sup>1)</sup>		
9,525	3/8	57,17	09525		
9,526 - 9,999		57,17	xxxxx <sup>1)</sup>		
10,000		38,82	10000	87,02	10000
10,001 - 10,499		57,17	xxxxx <sup>1)</sup>		
10,500		38,82	10500		
10,501 - 10,999		57,17	xxxxx <sup>1)</sup>		
11,000		38,82	11000	122,30	11000
11,001 - 11,112		57,17	xxxxx <sup>1)</sup>		
11,113	7/16	57,17	11113		
11,114 - 11,499		57,17	xxxxx <sup>1)</sup>		
11,500		38,82	11500		
11,501 - 11,999		57,17	xxxxx <sup>1)</sup>		
12,000		38,82	12000	122,30	12000
12,001 - 12,499		57,17	xxxxx <sup>1)</sup>		
12,500		38,82	12500		
12,501 - 12,699		57,17	xxxxx <sup>1)</sup>		
12,700	1/2	57,17	12700	144,70	12700

d <sub>1</sub> DCONWS mm	d <sub>1</sub> inch	NEW Y8	NEW Y8
		bestelnr. 81 053 ... EUR	bestelnr. 81 054 ... EUR
12,701 - 12,999		57,17 xxxxx <sup>1)</sup>	
13,000		38,82 13000	122,30 13000
13,001 - 13,499		57,17 xxxxx <sup>1)</sup>	
13,500		38,82 13500	
13,501 - 13,999		57,17 xxxxx <sup>1)</sup>	
14,000		38,82 14000	122,30 14000
14,001 - 14,499		57,17 xxxxx <sup>1)</sup>	
14,500		38,82 14500	
14,501 - 14,999		57,17 xxxxx <sup>1)</sup>	
15,000		38,82 15000	122,30 15000
15,001 - 15,499		57,17 xxxxx <sup>1)</sup>	
15,500		38,82 15500	
15,501 - 15,999		57,17 xxxxx <sup>1)</sup>	
16,000		38,82 16000	122,30 16000
16,001 - 16,499		57,17 xxxxx <sup>1)</sup>	
16,500		38,82 16500	
16,501 - 16,999		57,17 xxxxx <sup>1)</sup>	
17,000		38,82 17000	
17,001 - 17,499		57,17 xxxxx <sup>1)</sup>	
17,500		38,82 17500	
17,501 - 17,999		57,17 xxxxx <sup>1)</sup>	
18,000		38,82 18000	
18,001 - 18,499		57,17 xxxxx <sup>1)</sup>	
18,500		51,97 18500	
18,501 - 18,999		57,17 xxxxx <sup>1)</sup>	
19,000		51,97 19000	

1) Geen voorraadartikel, ruilen of teruggave is niet mogelijk / Levertijd 7 werkdagen

**i** Voor xxxxx gelieve bij bestelling de gewenste diameter aangeven (bv. Ø 6,789 – bestelnummer 81 053 06789)!

# Aanvoertangen

omschrijving	schuiver Ø	D DFC mm	Z KWW mm	P <sub>H7</sub> DCOB mm	L <sub>1</sub> OAL mm
S 25 / 222 E	D 25	25	8	20	65

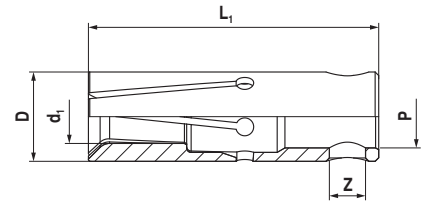

## S 25 / 222 E

▪ ook geschikt voor alle INDEX meerspindel machines



S 25 / 222 E

S 25 / 222 E

d <sub>1</sub> DCONWS mm	d <sub>1</sub> inch	NEW Y8	NEW Y8
		bestelnr. 81 055 ... EUR	bestelnr. 81 056 ... EUR
4,000		53,29 04000	
4,001 - 4,499		58,49 xxxxx <sup>1)</sup>	
4,500		53,29 04500	
4,501 - 4,999		58,49 xxxxx <sup>1)</sup>	
5,000		53,29 05000	105,00 05000
5,001 - 5,499		58,49 xxxxx <sup>1)</sup>	
5,500		53,29 05500	
5,501 - 5,999		58,49 xxxxx <sup>1)</sup>	
6,000		40,15 06000	88,65 06000
6,001 - 6,349		58,49 xxxxx <sup>1)</sup>	
6,350	1/4	58,49 06350	110,10 06350
6,351 - 6,499		58,49 xxxxx <sup>1)</sup>	
6,500		40,15 06500	
6,501 - 6,999		58,49 xxxxx <sup>1)</sup>	
7,000		40,15 07000	88,65 07000
7,001 - 7,499		58,49 xxxxx <sup>1)</sup>	
7,500		40,15 07500	
7,501 - 7,999		58,49 xxxxx <sup>1)</sup>	
8,000		40,15 08000	88,65 08000
8,001 - 8,499		58,49 xxxxx <sup>1)</sup>	
8,500		40,15 08500	
8,501 - 8,999		58,49 xxxxx <sup>1)</sup>	
9,000		40,15 09000	88,65 09000
9,001 - 9,499		58,49 xxxxx <sup>1)</sup>	
9,500		40,15 09500	
9,501 - 9,999		58,49 xxxxx <sup>1)</sup>	
10,000		40,15 10000	88,65 10000
10,001 - 10,499		58,49 xxxxx <sup>1)</sup>	
10,500		40,15 10500	
10,501 - 10,999		58,49 xxxxx <sup>1)</sup>	
11,000		40,15 11000	123,30 11000
11,001 - 11,499		58,49 xxxxx <sup>1)</sup>	
11,500		40,15 11500	
11,501 - 11,999		58,49 xxxxx <sup>1)</sup>	
12,000		40,15 12000	123,30 12000
12,001 - 12,499		58,49 xxxxx <sup>1)</sup>	
12,500		40,15 12500	
12,501 - 12,699		58,49 xxxxx <sup>1)</sup>	
12,700	1/2	58,49 12700	
12,701 - 12,999		58,49 xxxxx <sup>1)</sup>	
13,000		40,15 13000	123,30 13000
13,001 - 13,499		58,49 xxxxx <sup>1)</sup>	
13,500		40,15 13500	
13,501 - 13,999		58,49 xxxxx <sup>1)</sup>	
14,000		40,15 14000	123,30 14000
14,001 - 14,499		58,49 xxxxx <sup>1)</sup>	
14,500		40,15 14500	

d <sub>1</sub> DCONWS mm	d <sub>1</sub> inch	NEW Y8	NEW Y8
		bestelnr. 81 055 ... EUR	bestelnr. 81 056 ... EUR
14,501 - 14,999		58,49 xxxxx <sup>1)</sup>	
15,000		40,15 15000	123,30 15000
15,001 - 15,499		58,49 xxxxx <sup>1)</sup>	
15,500		40,15 15500	
15,501 - 15,999		58,49 xxxxx <sup>1)</sup>	
16,000		40,15 16000	123,30 16000
16,001 - 16,499		58,49 xxxxx <sup>1)</sup>	
16,500		40,15 16500	
16,501 - 16,999		58,49 xxxxx <sup>1)</sup>	
17,000		40,15 17000	123,30 17000
17,001 - 17,499		58,49 xxxxx <sup>1)</sup>	
17,500		40,15 17500	
17,501 - 17,999		58,49 xxxxx <sup>1)</sup>	
18,000		40,15 18000	123,30 18000
18,001 - 18,499		58,49 xxxxx <sup>1)</sup>	
18,500		40,15 18500	
18,501 - 18,999		58,49 xxxxx <sup>1)</sup>	
19,000		40,15 19000	123,30 19000
19,001 - 19,049		58,49 xxxxx <sup>1)</sup>	
19,050	3/4	58,49 19050	
19,051 - 19,499		58,49 xxxxx <sup>1)</sup>	
19,500		40,15 19500	
19,501 - 19,999		58,49 xxxxx <sup>1)</sup>	
20,000		40,15 20000	123,30 20000
20,001 - 20,499		58,49 xxxxx <sup>1)</sup>	
20,500		40,15 20500	
20,501 - 20,999		58,49 xxxxx <sup>1)</sup>	
21,000		40,15 21000	
21,001 - 21,499		58,49 xxxxx <sup>1)</sup>	
21,500		40,15 21500	
21,501 - 21,999		58,49 xxxxx <sup>1)</sup>	
22,000		40,15 22000	
22,001 - 22,499		58,49 xxxxx <sup>1)</sup>	
22,500		40,15 22500	
22,501 - 22,999		58,49 xxxxx <sup>1)</sup>	
23,000		40,15 23000	
23,001 - 23,499		58,49 xxxxx <sup>1)</sup>	
23,500		53,29 23500	
23,501 - 23,999		58,49 xxxxx <sup>1)</sup>	
24,000		53,29 24000	

1) Geen voorraadartikel, ruilen of teruggave is niet mogelijk / Levertijd 7 werkdagen

**i** Voor xxxxx gelieve bij bestelling de gewenste diameter aangeven (bv. Ø 6,789 – bestelnummer 81 055 06789)!



# Aanvoertangen - Turbo

omschrijving	schuiver Ø	D DFC mm	P <sub>H7</sub> DCOB mm	L <sub>1</sub> OAL mm
ST 32	D 32	32	20	90

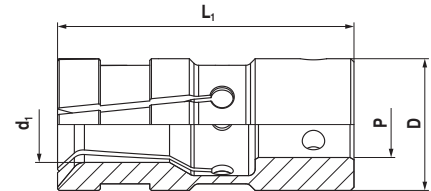

## ST 32

▪ ook geschikt voor alle INDEX meerspindel machines



ST 32

ST 32

d <sub>1</sub> DCONWS mm	d <sub>1</sub> inch	NEW Y8		NEW Y8	
		bestelnr. 81 057 ... EUR	05000 xxxxx <sup>1)</sup>	bestelnr. 81 058 ... EUR	05000 xxxxx <sup>1)</sup>
5,000		92,02	05000	168,10	05000
5,001 - 5,499		126,40	xxxxx <sup>1)</sup>		
5,500		92,02	05500		
5,501 - 5,999		126,40	xxxxx <sup>1)</sup>		
6,000		92,02	06000	168,10	06000
6,001 - 6,349		126,40	xxxxx <sup>1)</sup>		
6,350	1/4	126,40	06350		
6,351 - 6,499		126,40	xxxxx <sup>1)</sup>		
6,500		92,02	06500		
6,501 - 6,999		126,40	xxxxx <sup>1)</sup>		
7,000		92,02	07000	168,10	07000
7,001 - 7,499		126,40	xxxxx <sup>1)</sup>		
7,500		92,02	07500		
7,501 - 7,999		126,40	xxxxx <sup>1)</sup>		
8,000		92,02	08000	168,10	08000
8,001 - 8,499		126,40	xxxxx <sup>1)</sup>		
8,500		92,02	08500		
8,501 - 8,999		126,40	xxxxx <sup>1)</sup>		
9,000		53,29	09000	120,20	09000
9,001 - 9,499		126,40	xxxxx <sup>1)</sup>		
9,500		53,29	09500		
9,501 - 9,524		126,40	xxxxx <sup>1)</sup>		
9,525	3/8	87,43	09525		
9,526 - 9,999		87,43	xxxxx <sup>1)</sup>		
10,000		53,29	10000	120,20	10000
10,001 - 10,499		87,43	xxxxx <sup>1)</sup>		
10,500		53,29	10500		
10,501 - 10,999		87,43	xxxxx <sup>1)</sup>		
11,000		53,29	11000	126,40	11000
11,001 - 11,499		87,43	xxxxx <sup>1)</sup>		
11,500		53,29	11500		
11,501 - 11,999		87,43	xxxxx <sup>1)</sup>		
12,000		53,29	12000	126,40	12000
12,001 - 12,499		87,43	xxxxx <sup>1)</sup>		
12,500		53,29	12500		
12,501 - 12,699		87,43	xxxxx <sup>1)</sup>		
12,700	1/2	87,43	12700		
12,701 - 12,999		87,43	xxxxx <sup>1)</sup>		
13,000		53,29	13000	126,40	13000
13,001 - 13,499		87,43	xxxxx <sup>1)</sup>		
13,500		53,29	13500		
13,501 - 13,999		87,43	xxxxx <sup>1)</sup>		
14,000		53,29	14000	126,40	14000
14,001 - 14,499		87,43	xxxxx <sup>1)</sup>		
14,500		53,29	14500		
14,501 - 14,999		87,43	xxxxx <sup>1)</sup>		
15,000		53,29	15000	126,40	15000
15,001 - 15,499		87,43	xxxxx <sup>1)</sup>		
15,500		53,29	15500		
15,501 - 15,874		87,43	xxxxx <sup>1)</sup>		
15,875	5/8	87,43	15875		
15,876 - 15,999		87,43	xxxxx <sup>1)</sup>		
16,000		53,29	16000	126,40	16000
16,001 - 16,499		87,43	xxxxx <sup>1)</sup>		
16,500		53,29	16500		
16,501 - 16,999		87,43	xxxxx <sup>1)</sup>		
17,000		53,29	17000	126,40	17000

d <sub>1</sub> DCONWS mm	d <sub>1</sub> inch	NEW Y8		NEW Y8	
		bestelnr. 81 057 ... EUR	xxxxx <sup>1)</sup>	bestelnr. 81 058 ... EUR	xxxxx <sup>1)</sup>
17,001 - 17,462		87,43	xxxxx <sup>1)</sup>		
17,463	11/16	87,43	17463		
17,464 - 17,499		87,43	xxxxx <sup>1)</sup>		
17,500		53,29	17500		
17,501 - 17,999		87,43	xxxxx <sup>1)</sup>		
18,000		53,29	18000	126,40	18000
18,001 - 18,499		87,43	xxxxx <sup>1)</sup>		
18,500		53,29	18500		
18,501 - 18,999		87,43	xxxxx <sup>1)</sup>		
19,000		53,29	19000	126,40	19000
19,001 - 19,049		87,43	xxxxx <sup>1)</sup>		
19,050	3/4	87,43	19050		
19,051 - 19,499		87,43	xxxxx <sup>1)</sup>		
19,500		53,29	19500		
19,501 - 19,999		87,43	xxxxx <sup>1)</sup>		
20,000		53,29	20000	126,40	20000
20,001 - 20,499		87,43	xxxxx <sup>1)</sup>		
20,500		53,29	20500		
20,501 - 20,999		87,43	xxxxx <sup>1)</sup>		
21,000		53,29	21000	145,70	21000
21,001 - 21,499		87,43	xxxxx <sup>1)</sup>		
21,500		53,29	21500		
21,501 - 21,999		87,43	xxxxx <sup>1)</sup>		
22,000		53,29	22000	145,70	22000
22,001 - 22,224		87,43	xxxxx <sup>1)</sup>		
22,225	7/8	87,43	22225		
22,226 - 22,499		87,43	xxxxx <sup>1)</sup>		
22,500		53,29	22500		
22,501 - 22,999		87,43	xxxxx <sup>1)</sup>		
23,000		53,29	23000	145,70	23000
23,001 - 23,499		87,43	xxxxx <sup>1)</sup>		
23,500		53,29	23500		
23,501 - 23,999		87,43	xxxxx <sup>1)</sup>		
24,000		53,29	24000	145,70	24000
24,001 - 24,499		87,43	xxxxx <sup>1)</sup>		
24,500		53,29	24500		
24,501 - 24,999		87,43	xxxxx <sup>1)</sup>		
25,000		53,29	25000	145,70	25000
25,001 - 25,399		87,43	xxxxx <sup>1)</sup>		
25,400	1/1	87,43	25400		
25,401 - 25,499		87,43	xxxxx <sup>1)</sup>		
25,500		53,29	25500		
25,501 - 25,999		87,43	xxxxx <sup>1)</sup>		
26,000		53,29	26000	145,70	26000
26,001 - 26,499		87,43	xxxxx <sup>1)</sup>		
26,500		53,29	26500		
26,501 - 26,999		87,43	xxxxx <sup>1)</sup>		
27,000		53,29	27000		
27,001 - 27,499		87,43	xxxxx <sup>1)</sup>		
27,500		53,29	27500		
27,501 - 27,999		87,43	xxxxx <sup>1)</sup>		
28,000		53,29	28000		
28,001 - 28,499		87,43	xxxxx <sup>1)</sup>		
28,500		92,02	28500		
28,501 - 28,574		87,43	xxxxx <sup>1)</sup>		
28,575	1 1/8	126,40	28575		
28,576 - 28,999		126,40	xxxxx <sup>1)</sup>		
29,000		92,02	29000		
29,001 - 29,499		126,40	xxxxx <sup>1)</sup>		
29,500		92,02	29500		
29,501 - 29,999		126,40	xxxxx <sup>1)</sup>		
30,000		92,02	30000		

1) Geen voorraadartikel, ruilen of teruggave is niet mogelijk / Levertijd 7 werkdagen

**i** Voor xxxxx gelieve bij bestelling de gewenste diameter aangeven  
(bv. Ø 6,789 - bestelnummer 81 057 06789)!

## Technische informatie

### Rondlooptolerantie

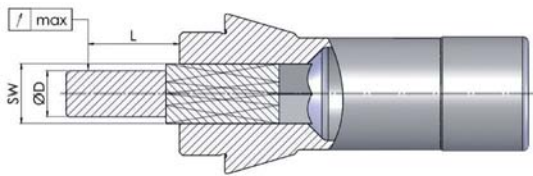

Rondlooptoleranties van profielspantangen					
profiel SW		L mm	standaard norm	WNT-Norm	
van	tot			Standaard	HP*
0,5	0,9	3	0,12	< 0,02	< 0,01
1	1,5	6	0,12	< 0,02	< 0,01
1,6	3	10	0,12	< 0,02	< 0,01
3,1	6	16	0,12	< 0,02	< 0,01
6,1	10	25	0,15	< 0,02	< 0,01
10,1	18	40	0,2	< 0,02	< 0,01
18,1	24	50	0,2	< 0,02	< 0,01
24,1	30	60	0,2	< 0,02	< 0,01
30,0		80	0,2	< 0,02	< 0,01

\* Kleinere rondlooptoleranties met de WNT HP (HighPrecision)-optie op aanvraag.

Onze profielspantangen en geleidebussen worden met maximaal 7 sleuven fijngeërodeerd. Daardoor garanderen wij u de hoogste kwaliteit en tegelijkertijd de kleinste rondlooptoleranties.

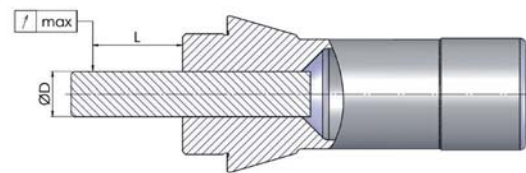

Rondlooptoleranties van ronde spantangen				
Boring		L mm	WNT-Norm	
van	tot		Standaard	HP*
0,5	0,9	3	< 0,01	< 0,008
1	1,5	6	< 0,01	< 0,008
1,6	3	10	< 0,015	< 0,008
3,1	6	16	< 0,015	< 0,008
6,1	10	25	< 0,015	< 0,008
10,1	18	40	< 0,02	< 0,01
18,1	24	50	< 0,02	< 0,01
24,1	30	60	< 0,02	< 0,01
30,0		80	< 0,03	< 0,015

\* Kleinere rondlooptoleranties met de WNT HP (HighPrecision)-optie op aanvraag.

Uw eis is ons streven. Daarom zijn de toleranties van de WNT-norm duidelijk kleiner dan de standaard toleranties. De levensduur van machine-componenten stijgt precies zoals die van de gereedschappen.

## Speciale vormen

Door een veelvoud van verschillende toepassingen ontstaat de noodzaak, bepaalde producten individueel op de processen aan te passen. Hiervoor bieden wij u de hoogste kwaliteit volgens uw richtlijnen aan. Maak gebruik van onderstaande mogelijkheden en laat uw spanmiddel maken:

### Persoonlijk advies

Heeft u interesse in onze span-opties?

Dan staan onze technisch adviseurs in de buitendienst u graag voor advies ter zijde. Dit geldt natuurlijk ook voor onze technici in de binnendienst, die u via ons servicenummer kunt bereiken.

### Aanvragen met formulier

Indien u ons een aanvraag voor een speciaal aangepaste oplossing wilt toesturen, vindt u op onze homepage onder het tabblad download een uitgebreide vragenlijst. Vult u deze alstublieft zorgvuldig in en zendt ons deze per E-mail of als fax toe.

→ [www.wnt.com/nl/download/](http://www.wnt.com/nl/download/)