

Technical Manual

Brake disc machining



CERATIZIT is a high-tech engineering group specialised in tooling and hard material technologies.

Tooling the Future

www.ceratizit.com

Dear customers,

Machining brake discs and brake drums presents major challenges: the strong competitive pressure calls for ever-increasing performance at lower and lower costs. Series production, above all, places high demands of application data and process security here, in order to keep the item costs as low as possible.

As a long-standing partner of leading manufacturers, we are extremely familiar with these requirements in large-scale production and can offer you a range of innovative and significantly improved cutting material and cutting tool solutions for all areas of brake disc machining. We will support you in optimising your processes and increasing productivity within your company. Get in touch!

Your Cutting Solutions by CERATIZIT team





**Advantage through innovation:
longer service lives thanks to
first-class cutting materials
and optimised tools**

Contents

Introduction	6–17
CERATIZIT Group	6–7
Quality	8–9
Logistics	10–11
CERATIZIT Services	12–13
Brake disc machining – overview	14–17
Designation systems	18–25
Designation systems for tools and indexable inserts	18–24
Designation system for grades	25
Material - cast iron	26–37
Material designation system	28
Cast iron – overview	29–30
Relative machinability – comparison	31–37
Turning with ceramics and CBN	38–65
Overview and description of grades	40–43
C-clamp 2.0 – advantages and installation instructions	44–48
Indexable inserts	49–51
Tools	52–63
Indexable inserts for ISO holders	64–65
Turning with carbide grades	66–89
Overview and description of grades	68–69
Indexable inserts	70–77
Tools	78–89
Ceramic grooving with CX 24	90–95
Overview and description of grades	92
Grooving inserts	93
Tools	94–95
Technical references	96–113
Success stories	98–105
Types of wear	106–107
Troubleshooting guide for turning	108–109
Comparison table for materials	110–113
OEM services	114–123
OEM services	116–119
Industry solutions	120



CERATIZIT – your competent partner for innovative hard materials solutions, highly-specialised cutting tools and worldwide service

CERATIZIT – with passion and pioneering spirit for carbides

For more than **95 years**, CERATIZIT has been a **pioneer** in the field of ambitious hard materials solutions for machining and protection against wear. The private company, with registered offices in Mamer, Luxembourg, develops and produces highly-specialised cutting tools, indexable inserts, rods and wear parts made from hard materials. The CERATIZIT Group is the **global market leader** in various application segments for wear parts and is successfully developing new carbide, cermet and ceramic grades, for example for woodworking and stone working. With more than 9,000 employees at 34 production facilities worldwide and a sales network with over 70 branches, CERATIZIT is a global player in the carbide sector. The technology leader is constantly investing in research and development and holds more than

1,000 patents. Innovative carbide solutions from CERATIZIT are used in mechanical engineering and tool making, in the automotive industry, the aviation and aerospace industry, and in the medical industry.

The CERATIZIT Group is active internationally and unites the four flagship brands Cutting Solutions by CERATIZIT, Hard Material Solutions by CERATIZIT, Tool Solutions by CERATIZIT and Toolmaker Solutions by CERATIZIT. The carbide manufacturer also owns the WNT and CB-CERATIZIT subsidiaries, as well as the tool manufacturers Günther Wirth, PROMAX Tools, Klenk, Cobra Carbide India, Becker Diamantwerkzeuge, Best Carbide Cutting Tools and KOMET GROUP.

Facts & figures

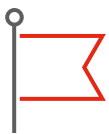

1 headquarters
Mamer / Luxembourg

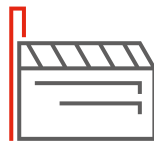

34
Production facilities



> 70
Sales offices



> 9,000
Employees



> 100,000
Different products



> 1,000
Patents and utility models



> 200
Employees in R&D



> 10
Innovation prizes



30%
Products that are less than 5 years old

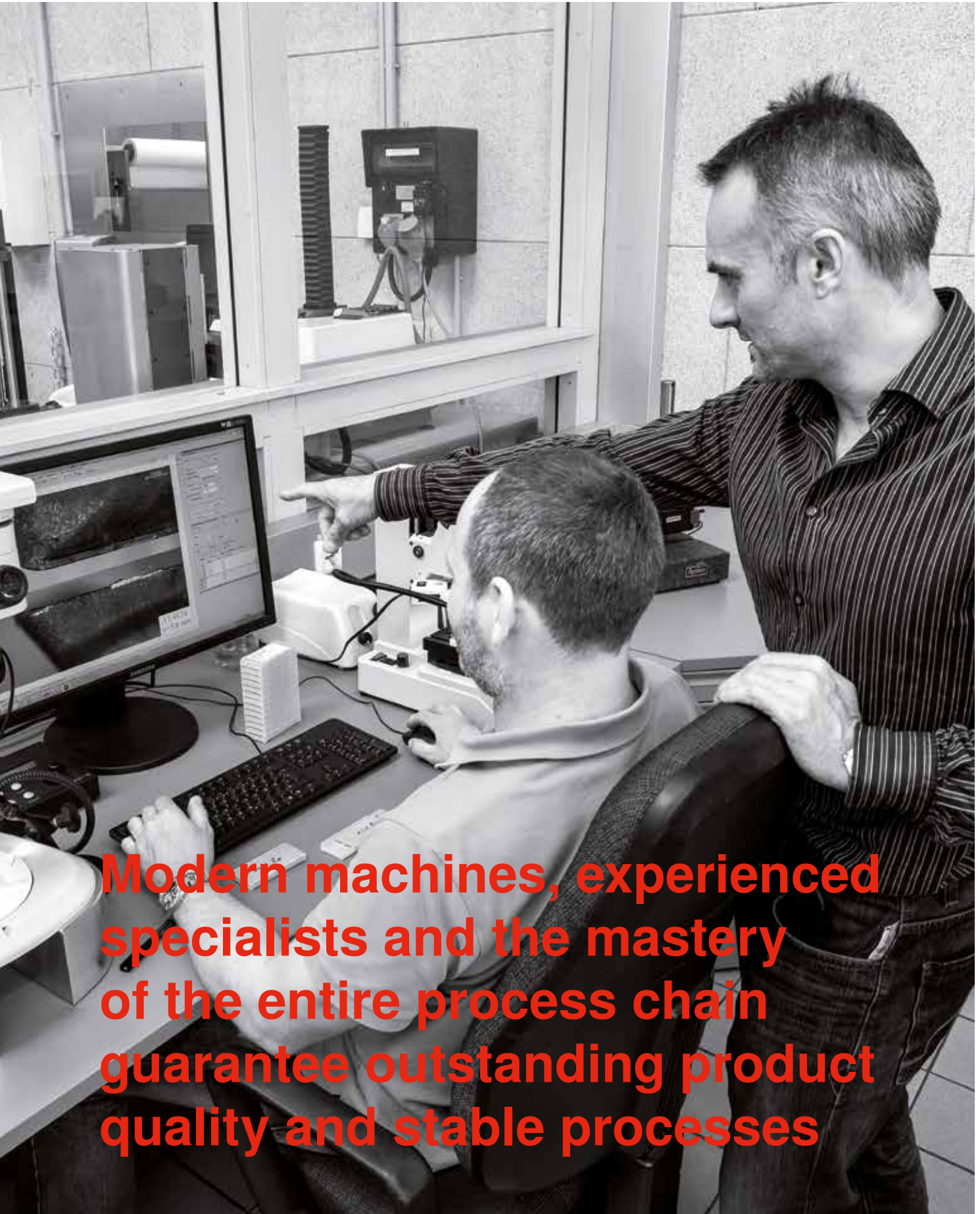

Modern machines, experienced specialists and the mastery of the entire process chain guarantee outstanding product quality and stable processes

Always the best quality

Cutting Solutions by CERATIZIT is a quality leader that unites all of the process knowledge and the extensive manufacturing competences of the CERATIZIT Group.

- ▲ Highly-qualified, trained experts in a wide range of areas.
- ▲ We control each individual production step.
- ▲ Our modern fleet of machinery is constantly being extended and improved.

- ▲ Optimised production processes reduce process costs and ensure that our products are of the very highest quality, as well as being environmentally friendly.
- ▲ Independently tested and certified products.

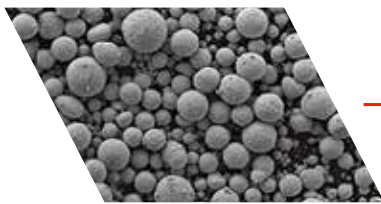

Preparing and mixing the powder



Shaping / Pressing



Sintering



Grinding



Coating



Dispatch



Recycling



Well thought-out logistics processes, a global sales network and flexible, high production capacities guarantee rapid and reliable delivery of your product solutions

Optimum availability

The majority of our standard products are available from stock. Our well organised warehouse guarantees that your order will be processed quickly and reliably, even if it is for large quantities. Thanks to our modern supply chain management, our production capacities are flexible. We are

therefore able to manufacture very large quantities in a very short period of time.

You can order products that are in stock from our online e-techstore, 24 hours a day.



e-techstore.com
Available for you
24 hours a day



The benefits for you:

- ▲ Live check on product availability
- ▲ Comprehensive technical details and graphical representations
- ▲ Rapid delivery: For orders placed before 6.30 pm, the goods are dispatched from our warehouse in Kempten, Germany on the same day
- ▲ Adherence to deadlines: We work exclusively with the best and most reliable transport service providers in the industry

CERATIZIT Services

Online service

Of course, we are also here for you online – 24 hours a day! On the CERATIZIT website, you will not only find all the details on our innovative products, but can also order these products straight away. Within the various product ranges, you have access to over 80 product details pages from the fields of machining, rods & moulded parts, wear protection and wood & stone working. Discover product videos, application examples and success stories.

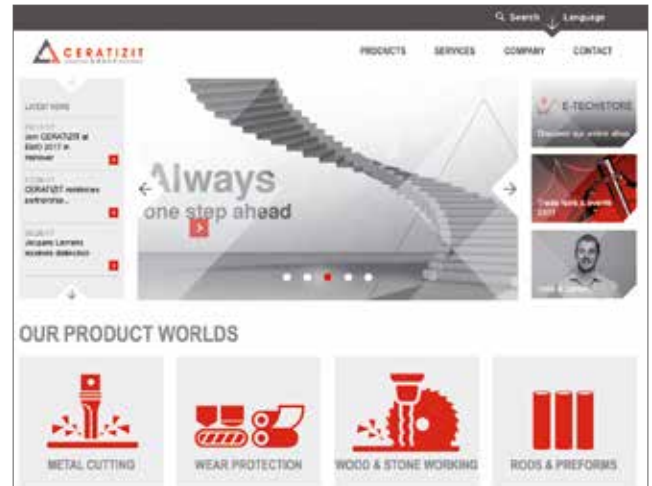

Connection to your system

Would you like to connect your ERP system to our shop, for example? No problem! Please do not hesitate to contact our e-commerce team. Our IT supports all common connection formats (EDI, XML, OCI, etc.). Just get in touch! Working

together with you, our engineers will analyse the prerequisites and advise you on selecting the correct technology.

Restore service

Re-grinding service for standard, semi-standard and special tools. Place your trust in the world-renowned, consistently high product quality and reliable service of Cutting Solutions by CERATIZIT. This also includes re-grinding of solid carbide

tools. Naturally, the prices for our restore service are also transparent and calculated fairly.

Configure

Your tailor-made tool. Using the Configure online solution, a tailor-made semi-standard tool can be configured with just a few clicks of the mouse. With the new Configure tool, we offer you a quick and easy ordering process for solid carbide tools adapted to individual customer's requirements. In our e-techstore, you can create your tailor-made semi-standard tool with just a few clicks of the mouse – 24 hours a day, seven days a week!



Tooling Academy

In addition, familiarise yourself with how the tools will work in your applications, right down to the details – on machines like those in use in all production facilities today. To enable this, we have set up test and training centres with cutting-edge machines and the very latest analysis technology in our Tooling Academy.

Working together with you, we investigate the workability of the materials and tools. Based on the findings from simulations and practical tests, we then draw up specific tool recommendations or develop specific tool solutions for you.



Complete range Cutting tools



Download from
www.ceratizit.com

Brake disc machining

Advantage through innovation and higher productivity

A significant amount of grey cast iron is still used in brake disc production in the car and commercial vehicle sector. However, despite supposedly being easy to work with, the material has its challenges: in particular, the extremely fine, abrasive chip flow is a real test for clamping devices. At cutting speeds in excess of 1,000 m/min and with feeds of over 0.5 mm, normal steel clamping fingers do not hold much longer than a single cutting edge.

Compared to steel precision casting claws, which are not equipped to withstand the high stresses involved in turning cast iron with ceramic and CBN cutting materials, the CERATIZIT carbide claw has undergone further development and provides a significantly increased tool life. We also offer appropriate cutting material and tool solutions for the other operations that make up brake disc machining, including machining the thermal groove or drilling and milling the brake calliper.

C-clamp 2.0 – the most wear-resistant claw on the market

The increased cutting speeds when turning grey cast iron with ceramic and CBN cutting inserts result in higher temperatures and chip flow speeds. This places the clamping system under an enormous amount of stress. Our C-clamp full-carbide claw is able to withstand these stresses and has proven its worth over many years – it is the most wear-resistant clamping solution on the market.

Machining brake discs in large-scale production makes particularly high demands of tool life and process security. In consultation with our customers, we have developed our successful clamping claw still further, into C-clamp 2.0. Its innovative design permits an increased tightening torque and offers even greater process security with easier handling. Combined with first-class CERATIZIT cutting materials ranging from carbide, cermet and ceramics through to full-CBN solutions (CTCK110, CTEP110, CTN / CTI3105, CTBK103), it enables a significant increase in productivity, with up to 40%-higher cutting speeds and feed rates.

C-clamp 2.0 – highlights

- ▲ M8 – Hexagon head screw with collar in 10.9 quality
- ▲ Tried-and-tested wedge clamping > NO chip deposits!
- ▲ Larger contact surfaces
- ▲ 20% higher tightening torque

20 Nm

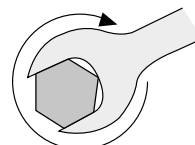

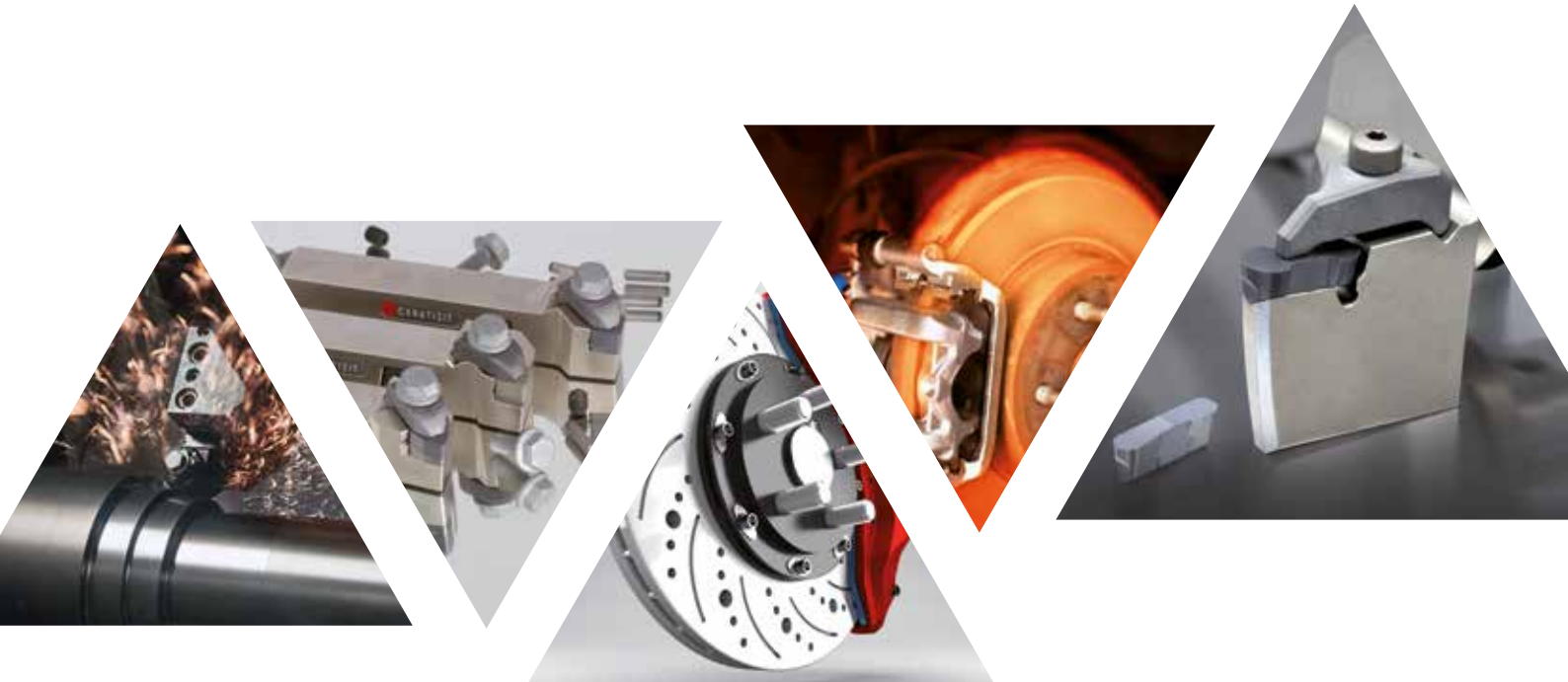

CX24 – ceramic grooving with CBN values

Creating the thermal groove on the brake disc is an important machining step and calls for an extremely stable tool. Based on customer requirements for a stable, process-secure solution, a full-carbide claw is also used for this grooving operation.

In order to meet the high demands of long-term operation and thereby to minimise the changing time and keep the handling as simple as possible, the CX24 grooving system was developed in collaboration with our customers. Combined with high-performance CERATIZIT cutting materials, this enables stable, extremely precise grooving without vibrations, and with greatly reduced tool wear. The optimised design permits high feed rates. The option of profiling and grooving using just one system means potential savings of up to 85%! The CX24 grooving system helps you to make series production of brake discs more productive.

Unique characteristics

- ▲ Installation at an angle of 4° – cutting force distributed between two components
- ▲ Wedge shape also permits reverse profiling
- ▲ Defined mating surface – absolutely no risk of mix-up
- ▲ 110° prism also enables side profiling



Brake disc or drum

In general, brake discs with internal ventilation are used for the front axle, while the discs for the rear axle do not have this. In smaller cars, due to the lower braking effect and stress for the brake system, a drum version is often designed for the rear axle.

On front discs with a ventilation gap, the machining of the external diameter is the most critical operation. A very rough

belt cutting procedure is used to separate the gate marks and the deployed tool must be able to withstand heavily interrupted cuts (in addition to the interruptions caused by the ventilation geometry)!

The rear axle discs, however, which are supposedly easier to machine, are considerably more inclined to vibrate during finishing.

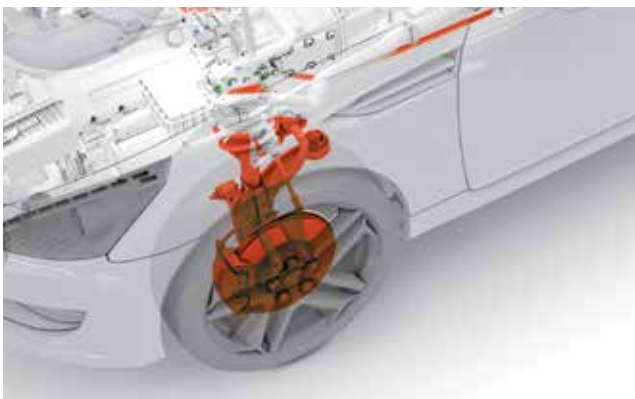
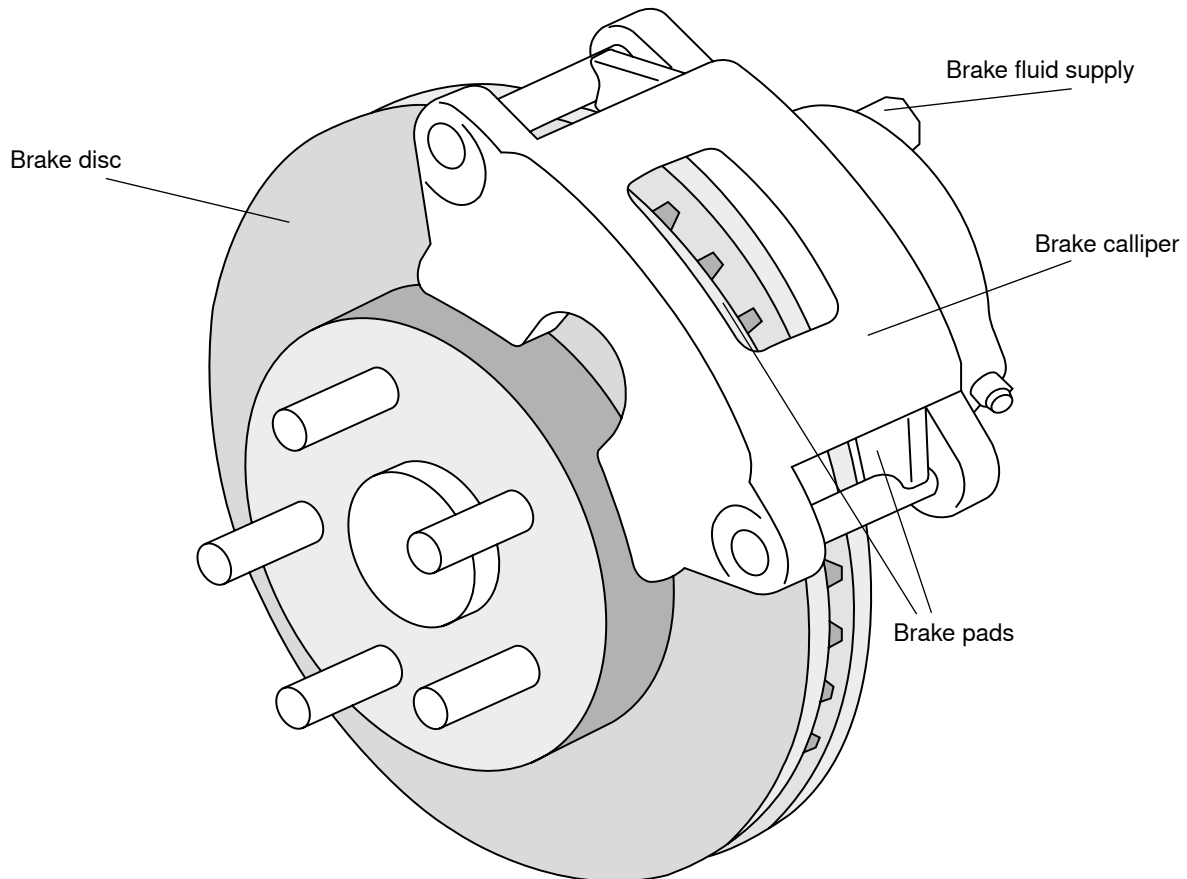

Front axle



Rear axle

Brake calliper

The guide for the brake pads and its attachment to the wheel suspension are produced using only drilling and milling. However, in the case of brake calliper production, multiple model ranges are often drawn together, meaning that greater volumes arise than for the discs themselves.

Our 90° face milling systems, the PCD-equipped HPC cutters and the full-carbide range from CT-Günther Wirth, with its standard drilling and thread cutting solutions, form part of the CERATIZIT standard range and, with the exception of customer-specific insert geometries, can also be supplied directly from stock!

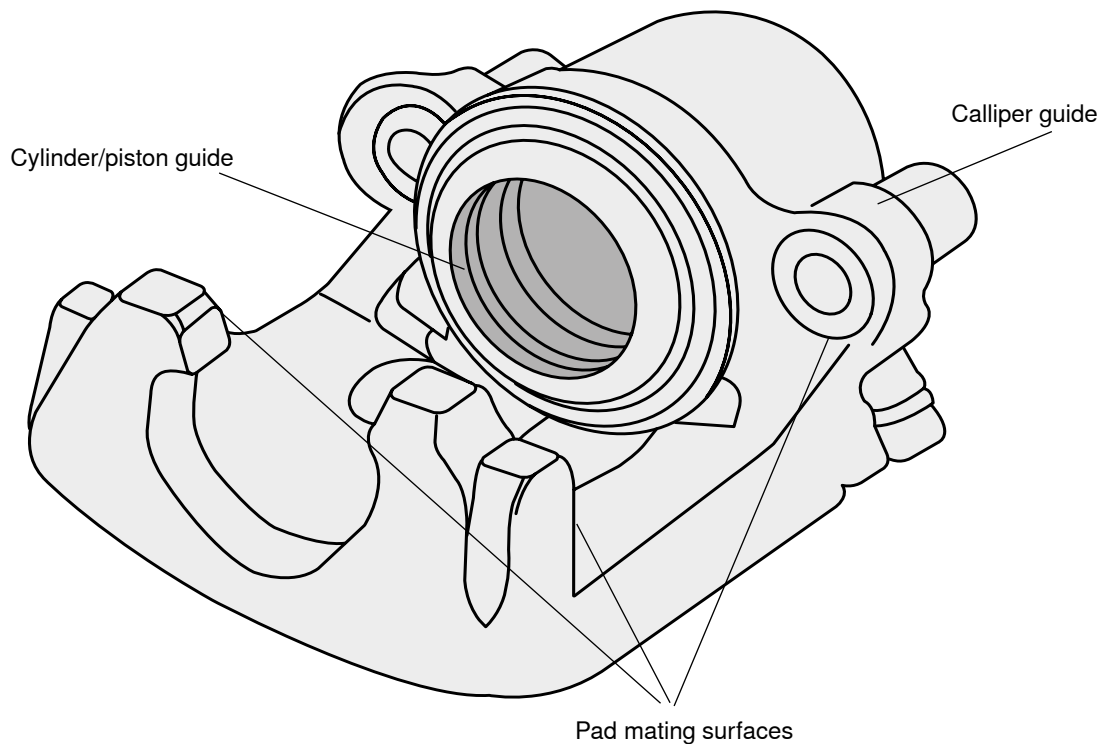

Brake pads

We do not carry out machining work on these components. The pads are manufactured similarly to our indexable inserts, by means of pressing and sintering, and are then soldered onto the metal support inserts.

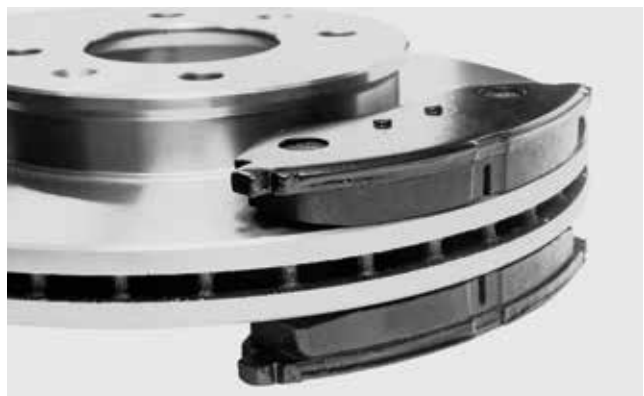

Brake pads

Designation systems for tool holders

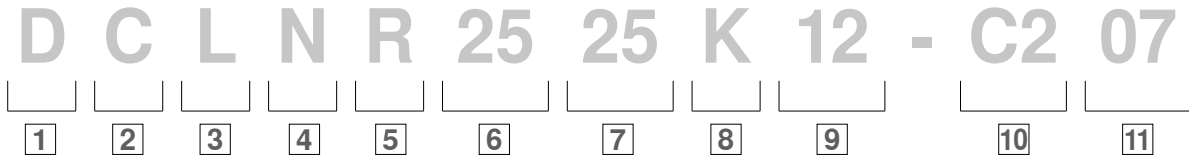

1 Tool holder

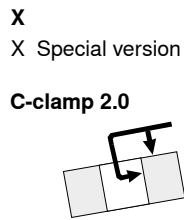
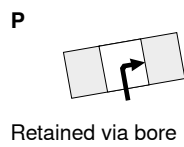
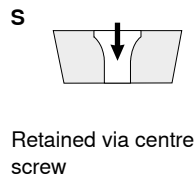
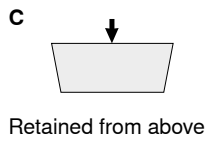
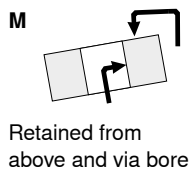
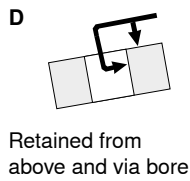

3 Holder shape

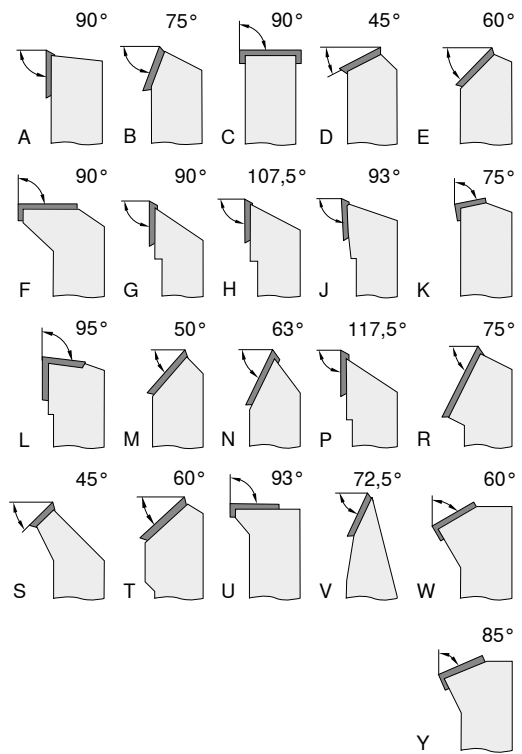

2 Insert shape

Corner angle Rhombus	35°	V		
	55°	D		
	75°	E		
	80°	C		
	86°	M		
Corner angle Rhomboid	55°	K		
	82°	B		
	85°	A		
Other shapes	90°	L	□	- ○ R
	108°	P	◇	90° □ S
	120°	H	⬡	60° △ T
	135°	O	○	80° △ W

4 Clearance angle

3°	A	25°	F
5°	B	30°	G
7°	C	0°	N
15°	D	11°	P
20°	E	*)	O

*) Clearance angles outside the standard, for which special information is required

PSC50 D W L N R - 35 060 12 - C2 07



5 Direction of cut

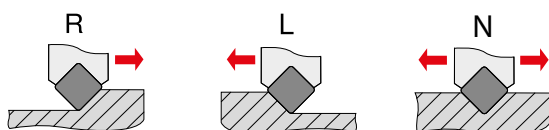

6 Shank height



7 Shank width / F dimension for PSC tools

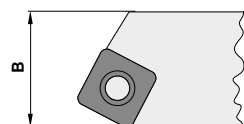

8 Tool length

l ₁ mm		l ₁ mm	
32	A	160	N
40	B	170	P
50	C	180	Q
60	D	200	R
70	E	250	S
80	F	300	T
90	G	350	U
100	H	400	V
110	J	450	W
125	K	500	Y
140	L	Special	X
150	M		

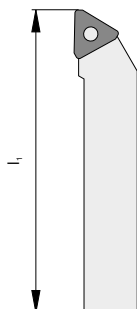

9 Insert size

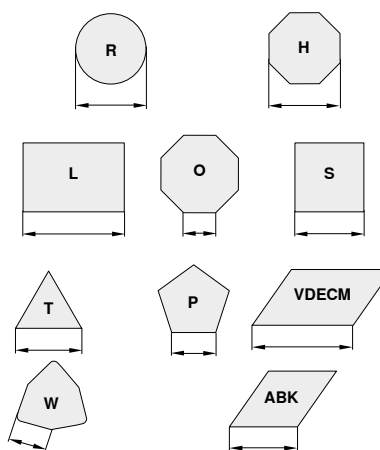

10 Manufacturer's specifications

- T = Knee lever
- Special length (mm)
- Insert thickness (deviating from standard)
- Special version (X..)
- Machine manufacturer (specific)

C2 = C-clamp 2.0

11 Insert thickness

- ..07 = Supports clamping of ceramic inserts with 07' thickness. Supports clamping of CBN indexable inserts with 04' thickness
- ..04 = only supports clamping of inserts with 04' thickness

0 Adapter system

PSC50 = Polygon shank taper Ø 50 mm

Designation systems for boring bars

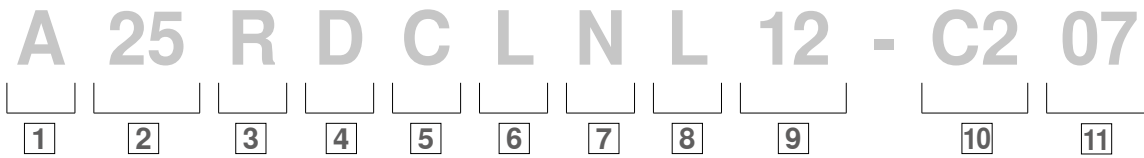

1 Shank type

- | | |
|---|--|
| S Steel shank | E As C with coolant hole |
| A Steel shank with coolant hole | F As C with antivibration system |
| B Steel shank with antivibration system | G As C with coolant hole and antivibration system |
| D Steel shank with coolant hole and antivibration system | H Heavy metal |
| C Carbide shank with steel head | J Heavy metal with coolant hole |

3 Tool length

l_1 mm		l_1 mm	
80	F	350	U
100	H	400	V
110	J	450	W
125	K	500	Y
140	L	Special	X
150	M		
160	N		
170	P		
180	Q		
200	R		
250	S		
300	T		

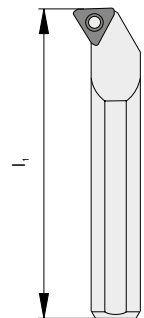

2 Shank diameter

- d_1 mm
- 08
 - 10
 - 12
 - 16
 - 20
 - 25
 - 32
 - 40
 - 50
 - 60

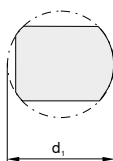

4 Clamping

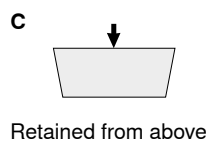
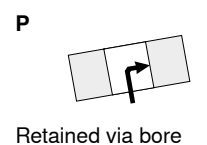
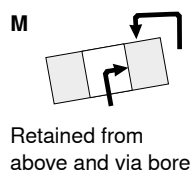
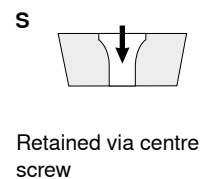
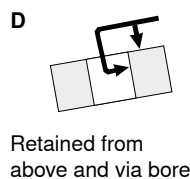

X
X Special version

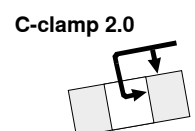

5 Insert shape

Corner angle Rhombus		35°	V	
		55°	D	
		75°	E	
		80°	C	
		86°	M	
Corner angle Rhomboid		55°	K	
		82°	B	
		85°	A	
		90°	L	
		108°	P	
		90°	□	R
		120°	⬡	S
		60°	△	T
		80°	◊	W

6 Holder shape

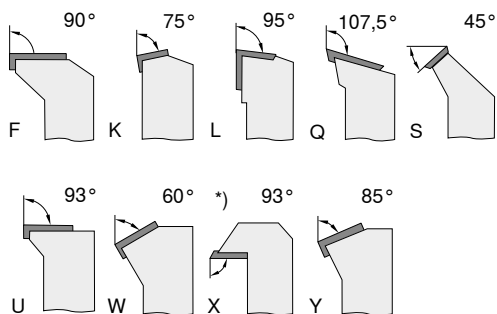

*) CERATIZIT factory standard

7 Clearance angle

3°	A	25°	F
5°	B	30°	G
7°	C	0°	N
15°	D	11°	P
20°	E	*)	O

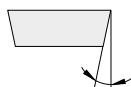

*) Clearance angles outside the standard, for which special information is required

8 Direction of cut

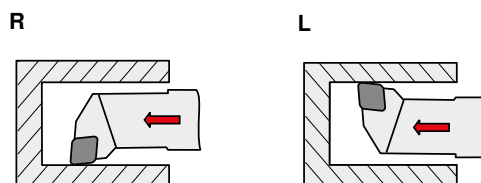

9 Cutting length

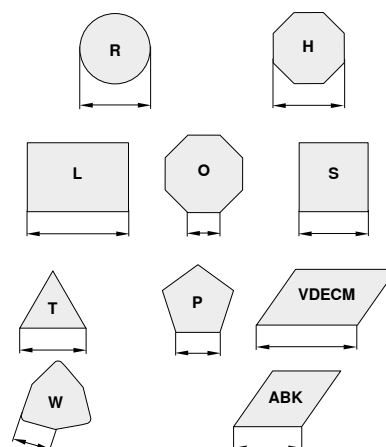

10 Manufacturer's specifications

- T = Knee lever
- Special length (mm)
- Insert thickness (deviating from standard)
- Special version (X..)
- Machine manufacturer (specific)

C2 = C-clamp 2.0

11 Insert thickness

- ..07 = Supports clamping of ceramic inserts with 07' thickness. Supports clamping of CBN indexable inserts with 04' thickness
- ..04 = only supports clamping of inserts with 04' thickness

Designation systems for indexable inserts

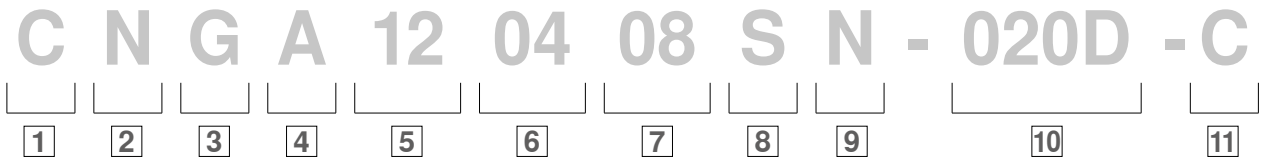

1 Insert shape

Rhombus	35°	V
	55°	D
	75°	E
	80°	C
	86°	M
Rhomboid	55°	K
	82°	B
	85°	A
	90°	L
Other shapes	108°	P
	120°	H
	135°	O
	-	R
	90°	S
	60°	T
	80°	W

2 Clearance angle

3°	A	25°	F
5°	B	30°	G
7°	C	0°	N
15°	D	11°	P
20°	E)*	O

)* Clearance angles outside the standard, for which special information is required

3 Tolerances

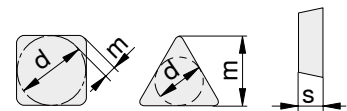

	d ± [mm]	m ± [mm]	s ± [mm]
A	0.025	0.005	0.025
F	0.013	0.005	0.025
C	0.025	0.013	0.025
H	0.013	0.013	0.025
E	0.025	0.025	0.025
G	0.025	0.025	0.13
J	0.05-0.15*	0.005	0.025
K	0.05-0.15*	0.013	0.025
L	0.05-0.15*	0.025	0.025
M	0.05-0.15*	0.05-0.20	0.13
N	0.05-0.15*	0.05-0.20	0.025
U	0.08-0.25*	0.13-0.38	0.13

6 Insert thickness

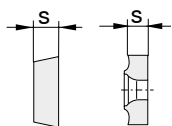

[mm]	Key figure
1.59	01
2.38	02
3.18	03
3.97	T3
4.76	04
5.56	05
6.35	06
7.94	07
9.52	09

7 Corner radius

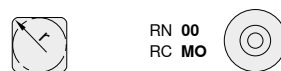

[mm]	Key figure
≤ 0.05	00
0.1	01
0.2	02
0.4	04
0.8	08
1.2	12
1.6	16
2.0	20
2.4	24
2.8	28
3.2	32

8 Cutting edge

F	sharp
E	rounded
T	chamfered
S	chamfered and rounded
K	double-chamfered
P	double-chamfered and rounded

9 Direction of cut

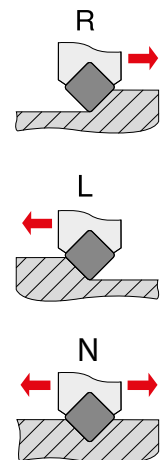

4 Characteristic

N		
R		
F		
A		
M, P		
G, P		
W		
T		
Q		
U		
B		
H		
C		
J		
X	Special version	

5 Cutting length

Type	ISO	ANSI	L [mm]	d [mm]
C	06	2	6.4	6.35
	09	3	9.7	9.525
	12	4	12.9	12.70
	16	5	16.1	15.875
	19	6	19.3	19.05
	25	8	25.8	25.4
S	06	2	6.35	6.35
	09	3	9.525	9.525
	12	4	12.7	12.7
	15	5	15.875	15.875
	19	6	19.05	19.05
	25	8	25.4	25.4
31	10	31.75	31.75	

Type	ISO	ANSI	L [mm]	d [mm]
T	06	1.2	6.9	3.97
	09	1.8	9.6	5.56
	11	2	11.0	6.35
	16	3	16.5	9.525
	22	4	22.0	12.70
	27	5	27.5	15.875
33	6	33.0	19.05	
W	06	3	6.5	9.525
	08	4	8.7	12.70
	10	5	10.9	15.875
R	12*	4	12.7	12.70
	15	5	15.875	15.875

—*) inch version

10 Chamfer design

T / S	K / P ¹⁾
[mm]	
015 0.15	A 05°
020 0.20	B 10°
025 0.25	C 15°
050 0.50	D 20°
075 0.75	E 25°
100 1.00	F 30°

1) Two letters are assigned for double-chamfered cutting

e.g.

BE = Chamfer angle 1 = 10°
Chamfer angle 2 = 25°

11 Number of cuts

single sided	total thickness
A	T
B	U
C	V
D	W
G	X
H	Y
double sided	whole rake face
K	S
L	F
M	E
N	
P	
Q	

Example 10, 11 / C-clamp system:

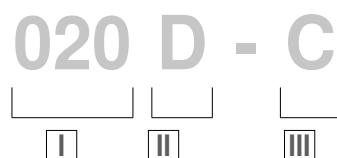

- I Chamfer width $b = 0.20 \text{ mm}$
- II Chamfer angle $D = 20^\circ$
- III C-clamp system

Code for angle Y

	Chamfer width	A 0.20	5°
		B 0.20	10°
		C 0.20	15°
	Chamfer angle	D 0.20	20°
		E 0.20	25°
		F 0.20	30°

Designation systems for ceramic grooving systems

Designation of indexable inserts

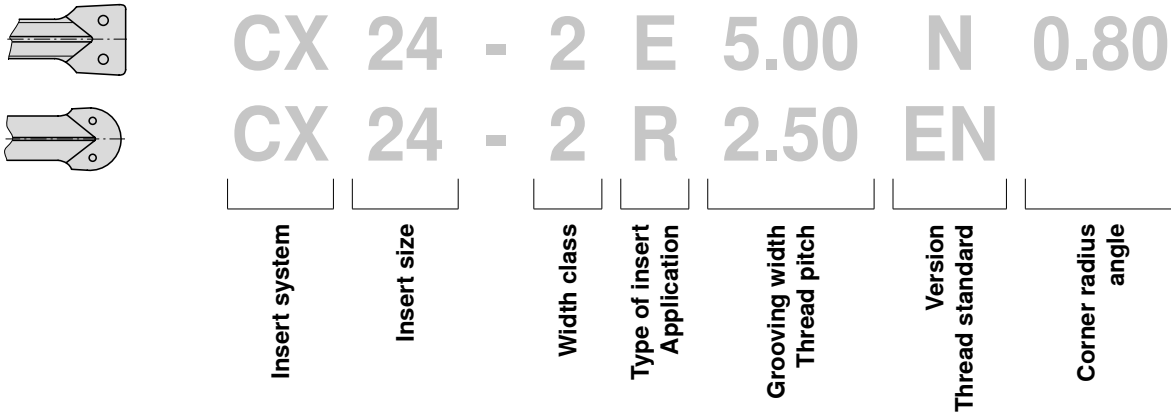

Designation of holder

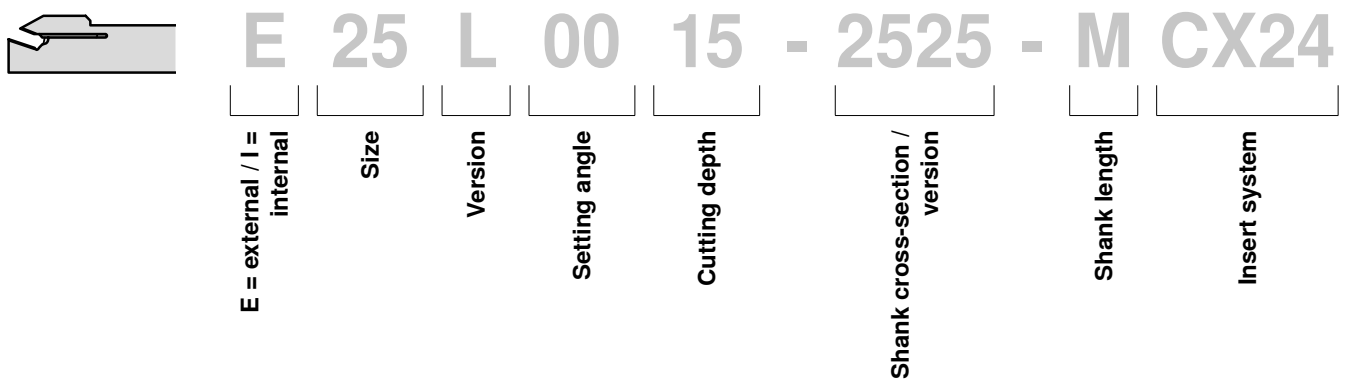

Axial grooving and face turning

Diameter range

D_{min} [mm]		D_{max} [mm]
130	-	180
130	-	190
140	-	200
140	-	240

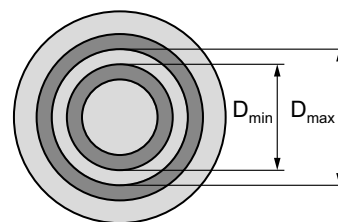

Important: The specified diameters refer to the groove diameter in accordance with the sketch, as grooving inserts of different widths can be used.

! Only applicable to start diameter

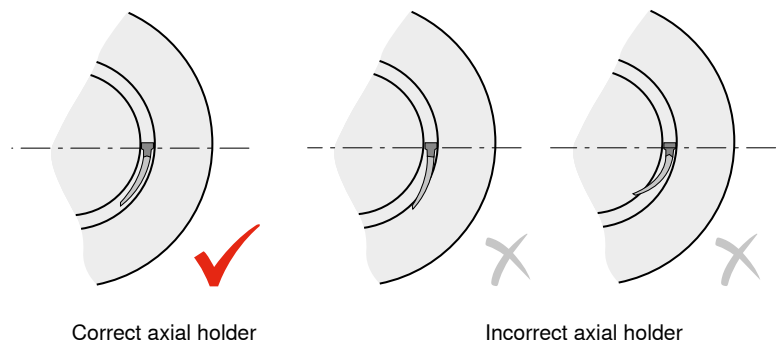

Designation systems for grades

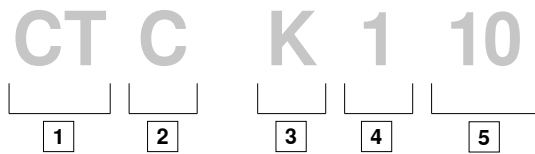

1 Manufacturer: CERATIZIT

2 Cutting material type

- W Carbide uncoated
- ⇒ [C Carbide CVD-coated
- [P Carbide PVD-coated
- T Cermet uncoated
- E Cermet coated
- ⇒ [N Silicon nitride uncoated
- [M Silicon nitride coated
- S Composite ceramic
- K Whisker ceramic
- I Sialon
- D PCD
- ⇒ [B PCBN
- [L PCBN coated
- H PM-HSS

3 Primary suitability for material Option 1: Number

- ⇒ [1 Steel
- 2 Stainless steel
- ⇒ [3 Cast Iron
- 4 Alloys and non-ferrous metals/non-metals
- 5 Super alloys/titanium
- 6 Hard materials
- ⇒ [7 Multi-use grade without particular material focus

3 Primary suitability for material Option 2: ISO letter

- ⇒ [P Steel
- M Stainless steel
- ⇒ [K Cast iron
- N Alloys and non-ferrous metals/non-metals
- S Super alloys/titanium
- H Hard materials
- ⇒ [X Multi-use grade without particular material focus

4 Primary suitability for application

- ⇒ [1 Turning
- [2 Milling
- [3 Grooving
- 4 Drilling
- 5 Thread turning
- 6 Other
- 7 Multi-use grade without particular application focus

5 ISO 513 application range

- e.g.
- [01
 - 05
 - ⇒ [10
 - [15
 - 25
 - 35 ISO P35
 - .
 - .



**Only supposedly easy!
Machining cast iron makes
high demands of cutting
materials and tools**

Material - cast iron

It is predominantly cast iron materials that are used in the manufacture of brake discs. The term "cast iron" refers to a group of iron alloys containing carbon and silicon, as well as other elements such as manganese, chromium and nickel. The various cast iron materials differ considerably in elongation/ductility and tensile strength/hardness. Their machinability varies just as widely.

In particular, grey cast iron is the most important material in brake disc production, alongside spheroidal graphite cast iron or vermicular cast iron. The following chapter provides further information on the properties of the most important materials, their hardness and tensile strength, and which cutting materials are most suitable for each application.

Material designation system

Abbreviated names for materials have up to six designation options without spaces, starting with EN (1 – European standard) and GJ (2 – cast iron). The other parameters indicate the graphite structure (3), the micro or macro-structure (4) and the mechanical properties or chemical composition (5).

The final option within the designation (6) describes additional characteristics and requirements. Material numbers have seven designation options, to which the material identifier is added.

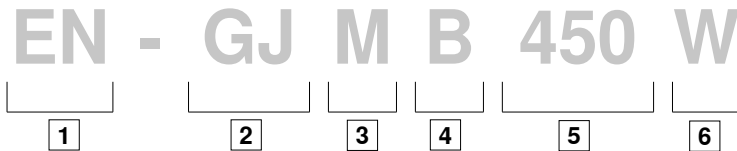

1 EN = European standard

2 GJ = Cast iron

3 Graphite structure

L = Lamellar graphite
 S = Spheroidal graphite
 M = Temper carbon
 V = Vermicular graphite
 N = Graphite-free
 Y = Special structure

4 Micro or macro-structure

A = Austenite
 F = Ferrite
 P = Pearlite
 M = Martensite
 L = Ledeburite
 Q = Quenched
 T = Tempered
 B = Annealed without decarburisation
 W = Annealed with decarburisation

5 Mechanical properties or chemical composition

MECHANICAL PROPERTIES

350 = Minimum tensile strength R_m in N/mm²
 350-22 = Additional elongation at break A in %
 S = Sample cast separately
 U = Sample cast on
 C = Sample taken from the casting
 HB155 = max. hardness

CHEMICAL PROPERTIES

Information in line with the steel designations

6 Additional requirements

D = Rough casting
 H = Heat-treated casting
 W = Suitable for welding
 Z = Additional requirements

Cast iron with vermicular graphite (EN-GJV...)

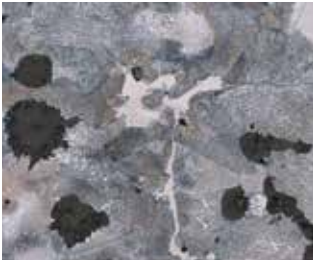

Tensile strength	Hardness	Elongation at break	Yield strength
300 – 575 N/mm ²	HB 170 – 400	0.5 – 5%	R _{p 0.2} = 210 – 400 N/mm ²

Machinability:

EN-GJV-300 – good, comparable to GGG-40, EN-GJV-450 – difficult, approx. –30% to GGG-40
EN-GJV-500 – poor, approx. –45% to GGG-40

Classification:

EN-GJV-300	EN-GJV-450
EN-GJV-350	EN-GJV-500
EN-GJV-400	

Aluminium and other weight-reducing materials

The most critical weight reductions in vehicles are the unsprung masses. Consequently, automotive manufacturers are investing a great deal in developing new composite solutions to make mass-produced products such as brake discs, and brake callipers lighter.

Here the manufacturers are placing their bets on composite brake discs. In addition to the aluminium version (pot) with cast iron (friction ring), solutions using carbon friction rings originate from motorsport and other high-end areas.

Thanks to the extensive development work we have carried out over the past three decades, we are able to offer our comprehensive standard range for aluminium machining. Here you will find a broad spectrum of geometries, chip breakers and cutting material variants.

However, the latest state-of-the-art technology consists of deep-drawn steel pots that are inserted into the friction ring using a type of tooth profile. This machining technique is equivalent to hobbing and is known as "scudding" in the technical jargon.



© Ronal Group

Relative machinability – comparison of materials

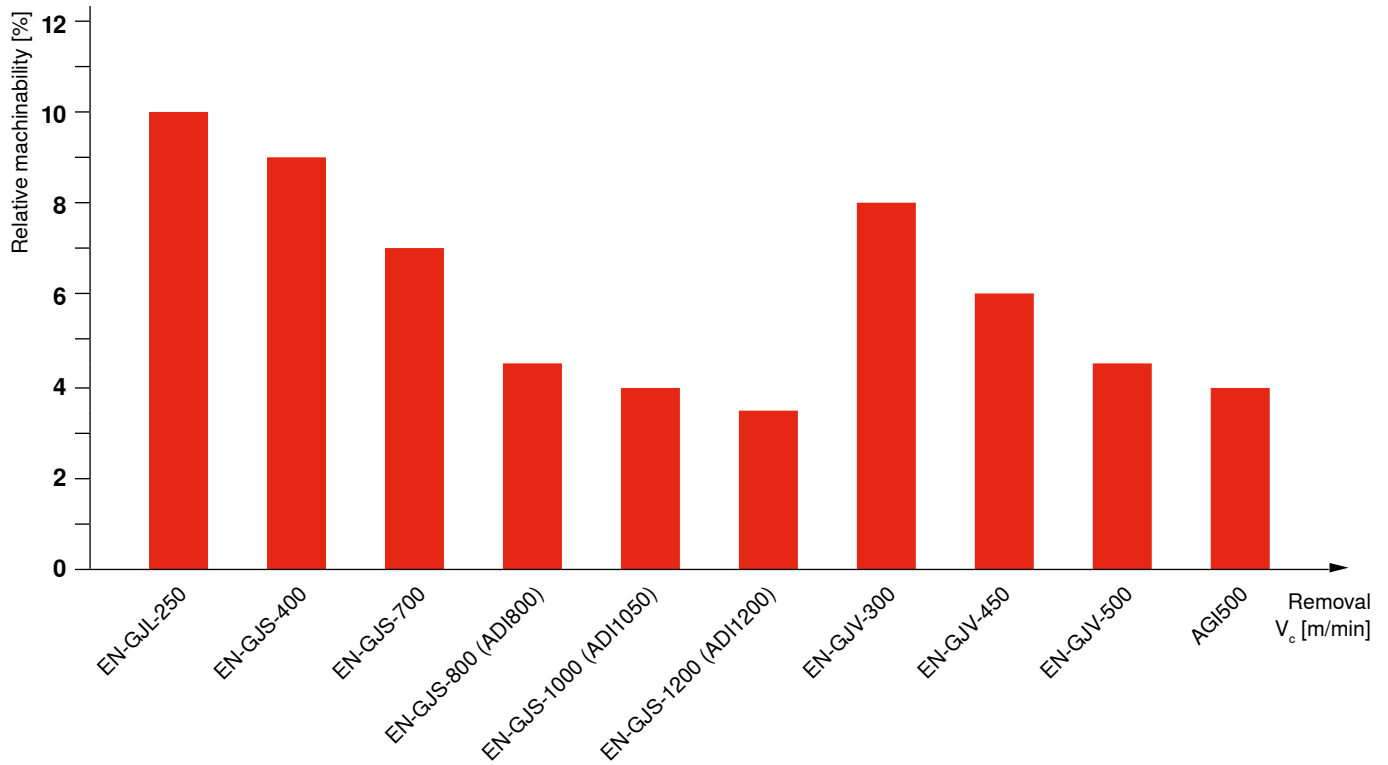

Source: User manual A1 – P. Zobl



Hardness values comparison table

Tensile strength N/mm	Vickers HV	Brinell HB	Rockwell HRC	Shore C	Tensile strength N/mm	Vickers HV	Brinell HB	Rockwell HRC	Shore C
575	180	171			1845	560	532	53	63
595	185	176			1880	570	542	53.6	64
610	190	181			1920	580	551	54.1	65
625	195	185			1955	590	561	54.7	66
640	200	190	12		1995	600	570	55.2	67
660	205	195	13		2030	610	580	55.7	68
675	210	199	14		2070	620	589	56.3	69
690	215	204	15		2105	630	599	56.8	70
705	220	209	15	28	2145	640	608	57.3	71
720	225	214	16		2180	650	618	57.8	72
740	230	219	17	29	2210	660	628	58.3	73
755	235	223	18		2240	665	633	58.8	74
770	240	228	20.3	30	2280	670	638	59.3	
785	245	233	21.3		2310	675	643	59.8	75
800	250	238	22.2	31	2350	680	648	60.3	76
820	255	242	23.1	32	2380	685	653	61.1	77
835	260	247	24	33	2410	690	658	61.3	78
850	265	252	24.8		2450	695	663	61.7	79
865	270	257	25.6		2480	710	668	62.2	80
880	275	261	26.4	34	2520	720	678	62.6	81
900	280	268	27.1		2550	730	683	63.1	82
915	285	271	27.8	35	2590	740	693	63.5	
930	290	276	28.5		2630	750	703	63.9	83
950	295	280	29.2	36	2660	760	708	64.3	84
965	300	285	29.8	37	2700	770	718	64.7	85
995	310	295	31	38	2730	780	723	65.1	
1030	320	304	32.2	39	2770	790	733	65.5	86
1060	330	314	33.3	40	2800	800	738	65.9	
1095	340	323	34.3	41	2840	810	748	66.3	87
1125	350	333	35.5	42	2870	820	753	66.7	88
1155	360	342	36.6	43	2910	830	763	67	
1190	370	352	37.7	44	2940	840	768	67.4	89
1220	380	361	38.8	45	2980	850		67.7	
1255	390	371	39.8	46	3010	860		68.1	90
1290	400	380	40.8	47	3050	870		68.4	
1320	410	390	41.8	48	3080	880		68.7	91
1350	420	399	42.7		3120	890		69	
1385	430	409	43.6	49	3150	900		69.3	92
1420	440	418	44.5		3190	910		69.6	
1455	450	428	45.3	51	3220	920		69.9	
1485	460	437	46.1	52	3260	930		70.1	
1520	470	447	46.9	53					
1555	480	465	47.7	54					
1595	490	466	48.4						
1630	500	475	49.1	57					
1665	510	485	49.8	58					
1700	520	494	50.5	59					
1740	530	504	51.1	60					
1775	540	513	51.7	61					
1810	550	523	52.3	62					

Conversion values are approximate, based on DIN EN ISO18265 (02-2004)

Machining requirements – machining notes

In brake disc machining, the selection of the optimal cutting material solution is based on not only the material to be machined, but also on other parameters. It is dependent on the number of items to be machined, the machine output used and the component size in question.

Due to the different specifications, it is not possible to make a uniform recommendation. The following image shows the cutting material grades that are suitable for the various application areas.

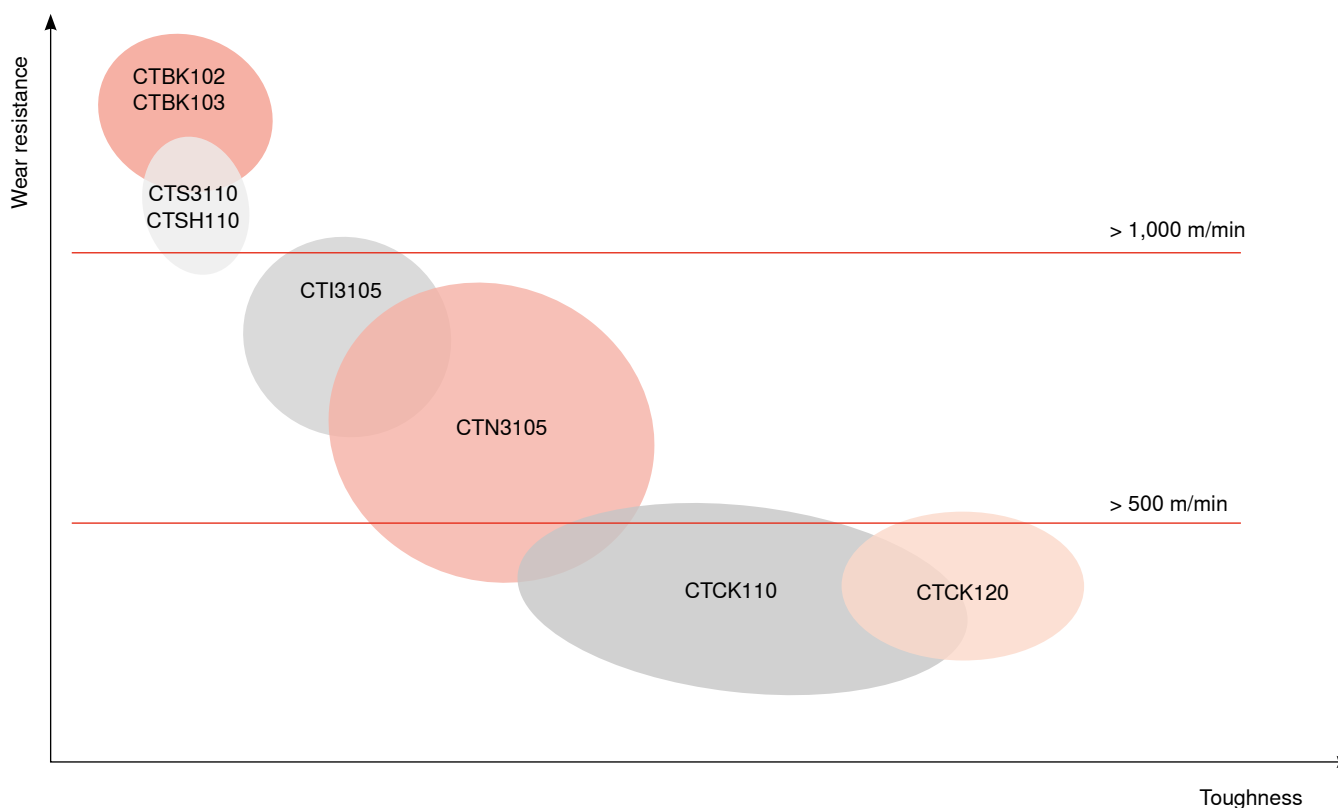

Our range of cutting material grades extends from conventional carbide to ultra-hard cubic boron nitride (CBN) and thereby encompasses all cutting materials that are relevant for turning cast iron materials.

If a high level of toughness is required, as when machining high-alloy cast irons, GJV brake drums or other components with heavily interrupted cuts, cutting speeds of up to 500 m/min are recommended. In this case, the BLACKSTAR™ CTCK110 and BLACKSTAR™ CTCK120 grades are the first choice, particularly in the -M70 or -M50 chip breaker geometries that reduce cutting force.

The universal silicon nitride ceramic grades manage the balancing act between changing material conditions and

economical cutting parameters of up to 1,000 m/min. As ceramic and CBN cutting material solutions are both dependent on a high cutting temperature for optimum results, we recommend switching to the CTI3105 SiAlON ceramic grade, which is significantly harder, for higher quality cast irons.

Composite or whisker ceramic inserts, as well as full-CBN inserts with high printability, are suited to use in the high-end sector with cutting speeds in excess of 1,000 m/min and maximum wear resistance. The cutting forces must be designed accordingly here (compression load rather than tensile load at the cutting edge). In addition, with CBN inserts, the cutting temperature should not fall below 600 °C at the cutting edge – thereby ensuring process-security and tool life.

HV 1900 = higher brittleness = significantly more prone to breakage!

Relative machinability – not an easy comparison

It is particularly in the aging and curing process that the supposedly simple iron-carbon structure of "cast iron" shows its versatility.

All steel and cast iron producers have previously carried out machinability studies on this, but using different approaches in each case, such as considering changes in the structural elements, or changes of physical measured values (hardness, layer thickness of the cast skin). The structural composition also does not display any measurable development that is able to explain, even at a rudimentary level, the reduction of up to 60% in tool life seen when using CBN cutting materials.

Many years of study have led us to conclude that the optimum time to use CBN is after a 4 to 5-day aging period. At this point, the cast iron is in a very consistent material

condition – no change in the power consumption or machining behaviour can be detected either between different batches or from different pallets in a casting series. Cubic boron nitride lives up to its reputation as a high-quality cutting material and its use can reduce unit costs with mechanical machining. To date, it has not been possible to find a scientific explanation for why the effect is reversed again after around 10 days, and a 10–30% reduction in tool life can once again occur (depending on the structure, this may only occur again after 20 days, or not at all). However, all of our experience and tests suggest that, with the further volatilisation of the sulphur / structural formation, the manganese-sulphide layer that is so important can no longer be formed so quickly and thickly, particularly during machining of the peripheral zone, making the CBN more vulnerable to crater wear and therefore allowing the cutting inserts to wear more quickly.

Relative machinability based on the aging time (3 working weeks)

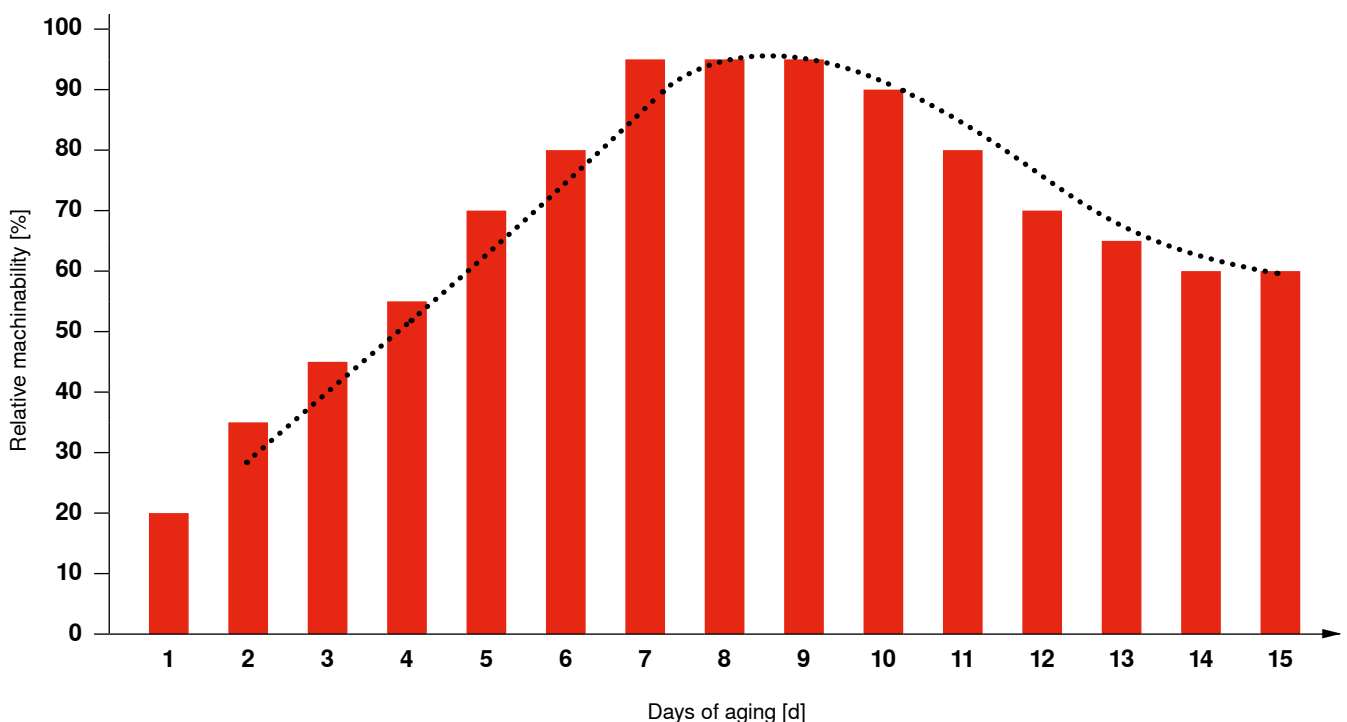

Development of the primary cutting forces

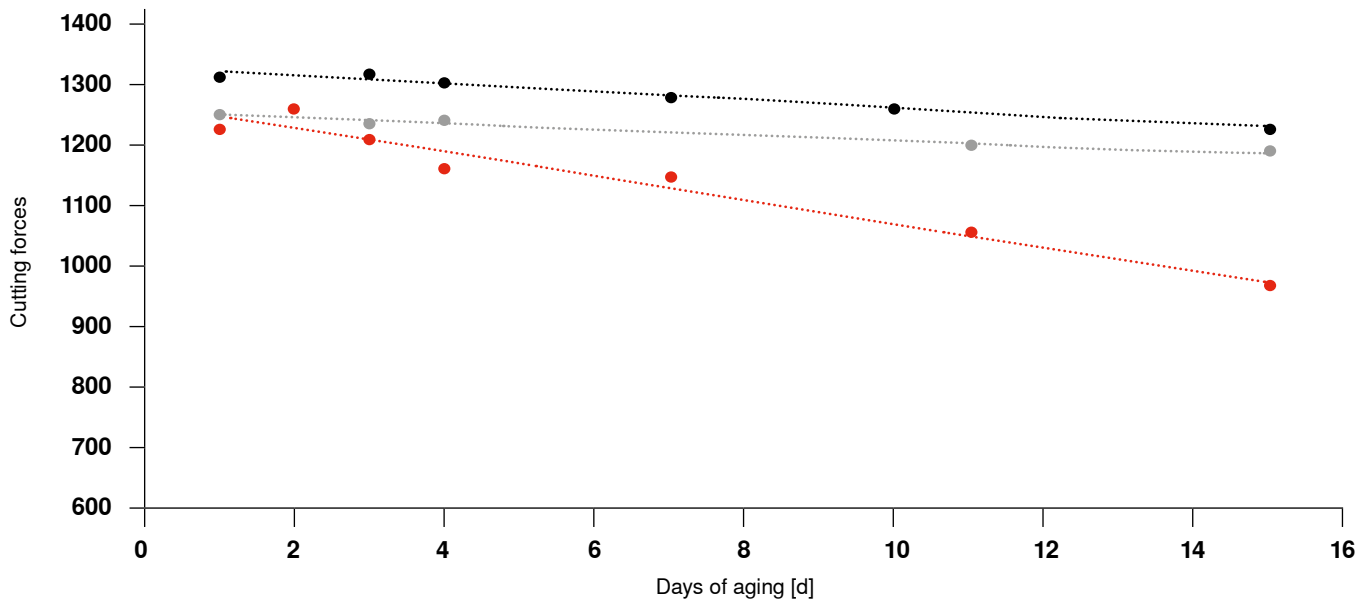

- 1st cut (with cast skin)
- 2nd cut
- 3rd cut

Finish machining – technology advantages for greater quality and productivity

Pulling cuts during finish machining

The use of special indexable inserts made from ceramics and PCBN enables parallel finishing of brake discs. Instead of the conventional cut, this machining strategy relies on a pulling cut on the braking surface. This brings several advantages: Due to the small setting angle, a considerably larger section of the cutting edge can be used. This makes it possible to reduce the machining times of components significantly, while simultaneously obtaining high feeds with outstanding surface quality. In addition, due to the improved use of the cutting edge, the cutting edge wear is distributed over a greater area. The service life and process security can be significantly increased through the use of this cutting technique and high-quality cutting materials (Masterfinish™ effect).

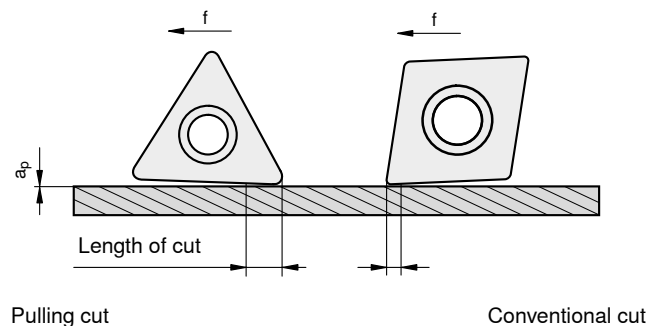

Rear wheel disc – conventional susceptibility to vibrations for brake discs without rear ventilation

Vibrations are particularly likely to occur in the case of thin brake discs with no internal ventilation as, when the braking surface finishing operation begins, the cutting pressure deforms the component. In order to avoid this, we draw on our experience in hard turning and use what is known as the multicut strategy. In this manner, for example, work starts with a feed of 0.35 mm/U on the outer diameter.

After the first 25 mm length of cut, the feed is increased to 0.45 mm/U and the feed is then throttled again both in the direction of the disc centre and at the end of the machining process. (Machining example: rear wheel disc with external diameter of 230 and machining length of approx. 60 mm – feed values based on a special Masterfinish geometry).

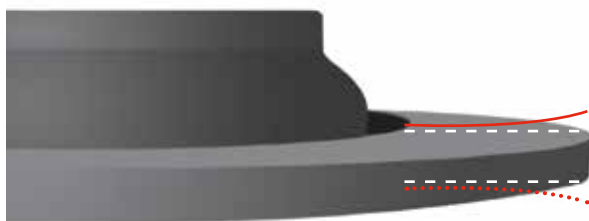

----- Theoretical strength
 Movement of the brake disc during machining

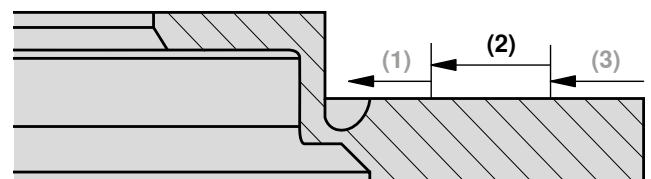

Three zones on the machining length with the various feeds.

Finishing with Cermet:

The generally "neglected application range" of cast iron machining for cermet cutting materials, the majority of which focus more on steel machining, brings particular finishing advantages on young castings, especially when using our CVD-coated indexable inserts (use with emulsion is also possible). The use of chip breakers and the extremely

smooth surface of the polished edge layer, combined with positive clearance angles, means that the cutting forces and consequently their influence on component deformation can be so greatly reduced that components which are particularly susceptible to vibrations achieve the narrow tolerances with regard to vibrations more easily.

Masterfinish: special wiper geometry technology

Functional principle / Benefits

Improved surface quality

Given identical feed rates, the indexable insert with Masterfinish attains a R_a value that is many times better than a conventional indexable insert.

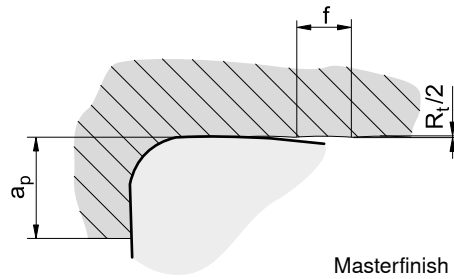
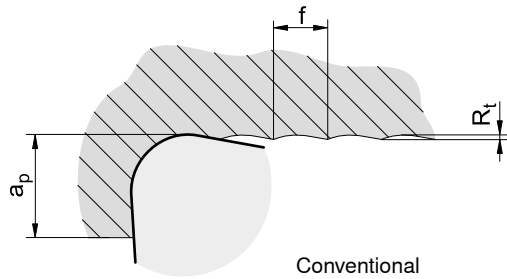

Shorter machining time

If the same R_a value is to be attained as with a standard indexable insert, it is possible to run at twice the feed rate

using the indexable insert with Masterfinish (= lower times per piece!).

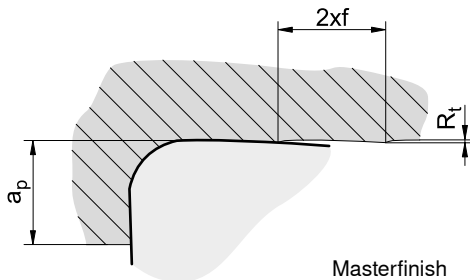
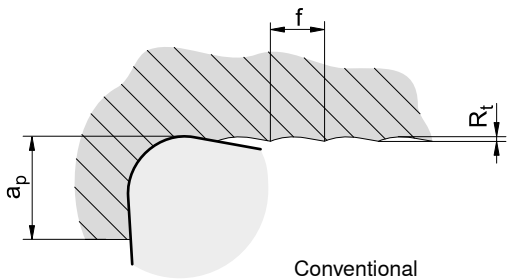

LT	15	MM
RA	5.63	UM
RZ	24.76	UM
RMAX	26.24	UM
RPM	14.68	UM
VER	25	MM
HOR	LC 2.5	MM

Indexable insert:
WNMG 080408EN-M70

 v_c : 200 m/min
 a_p : 1.0 mm
 f : 0.4 mm/U

LT	15	MM
RA	1.02	UM
RZ	6.16	UM
RMAX	7.36	UM
RPM	3.80	UM
VER	25	MM
HOR	LC 2.5	MM

Indexable insert:
WNMG 080408EN-TFQ

 v_c : 200 m/min
 a_p : 1.0 mm
 f : 0.4 mm/U

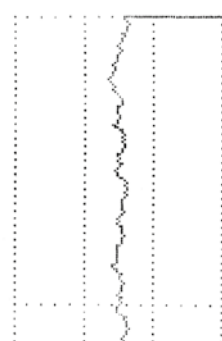
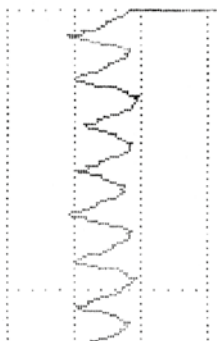

Optimisation of surface through:

- ▲ Using a larger corner radius
- ▲ Masterfinish

- ▲ Reducing feed rate
- ▲ Two-cut strategy



**Maximum retention force,
almost no wear: process-secure
brake disc turning with the
optimised C-clamp 2.0**

High-performance turning with ceramics & CBN

The service lives and volumes required in the series production of brake discs pose major challenges for cutting materials and clamping systems. Our first-class solutions guarantee process-secure turning of grey cast iron and other cast iron materials. For cutting speeds between 500 and 1,000 m/min, the universal CERATIZIT ceramic indexable inserts are the first choice. Our ultra-hard cutting materials made from composite ceramic and whisker ceramic, along with full-CBN inserts, cover the high-end sector with cutting speeds in excess of 1,000 m/min.

During high-performance turning of grey cast iron, high temperatures and chip removal speeds are generated, placing the clamping system, in particular, under excessive stress. Steel claws are only able to withstand these stresses for a short time. Consequently, CERATIZIT developed a carbide claw that can withstand even the most demanding usage for clamping the wear-resistant ceramic and CBN indexable inserts. This product has been successfully in use for many years, and in consultation with our customers we have now further optimised the C-clamp: the clamping situation and contact area have been improved and guarantee a stable insert position with optimum retention force, even under extreme stresses. C-clamp 2.0 is the most wear-resistant claw on the market and makes a significant contribution towards increasing productivity in brake disc machining.

Grades overview

Grade designation	Standard designation		Cutting material type	Application range												P	M	K	N	S	H	
	ISO	ANSI		01	05	10	15	20	25	30	35	40	45	50								
CBN																						
CTBK102	BH-K10	C3	B													●						
	BH-H25	C2	B														●					
CTBK103	BH-K10	C3	B													●						
	BH-H25	C2	B														●					
CTBK104	BH-K10	C3	B													●						
	BH-H25	C2	B														●					
Mixed ceramic																						
CTS3105	CM-K05	C4	S													●						
	CM-H05	C4	S															●				
CTSH110	CM-H10	C3	S															●				
	CM-K10	C3	S													●						
Ceramic																						
CTN3105	CN-K05	C4	N													●						
CTI3105	CN-K05	C3	I													●						
	CN-S05	-	I																			○

● Main application
○ Extended application

Grade description

CTBK102

CBN

BH-K10 | BH-H25

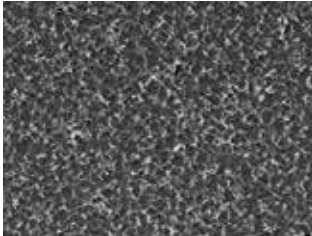

Specifications:

Composition: Cubic boron nitride (CBN) | 90 vol.% + metallic binder phase

Recommended use:

The first choice for cast iron machining with full CBN.

CTBK103

CBN

BH-K10 | BH-H25

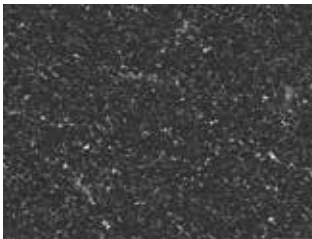

Specifications:

Composition: Cubic boron nitride (CBN) | 90 vol.% + metallic binder phase

Recommended use:

First choice for cast iron and sintered steels when finishing.

CTBK104

CBN

BH-K10 | BH-H25

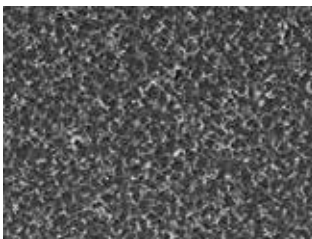

Specifications:

Composition: Cubic boron nitride (CBN) | 90 vol.% + metallic binder phase

Recommended use:

The first choice for cast iron machining with full CBN.

CTS3105

Mixed ceramic

CM-K05 | CM-H05



Specifications:

Composition: Al_2O_3 ; TiC | Grain size: $> 1 \mu m$ | Hardness: $HV_{30} 2100$

Recommended use:

This mixed ceramic grade is suitable for hard precision turning of steel and for turning steel and cast iron or chilled iron rolls.

CTSH110

Mixed ceramic

CM-H10 | CM-K10

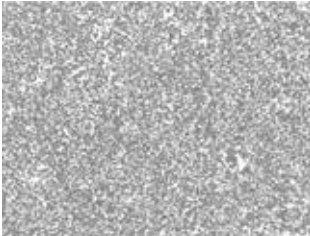
**Specifications:**Composition: Al_2O_3 ; TiCN | Hardness: HV₃₀ 2150**Recommended use:**

Mixed ceramic grade with very high cutting edge stability for machining of hardened materials. Suitable for slightly interrupted cuts.

CTN3105

Ceramic

CN-K05

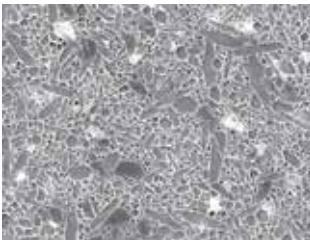
**Specifications:**Composition: $\beta - Si_3N_4$ | Grain size: fine | Hardness: HV₁₀ 1620**Recommended use:**

Universal silicon nitride grade for cast iron machining.

CTI3105

Ceramic

CN-K05 | CN-S05

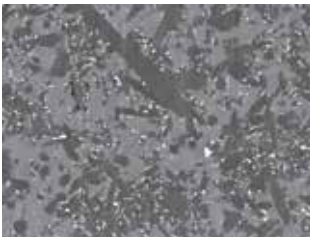
**Specifications:**Composition: $\alpha, \beta - Sialon$ | Hardness: HV₁₀ 1900**Recommended use:**

The hardest sialon on the market – high-performance grade for machining of cast iron and Ni-based alloys.



C-clamp 2.0

Clamping situation



- ▲ Carbide clamping elements, almost no noticeable wear
- ▲ Optimised anti-rotation lock
- ▲ High tightening torque using M8 screw

Contact area



- ▲ Claw fully covers the hollow in the insert
- ▲ Large contact area in the clamping zone between the claw/indexable insert hollow
- ▲ No wear in the area of the clamping zone

The C-clamp 2.0 principle

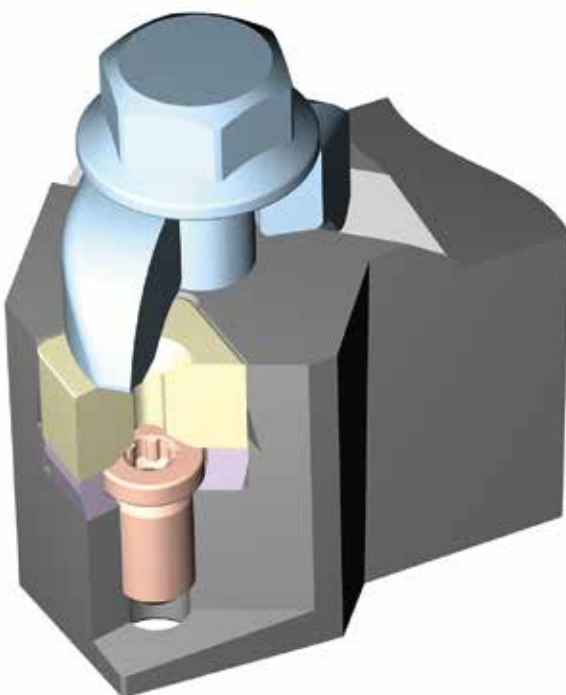

- ▲ The structural design and a tightening torque of 20 Nm guarantee maximum retention force
- ▲ Stable indexable insert position throughout the entire duration of use, even under extreme stresses

- Clamping element
- Indexable insert
- Insert seat
- Screw

Advantages and benefits of the optimised clamping system

At a glance

Advantages

M8 hexagon head screw

Tried-and-tested wedge clamping method

Solid carbide claw

Larger contact area

Higher tightening torque 20 Nm

Benefits

- ▲ No contamination of inner profile
- ▲ Protective surface treatment
- ▲ No weakening of the core diameter

- ▲ No deposits in the claw groove
- ▲ Impossible for the claw to jam
- ▲ Many years of system experience in the standard

- ▲ No eroding of the steel finger over the armouring
- ▲ No screw breakage

- ▲ Low setting behaviour
- ▲ Increased surface pressure
- ▲ Optimised positioning for change of cutting direction

- ▲ 20% more clamping force



C-clamp assembly instructions

1. TOOL – DELIVERY CONDITION WITH PRE-ASSEMBLY



The series-production tools are supplied as standard, as previously, with pre-assembled insert seat (1), pressed-in centring pin (2) and the grub screw (3).



We can also deliver without pre-assembly in response to customer requests.

2. SCREWING IN INSERT SEAT



Place the insert seat into the mount and tighten it using the appropriate screws (M6 x 13 / T20IP).



Check the insert mount again for contamination before installation – if there is any contamination present, we recommend blowing out the thread and seat using compressed air!



Here you see a double holder with insert seat fitted.

3) SCREWING IN GRUB SCREW



The sealed threaded holes can clearly be seen here!

In order to prevent contamination in the thread of the clamping screw, the new C-clamp system uses a grub screw which is screwed into a separate threaded section from below.

4) ATTACHING THE CLAMPING CLAW



The clamping claw can now be fitted with the clamping screw and installed.



Tilting claw for inserting the indexable insert.



Thanks to the option of tilting and sliding off the new claw, this remains free and can be raised for installation of the indexable insert.

5) CLAMPING THE INDEXABLE INSERT



The last and most important step in the assembly process is clamping the indexable insert.

Place the cutting insert into the seat as usual and press it against the mating surfaces. The new C-clamp 2.0 then completes the final positioning and holding down process itself.

6) CLAMPING WITH 20 NM TORQUE



Finally, the indexable insert is clamped again using a defined torque.

Due to the significantly stronger M8 hexagon head screw and the more even support area, it has been possible to increase this torque to 20 Nm!

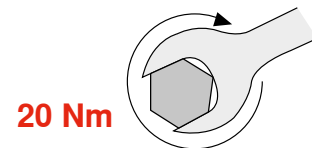

7) READY FOR TAKE-OFF

The tool is now equipped with the new C-clamp 2.0 system and ready for tomorrow's requirements!



CNGX-C / CNNX-C

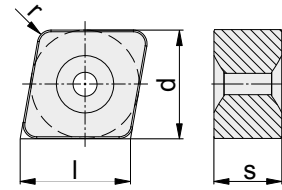

CNX-C



	CTBK103 CTN3105 CTI3105	d [mm]	l [mm]	s [mm]	r [mm]
CNGX 120412TN-020D-C	●	12.70	12.90	4.76	1.20
CNGX 120416TN-020D-C	●	12.70	12.90	4.76	1.60
CNGX 120712TN-020D-C	● ●	12.70	12.90	7.94	1.20
CNNX 120712TN-020D-C	●	12.70	12.90	7.94	1.20
CNGX 120716TN-020D-C	● ●	12.70	12.90	7.94	1.60
CNNX 120716TN-020D-C	● ●	12.70	12.90	7.94	1.60

● Main application
○ Extended application

DNGX-C

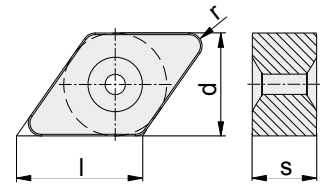

DNGX-C



	CTBK103 CTN3105 CTI3105	d [mm]	l [mm]	s [mm]	r [mm]
DNGX 120416TN-020D-C	●	10.00	12.30	4.76	1.60
DNGX 120716TN-020D-C	●	10.00	12.30	7.94	1.60
DNGX 150712TN-020D-C	●	12.70	15.50	7.94	1.20
DNGX 150716TN-020D-C	● ●	12.70	15.50	7.94	1.60

● Main application
○ Extended application

SNGX-C / SNNX-C

SN.X-C



P			
M			
K	●	●	●
N	●	●	●
S			○
H	●	●	
	CTBK102	CTBK103	CTN3105
			CTI3105

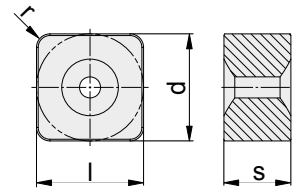

			d [mm]	l [mm]	s [mm]	r [mm]
	SNGX 120412TN-020D-C	● ●	12.70	12.70	4.76	1.20
	SNGX 120416TN-020D-C	● ●	12.70	12.70	4.76	1.60
	SNGX 120712TN-020D-C	● ●	12.70	12.70	7.94	1.20
	SNGX 120716TN-020D-C	● ●	12.70	12.70	7.94	1.60
	SNNX 120716TN-020D-C	● ●	12.70	12.70	7.94	1.60

● Main application
○ Extended application

WNGX-C / WNNX-C

WN.X-C



P			
M			
K	●	●	●
N	●	●	●
S			○
H	●	●	
	CTBK102	CTBK103	CTN3105
			CTI3105

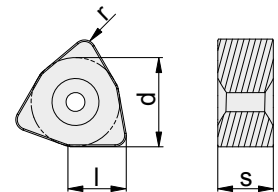

			d [mm]	l [mm]	s [mm]	r [mm]
	WNGX 080408TN-020D-C	●	12.70	8.69	4.76	0.80
	WNGX 080416TN-020D-C	● ●	12.70	8.69	4.76	1.60
	WNGX 080712TN-020D-C	● ●	12.70	8.69	7.94	1.20
	WNGX 080716TN-020D-C	● ●	12.70	8.69	7.94	1.60
	WNNX 080716TN-020D-C	●	12.70	8.69	7.94	1.60

● Main application
○ Extended application

RNGX-C

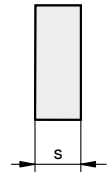
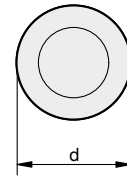

RNGX-C





		CTBK102	CTBK103	d [mm]	s [mm]
	RNGX 120400TN-020D-C	●	●	12.70	4.76

- Main application
- Extended application

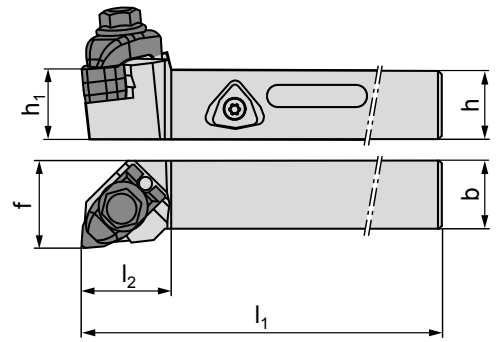
DWLN..



h [mm]	Type, Designation	LNR 	h ₁ [mm]	b [mm]	l ₁ [mm]	l ₂ [mm]	f [mm]		
25	DWLN L 2525 M08-C207	L	25	25	150	32	32	WN.X 08..	E01
25	DWLN R 2525 M08-C207	R	25	25	150	32	32	WN.X 08..	E01



E01



11819787



11897356







11844339

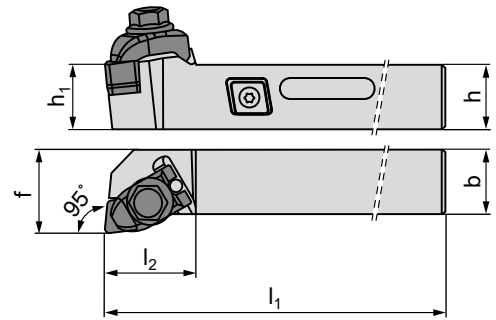

11864168 / 11877173

DCLN..



h [mm]	Type, Designation	LNR 	h ₁ [mm]	b [mm]	l ₁ [mm]	l ₂ [mm]	f [mm]		
25	DCLNL 2525 M12-C207	L	25	25	150	35	32	CN.X 12..	E01
25	DCLNR 2525 M12-C207	R	25	25	150	35	32	CN.X 12..	E01



E01



11819787



11897356







11844339

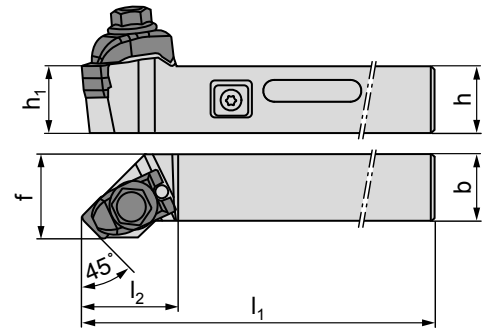

11844332 / 11844333

DSSN..



h [mm]	Type, Designation	LNR 	h ₁ [mm]	b [mm]	l ₁ [mm]	l ₂ [mm]	f [mm]		
25	DSSNL 2525 M12-C207	L	25	25	150	35	32	SN.X 12..	E01
25	DSSNR 2525 M12-C207	R	25	25	150	35	32	SN.X 12..	E01



E01



11819787



11897356







11844339

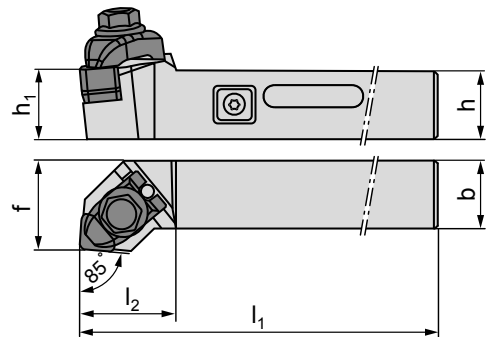

11844328 / 11844329

DSXN..



h [mm]	Type, Designation	LNR 	h ₁ [mm]	b [mm]	l ₁ [mm]	l ₂ [mm]	f [mm]		
25	DSXNL 2525 M12-C207	L	25	25	150	35	32	SN.X 12..	E01
25	DSXNR 2525 M12-C207	R	25	25	150	35	32	SN.X 12..	E01



E01



11819787



11897356



11844339



11844328 / 11844329

DSYN..

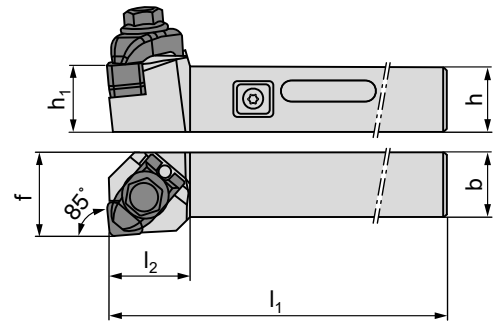

h [mm]	Type, Designation	LNR 	h ₁ [mm]	b [mm]	l ₁ [mm]	l ₂ [mm]	f [mm]		
25	DSYNL 2525 M12-C207	L	25	25	150	36	32	SN.X 12..	E01
25	DSYNR 2525 M12-C207	R	25	25	150	36	32	SN.X 12..	E01



E01



11819787



11897356





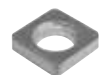

11844339

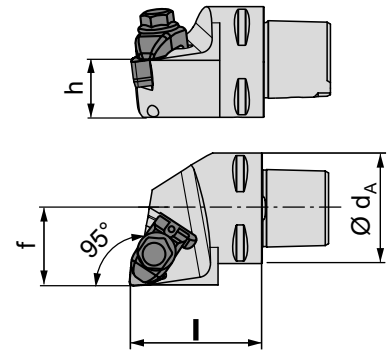

11844328 / 11844329

PSC50-DWLN..



h [mm]	Type, Designation	LNR 	d_a [mm]	l [mm]	f [mm]		
25	PSC50-DWLN L 35060 08-C207	L	50	60	35	WN.X 08..	E01
25	PSC50-DWLN R 35060 08-C207	R	50	60	35	WN.X 08..	E01



E01



11819787



11897356







11844339

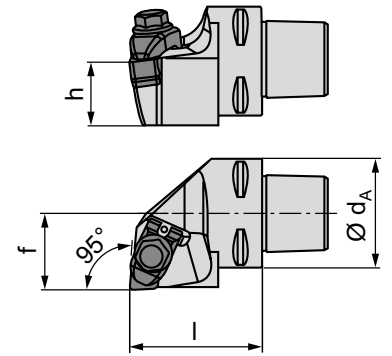

11864168 / 11877173

PSC50-DCLN..



h [mm]	Type, Designation	LNR 	d _a [mm]	l [mm]	f [mm]		
28,50	PSC50-DCLNL 35060 12-C207	L	50	60	35	CN.X 12..	E01
28,50	PSC50-DCLNR 35060 12-C207	R	50	60	35	CN.X 12..	E01



E01



11819787



11897356







11844339

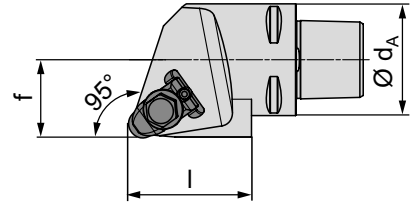
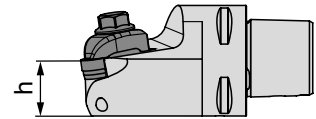

11844332 / 11844333

PSC50-DRGN..



h [mm]	Type, Designation	LNR 	d _a [mm]	l [mm]	f [mm]		
25	PSC50-DRGNL 35075 12-C204	L	50	75	35	RNGX 12..	E01
25	PSC50-DRGNR 35075 12-C204	R	50	75	35	RNGX 12..	E01



E01



11819787



11897356







11844339

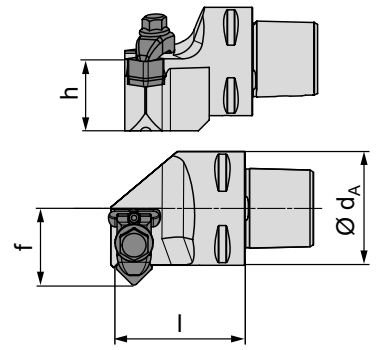

11933596

PSC50-DSSN..



h [mm]	Type, Designation	LNR 	d _a [mm]	l [mm]	f [mm]		
32	PSC50-DSSNN 35060 12-C207	N	50	60	35	SN.X 12..	E01



E01



11819787



11897356





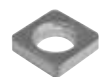

11844339

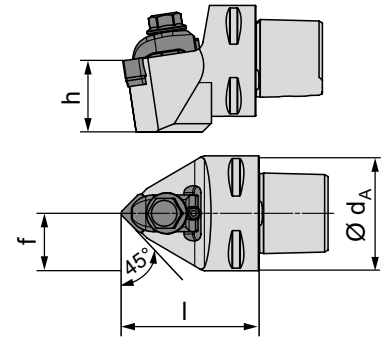

11844328 / 11844329

PSC50-DSDN..



h [mm]	Type, Designation	LNR 	d _a [mm]	l [mm]	f [mm]		
32,5	PSC50-DSDNN 00060 12-C207	N	50	60	35	SN.X 12..	E01



E01



11819787



11897356



11844339







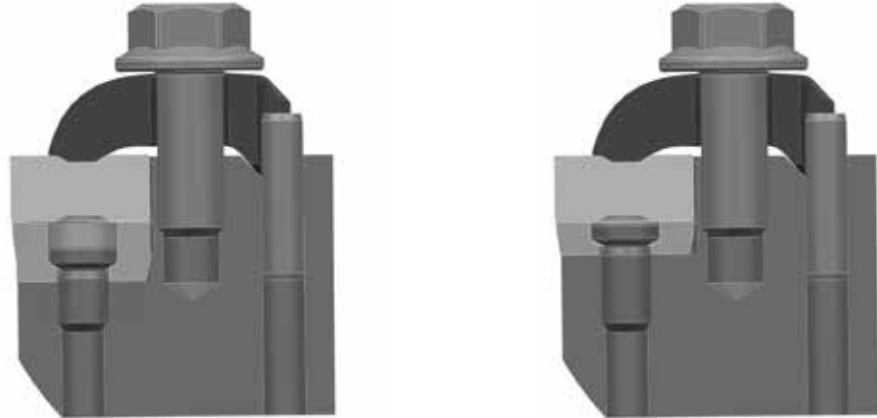

11844328 / 11844329

Spare parts



Insert seats



Shape	-T3	-X7
	U-SN12T316-C M6	U-SN12X716-C M6
	U-CN12T316-C M6	U-CN12X716-C M6
	U-WN08T316-C M6	U-WN08X716-C M6
	U-DN12T316-C M6 U-DN15T316-C M6	U-DN12X716-C M6 U-DN15X716-C M6
	U-TN16T316-C M6	U-TN16X716-C M6
	U-RN12T300-C M6	U-RN12X700-C M6



CNGX / CNNX for ISO holders

			CTN3105		d [mm]	l [mm]	s [mm]	r [mm]
			CTN3105	CTI3105				
			●		12.70	12.90	7.94	0.80
			●	●	12.70	12.90	7.94	1.20
			●	●	12.70	12.90	7.94	1.60
			●	●	12.70	12.90	7.94	1.60
			●	●	15.88	16.10	7.94	1.60

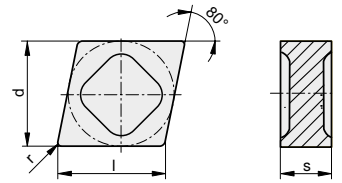

● Main application
○ Extended application

DNGX for ISO holders

			CTN3105		d [mm]	l [mm]	s [mm]	r [mm]
			CTN3105	CTI3105				
			●		10.00	12.30	7.94	1.20
			●		12.70	15.50	7.94	1.20
			●		12.70	15.50	7.94	1.60

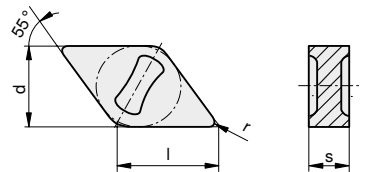

● Main application
○ Extended application

SNGX / SNNX for ISO holders

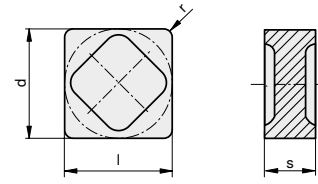

S.N.X

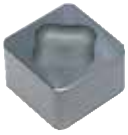

	CTN3105	CTI3105	d [mm]	l [mm]	s [mm]	r [mm]
SNGX 120712TN-020D	●	●	12.70	12.70	7.94	1.20
SNGX 120716TN-020D	●	●	12.70	12.70	7.94	1.60
SNNX 120716TN-020D	●	●	12.70	12.70	7.94	1.60
SNGX 150716TN-020D	●	●	15.88	15.88	7.94	1.60
SNGX 150716TN-040D	●		15.88	15.88	7.94	1.60

● Main application
○ Extended application



**Wear-resistant, stable and tough:
The Maxilock D tool holder
equipped with cutting inserts
made from coated carbide**

Safe turning with carbide grades

The coated BLACKSTAR™ carbide cutting materials from CERATIZIT are universal, durable and cover a wide range of applications for turning cast iron materials. In brake disc machining, they are used whenever

high toughness and maximum cutting speeds of 500 m/min are called for, such as when machining high-alloy cast irons. Here, the CTCK110 cutting material grade is recommended for continuous cuts under stable conditions. The CTCK120 grade is the first choice for unstable, difficult conditions. It ensures stable processes, even during roughing and finishing of components with heavily interrupted cuts, such as HGV brake drums. In brake disc machining, the wear-resistant centre-hole inserts have become particularly well established in combination with the Maxilock D tool holder. The tool holder's double clamping action, robust clamping claw and optimised insert seat enable exact positioning of the indexable insert and provide a high level of process security, even under tensile load.

The combination of secure clamping and a suitable cutting insert made from the appropriate cutting material for the application opens up huge savings potential in roughing and finishing, as well as in the machining of alloy castings.

Grades overview

Grade designation	Standard designation		Cutting material type	Application range											P	M	K	N	S	H				
	ISO	ANSI		01	05	10	15	20	25	30	35	40	45	50										
Coated carbide																								
CTCK110	HC-K10	C3	C																	●				
	HC-P05	C8	C																		○			
CTCK120	HC-K20	C2	C																	●				
	HC-P10	C8	C																	○				
CTEP110	HC-P10	C8	E																	●				
	HC-K05	C4	E																	○				

● Main application
○ Extended application

Grade description

CTCK110

Coated carbide

HC-K10 | HC-P05

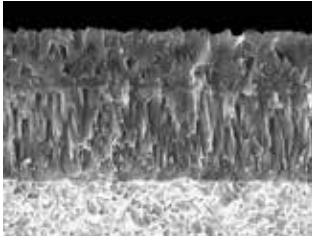

Specifications:

Composition: Co 5.0%; mixed carbide 2.0%; WC balance | Grain size: submicron |
Hardness: HV₃₀ 1810 | Layer system: CVD TiCN-Al₂O₃

Recommended use:

The most wear-resistant grade for working on cast iron materials with high cutting speeds in a continuous cut.

CTCK120

Coated carbide

HC-K20 | HC-P10

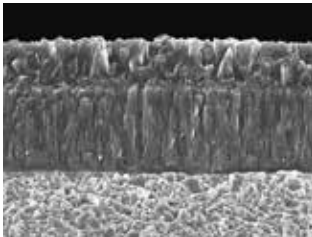

Specifications:

Composition: Co 6.0%, TaC 2.0%, WC balance | Grain size: 1 μm | Hardness: HV₃₀ 1630 |
Layer system: CVD TiCN-Al₂O₃

Recommended use:

The grade for cast iron machining, with high toughness reserves for difficult conditions and interrupted cuts.

CSTEP110

Colorstar

HC-P10 | HC-K05

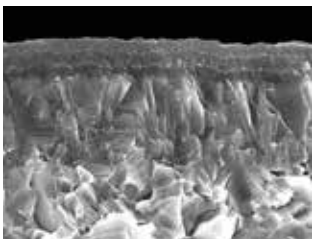

Specifications:

Composition: Co/Ni 12.2%; TC 15.0%; TaNbC 10.0%; TiCN balance | Grain size: fine |
Hardness: HV₃₀ 1620 | Layer system: CVD TiCN-Al₂O₃ Multilayer

Recommended use:

The cermet grade with reserves of toughness for finishing at high cutting speeds.

CCGT.. / CCMT.. / CNMA.. / CNMG..



CTCK110
CTCK120
CTEP110

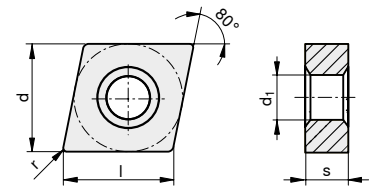

				d [mm]	l [mm]	s [mm]	r [mm]	d ₁ [mm]
-CF05		CCGT 060202EN-CF05	●	6.35	6.40	2.38	0.20	2.80
		CCGT 060204EN-CF05	●	6.35	6.40	2.38	0.40	2.80
		CCGT 09T302EN-CF05	●	9.52	9.70	3.97	0.20	4.40
		CCGT 09T304EN-CF05	●	9.52	9.70	3.97	0.40	4.40
		CCGT 09T308EN-CF05	●	9.52	9.70	3.97	0.80	4.40
-CF20		CNMG 120404EN-CF20	●	12.70	12.90	4.76	0.40	5.16
		CNMG 120408EN-CF20	●	12.70	12.90	4.76	0.80	5.16
-CF55		CCMT 060204EN-CF55	●	6.35	6.40	2.38	0.40	2.80
		CCMT 09T304EN-CF55	●	9.52	9.70	3.97	0.40	4.40
		CCMT 09T308EN-CF55	●	9.52	9.70	3.97	0.80	4.40
		CCMT 120404EN-CF55	●	12.70	12.90	4.76	0.40	5.50
-SM		CCMT 060204EN-SM	●●	6.35	6.40	2.38	0.40	2.80
		CCMT 060208EN-SM	●●	6.35	6.40	2.38	0.80	2.80
		CCMT 09T304EN-SM	●●	9.52	9.70	3.97	0.40	4.40
		CCMT 09T308EN-SM	●●	9.52	9.70	3.97	0.80	4.40
		CCMT 09T312EN-SM	●	9.52	9.70	3.97	1.20	4.40
		CCMT 120404EN-SM	●●	12.70	12.90	4.76	0.40	5.50
		CCMT 120408EN-SM	●●	12.70	12.90	4.76	0.80	5.50
-CNMA		CNMA 120408EN	●●	12.70	12.90	4.76	0.80	5.16
		CNMA 120412EN	●●	12.70	12.90	4.76	1.20	5.16
		CNMA 120416EN	●	12.70	12.90	4.76	1.60	5.16
		CNMA 160608EN	●●	15.88	16.10	6.35	0.80	6.35
		CNMA 160612EN	●●	15.88	16.10	6.35	1.20	6.35
		CNMA 160616EN	●●	15.88	16.10	6.35	1.60	6.35
		CNMA 190612EN	●●	19.05	19.30	6.35	1.20	7.94
		CNMA 190616EN	●●	19.05	19.30	6.35	1.60	7.94

● Main application
○ Extended application

CCGT.. / CCMT.. / CNMA.. / CNMG..

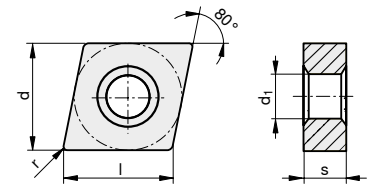

		CTCK110	CTCK120	CTEP110	d [mm]	l [mm]	s [mm]	r [mm]	d ₁ [mm]
-TFQ				●	12.70	12.90	4.76	0.40	5.16
				●	12.70	12.90	4.76	0.80	5.16
				●	12.70	12.90	4.76	1.20	5.16
-TM				●	9.52	9.70	3.81	0.80	3.81
-M50			● ●		12.70	12.90	4.76	0.80	5.16
			● ●		12.70	12.90	4.76	1.20	5.16
-M70			● ●		12.70	12.90	4.76	0.80	5.16
			● ●		12.70	12.90	4.76	1.20	5.16
			● ●		12.70	12.90	4.76	1.60	5.16
			● ●		15.88	16.10	6.35	0.80	6.35
			● ●		15.88	16.10	6.35	1.20	6.35
			● ●		15.88	16.10	6.35	1.60	6.35
			● ●		19.05	19.30	6.35	1.20	7.94
			● ●		19.05	19.30	6.35	1.60	7.94

● Main application
○ Extended application

DCGT.. / DCMT.. / DNMA.. / DNMG..

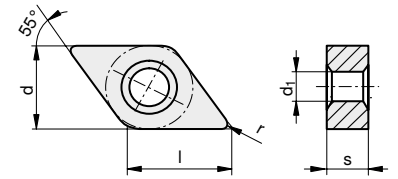

		CTCK110	CTCK120	CTEP110	d [mm]	l [mm]	s [mm]	r [mm]	d ₁ [mm]
-CF05		DCGT 070202EN-CF05	●		6.35	7.75	2.38	0.20	2.80
		DCGT 070204EN-CF05		●	6.35	7.75	2.38	0.40	2.80
		DCGT 11T302EN-CF05		●	9.52	11.60	3.97	0.20	4.40
		DCGT 11T304EN-CF05		●	9.52	11.60	3.97	0.40	4.40
		DCGT 11T308EN-CF05		●	9.52	11.60	3.97	0.80	4.40
-CF55		DCMT 070202EN-CF55		●	6.35	7.75	2.38	0.20	2.80
		DCMT 070204EN-CF55		●	6.35	7.75	2.38	0.40	2.80
		DCMT 11T304EN-CF55		●	9.52	11.60	3.97	0.40	4.40
		DCMT 11T308EN-CF55		●	9.52	11.60	3.97	0.80	4.40
-SM		DCMT 070204EN-SM	●	●	6.35	7.75	2.38	0.40	2.80
		DCMT 070208EN-SM	●	●	6.35	7.75	2.38	0.80	2.80
		DCMT 11T304EN-SM	●	●	9.52	11.60	3.97	0.40	4.40
		DCMT 11T308EN-SM	●	●	9.52	11.60	3.97	0.80	4.40
DNMA		DNMA 150408EN		●	12.70	15.50	4.76	0.80	5.16
		DNMA 150608EN	●	●	12.70	15.50	6.35	0.80	5.16
		DNMA 150612EN	●	●	12.70	15.50	6.35	1.20	5.16
--M50		DNMG 150608EN-M50	●	●	12.70	15.50	6.35	0.80	5.16
		DNMG 150612EN-M50	●	●	12.70	15.50	6.35	1.20	5.16
M70		DNMG 150608EN-M70	●	●	12.70	12.90	4.76	0.80	5.16
		DNMG 150612EN-M70	●	●	12.70	12.90	4.76	1.20	5.16
		DNMG 150612EN-M70	●	●	12.70	12.90	4.76	1.60	5.16
-TFQ		DNMG 150604EN-TFQ		●	12.70	15.50	6.35	0.40	5.16
		DNMG 150608EN-TFQ		●	12.70	15.50	6.35	0.80	5.16

● Main application
○ Extended application

SCGT.. / SCHN.. / SCMT.. / SNMA.. / SNMG..

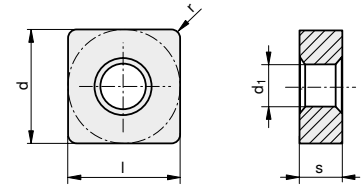

		CTCK110	CTCK120	CTEP110	d [mm]	l [mm]	s [mm]	r [mm]	d ₁ [mm]
-CF05		SCGT 09T304EN-CF05	●		9.52	9.52	3.97	0.40	4.40
		SCGT 09T308EN-CF05		●	9.52	9.52	3.97	0.80	4.40
-CF55		SCMT 09T304EN-CF55	●		9.52	9.52	3.97	0.40	4.40
		SCMT 09T308EN-CF55		●	9.52	9.52	3.97	0.80	4.40
-SM		SCMT 09T304EN-SM	● ●		9.52	9.52	3.97	0.40	4.40
		SCMT 09T308EN-SM	● ●		9.52	9.52	3.97	0.80	4.40
		SCMT 120408EN-SM	● ●		12.70	12.70	4.76	0.80	5.50
		SCMT 120412EN-SM	● ●		12.70	12.70	4.76	1.20	5.30
SNMA		SNMA 120408EN	● ●		12.70	12.70	4.76	0.80	5.16
		SNMA 120412EN	● ●		12.70	12.70	4.76	1.20	5.16
		SNMA 120416EN	● ●		12.70	12.70	4.76	1.20	5.16
		SNMA 150612EN	● ●		15.88	15.88	6.35	1.20	6.35
		SNMA 150616EN	● ●		15.88	15.88	6.35	1.60	6.35
		SNMA 190612EN	● ●		19.05	19.05	6.35	1.20	7.94
		SNMA 190616EN	● ●		19.05	19.05	6.35	1.60	7.94
-M70		SNMG 120408EN-M70	● ●		12.70	12.70	4.76	0.80	5.16
		SNMG 120412EN-M70	● ●		12.70	12.70	4.76	1.20	5.16
		SNMG 150612EN-M70	● ●		15.88	15.88	6.35	1.20	6.35
		SNMG 150616EN-M70	● ●		15.88	15.88	6.35	1.60	6.35
		SNMG 190612EN-M70	● ●		19.05	19.05	6.35	1.20	7.94
		SNMG 190616EN-M70	● ●		19.05	19.05	6.35	1.60	7.94
-Q		SCHN 090407EN-Q	●		9.52	9.52	4.76	0.70	-





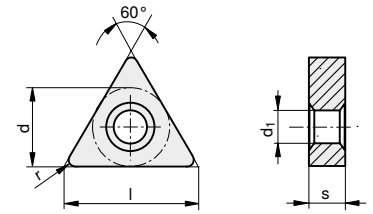

● Main application
○ Extended application

TCGT.. / TCMT.. / TNMA.. / TNMG..

P	○	○	●
M	○	○	○
K	●	●	○
S	○	○	○
H			

CTCK110
CTCK120
CTEP110







			d [mm]	l [mm]	s [mm]	r [mm]	d ₁ [mm]	
-CF05		TCGT 110202EN-CF05	●	6.35	11.00	2.38	0.20	2.80
		TCGT 110204EN-CF05	○	6.35	11.00	2.38	0.40	2.80
		TCGT 110208EN-CF05	○	6.35	11.00	2.38	0.80	2.80
		TCGT 16T304EN-CF05	○	9.52	16.50	3.97	0.40	4.40
-CF20		TNMG 160404EN-CF20	●	9.52	16.50	4.76	0.40	3.81
		TNMG 160408EN-CF20	○	9.52	16.50	4.76	0.80	3.81
		TNMG 160412EN-CF20	○	9.52	16.50	4.76	1.20	3.81
-CF55		TCMT 110204EN-CF55	●	6.35	11.00	2.38	0.20	2.80
		TCMT 16T308EN-CF55	○	9.52	16.50	3.97	0.40	4.40
-SM		TCMT 110204EN-SM	●●	6.35	11.00	2.38	0.40	2.80
		TCMT 110208EN-SM	●●	6.35	11.00	2.38	0.80	2.80
		TCMT 16T304EN-SM	●●	9.52	16.50	3.97	0.40	4.40
		TCMT 16T308EN-SM	●●	9.52	16.50	3.97	0.80	4.40
		TCMT 16T312EN-SM	●	9.52	16.50	3.97	1.20	4.40
TNMA		TNMA 160408EN	●●	9.52	16.50	4.76	0.80	3.81
		TNMA 160412EN	●●	9.52	16.50	4.76	1.20	3.81
		TNMA 160416EN	●●	9.52	16.50	4.76	1.60	3.81
		TNMA 220408EN	●●	12.70	22.00	4.76	0.80	5.16
		TNMA 220412EN	●●	12.70	22.00	4.76	1.20	5.16
		TNMA 220416EN	●●	12.70	22.00	4.76	1.60	5.16
-M70		TNMG 160408EN-M70	●●	9.52	16.50	4.76	0.80	3.81
		TNMG 160412EN-M70	●●	9.52	16.50	4.76	1.20	3.81
		TNMG 220408EN-M70	●●	12.70	22.00	4.76	0.80	5.16
		TNMG 220412EN-M70	●●	12.70	22.00	4.76	1.20	5.16
		TNMG 220416EN-M70	●●	12.70	22.00	4.76	1.60	5.16

● Main application
○ Extended application

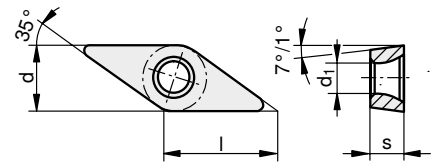
VCGT.. / VCMT.. / VNMG..

P	○	○	●
M	○	○	○
S	●	●	○
H	○	○	○





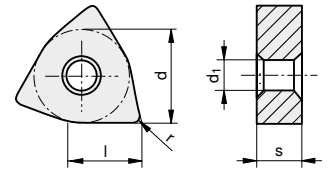

		CTCK110	CTCK120	CTEP110	d [mm]	l [mm]	s [mm]	r [mm]	d ₁ [mm]
SM		VCMT 160404EN-SM	●	●	9.52	16.60	4.76	0.40	4.40
		VCMT 160408EN-SM	●	●	9.52	16.60	4.76	0.80	4.40
-CF05		VCGT 110302EN-CF05	○	●	6.35	11.10	3.18	0.20	2.80
		VCGT 110304EN-CF05	○	●	6.35	11.10	3.18	0.40	2.90
		VCGT 160404EN-CF05	○	●	9.52	16.60	4.76	0.40	4.40
		VCGT 160408EN-CF05	○	●	9.52	16.60	4.76	0.80	4.40
-CF55		VCMT 110304EN-CF55	○	●	6.35	11.10	3.18	0.40	2.90
		VCMT 160404EN-CF55	○	●	9.52	16.60	4.76	0.40	4.40
		VCMT 160408EN-CF55	○	●	9.52	16.60	4.76	0.80	4.40
-M50		VNMG 160408EN-M50	○	●	9.52	16.60	4.76	0.80	3.81
		VNMG 160412EN-M50	○	●	9.52	16.60	4.76	1.20	3.81

● Main application
○ Extended application

WNMA.. / WNMG..



		CTCK110	CTCK120	CTEP110	d [mm]	l [mm]	s [mm]	r [mm]	d ₁ [mm]
WNMA		WNMA 080408EN	●	●	12.70	8.69	4.76	0.80	5.16
		WNMA 080412EN	●	●	12.70	8.69	4.76	1.20	5.16
		WNMA 080416EN	●	●	12.70	8.69	4.76	1.60	5.16
-CF20		WNMG 060404EN-CF20	●		9.52	6.50	4.76	0.40	3.81
		WNMG 060408EN-CF20		●	9.52	6.50	4.76	0.80	3.81
		WNMG 080408EN-CF20	●		12.70	8.69	4.76	0.80	5.16
-TFQ		WNMG 060408EN-TFQ	●		9.52	6.50	4.76	0.80	3.81
		WNMG 080404EN-TFQ		●	12.70	8.69	4.76	0.40	5.16
		WNMG 080408EN-TFQ	●		12.70	8.69	4.76	0.80	5.16
-M50		WNMG 080408EN-M50	●	●	12.70	8.69	4.76	0.80	5.16
		WNMG 080412EN-M50	●	●	12.70	8.69	4.76	1.20	5.16
-M70		WNMG 080408EN-M70	●	●	12.70	8.69	4.76	0.80	5.16
		WNMG 080412EN-M70	●	●	12.70	8.69	4.76	1.20	5.16
		WNMG 080416EN-M70	●	●	12.70	8.69	4.76	1.60	5.16

● Main application
○ Extended application





DCBN..

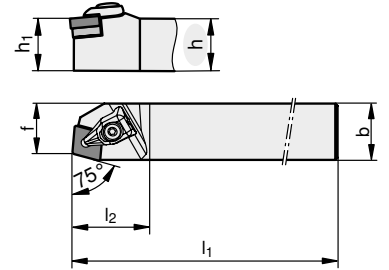

Image shows right-hand version



h [mm]	Type, Designation	L N R 	h ₁ [mm]	b [mm]	l ₁ [mm]	l ₂ [mm]	f [mm]		
25	DCBNR 2525 M12	R	25	25	150	32	22	CN.. 1204..	E01
25	DCBNL 2525 M12	L	25	25	150	32	22	CN.. 1204..	E01



E01



11224545



11224494



11211558





11224503

DCKN..

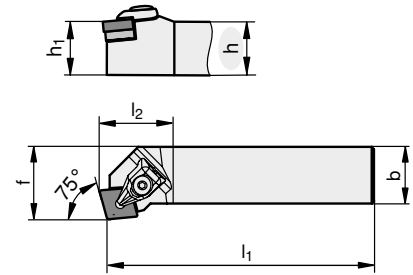

Image shows right-hand version



h [mm]	Type, Designation	L N R	h_1 [mm]	b [mm]	l_1 [mm]	l_2 [mm]	f [mm]		
25	DCKNR 2525 M12	R	25	25	150	29	32	CN.. 1204..	E01
25	DCKNL 2525 M12	L	25	25	150	29	32	CN.. 1204..	E01



E01



11224545



11224494



11211558







11224503

DCLN..

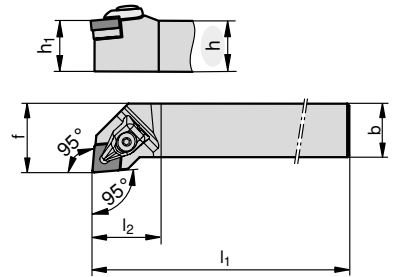

Image shows right-hand version



h [mm]	Type, Designation	L N R 	h ₁ [mm]	b [mm]	l ₁ [mm]	l ₂ [mm]	f [mm]		
20	DCLNR 2020 K09	R	20	20	125	24	25	CN.. 0903..	E01
20	DCLNL 2020 K09	L	20	20	125	24	25	CN.. 0903..	E01
20	DCLNR 2020 K12	R	20	20	125	32	25	CN.. 1204..	E02
20	DCLNL 2020 K12	L	20	20	125	32	25	CN.. 1204..	E02
25	DCLNL 2525 M12	R	25	25	150	32	32	CN.. 1204..	E02
25	DCLNR 2525 M12	L	25	25	150	32	32	CN.. 1204..	E02
25	DCLNR 2525 M16	R	25	25	150	38	32	CN.. 1606..	E03
25	DCLNL 2525 M16	L	25	25	150	38	32	CN.. 1606..	E03
32	DCLNR 3232 P16	R	32	32	170	37	40	CN.. 1606..	E03
32	DCLNL 3232 P16	L	32	32	170	37	40	CN.. 1606..	E03
32	DCLNR 3232 P19	R	32	32	170	42	40	CN.. 1906..	E04
32	DCLNL 3232 P19	L	32	32	170	42	40	CN.. 1906..	E04





E01	11227306	11227305	11577861	11227314
E02	11224545	11224494	11211558	11224503
E03	11227322	11227318	11227315	11227323
E04	11227325	11227318	11227316	11227323

DDJN..

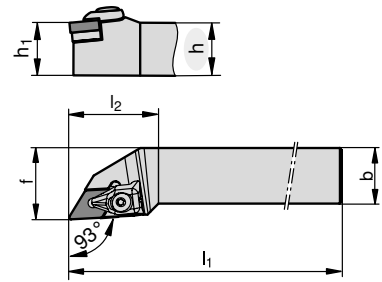

Image shows right-hand version



h [mm]	Type, Designation	LNR	h ₁ [mm]	b [mm]	l ₁ [mm]	l ₂ [mm]	f [mm]		
20	DDJNR 2020 K11	R	20	20	125	40	25	DN.. 1104..	E01
20	DDJNL 2020 K11	L	20	20	125	40	25	DN.. 1104..	E01
20	DDJNR 2525 M11	R	25	25	150	40	32	DN.. 1104..	E01
20	DDJNL 2525 M11	L	25	25	150	40	32	DN.. 1104..	E01
25	DDJNR 2020 K15	R	20	20	125	40	25	DN.. 1506..	E02
25	DDJNL 2020 K15	L	20	20	125	40	25	DN.. 1506..	E02
25	DDJNR 2525 M15	R	25	25	150	40	32	DN.. 1506..	E02
25	DDJNL 2525 M15	L	25	25	150	40	32	DN.. 1506..	E02



E01

11258694

11227305

11227308

11227314

E02

11224545

11224494

11211562



11224503

DSBN..

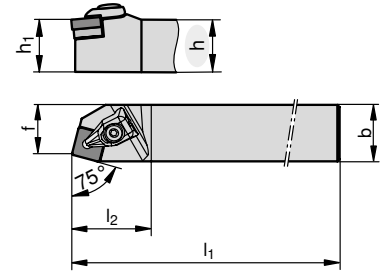

Image shows right-hand version



h [mm]	Type, Designation	L N R 	h ₁ [mm]	b [mm]	l ₁ [mm]	l ₂ [mm]	f [mm]		
20	DSBNR 2020 K12	R	20	20	125	35	17	SN.. 1204..	E01
20	DSBNL 2020 K12	L	20	20	125	35	17	SN.. 1204..	E01
25	DSBNR 2525 M12	R	25	25	150	35	22	SN.. 1204..	E01
25	DSBNL 2525 M12	L	25	25	150	35	22	SN.. 1204..	E01
25	DSBNR 2525 M15	R	25	25	150	43	22	SN.. 1506..	E02
25	DSBNL 2525 M15	L	25	25	150	43	22	SN.. 1506..	E02
32	DSBNR 3232 P15	R	32	32	170	42	27	SN.. 1506..	E02
32	DSBNL 3232 P15	L	32	32	170	42	27	SN.. 1506..	E02
32	DSBNR 3232 P19	R	32	32	170	48	27	SN.. 1906..	E03
32	DSBNL 3232 P19	L	32	32	170	48	27	SN.. 1906..	E03



E01

11224545

11224494

11211561

11224503

E02

11227322

11227318

11247269

11227323

E03

11227325



11227318

11227317

11227323

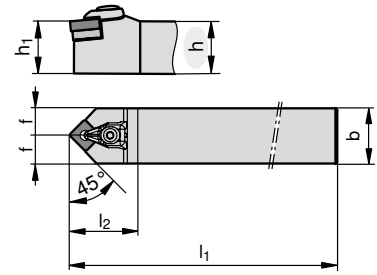
DSDN..



h [mm]	Type, Designation	LNR 	h_1 [mm]	b [mm]	l_1 [mm]	l_2 [mm]	f [mm]		
20	DSDNN 2020 K12	N	20	20	125	38	10	SN.. 1204..	E01
25	DSDNN 2525 M12	N	25	25	150	38	12.5	SN.. 1204..	E01



E01



11224545



11224494



11211561







11224503

DSKN..

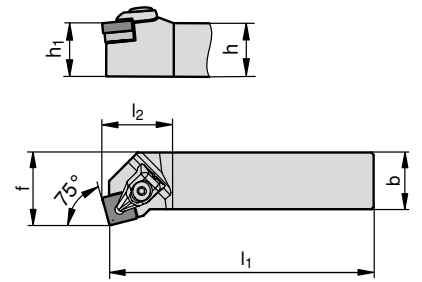

Image shows right-hand version



h [mm]	Type, Designation	L N R 	h ₁ [mm]	b [mm]	l ₁ [mm]	l ₂ [mm]	f [mm]		
25	DSKNR 2525 M12	R	25	25	150	31	32	SN.. 1204..	E01
25	DSKNL 2525 M12	L	25	25	150	31	32	SN.. 1204..	E01



E01



11224545



11224494



11211561







11224503

DSSN..

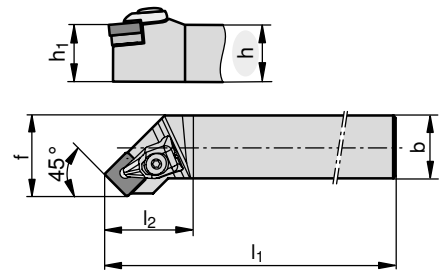

Image shows right-hand version



h [mm]	Type, Designation	L N R 	h ₁ [mm]	b [mm]	l ₁ [mm]	l ₂ [mm]	f [mm]		
20	DSSNR 2020 K12	R	20	20	125	35	25	SN.. 1204..	E01
20	DSSNL 2020 K12	L	20	20	125	35	25	SN.. 1204..	E01
25	DSSNR 2525 M12	R	25	25	150	35	32	SN.. 1204..	E01
25	DSSNL 2525 M12	L	25	25	150	35	32	SN.. 1204..	E01



E01



11224545



11224494



11211561



11224503

DTJN..



Image shows right-hand version

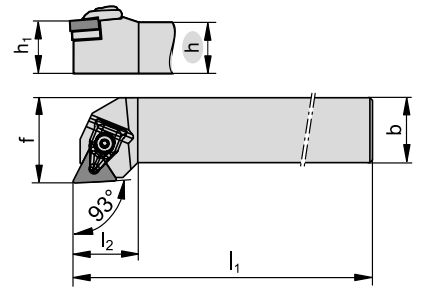

h [mm]	Type, Designation	LNR 	h ₁ [mm]	b [mm]	l ₁ [mm]	l ₂ [mm]	f [mm]		
20	DTJNR 2020 K16	R	20	20	125	23	25	TN.. 1604..	E01
20	DTJNL 2020 K16	L	20	20	125	23	25	TN.. 1604..	E01
25	DTJNR 2525 M16	R	25	25	150	24	32	TN.. 1604..	E01
25	DTJNL 2525 M16	L	25	25	150	24	32	TN.. 1604..	E01



E01



11227306



11227305



11344329





11227314

DVJN..

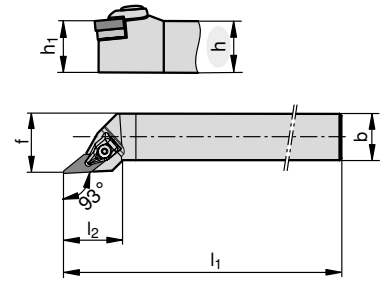

Image shows right-hand version



h [mm]	Type, Designation	LNR	h ₁ [mm]	b [mm]	l ₁ [mm]	l ₂ [mm]	f [mm]		
20	DVJNR 2020 K16	R	20	20	125	39	25	VN.. 1604..	E01
20	DVJNL 2020 K16	L	20	20	125	39	25	VN.. 1604..	E01
25	DVJNR 2525 M16	R	25	25	150	39	32	VN.. 1604..	E01
25	DVJNL 2525 M16	L	25	25	150	39	32	VN.. 1604..	E01



E01



11258694



11227305







11227311

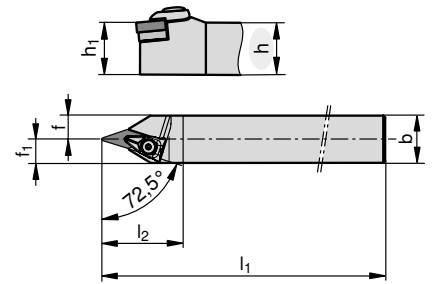

11227314

DVVN..



h [mm]	Type, Designation	LNR 	h ₁ [mm]	b [mm]	l ₁ [mm]	l ₂ [mm]	f [mm]	f ₁ [mm]		
20	DVVNN 2020 K16	N	20	20	125	43	7.5	12.5	VN.. 1604..	E01
25	DVVNN 2525 M16	N	25	25	150	43	12.5	12.5	VN.. 1604..	E01



E01



11258694



11227305



11227311







11227314

DWLN..

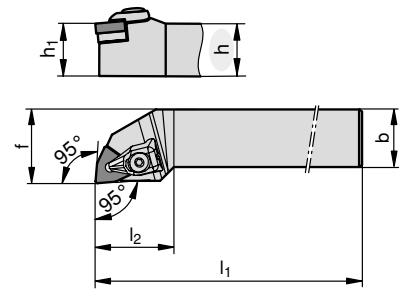

Image shows right-hand version



h [mm]	Type, Designation	L N R 	h_1 [mm]	b [mm]	l_1 [mm]	l_2 [mm]	f [mm]		
20	DWLN R 2020 K06	R	20	20	125	27	25	WN.. 0604..	E01
20	DWLN L 2020 K06	L	20	20	125	27	25	WN.. 0604..	E01
20	DWLN R 2020 K08	R	20	20	125	34	25	WN.. 0804..	E02
20	DWLN L 2020 K08	L	20	20	125	34	25	WN.. 0804..	E02
25	DWLN R 2525 M06	R	25	25	150	27	32	WN.. 0604..	E01
25	DWLN L 2525 M06	L	25	25	150	27	32	WN.. 0604..	E01
25	DWLN R 2525 M08	R	25	25	150	34	32	WN.. 0804..	E02
25	DWLN L 2525 M08	L	25	25	150	34	32	WN.. 0804..	E02



E01

11227306

11227305

11227310

11227314

E02

11224545

11224494

11211563

11224503

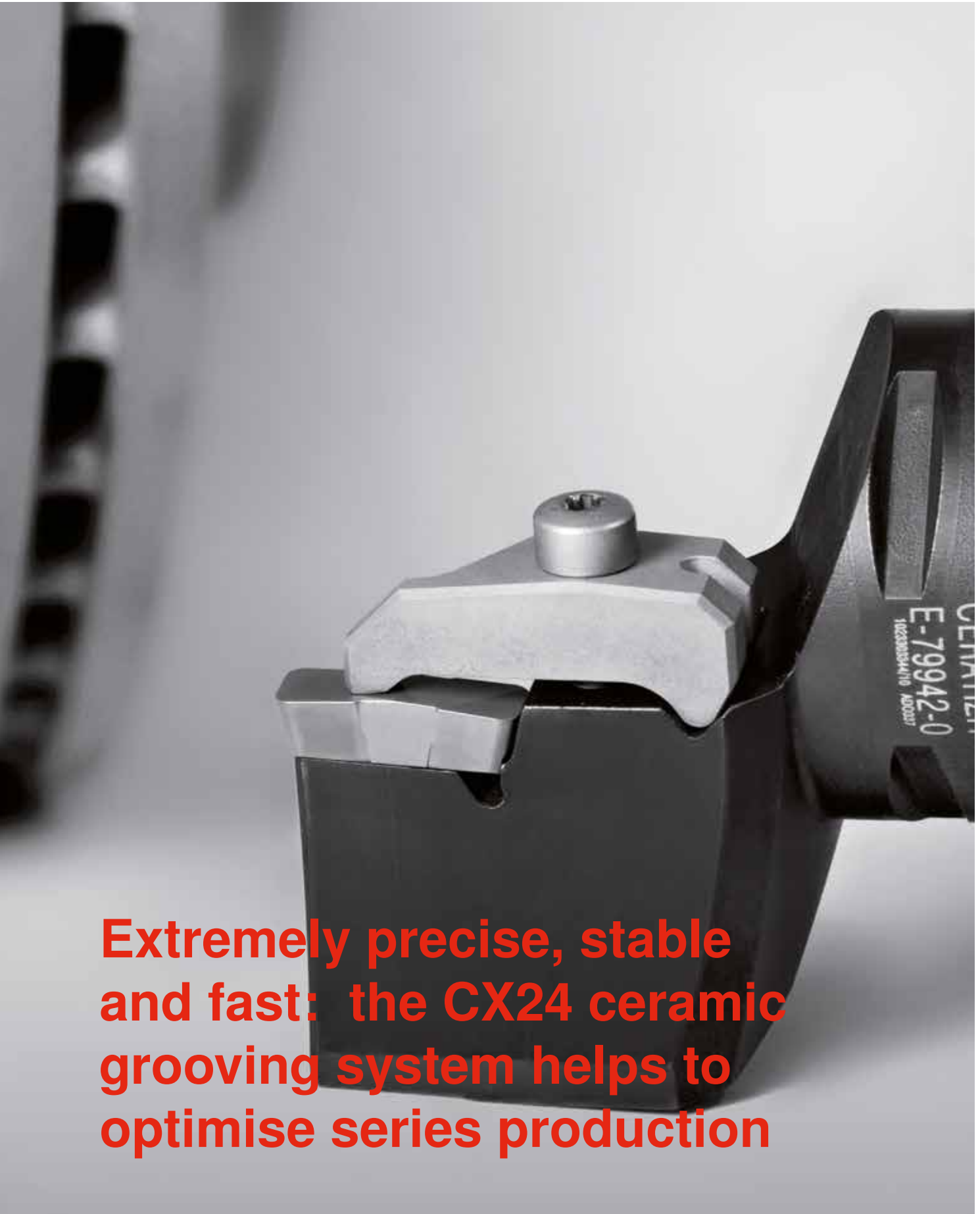

Extremely precise, stable and fast: the CX24 ceramic grooving system helps to optimise series production

Ceramic grooving with CX24

Grooving the thermal groove on the brake disc is an important machining step and calls for an extremely stable tool, so as to ensure a secure process with the necessary long service lives. In order to meet these challenges in long-term operation, we developed the CX24 ceramic grooving system for machining grey cast iron and other types of cast iron. Like the C-clamp holder, it is equipped with a wear-resistant carbide claw.

When combined with our high-performance ceramic cutting materials, this enables extremely precise grooving with no vibrations. The CX24 ceramic grooving system is suitable for standard tools with square-section shanks and modular tool systems with standardised interfaces such as HSK, UTS, Capto, etc. Its optimised design permits high feed rates with simplified handling, considerably shorter changing times and greatly reduced tool wear. By implementing grooving and profiling operations in one system, it is possible to minimise machining outlay and unit costs, with savings of up to 85% being attainable. The CERATIZIT CX24 ceramic grooving system therefore makes a decisive contribution towards increasing productivity in series manufacturing of brake discs.

Grades overview

Grade designation	Standard designation		Cutting material type	Application range												P	M	K	N	S	H	
	ISO	ANSI		01	05	10	15	20	25	30	35	40	45	50								
CTN3105	CN-K05	C4	N	[Application range bar with a shaded area from 05 to 15]															●			
CTI3105	CN-K05	C3	I	[Application range bar with a shaded area from 05 to 15]															●			
	CN-S05	-	I	[Application range bar with a shaded area from 05 to 15]																		○

● Main application
○ Extended application

Grade description

CTN3105

Ceramic

CN-K05

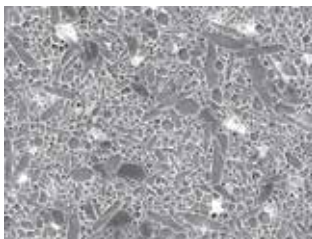

Specifications:

Composition: $\beta - Si_3N_4$ | Grain size: fine | Hardness: HV₁₀ 1620

Recommended use:

Universal silicon nitride grade for cast iron machining.

CTI3105

Ceramic

CN-K05 | CN-S05



Specifications:

Composition: $\alpha, \beta - SiAlON$ | Hardness: HV₁₀ 1900

Recommended use:

The hardest sialon on the market – high-performance grade for machining of cast iron and Ni-based alloys.

CX24..

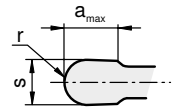
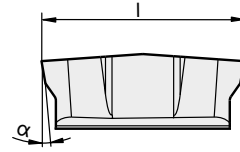

CX24



	CTN3105	l [mm]	α [°]	r [mm]	s [mm]	a_{max} [mm]
CX24-2R2.5EN	●	24.00	10.00	2.50	5.00	9.00
CX24-2R3.0EN	●	24.00	10.00	3.00	6.00	9.00
CX24-3E7.00N2.5EN	●	24.00	10.00	2.50	7.00	12.00

- Main application
- Extended application

CX24 shank holder - radial

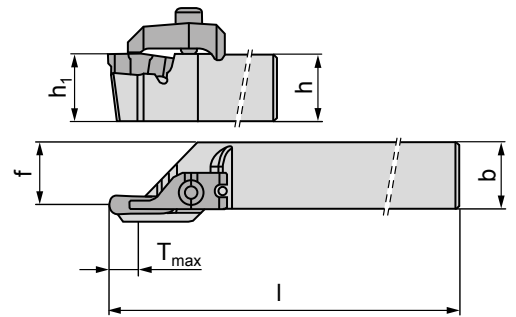

h [mm]	Type, Designation	LNR	h ₁ [mm]	b [mm]	l [mm]	T _{max} * [mm]	f [mm]		
25	E25L0012-2525M-CX24-2	L	25	25	150	12	23	CX24-2..	E01
25	E25R0012-2525M-CX24-2	R	25	25	150	12	23	CX24-2..	E02
25	E25L0012-2525M-CX24-3	L	25	25	150	12	23	CX24-3..	E01
25	E25R0012-2525M-CX24-3	R	25	25	150	12	23	CX24-3..	E02

*T_{max} dependent on width of indexable insert

CX24 shank holder - axial

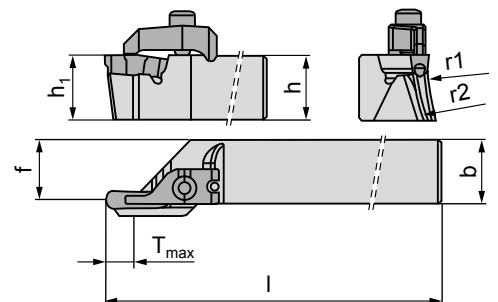

h [mm]	Type, Designation	LNR	h ₁ [mm]	b [mm]	l [mm]	T _{max} * [mm]	f [mm]		
25	E25L0012-2525M-CX24-2 A130-180	L	25	25	150	12	23	CX24-2..	E01
25	E25R0012-2525M-CX24-2 A130-180	R	25	25	150	12	23	CX24-2..	E02
25	E25L0012-2525M-CX24-3 A140-200	L	25	25	150	12	23	CX24-3..	E01
25	E25R0012-2525M-CX24-3 A140-200	R	25	25	150	12	23	CX24-3..	E02



*T_{max} dependent on width of indexable insert

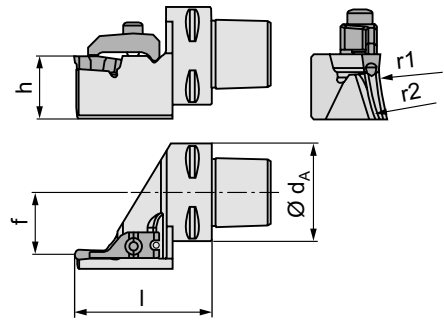

E01	11680017	11515901	11227323
E02	11680031	11515901	11227323

PSC50-CX24.. Axial holder



h [mm]	Type, Designation	LNR 	d _a [mm]	l [mm]	T _{max} * [mm]	f [mm]		
32	PSC50-L0014-32070-CX24-2 A130-190	L	50	70	14	32	CX24-2..	E01
32	PSC50-R0014-32070-CX24-2 A130-190	R	50	70	14	32	CX24-2..	E02
32	PSC50-L0015-32070-CX24-3 A140-240	L	50	70	15	32	CX24-3..	E01
32	PSC50-R0015-32070-CX24-3 A140-240	R	50	70	15	32	CX24-3..	E02

*T_{max} dependent on width of indexable insert



E01

11680017

11515901

11227323

E02

11680031

11515901

11227323



**First-class cutting materials
combined with improved
tools make series production
of brake discs even more
productive!**

Technical references

Due to the continuous further development of cutting materials and the optimisation of turning and grooving tools, we are able to offer our customers in the field of brake disc manufacturing innovative solutions for all applications and machine outputs. Well-established and new high-performance grades for machining grey cast iron and other cast iron materials, indexable inserts and tools enable significantly greater service lives, feed rates and cutting speeds.

Our newly-developed cutting and grooving inserts made from full CBN, whisker ceramic and composite ceramic, combined with wear-resistant carbide claws for turning (C-clamp 2.0) and grooving (CX24) systems are being used successfully in brake disc machining. With the improved chip breakers and insert geometries, they aid in creating significantly more process security in series production. These CERATIZIT innovations help to increase service lives and reduce machining times, as higher feed rates and cutting speeds are possible – as shown convincingly by the success stories.

Machining of grey cast iron

BRAKE DISC MACHINING



PROBLEM/CRITERIA

- ▲ Increase cutting speed and feed rate
- ▲ Avoid indexable insert breakage on the outer diameter!

SITUATION

Application	Turning
Workpiece	Brake disc
Material	GG25
Properties/Hardness	HB 230–280
Machine	Hessap T.L.

COMPETITION

Tool	Special holder (S3 system)
Indexable insert	–
Grade	–

CERATIZIT

Tool	Special R holder
Indexable insert	RNGX120400TN-020D-C
Grade	CTBK103, full-PCBN insert

RESULT

	Competition	CERATIZIT
V_c [m/min]	1000	1400
a_p [mm]	3-4	3-4
f [mm]	0.7	0.8
Cooling	none	none
Tool life [piece]	1000	1000

RESULT / CUSTOMER BENEFIT

- ▲ 40% higher cutting speed
- ▲ 15% higher feed rate
- ▲ Improved wear properties
- ▲ Process security
- ▲ Chip thickness: maximum 0.74 mm, average 0.40 mm

CUTTING SPEED

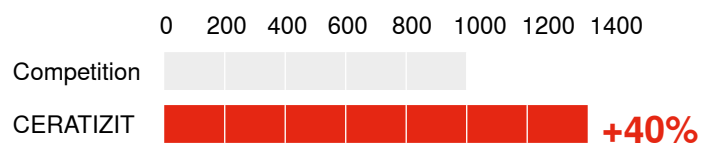

Machining of grey cast iron

BRAKE DISC MACHINING



SITUATION

Application	Turning
Workpiece	Brake disc Ø 300 mm
Material	GG25
Properties/Hardness	–
Machine	Scherer Feinbau

PROBLEM/CRITERIA

- ▲ Increase service life and improve surface quality

CERATIZIT

Tool	Special finishing holder (hydraulic)
Indexable insert	SNGX120416TN-020D-C
Grade	CTBK103

RESULT

	Competition	CERATIZIT
V_c [m/min]	800	1050
a_p [mm]	0.3	0.3
f [mm]	0.5	0.5
Cooling	none	none
Tool life [piece]	450	600

RESULT / CUSTOMER BENEFIT

- ▲ Tool changes reduced by 25%
- ▲ Better surface quality – including visually
- ▲ Cutting speed more than 30% higher
- ▲ Service life more than 30% longer

TOOL LIFE

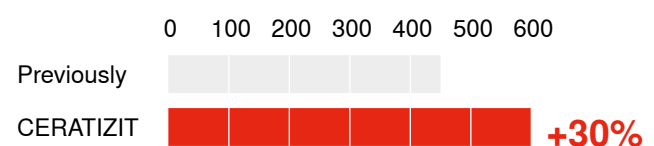

Machining of grey cast iron

BRAKE DISC MACHINING



SITUATION

Application	Grooving
Workpiece	Brake disc (Ø 340mm)
Material	GG25
Properties/Hardness	–
Machine	Hessap T.L.

PROBLEM/CRITERIA

- ▲ Reduce unit costs

CERATIZIT

Tool	Special CX24 holder
Indexable insert	CX24-3 R5-Special profile
Grade	CTN3105

RESULT

	Competition	CERATIZIT
V_c [m/min]	1000	1500
a_p [mm]		
f [mm]	0.5	0.55
Cooling	none	none
Tool life [piece]	700	700
Insert price [%]	100	15

RESULT / CUSTOMER BENEFIT

- ▲ Carbide claw > process security
- ▲ Feed rate: +10%, cutting speed: +50%
- ▲ Ceramics replaced by full-CBN.
Unit costs reduced by 85%!

CUTTING SPEED

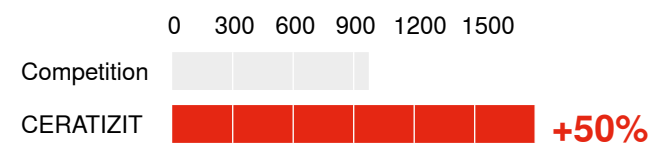

Machining of grey cast iron

PRE-FINISHING OF A FRONT DISC

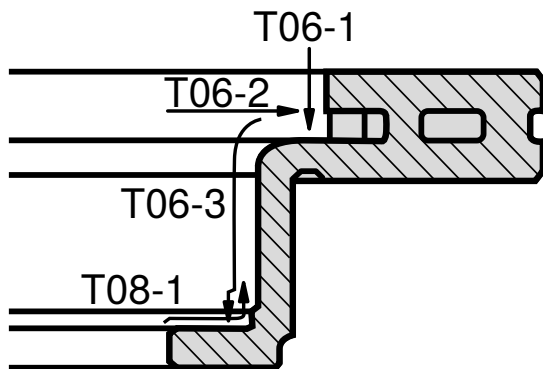

PROBLEM/CRITERIA

- ▲ Process-secure machining, increased tool life

SITUATION

Application	Finishing
Workpiece	Brake disc Ø 431 mm
Material	alloyed grey steel (TL-011)
Properties/Hardness	–
Machine	Mazak VC500

COMPETITION

Tool	Standard shank holder
Indexable insert	
Grade	GC3015

CERATIZIT

Tool	DWLN R 2525 M08-C207
Indexable insert	WNGX080416TN-020D-C
Grade	CTN3105

RESULT

	Competition	CERATIZIT
V_c [m/min]	450	600
a_p [mm]	1.1	1.1
f [mm]	0.40	0.40
Cooling	none	none
Tool life [piece]	8-10	62

RESULT / CUSTOMER BENEFIT

- ▲ Process security established – no more fluctuations in the tool life
- ▲ CERAMIC works without crater formation (against HM-C)
- ▲ Tool life increased almost sevenfold = 700%

TOOL LIFE

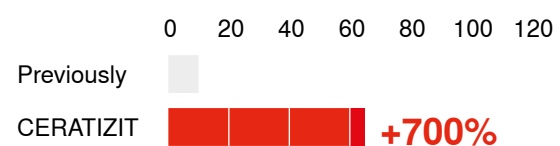

Machining of grey cast iron

FINISHING OF A REAR WHEEL DISC



SITUATION

Application	Finishing
Workpiece	Brake disc Ø 340mm
Material	Proprietary GG-25
Properties/Hardness	–
Machine	HONOR vertical centre

COMPETITION

Tool	–
Indexable insert	CNMG 120408EN-MA
Grade	UC5115

PROBLEM/CRITERIA

- ▲ Increase feed rate, better surface quality

CERATIZIT

Tool	WB-ISO shank tool
Indexable insert	CNMA 120412EN
Grade	CTCK110

RESULT

	Competition	CERATIZIT
V_c [m/min]	300	300
a_p [mm]	0.40-0.50	0.40-0.50
f [mm]	0.20	0.32
Cooling	none	none
Tool life [piece]	90-110	330

RESULT / CUSTOMER BENEFIT

- ▲ Feed rate increased by 60%, lower R_a value attained
- ▲ Significantly-improved surface quality due to Masterfinish effect (R0.8 to R1.2)
- ▲ Tool life fluctuation caused by changing material conditions reduced, process security increased

TOOL LIFE



Machining of cast iron

BELT PULLEY



PROBLEM/CRITERIA

- ▲ Longer tool life, cost saving

SITUATION

Application	Turning
Workpiece	Belt pulley / grooved wheel
Material	G3000 iron
Properties/Hardness	20–25 HRC
Machine	Herkules

COMPETITION

Tool	–
Indexable insert	CNMG12048EN-MF
Grade	–

CERATIZIT

Tool	Special tool
Indexable insert	CNMA 120408EN
Grade	CTCK110

RESULT

	Competition	CERATIZIT
V_c [m/min]	800	800
a_p [mm]	Roughness 0.40 + fine 0.10	0.50 in one pass
f [mm]	0.3	0.3
Cooling	none	none
Tool life [piece]	500	900

RESULT / CUSTOMER BENEFIT

- ▲ Material is too soft for whisker, carbide is by far the better choice
- ▲ Process time improved by approx. 50% cycle time, 1.07 seconds instead of 2.10 seconds
- ▲ High cost saving for this fully-automatic line

TOOL LIFE

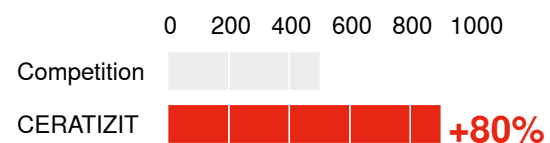

Machining of high-alloy cast iron

PRODUCTION OF A REAR WHEEL DISC

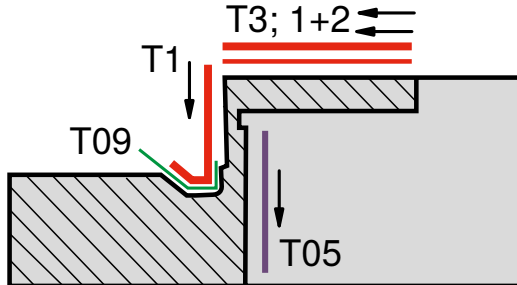

SITUATION

Application	Turning
Workpiece	Brake disc Ø 430 mm
Material	High-alloy cast iron
Properties/Hardness	–
Machine	Doosan vertical centre

COMPETITION

Tool	–
Indexable insert	–
Grade	MC5115

CERATIZIT

Tool	Special tool
Indexable insert	TNMG 220416EN-M70 and others
Grade	CTCK110 & CTCK120

PROBLEM/CRITERIA

- ▲ Process security and improved tool service life
- ▲ T1: TNMG 220416EN-M70 T3.2: WNMA 080412EN
- ▲ T5: WNMG 080416EN-M70 T09: VNMG 160412EN-M50 CTCK120 different ap values for each operation - T1+T5+T3.1= 1 mm T3.2= 0.20 mm and T09= 2.20 mm

RESULT

	Competition	CERATIZIT
V_c [m/min]	450	450
a_p [mm]	0.20 in T3 / 1.00 in T1+T5 / 2.20 in T09	
f [mm]	0.30	0.30
Cooling	none	none
Tool life [piece]	4-5	10-12

RESULT / CUSTOMER BENEFIT

- ▲ Process security established
- ▲ Up to three times the tool life (depending on operation)
- ▲ Significantly lower cutting forces and power requirement, less component deformation

TOOL LIFE

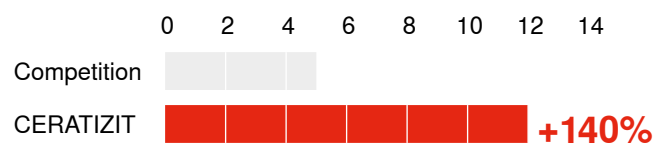

Machining of cast iron

BRAKE DISC MACHINING

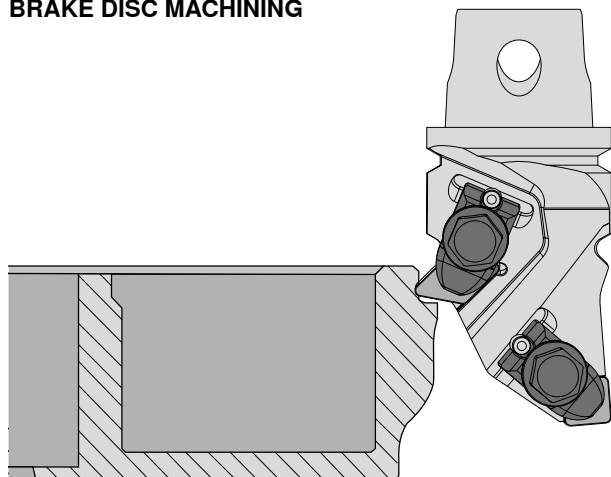

SITUATION

Application	Turning
Workpiece	Brake disc
Material	EN-GJL-250 (proprietary cast iron)
Properties/Hardness	HB 170-217
Machine	Morando Multispindle

PROBLEM/CRITERIA

- ▲ Extend tool life, reduce CPP (cost per part) and increase tool service life

CERATIZIT

Tool	Special tool
Indexable insert	CNMG 120412
Grade	CTCK120

RESULT

	Competition	CERATIZIT
V_c [m/min]	250	250
a_p [mm]	1.0	1.0
f [mm]	2.0	2.0
Cooling	Emulsion	Emulsion
Piece / Cutting edge	300	500

RESULT / CUSTOMER BENEFIT

- ▲ Better surface quality also improves the semi-finish result
- ▲ Regular/consistent insert change interval on all 3 OPs
- ▲ From OP1= 300, OP2= 200 and OP3= 300 to a constant 500 pieces
- ▲ Tool life increased by approx. 70% per cutting edge

NUMBER OF PIECES

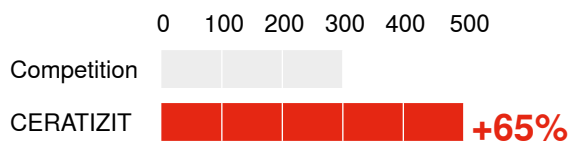

Types of wear - turning

Flank wear

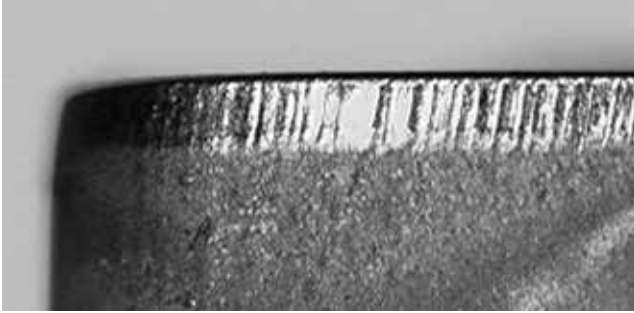

Abrasion on flank, normal wear after a certain machining time.

Cause

- ▲ Cutting speed too high
- ▲ Grade does not have enough wear resistance
- ▲ Feed not adapted to application

Solution

- ▲ Select a cutting material grade with a higher wear resistance
- ▲ Bring feed rate into the right relationship with cutting speed and cutting depth (increase feed rate)

Edge breakages

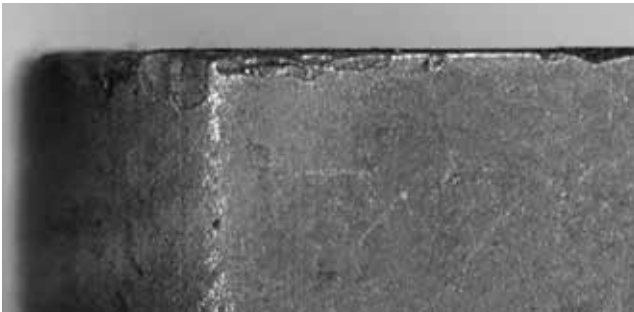

Through excessive mechanical stress at the cutting edge fracture and chipping can occur.

Cause

- ▲ Grades with too high a wear resistance
- ▲ Vibration
- ▲ Feed rate or cutting depth is too high
- ▲ Interrupted cut
- ▲ Chip stroke

Solution

- ▲ Use tougher grades
- ▲ Use negative cutting edge geometry with a chip breaker
- ▲ Improve stability (tool, workpiece)

Crater wear



The hot chip which is being evacuated causes cratering at the rake face of the cutting edge.

Cause

- ▲ Cutting speed, feed rate or both are too high
- ▲ Rake angle too low
- ▲ Grade does not have enough wear resistance
- ▲ Incorrectly supplied coolant

Solution

- ▲ Reduce cutting speed and/or feed rate
- ▲ Increase amount and/or pressure of coolant, check supply
- ▲ Use a more crater-resistant grade

Plastic deformation

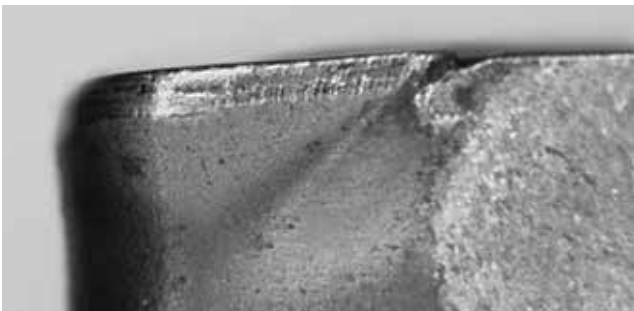

High machining temperature and simultaneous mechanical stress can lead to plastic deformation.

Cause

- ▲ Working temperature too high, softening of the base material (also found with carbide)
- ▲ Damage to the coating
- ▲ Chip breaker too narrow

Solution

- ▲ Reduce cutting speed
- ▲ Select a cutting material grade with a higher wear resistance
- ▲ Make provisions for cooling

Built-up edge formation

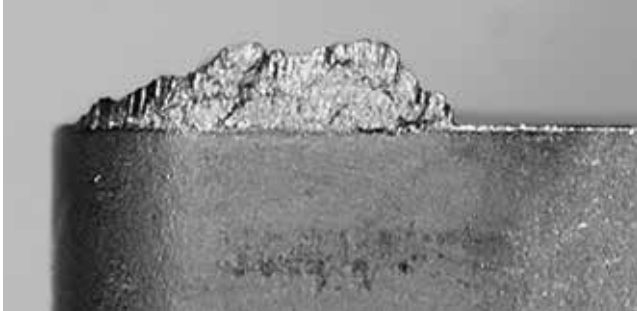

Built-up edge occurs when the chip is not evacuated properly due to insufficient cutting temperature.

Cause

- ▲ Cutting speed too low
- ▲ Rake angle too small
- ▲ Incorrect cutting material
- ▲ Missing coolant/lubrication

Solution

- ▲ Increase cutting speed
- ▲ Increase rake angle
- ▲ Use TiN coating (smooth surface)
- ▲ Use thicker emulsion

Insert breakage

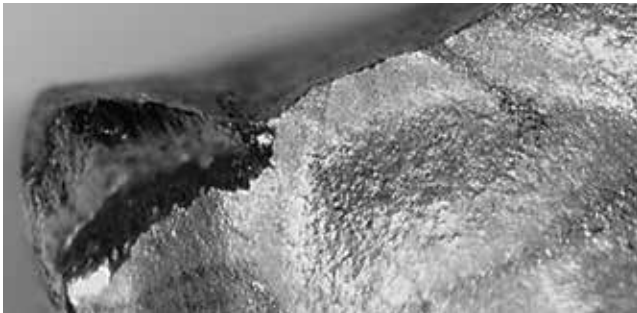

Excessive stress of the insert causes breakage.

Cause

- ▲ Overload of the cutting material
- ▲ Lack of stability
- ▲ Wedge angle too small
- ▲ Excessive notch wear

Solution

- ▲ Use a tougher cutting material
- ▲ Use chamfer for edge protection
- ▲ Increase rounding of cutting edge
- ▲ Use more stable geometry

Troubleshooting guide for turning

Problem

Type of wear		Workpiece problems									Solution, measures
Flank wear	Crater wear	Notch wear	Cracks at right angles to the cutting edge	Edge breakage	Insert breakage	Chipping on the surface	Surface quality	Vibration	Burr formation		
	↓		↓			↓	↑	↓		Cutting speed v_c	
↑	↑	↓	↓	↓		↑	↓	≈	↑	Feed f	
↑			↓	↓					↑	Depth of cut a_p	
	↓		↓		↑	↓	↓		↓	Check chamfer angle and setting angle	
		↑		↑	↑		↑	↓	↓	Corner radius	
										larger ↑ ↓ smaller	
↓	↓		↓	↓	↑	↓	↓	↓	↓	Rounding	
	↓	↑	↑	↑	↑					Physical properties BH Wear resistance BL Toughness	
				≈	≈	≈	≈	≈		Tool clamping	
				≈	≈	≈	≈	≈		Workpiece clamping	
				≈	≈	↓	↓	↓		Overhang	
≈				≈	≈	≈	≈	≈		Pitch height	

↑	raise, increase, large influence	↓	avoid, reduce, large influence	≈	check, optimise
↑	raise, increase, small influence	↓	avoid, reduce, small influence		

Special troubleshooting for brake discs

Troubleshooting

Problem	Possible causes	Solution
Poor tool lives	<ul style="list-style-type: none"> ▲ Cutting speed does not fall within the specifications (may be too high or too low) 	<ul style="list-style-type: none"> ▲ Increase cutting speed ▲ Ideally, chip is glowing ("sparkler")
Poor surface quality	<ul style="list-style-type: none"> ▲ Feed rate too high ▲ Corner radius too small 	<ul style="list-style-type: none"> ▲ Reduce feed rate ▲ Increase corner radius ▲ Use MASTERFINISH
Chatter marks	<ul style="list-style-type: none"> ▲ Tool overhang too long 	<ul style="list-style-type: none"> ▲ Reduce, use more stable holder
Vibration	<ul style="list-style-type: none"> ▲ Cutting pressure too high ▲ Chip thickness too high ▲ Centre height incorrect ▲ Unstable tool or workpiece clamping ▲ Indexable insert radius too large, high recoil force 	<ul style="list-style-type: none"> ▲ Reduce cutting pressure ▲ Reduce chip thickness ▲ Check / adjust centre height ▲ Clamp with C-clamp ▲ Use smaller radius
Burrs on workpiece	<ul style="list-style-type: none"> ▲ With soft materials ▲ Cutting pressure too high 	<ul style="list-style-type: none"> ▲ Use smaller radius ▲ Adjust chip thickness ▲ Increase cutting depth ▲ Increase cutting speed ▲ Reduce chamfer angle
Notch wear	<ul style="list-style-type: none"> ▲ Cutting speed/feed rate too high ▲ Temperature at the cutting edge too high 	<ul style="list-style-type: none"> ▲ Check cutting speed and feed rate with regard to cutting length/period of operation and adjust
Notch wear (chemical)	<ul style="list-style-type: none"> ▲ Deep scoring on the main cutting edge 	<ul style="list-style-type: none"> ▲ Check material ▲ For example, ferrite content too high (e.g. GG25)
Edge breakage on the workpiece	<ul style="list-style-type: none"> ▲ Sharp edge at the exit 	<ul style="list-style-type: none"> ▲ Change machining direction ▲ Reduce the feed rate during entry and exit

Comparison table for materials

DIN	Work-piece No.	BS	AFNOR	SS	AISI	Japan JIS	Kc1.1 N/mm ²	mc	VDI 3323 Group
10 SPb 20	1.0722		10 PbF 2		11 L 08		1350	0,20	1
100 Cr 6	1.2067	BL 3	Y 100 C 6		L 3	SUJ2	1775	0,24	6/9
105 WCr 6	1.2419		105 WC 13			SKS31	1775	0,24	6/9
12 CrMo 9 10	1.7380	1501-622 Gr. 31; 45	10 CD 9.10	2218	A 182-F22	SPVA, SCMV4	1675	0,24	6/7
12 Ni 19	1.5680		Z 18 N 5		2515		2450	0,23	10/11
13 CrMo 4 4	1.7335	1501-620 Gr. 27	15 CD 3.5	2216	A 182-F11; F12	SPVAF12	1675	0,24	6/7
14 MoV 6 3	1.7715	1503-660-440					1675	0,24	6/7
14 Ni 6	1.5622		16 N 6		A 350-LF 5		1675	0,24	6/7
14 NiCr 10	1.5732		14 NC 11		3415	SNC415(H)	1675	0,24	6/7
14 NiCr 14	1.5752	655 M 13	12 NC 15		3310; 9314	SNC815(H)	1675	0,24	6/7
14 NiCrMo 13 4	1.6657						1675	0,24	6/7
15 Cr 3	1.7015	523 M 15	12 C 3		5015		1675	0,24	6/7
15 CrMo 5	1.7262		12 CD 4			SCM415(H)	1675	0,24	6/7
15 Mo 3	1.5415	1501-240	15 D 3	2912	A 204 Gr. A		1675	0,24	6/7
16 MnCr 5	1.7131	527 M 17	16 MC 5	2511	5115	SCR415	1675	0,24	6/7
16 Mo 5	1.5423	1503-245-420			4520	SB450M	1675	0,24	6/7
17 CrNiMo 6	1.6587	820 A 16	18 NCD 6				1675	0,24	6/7
21 NiCrMo 2	1.6523	805 M 20	20 NCD 2	2506	8620	SNCM220(H)	1725	0,24	6/8
25 CrMo 4	1.7218	1717 CDS 110	25 CD 4 S	2225	4130	SM420; SCM430	1725	0,24	6/8
28 Mn 6	1.1170	150 M 28	20 M 5		1330		1500	0,22	2
32 CrMo 12	1.7361	722 M 24	30 CD 12	2240			1775	0,24	6/9
34 Cr 4	1.7033	530 A 32	32 C 4		5132	SCR430(H)	1725	0,24	6/8
34 CrMo 4	1.7220	708 A 37	35 CD 4	2234	4135; 4137	SCM432; SCCRM3	1775	0,24	6/9
34 CrNiMo 6	1.6582	817 M 40	35 NCD 6	2541	4340	SNCM447	1775	0,24	6/9
35 S 20	1.0726	212 M 36	35 MF 4	1957	1140		1525	0,22	2/3
36 CrNiMo 4	1.6511	816 M 40	40 NCD 3		9840	SNCM447	1775	0,24	6/9
36 Mn 5	1.1167						1525	0,22	2/3
36 NiCr 6	1.5710	640 A 35	35 NC 6		3135	SNC236	1800	0,24	3/9
38 MnSi 4	1.5120						1800	0,24	3/9
39 CrMoV 13 9	1.8523	897 M 39					1775	0,24	6/9
40 Mn 4	1.1157	150 M 36	35 M 5		1039		1525	0,22	2/3
40 NiCrMo 2 2	1.6546	311-Type 7	40 NCD 2		8740	SNCM240	1775	0,24	6/9
41 Cr 4	1.7035	530 M 40	42 C 4		5140	SCR440(H)	1775	0,24	6/9
41 CrAlMo 7	1.8509	905 M 39	40 CAD 6.12	2940	A 355 Cl. A	SACM645	1775	0,24	6/9
41 CrMo 4	1.7223	708 M 40	42 CD 4 TS	2244	4142; 4148	SCM440	1775	0,24	6/9
42 Cr 4	1.7045	530 A 40	42 C 4 TS	2245	5140	SCr440	1775	0,24	6/9
42 CrMo 4	1.7225	708 M 40	42 CD 4	2244	4142; 4148	SCM440(H)	1775	0,24	6/9
45 WCrV 7	1.2542	BS 1		2710	S 1		1775	0,24	6/9
50 CrV 4	1.8159	735 A 50	50 CV 4	2230	6150	SUP10	1775	0,24	6/9
55 Cr 3	1.7176	527 A 60	55 C 3	2253	5155	SUP9(A)	1775	0,24	6/9
55 NiCrMoV 6	1.2713		55 NCDV 7		L 6	SKH1; SKT4	1775	0,24	6/9
55 Si 7	1.0904	250 A 53	55 S 7	2085; 2090	9255		1775	0,24	6/9
58 CrV 4	1.8161						1775	0,24	6/9
60 SiCr 7	1.0961		60 SC 7		9262		1775	0,24	6/9
9 SMn 28	1.0715	230 M 07	S 250	1912	1213	SUM22	1350	0,21	1
9 SMn 36	1.0736	240 M 07	S 300		1215		1350	0,21	1
9 SMnPb 28	1.0718		S 250 Pb	1914	12 L 13	SUM22L	1350	0,21	1
9 SMnPb 36	1.0737		S 300 Pb	1926	12 L 14		1350	0,21	1
Al99	3.0205						700	0,25	21

Comparison table for materials

DIN	Work-piece No.	BS	AFNOR	SS	AISI	Japan JIS	Kc1.1 N/mm ²	mc	VDI 3323 Group
AlCuMg1	3.1325						700	0,25	22
AlMg1	3.3315						700	0,25	21
AlMgSi1	3.2315						700	0,25	22
C 105 W1	1.1545		Y1 105	1880	W 110	SK3	1675	0,24	3
C 125 W	1.1663		Y2 120		W 112		1675	0,24	3
C 15	1.0401	080 M 15	AF3 7 C 12; XC 18	1350	1015	S15C	1350	0,21	1
C 22	1.0402	050 A 20	AF 42 C 20	1450	1020	S20C, S22C	1350	0,21	1
C 35	1.0501	060 A 35	AF 55 C 35	1550	1035	S35C	1525	0,22	2/3
C 45	1.0503	080 M 46	AF 65 C 45	1650	1045	S45C	1525	0,22	2/3
C 55	1.0535	070 M 55		1655	1055	S55C	1675	0,24	3
C 60	1.0601	080 A 62	CC 55		1060	S60C	1675	0,24	3
Cf 35	1.1183					S35C	1525	0,22	2/3
Cf 53	1.1213					S50C	1525	0,22	2/3
Ck 101	1.1274	060 A 96		1870	1095		1675	0,24	3
Ck 15	1.1141	080 M 15	XC 15; XC 18	1370	1015	S15C	1350	0,21	1
Ck 55	1.1203	070 M 55	XC 55		1055	S55C	1675	0,24	3
Ck 60	1.1221	080 A 62	XC 60	1665; 1678	1060	S58C	1675	0,24	3
CoCr20W15Ni	2.4764						3300	0,24	35
CuZn15	2.0240						700	0,27	27
CuZn36Pb3	2.0375						700	0,27	26
E-Cu57	2.0060						700	0,27	28
G-AlSi10Mg	3.2381						700	0,25	24
G-AlSi12	3.2581						700	0,25	23
G-AlSi9Cu3	3.2163						700	0,25	23
G-CuSn5ZnPb	2.1096						700	0,27	26
G-CuZn40Fe	2.0590						700	0,27	28
G-X 120 Mn 12	1.3401	Z 120 M 12	Z 120 M 12		A 128 (A)		3300	0,24	35
G-X 20 Cr 14	1.4027	420 C 29	Z 20 C 13 M			SCS2	1875	0,21	12/13
G-X 40 NiCrSi 38 18	1.4865	330 C 40					2600	0,24	31
G-X 45 CrSi 9 3	1.4718	401 S 45	Z 45 CS 9		HNV 3		2450	0,23	10/11
G-X 5 CrNi 13 4	1.4313	425 C 11	Z 5 CN 13.4	2385	CA 6-NM		1875	0,21	12/13
G-X 5 CrNiMoNb 18 10	1.4581	318 C 17	Z 4 CNDNb 18.12 M				2150	0,20	14
G-X 6 CrNi 18 9	1.4308	304 C 15	Z 6 CN 18.10 M	2333	CF-8		2150	0,20	14
G-X 6 CrNiMo 18 10	1.4408						2150	0,20	14
G-X 7 Cr 13	1.4001						1875	0,21	12/13
GG-10	0.6010		Ft 10 D	01 10-00	A48-20 B	FC100	1150	0,21	15
GG-15	0.6015	Grade 150	Ft 15 D	01 15-00	A48-25 B	FC150	1150	0,21	15
GG-20	0.6020	Grade 220	Ft 20 D	01 20-00	A48-30 B	FC200	1150	0,21	15
GG-25	0.6025	Grade 260	Ft 25 D	01 25-00	A48-40 B	FC250	1250	0,24	15/16
GG-30	0.6030	Grade 300	Ft 30 D	01 30-00	A48-45 B	FC300	1350	0,28	16
GG-35	0.6035	Grade 350	Ft 35 D	01 35-00	A48-50 B	FC350	1350	0,28	16
GG-40	0.6040	Grade 400	Ft 40 D	01 40-00	A48-60 B	FC400	1350	0,28	16
GGG-35.3	0.7033					FCD350	1225	0,25	17
GGG-40	0.7040	SNG 420/12	FGS 400-12	0717-02	60-40-18	FCD400	1225	0,25	17
GGG-40.3	0.7043	SNG 370/17	FGS 370-17	0717-15		FCD400	1225	0,25	17
GGG-50	0.7050	SNG 500/7	FGS 500-7	0727-02	65-45-12	FCD500	1350	0,28	18
GGG-60	0.7060	SNG 600/3	FGS 600-3	0732-03	80-55-06	FCD600	1350	0,28	18
GGG-70	0.7070	SNG 700/2	FGS 700-2	0737-01	100-70-03	FCD700	1350	0,28	18
GGG-NiCr 20 2	0.7660	S-NiCr 20 2	S-NC 20 2		A 439 Type D-2		1350	0,28	18

Comparison table for materials

DIN	Work-piece No.	BS	AFNOR	SS	AISI	Japan JIS	Kc1.1 N/mm ²	mc	VDI 3323 Group
GGG-NiMn 13 7	0.7652	S-NiMn 13 7	S-NM 13 7				1350	0,28	18
GS-Ck 45	1.1191	080 M 46	XC 42	1672	1045	S45C	1525	0,22	2/3
GTS-35-10	0.8135	B 340/12	MN 35-10				1225	0,25	19
GTS-45-06	0.8145	P 440/7					1420	0,30	20
GTS-55-04	0.8155	P 510/4	MP 50-5				1420	0,30	20
GTS-65-02	0.8165	P 570/3	MP 60-3				1420	0,30	20
GTS-70-02	0.8170	P 690/2	IP 70-2				1420	0,30	20
NiCr20TiAl	2.4631	HR 401; 601	Nimonic 80 A				3300	0,24	33
NiCr22Mo9Nb	2.4856		Inconel 625				3300	0,24	33
NiCu30Al	2.4375		Monel K 500				3300	0,24	34
NiFe25Cr20NbTi	2.4955						3300	0,24	34
S 18-0-1	1.3355	BT 1	Z 80 WCV 18-04-01		T 1		2450	0,23	10/11
S 18-1-2-5	1.3255	BT 4	Z 80 WKC V 18-05-04-0		T 4		2450	0,23	10/11
S 2-9-2	1.3348		Z 100 DCWV 09-04-02-	2782	M 7		2450	0,23	10/11
S 6-5-2	1.3343	BM 2	Z 85 WDCV 06-05-04-0	2722	M 2	SKH9; SKH51	2450	0,23	10/11
S 6-5-2-5	1.3243		Z 85 WDKCV 06-05-05-	2723		SKH55	2450	0,23	10/11
TiAl6V4	3.7165	TA 10 bis TA 13	T-A 6 V				2110	0,22	37
X 10 Cr 13	1.4006	410 S 21	Z 12 C 13	2302	410; CA-15	SUS410	1875	0,21	12/13
X 10 CrNiMoNb 18 12	1.4583				318		2150	0,20	14
X 10 CrNiS 18 9	1.4305	303 S 21	Z 10 CNF 18.09	2346	303		2150	0,20	14
X 100 CrMoV 5 1	1.2363	BA 2	Z 100 CDV 5	2260	A 2		2450	0,23	10/11
X 12 CrMoS 17	1.4104		Z 10 CF 17	2383	430 F	SUS430F	1875	0,21	12/13
X 12 CrNi 17 7	1.4310	301 S 21	Z 12 CN 17.07		301		2150	0,20	14
X 12 CrNi 22 12	1.4829					SUS301	1350	0,28	16
X 12 CrNi 25 21	1.4845	310 S24	Z 12 CN 25.20	2361	310 S	SUH310; SUS310S	2150	0,20	14
X 12 CrNiTi 18 9	1.4878	321 S 20	Z 6 CNT 18.12 (B)	2337	321		2150	0,20	14
X 12 NiCrSi 36 16	1.4864	NA 17	Z 12 NCS 37.18		330	SUH330	2600	0,24	31
X 15 CrNiSi 20 12	1.4828	309 S 24	Z 15 CNS 20.12		309	SUH309	1350	0,28	16
X 165 CrMoV 12	1.2601			2310			2450	0,23	10/11
X 2 CrNiMo 18 13	1.4440						2150	0,20	14
X 2 CrNiMoN 17 13 3	1.4429	316 S 62	Z 2 CND 17.13 Az	2375	316 LN	SUS316LN	2150	0,20	14
X 2 CrNiN 18 10	1.4311	304 S 62	Z 2 CN 18 .10	2371	304 LN	SUS304LN	2150	0,20	14
X 20 CrNi 17 2	1.4057	431 S 29	Z 15 CN 16.02	2321	431	SUS431	1875	0,21	12/13
X 210 Cr 12	1.2080	BD 3	Z 200 C 12		D 3		2450	0,23	10/11
X 210 CrW 12	1.2436			2312			2450	0,23	10/11
X 30 WCrV 9 3	1.2581	BH 21	Z 30 WCV 9		H 21	SKD5	2450	0,23	10/11
X 40 CrMoV 5 1	1.2344	BH 13	Z 40 CDV 5	2242	H 13	SKD61	2450	0,23	10/11
X 46 Cr 13	1.4034	420 S 45	Z 40 C 14				1875	0,21	12/13
X 5 CrNi 18 9	1.4301	304 S 15	Z 6 CN 18.09	2332; 2333	304; 304 H	SUS304	2150	0,20	14
X 5 CrNiMo 17 13 3	1.4436	316 S 16	Z 6 CND 17.12	2343	316	SUS316	2150	0,20	14
X 5 CrNiMo 18 10	1.4401	316 S 16	Z 6 CND 17.11	2347	316	SUS316	2150	0,20	14
X 53 CrMnNiN 21 9	1.4871	349 S 54	Z 52 CMN 21.09		EV 8		1875	0,21	12/13
X 6 Cr 13	1.4000	403 S 17	Z 6 C 13	2301	403	SUS403	1875	0,21	12/13
X 6 Cr 17	1.4016	430 S 15	Z 8 C 17	2320	430	SUS430	1875	0,21	12/13
X 6 CrMo 17	1.4113	434 S 17	Z 8 CD 17.01	2325	434	SUS434	1875	0,21	12/13
X 6 CrNiMoTi 17 12 2	1.4571	320 S 31	Z 6 CNT 17.12	2350	316 Ti		2150	0,20	14
X 6 CrNiNb 18 10	1.4550	347 S 17	Z 6 CNNb 18.10	2338	347		2150	0,20	14
X 6 CrNiTi 18 10	1.4541	321 S 12	Z 6 CNT 18.10	2337	321		2150	0,20	14
X2 CrNi 18-8	1.4317						2150	0,20	14





We will support you in production with individual, tailor-made solutions and machine commissioning on site

OEM services

Not only do we offer our partners in mass production highly-stable, excellent cutting material and tool solutions for the entire automotive sector, we also provide tailor-made complete concepts and toolkits for optimal machining of their workpieces. In doing so, we guarantee the utmost professionalism and reliability, with concepts specially tailored to your requirements.

Working together with you, we will develop complete machining strategies, from defining the individual work steps through to their implementation. We will support you during commissioning, with tool assembly and in the preliminary and final acceptance processes for the machines. Tooling Academies can be found at our production sites and give you the opportunity to try out new materials and perform machining tests. Place your trust in our decades of experience and benefit from our extensive practical know-how throughout the entire field of heavy machining.

OEM services

OEM

**Everything from a single source:
tailor-made machining strategies and complete tool packages**

Not only do we offer our partners in an extremely wide range of industrial applications excellent cutting tools, but also tailor-made complete concepts and toolkits for optimal machining of workpieces on your equipment. Our own OEM team is available to coordinate and support your project. For new materials or particularly difficult workpieces, Tooling Academies at our production sites and several Technical Centres at our sales offices are ready to carry out machining tests. In this way, we are able to guarantee you the utmost professionalism and reliability, as well as solutions individually tailored to your requirements. Working togeth-

er with you, we develop detailed machining concepts and support you with implementing these directly on the machinery at your site – worldwide. We support you in process optimisation as well as in realising new projects. Get in touch.



With the CERATIZIT OEM services, we offer you the following specific options:

- ▲ Advice on workpiece clamping and the machining strategy
- ▲ Definition of the individual machining steps
- ▲ Selection of the optimal tools, cutting geometries and cutting materials
- ▲ Where required, trial machining in one of the CERATIZIT Tooling Academies or one of the Technical Centres
- ▲ Determination of cutting forces and spindle power – mathematically or by means of cutting force measurement
- ▲ Establishment of cutting parameters
- ▲ Calculation of machining times and unit costs
- ▲ Forecast for tool service lives and tool costs
- ▲ Tool assembly and measurement
- ▲ Support with preliminary and final acceptance of machines
- ▲ Comprehensive project documentation
- ▲ Effective project and deadline management

Behind every OEM project is an experienced, multi-functional team of experts from all necessary specialist areas: project management, sales, customer service, application technology, construction, logistics and production.

As a result, we are able to guarantee you a professional service for the provision of original equipment machinery and process optimisations, as well as a reliable collaboration based on partnership.



Complete and clearly-structured project documentation



The project documentation sets out the entire machining concept in full, in a clearly-structured manner: machining steps and tool assignment, machining plans, cutting

parameters, power and time calculations, tool sheets with reference dimensions, parts lists and, of course, the tool package with prices and delivery times.

CERATIZIT Deutschland GmbH
D-72186 Englingen
www.ceratizit.com
Gemeinsam schaffen wir die bessere Lösung

DEMO GmbH u. Co. KG Eisengießerei Ihre CERATIZIT Ansprechpartner

Muster-Str. 15
80331 München

Ing. Daniel Huter - Projektleiter
Tel: +43 5672 200 2980
daniel.huter@ceratizit.com

Max Mustermann
Tel: +49 0916 200 33
max.mustermann@demo-muc.de

Markt:
Tel: +
m. br

Projekt DEMO - LKW Brem
D-000244 143775 0035 01 40

Machining study

CERATIZIT
CUTTING SOLUTIONS BY CERATIZIT

Projekt LKW Vorderachs-Bremsscheibe
O-000244 / 143775 Datum: 23.01.2018

DEMO GmbH u. Co. KG Eisengießerei
Muster-Str. 15 - 80331 München

Werkzeuge (zusammengebaut) Werkstück 1 DVT 5005B

Zusammengesetztes Werkzeug		Werkzeug-Elemente										Eingewetzt bei (Mechanisch Aufsp. [h])
Nr.	Bezeichnung	Kunden-Nr.	Bestellnummer	CERATIZIT Nr.	Kunden-Nr.	Bezeichnung	Ø	L	D	Stk	in	
PG-011	DP1008 - Station 1		SMER 120787N-0200-C-CT030 B5	1011130		SK Keramik Drehwendplatte	1	1,8	Ø	10		[31-01-01]
			CS-020PW-0008-12-C-027	1011402		PS-30 Drehfräser C-Clamp	1	Ø	Ø	1		
PG-011	DP1008 - Station 3		SMER 120787N-0200-C-CT0100	1011131		SK Keramik Drehwendplatte (optional)	1	1,8	Ø	10		[31-01-02]
			CNER 120787N-0200-C-CT0100	1011112		SK Keramik Drehwendplatte	1	1,8	Ø	10		
PG-011	DP1008 - Station 5		SMER 120787N-0200-C-CT0100	1011131		SK Keramik Drehwendplatte (optional)	1	1,8	Ø	10		[31-01-02]
			CNER 120787N-0200-C-CT0100	1011112		SK Keramik Drehwendplatte	1	1,8	Ø	10		
PG-011	DP1008 - Station 6		SP-40-03	1011132		Spanenwerkzeug C-Clamp 2.0	1	Ø	Ø	4		[31-01-04]
			CA-DUAL 20048 12-C-027	1011137		Kassette für 1003 026	1	Ø	Ø	2		
PG-017	DP1008 - Station 7		CNER 120787N-0200-C-CT0100	1011112		SK Keramik Drehwendplatte	1	1,8	Ø	10		[31-01-04]
			CS-DUAL-0008 12-C-027	1011402		PS-30 Drehfräser C-Clamp 2.0	1	Ø	Ø	1		
PG-017	DP1008 - Station 8		CNER 120787N-0200-C-CT0100	1011112		SK Keramik Drehwendplatte (optional)	1	1,8	Ø	10		[31-01-04]
			CNER 120787N-0200-C-CT0100	1011112		SK Keramik Drehwendplatte	1	1,8	Ø	10		
TN-001	DP1008 - Station 1		SMER 120787N-0200-C-CT030 B5	1011130		SK Keramik Drehwendplatte	1	1,8	Ø	10		[31-01-01]
			DSBRP 2028 W12-C-027	1011131		Drehfräser C-Clamp 2.0	1	Ø	Ø	1		
TN-003	DP1008 - Station 2		SMER 120787N-0200-C-CT030 B5	1011130		SK Keramik Drehwendplatte	1	1,8	Ø	10		[31-01-02]
			DSFNL 2028 W12-C-027	1011131		Drehfräser C-Clamp 2.0	1	Ø	Ø	1		
TN-003	DP1008 - Station 3		SMER 120787N-0200-C-CT030 B5	1011130		SK Keramik Drehwendplatte	1	1,8	Ø	10		[31-01-02]
			DSBRP 2028 W12-C-027	1011131		Drehfräser C-Clamp 2.0	1	Ø	Ø	1		
TN-004	DP1008 - Station 4		SMER 120787N-0200-C-CT0100	1011131		SK Keramik Drehwendplatte (optional)	1	1,8	Ø	10		[31-01-04]
			SCFN 300487N-0100-CT0100	1011133		SK Schichtwendplatte	2	0,7	Ø	10		
TN-004	DP1008 - Station 5		SCFN 300487N-0100-CT0100	1011133		Spanenwerkzeug Schichtwendplatte	2	0,8	Ø	10		[31-01-04]
			SMER 120787N-0200-C-CT030 B5	1011130		SK Keramik Drehwendplatte	1	1,8	Ø	10		
TN-005	DP1008 - Station 6		DSFNL 2028 W12-C-027	1011131		Drehfräser C-Clamp 2.0	1	Ø	Ø	1		[31-01-04]
			C-00 MP168 1.0 ROCK DR074	22 173 0000		SK-E Drehfräskörper	1	Ø	Ø	1		

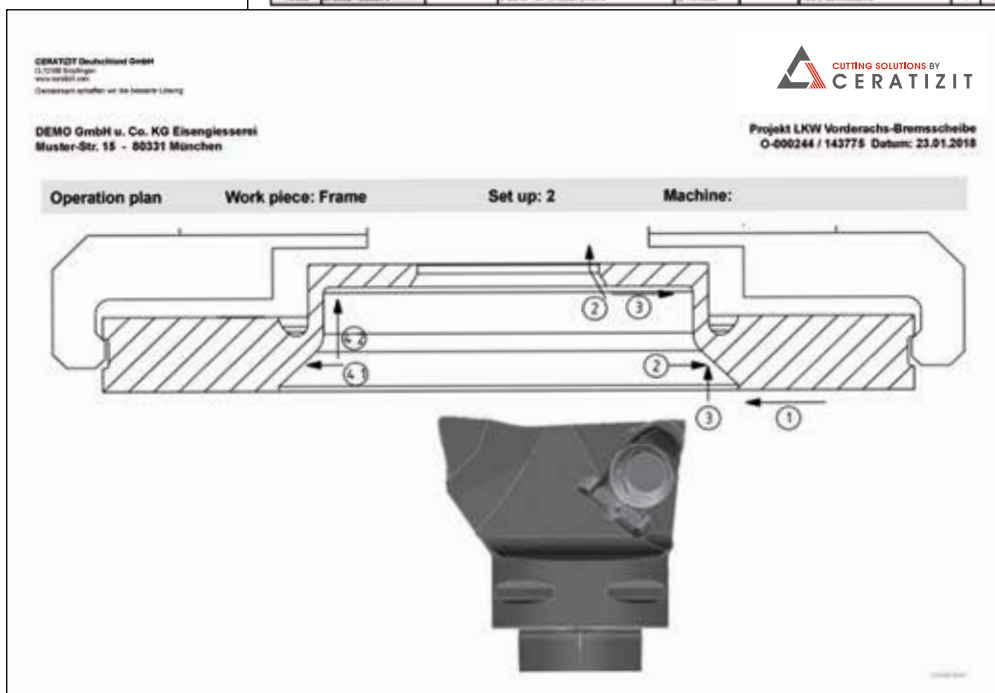

Machining plans

CERATIZIT Deutschland GmbH
D-17189 Ebersdorf
www.ceratizit.com
Gesamtwahl schaffen wir die bessere Lösung

DEMO GmbH u. Co. KG Eisengießerei
Muster-Str. 15 - 80331 München
Projekt O-0002

Werkzeugelement-Blatt C5-DCLNL-35060 1

Bezeichnung CERATIZIT
Maxilock D Capto

ISO_26623-1-PSC-50

60
35
15.6

Stückliste

Seite 1 von 8

CERATIZIT Deutschland GmbH
D-17189 Ebersdorf
www.ceratizit.com
Gesamtwahl schaffen wir die bessere Lösung

DEMO GmbH u. Co. KG Eisengießerei
Muster-Str. 15 - 80331 München
Projekt LKW Vorderachs-Bremsscheibe
O-000244 / 143775 Datum: 23.01.2018

Werkzeugelement-Blatt C5-DSDNN-00060-12-C207

Bezeichnung CERATIZIT Mat. Kunden-Id-Nr.

ISO_26623-1-PSC-50

60
0

Stückliste

CERATIZIT Deutschland GmbH
D-17189 Ebersdorf
www.ceratizit.com
Gesamtwahl schaffen wir die bessere Lösung

Projekt LKW Vorderachs-Bremsscheibe
O-000244 / 143775 Datum: 23.01.2018

D-10889_VDI-50

CERATIZIT Mat. Kunden-Id-Nr.

43.5
34.8
6
74
80

Stückliste

Tool documentation

CERATIZIT Deutschland GmbH
D-17189 Ebersdorf
www.ceratizit.com
Gesamtwahl schaffen wir die bessere Lösung

Power Calculation - Milling

Workpiece	Housing	Date: 06.08.17
Operation	Face milling	Name: Alfred Hölzger
Tool	AHFC.52.RL.05-12	
Insert	XCLX 1254105R M50 CTPP238	

Workpiece material	Description of Material	42CrMo4	600	Mk6
	Tensile Strength / Hardness	600		
	Reference Material	42CrMo4 - S27 Anneal		
	Specific Cutting Force	K _{1c} = 1747	Normal	
	Exponent of Chip Thickness	n = 0.24		
Tool	Tool Diameter	D = 52.00	mm	
	Number of Teeth	Z = 5	zeta	
	Angle of Approach	α = 10	°	
	Rake angle	γ ₀ = 12	°	
	Depth of Cut	a _p = 1.4	mm	
Cutting Conditions	Dimension U ₁	U ₁ = 52.00	mm	
	Feed per Tooth	f = 0.20	mm	
	Angle of Cutting Curve	α = 195.0	°	
	Depth of Cut	a _p = 1.4	mm	
	Medium Chip Thickness	h _{0.5} = 0.133	mm	
Compensation Factors	Compensation Factor of Rake Angle	K _{1α} = 0.73		
	Compensation Factor of α ₀	K _{1α0} = 0.90		
	Compensation Factor of Cutting Material	K _{1M} = 1.00		
	Compensation Factor of Wear	K _{1W} = 1.00		
Power Results	Cutting Force per Tooth	F _{0.5} = 2287	N	
	Number of teeth engaged	Z _{0.5} = 3	zeta	
	Total Cutting Force	F _{0.5} = 6861	N	
Productivity	Cutting performance	P _{0.5} = 22.87	mm³/min	
	Normal	M _{0.5} = 264	mm³/min	
	Spindle revs	n = 1224	rpm	
	Table feed	v _f = 8370	mm/min	
	Metal removal rate	Q (200%) = 891	cm³/min	

Calculation of cutting force and performance

Speak to us about new machines, new tools or process optimisation:

together we will create a better solution.



Industry solutions & technical manuals

Changed markets, new technologies and the development of complex materials mean that whole segments of industry are faced with major challenges – from the automotive industry and the energy sector to aviation and aerospace. As a creative and competent partner, we will work with you to develop sector-specific applications and individual solutions. Information on the individual segments, including detailed technical information, grade descriptions, cutting data, valuable application tips and correct usage data can be found in the Technical Manuals.



Download from
www.ceratzit.com

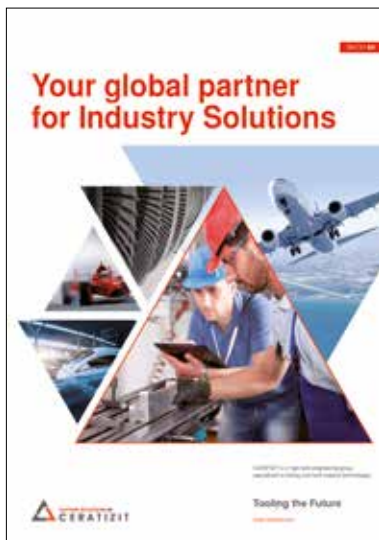

CatalogueNo. 705 Industry Solutions



CatalogueNo. 702 Technical Manual - Heavy machining



CatalogueNo. 679 Technical Manual - Bar Peeling

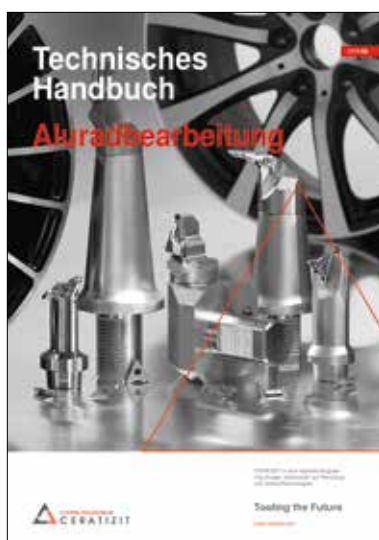

CatalogueNo. 717 Technical Manual - Aluminium Wheel Machining

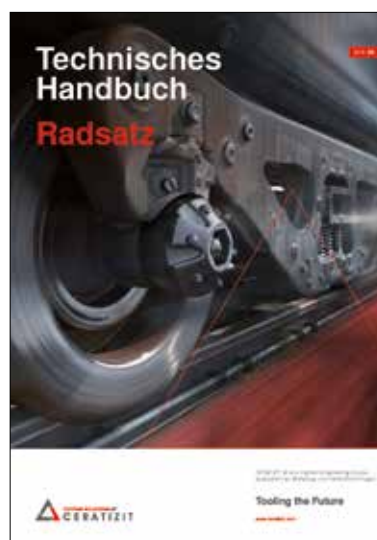

CatalogueNo. 668 Technical Manual - Wheelset



CatalogueNo. 667 Technical Manual - Hard Machining with PCBN

Notes

Notes

Headquarters:

CERATIZIT S.A.
LU-8232 Mamer
T. +352 31 20 85-1
E. info@ceratizit.com

www.ceratizit.com

Austria

CERATIZIT Austria GmbH
AT-6600 Reutte
T. +43 5672 200-0
E. info.austria@ceratizit.com

Brazil

CERATIZIT América Latina Ltda.
BR-06453-002 Barueri, São Paulo
T. +55 11 4133 2300
E. info.americalatina@ceratizit.com

Bulgaria

CERATIZIT Bulgaria AG
BG-5301 Gabrovo
T. +359 66 812 206
E. info.bulgaria@ceratizit.com

China

CB-CERATIZIT Tianjin
CN-300384 Tianjin
T. +86 22 5810 7000

Czech Republic / Slovak Republic

CERATIZIT Office Czech Republic
CZ-594 01 Velké Meziříčí
T. +420 566 520 341
E. info.czechrepublic@ceratizit.com

France / Luxembourg / Belgium

CERATIZIT Luxembourg S.à r.l.
LU-8232 Mamer
T. +352 31 20 85-1
E. info@ceratizit.com

Germany

CERATIZIT Deutschland GmbH
DE-72186 Empfingen
T. +49 7485 99802 0
E. info.deutschland@ceratizit.com

United Kingdom / Ireland

CERATIZIT Office UK
UK-Sheffield S9 1XU
Toll Free 0800 048 4877
T. +44 1925 261 161
E. info.uk@ceratizit.com

Hungary

CERATIZIT Office Hungary
HU-1138 Budapest
T. +36 1 437 0930
E. info.hungary@ceratizit.com

India

CERATIZIT India Pvt. Ltd.
IN-Bengaluru 560099
T. +91 80 4043 1262
E. ctindia.south@ceratizit.com

CERATIZIT India Pvt. Ltd.
IN-Chennai 600037
T. +91 44 4269 4350
E. ctindia.south@ceratizit.com

CERATIZIT India Pvt. Ltd.
IN-Coimbatore 641009
T. +91 4224 273 373
E. ctindia.south@ceratizit.com

CERATIZIT India Pvt. Ltd.
IN-Gurgaon 122002
T. +91 124 4018 481
E. ctindia.north@ceratizit.com

CERATIZIT India Pvt. Ltd.
IN-Pune 411018
T. +91 20 6529 0628
E. ctindia.west@ceratizit.com

Indonesia

CB-CERATIZIT Indonesia
ID-17530 Bekasi
T. +62-21-2961-2351

Italy

CERATIZIT Italia S.p.A.
IT-22040 Alserio (CO)
T. +39 031 6349 211
E. info.italia@ceratizit.com

Mexico

CERATIZIT México, S.A. de C.V.
MX-76040 Querétaro, QRO
T. +52 442 225 9173
E. info.mexico@ceratizit.com

Netherlands

CERATIZIT Nederland B.V.
NL-4707 AT Roosendaal
T. +31 165 55 08 00
E. info.nederland@ceratizit.com

Poland

CERATIZIT Office Poland
PL-30-443 Kraków
T. +48 12 252 8591
E. info.polska@ceratizit.com

Spain / Portugal

CERATIZIT Ibérica S.L.
ES-28031 Madrid
T. +34 91 351 0609
E. info.iberica@ceratizit.com

Taiwan

CB-CERATIZIT Tamsui
TW-25152-Tamsui
T. +886 2 2622 1668

Turkey

CERATIZIT Turkey
TR-34870 Kartal, Istanbul
T. +90 216 353 66 43
E. info.turkey@ceratizit.com

USA / Canada

CERATIZIT USA, Inc.
US-Warren, MI 48089-1833
Toll free +1-800-783-2280
T. +1-586-759-2280
E. info.usa@ceratizit.com