

BAR PEELING

Technical Manual



TEAM CUTTING TOOLS



CERATIZIT is a high-technology engineering group specialised in cutting tools and hard material solutions.

Tooling the Future

www.ceratizit.com



Industry Solutions

Industry-specific applications and bespoke solutions

Every sector has its own specific requirements. Tools and materials are expected to offer maximum cutting performance, wear resistance, precision and quality – from large-scale production to the manufacture of single parts. This applies to the machining of aluminium alloys, cast materials and high-alloy steel as well as super alloys and titanium. As such, almost every sector of industry is affected – from the automotive and heavy duty machining sectors to aerospace and energy technology.

As the leading supplier of solutions for numerous industry-specific applications, we draw upon our wide-ranging expertise to offer you first-class advice and support. Whatever you need, we will work with you to find a successful, innovative solution to optimise your production process.



As our customer, you will benefit from one of the largest ranges on the market, an efficient sales operation and our leading expertise worldwide!

Team Cutting Tools from the CERATIZIT Group

The full-service provider in the machining sector

Team Cutting Tools from the CERATIZIT Group is your gateway to leading international experts in machining solutions.

We are masters of the carbide production process, from the powder to the finished cutting tool. Not only does this allow us to develop special-purpose tools for customer-specific applications, it also means we can draw upon a full range of sector-specific standard tools, which are kept in stock and are available immediately.

We are experts at developing solutions, including the ability to analyse and optimise existing processes. And there is one thing that will never change – direct contact with our customers – thanks to streamlined structures and personal contacts.

- ▲ Uniquely extensive expertise in the field of machining
- ▲ One of the most extensive ranges on the market – from standard and semi-standard tools to special-purpose tools.
- ▲ Best-in-class R&D, sales and customer service
- ▲ Leading expertise in future technologies such as digitalisation and innovative production processes
- ▲ Many years of in-depth experience in various industry segments
- ▲ All under one roof the global CERATIZIT Group



> 9.000
employees



33
production facilities



> 1.000
patents

Bar peeling

Our solutions for the entire process

For the bar peeling application range we offer machining solutions that guarantee high process security, optimum surface quality and maximum machining rates.

Use our user manual to find out more about the particular challenges and options for bar peeling. Find out more about the specific process and our cutting material solutions which cover the entire range of requirements. Experience gained in bar peeling with CERATIZIT tools speaks for itself. Our practical examples will inspire you

Technical information

Bar peeling	→ page 9
Our solutions for the entire application range	→ pages 10–11
The bar peeling process	→ pages 12–13
Comparison tables for materials	→ pages 14–17
Cutting materials	→ pages 18–23
Dragonskin	→ pages 24–25
Application examples	→ pages 26–31
Influencing factors and selection of the correct indexable insert	→ page 32
Support chamfers	→ pages 33–35
Peeling inserts – product range	→ pages 36–37
Solutions for super alloys and titanium	→ pages 38–39
Hexagonal roughing inserts	→ pages 40–41
Peeling inserts for roughing	→ pages 42–43
Peeling inserts for roughing and finishing	→ pages 44–45
Peeling inserts for finishing	→ pages 46–47
Hexagonal roughing inserts HNMJ 131050, HNMH/J 221550 and HNMH/J 281850	→ pages 48–49
Tool holders and cartridges	→ pages 50–51
Different clamping methods	→ pages 52–53
Use of carbide shims	→ page 54
Precise setting of the tool holders	→ page 55
Surface quality	→ page 56
Productivity and efficiency	→ page 57
Machining examples	→ page 58
Bar peeling formulae	→ page 59
Troubleshooting guide for turning	→ page 60
Troubleshooting guide for bar peeling	→ page 61
Causes and types of wear	→ pages 62–64



Indexable inserts – product range

- Designation system for indexable inserts → pages 66–67
- Indexable insert range for external peeling → pages 68–108
- Indexable insert range for internal peeling → pages 109–112

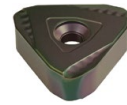

Tools – product range

- Designation system for tools and cartridges → pages 114–115
- Single cartridges → pages 116–119
- Tandem cartridges → pages 120–125

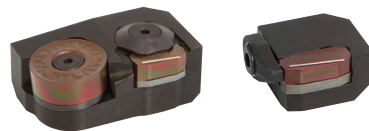

Spare parts

- Screws, claws → pages 126
- Shims → pages 127



Peeling heads and accessories

- Peeling heads for bars, spare parts → pages 129–130
- Clamping and guide components → pages 131
- Tools and indexable inserts for bar end machining → pages 132–133

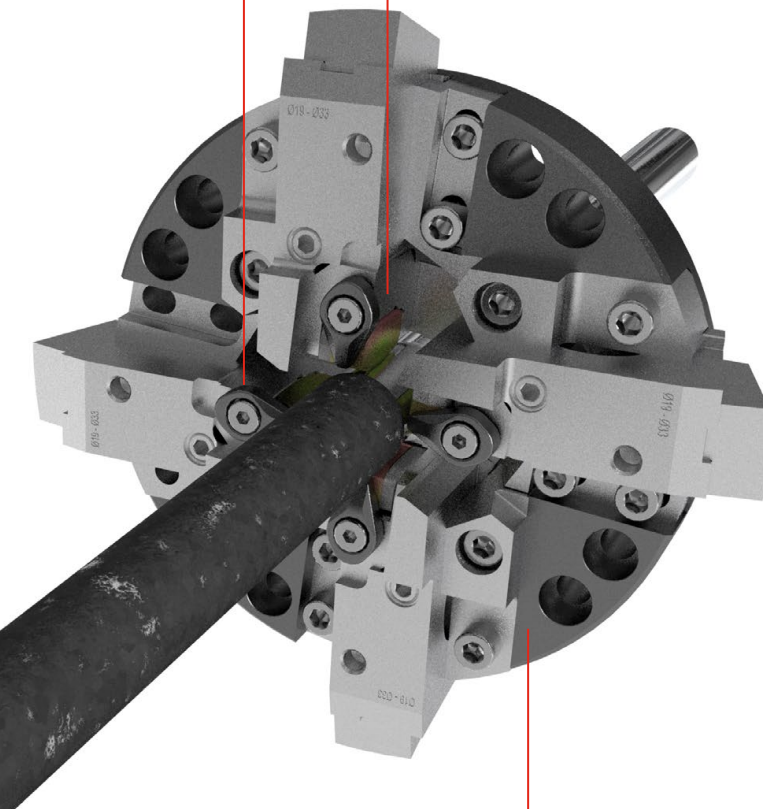

Our service – your competitive advantage

Take advantage of our customer-specific services that truly make the difference

Do you want to be one of the players setting the pace on the international market? With Team Cutting Tools from CERATIZIT as your expert partner, you can. In addition to the latest technological standards, innovative materials and coatings, as well as unique special tools for bar peeling, you can benefit from our highly attractive, comprehensive range of services.

Our trend-setting offers explicitly target manufacturers of bright steel and are individually tailored to each customer's objectives – a unique offer that gives you a decisive competitive advantage. See for yourself with our services that take your processes to a completely new level and assist you significantly in addressing your challenges.

Your expert local partner

An application engineer is always available by phone to answer your application-specific questions. Even if they are not on-site with you, our experts are always ready to answer your questions.



Customised tool solutions

We adapt standard tools and develop special tools or complete tool concepts together with you.

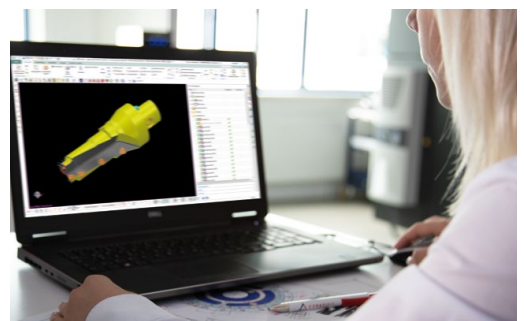

State-of-the-art with technical training

Our engineers are provided with constant training to keep them up to speed on all technical matters. You can also use our service to train your employees on-site.



Full process control with ToolScope

With the ToolScope monitoring and control system, we have paved the way for the digital future of machining. The system continuously records signals from the machine during the production process and monitors factors such as tool wear. This guarantees maximum process control.

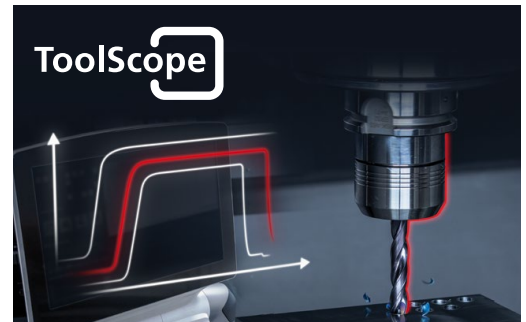

24-hour ordering from the online shop

Optimum filter options guarantee a quick tool search. Your personalised customer account with condition details, order history, personal customer discounts and order authorisation assignments ensures that the ordering process is convenient and easy.



Innovative tool procurement

By using the Tool-O-Mat, you benefit from 100% availability of all tools at all times and at no extra cost.



Environmentally friendly, sustainable and cost-effective

Certified recycling of high quality carbide.



For more information about our services, visit our website or ask your personal contact.

cuttingtools.ceratizit.com

Always the best quality

CERATIZIT is a quality leader that unites all the process knowledge and extensive manufacturing expertise of the CERATIZIT Group.

- ▲ Highly qualified, trained experts in a wide range of areas.
- ▲ We control each individual production step.
- ▲ Our modern fleet of machinery is constantly being expanded and improved.
- ▲ Optimised production processes reduce process costs and ensure that our products are of the highest quality and environmentally friendly.
- ▲ Independently tested and certified products.

We cover the entire process chain

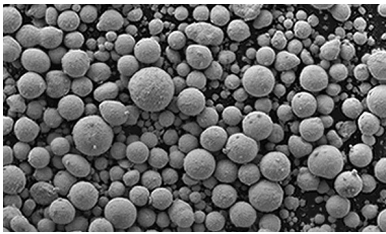

Preparing and mixing the raw materials

Powder preparation and manufacture of carbide grades, quality management and control.



Forming / pressing

All forming technologies are available (extrusion moulding, injection moulding, direct pressing, isostatic pressing, rotary pressing, manual profiling).



Sintering

Decades of experience in calculating exact sintering shrinkage to guarantee the high quality of the end product.

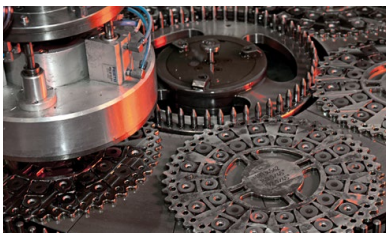

Grinding

Different techniques are available such as grinding, lapping, slide grinding, irradiating, brushing.



Coating

State-of-the-art coating technologies, CVD and PVD, as well as post-treatment processes for best surface quality.

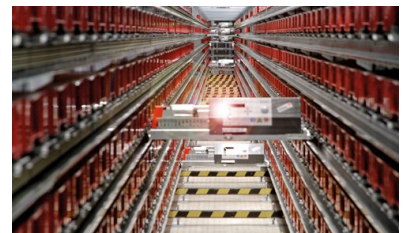

Dispatch

Fully automatic High-Tech-Shuttle warehouse.



Recycling (optional)

We organise the entire process for you and also provide free, quantity-specific collection containers and transport solutions.

Bar peeling

CERATIZIT cutting solutions guarantee high process reliability, best surface quality and maximal metal removal rates

For over 50 years, CERATIZIT has been supplying cutting tools for bar peeling for the manufacture of bright steel products in different materials. We are constantly developing our tools and tool holders in order to meet your requirements and wishes. Our customers worldwide benefit from the following:

- ▲ State-of-the-art cutting material solutions and tool holders for all bar peeling applications
- ▲ Long service life with maximum process-security thanks to the use of tools from our comprehensive range of standard products
- ▲ Custom-made products and tool systems specifically tailored to your needs available on request

Our solutions for the entire application range

CERATIZIT experts specialising in bar peeling advise customers in the production of bright steel and help them select and use the right tools. Our range of advisory services and product range includes:

- ▲ Carbide peeling inserts
- ▲ Peeling heads, tool holders and peeling cartridges made of steel
- ▲ Guide elements for the infeed and outfeed areas of the peeling machine
- ▲ Milling tools for face milling and chamfering of the bar ends

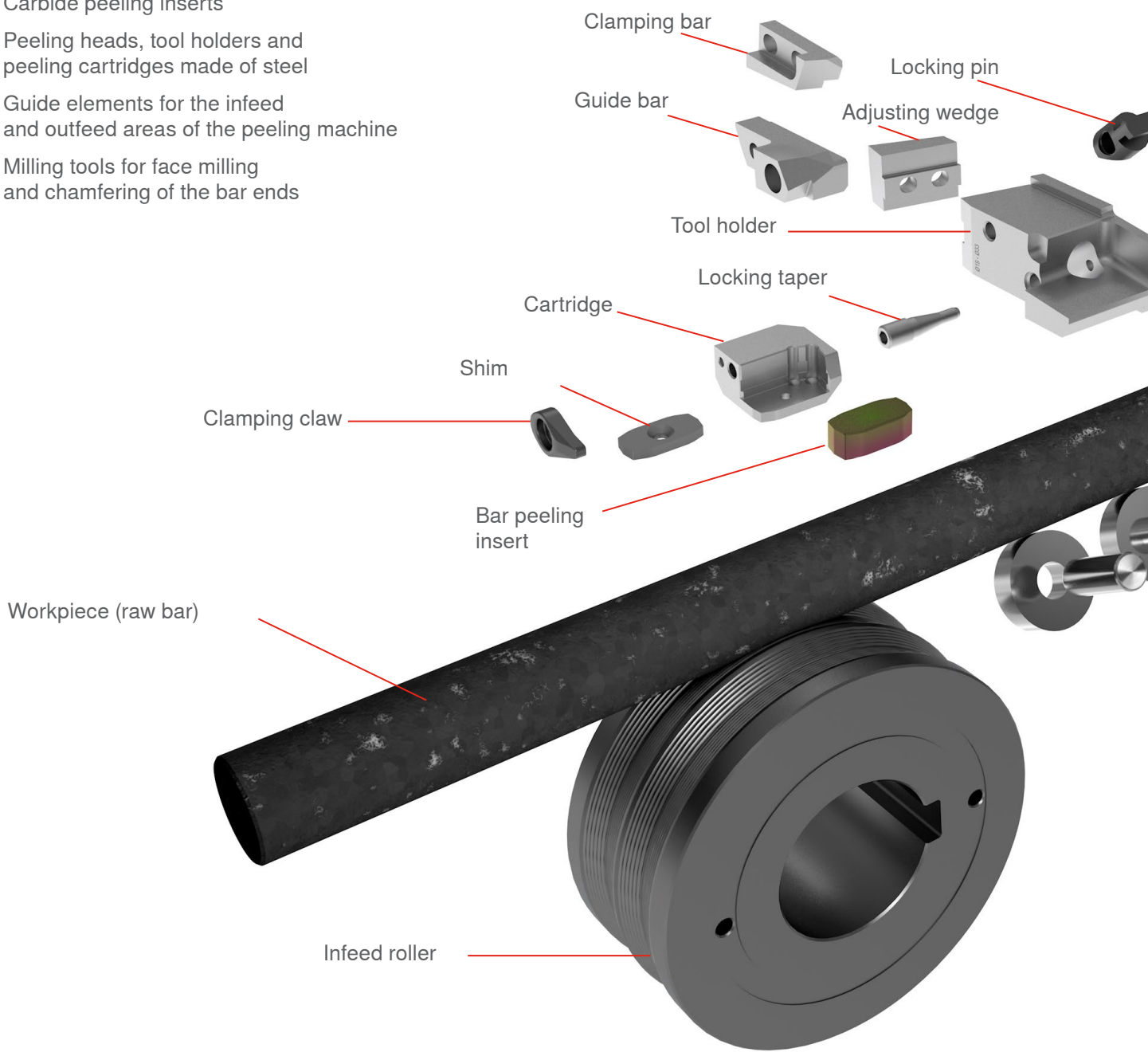

The bar peeling process is used to produce bright steel in all materials after a previous drawing, rolling or forging process and is divided into the following application ranges:

- ▲ External peeling of bars and pipes with diameters from 10 to 650 mm
- ▲ Wire peeling of coils with diameters from 5 to 20 mm
- ▲ Internal peeling of pipes for the hydraulic cylinder industry with diameters from 35 to is 300 mm
- ▲ Peeling of conical rods for spring production in the automotive industry

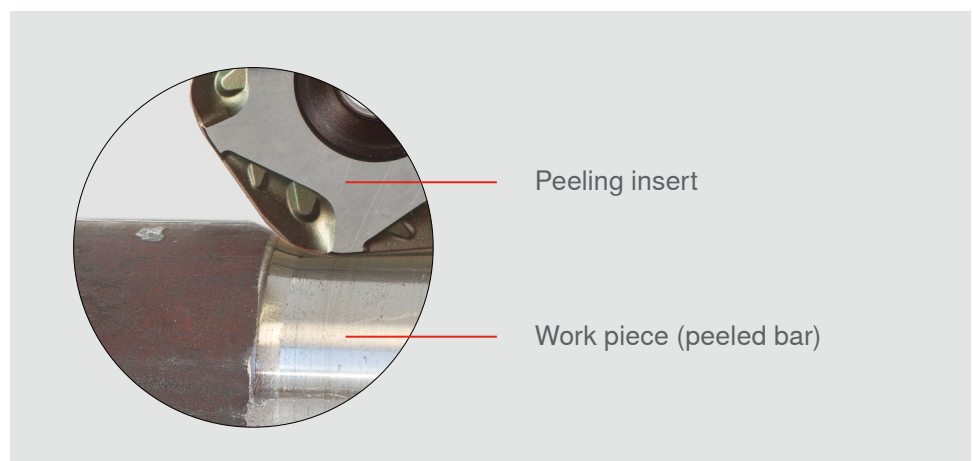
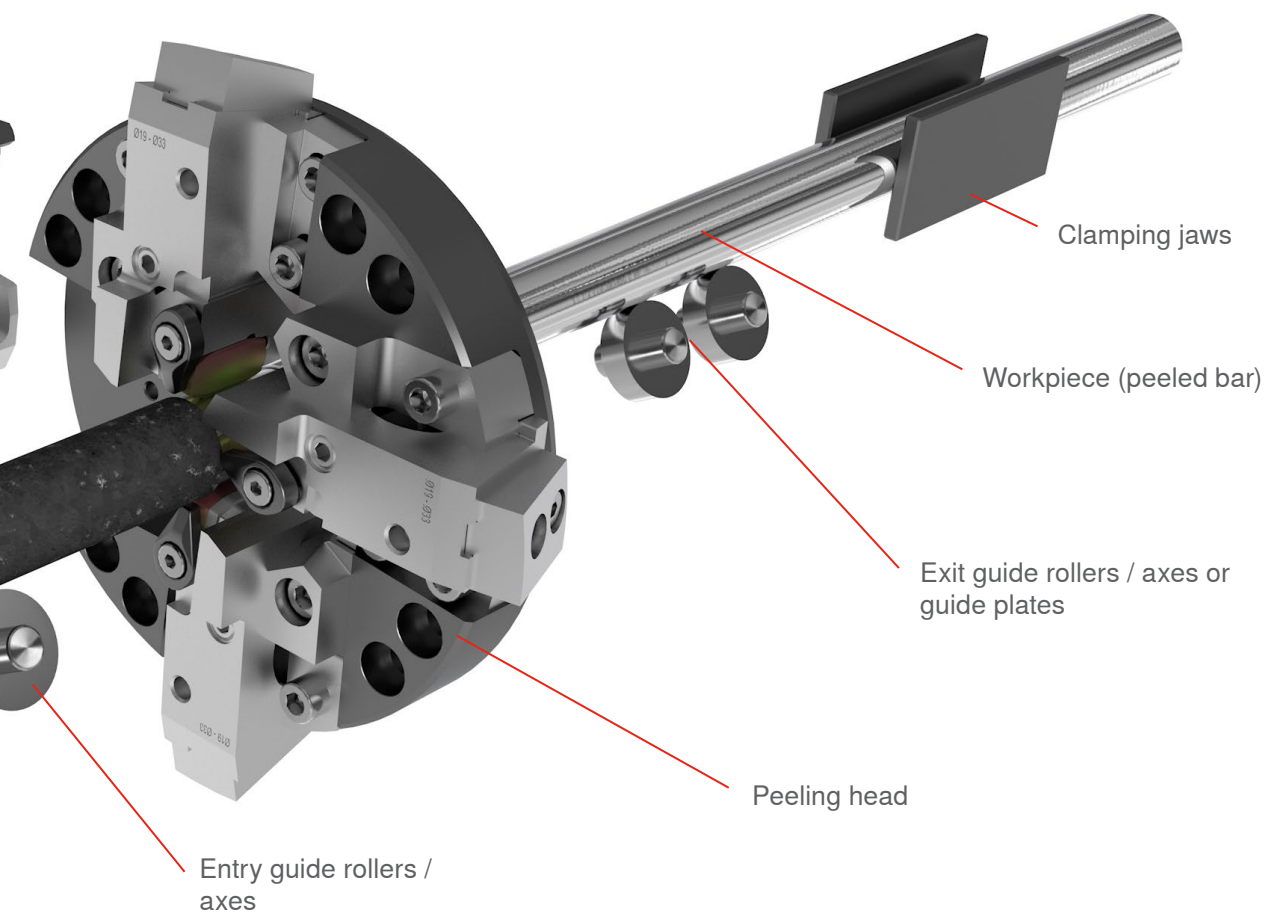

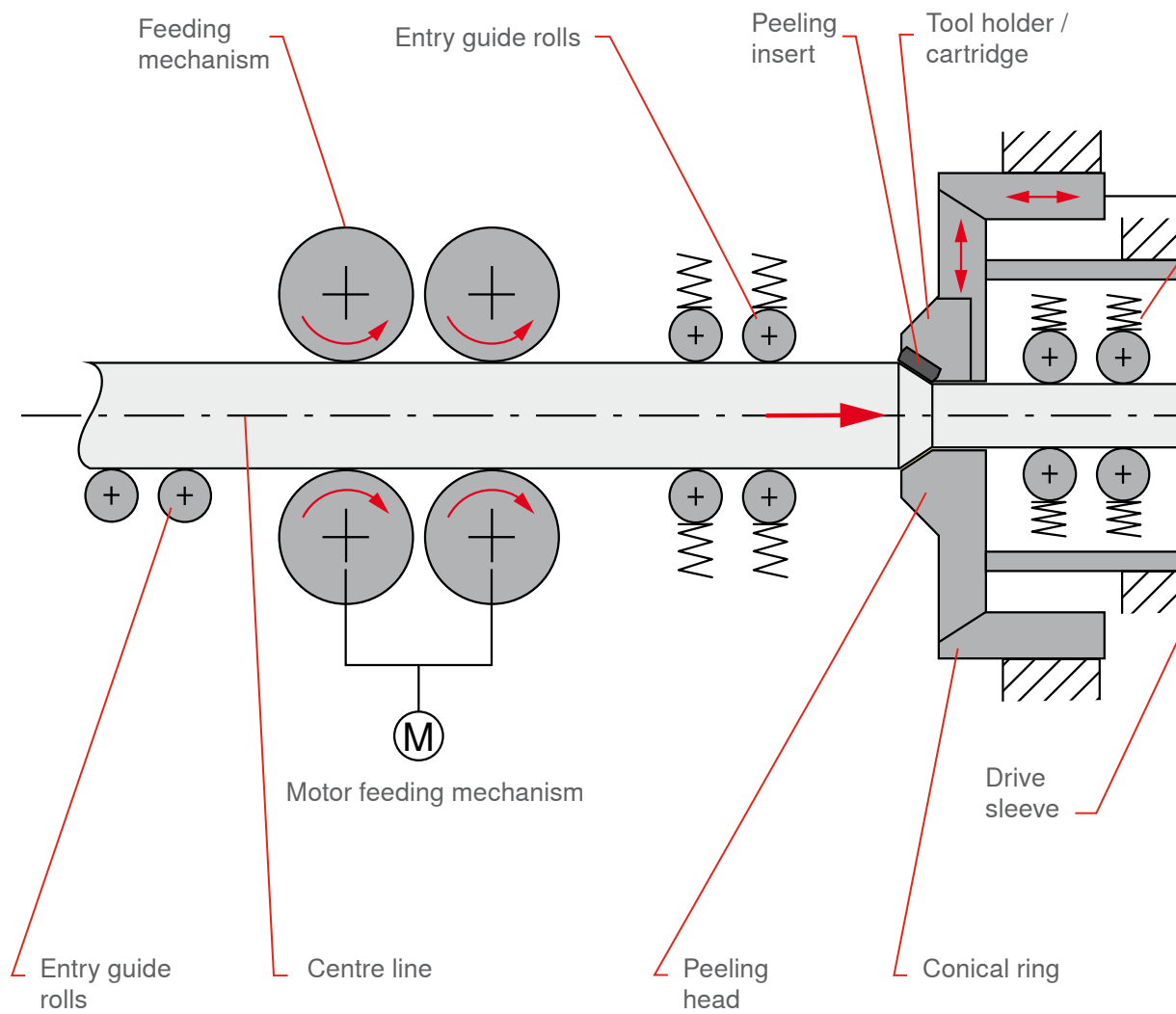
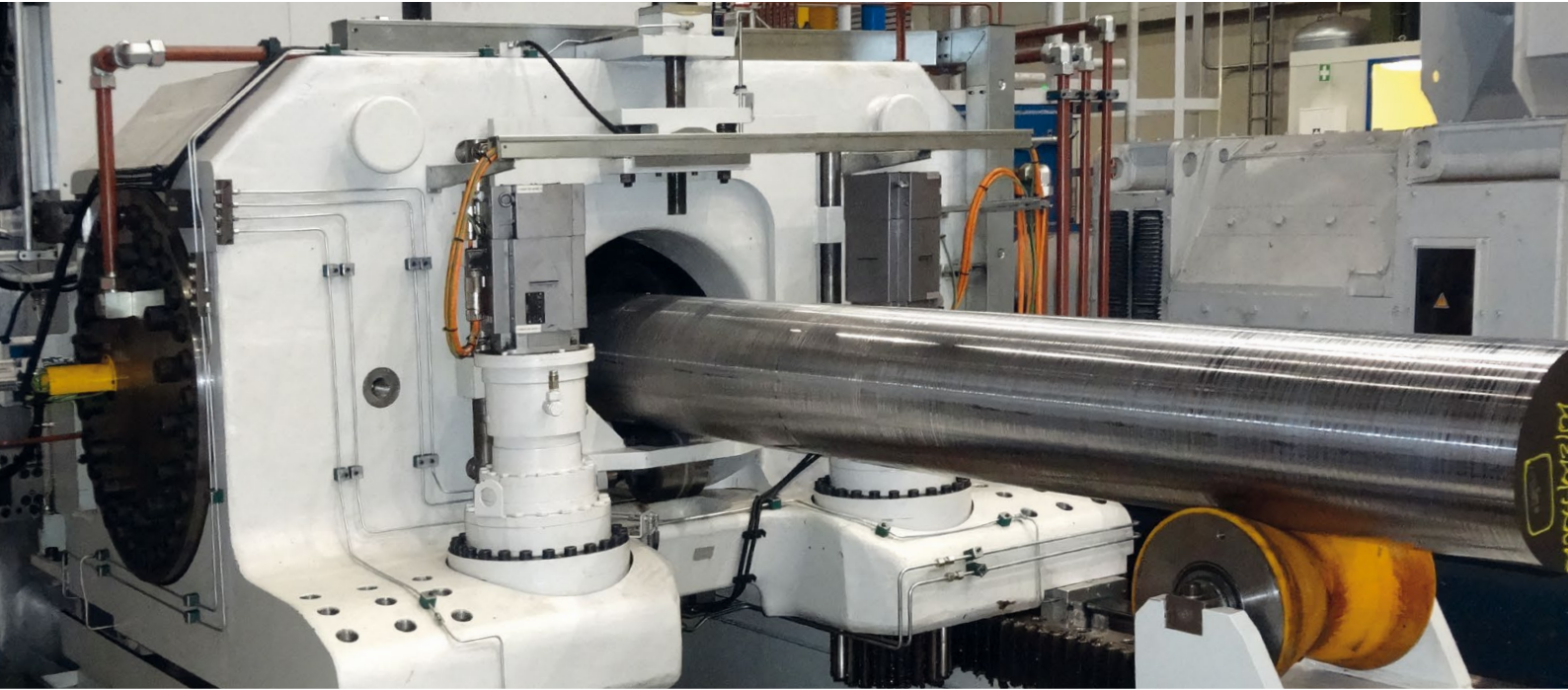

Bar peeling – the process

Bar peeling gives bars and tubes in various materials (carbon) steel, spring steel, stainless steel, nickel-based alloy, titanium, aluminium) the requisite surface quality and dimensional and form accuracy. In the peeling process work pieces with diameters from 6 to 650 mm (in many cases rough forged, but also rolled or drawn) are machined to produce a bright smooth surface while eliminating ruptures caused during the forging and rolling process.

This heavy machining process is seen as very productive and efficient, but at the same time particularly challenging for the tools and machines. Due to the considerably reduced throughput times compared to the conventional turning process, and the excellent result the bright steel products show in terms of surface quality and dimensional accuracy, costs and outlay are reduced in the final machining of these semi-finished products.

Schematic diagram of a bar peeling machine

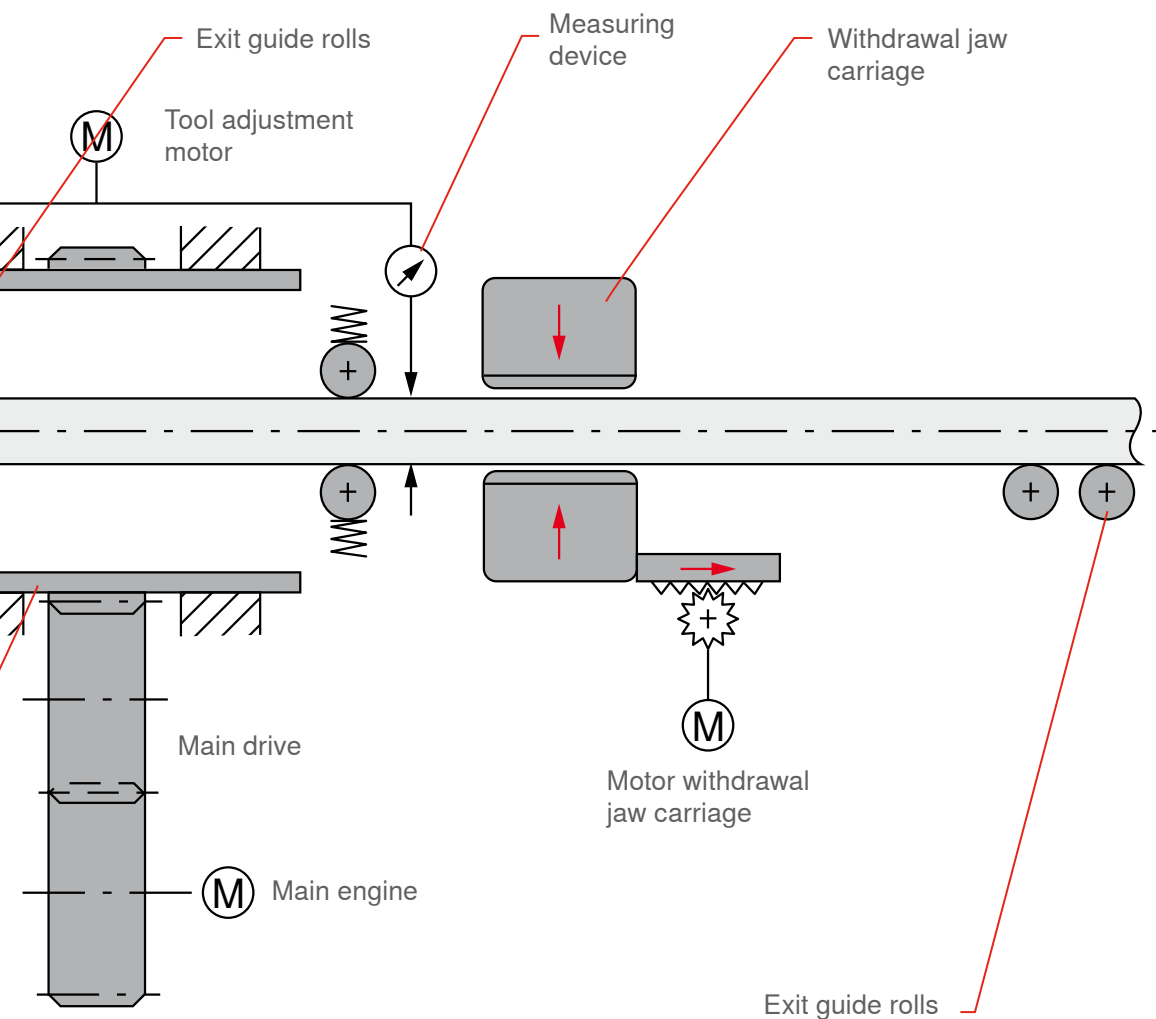

Materials Table

DIN	WKS no.	BS	AFNOR	SS	AISI	Japan JIS	Kc1.1 N/mm ²	mc	VDI 3323 Group
10 SPb 20	1.0722		10 PbF 2		11 L 08		1350	0.20	1
100 Cr 6	1.2067	BL 3	Y 100 C 6		L 3	SUJ2	1775	0.24	6/9
105 WCr 6	1.2419		105 WC 13			SKS31	1775	0.24	6/9
12 CrMo 9 10	1.7380	1501-622 Gr. 31; 45	10 CD 9.10	2218	A 182-F22	SPVA,SCMV4	1675	0.24	6/7
12 Ni 19	1.5680		Z 18 N 5		2515		2450	0.23	10/11
13 CrMo 4 4	1.7335	1501-620 Gr. 27	15 CD 3.5	2216	A 182-F11; F12	SPVAF12	1675	0.24	6/7
14 MoV 6 3	1.7715	1503-660-440					1675	0.24	6/7
14 Ni 6	1.5622		16 N 6		A 350-LF 5		1675	0.24	6/7
14 NiCr 10	1.5732		14 NC 11		3415	SNC415(H)	1675	0.24	6/7
14 NiCr 14	1.5752	655 M 13	12 NC 15		3310; 9314	SNC815(H)	1675	0.24	6/7
14 NiCrMo 13 4	1.6657						1675	0.24	6/7
15 Cr 3	1.7015	523 M 15	12 C 3		5015		1675	0.24	6/7
15 CrMo 5	1.7262		12 CD 4			SCM415(H)	1675	0.24	6/7
15 Mo 3	1.5415	1501-240	15 D 3	2912	A 204 Gr. A		1675	0.24	6/7
16 MnCr 5	1.7131	527 M 17	16 MC 5	2511	5115	SCR415	1675	0.24	6/7
16 Mo 5	1.5423	1503-245-420			4520	SB450M	1675	0.24	6/7
17 CrNiMo 6	1.6587	820 A 16	18 NCD 6				1675	0.24	6/7
21 NiCrMo 2	1.6523	805 M 20	20 NCD 2	2506	8620	SNCM220(H)	1725	0.24	6/8
25 CrMo 4	1.7218	1717 CDS 110	25 CD 4 S	2225	4130	SM420;SCM430	1725	0.24	6/8
28 Mn 6	1.1170	150 M 28	20 M 5		1330		1500	0.22	2
32 CrMo 12	1.7361	722 M 24	30 CD 12	2240			1775	0.24	6/9
34 Cr 4	1.7033	530 A 32	32 C 4		5132	SCR430(H)	1725	0.24	6/8
34 CrMo 4	1.7220	708 A 37	35 CD 4	2234	4135; 4137	SCM432;SCCRM3	1775	0.24	6/9
34 CrNiMo 6	1.6582	817 M 40	35 NCD 6	2541	4340	SNCM447	1775	0.24	6/9
35 S 20	1.0726	212 M 36	35 MF 4	1957	1140		1525	0.22	2/3
36 CrNiMo 4	1.6511	816 M 40	40 NCD 3		9840	SNCM447	1775	0.24	6/9
36 Mn 5	1.1167						1525	0.22	2/3
36 NiCr 6	1.5710	640 A 35	35 NC 6		3135	SNC236	1800	0.24	3/9
38 MnSi 4	1.5120						1800	0.24	3/9
39 CrMoV 13 9	1.8523	897 M 39					1775	0.24	6/9
40 Mn 4	1.1157	150 M 36	35 M 5		1039		1525	0.22	2/3
40 NiCrMo 2 2	1.6546	311-Type 7	40 NCD 2		8740	SNCM240	1775	0.24	6/9
41 Cr 4	1.7035	530 M 40	42 C 4		5140	SCR440(H)	1775	0.24	6/9
41 CrAlMo 7	1.8509	905 M 39	40 CAD 6.12	2940	A 355 Cl. A	SACM645	1775	0.24	6/9
41 CrMo 4	1.7223	708 M 40	42 CD 4 TS	2244	4142; 4140	SCM440	1775	0.24	6/9
42 Cr 4	1.7045	530 A 40	42 C 4 TS	2245	5140	Scr440	1775	0.24	6/9
42 CrMo 4	1.7225	708 M 40	42 CD 4	2244	4142; 4140	SCM440(H)	1775	0.24	6/9
45 WCrV 7	1.2542	BS 1		2710	S 1		1775	0.24	6/9
50 CrV 4	1.8159	735 A 50	50 CV 4	2230	6150	SUP10	1775	0.24	6/9
55 Cr 3	1.7176	527 A 60	55 C 3	2253	5155	SUP9(A)	1775	0.24	6/9
55 NiCrMoV 6	1.2713		55 NCDV 7		L 6	SKH1;SKT4	1775	0.24	6/9
55 Si 7	1.0904	250 A 53	55 S 7	2085; 2090	9255		1775	0.24	6/9
58 CrV 4	1.8161						1775	0.24	6/9
60 SiCr 7	1.0961		60 SC 7		9262		1775	0.24	6/9
9 SMn 28	1.0715	230 M 07	S 250	1912	1213	SUM22	1350	0.21	1
9 SMn 36	1.0736	240 M 07	S 300		1215		1350	0.21	1
9 SMnPb 28	1.0718		S 250 Pb	1914	12 L 13	SUM22L	1350	0.21	1
9 SMnPb 36	1.0737		S 300 Pb	1926	12 L 14		1350	0.21	1
Al99	3.0205						700	0.25	21
AlCuMg1	3.1325						700	0.25	22
AlMg1	3.3315						700	0.25	21
AlMgSi1	3.2315						700	0.25	22
C 105 W1	1.1545		Y1 105	1880	W 110	SK3	1675	0.24	3
C 125 W	1.1663		Y2 120		W 112		1675	0.24	3
C 15	1.0401	080 M 15	AF3 7 C 12; XC 18	1350	1015	S15C	1350	0.21	1
C 22	1.0402	050 A 20	AF 42 C 20	1450	1020	S20C, S22C	1350	0.21	1
C 35	1.0501	060 A 35	AF 55 C 35	1550	1035	S35C	1525	0.22	2/3
C 45	1.0503	080 M 46	AF 65 C 45	1650	1045	S45C	1525	0.22	2/3
C 55	1.0535	070 M 55		1655	1055	S55C	1675	0.24	3
C 60	1.0601	080 A 62	CC 55		1060	S60C	1675	0.24	3
Cf 35	1.1183					S35C	1525	0.22	2/3
Cf 53	1.1213					S50C	1525	0.22	2/3
Ck 101	1.1274	060 A 96		1870	1095		1675	0.24	3
Ck 15	1.1141	080 M 15	XC 15; XC 18	1370	1015	S15C	1350	0.21	1

Materials Table

DIN	Wks no.	BS	AFNOR	SS	AISI	Japan JIS	Kc1.1 N/mm ²	mc	VDI 3323 Group
Ck 55	1.1203	070 M 55	XC 55		1055	S55C	1675	0.24	3
Ck 60	1.1221	080 A 62	XC 60	1665; 1678	1060	S58C	1675	0.24	3
CoCr20W15Ni	2.4764						3300	0.24	35
CuZn15	2.0240						700	0.27	27
CuZn36Pb3	2.0375						700	0.27	26
E-Cu57	2.0060						700	0.27	28
G-AISI10Mg	3.2381						700	0.25	24
G-AISI12	3.2581						700	0.25	23
G-AISI9Cu3	3.2163						700	0.25	23
G-CuSn5ZnPb	2.1096						700	0.27	26
G-CuZn40Fe	2.0590						700	0.27	28
G-X 120 Mn 12	1.3401	Z 120 M 12	Z 120 M 12		A 128 (A)		3300	0.24	35
G-X 20 Cr 14	1.4027	420 C 29	Z 20 C 13 M			SCS2	1875	0.21	12/13
G-X 40 NiCrSi 38 18	1.4865	330 C 40					2600	0.24	31
G-X 45 CrSi 9 3	1.4718	401 S 45	Z 45 CS 9		HNV 3		2450	0.23	10/11
G-X 5 CrNi 13 4	1.4313	425 C 11	Z 5 CN 13.4	2385	CA 6-NM		1875	0.21	12/13
G-X 5 CrNiMoNb 18 10	1.4581	318 C 17	Z 4 CNDNb 18.12 M				2150	0.20	14
G-X 6 CrNi 18 9	1.4308	304 C 15	Z 6 CN 18.10 M	2333	CF-8		2150	0.20	14
G-X 6 CrNiMo 18 10	1.4408						2150	0.20	14
G-X 7 Cr 13	1.4001						1875	0.21	12/13
GG-10	0.6010		Ft 10 D	01 10-00	A48-20 B	FC100	1150	0.20	15
GG-15	0.6015	Grade 150	Ft 15 D	01 15-00	A48-25 B	FC150	1150	0.20	15
GG-20	0.6020	Grade 220	Ft 20 D	01 20-00	A48-30 B	FC200	1150	0.20	15
GG-25	0.6025	Grade 260	Ft 25 D	01 25-00	A48-40 B	FC250	1250	0.24	15/16
GG-30	0.6030	Grade 300	Ft 30 D	01 30-00	A48-45 B	FC300	1350	0.28	16
GG-35	0.6035	Grade 350	Ft 35 D	01 35-00	A48-50 B	FC350	1350	0.28	16
GG-40	0.6040	Grade 400	Ft 40 D	01 40-00	A48-60 B	FC400	1350	0.28	16
GGG-35.3	0.7033					FCD350	1225	0.25	17
GGG-40	0.7040	SNG 420/12	FGS 400-12	0717-02	60-40-18	FCD400	1225	0.25	17
GGG-40.3	0.7043	SNG 370/17	FGS 370-17	0717-15		FCD400	1225	0.25	17
GGG-50	0.7050	SNG 500/7	FGS 500-7	0727-02	65-45-12	FCD500	1350	0.28	18
GGG-60	0.7060	SNG 600/3	FGS 600-3	0732-03	80-55-06	FCD600	1350	0.28	18
GGG-70	0.7070	SNG 700/2	FGS 700-2	0737-01	100-70-03	FCD700	1350	0.28	18
GGG-NiCr 20 2	0.7660	S-NiCr 20 2	S-NC 20 2		A 439 Type D-2		1350	0.28	18
GGG-NiMn 13 7	0.7652	S-NiMn 13 7	S-NM 13 7				1350	0.28	18
GS-Ck 45	1.1191	080 M 46	XC 42	1672	1045	S45C	1525	0.22	2/3
GTS-35-10	0.8135	B 340/12	MN 35-10				1225	0.25	19
GTS-45-06	0.8145	P 440/7					1420	0.30	20
GTS-55-04	0.8155	P 510/4	MP 50-5				1420	0.30	20
GTS-65-02	0.8165	P 570/3	MP 60-3				1420	0.30	20
GTS-70-02	0.8170	P 690/2	IP 70-2				1420	0.30	20
NiCr20TiAl	2.4631	HR 401; 601	Nimonic 80 A				3300	0.24	33
NiCr22Mo9Nb	2.4856		Inconel 625				3300	0.24	33
NiCu30Al	2.4375		Monel K 500				3300	0.24	34
NiFe25Cr20NbTi	2.4955						3300	0.24	34
S 18-0-1	1.3355	BT 1	Z 80 WCV 18-04-01		T 1		2450	0.23	10/11
S 18-1-2-5	1.3255	BT 4	Z 80 WKCV 18-05-04-0		T 4		2450	0.23	10/11
S 2-9-2	1.3348		Z 100 DCWV 09-04-02-	2782	M 7		2450	0.23	10/11
S 6-5-2	1.3343	BM 2	Z 85 WDCV 06-05-04-0	2722	M 2	SKH9; SKH51	2450	0.23	10/11
S 6-5-2-5	1.3243		Z 85 WDKCV 06-05-05-	2723		SKH55	2450	0.23	10/11
TiAl6V4	3.7165	TA 10 bis TA 13	T-A 6 V				2110	0.22	37
X 10 Cr 13	1.4006	410 S 21	Z 12 C 13	2302	410; CA-15	SUS410	1875	0.21	12/13
X 10 CrNiMoNb 18 12	1.4583				318		2150	0.20	14
X 10 CrNiS 18 9	1.4305	303 S 21	Z 10 CNF 18.09	2346	303		2150	0.20	14
X 100 CrMoV 5 1	1.2363	BA 2	Z 100 CDV 5	2260	A 2		2450	0.23	10/11
X 12 CrMoS 17	1.4104		Z 10 CF 17	2383	430 F	SUS430F	1875	0.21	12/13
X 12 CrNi 17 7	1.4310	301 S 21	Z 12 CN 17.07		301		2150	0.20	14
X 12 CrNi 22 12	1.4829					SUS301	1350	0.28	16
X 12 CrNi 25 21	1.4845	310 S24	Z 12 CN 25.20	2361	310 S	SUH310; SUS310S	2150	0.20	14
X 12 CrNiTi 18 9	1.4878	321 S 20	Z 6 CNT 18.12 (B)	2337	321		2150	0.20	14
X 12 NiCrSi 36 16	1.4864	NA 17	Z 12 NCS 37.18		330	SUH330	2600	0.24	31
X 15 CrNiSi 20 12	1.4828	309 S 24	Z 15 CNS 20.12		309	SUH309	1350	0.28	16
X 165 CrMoV 12	1.2601			2310			2450	0.23	10/11
X 2 CrNiMo 18 13	1.4440						2150	0.20	14

Materials Table

DIN	Mat. no.	BS	AFNOR	SS	AISI	Japan JIS	Kc1.1 N/mm ²	mc	VDI 3323 Group
X 2 CrNiMoN 17 13 3	1.4429	316 S 62	Z 2 CND 17.13 Az	2375	316 LN	SUS316LN	2150	0.20	14
X 2 CrNiN 18 10	1.4311	304 S 62	Z 2 CN 18 .10	2371	304 LN	SUS304LN	2150	0.20	14
X 20 CrNi 17 2	1.4057	431 S 29	Z 15 CN 16.02	2321	431	SUS431	1875	0.21	12/13
X 210 Cr 12	1.2080	BD 3	Z 200 C 12		D 3		2450	0.23	10/11
X 210 CrW 12	1.2436			2312			2450	0.23	10/11
X 30 WCrV 9 3	1.2581	BH 21	Z 30 WCV 9		H 21	SKD5	2450	0.23	10/11
X 40 CrMoV 5 1	1.2344	BH 13	Z 40 CDV 5	2242	H 13	SKD61	2450	0.23	10/11
X 46 Cr 13	1.4034	420 S 45	Z 40 C 14				1875	0.21	12/13
X 5 CrNi 18 9	1.4301	304 S 15	Z 6 CN 18.09	2332; 2333	304; 304 H	SUS304	2150	0.20	14
X 5 CrNiMo 17 13 3	1.4436	316 S 16	Z 6 CND 17.12	2343	316	SUS316	2150	0.20	14
X 5 CrNiMo 18 10	1.4401	316 S 16	Z 6 CND 17.11	2347	316	SUS316	2150	0.20	14
X 53 CrMnNiN 21 9	1.4871	349 S 54	Z 52 CMN 21.09		EV 8		1875	0.21	12/13
X 6 Cr 13	1.4000	403 S 17	Z 6 C 13	2301	403	SUS403	1875	0.21	12/13
X 6 Cr 17	1.4016	430 S 15	Z 8 C 17	2320	430	SUS430	1875	0.21	12/13
X 6 CrMo 17	1.4113	434 S 17	Z 8 CD 17.01	2325	434	SUS434	1875	0.21	12/13
X 6 CrNiMoTi 17 12 2	1.4571	320 S 31	Z 6 CNT 17.12	2350	316 Ti		2150	0.20	14
X 6 CrNiNb 18 10	1.4550	347 S 17	Z 6 CNNb 18.10	2338	347		2150	0.20	14
X 6 CrNiTi 18 10	1.4541	321 S 12	Z 6 CNT 18.10	2337	321		2150	0.20	14
X2 CrNi 18-8	1.4317						2150	0.20	14

Hardness values

Tensile strength N/mm ²	Vickers HV	Brinell HB	Rockwell HRC	Shore C	Tensile strength N/mm ²	Vickers HV	Brinell HB	Rockwell HRC	Shore C
305	95	90			800	250	238	22.2	31
320	100	95			820	255	242	23.1	32
335	105	100			835	260	247	24	33
350	110	105			850	265	252	24.8	
370	115	109			865	270	257	25.6	
385	120	114			880	275	261	26.4	34
400	125	119			900	280	268	27.1	
415	130	124			915	285	271	27.8	35
430	135	128			930	290	276	28.5	
450	140	133			950	295	280	29.2	36
465	145	138			965	300	285	29.8	37
480	150	143			995	310	295	31	38
495	155	147			1030	320	304	32.2	39
510	160	152			1060	330	314	33.3	40
530	165	157			1095	340	323	34.3	41
545	170	162			1125	350	333	35.5	42
560	175	166			1155	360	342	36.6	43
575	180	171			1190	370	352	37.7	44
595	185	176			1220	380	361	38.8	45
610	190	181			1255	390	371	39.8	46
625	195	185			1290	400	380	40.8	47
640	200	190			1320	410	390	41.8	48
660	205	195	13		1350	420	399	42.7	
675	210	199	14		1385	430	409	43.6	49
690	215	204	15		1420	440	418	44.5	
705	220	209	15	28	1455	450	428	45.3	51
720	225	214	16		1485	460	437	46.1	52
740	230	219	17	29	1520	470	447	46.9	53
755	235	223	18		1555	480	465	47.7	54
770	240	228	20.3	30	1595	490	466	48.4	
785	245	233	21.3		1630	500	475	49.1	57

The figures given are approximate according to DIN EN ISO18265 (02-2004)

Basic tolerances

Basic tolerances in μm				DIN ISO 286-1, -2 : 1990-11																			
				IT toleranz grade																			
Nominal dimension in mm				01	0	1	2	3	4	5	6	7	8	9	10	11	12	13	14	15	16	17	18
		to	3	0,3	0,5	0,8	1,2	2	3	4	6	10	14	25	40	60	100	140	250	400	600	1000	1400
over	3	to	6	0,4	0,6	1	1,5	2,5	4	5	8	12	18	30	48	75	120	180	300	480	750	1200	1800
over	6	to	10	0,4	0,6	1	1,5	2,5	4	6	9	15	22	36	58	90	150	220	360	580	900	1500	2200
over	10	to	18	0,5	0,8	1,2	2	3	5	8	11	18	27	43	70	110	180	270	430	700	1100	1800	2700
over	18	to	30	0,6	1	1,5	2,5	4	6	9	13	21	33	52	84	130	210	330	520	840	1300	2100	3300
over	30	to	50	0,6	1	1,5	2,5	4	7	11	16	25	39	62	100	160	250	390	620	1000	1600	2500	3900
over	50	to	80	0,8	1,2	2	3	5	8	13	19	30	46	74	120	190	300	460	740	1200	1900	3000	4600
over	80	to	120	1	1,5	2,5	4	6	10	15	22	35	54	87	140	220	350	540	870	1400	2200	3500	5400
over	120	to	180	1,2	2	3,5	5	8	12	18	25	40	63	100	160	250	400	630	1000	1600	2500	4000	6300
over	180	to	250	2	3	4,5	7	10	14	20	29	46	72	115	185	290	460	720	1150	1850	2900	4600	7200
over	250	to	315	2,5	4	6	8	12	16	23	32	52	81	130	210	320	520	810	1300	2100	3200	5200	8100
over	315	to	400	3	5	7	9	13	18	25	36	57	89	140	230	360	570	890	1400	2300	3600	5700	8900
over	400	to	500	4	6	8	10	15	20	27	40	63	97	155	250	400	630	970	1550	2500	4000	6300	9700



CERATIZIT designation system – cutting materials

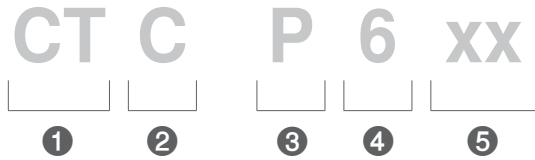

1 Manufacturer: CERATIZIT

2 Cutting material

- ▲ W Uncoated carbide
- ▲ C CVD coated carbide
- ▲ P PVD coated carbide
- ▲ T Uncoated cermet
- ▲ E Coated cermet
- ▲ N Uncoated silicon nitride
- ▲ M Coated silicon nitride
- ▲ S Mixed ceramic
- ▲ K Whisker ceramic
- ▲ I Sialon
- ▲ D PCD
- ▲ B CBN
- ▲ L CBN coated
- ▲ H Sintered HSS

3 Main application (material) Variant 1: number

- ▲ 1 Steel
- ▲ 2 Stainless steel
- ▲ 3 Cast iron
- ▲ 4 Light and non-ferrous metals, non metals
- ▲ 5 Heat-resistant alloys, titanium
- ▲ 6 Hard materials
- ▲ 7 Universal grade for a variety of applications

Main application (material) Variant 2: ISO letter

- ▲ P Steel
- ▲ M Stainless steel
- ▲ K Cast iron
- ▲ N Light and non-ferrous metals, non metals
- ▲ S Heat-resistant alloys, titanium
- ▲ H Hard materials
- ▲ X Universal grade for a variety of applications

4 Main application (machining method)

- ▲ 1 Turning
- ▲ 2 Milling
- ▲ 3 Parting and grooving
- ▲ 4 Drilling
- ▲ 5 Threading
- ▲ 6 Others / bar peeling / heavy machining
- ▲ 7 Universal grade for a variety of applications

5 ISO 513 Application range

- For example.
- ▲ 01
 - ▲ 05
 - ▲ 10
 - ▲ 15
 - ▲ 25
 - ▲ 35ISO P35
 - ▲ .
 - ▲ .

Grade designation P635 = CTCP635

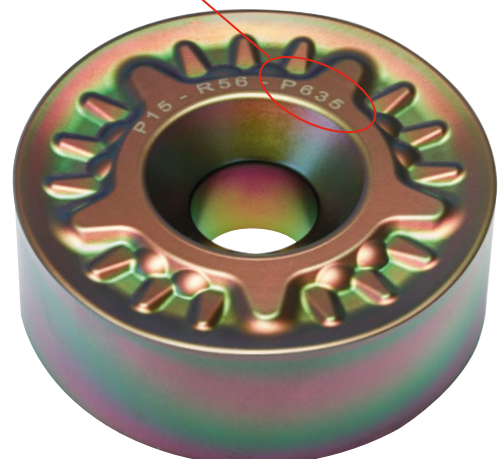





Cutting materials grades

Grade designation	Standard designation		Cutting material	Application range											P	M	K	N	S	H	
	ISO	ANSI		01	05	10	15	20	25	30	35	40	45	50							
CTCP605	HC-P10	C8	C												●			○			
	HC-K20	C2	C														○				
CTCM615	HC-M15	-	C												●						
	HC-S15	-	C																●		
CTCP615	HC-P15	C7	C												●		○				
	HC-M15	-	C													●					
	HC-S15	-	C																●		
CTCM625	HC-M25	-	C												●						
	HC-S25	-	C																●		
CTCP625	HC-P25	C6	C												●						
	HC-M25	-	C													●					
	HC-S25	-	C																●		
CTCP630	HC-P30	C6	C												●						
	HC-M30	-	C													●					
	HC-S30	-	C																●		
CTCM635	HC-M35	-	C												●						
	HC-S35	-	C																●		
CTCP635	HC-P35	C5	C												●						
	HC-M35	-	C													●					
	HC-S35	-	C																●		
CTCP640	HC-P40	C5	C												●						
	HC-M40	-	C													●					
	HC-S40	-	C																●		
H216T	HW-N15	C3	W															○			
	HW-K15	C3	W														●				
	HW-S15	--	W																●		

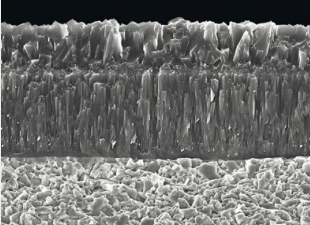
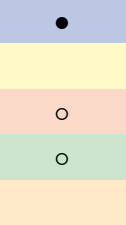
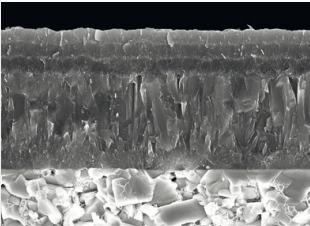
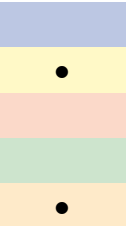
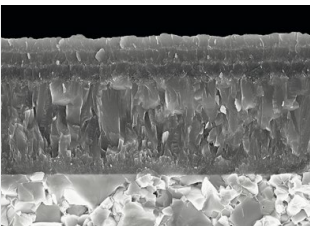
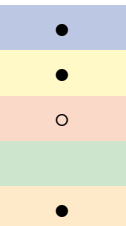
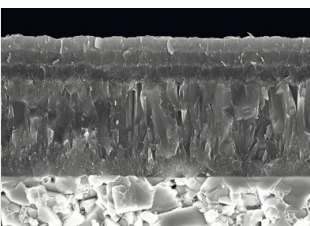
● Main application
○ Extended application

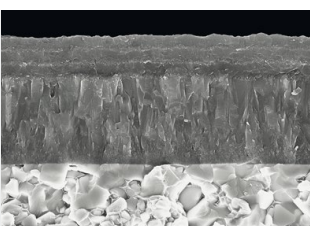
Cutting material grades

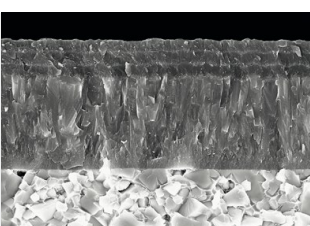
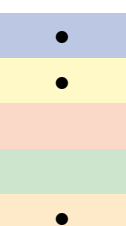
<p>CTCP605 HC-P10 HC-K20</p> <p>Specifications: Composition: Co 6.0%; TaC 2.0%; WC balance Grain size: 1 µm Hardness: HV₃₀ 1630 Coating specification: CVD TiCN-Al₂O₃</p>			<p>Recommended application: First choice for high cutting speeds and feed rates on steel materials and with very stable machining conditions.</p>
<p>CTCM615 HC-M15 HC-P15</p> <p>Specifications: Composition: Co 6.0%; TaC 2.0%; WC balance Grain size: 1 µm Hardness: HV₃₀ 1630 Coating specification: CVD TiCN-Al₂O₃</p>			<p>Recommended application: First-class high-end grade for martensitic stainless steels and heat-resistant alloys with stable machining conditions</p>
<p>CTCP615 HC-P15 HC-M15 HC-S15</p> <p>Specifications: Composition: Co 6.0%; mixed carbides 3.1%; WC balance Grain size: fine Hardness: HV₃₀ 1630 Coating specification: CVD TiCN-Al₂O₃</p>			<p>Recommended application: Wear-resistant carbide grade mainly with finishing inserts in all material classes with stable machining conditions.</p>
<p>CTCM625 HC-M25 HC-P25 HC-S25</p> <p>Specifications: Composition: Co 7.0%; mixed carbides 6.5%; WC balance Grain size: medium Hardness: HV₃₀ 1460 Coating specification: CVD TiCN-Al₂O₃</p>			<p>Recommended application: Specially developed grade for general machining of stainless steels</p>
<p>CTCP625 HC-P25 HC-M25 HC-S25</p> <p>Specifications: Composition: Co 7.0%; mixed carbides 6.5%; WC balance Grain size: medium Hardness: HV₃₀ 1460 Coating specification: CVD TiCN-Al₂O₃</p>			<p>Recommended application: Excellent universal grade mainly with finishing inserts in all material classes with medium strengths and unstable machining conditions.</p>
<p>CTCP630 HC-P30 HC-M30 HC-S30</p> <p>Specifications: Composition: Co 9.0%; others < 3%; WC balance Grain size: medium Hardness: HV₃₀ 1400 Coating specification: CVD TiCN-Al₂O₃</p>			<p>Recommended application: Carbide grade mainly for roughing on specific stainless materials and heat-resistant alloys.</p>

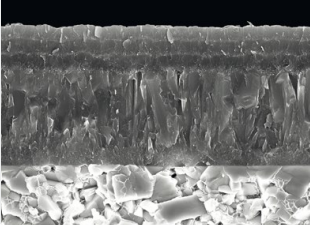
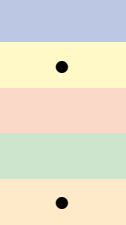
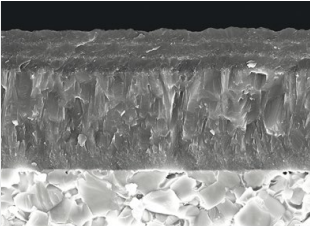
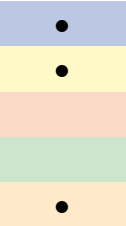
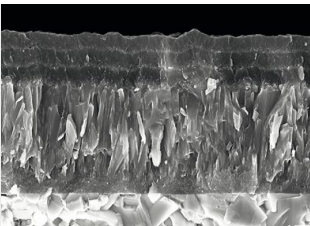
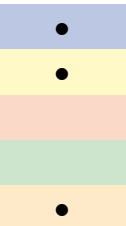
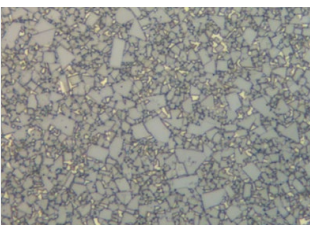
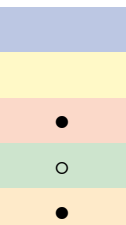
<p>CTCM635 HC-M35 HC-P35 HC-S35</p> <p>Specifications: Composition: Co 10,0%; mixed carbides 5,0%; WC balance Grain size: medium Hardness: HV30 1380 Coating specification: CVD TiCN-Al₂O₃</p>			<p>Recommended application: Tough grade for machining stainless steels in difficult conditions</p>
<p>CTCP635 HC-P35 HC-M35 HC-S35</p> <p>Specifications: Composition: Co 10.0%; mixed carbides 5.0%; WC balance Grain size: medium Hardness: HV₃₀ 1380 Coating specification: CVD TiCN-Al₂O₃</p>			<p>Recommended application: Tough universal grade mainly for roughing on all materials under difficult conditions.</p>
<p>CTCP640 HC-P40 HC-M40 HC-S40</p> <p>Specifications: Composition: Co 10.5%; mixed carbides 2.0%; WC balance Grain size: medium Hardness: HV₃₀ 1400 Coating specification: CVD TiCN-Al₂O₃</p>			<p>Recommended application: Extremely tough carbide grade for roughing under difficult machining conditions.</p>
<p>H216T HW-N15 HW-K15</p> <p>Specifications: Composition: Co 6.0%; WC balance Grain size: 1 µm Hardness: HV₃₀ 1630</p>			<p>Recommended application: Uncoated carbide grade for the machining of aluminium and other non-ferrous metals</p>

Cutting material grades ISO P / ISO M / ISO S

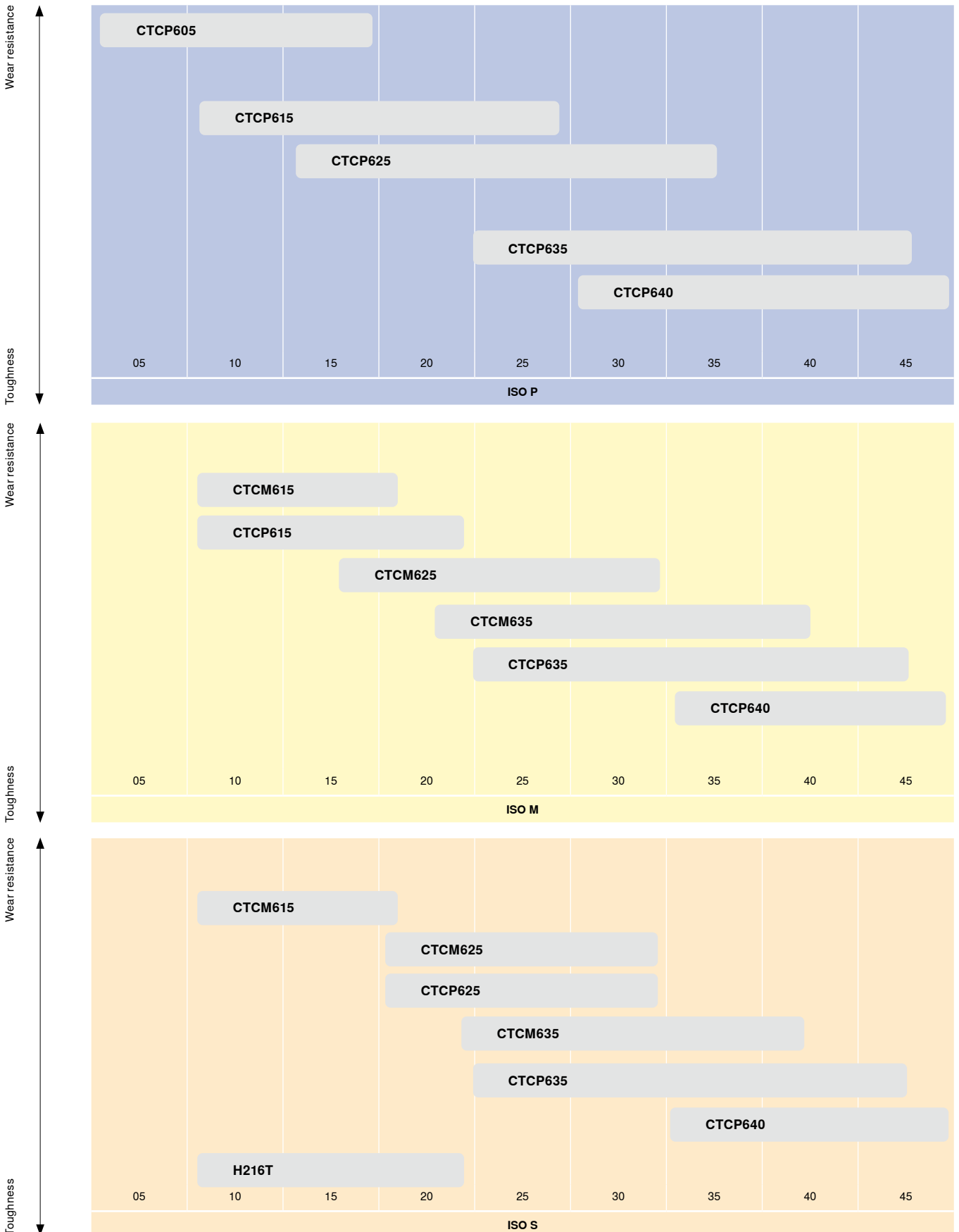

Recommended CERATIZIT carbide grades per material

	Work piece material	Type of treatment	Alloy	VDI 3323 group	Hardness [HB]	Grade
P	Non alloyed steel	annealed	≤ 0.15 % C	1	125	CTCP625 CTCP635 / CTCP605
	Non alloyed steel	annealed	0.15 %–0.45 % C	2	150–250	CTCP625 CTCP635 / CTCP605
	Non alloyed steel	tempered	≥ 0.45 % C	3	300	CTCP615 CTCP605
	Low alloyed steel	annealed		6	180	CTCP625 CTCP635 / CTCP605
	Low alloyed steel	tempered		7 / 8	250–300	CTCP615 CTCP625 / CTCP605
	Low alloyed steel	tempered		9	350	CTCP615 CTCP605
	High alloyed steel	annealed		10	200	CTCP625 CTCP615
	High alloyed steel	tempered		11	350	CTCP615 CTCP605
	Stainless steel	annealed	ferritic / martensitic	12	200	CTCP625
	Stainless steel	tempered	martensitic	13	325	CTCP625 CTCM615
	Stainless steel	heat-treated	ferritic / martensitic	13	200	CTCP625
M	Stainless steel	quenched	austenitic	14	180	CTCM625 CTCM635
	Stainless steel	quenched	ferritic / austenitic (duplex)	14	230–260	CTCM625 CTCM635 / CTCM615
	Stainless steel	hardened	austenitic, precipitation hardened (PH)	14	330	CTCM625 CTCM635 / CTCM615
K	Cast iron			15–20	130–260	CTCP615 CTCP605 / H216T
N	Non-ferrous metals			21–30	80–130	CTCP615 CTCP605 / H216T
S	Heat-resistant materials			31–35	200–350	CTCP625 CTCP630 / CTCP640
	Titanium alloys			36 / 37	150–300	CTCP615 CTCM615 / H216T

Dragonskin – the coating for maximum performance

The ongoing development of production technologies takes top priority at CERATIZIT. This is why we have focused all our innovative strength and expert knowledge in coating technology on one objective: developing a tool coating that allows our customers to achieve an unprecedented level of performance in machining. We have succeeded in our efforts with the Dragonskin coating technology.

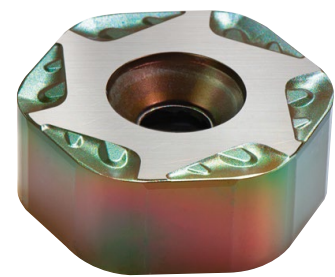

The secret of the coating

For bar peeling, we have adapted the innovative Dragonskin coating technology specifically to the machining of bright steel products. One of the coatings is, for example, made up of a multilayer, nanometre thick layer structure of aluminium oxides, exhibiting very fine crystals. This fine, crystalline structure on the one hand ensures that improved mechanical properties are achieved, and on the other that the intrinsic roughness of the layer is reduced, resulting in optimal chip evacuation. This in turn reduces the friction value and results in minimal heating of the cutting material. Our Dragonskin grades that are developed especially for the peeling process are particularly robust and, thanks to their special layer structure, feature – in addition to the usual excellent physical properties such as fracture toughness, wear resistance, heat resistance, and temperature and chemical resistance – a flawless protective function for the cutting edges against micro-cracks and chipping.

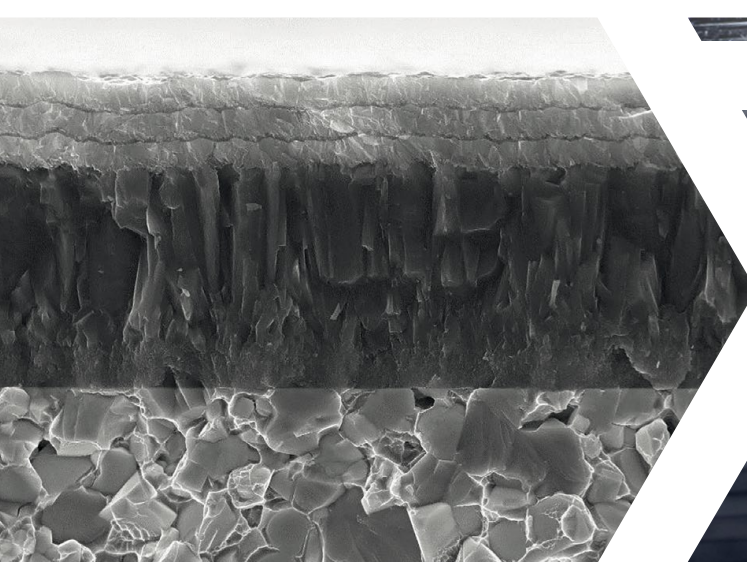

YOUR BENEFITS

NANO COATING

THE LATEST NANO COATING TECHNOLOGY PRODUCES TOUGH LAYERS AND REDUCES THE RISK OF CHIPPING ON THE CUTTING EDGE

PERFECT CHIP EVACUATION

AND LESS MATERIAL ADHESION THANKS TO THE EXTREMELY SMOOTH LAYER SURFACE

SIGNIFICANTLY LESS WEAR

AND THEREFORE MORE EFFECTIVE PRODUCTION

CTCP605 – UNBEATABLE WHEN MACHINING STEEL

The new high-performance
grade for bar peeling



DRAGONSKIN
by CERATIZIT

Application examples from practical use

Increase tool life, reduce costs – users in the production of bright steel are increasingly faced with the challenge of optimising existing production processes in order to save time and money. The machining of new materials or modified general conditions can also lead to new problems.

With our products and solutions for bar peeling we were able to optimise the processes for various manufacturers of bright steel, thereby helping them achieve a better outcome. See for yourself and take a look at the examples from practical use:

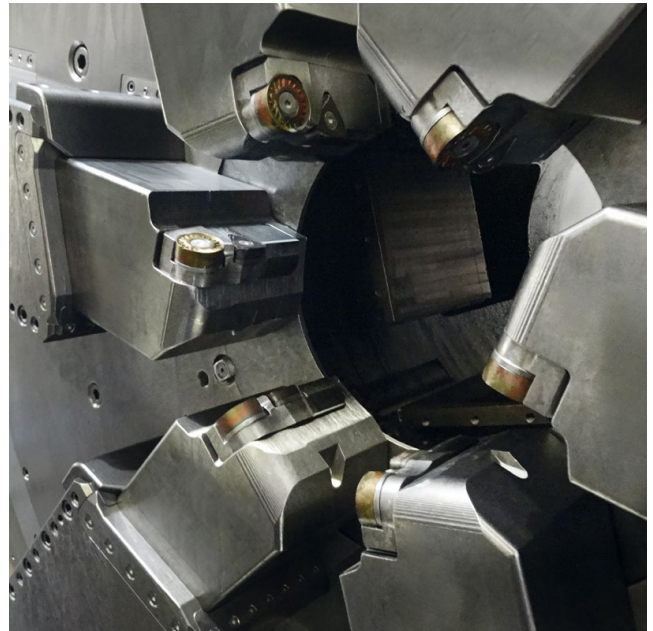

Test report

Cost saving 30%

Material	Stainless steel X2CrNiMoV 22-5-3 / 260 HB
Work piece	Bright steel bar, Ø 320 mm
Strength	880 N/mm ² (260 HB)
Machine	Kieserling WDHS 300
V _c	30 m/min
a _p	6.0 + 1.5 mm
f	12 mm/rev
Coolant	Emulsion

Competitor	
■ Tool	TCA14-RN50YN20
■ Insert	YNUF 201220S50-M50
■ Grade	CTC1125
CERATIZIT	
■ Tool	TCA14-RN50NN20
■ Insert	NNUX 201020S50-M43
■ Grade	CTCP625

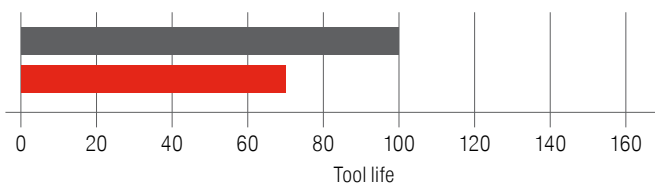

Tandem cartridge
TCA14-RN50NN20



NNUX 201020S50-M43
CTCP625

Problems / criteria

- ▲ Improved chip formation

Result

- ▲ New M43 chip breaker design provides shorter chips: chip jam reduced to a minimum
- ▲ By using the NNUX 201020S50-M43 insert with 6 cutting edges cost saving of 30% for the customer

Test report

Material	Super duplex steel P550
Work piece	Boring bar for oil industry Ø 223 mm, L = 9.5 m
Strength	1035 N/mm ² (304 HB)
Machine	Kieserling WDHS 300
V _c	13 m/min
a _p	4.0 + 2.5 mm
f	13.2 mm/rev
Coolant	Emulsion

**Tool life improved
100%**

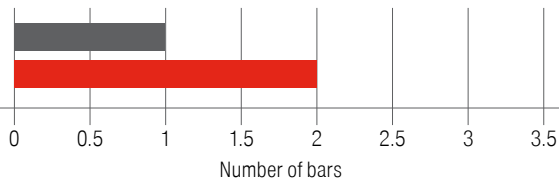

Tandem cartridge
TCA12-RN38WN16



RNGH 3812MOP15-R56
CTCP635

Competitor

Tool	TCA12-RN38WN16
Insert	RNMH-3812-BML-M1
Grade	LC228E

CERATIZIT

Tool	TCA12-RN38WN16
Insert	RNGH 3812MOP15-R56
Grade	CTCP635

Problems / criteria

- ▲ Improve tool life and reduce cost

Result

- ▲ Tool life improved by 100%
- ▲ Perfect edge stability and high process security
- ▲ Excellent performance from grade CTCP635
- ▲ Manufacturing of a second bar possible without any failure of the insert performance

Test report

Material	Tool steel C15E2, soft
Work piece	Bright steel, automotive industry Ø 50 mm
Strength	350 N/mm ² (105 HB)
Machine	Kieserling WDHX 100
V _c	174 m/min
a _p	0.8 mm
f	18.5 mm/rev
Coolant	Emulsion

**Tool life improved
180%**

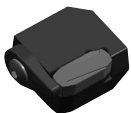
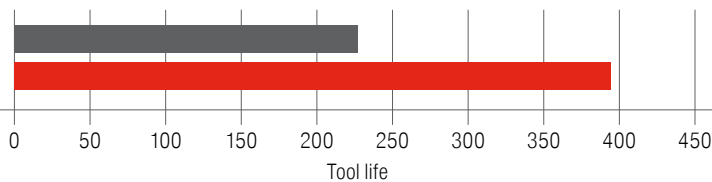

Single cartridge
CA00-YNUF20



YNUF 201220P60-M50
CTCP635

Competitor

Tool	CA00-YNUF20
Insert	LKGC 182020 SF
Grade	VTA420

CERATIZIT

Tool	CA00-YNUF20
Insert	YNUF 201220P60-M50
Grade	CTCP635

Problems / criteria

- ▲ Improve tool life with soft steel materials

Result

- ▲ Tool life improved by 180%
- ▲ Perfect chip evacuation – less material sticking tendency
- ▲ 21 tons of material were peeled with one cutting edge (= 265 bars) – the competitor's insert cut only 7.5 tons
- ▲ Extremely tough coating minimizes the risk of chipping and gives maximum reliability

Test report

**Tool life improved
70%**

Material Nimonic 80A
 Work piece Bright steel, Ø 62.8 mm,
 L = 4000 mm
 Strength 1050 N/mm² (311 HB)
 Machine Medard 4R – Peeling heads with
 6 tool holders
 V_c 22 m/min
 a_p 2.3 mm
 f 8 mm/rev.
 Coolant Emulsion

Competitor	
■ Tool	CA00-WNGU15
■ Insert	TNMX 1509-2
■ Grade	4225
CERATIZIT	
■ Tool	CA00-WNGU15
■ Insert	WNGU 151015S50-M50
■ Grade	CTCP635

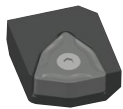
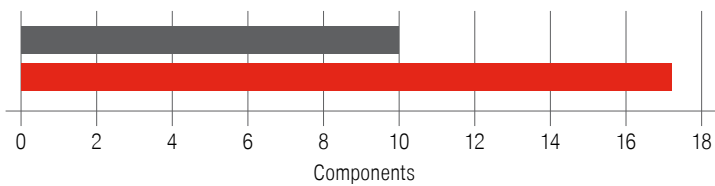

Single cartridge
CA00-WNGU15

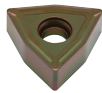

WNGU 151015S50-M50
CTCP635

Problems / criteria

- ▲ Improve tool life

Result

- ▲ Tool life improved by 70%
- ▲ Competitor's insert = 10 bars per cutting edge
 CERATIZIT insert = 17 bars per cutting edge
- ▲ Excellent edge stability and process security by using grade CTCP635
- ▲ Cost reduction – more bars per cutting edge

Test report

**Improved productivity
42%**

Material X6NiCrTiMoVB25-15-2
 (1.4980)
 Work piece Bright steel, Ø 20 mm,
 L = 4000 mm
 Strength 1180 N/mm² (350 HB)
 Machine SMS Schumag PM35
 V_c 65 m/min
 a_p 0.5 mm
 f 12 mm/rev.
 Coolant Emulsion
 Tool life 45

Competitor	
■ Tool	CA00-YNUF17
■ Insert	LPUC 121517 PF
■ Grade	VTA420
CERATIZIT	
■ Tool	CA00-YNUF17
■ Insert	YNUF 170820P33-M50
■ Grade	CTCM615

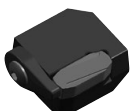
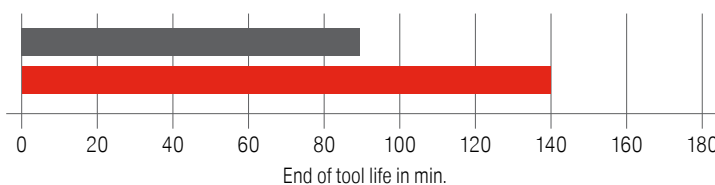

Single cartridge
CA00-YNUF17



YNUF 170820P33-M50
CTCM615

Problem / criteria

- ▲ Achieving the specified cutting data in different materials for the machine acceptance test

Result / customer benefit

- ▲ Improved productivity
- ▲ Highest quality of the products
- ▲ The cutting parameters specified by the customer, the tool life and the quality of the bars were achieved

Test report

Tool life improved
100%

Material	X2CrNiMoN22-5-3 (1.4462)
Work piece	Bright steel, Ø 325 mm / L = 7700 mm
Strength	820 N/mm ² (240HB)
Machine	SMS PMH600
V _c	45 m/min
a _p	6.5 mm
f	18 mm/rev.
Coolant	Emulsion

Competitor	
■ Tool	TCA12 RN50NN27
■ Insert	RNMH 5018M0-P15
■ Grade	CTCP635
CERATIZIT	
■ Tool	TCA12 HN28NN27
■ Insert	HNMH 281850S50-R51
■ Grade	CTCP635

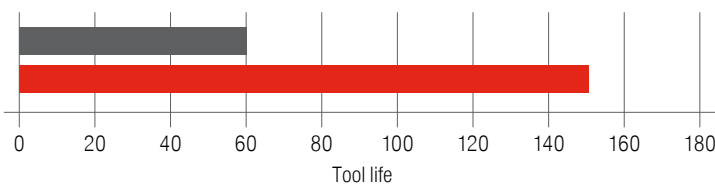

Problem / criteria

- ▲ Chip breakage/tool life

Result / customer benefit

- ▲ 100% improvement in tool life
- ▲ Significantly improved chip breakage



Tandem cartridge TCA12 HN28NN27
HNMH 281850S50-R51
CTCP635

Test report

Cost saving
60%

Material	Nicorros al SO1 (2.4375)
Work piece	Bright steel, Ø 200 mm / L = 4150 mm
Strength	1100 N/mm ² (325 HB)
Machine	SMS Schumag PMH320
V _c	30 m/min
a _p	10.2 mm
f	7 mm/rev.
Coolant	Emulsion

Competitor	
■ Tool	TCA12 RN50NN20
■ Insert	RKUC 508000 VF
■ Grade	VTE510
CERATIZIT	
■ Tool	TCA12 HN22NN20
■ Insert	HNMJ 221550S60-R51 „double sided“
■ Grade	CTCP635

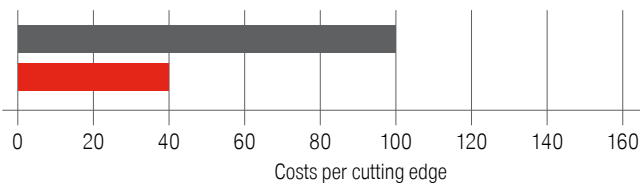

Problem / criteria

- ▲ Production optimisation

Result / customer benefit

- ▲ -60% cost reduction
- ▲ Improved chip breakage
- ▲ The chip containers do not need to be changed as frequently

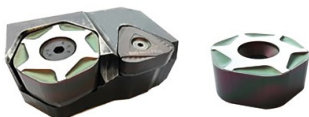

Tandem cartridge TCA12 HN22NN20
HNMJ 221550S60-R51
CTCP635

Test report

Improved productivity
150%

Material	X5CrNiCuNb16-4 (1.4542)
Work piece	Bright steel, 18.5 mm / L = 3000 mm
Strength	1000 N/mm ² (300 HB)
Machine	EJP PM30
V _c	48 m/min
a _p	0.5 mm
f	6.4 mm/rev.
Coolant	Emulsion

Competitor	
■ Tool	CA00-YNUF17
■ Insert	LPUC 121517 SF
■ Grade	VTA320
CERATIZIT	
■ Tool	CA00-YNUF17
■ Insert	YNUF 170820S60-M48
■ Grade	CTCP625

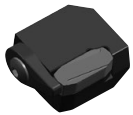
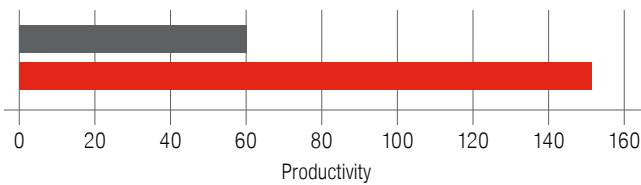

Single cartridge
CA00-YNUF17



YNUF 170825S60-M48
CTCP625

Problem / criteria

- ▲ Improved chip breakage
- ▲ Improved tool life
- ▲ Roundness and dimensional accuracy from the start of production

Result / customer benefit

- ▲ Optimum chip breakage
- ▲ Excellent dimensional accuracy
- ▲ Optimum roundness from the beginning

Test report

Improved tool life
75%

Material	V953SB (1.1210)
Work piece	Bright steel, Ø 29.8 mm, L = 5890 mm
Strength	900 N/mm ² (268 HB)
Machine	SMS Schumag PM1
V _c	136 m/min
a _p	0.9 mm
f	15.5 mm/rev.
Coolant	Emulsion

Competitor	
■ Tool	CA00-YNUF24
■ Insert	LPUC 151224 MF
■ Grade	VTA420
CERATIZIT	
■ Tool	CA00-YNUF24
■ Insert	YNUF 241020S60-M50
■ Grade	CTCP605

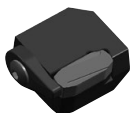
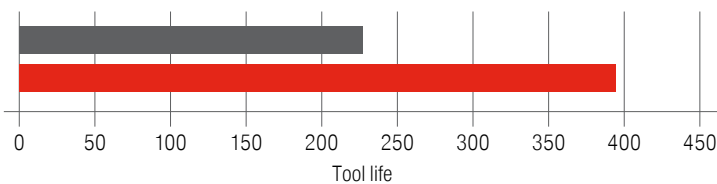

Single cartridge
CA00-YNUF24



YNUF 241020S60-M50
CTCP605

Problem / criteria

- ▲ High reject rate at the beginning of peeling due to poor roundness (IT09) should be avoided
- ▲ Improved tool life

Result / customer benefit

- ▲ No scrap parts at the start of production with CERATIZIT inserts.
- ▲ Roundness of the bars at 0.01 mm from the start of production
- ▲ Tool life increased by 75%



UNBEATABLE WHEN MACHINING STEEL

The CTCP605 high-performance grade

The CTCP605 high-performance grade for bar peeling boasts exceptional performance in terms of tool life, bar surface quality and roundness. High process security and maximum machining rates are also among the outstanding qualities of these innovative indexable inserts.

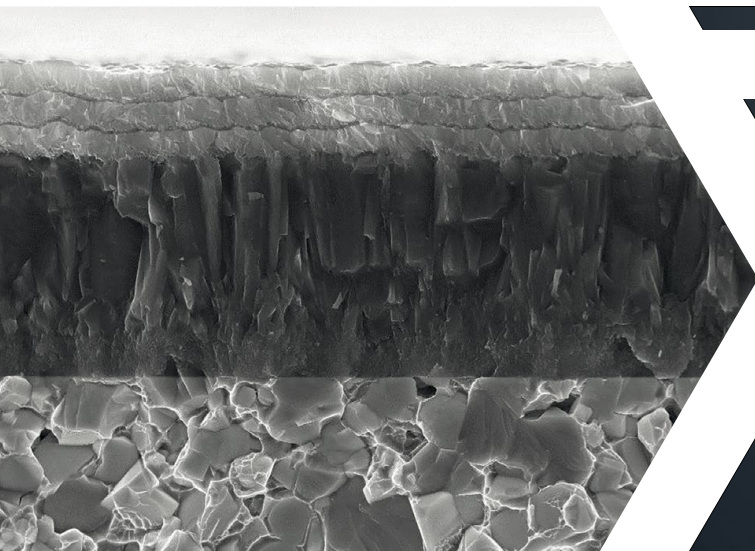

YOUR BENEFITS

IMPROVED TOOL LIFE

DUE TO SUBSTRATE /
COATING COMBINATION

OPTIMUM ROUNDNESS (IT9)

FROM START OF PRODUCTION

PERFECT SURFACE QUALITY

ON FINISHED PRODUCTS

Bar peeling inserts – influencing factors for choosing the correct insert

In order to select the best-suited peeling insert, the following criteria have to be taken into consideration

- ▲ Composition and properties of the material to be machined
- ▲ Hardness of the material
- ▲ Diameter
- ▲ Depth of cut
- ▲ Required surface quality

The most important criterion for the correct choice of the peeling insert and its carbide grade is the material which has to be machined, its degree of finishing and its hardness. The wide variety of material composition that can occur, may however make it necessary in some cases to deviate from the prescribed recommendations; practical tests are a useful resource in this context. For different application cases different cutting edge geometries and various carbide grades have been developed which can then be combined with different support chamfers. A detailed Designation of these and the criteria of how to select them can be found on the following pages. Another criterion is the diameter which has to be machined together with the depth of cut. In this context the manufacturing process of the bars plays an important role. Drawn and rolled bars with diameters up to 150mm normally feature better surface quality of the blank than forged bars with diameters above 150mm, which besides the irregular surface structure can also show ruptures, cavities and flaking.



Increased metal removal rates and greater depths of cut are the consequence.

Other influencing factors

In addition to the above 5 selection criteria, other influencing factors which are decisive for the correct selection of the cutting insert are the following:

- ▲ Condition and characteristics of the peeling machine (maintenance)
- ▲ Condition and accuracy of the tool holder and cartridges (insert seat and insert clamping)
- ▲ Condition and setting of the guide elements (central infeed, pressurisation, wear of the rolls and guiding elements).
- ▲ Condition and characteristics of the blank bar (roundness, deflection, bar end hardening, chamfers, surface damages such as cracks, flat spots and flaking) ...
- ▲ Sufficient cooling in accurate concentration, sufficient pressure and quantity directly on the cutting edge
- ▲ Optimal chip evacuation – no chip jamming in the peeling head

Peeling inserts – different angles on the peeling insert

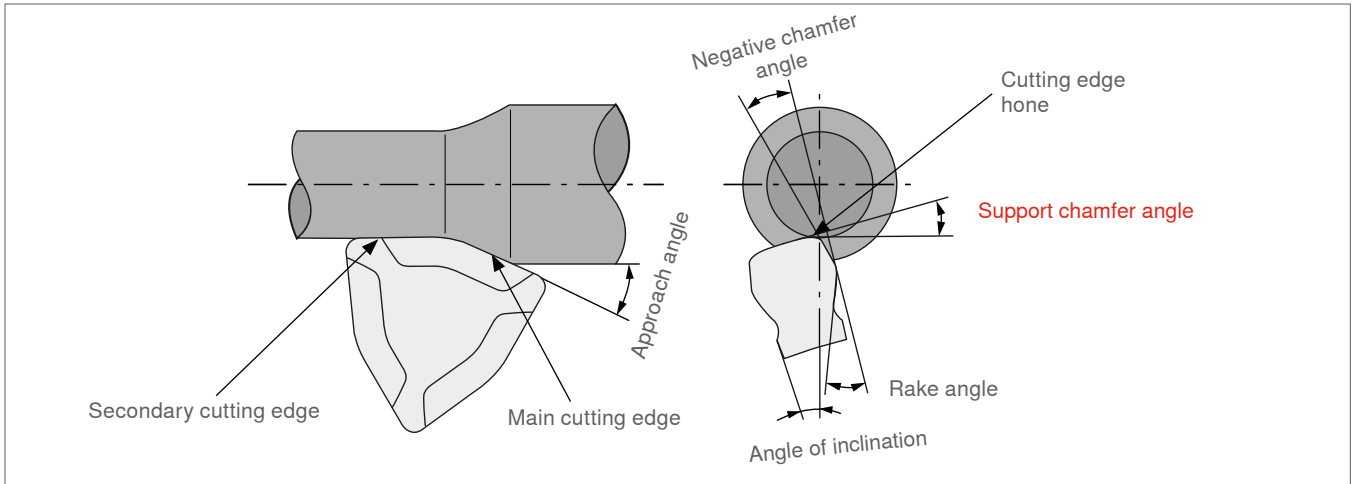

Support chamfer angle

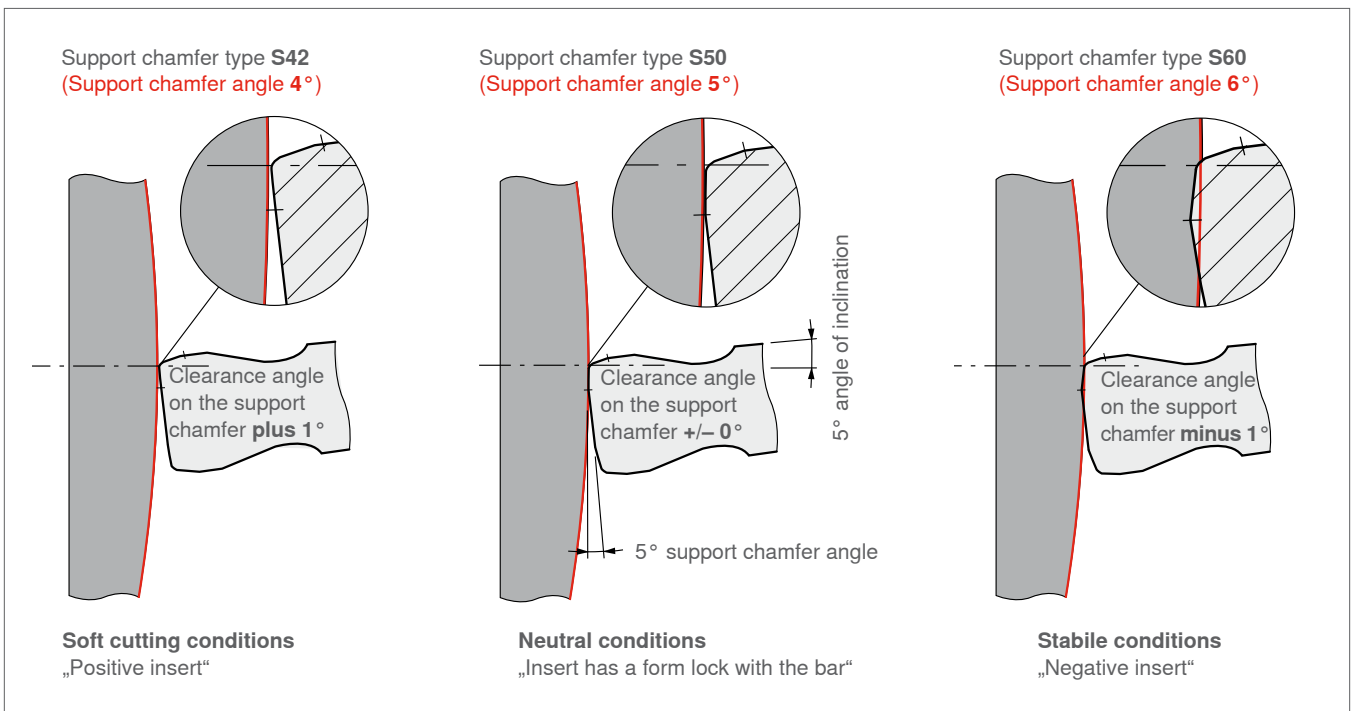

Inclination angle of the insert in the cartridge mainly 5°

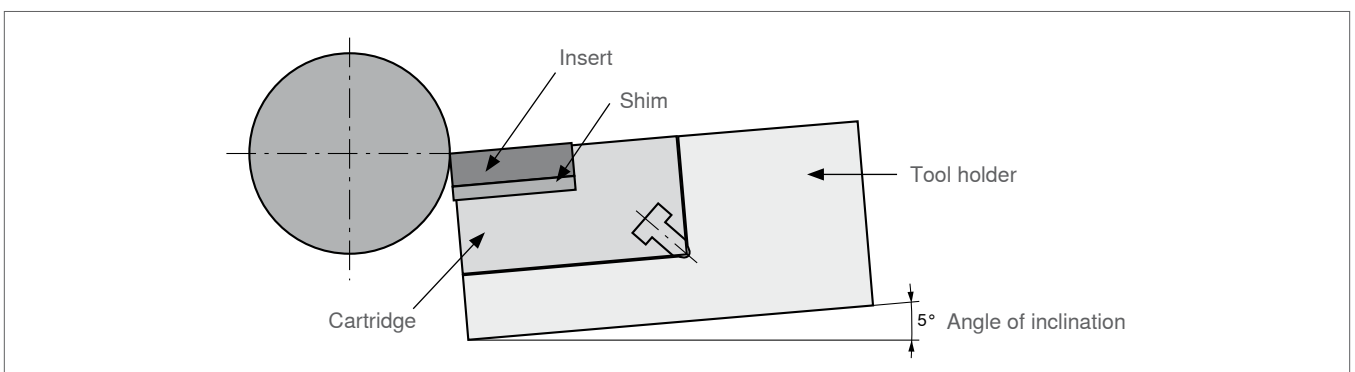

Various types of support chamfer preparation

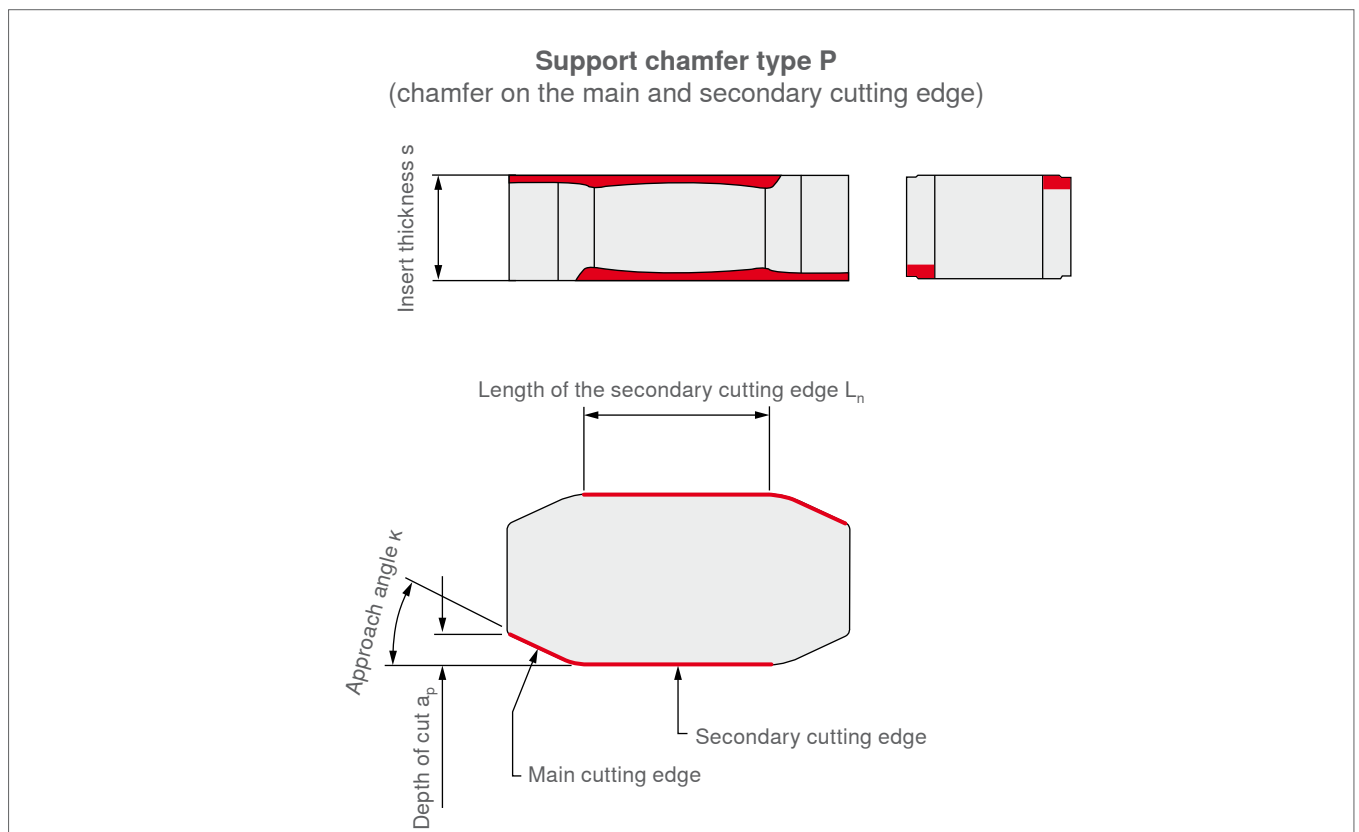
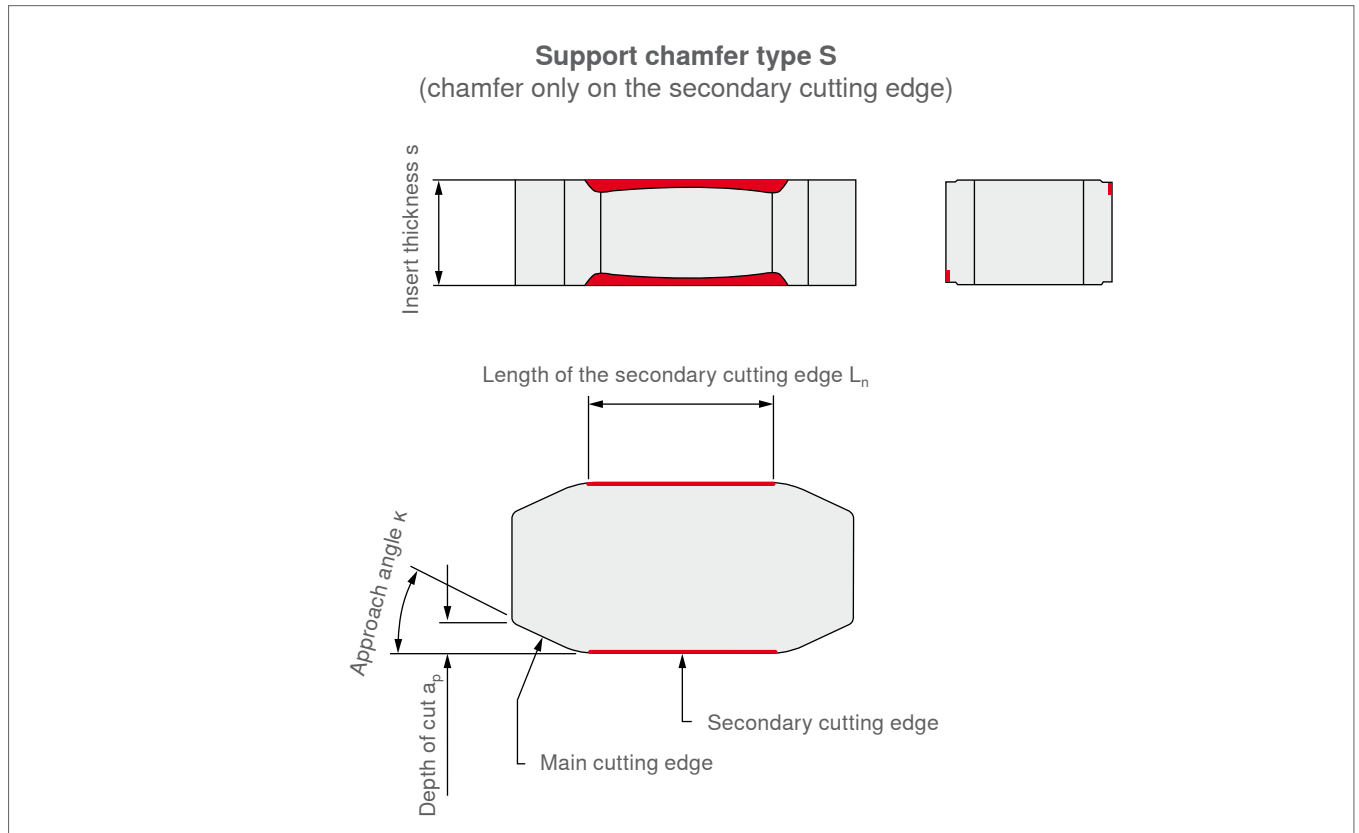

Support chamfer overview

Chamfer	Designation	Application range	Tensile strength (Brinell hardness)
P60	Main and secondary cutting edge chamfer angle 6°	< Annealed > e.g.: construction steel, tool steel, mainly used with vibration-sensitive materials and under unstable machining conditions	300–700 N/mm ² (90–210 HB)
S60	Secondary cutting edge chamfer angle 6°	< Annealed > e.g.: construction steel, tool steel	500–850 N/mm ² (150–250 HB)
P50	Main and secondary cutting edge chamfer angle 5°	< Full-hard > e.g.: construction steel, tool steel, stainless steel (austenitic)	450–800 N/mm ² (135–240 HB)
S50	Secondary cutting edge chamfer angle 5°	< Full-hard > e.g.: construction steel, tool steel, stainless steel (austenitic)	550–950 N/mm ² (160–280 HB)
P40	Main and secondary cutting edge chamfer angle 4°	< Full-hard > heat-resistant alloys	700–1100 N/mm ² (210–235 HB)
S42	Secondary cutting edge chamfer angle 4°	< Tempered > e.g. tempered steel, tool steel, stainless steel (duplex), Ni base alloys	750–1200 N/mm ² (220–350 HB)
P30	Main and secondary cutting edge chamfer angle 3°	< Tempered > e.g. tempered steel, tool steel, stainless steel (duplex), Ni base alloys	850–1350 N/mm ² (250–400 HB)
S30	Secondary cutting edge chamfer angle 3°	< Tempered > e.g. tempered steel, tool steel	900–1500 N/mm ² (280–470 HB)

Recommended application range for support chamfers based on the tensile strength of the steel material (N/mm²)



Recommended application range for support chamfers based on the BRINELL hardness of the steel material (HB)

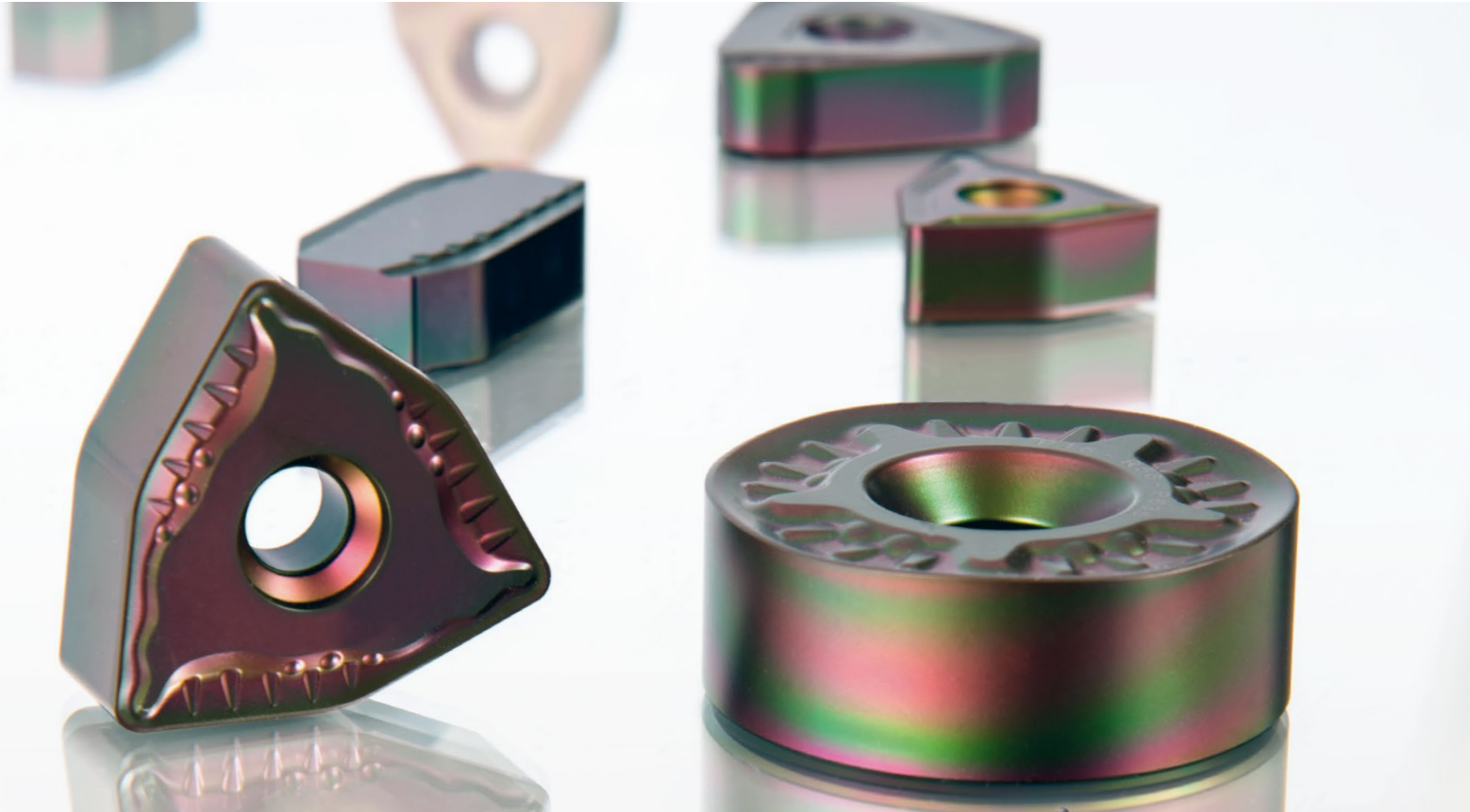

CERATIZIT peeling insert range

The principal uses of CERATIZIT peeling tools are in bright steel production, the bar end machining of semi-finished products for the automotive industry, bar and wire peeling from the coil, internal peeling of bars for the manufacture of hydraulic cylinders and conical peeling, for example in spring production.

For all material classes and diameter ranges, as well as cylindrical and tapered machining, we offer numerous insert styles in a variety of geometries and carbide grades, customised tools and holistic solutions for boosting both quality and productivity.

Peeling inserts for every application

Depths of cut 0.5 – 12 mm

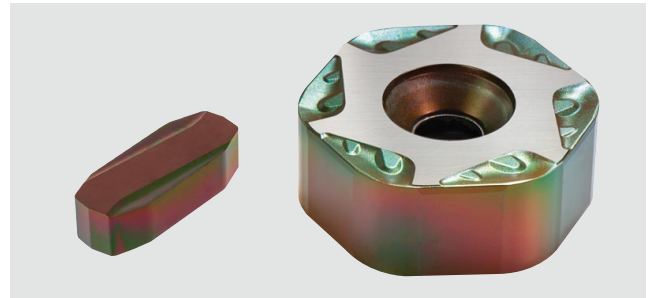

Feed rates up to 27 mm/rev.

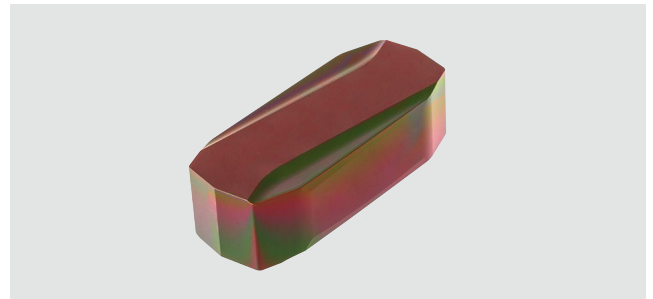

Cutting edges and chip grooves available for all material classes, e.g. the titanium machining

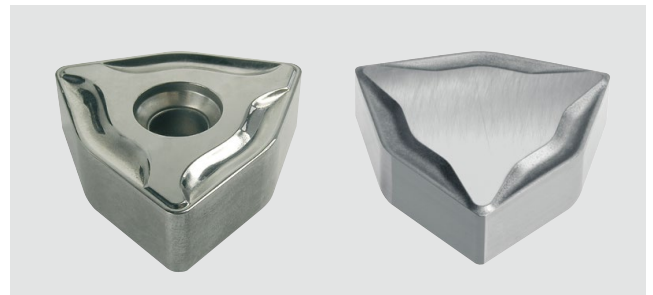

Cylindrical and conical machining

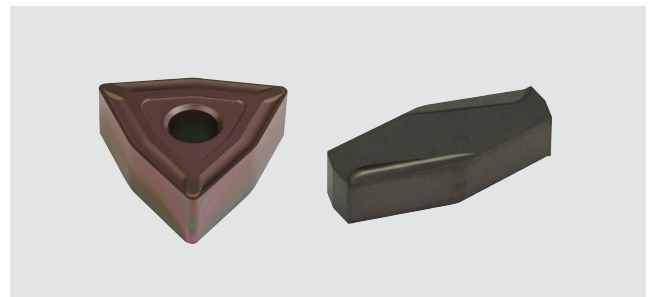

Inserts for internal peeling

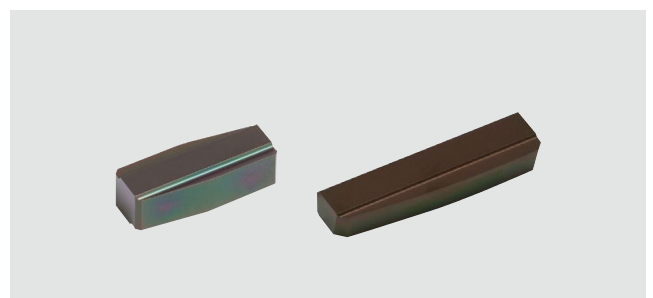

Solutions for super alloys and titanium

Super alloys are used in engine, turbine and power plant construction due to the heat-resistant material properties. Most super alloys are nickel-based super alloys such as those manufactured by STELLITE®, TRIBALOY®, HASTELOY®, INCOLOY® or INCONEL®.

Super alloys are extremely tough and resistant to heat, corrosion and acidic media. For the bar peeling of super alloys, CERATIZIT offers specially developed indexable inserts and grades, which are adapted for these material properties of heat-resistant materials and allow for optimum machining.

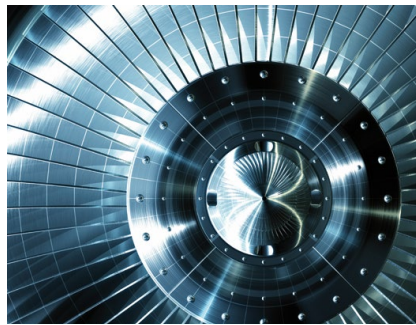
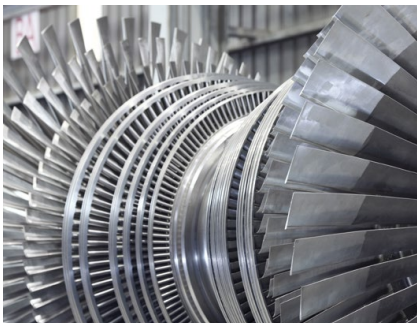

Usage conditions and risks – difficulties when machining:

Problem		Possible effects
Poor heat conductivity	→	High temperature on the cutting edge
Hardening on component	→	High mechanical load on cutting edge
Vibration-sensitive	→	Risk of insert breakage
Heavy wear	→	Poor tool life
Low cutting values	→	Low productivity

Peeling insert solutions for machining HRSA – Inconel

The CTCP625 and CTCP635 grades with the special cutting edge design and R59 chip breaker are ideal for machining HRSA – Inconel. The special support chamfer "S55" reduces the cutting pressure on the finished bar surface.

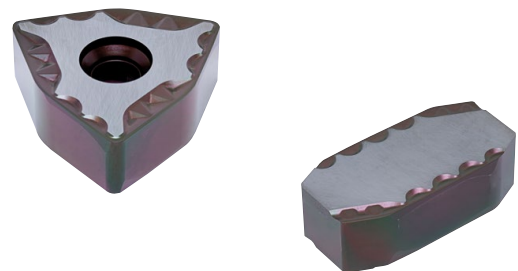

Peeling insert solutions for machining titanium

The high-performance grade is optimised for machining titanium thanks to the special cutting edge design and the R51 chip breaker. The extremely sharp cutting edges help prevent notch wear. The polished surface prevents built-up edge formation and guarantees optimum chip removal. The uncoated surface ensures that the titanium chips are not contaminated.



WNMF 96-P50



WNEU 161325P50-R51



WNGU 151015



NNUX 150820



Hexagonal roughing insert

For maximum efficiency when bar peeling

The unique and patented hexagonal roughing insert stands out in every material application and the distinctive insert geometry delivers significant benefits in the production of bright steel. Combined with the newly developed clamping system, it is a real all-purpose tool for users during bar peeling.

The ideal chip breaker for every material

The hexagonal roughing insert provides users with everything they need for any material requirement. Specially developed chip breakers with adapted cutting edge design guarantee the best results when bar peeling – whether in short-chipping or long-chipping materials.

-R57 chip breaker

Optimum geometry for general steel materials.

-R51 chip breaker

Specially adapted for soft or tough materials such as stainless steel and Ni-based alloys.

Versions:

HNMH roughing insert, single-sided use

HNMJ roughing insert, double-sided use



Bring out the best: Best results are achieved when combined with the right cartridge system, which thanks to the new and patented clamping method, enables the cutting edge to be changed more quickly.
→ pages 53

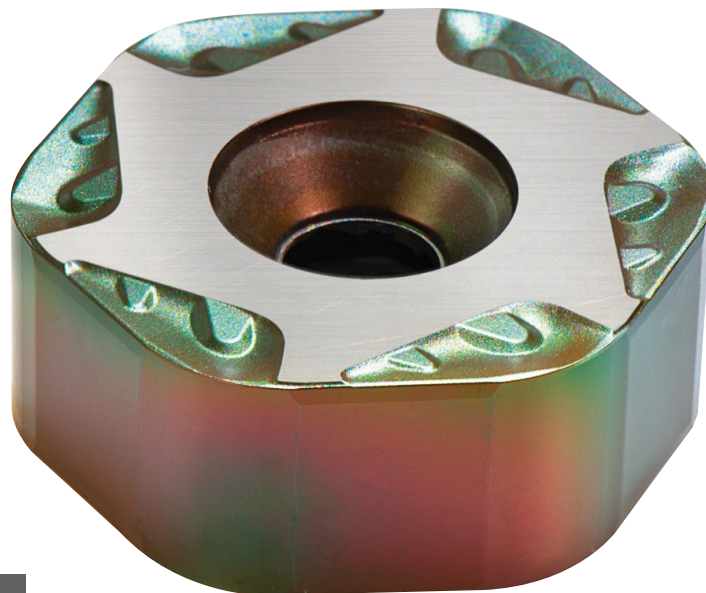

DRAGONSKIN

With innovative Dragonskin coating! The latest nano-coating technology produces an extremely smooth tool surface and guarantees perfect chip clearance. You benefit from maximum tool life and maximum process-security.

6 corners – 6 significant benefits!

1 Perfect positioning in the cartridge

The exact position of the indexable insert in the cartridge is defined geometrically by the hexagonal outside profile. 6 high performance cutting edges guarantee optimum use of the indexable insert.

No rotation or uncontrolled loosening during the production process.

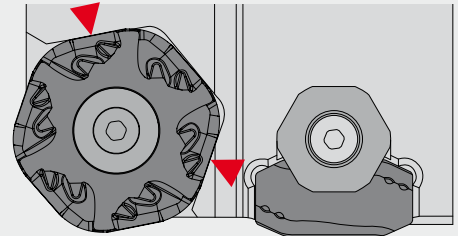

2 Reduced machine drive power

Shorter contact length of the cutting edge in comparison with the RNMH 5018 roughing insert reduces the power consumption by a factor of up to 0.7 at a maximum chip depth of 12 mm.

Less stress on the cutting edge reduces insert breakages.

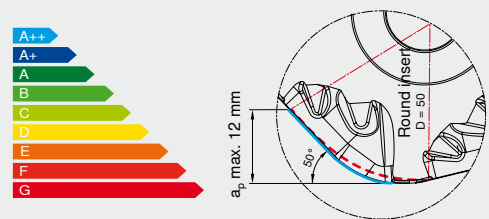

3 Optimised roughing surface on the bar

The finish cutting edge integrated in the roughing insert improves the roughness quality of the surface roughness on the bar.

Longer service life of the subsequent finishing insert as application conditions remain constant.

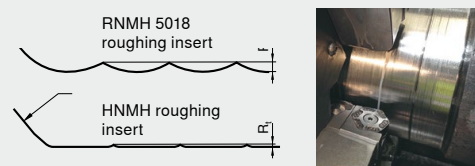

4 First roughing insert with protective chamfer

Protective chamfers partially placed on the cutting edge stabilise the cutting edge in exposed areas.

Reduces vibrations and improves both the cutting and wear properties of the indexable insert.



5 Uncoated seating surfaces

Improved heat transfer thanks to ground Al_2O_3 coating on the seating surfaces.

Increased tool life due to improved heat dissipation from the carbide insert into the steel tool holder.

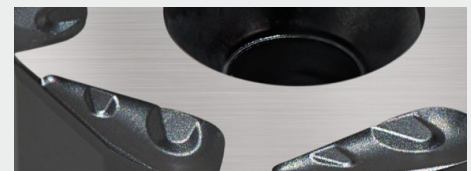

6 Twice as many cutting edges with HNMJ insert

The double-sided version offers 12 high performance cutting edges.

Reduced costs per cutting edge

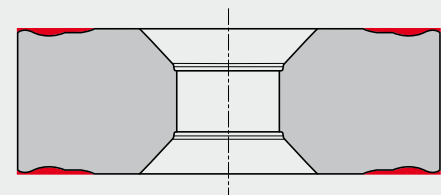

Peeling inserts for ROUGHING – code “R”

HNMJ 1310..-R51



$a_p = 4.0$

HNMJ 1310..-R57



$a_p = 4.0$

HNMH 2215..-R51



$a_p = 8.0$

HNMJ 2215..-R51



$a_p = 8.0$

HNMH 2215..-R57



$a_p = 8.0$

HNMJ 2215..-R57



$a_p = 8.0$

HNMH 2818..-R51

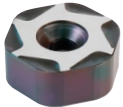

$a_p = 12.0$

HNMJ 2818..-R51

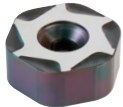

$a_p = 12.0$

HNMH 2818..-R57

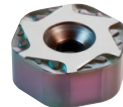

$a_p = 12.0$

HNMJ 2818..-R57

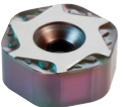

$a_p = 12.0$

RNMH 2008..-R50



$a_p = 3.0$

RNMH 2008..-R56



$a_p = 3.0$

RNMH 2810..-R50



$a_p = 5.0$

RNMH 2810..-R56



$a_p = 5.0$

RNGH 3812..-R50



$a_p = 7.0$

RNGH 3812..-R55



$a_p = 7.0$

RNGH 3812..-R56



$a_p = 7.0$

RNGX 3812..-R56



$a_p = 7.0$

RNMX 5018..-R50

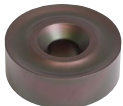

$a_p = 9.0$

RNMH 5018..-R55

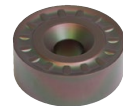

$a_p = 9.0$

RNMH 5018..-R56



$a_p = 9.0$

a_p = maximum depth of cut

Chip groove code – ROUGHING inserts – code “R”

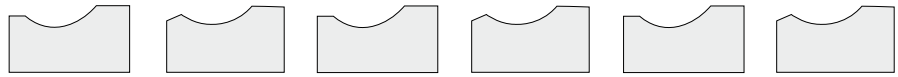

Roughing insert code “R”		neutral	negative	neutral	negative	neutral	negative
Chip groove code		R51	R50	R55	R55	R56	R57
HNMJ 131050	Page 68	S60-R51					S60-R57
HNMH/J 221550	Page 68, 69	S60-R51					S60-R57
HNMH/J 281850	Page 68, 69	S60-R51					S60-R57
RNMH 200800	Page 84	E00				E00	P15
RNMH 281000	Page 84	E00				E00	P15
RNGH 381200	Page 85		P15		P15	E00	P15
RNGX 381200	Page 86					E00	P15
RNMH 5018M0	Page 87			E00		E00	P15
RNMX 5018M0	Page 87	E00					

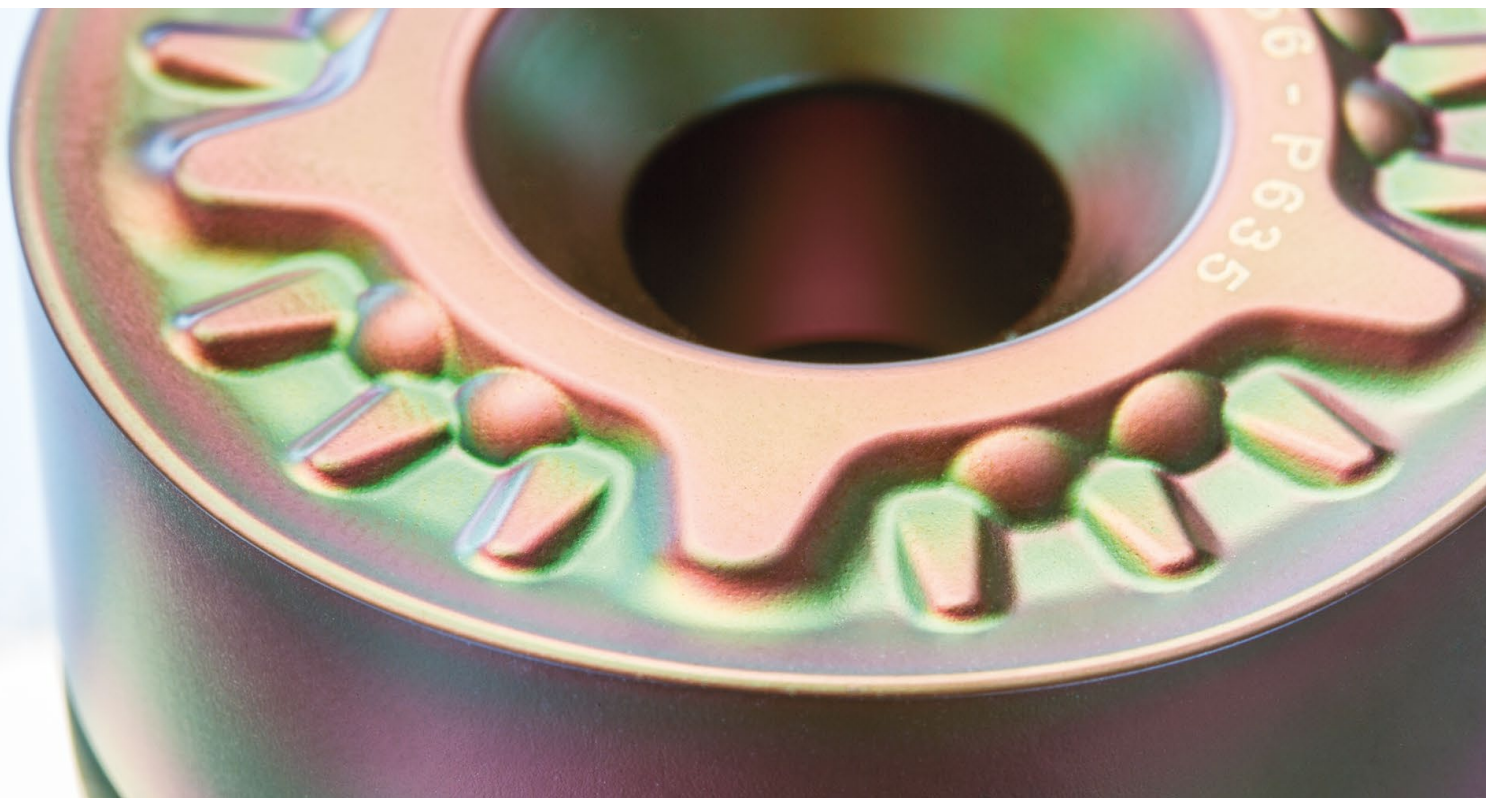

Peeling inserts for ROUGHING and FINISHING – code “R”

LNGF 23..-R50

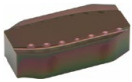

$L_n = 23$ $a_p = 3.0$

LNGF 23..-R51



$L_n = 23$ $a_p = 3.0$

LNGF 23..-R59

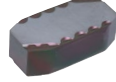

$L_n = 23$ $a_p = 3.0$

WNEF 16..-R50

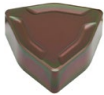

$L_n = 16$ $a_p = 7.0$

WNEF 16..-R51



$L_n = 16$ $a_p = 7.0$

WNEF 16..-R55

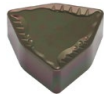

$L_n = 16$ $a_p = 7.0$

WNEF 16..-R59

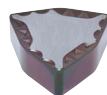

$L_n = 16$ $a_p = 7.0$

WNEU 16..-R50

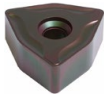

$L_n = 16$ $a_p = 7.0$

WNEU 16..-R51



$L_n = 16$ $a_p = 7.0$

WNEU 16..-R55

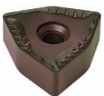

$L_n = 16$ $a_p = 7.0$

WNEU 16..-R59

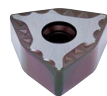

$L_n = 16$ $a_p = 7.0$

WNMF 96..

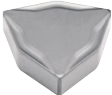

$L_n = 16$ $a_p = 6.0$

WNMF 96.. -R51

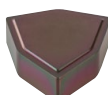

$L_n = 16$ $a_p = 6.0$

WNMF 96.. -R54

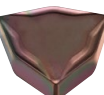

$L_n = 16$ $a_p = 6.0$

YNGX 15..-R50



$L_n = 15$ $a_p = 3.5$

YNGX 15..-R52



$L_n = 15$ $a_p = 3.5$

YNGX 17..-R52

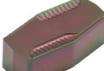

$L_n = 17$ $a_p = 4.0$

L_n = length of secondary cutting edge

a_p = maximum depth of cut

Chip groove code ROUGHING/FINISHING inserts – code “R”



positive

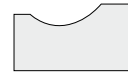

neutral
chip groove code



negative

Finishing insert code “R”

R = Rough (depth of cut $a_p > 3.0$ mm)

		positive	neutral chip groove code	negative
LNGF 231025	Page 70–72	R50	R51	R59
LNGF 231225	Page 70–72	R50	R51	R59
WNEF 161325	Page 89, 90		R55	R50 R51 R59
WNEU 161325	Page 91–94		R55	R50 R51 R59
WNEU 161425	Page 91, 93		R55	R50 R51 R59
WNMF 96	Page 99, 100		R51 R54	
YNGX 150820	Page 101, 102	R50		R52
YNGX 171215	Page 103			R52

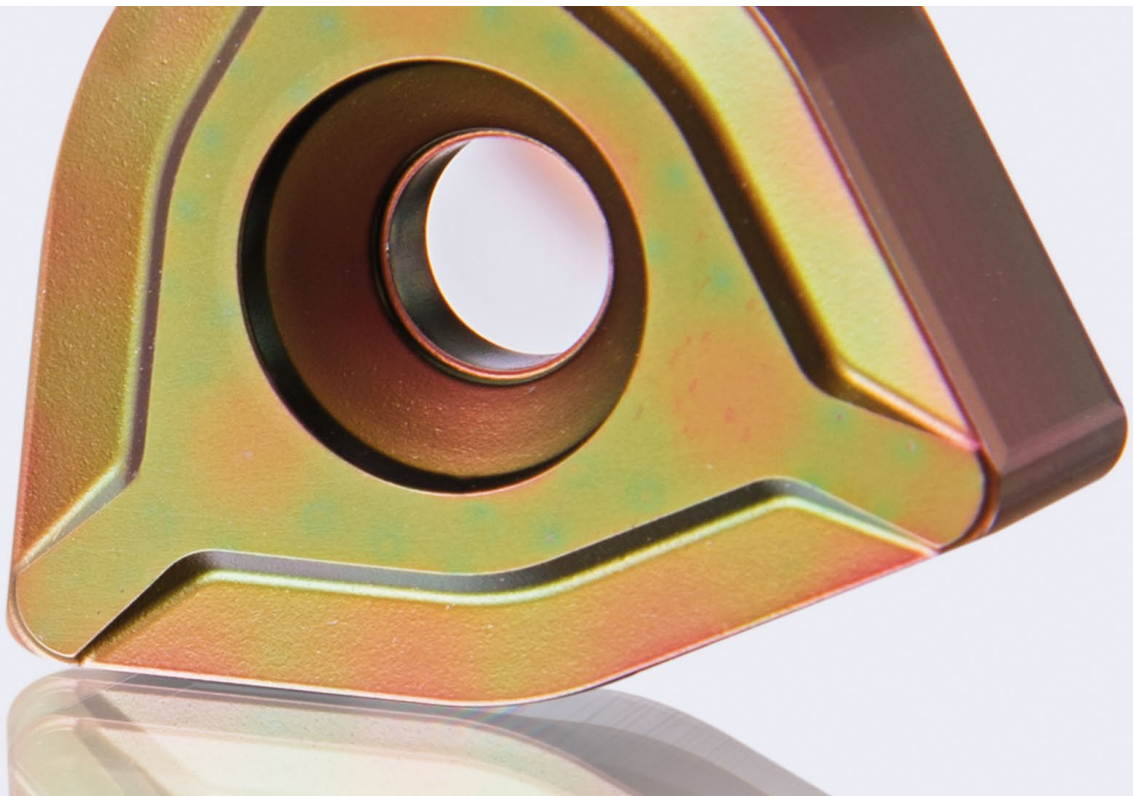

Peeling inserts for FINISHING – code “M” and “F”

NNUX 12..-M40



$L_n = 12$ $a_p = 1.5$

NNUX 15..-M43



$L_n = 15$ $a_p = 2.0$

NNUX 15..-M46



$L_n = 15$ $a_p = 2.0$

NNUX 20..-M40



$L_n = 20$ $a_p = 2.5$

NNUX 20..-M41



$L_n = 20$ $a_p = 2.5$

NNUX 20..-M43



$L_n = 20$ $a_p = 2.5$

NNUX 20..-M46



$L_n = 20$ $a_p = 2.5$

NNXX 20..-M40



$L_n = 20$ $a_p = 2.5$

NNUX 27..-M43



$L_n = 27$ $a_p = 2.5$

WNGU 10..-M46

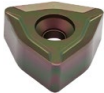

$L_n = 10$ $a_p = 3.0$

WNGU 15..-M50

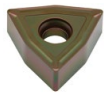

$L_n = 15$ $a_p = 3.0$

WNGU 15..-M52



$L_n = 15$ $a_p = 3.0$

WNMF 11..-M43



$L_n = 11$ $a_p = 3.0$

WNMF 11..-M41



$L_n = 11$ $a_p = 3.0$

YNUX 10..-M50



$L_n = 10$ $a_p = 2.0$

YNGX 15..-M50

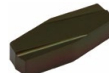

$L_n = 15$ $a_p = 3.0$

YNUF 17..-M48



$L_n = 17$ $a_p = 1.5$

YNUF 2009..-M48



$L_n = 20$ $a_p = 2.0$

YNUF 2012..-M48



$L_n = 20$ $a_p = 2.0$

YNUF 17..-M50



$L_n = 17$ $a_p = 1.5$

YNUF 2009..-M50



$L_n = 20$ $a_p = 2.0$

YNUF 2012..-M50

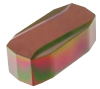

$L_n = 20$ $a_p = 2.0$

YNUF 24..-M50



$L_n = 24$ $a_p = 1.2$

YNUF 27..-M50



$L_n = 27$ $a_p = 2.0$

YNUR 27..-M40



$L_n = 27$ $a_p = 3.0$

TNGT 22..-F46



$L_n = 22$ $a_p = 1.0$

L_n = length of secondary cutting edge

a_p = maximum depth of cut

Chip groove code FINISHING – code “M” and “F”



positive



neutral



negative

Finishing insert code “M”

M = Medium (depth of cut a_p 1.0–3.0 mm)

chip groove code

Product Code	Page	positive	neutral	negative
NNUX 120800	Page 73	M40		
NNUX 150820	Page 74, 75		M43	M46
NNUX 201020	Page 76–81	M35 M40 M48	M41 M42 M43	M45 M46
NNXX 201020	Page 83		M40	
NNUX 271220	Page 82		M43	
WNGU 101025	Page 95			M46
WNGU 151015	Page 96, 97		M50	M52
WNMF 110615	Page 98		M41 M43	
YNGX 150815	Page 101			M50
YNUX 100615	Page 104	M50		
YNUF 170820	Page 105, 106	M48	M50	
YNUF 200920	Page 105, 106	M48	M50	
YNUF 201220	Page 106	M48	M50	
YNUF 241020	Page 106		M50	
YNUF 271220	Page 106		M50	
YNUR 271220	Page 107		M40	



positive



neutral



negative





Finishing insert code „F”

F = Fine (depth of cut $a_p < 1,0$ mm)

chip groove code

TNGT 220815	Page 88			F46
-------------	---------	--	--	-----

Hexagonal roughing insert HNMJ 131050, HNMH/J 221550 and HNMH/J 281850

	Workpiece / material	Type of treatment	Alloy	VDI 3323 group	Hardness [HB]	Chip breaker Recommendation
P	Unalloyed steel	Annealed	≤ 0.15% C	1	125	R57 
	Unalloyed steel	Annealed	0.15%–0.45% C	2	150-250	
	Unalloyed steel	Tempered	≥ 0.45% C	3	300	
	Low-alloy steel	Annealed		6	180	
	Low-alloy steel	Tempered		7 / 8	250-300	
	Low-alloy steel	Tempered		9	350	
	High-alloy steel	Annealed		10	200	
	High-alloy steel	Tempered		11	350	
	Stainless steel	Annealed	Ferritic / martensitic	12	200	
	Stainless steel	Tempered	Martensitic	13	325	
	Stainless steel	Heat-treated	Ferritic / martensitic	13	200	R57 
M	Stainless steel	Quenched	Austenitic	14	180	R51 
	Stainless steel	Quenched	Ferritic / austenitic (Duplex)	14	230-260	
	Stainless steel	Age-hardened	Austenitic precipitation hardened (PH)	14	330	
K	Cast iron			15-20	130-260	Not yet peeled
N	Non-ferrous metals			21-30	80-130	R51 
S	Heat-resistant alloys			31-35	200-350	R51 
	Titanium alloys			36 / 37	150-300	Not yet peeled

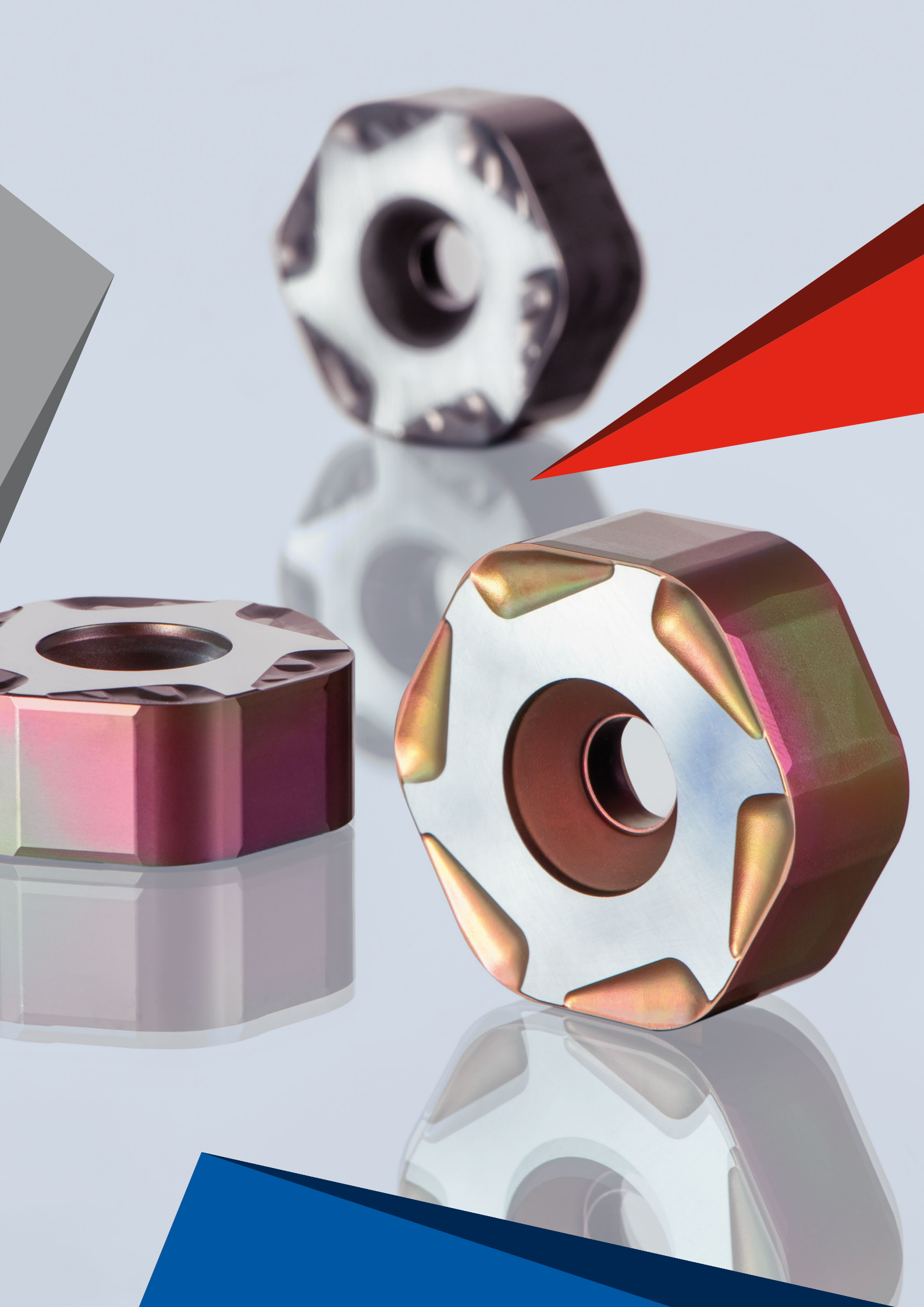

Tool holders and cartridges

The majority of the bar peeling tools used on the market are types specific to the manufacturers of bar peeling machines. Below you can find an extract of peeling machine types including the names of manufacturers that are used by our customers:

- ▲ Bültmann, Germany
- ▲ EJP – Farmer Norton, Germany
- ▲ Lindemann – Calow, Germany
- ▲ SMS Schumag – Kieserling, Germany
- ▲ Danieli, Italy
- ▲ Landgraf, Italy
- ▲ MAIR Research, Italy
- ▲ SAS, Italy
- ▲ Daisho, Japan
- ▲ Hetran-B, USA
- ▲ Medart, USA

Due to the numerous different brands and versions, we only have some of the types more frequently used on the market as standard items in stock. However, we do of course provide our customers with the option to order their exact machine-specific tool holder and/or cartridge type from us. These tools are produced to order with acceptable delivery times. High-quality tool steels are used here, observing narrow tolerances and case-hardened against wear.

Examples of machine-specific tool holders:

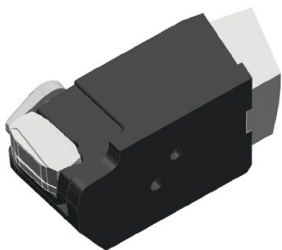

Bültmann / SMS Schumag



MAIR Research

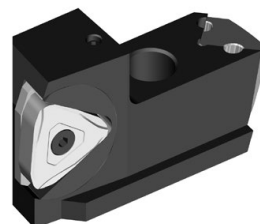

Kieserling

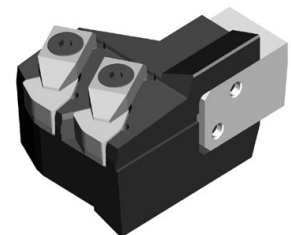

Daisho

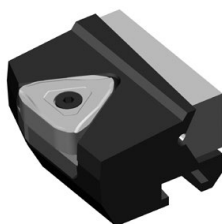

Calow



Farmer Norton



Hetran-B

Based on the metal removal performance required from the machine, different cartridge systems are used: from the SINGLE system to the TANDEM system or TRIO system.

By increasing the number of inserts in the cartridge the total depth of cut is divided into various single depths of cut, thus reducing the stress per insert and so maximising the tool life of the entire system.

SINGLE cartridge system

- ▲ For light to medium machining
- ▲ Low depth of cut up to max. $a_p = 2.0$ mm



TANDEM cartridge system

- ▲ For roughing and medium machining
- ▲ Depth of cut $a_p = 5.0 + 1.5$ mm = 6.5 mm



Trio cartridge system

- ▲ For rough machining with maximum metal removal rates
- ▲ Depth of cut $a_p = 5.0 + 3.5 + 1.5$ mm = 10 mm and more

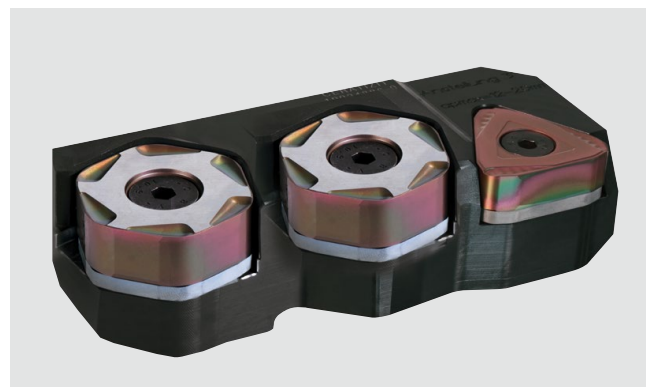

Different insert clamping methods

The basic condition for a satisfactory peeling result is the exact and secure fixing of the insert in the peeling tool. In practice the following two variants of insert clamping are used:

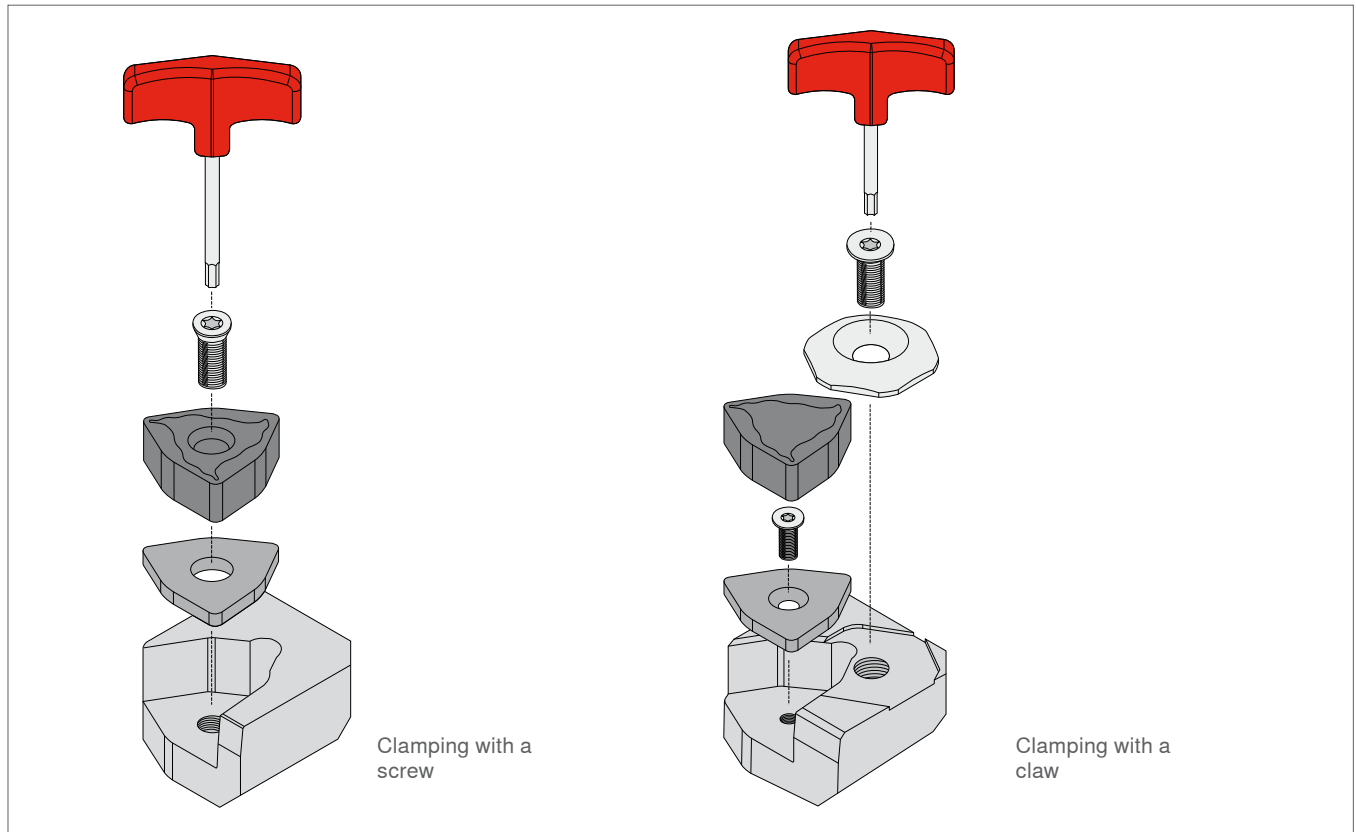

Advantages of screw clamping

Compared to insert clamping with a claw, the clamping method with a screw allows the precise positioning of the insert in the seat, clamping it accurately in both radial and axial direction. The screw clamping system is an economical solution, as the screw is the only spare part. The very compact design, without protruding components, avoids chip evacuation problems and wear of the clamping parts.

Advantages of claw clamping

When using the clamping claw, the claw only needs to be lifted slightly to index or replace the insert, unlike when clamping with the screw method.

Locking torque of fixing screws

Screw thread	maximum locking torque [Nm] per property class		
	8.8	10.9	12.9
M4	3	4.6	6.1
M5	5.9	8.6	10
M6	10.1	14.9	17.4
M8	24.6	36.1	42.2
M10	48	71	83

Quick and easy clamping method for hexagonal peeling inserts

Thanks to the new and patent-pending clamping method, changing a cutting edge on the hexagonal peeling inserts is now even easier and quicker. Cartridge, peeling insert and clamping system are perfectly matched: This ensures that the insert is securely positioned in the cartridge and cannot rotate or loosen during the production process.

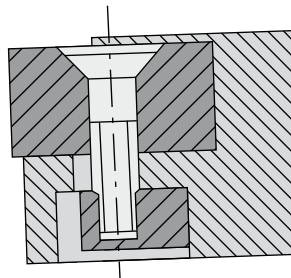

Sectional view



Detailed view of the bottom side

The new clamping method for an even easier and quicker cutting edge change:



1) Undo the clamping screw by 180°



2) Pull the indexable insert out of the insert seat

3) Turn the indexable insert **clockwise** by an additional cutting edge



4) Push the insert back into the insert seat

5) Secure the insert again with the clamping screw

Peeling tools – use of carbide shims

A crucial point for the reliable operation of peeling tools is the use of a carbide shim adapted to the external profile of the peeling insert. On the one hand it gives the cutting insert the necessary support in the insert seat, while on the other it protects the location face of the insert seat from deformation and dents. Moreover the carbide shim prevents erosion of the tool holder caused by swarf damage which frequently occurs in peeling operations due to the limited space inside the peeling head. In the peeling process, fundamentally the secondary cutting edge must be exactly aligned with the work piece axis. A cutting edge positioned below the centre causes vibrations, one positioned above the bar axis causes high cutting pressure, hardening of the bar surface and plastic deformation of the cutting edge, which in the long run eventually has a negative impact on the insert's service life.

Thanks to the varying thickness of the shims the correct position of the cutting edge can be set to the centre of the bar. The absence of wear markings on the support chamfer, splintering on the cutting edge and massive wear on the chip groove indicate that the cutting edge is positioned below the work piece axis. Extreme wear on the support chamfer on the other hand, together with reduced wear on the chip groove, indicates that the cutting edge is above the work piece axis.



The use of carbide shims prevents erosion, deformation and dents in the tool holder.

U-LNGF 2312



U-RNMH 5018



U-WNEU 1613



The carbide shim is adapted to the external profile of the insert.

Precise setting of the tool holders



Adjustable tool holder



Non-adjustable tool holder

Mounting device for presetting of a tool holder

The roundness and diameter tolerance of the bright steel bars produced depends essentially on the precision of the tool holder set. So when producing bars with precise ISO tolerances, in addition to regular cleaning and maintenance of the tool holders, it is essential to set them accurately, off the machine, before mounting them on the peeling head.

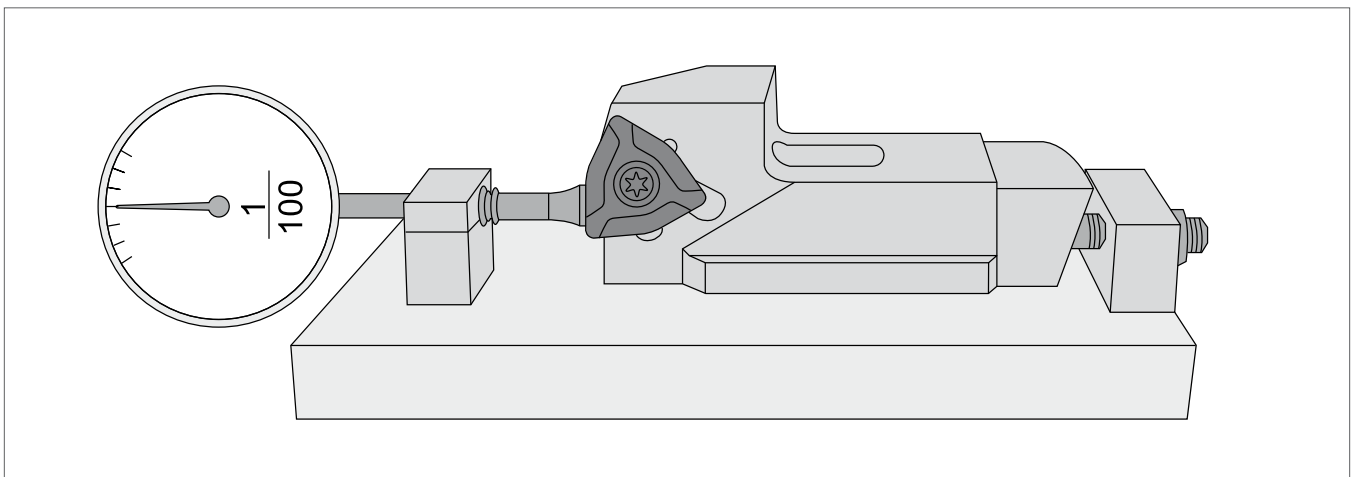

For exact pre-setting of the tool holder set's length, the gauge on the ground support chamfer has to be positioned as accurately as possible in the centre of the secondary cutting edge. The same reference point must be chosen for each tool set for the point of contact of the adjustable wedge, to avoid measurement deviations. This guarantees that all insert cutting edges of a tool holder set (generally comprising 4 to 8 tool holders) work to the same circumference, in such a way as to ensure the required roundness and surface roughness of the bar.

Surface quality

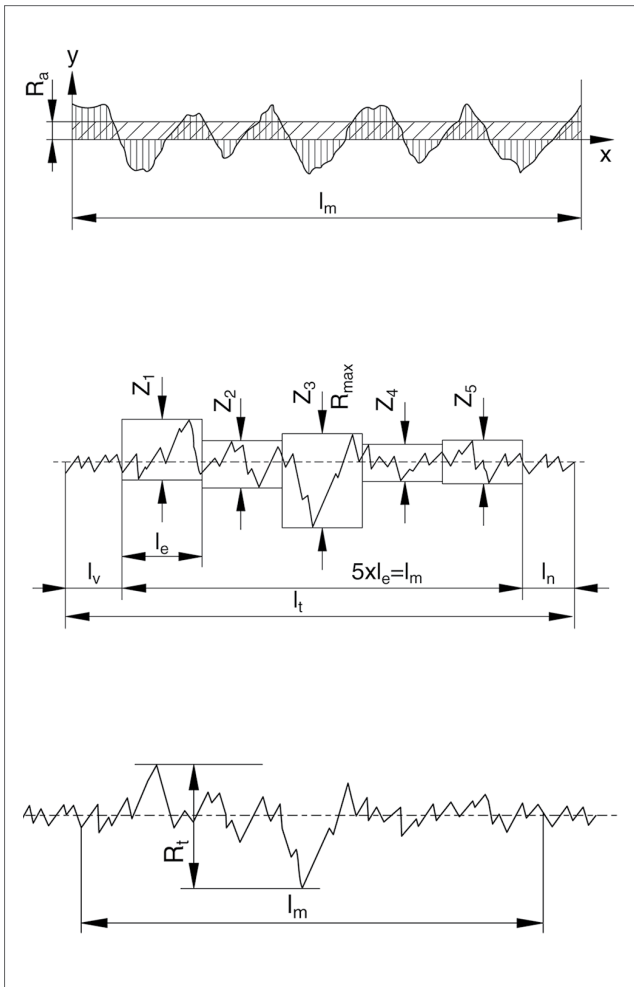

Average roughness value R_a (DIN 4768)

This is defined as the arithmetical mean of the absolute sums of the roughness profile R within the entire measured length l_m .

Average roughness depth R_z (DIN 4768)

is the mean of the individual roughness depths in five successive individual measuring sections l_e .

Single surface roughness depth $Z_1 \dots Z_5$

This is the vertical distance between the highest and the lowest point of the roughness profile R within a single measured length l_e .

Maximum surface roughness depth R_t (DIN 4768/1)

This is the distance between the elevation and depression of the line within the measured length (reference distance) of profile filtered according to DIN 4768 sheet 1.

Surface quality based on the production method

Surface symbol according to ISO 1302	neu	0,025	0,05	0,1	0,2	0,4	0,8	1,6	3,2	6,3	12,5	25	50
Surface symbol according to ISO 3141	bisher	✓	✓	✓	✓	✓	✓	✓	✓	✓	✓	✓	✓
Roughness index		N 1	N 2	N 3	N 4	N 5	N 6	N 7	N 8	N 9	N 10	N 11	N 12
Arithmetic mean value	R_a [μm]	0,025	0,05	0,1	0,2	0,4	0,8	1,6	3,2	6,3	12,5	25	50
Surface roughness depth	R_z [μm]	0,25	0,63	1	1,6	2,5	4-6,3	10	16-25	40	63	100	160
Longitudinal turning – face turning													
Longitudinal grinding													
Surface grinding													

☐ ≙ Surface roughness (produced through special methods)

☐ ≙ Surface roughness (produced through normal workshop methods)

☐ ≙ Surface roughness (produced through rough machining methods)

Productivity and efficiency

Along with high process reliability and high metal removal rates, the need for perfect bar surfaces and form accuracy are the most important criteria for our bar peeling customers.

An important prerequisite for the above requirements is the choice of the peeling machine. Different machining methods and combinations of cutting inserts in SINGLE, TANDEM or TRIO cartridge systems entail varying levels of power consumption on the part of the peeling machine. The formula below serves for an approximate calculation of the necessary power consumption P [kW], on the basis of which the number of the usable cutting edges or inserts can then be determined:

Formula for the calculation of power consumption

$$P = \frac{(v_c \cdot a_p \cdot f \cdot K_c 1.1)}{60000} \cdot \left(\frac{0.4}{f} \right)^{0.29} \text{ [kW]}$$

v_c	= cutting speed	[m/min]
a_p	= depth of cut	[mm]
f	= feed rate per cartridge	[mm/rev.]
$K_c 1.1$	= specific cutting force	[N/mm ²]

It has to be taken into account that the approximately calculated drive output applies only to one cartridge system. If the peeling machine is equipped with a peeling head comprising 4 cartridges / tool slides, the power consumption resulting from the formula has to be multiplied by a factor of 4. Regarding the depth of cut (a_p), it has to be taken into account that in case of a TANDEM or TRIO system the individual radial depths of cut of all roughing and finishing inserts are cumulated.

Feed rate and depth of cut

The major influencing factors in terms of productivity are the feed rate and the depth of cut. These, however, are limited by the possibilities and the state of repair of the peeling machine and its peeling tools, as well as by the condition of the raw material, all of which inevitably generate vibrations. In the last resort, the reduction of vibrations during the peeling process is the winning formula for productivity and product quality. The preparation of the support chamfer, based on the quality and hardness of the material which is to be machined, contributes additional stability to the peeling process. The nominal value of the support chamfer angle determines whether the finishing insert, which is aligned parallel to the axis, forms a clearance angle between the bar and the support chamfer. If it does so, these are described as positive inserts. The inserts are described as neutral when they have a form lock with the bar, while negative inserts exert massive pressure on the bars. Depending on their nature, different materials need the properties of the cutting insert to be adapted accordingly.

The support chamfer angle and the length of the secondary cutting edge in the last resort influence the surface quality of the bars, and also, importantly, the choice of the correct insert for the respective depth of cut a_p . Chip grooves which are specifically adapted to the material's properties break the chips produced during the peeling process to an acceptable length. In this context the depth of cut is a significant factor. As described in previous sections, in bar peeling there are different inserts for roughing, for medium machining and for finish machining. The designations of the CERATIZIT chip grooves already indicate the application range in terms of depth of cut a_p . Chip groove designations with the letter R (Rough) should be used for depths of cut larger than 3.0 mm. Chip grooves with the letter M (Medium) should be used for depths of cut between 1.0 and 3.0 mm, and those with the letter F (Fine) for depths of cut less than 1.0 mm – these are in all cases suitable for finishing operations. Based on this selection the best possible cutting conditions can be obtained, the cutting forces are optimally distributed and tool life will be ideally prolonged. When using TANDEM cartridge systems, the major part of the material should be removed by the roughing insert: the depth of cut of the finishing insert – depending on its type – should be between 0.5 and 1.8 mm.

Machining examples

Finishing with the SINGLE system

Depth of cut $a_p = 1.2$ mm
Bar diameter = 28 mm h9
Material: Cf 53 W.Nr. 1.1213

Specific cutting force:
 $K_c 1.1 = 1525$ N/mm²

Insert:
YNUF 241020-M50

$f = 16$ mm/rev.
 $v_c = 135$ m/min
→ **P = 23 kW**

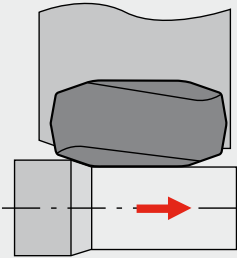

Medium machining with the SINGLE system

Depth of cut $a_p = 3$ mm
Bar diameter = 70 mm
Material: X 20 CrNi 17-2 W.Nr. 1.4057

Specific cutting force:
 $K_c 1.1 = 1875$ N/mm²

Insert:
WNEU 161425-R50

$f = 12$ mm/U
 $v_c = 100$ m/min
→ **P = 42 kW**

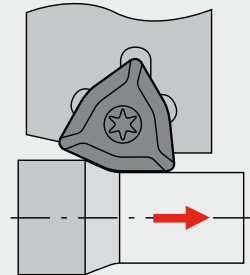

Roughing and medium machining with the TANDEM system

Depth of cut $a_p = 3,5 + 1,5 = 5$ mm
Bar diameter = 220 mm
Material: X6 CrNiMoTi 17-12-2 W.Nr. 1.4571

Specific cutting force:
 $K_c 1.1 = 2150$ N/mm²

Insert:
RNMH 5018MO + YNUF 201220-M50

$f = 14$ mm/rev.
 $v_c = 60$ m/min
→ **P = 54 kW**

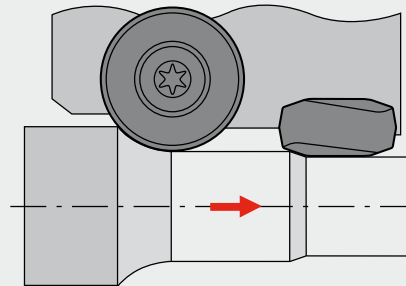

The calculated power value applies to just one tool holder. In case of a peeling head with 4 tool holders, the power has to be multiplied by 4.

Calculation of the medium chip thickness h_m

For inserts form L, N, T, W, Y

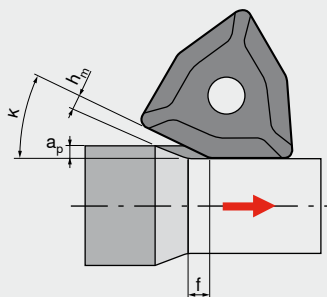

$$h_m \approx f \cdot \sin(\kappa)$$

For inserts form R

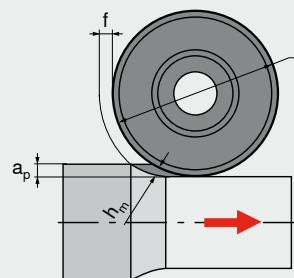

$$h_m \approx f \cdot \sqrt{\frac{a_p}{d}}$$

Bar peeling formulas

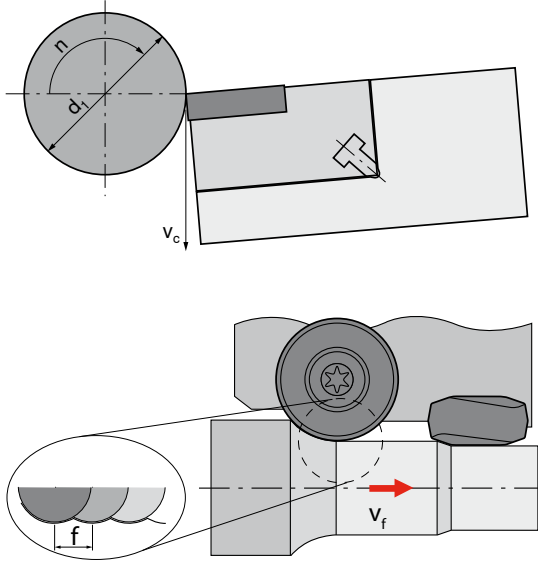

Cutting speed [m/min]:

$$v_c = \frac{d_1 \cdot \pi \cdot n}{1000}$$

Peeling head rev number [rev./min]

$$n = \frac{v_c \cdot 1000}{d_1 \cdot \pi}$$

Feed rate per revolution [mm/rev.]

$$f = \frac{v_f}{n}$$

Feed rate [m/min]

$$v_f = f \cdot n$$

Metal removal rate [cm³/min]

$$Q = a_p \cdot f \cdot v_c$$

Calculation example::

Insert:
YNUF 271220S50-M50 CTCP625

Bar diameter:
Ø 77 mm

Depth of cut (a_p):
1 mm

Feed rate (f):
22 mm/rev.

Selected cutting speed (V_c):
160 m/min

Calculation of rev number:

$$n = \frac{160 \cdot 1000}{77 \cdot \pi} = 661 \text{ (rev./min)}$$

Feed rate calculation:

$$v_f = 22 \cdot 661 = 14542 \text{ mm/min} \\ = 14.5 \text{ m/min}$$

Calculation of metal removal rate:

$$Q = 1 \cdot 22 \cdot 160 = 3520 \text{ (cm}^3\text{/min)}$$

Conversion inch ↔ metric

1 inch	=	2.54 cm = 0.0254 m
1 foot	=	12 inches = 30.48 cm = 0.3048 m
1 meter	=	approx. 39.37 inches = approx. 3.2808 feet

Troubleshooting for turning problems

Type of problem

Type of wear					Work piece problems					
Flank wear	Cratering	Notching	Thermal cracking	Edge chipping	Insert breakage	Flaking	Surface quality	Vibrations	Formation of burrs	Corrective measures
	↓		↓			↓	↑	↓		Cutting speed v_c
↑	↑	↓	↓	↓		↑	↓	≈	↑	Feed rate f
↑			↓	↓					↑	Depth of cut a_p
	↓		↓	↑	↑	↓	↓		↓	Chamfer angle 35° heavily interrupted cut Chamfer angle 25° continuous or slightly interrupted cut Chamfer angle 15° continuous or slightly interrupted cut
		↑		↑	↑	↑	↑	↓	↓	Corner radius larger ↑ smaller ↓
↓	↓		↓	↓	↑	↓	↓	↓	↓	Hone
			≈	≈	≈	≈	≈	≈		Clamping of tool
			≈	≈	≈	≈	≈	≈		Clamping of work piece
			≈	≈	↓	↓	↓	↓		Overhang
≈				≈	≈	≈	≈	≈		Tip height
■	■	■	■	■					■	Cooling lubricant

↑ raise, increase, large influence
↑ raise, increase low influence

↓ avoid, reduce large influence
↓ avoid, reduce low influence

≈ check, optimise
■ use
□ don't use

Troubleshooting for bar peeling problems

Problem	Possible causes	Corrective measures
Bar not perfectly round	Inserts not on the same circumference →	Readjust tool holder, check insert tolerance, perhaps use ground inserts
	The bar is not inserted centrally in relation to the peeling head →	Check position of guide rolls
	Large variety of initial material →	Check for deviations
Gradations on the surface (saw-tooth pattern)	The secondary cutting edge of one or more of the inserts is not parallel to the bar →	Check position of secondary cutting edge, and adjust if necessary
	Feed rate per revolution exceeds the length of the secondary cutting edge →	Reduce feed rate
	Incorrect clamping in the insert seat (soiling in the insert seat) →	Check clamping, clean insert seat
Poor chip formation	Insufficient feed rate →	Increase feed rate
	Wrong chip groove →	Check suitability of chip groove
	Insufficient coolant →	Increase coolant supply
Vibration marks	Incorrect support chamfer →	Check support chamfer size
	Secondary cutting edge too sharp (hacks into the material) →	Hone edge
	Cutting edge is too far below the centre →	Check centre height
	Guide rolls or jaws are not positioned correctly →	Check and readjust
Widely varying wear from one insert to the next	Tools incorrectly adjusted (one insert works at greater depth of cut than the others) →	Check alignment and readjust
Edge chipping	Wrong protective chamfer for cutting edge →	Increase width of chamfer, increase chamfer angle
	Feed rate too high →	Reduce feed rate
	Honing too small →	Further honing needed
	Wrong grade being used →	Use tougher grade

Causes of wear

Wear is caused through simultaneous mechanical and thermal stress of the cutting edge. The most common causes are:

- ▲ Mechanical abrasion
- ▲ Damage due to built-up edge (BUE)
- ▲ Oxidation processes
- ▲ Diffusion

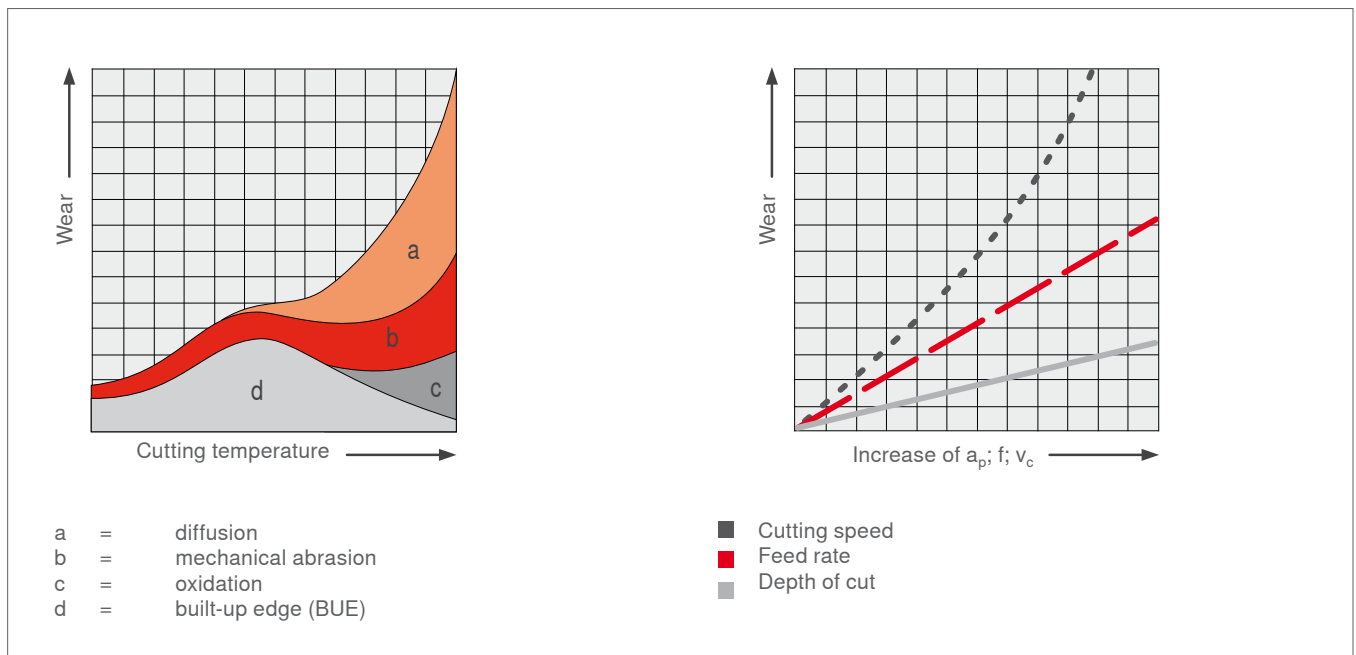

With increasing cutting temperature the thermally caused wear types of oxidation and diffusion prevail.

Cutting temperature and wear depend decisively upon the machining conditions.



Benefits of hard material coatings



Depositing hard material layers on carbide tools positively influences wear characteristics.

- ▲ Friction
- ▲ Temperature changes
- ▲ Oxidation
- ▲ Diffusion

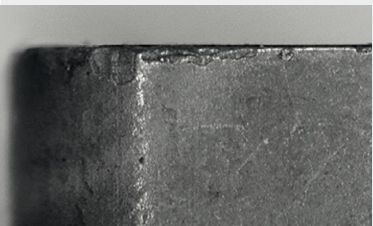
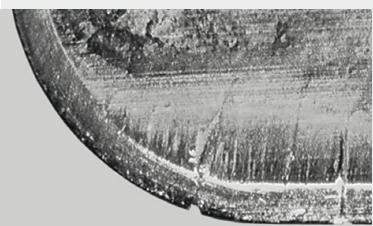
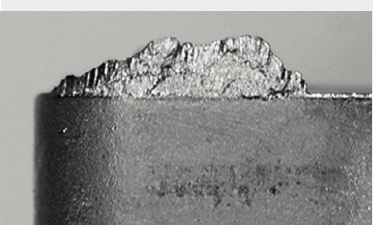
Causes of wear

<p>Flank wear</p>  <p>Abrasion on flank, normal wear after a certain machining time.</p>	<table border="1"> <thead> <tr> <th>Cause</th> <th></th> <th>Remedy</th> </tr> </thead> <tbody> <tr> <td>Cutting speed too high</td> <td>→</td> <td>Reduce cutting speed</td> </tr> <tr> <td>Carbide grade with insufficient wear resistance</td> <td>→</td> <td>Select more wear-resistant carbide grade</td> </tr> <tr> <td>Incorrect feed rate</td> <td>→</td> <td>Adapt feed rate to cutting speed and cutting depth (increase feed rate)</td> </tr> </tbody> </table>	Cause		Remedy	Cutting speed too high	→	Reduce cutting speed	Carbide grade with insufficient wear resistance	→	Select more wear-resistant carbide grade	Incorrect feed rate	→	Adapt feed rate to cutting speed and cutting depth (increase feed rate)						
Cause		Remedy																	
Cutting speed too high	→	Reduce cutting speed																	
Carbide grade with insufficient wear resistance	→	Select more wear-resistant carbide grade																	
Incorrect feed rate	→	Adapt feed rate to cutting speed and cutting depth (increase feed rate)																	
<p>Edge chipping</p>  <p>Through excessive mechanical stress at the cutting edge fracture and chipping can occur.</p>	<table border="1"> <thead> <tr> <th>Cause</th> <th></th> <th>Remedy</th> </tr> </thead> <tbody> <tr> <td>Grade with too high wear resistance</td> <td>→</td> <td>Use tougher grade</td> </tr> <tr> <td>Vibration</td> <td>→</td> <td>Use negative cutting edge geometry with chip groove</td> </tr> <tr> <td>Feed rate too high or excessive cutting depth</td> <td>→</td> <td>Adapt cutting values</td> </tr> <tr> <td>Interrupted cut</td> <td>→</td> <td>Use tougher grade or more stable geometry</td> </tr> <tr> <td>Swarf damage</td> <td>→</td> <td>Use different chip breaker</td> </tr> </tbody> </table>	Cause		Remedy	Grade with too high wear resistance	→	Use tougher grade	Vibration	→	Use negative cutting edge geometry with chip groove	Feed rate too high or excessive cutting depth	→	Adapt cutting values	Interrupted cut	→	Use tougher grade or more stable geometry	Swarf damage	→	Use different chip breaker
Cause		Remedy																	
Grade with too high wear resistance	→	Use tougher grade																	
Vibration	→	Use negative cutting edge geometry with chip groove																	
Feed rate too high or excessive cutting depth	→	Adapt cutting values																	
Interrupted cut	→	Use tougher grade or more stable geometry																	
Swarf damage	→	Use different chip breaker																	
<p>Thermal cracking</p>  <p>Small cracks at 90° to cutting edge.</p>	<table border="1"> <thead> <tr> <th>Cause</th> <th></th> <th>Remedy</th> </tr> </thead> <tbody> <tr> <td>Varying temperature of cutting edge, thermal shock</td> <td>→</td> <td>Use grade that is resistant to thermal cracking</td> </tr> <tr> <td>Incorrect cooling</td> <td>→</td> <td>Apply cooling lubricant abundantly or use dry milling</td> </tr> <tr> <td>High tensile materials</td> <td>→</td> <td>Select suitable cutting parameters</td> </tr> <tr> <td>Cutting speed too high</td> <td>→</td> <td>Reduce cutting speed</td> </tr> </tbody> </table>	Cause		Remedy	Varying temperature of cutting edge, thermal shock	→	Use grade that is resistant to thermal cracking	Incorrect cooling	→	Apply cooling lubricant abundantly or use dry milling	High tensile materials	→	Select suitable cutting parameters	Cutting speed too high	→	Reduce cutting speed			
Cause		Remedy																	
Varying temperature of cutting edge, thermal shock	→	Use grade that is resistant to thermal cracking																	
Incorrect cooling	→	Apply cooling lubricant abundantly or use dry milling																	
High tensile materials	→	Select suitable cutting parameters																	
Cutting speed too high	→	Reduce cutting speed																	
<p>Built-up edge</p>  <p>Built-up edge occurs when the chip is not evacuated properly due to insufficient cutting temperature.</p>	<table border="1"> <thead> <tr> <th>Cause</th> <th></th> <th>Remedy</th> </tr> </thead> <tbody> <tr> <td>Cutting speed too low</td> <td>→</td> <td>Increase cutting speed</td> </tr> <tr> <td>Rake angle too small</td> <td>→</td> <td>Increase rake angle</td> </tr> <tr> <td>Wrong cutting material</td> <td>→</td> <td>Apply TiN coating</td> </tr> <tr> <td>Lack of cooling / lubrication</td> <td>→</td> <td>Use emulsion with higher concentration</td> </tr> </tbody> </table>	Cause		Remedy	Cutting speed too low	→	Increase cutting speed	Rake angle too small	→	Increase rake angle	Wrong cutting material	→	Apply TiN coating	Lack of cooling / lubrication	→	Use emulsion with higher concentration			
Cause		Remedy																	
Cutting speed too low	→	Increase cutting speed																	
Rake angle too small	→	Increase rake angle																	
Wrong cutting material	→	Apply TiN coating																	
Lack of cooling / lubrication	→	Use emulsion with higher concentration																	

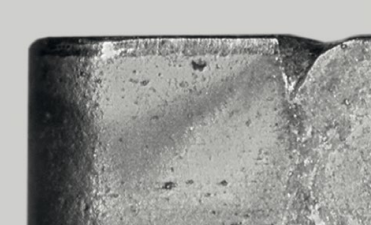
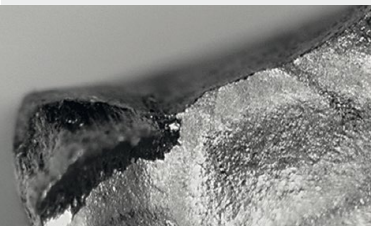
Causes of wear

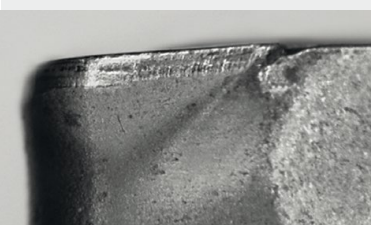
<p>Notching</p>  <p>Notch at the maximum cutting depth.</p>	<table border="1"> <thead> <tr> <th>Cause</th> <th></th> <th>Remedy</th> </tr> </thead> <tbody> <tr> <td>Cold work hardening materials (e.g. super alloys)</td> <td>→</td> <td>Decrease cutting speed</td> </tr> <tr> <td>Cast and forging skin</td> <td>→</td> <td>Use smaller setting angle</td> </tr> <tr> <td>Formation of burrs</td> <td>→</td> <td>Change working orientation of the milling cutter</td> </tr> </tbody> </table>	Cause		Remedy	Cold work hardening materials (e.g. super alloys)	→	Decrease cutting speed	Cast and forging skin	→	Use smaller setting angle	Formation of burrs	→	Change working orientation of the milling cutter						
Cause		Remedy																	
Cold work hardening materials (e.g. super alloys)	→	Decrease cutting speed																	
Cast and forging skin	→	Use smaller setting angle																	
Formation of burrs	→	Change working orientation of the milling cutter																	
<p>Insert breakage</p>  <p>Excessive stress of the insert causes breakage.</p>	<table border="1"> <thead> <tr> <th>Cause</th> <th></th> <th>Remedy</th> </tr> </thead> <tbody> <tr> <td>Excessive stress of the carbide grade</td> <td>→</td> <td>Use tougher cutting material or adapt cutting parameter</td> </tr> <tr> <td>Lack of stability</td> <td>→</td> <td>Use protective edge chamfer</td> </tr> <tr> <td>Corner angle too small</td> <td>→</td> <td>Increase edge hone</td> </tr> <tr> <td>Excessive notching</td> <td>→</td> <td>Use more stable geometry and adapt cutting parameter</td> </tr> <tr> <td>Sudden changes of cutting forces</td> <td>→</td> <td>Reduce feed rate</td> </tr> </tbody> </table>	Cause		Remedy	Excessive stress of the carbide grade	→	Use tougher cutting material or adapt cutting parameter	Lack of stability	→	Use protective edge chamfer	Corner angle too small	→	Increase edge hone	Excessive notching	→	Use more stable geometry and adapt cutting parameter	Sudden changes of cutting forces	→	Reduce feed rate
Cause		Remedy																	
Excessive stress of the carbide grade	→	Use tougher cutting material or adapt cutting parameter																	
Lack of stability	→	Use protective edge chamfer																	
Corner angle too small	→	Increase edge hone																	
Excessive notching	→	Use more stable geometry and adapt cutting parameter																	
Sudden changes of cutting forces	→	Reduce feed rate																	
<p>Cratering</p>  <p>The hot chip which is being evacuated causes cratering at the rake face of the cutting edge.</p>	<table border="1"> <thead> <tr> <th>Cause</th> <th></th> <th>Remedy</th> </tr> </thead> <tbody> <tr> <td>Cutting speed and / or feed rate too high</td> <td>→</td> <td>Reduce cutting speed and / or feed rate</td> </tr> <tr> <td>Rake angle too shallow</td> <td>→</td> <td>Use different geometry</td> </tr> <tr> <td>Grade with low wear resistance</td> <td>→</td> <td>Use more wear-resistant grade</td> </tr> <tr> <td>Insufficient coolant supply</td> <td>→</td> <td>Increase coolant quantity and / or pressure, optimise coolant supply</td> </tr> </tbody> </table>	Cause		Remedy	Cutting speed and / or feed rate too high	→	Reduce cutting speed and / or feed rate	Rake angle too shallow	→	Use different geometry	Grade with low wear resistance	→	Use more wear-resistant grade	Insufficient coolant supply	→	Increase coolant quantity and / or pressure, optimise coolant supply			
Cause		Remedy																	
Cutting speed and / or feed rate too high	→	Reduce cutting speed and / or feed rate																	
Rake angle too shallow	→	Use different geometry																	
Grade with low wear resistance	→	Use more wear-resistant grade																	
Insufficient coolant supply	→	Increase coolant quantity and / or pressure, optimise coolant supply																	
<p>Plastic deformation</p>  <p>High machining temperature and simultaneous mechanical stress can lead to plastic deformation.</p>	<table border="1"> <thead> <tr> <th>Cause</th> <th></th> <th>Remedy</th> </tr> </thead> <tbody> <tr> <td>Too high machining temperature, resulting in softening of substrate</td> <td>→</td> <td>Reduce cutting speed</td> </tr> <tr> <td>Damaged coatings</td> <td>→</td> <td>Choose carbide grade with higher wear resistance</td> </tr> <tr> <td>Chip groove too narrow</td> <td>→</td> <td>Use different geometry</td> </tr> </tbody> </table>	Cause		Remedy	Too high machining temperature, resulting in softening of substrate	→	Reduce cutting speed	Damaged coatings	→	Choose carbide grade with higher wear resistance	Chip groove too narrow	→	Use different geometry						
Cause		Remedy																	
Too high machining temperature, resulting in softening of substrate	→	Reduce cutting speed																	
Damaged coatings	→	Choose carbide grade with higher wear resistance																	
Chip groove too narrow	→	Use different geometry																	

Inserts

First-class cutting grades combined with advanced chip breakers create a head start on performance

Based on the different application cases, CERATIZIT offers an extensive range of bar peeling inserts in different geometries and carbide grades for the machining of all classes of material, with the goal of increasing both the productivity and efficiency of the manufacturing processes as well as the quality of the resulting products.

See for yourself!

Designation system inserts (CERATIZIT Standard)

L N G F 23 10 25 S 50 - R 50

① ② ③ ④ ⑤ ⑥ ⑦ ⑧ ⑨ ⑩ ⑪

① Insert shape

	120°	H
	90°	L
	60°	N
	-	R
	60°	T
	80°	W
	100°	Y

② Clearance angle

0°	N
13°	O

③ Tolerances

	B ±		s ±	
	[mm]	[inch]	[mm]	[inch]
C	0.025	.0010	0.025	.0010
E	0.025	.0010	0.05	.0020
G	0.025-0.15*	.0010-.0060*	0.13	.0050
M	0.05-0.17*	.0020-.0070*	0.13	.0050
U	0.08-0.25*	.0030-.0100*	0.13	.0050
X	0.08-0.25*	.0030-.0100*	0.13	.0050

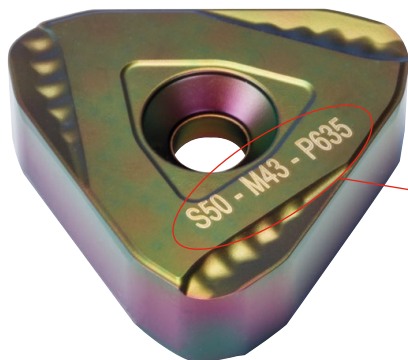

- ▲ Support chamfer type S50 ⑧+⑨
- ▲ Chip groove code M43 ⑩+⑪
- ▲ Grade designation P635 = CTCP63 (page 18–23)

* depends on insert type

⑦ Approach angle

κ	Angle° / radius
MO	radius
00	radius
08	8°
10	10°
15	15°
20	20°
25	25°
50	50°

⑧ Support chamfer type







Definition	Diagram
E NO support chamfer on round inserts – honed cutting edge	
P NO support chamfer on round inserts – negative chamfer on cutting edge	
P Support chamfer on main and secondary cutting edge	
S Support chamfer on secondary cutting edge	

⑨ Support chamfer angle

Definition	Diagram
00 0° – for round inserts	
15 15° negative chamfer angle – for round inserts	
30/33/35/37 3°	
40(42)/43/45/47 4°	
50/53/55/57 5°	
60/63/65/67 6°	

4

Form of top surface

- N 
- R 
- F 
- T 
- U 
- H 
- J 
- X Special version

5

Length of the secondary cutting edge or diameter when using round inserts

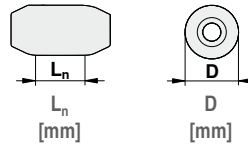

	L_n [mm]	D [mm]
07	7	
08	8	
09	9	
10	10	
11	11	
12	12	
15	15	
16	16	
17	17	
20	20	20
22	22	
23	23	
24	24	
27	27	
28	28	28
38	38	38
50	50	50

6

Insert thickness



s	[mm]	s	[mm]
03	3.50	12	11.90
04	4.76	12	12.15
05	5.00	12	12.20
06	6.00	12	12.35
06	6.35	12	12.45
08	7.50	12	12.70
08	7.70	13	13.20
08	8.00	13	13.30
08	8.10	14	14.20
09	9.05	18	18.20
10	9.70	18	18.30
10	10.00		
10	10.15		
10	10.20		
10	10.35		
10	10.45		
10	10.60		

Example "S53"

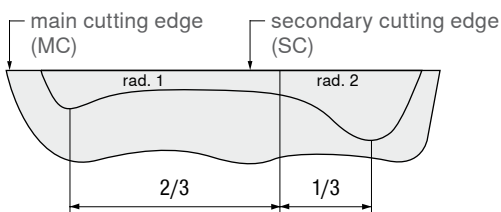

10

Chip groove application range

	Definition	a_p
F	fine	< 1.0 mm
M	medium	1.0 to 3.0 mm
R	coarse	> 3.0 mm

11

Chip groove code

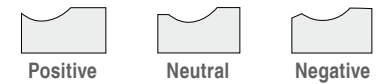

- 35
- 40
- 41
- 42
- 43
- 46
- 48
- 50
- 51
- 52
- 53
- 54
- 55
- 56
- 57
- 59

For details see page 42 to page 47

Detailed definition "50 / 53 / 55 / 57"

Support chamfer angle	Angle	Support chamfer radius	Support chamfer allocation
50	5°	rad. 1	whole width of SC
53	5°	rad. 1 / rad. 2	2/3 or 1/3 of NS
55	5°	rad. 1 / rad. 2	1/2 or 1/2 or NS
57	5°	rad. 1 / rad. 2 / rad. 3	1/5 or 3/5 or 1/5 of NS

HNMJ

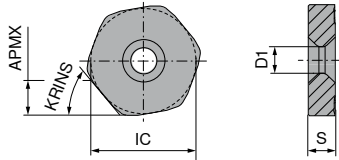

NEW	NEW	NEW	NEW
-R51 CTCP625	-R51 CTCP635	-R57 CTCP625	-R57 CTCP635
DRAGONSKIN	DRAGONSKIN	DRAGONSKIN	DRAGONSKIN
HNMJ	HNMJ	HNMJ	HNMJ
74 017 ...	74 017 ...	74 019 ...	74 019 ...

Designation	IC mm	APMX mm	S mm	D1 mm	KRINS	NOI
HNMJ 131050S60-R51	22	4	10.00	7.2	50°	12
HNMJ 131050S60-R57	22	4	10.00	7.2	50°	12
HNMJ 221550S60-R51	38	8	15.00	9.2	50°	12
HNMJ 221550S60-R57	38	8	15.00	9.2	50°	12
HNMJ 281850S60-R51	50	12	18.00	12.2	50°	12
HNMJ 281850S60-R57	50	12	18.00	12.2	50°	12

P	•	•	•	•
M	•	•	•	•
K	•	•	•	•
N	•	•	•	•
S	•	•	•	•
H				
O				

Spare parts

HN.. 13..		53000		54000
HN.. 22..			53200	54100
HN.. 28..			52500	54200

Screw Indexable inserts	Screw Indexable inserts	HM-Shim
70 950 ...	70 950 ...	70 950 ...

HNMH

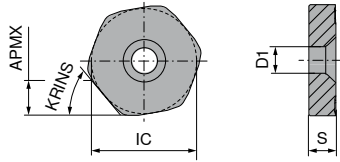

NEW	NEW
-R51 CTCP635	-R57 CTCP635
DRAGONSKIN	DRAGONSKIN
HNMH	HNMH
74 011 ...	74 014 ...
02100	02100
06100	06100

Designation	IC mm	APMX mm	S mm	D1 mm	KRINS	NOI
HNMH 221550S60-R51	38	8	15.00	9.2	50°	6
HNMH 221550S60-R57	38	8	15.00	9.2	50°	6
HNMH 281850S60-R51	50	12	18.00	12.2	50°	6
HNMH 281850S60-R57	50	12	18.00	12.2	50°	6

P	•	•
M	•	•
K		
N		
S	•	•
H		
O		

Screw Indexable inserts	HM-Shim
70 950 ...	70 950 ...

Spare parts

HN.. 22..	53200	54100
HN.. 28..	52500	54200

LNGF

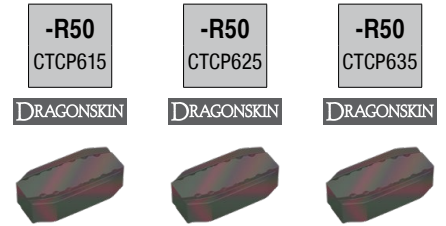
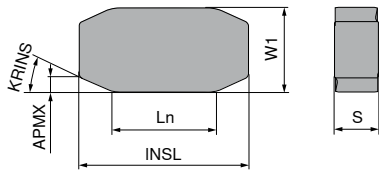

Designation	Ln mm	APMX mm	S mm	KRINS	INSL mm	W1 mm	NOI
LNGF 231025S42-R50	23	3	10.00	25°	40	20	4
LNGF 231025S50-R50	23	3	10.00	25°	40	20	4
LNGF 231225S42-R50	23	3	12.00	25°	40	20	4
LNGF 231225S50-R50	23	3	12.00	25°	40	20	4

Designation	Ln mm	APMX mm	S mm	KRINS	INSL mm	W1 mm	NOI
LNGF 231025S42-R50	23	3	10.00	25°	40	20	4
LNGF 231025S50-R50	23	3	10.00	25°	40	20	4
LNGF 231225S42-R50	23	3	12.00	25°	40	20	4
LNGF 231225S50-R50	23	3	12.00	25°	40	20	4

P							
M							
K							
N							
S							
H							
O							

Spare parts

LN.. 23..

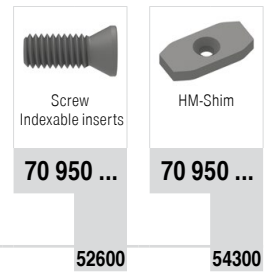

LNGF

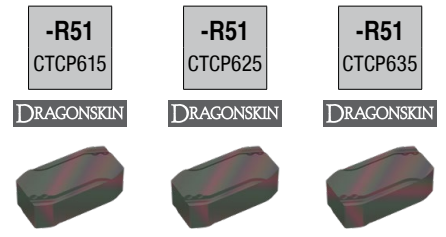
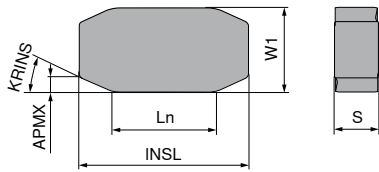

Designation	Material	Part Number
LNGF 74 021 ...	72300	42300
LNGF 74 021 ...	72400	42400
LNGF 74 021 ...	72800	42200
LNGF 74 021 ...	72900	42800
LNGF 74 021 ...		42600
LNGF 74 021 ...		42700

Designation	L _n mm	APMX mm	S mm	KRINS	INSL mm	W1 mm	NOI
LNGF 231025S42-R51	23	3	10.00	25°	40	20	4
LNGF 231025S50-R51	23	3	10.00	25°	40	20	4
LNGF 231025P50-R51	23	3	10.00	25°	40	20	4
LNGF 231225S42-R51	23	3	12.00	25°	40	20	4
LNGF 231225S50-R51	23	3	12.00	25°	40	20	4
LNGF 231225P50-R51	23	3	12.00	25°	40	20	4
LNGF 231225P60-R51	23	3	12.00	25°	40	20	4

P	•	•	•
M	•	•	•
K	○		
N			
S	•	•	•
H			
O			

Spare parts

LN.. 23..

Screw Indexable inserts	70 950 ...	52600
HM-Shim	70 950 ...	54300

LNGF

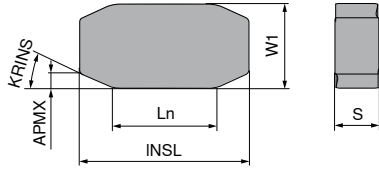

NEW

-R59
CTCP625

DRAGONSKIN

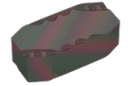

LNGF

74 022 ...

Designation	Ln mm	APMX mm	S mm	KRINS	INSL mm	W1 mm	NOI	
LNGF 231225S43-R59	23	3	12.00	25°	40	20	4	42300
LNGF 231225P43-R59	23	3	12.00	25°	40	20	4	42400
LNGF 231225S53-R59	23	3	12.00	25°	40	20	4	42500
LNGF 231225S55-R59	23	3	12.00	25°	40	20	4	42100
LNGF 231225P53-R59	23	3	12.00	25°	40	20	4	42600

P	•
M	•
K	
N	
S	•
H	
O	



70 950 ...

52600



70 950 ...

54300

Spare parts

LN.. 23..

NNUX

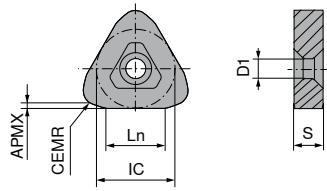

-M40 CTCP625	-M40 CTCP635
DRAGONSKIN	DRAGONSKIN
NNUX 74 066 ...	NNUX 74 066 ...
40100	00100

Designation	Ln mm	APMX mm	S mm	CEMR mm	IC mm	D1 mm	NOI		
NNUX 120800S50-M40	12	1.5	8.00	8	22	7	6		
P								•	•
M								•	•
K									
N									
S								•	•
H									
O									

Screw Indexable inserts	HM-Shim
70 950 ...	70 950 ...
53000	54500

Spare parts

NN.. 12..

NNUX

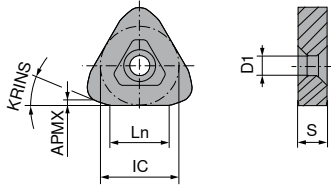

NEW

-M43
CTCP605

-M43
CTCP615

-M43
CTCP625

DRAGONSKIN

DRAGONSKIN

DRAGONSKIN

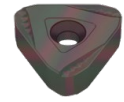
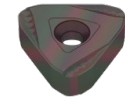
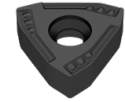

NNUX
74 064 ...

NNUX
74 064 ...

NNUX
74 064 ...

Designation	Ln mm	APMX mm	S mm	KRINS	IC mm	D1 mm	NOI				
NNUX 150820P30-M43	15	2	8.00	20°	22	7	6		42101	72100	
NNUX 150820S42-M43	15	2	8.00	20°	22	7	6		42301	42300	72300
NNUX 150820S50-M43	15	2	8.00	20°	22	7	6		42401	42400	72400
NNUX 150820S60-M43	15	2	8.00	20°	22	7	6		42501	72500	42500
NNUX 150820P60-M43	15	2	8.00	20°	22	7	6		42201		42200
P									●	●	●
M										●	●
K									○	○	
N									○		
S										●	●
H											
O											



70 950 ...

53000



70 950 ...

54600

Spare parts

NN.. 15..

NNUX

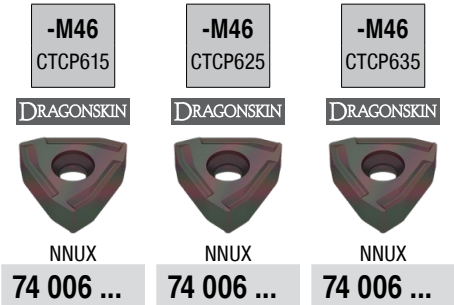
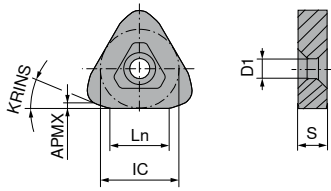

Designation	Ln mm	APMX mm	S mm	KRINS	IC mm	D1 mm	NOI				
NNUX 150820S42-M46	15	2	8.00	20°	22	7	6		72300	42300	
NNUX 150820S50-M46	15	2	8.00	20°	22	7	6		72400	42400	02400
NNUX 150820P60-M46	15	2	8.00	20°	22	7	6			42200	02200
P									•	•	•
M									•	•	•
K									○		
N											
S									•	•	•
H											
O											

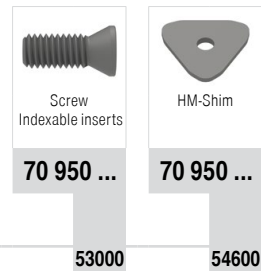

Spare parts

NN.. 15..

NNUX

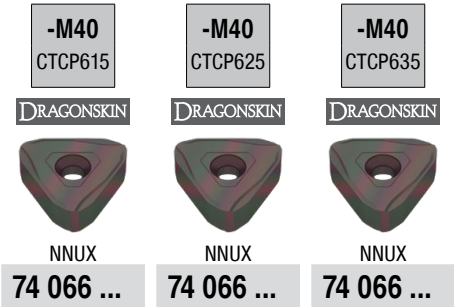
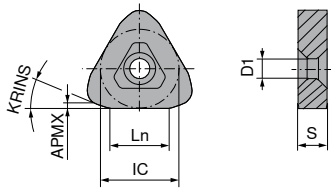

Designation	Ln mm	APMX mm	S mm	KRINS	IC mm	D1 mm	NOI			
NNUX 201020S42-M40	20	2.5	10.00	20°	28	7	6		74100	44100
NNUX 201020S50-M40	20	2.5	10.00	20°	28	7	6		74200	44200
										04200
P									•	•
M									•	•
K									○	•
N										
S									•	•
H										
O										

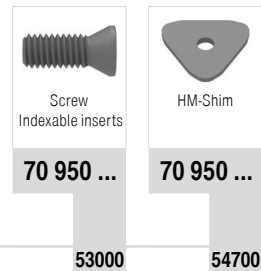

Spare parts

NN.. 20..

NNUX

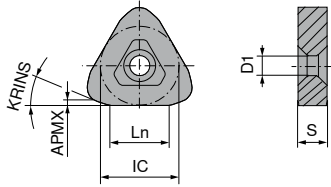

NEW

-M43
CTCP605

DRAGONSKIN

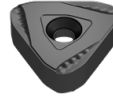

NNUX

74 064 ...

-M43
CTCP615

DRAGONSKIN

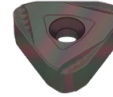

NNUX

74 064 ...

-M43
CTCP625

DRAGONSKIN

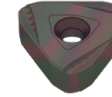

NNUX

74 064 ...

-M43
CTCP635

DRAGONSKIN

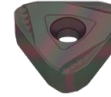

NNUX

74 064 ...

Designation	Ln mm	APMX mm	S mm	KRINS	IC mm	D1 mm	NOI				
NNUX 201020P30-M43	20	2.5	10.00	20°	28	7	6	44101	74100		
NNUX 201020S42-M43	20	2.5	10.00	20°	28	7	6	44401	74400	44400	
NNUX 201020S50-M43	20	2.5	10.00	20°	28	7	6	44501	74500	44500	04500
NNUX 201020P50-M43	20	2.5	10.00	20°	28	7	6		74200	44200	
NNUX 201020S60-M43	20	2.5	10.00	20°	28	7	6	44601			
NNUX 201020P60-M43	20	2.5	10.00	20°	28	7	6	44301	74300	44300	
P								●	●	●	●
M									●	●	●
K								○	○		
N										○	
S										●	●
H											●
O											

Spare parts

NN.. 20..



Screw
Indexable inserts

70 950 ...

53000



HM-Shim

70 950 ...

54700

NNUX

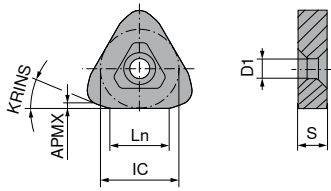

-M41
CTCP615

DRAGONSKIN

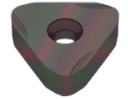

NNUX
74 067 ...

Designation	Ln mm	APMX mm	S mm	KRINS	IC mm	D1 mm	NOI	
NNUX 201020S50-M41	20	2.5	10.0	20°	28	7	6	74100
P								●
M								●
K								○
N								
S								●
H								
O								



70 950 ...



70 950 ...

Spare parts

NN.. 20..

53000

54700

NNUX

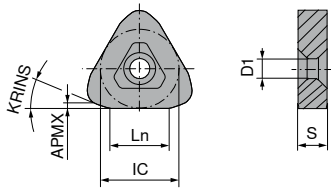

-M45
CTCP635

DRAGONSKIN

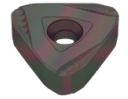

NNUX
74 005 ...

Designation	Ln mm	APMX mm	S mm	KRINS	IC mm	D1 mm	NOI	
NNUX 201020P53-M45	20	2.5	10.0	20°	28	7	6	04100
P								•
M								•
K								
N								
S								•
H								
O								



70 950 ...

53000



70 950 ...

54700

Spare parts

NN.. 20..

NNUX

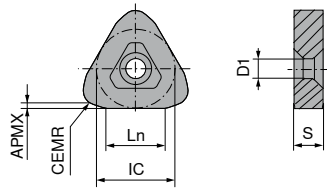

-M46
CTCP125

DRAGONSKIN

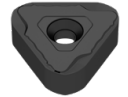

NNUX
74 006 ...

Designation	Ln mm	APMX mm	S mm	CEMR mm	IC mm	D1 mm	NOI	
NNUX 201000S42-M46	20	2.5	10.0	12	28	7	6	64100
P								●
M								○
K								
N								
S								●
H								
O								



70 950 ...



70 950 ...

Spare parts

NN.. 20..

53000

54700

NNUX

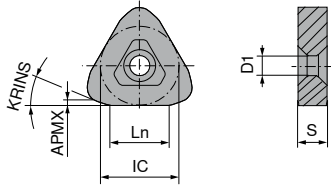

NEW	NEW
-M48 CTCP615	-M48 CTCP625
DRAGONSKIN	DRAGONSKIN
NNUX	NNUX
74 069 ...	74 069 ...
74000	
74200	44200
74300	44300
74400	44400
74100	44100

Designation	Ln mm	APMX mm	S mm	KRINS	IC mm	D1 mm	NOI
NNUX 201020P30-M48	20	2.5	10.00	20°	28	7	6
NNUX 201020S42-M48	20	2.5	10.00	20°	28	7	6
NNUX 201020S50-M48	20	2.5	10.00	20°	28	7	6
NNUX 201020S60-M48	20	2.5	10.00	20°	28	7	6
NNUX 201020P60-M48	20	2.5	10.00	20°	28	7	6

P	●	●
M	●	●
K	○	
N		
S	●	●
H		
O		

Spare parts

NN.. 20..

Screw Indexable inserts	HM-Shim
70 950 ...	70 950 ...
53000	54700

NNUX

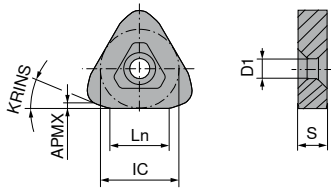

-M43
CTCP625

DRAGONSKIN

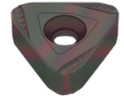

NNUX
74 064 ...

Designation	Ln mm	APMX mm	S mm	KRINS	IC mm	D1 mm	NOI	
NNUX 271220S50-M43	27	2.5	12.00	20°	32	9	6	46200
NNUX 271220P60-M43	27	2.5	12.00	20°	32	9	6	46100

P	•
M	•
K	
N	
S	•
H	
O	



70 950 ...

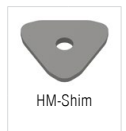

70 950 ...

Spare parts

NN.. 27..

52200

54800

NNXX

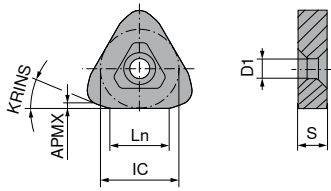

-M40
CTCP615

DRAGONSKIN

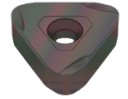

NNXX
74 024 ...

Designation	Ln mm	APMX mm	S mm	KRINS	IC mm	D1 mm	NOI	
NNXX 201020S50-M40	20	2.5	10.00	20°	28	7	6	72100
P								●
M								●
K								○
N								
S								●
H								
O								



70 950 ...

53000



70 950 ...

54700

Spare parts

NN.. 20..

RNMH

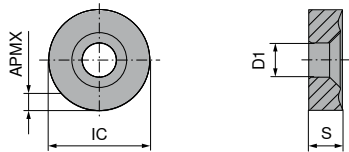

Designation	IC mm	APMX mm	S mm	D1 mm	NOI
RNMH 200800E00-R50	20	3	8.00	7	5
RNMH 200800E00-R56	20	3	8.00	7	5
RNMH 200800P15-R56	20	3	8.00	7	5
RNMH 281000E00-R50	28	5	10.50	9	5
RNMH 281000E00-R56	28	5	10.50	9	5
RNMH 281000P15-R56	28	5	10.50	9	5

P	•	•
M	•	•
K		
N		
S	•	•
H		
O		

Spare parts

RN.. 20..	53000		54900
RN.. 28..		52200	55000

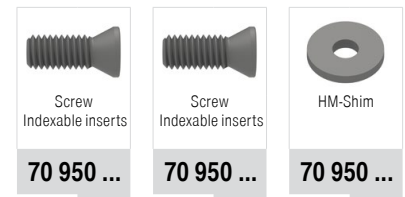

RNGH

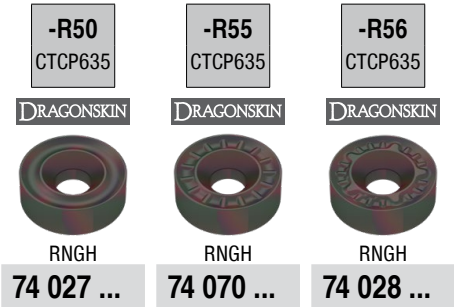
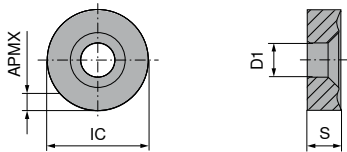

Designation	IC mm	APMX mm	S mm	D1 mm	NOI			
RNGH 381200P15-R50	38	7	12.00	12.7	5		06100	
RNGH 381200P15-R55	38	7	12.00	12.7	5			06100
RNGH 381200E00-R56	38	7	12.00	12.7	5			06000
RNGH 381200P15-R56	38	7	12.00	12.7	5			06100
P							•	•
M							•	•
K								
N								
S							•	•
H								
O								

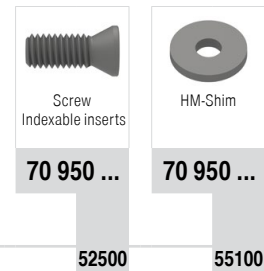

Spare parts

RN.. 38..

RNGX

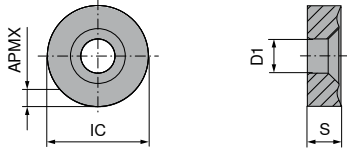

-R56
CTCP635

DRAGONSKIN

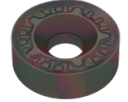

RNGX
74 029 ...

Designation	IC mm	APMX mm	S mm	D1 mm	NOI
RNGX 381200E00-R56	38	7	12.00	8.8	5

06100

P	•
M	•
K	
N	
S	•
H	
O	



70 950 ...



70 950 ...

Spare parts

RN.. 38..

52200

55100

RNMX / RNMH

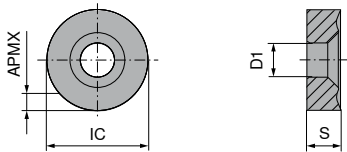

Designation	IC mm	APMX mm	S mm	D1 mm	NOI
RNMX 5018MOE00-R50	50	9	18.00	12.7	5
RNMH 5018MOE00-R55	50	9	18.00	12.7	5
RNMH 5018MOE00-R56	50	9	18.00	12.7	5
RNMH 5018MOP15-R56	50	9	18.00	12.7	5

74 031 ...	74 031 ...	74 032 ...	74 032 ...
06101	06100	06301	06200 06300

P	•	•	•	•
M	•	•	•	•
K				
N				
S	•	•	•	•
H				
O				

Spare parts

RN.. 50..

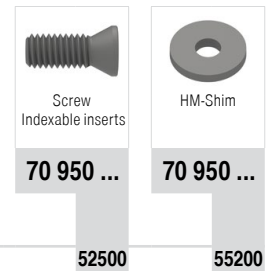

TNGT

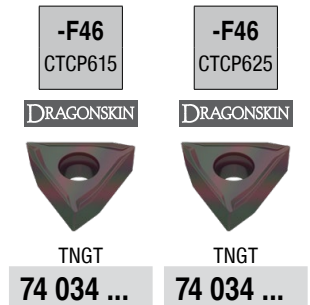
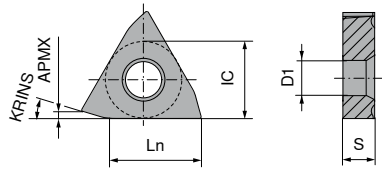

Designation	Ln mm	APMX mm	S mm	KRINS	IC mm	D1 mm	NOI			
TNGT 220815S42-F46	22	1	8.00	15°	19	8	3		72100	42100
TNGT 220815S50-F46	22	1	8.00	15°	19	8	3		72200	42200
P									●	●
M									●	●
K									○	○
N										
S									●	●
H										
O										

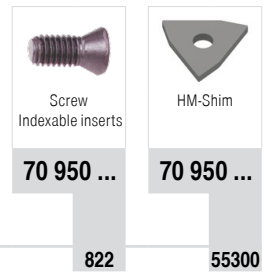

Spare parts

TN.. 22..

WNEF

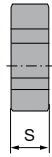
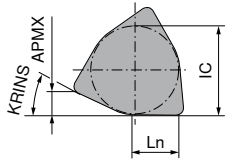

Designation	L _n mm	APMX mm	S mm	KRINS	IC mm	NOI				
WNEF 161325S50-R50	16	7	13.00	25°	32	6		40200		
WNEF 161325P50-R50	16	7	13.00	25°	32	6		40400	00400	
WNEF 161325P60-R50	16	7	13.00	25°	32	6		40100	00100	
WNEF 161325S50-R55	16	7	13.00	25°	32	6				40100 00100

P										
M										
K										
N										
S										
H										
O										

Spare parts

WN.. 16..

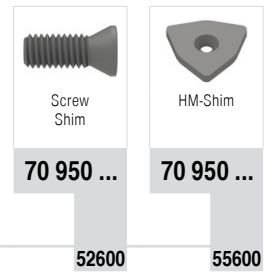

WNEF

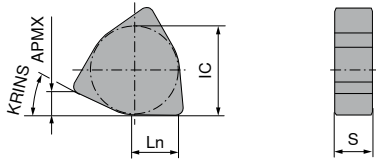

NEW

-R59
CTCP625

DRAGONSKIN

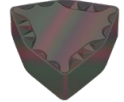

WNEF

74 072 ...

Designation	Ln mm	APMX mm	S mm	KRINS	IC mm	NOI	
WNEF 161325S45-R59	16	7	13.00	25°	32	6	40100
WNEF 161325S55-R59	16	7	13.00	25°	32	6	40200
WNEF 161325P55-R59	16	7	13.00	25°	32	6	40300
P							•
M							•
K							
N							
S							•
H							
O							



Screw Shim

70 950 ...

52600

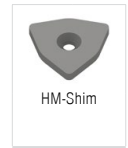

HM-Shim

70 950 ...

55600

Spare parts

WN.. 16..

WNEU

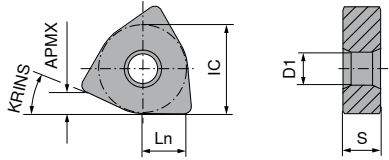

Designation	L _n mm	APMX mm	S mm	KRINS	IC mm	D1 mm	NOI			
WNEU 161325S42-R50	16	7	13.00	25°	32	9	6		74 037 ...	70100
WNEU 161325S50-R50	16	7	13.00	25°	32	9	6		74 037 ...	70200 40200 00200
WNEU 161425S42-R50	16	7	14.00	25°	32	9	6		74 037 ...	70500
WNEU 161425S50-R50	16	7	14.00	25°	32	9	6		74 037 ...	70600 40600
P										• • •
M										• • •
K										○
N										
S										• • •
H										
O										

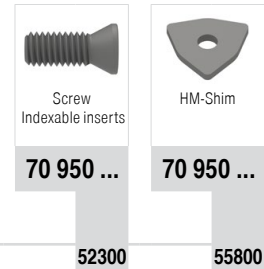

Spare parts

WN.. 16..

WNEU

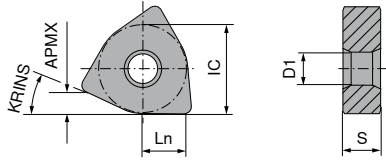

-R51
H216T

DRAGONSKIN



WNEU

74 038 ...

Designation	L _n mm	APMX mm	S mm	KRINS	IC mm	D1 mm	NOI	
WNEU 161325P50-R51	16	7	13.00	25°	32	9	6	10102
P								
M								
K								●
N								○
S								●
H								
O								

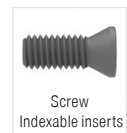

70 950 ...

52300



70 950 ...

55800

Spare parts

WN.. 16..

WNEU

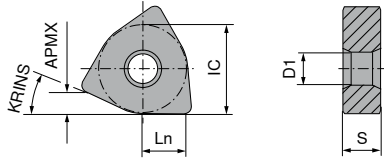

Designation	Ln mm	APMX mm	S mm	KRINS	IC mm	D1 mm	NOI		
WNEU 161325S42-R55	16	7	13.00	25°	32	9	6		
WNEU 161325S50-R55	16	7	13.00	25°	32	9	6	70100	40100
WNEU 161425S42-R55	16	7	14.00	25°	32	9	6	70200	40200
WNEU 161425S50-R55	16	7	14.00	25°	32	9	6	70300	40300
								70400	40400
P								●	●
M								●	●
K								○	
N									
S								●	●
H									
O									

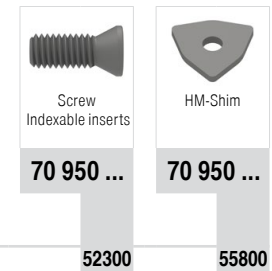

Spare parts

WN.. 16..

WNEU

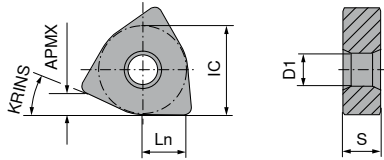

NEW

-R59
CTCP625

DRAGONSKIN

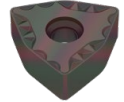

WNEU

74 040 ...

Designation	L _n mm	APMX mm	S mm	KRINS	IC mm	D1 mm	NOI	
WNEU 161325S45-R59	16	7	13.00	25°	32	9	6	40300
WNEU 161325S55-R59	16	7	13.00	25°	32	9	6	40200
WNEU 161325P55-R59	16	7	13.00	25°	32	9	6	40400
P								•
M								•
K								
N								
S								•
H								
O								



70 950 ...

52300



70 950 ...

55800

Spare parts

WN.. 16..

WNGU

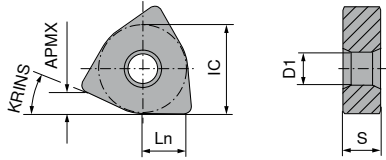

-M46
CTCP625

DRAGONSKIN

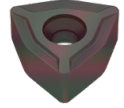

WNGU
74 041 ...

Designation	Ln mm	APMX mm	S mm	KRINS	IC mm	D1 mm	NOI	
WNGU 101025S55-M46	10	3	10.00	25°	22	6	6	40100
P								•
M								•
K								
N								
S								•
H								
O								



70 950 ...

52900



70 950 ...

55900

Spare parts

WN.. 10..

WNGU

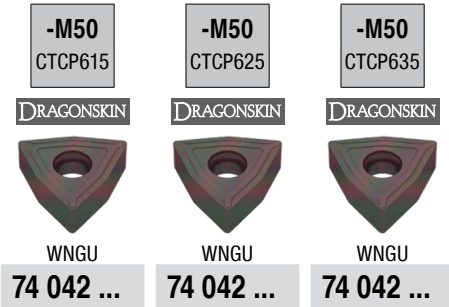
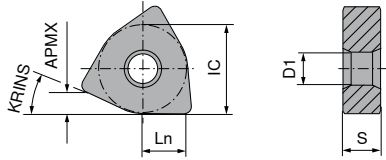

Designation	Ln mm	APMX mm	S mm	KRINS	IC mm	D1 mm	NOI				
WNGU 151015E00-M50	15	3	10.00	15°	22	8	6		72500	42500	02500
WNGU 151015S42-M50	15	3	10.00	15°	22	8	6		72200	42200	
WNGU 151015S50-M50	15	3	10.00	15°	22	8	6		72300	42300	02300
WNGU 151015P60-M50	15	3	10.00	15°	22	8	6			42100	02100
P									•	•	•
M									•	•	•
K									○		
N											
S									•	•	•
H											
O											

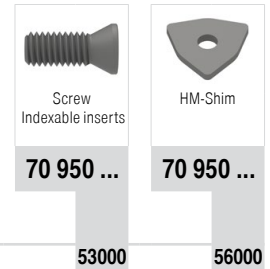

Spare parts

WN.. 15..

WNGU

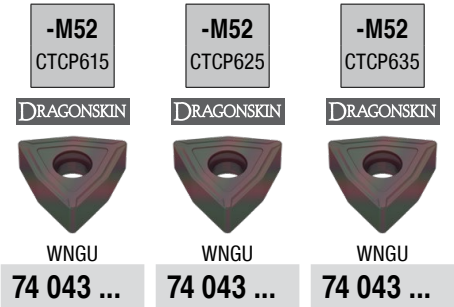
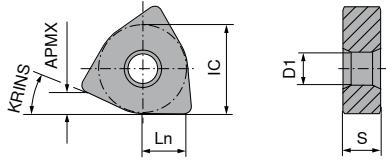

Designation	L _n mm	APMX mm	S mm	KRINS	IC mm	D1 mm	NOI				
WNGU 151015S50-M52	15	3	10.00	15°	22	8	6		72200	42200	02200
WNGU 151015P60-M52	15	3	10.00	15°	22	8	6			42100	
P									•	•	•
M									•	•	•
K									○		
N											
S									•	•	•
H											
O											

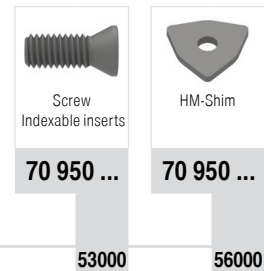

Spare parts

WN.. 15..

WNMF

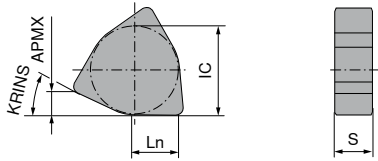

-M41
CTCP615

DRAGONSKIN

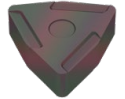

WNMF
74 044 ...

Designation	Ln mm	APMX mm	S mm	KRINS	IC mm	NOI	
WNMF 110615S50-M41	11	2	6.00	15°	16	6	70100
P							•
M							•
K							○
N							
S							•
H							
O							



70 950 ...

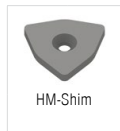

70 950 ...

Spare parts

WN.. 11..

53100

55400

WNMF

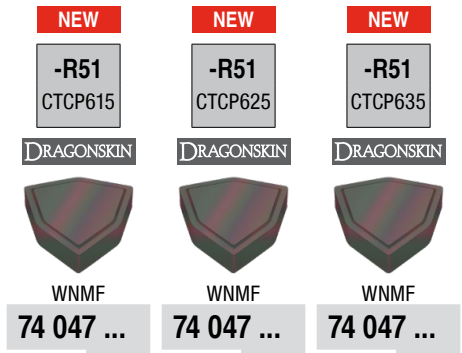
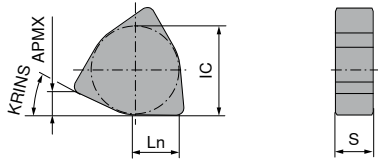

Designation	Ln mm	APMX mm	S mm	KRINS	IC mm	NOI			
WNMF 96S00-R51	16	6	9.00	30°	28	6			06300
WNMF 96S53-R51	16	6	9.00	30°	28	6	76000	46000	
WNMF 96P73-R51	16	6	9.00	30°	28	6	76400	46400	
WNMF 96P93-R51	16	6	9.00	30°	28	6	76500	46500	
P							•	•	•
M							•	•	•
K							○		
N									
S							•	•	•
H									
O									

Spare parts

WN.. 96..

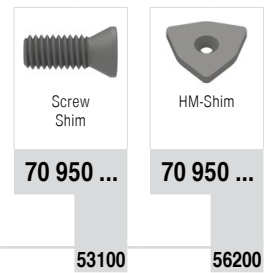

WNMF

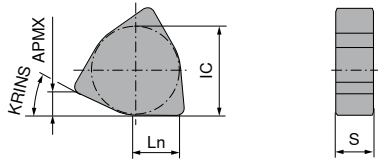

H216T



WNMF
74 049 ...

Designation	Ln mm	APMX mm	S mm	KRINS	IC mm	NOI
WNMF 96-P50 H216T	16	6	9.00	30°	28	6

16202

P
M
K
N
S
H
O



Screw Shim

70 950 ...



HM-Shim

70 950 ...

Spare parts

WN.. 96..

53100

56200

YNGX

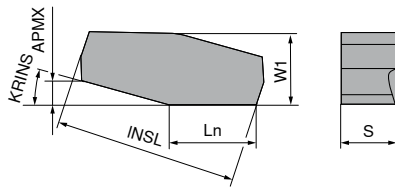

-M50
CTCP635

DRAGONSKIN

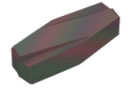

YNGX
74 058 ...

Designation	Ln mm	APMX mm	S mm	KRINS	INSL mm	W1 mm	NOI	
YNGX 150815S50-M50	15	3	8.00	15°	31	12	4	02100
P								•
M								•
K								
N								
S								•
H								
O								



70 950 ...



70 950 ...

Spare parts

YNGX 150815	53100	57000
-------------	--------------	--------------

YNGX

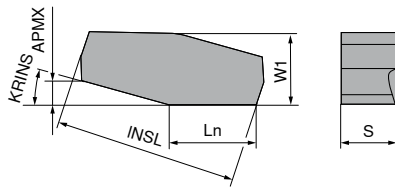

-R52
CTCP635

DRAGONSKIN

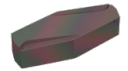

YNGX
74 060 ...

Designation	Ln mm	APMX mm	S mm	KRINS	INSL mm	W1 mm	NOI	
YNGX 150820S42-R52	15	3.5	8.00	20°	31	12	4	02200
YNGX 150820S57-R52	15	3.5	8.00	20°	31	12	4	02300
YNGX 150820P57-R52	15	3.5	8.00	20°	31	12	4	02100

P	•
M	•
K	
N	
S	•
H	
O	



Screw Shim

70 950 ...



HM-Shim

70 950 ...

Spare parts

YNGX 150820

53100

57100

YNGX

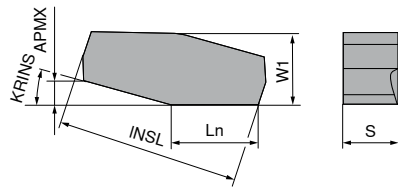

-R52
CTCP615

DRAGONSKIN

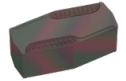

YNGX
74 060 ...

Designation	Ln mm	APMX mm	S mm	KRINS	INSL mm	W1 mm	NOI	
YNGX 171215S55-R52	17	4	12.00	15°	37	18	4	74200
P								●
M								●
K								○
N								
S								●
H								
O								



70 950 ...



70 950 ...

Spare parts

YNGX 171215

53100

57200

YNUX

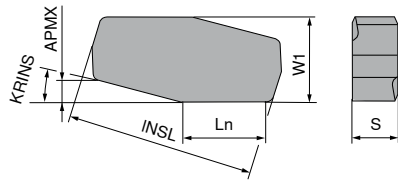

-M50
CTCP625

DRAGONSKIN

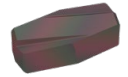

YNUX
74 063 ...

Designation	Ln mm	APMX mm	S mm	KRINS	INSL mm	W1 mm	NOI	
YNUX 100615S50-M50	10	2	6.00	15°	22	10	4	40100
P								•
M								•
K								
N								
S								•
H								
O								



70 950 ...



70 950 ...

Spare parts

YNUX 100615	53100	56900
-------------	-------	-------

YNUF

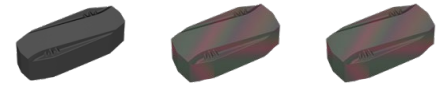
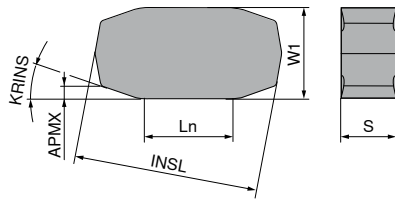

YNUF 74 009 ... YNUF 74 009 ... YNUF 74 009 ...

Designation	L _n mm	APMX mm	S mm	KRINS	INSL mm	W1 mm	NOI				
YNUF 170820P30-M48	17	1.5	8.00	20°	31	12	4		40501	70500	
YNUF 170820S42-M48	17	1.5	8.00	20°	31	12	4		40601	70600	40600
YNUF 170820S50-M48	17	1.5	8.00	20°	31	12	4		40201	70200	40200
YNUF 170820S60-M48	17	1.5	8.00	20°	31	12	4		40301	70300	40300
YNUF 170820P60-M48	17	1.5	8.00	20°	31	12	4		40101	70100	40100
YNUF 200920P30-M48	20	2.0	9.00	20°	37	18	4		42201	72200	
YNUF 200920S42-M48	20	2.0	9.00	20°	37	18	4		42401	72400	42400
YNUF 200920S50-M48	20	2.0	9.00	20°	37	18	4		42501	72500	42500
YNUF 200920S60-M48	20	2.0	9.00	20°	37	18	4		42601	72600	42600
YNUF 200920P60-M48	20	2.0	9.00	20°	37	18	4		42301	72300	42300
YNUF 201220P30-M48	20	2.0	12.00	20°	37	18	4		42701	72700	
YNUF 201220S42-M48	20	2.0	12.00	20°	37	18	4		42901	72900	42900
YNUF 201220S50-M48	20	2.0	12.00	20°	37	18	4		43001	73000	43000
YNUF 201220S60-M48	20	2.0	12.00	20°	37	18	4		43101	73100	43100
YNUF 201220P60-M48	20	2.0	12.00	20°	37	18	4		42801	72800	42800
P									●	●	●
M										●	●
K									○	○	
N									○		
S										●	●
H											
O											



70 950 ... 70 950 ...

Spare parts

YNUF 17..	53100	56300
YNUF 20..	52600	56400

YNUF

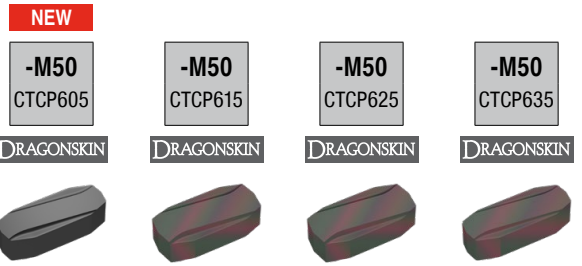
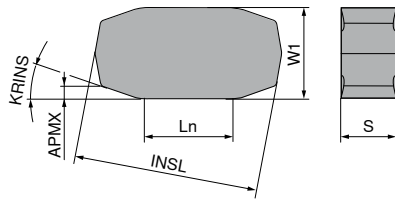

YNUF 74 007 ... YNUF 74 007 ... YNUF 74 007 ... YNUF 74 007 ...

Designation	L _n mm	APMX mm	S mm	KRINS	INSL mm	W1 mm	NOI				
YNUF 170820P30-M50	17	1.5	8.00	20°	31	12	4	40701	70700		
YNUF 170820S42-M50	17	1.5	8.00	20°	31	12	4	40101	70100	40100	
YNUF 170820S50-M50	17	1.5	8.00	20°	31	12	4	40201	70200	40200	00200
YNUF 170820S60-M50	17	1.5	8.00	20°	31	12	4	40301	70300	40300	
YNUF 170820P60-M50	17	1.5	8.00	20°	31	12	4	40401	70400	40400	00400
YNUF 200920P30-M50	20	2.0	9.00	20°	37	18	4	42101	72100	42100	
YNUF 200920S42-M50	20	2.0	9.00	20°	37	18	4	42201	72200	42200	
YNUF 200920S50-M50	20	2.0	9.00	20°	37	18	4	42301	72300	42300	
YNUF 200920S60-M50	20	2.0	9.00	20°	37	18	4	42401	72400	42400	
YNUF 200920P60-M50	20	2.0	9.00	20°	37	18	4	42501	72500	42500	
YNUF 201220P30-M50	20	2.0	12.00	20°	37	18	4	42601	72600		
YNUF 201220S42-M50	20	2.0	12.00	20°	37	18	4	42701	72700	42700	
YNUF 201220S50-M50	20	2.0	12.00	20°	37	18	4	42801	72800	42800	02800
YNUF 201220S60-M50	20	2.0	12.00	20°	37	18	4	42901	72900	42900	
YNUF 201220P60-M50	20	2.0	12.00	20°	37	18	4	43001	73000	43000	03000
YNUF 241020P30-M50	24	1.2	10.00	20°	35	15	4	44101			
YNUF 241020S42-M50	24	1.2	10.00	20°	35	15	4	44201			
YNUF 241020S50-M50	24	1.2	10.00	20°	35	15	4	44301			
YNUF 241020S60-M50	24	1.2	10.00	20°	35	15	4	44401			
YNUF 241020P60-M50	24	1.2	10.00	20°	35	15	4	44501			
YNUF 271220P30-M50	27	2.0	12.00	20°	43	18	4	46101			
YNUF 271220S42-M50	27	2.0	12.00	20°	43	18	4	46201	76200	46200	
YNUF 271220S50-M50	27	2.0	12.00	20°	43	18	4	46301	76300	46300	06300
YNUF 271220S60-M50	27	2.0	12.00	20°	43	18	4	46401	76400		
YNUF 271220P60-M50	27	2.0	12.00	20°	43	18	4	46501	76500	46500	06500
P								●	●	●	●
M									●	●	●
K								○	○		
N								○			
S									●	●	●
H											
O											



70 950 ... 70 950 ...

Spare parts

YNUF 17..	53100	56300
YNUF 20..	52600	56400
YNUF 24..	52600	56600
YNUF 27..	52600	56700

YNUR

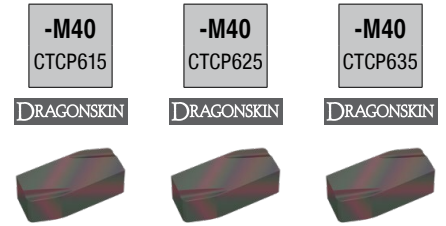
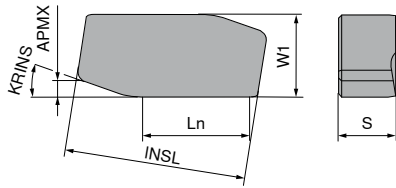

Material	Part Number	Code
-M40	CTCP615	74 062 ...
-M40	CTCP625	74 062 ...
-M40	CTCP635	74 062 ...
		74100
		44100
		04100

Designation	Ln mm	APMX mm	S mm	KRINS	INSL mm	W1 mm	NOI
YNUR 271220S50-M40	27	3	12.00	20°	38	18	2
P							
M							
K							
N							
S							
H							
O							

Part	Part Number
Screw Shim	70 950 ...
HM-Shim	70 950 ...
	53100
	56800

Spare parts

YNUR 27..

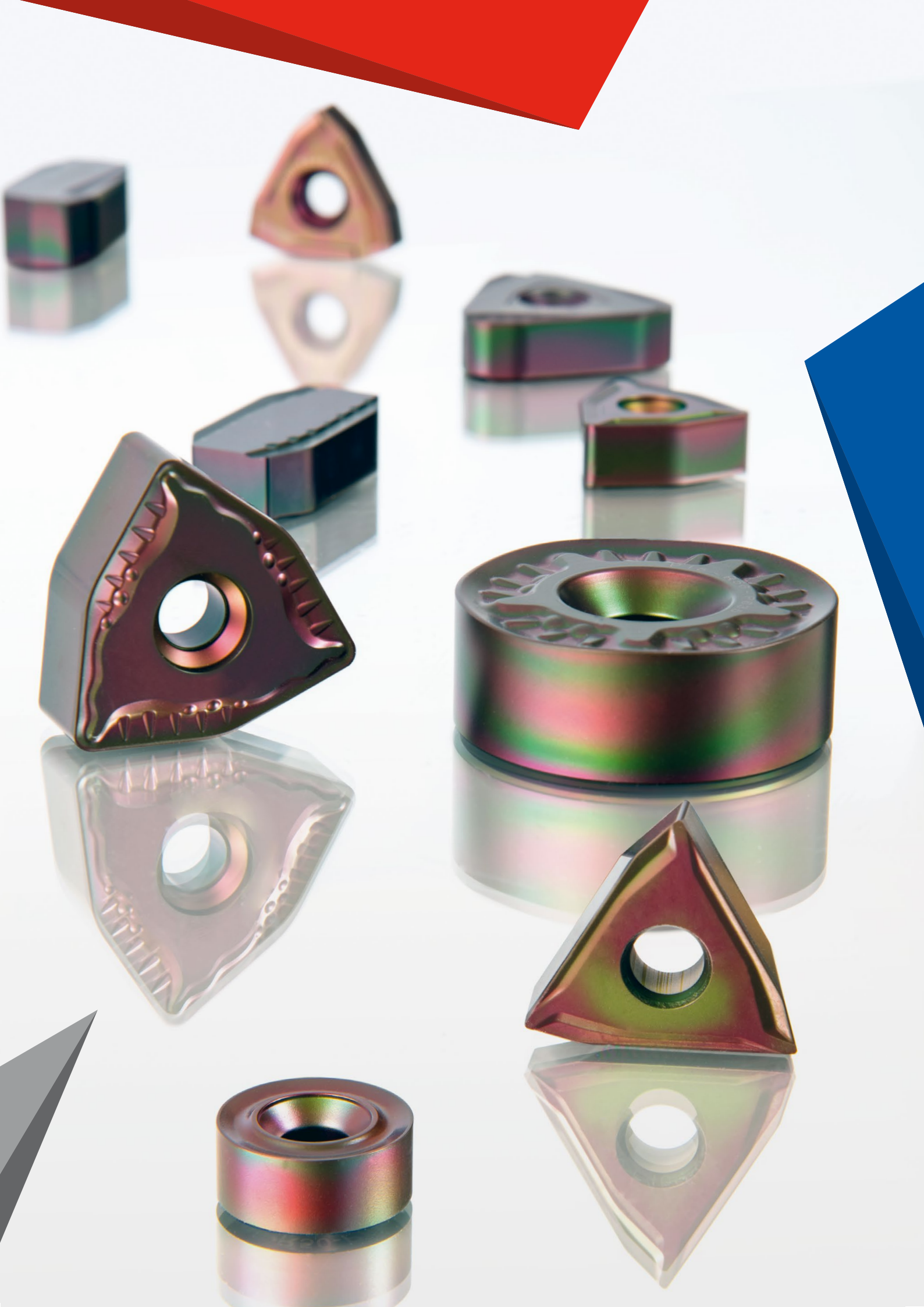

Internal peeling – the process

In internal peeling, the internal diameter of seamless steel tubes (as well as cold welded or cold drawn precision steel tubes, used for the production of cylindrical tubes for example) undergoes finish machining. In most cases a combination of peeling and smooth rolling tools is used.

The peeling inserts are positioned and clamped in cartridges in the front part of the internal peeling head. In most cases only 2 inserts, positioned at an offset of 180° to the diameter, are actively involved. To increase material removal rate, tandem systems may also be used. Here 2 internal peeling inserts are contained in the cartridge, positioned one behind the other in the direction of the axis.

The subsequent smooth rolling tool further optimises the peeling surface, combining roller pressure and rotation in a single operation; the material is compressed, roughness and uneven spots are depressed, making the internal tube surface more even, smoother and more wear-resistant.

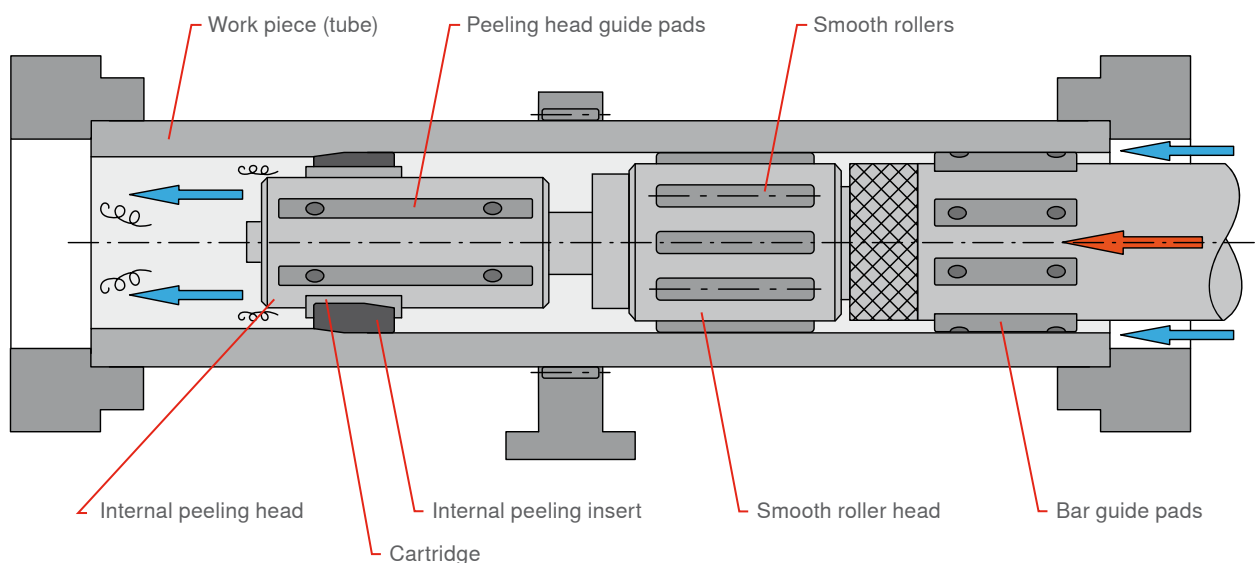

LNGX

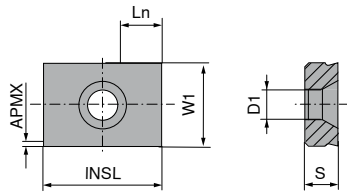

-F50
CTPM225

DRAGONSKIN



LNGX
74 068 ...

Designation	Ln mm	APMX mm	S mm	KRINS	INSL mm	W1 mm	D1 mm	
LNGX 170400E00-F50	6	0.7	4.76	6°	17	12	4.3	20203
P								•
M								•
K								
N								
S								•
H								
O								



Clamping screw

70 950 ...

Spare parts

LN.. 17..

839

YNCR

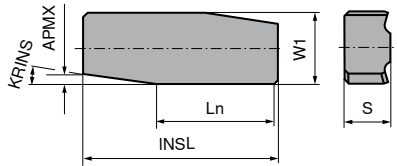

Designation	Ln mm	APMX mm	S mm	KRINS	INSL mm	W1 mm	NOI		
YNCR 080308P10-F50	8	0.5	3.50	8°	14.85	5.5	2		42000
YNCR 080308P10-F51	8	0.5	3.50	8°	14.85	5.5	2		42000
P									• •
M									• •
K									
N									
S									• •
H									
O									

YNCF

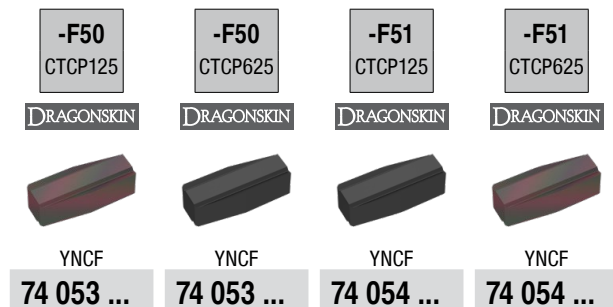
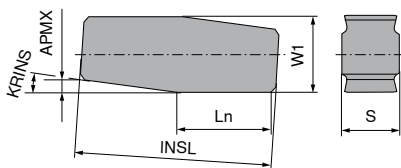

Designation	Ln mm	APMX mm	S mm	KRINS	INSL mm	W1 mm	NOI		
YNCF 090608P90-F50	9	0.8	6.00	8°	20.45	8	4		60100
YNCF 090608P90-F51	9	0.8	6.00	8°	20.45	8	4		40100
P									• • • •
M									○ • ○ •
K									
N									
S									• • • •
H									
O									

YNSF

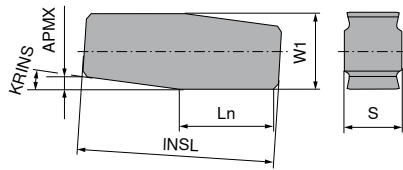

-F52
CTCP625
DRAGONSKIN

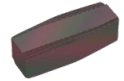

YNSF
74 055 ...

Designation	Ln mm	APMX mm	S mm	KRINS	INSL mm	W1 mm	NOI	
YNSF 090608P90-F52	9	0.8	6.00	8°	20.45	8	4	40100
YNSF 090608S90-F52	9	0.8	6.00	8°	20.45	8	4	40200

P	•
M	•
K	
N	
S	•
H	
O	

YOGR

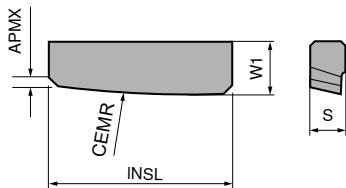

-F50
1310

-F50
CTCP625
DRAGONSKIN

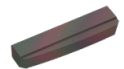
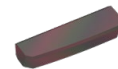

YOGR
74 075 ...

YOGR
74 075 ...

Designation	Ln mm	APMX mm	S mm	CEMR mm	INSL mm	W1 mm	NOI	
YOGR 0504120E00-F50	5	0.7	4.00	120	20.90	6	1	30103
YOGR 0805165E00-F50	8	1.0	5.00	165	30.85	9	1	42100
YOGR 0906165E00-F50	9	1.5	6.00	165	35.85	10	1	44100

P	•	•
M	•	•
K		
N		
S	•	•
H		
O		

Cartridges

CERATIZIT is your competent partner with first-class cutting grades in combination with machine-specific tool holders and cartridges

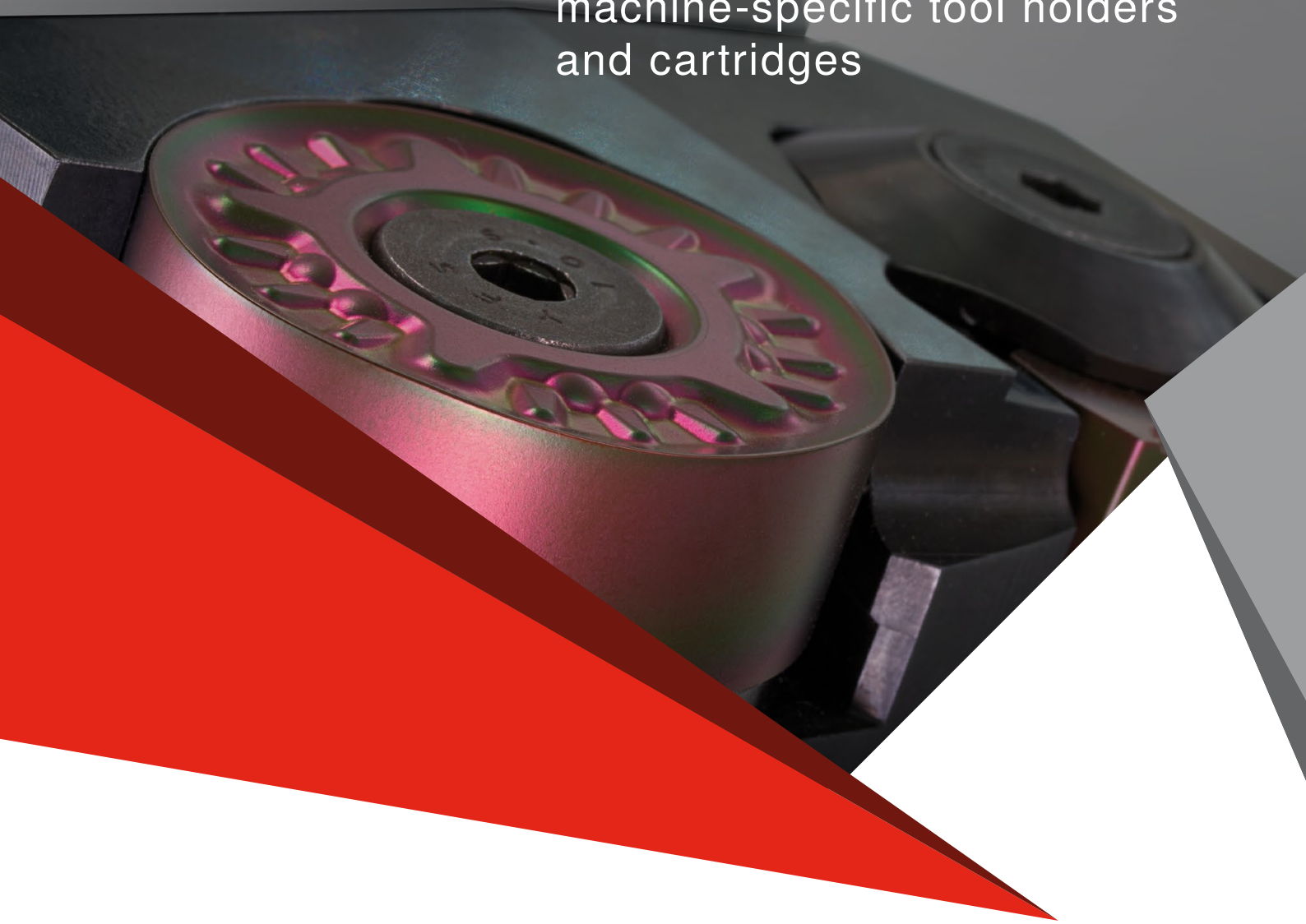

In the field of tool holders and cartridges as well, CERATIZIT is your expert partner of choice. In view of the wide range of different machine products and versions, we only keep some of the more frequently used types as standard articles in stock. But of course we do offer our customers the option of ordering their machine-specific tool holder and/or cartridge type from us.

Delivery times adapted to market requirements, along with the high manufacturing quality of the tools, will convince you.



Designation system cartridges and tool holders

Standard cartridges
(SMS/KIESERLING/BÜLTMANN-Systems)



CA 00 - LNGF 23 10
 1 2 3 4 5

CA 00 - TNGT 22 - 30
 1 2 3 4 6

T CA 12 - RN 50 YN 20
 1 2 3 4 3 4

TR CA 12 - RN 50 RN 50 NN 20
 1 2 3 4 3 4 3 4

Special cartridges

CA XX - LNGF 23 10 - 22 . 55 . 50
 1 2 3 4 5 6 7 8

TCAS XX - RN 28 YN 20 - 90 10011354
 1 2 3 4 3 4 8 9

TR CA XX - RN 50 RN 50 LN 23 12 10011439
 1 2 3 4 3 4 3 4 5 9

Tool holders “Monobloc”



THM - WN 16 - D150-170 L151 10026376
 1 3 4 10 8 9

Tool holders “Cartridge”



THC - D150-170 - L151 10026377
 1 10 8 9

1 Cartridges /Tool holders

CA	SINGLE cartridge (1 insert seat)
TCA	TANDEM cartridge (2 insert seats)
TRCA	TRIO cartridge (3 insert seats)
TRCAS	QUICK CLAMPING system
THM	Tool holder MONOBLOC
THC	Tool holder CARTRIDGE

2 Cartridge definition

00	CERATIZIT standard cartridges - for Bültmann and Kieserling peeling machines
12	
14	- the figures define different clamping methods
15	
XX	CERATIZIT special cartridges

3 Insert seat definition

LNGF	Insert designation
NNUX	
TNGT	
WNEF	
WNEU	
WNGU	
YNUF	One part of the insert designation
WN	
HN	
LN	
NN	
RN	
TN	
YN	

4 Insert size

07	By analogy with the insert designation system
08	
09	
10	
11	
12	
15	
16	
17	
20	
22	
23	
24	
27	
28	
38	
50	

5 Insert thicknesses

09	Definition of different insert thicknesses depending on the insert type
10	
12	

6 Cartridge height

22 etc.	Cartridge height in mm
------------	------------------------

7 Cartridge depth

55 etc.	Cartridge depth in mm
------------	-----------------------

8 Cartridge length

50 etc.	Cartridge length in mm
------------	------------------------

9 Drawing number

10011345 etc.	CERATIZIT drawing number
------------------	-----------------------------

10 Diameter range tool holder

D150- 170	Ø 150 to 170 mm
--------------	-----------------

Tools upon request

All peeling cartridges except the CA00 standard cartridge are produced upon request.

If you are interested in CERATIZIT peeling cartridges, please send us your enquiry.

Single Cartridges CA..YNUF..

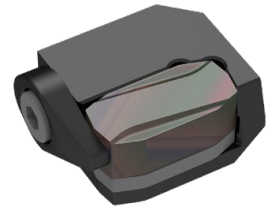
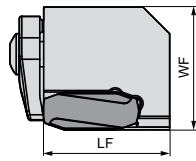

Single
74 610 ...

Designation	LF mm	HF mm	WF mm	Insert	
CA00-YNUF17	40	22	39	YNUF 170820	07100
CA00-YNUF2009	42	22	39	YNUF 200920	07300
CA00-YNUF20	42	22	39	YNUF 201220	07500
CA00-YNUF24	42	22	39	YNUF 241020	07700
CA00-YNUF27	49	22	39	YNUF 271220	07900

Clamp

70 950 ...

Clamping screw
Seat

70 950 ...

Clamping screw
Clamp

70 950 ...

Carbide seat

70 950 ...

Spare parts
for Article no.

74 610 07100	53600	53100	53300	56300
74 610 07300	53600	52600	53300	56400
74 610 07500	53600	52600	53300	56400
74 610 07700	53600	52600	53300	56600
74 610 07900	53600	52600	53300	56700

Single Cartridges CA..YNGF..

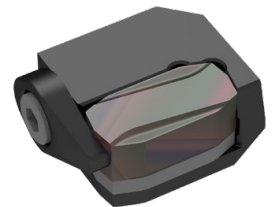
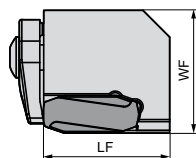

Single
74 610 ...

Designation	LF mm	HF mm	WF mm	Insert	
CA00-YNGF20	49	22	39	YNGF 201220	06200

Clamp

70 950 ...

Clamping screw
Seat

70 950 ...

Clamping screw
Clamp

70 950 ...

Carbide seat

70 950 ...

Spare parts
for Article no.

74 610 06200	53600	52600	53300	56500
--------------	-------	-------	-------	-------

Single Cartridges CA..-LNGF..

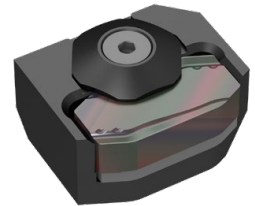
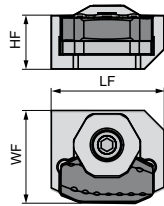

Single
74 610 ...

Designation	LF mm	HF mm	WF mm	Insert	
CA00-LNGF2310	49	22	39	LNGF 231025	02200
CA00-LNGF2312	49	22	39	LNGF 231225	00400

Clamping screw Seat	Clamping screw Clamp	Clamp	Carbide seat
70 950 ...	70 950 ...	70 950 ...	70 950 ...
52600	52700	53400	54400
52600	52700	53400	54300

Spare parts
for Article no.

74 610 00200
74 610 00400

Single Cartridges CA..-NNUX..

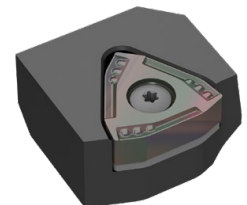
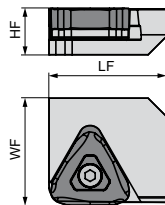

Single
74 610 ...

Designation	LF mm	HF mm	WF mm	Insert	
CA00-NNUX12	42	22	39	NNUX 120800	02200
CA00-NNUX15	42	22	39	NNUX 150820	02400
CAXX-NNUX20	51	25	46	NNUX 201020	02600

Insert Clamping screw	Carbide seat
70 950 ...	70 950 ...
53000	54500
53000	54600
53000	54700

Spare parts
for Article no.

74 610 02200
74 610 02400
74 610 02600

Single Cartridges CA..-WNGU..

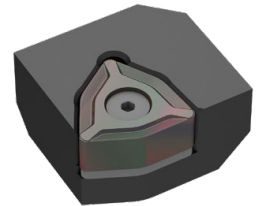
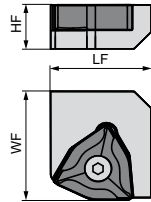

Single
74 610 ...

Designation	LF mm	HF mm	WF mm	Insert	
CA00-WNGU10	42	22	39	WNGU 101025	05200
CA00-WNGU15	42	22	39	WNGU 151015	05400

Insert Clamping screw	Carbide seat
70 950 ...	70 950 ...
52900	55900
53000	56000

Spare parts
for Article no.

74 610 05200	52900	55900
74 610 05400	53000	56000

Single Cartridges CA..-WNEF..

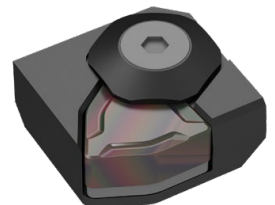
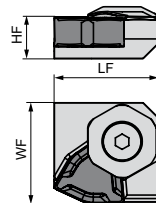

Single
74 610 ...

Designation	LF mm	HF mm	WF mm	Insert	
CAXX-WNEF1613	58	22	55	WNEF 161325	03200
CA12-WNEF1613	110	40	65	WNEF 161325	03400

Clamping screw Seat	Clamping screw Clamp	Clamp	Carbide seat
70 950 ...	70 950 ...	70 950 ...	70 950 ...
52600	52400	53500	55600
	52400	53500	

Spare parts
for Article no.

74 610 03200	52600	52400	53500	55600
74 610 03400				

Single Cartridges CA..-WNEU..

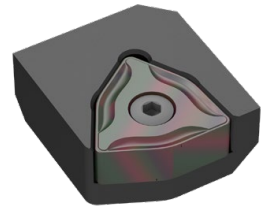
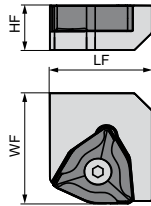

Designation	LF mm	HF mm	WF mm	Insert
CAXX-WNEU1613	50	22	55	WNEU 161325
CAXX-WNEU1614	50	22	55	WNEU 161425
CA12-WNEU1613	110	40	65	WNEU 161325

Single
74 610 ...

Spare parts
for Article no.
74 610 04200
74 610 04400
74 610 04600

Insert Clamping screw	Carbide seat
70 950 ...	70 950 ...
52800	
52800	
52300	55800

Single Cartridges CA..-NNUX..

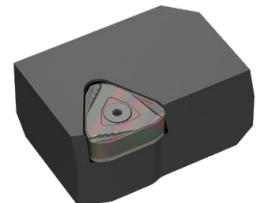
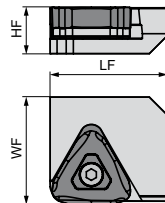

Designation	LF mm	HF mm	WF mm	Insert
CA12-NN20-40-65-90	90	40	65	NNUX 201020

Single
74 610 ...

Spare parts
for Article no.
74 610 01200

Insert Clamping screw	Carbide seat
70 950 ...	70 950 ...
53000	54700

Tandem Cartridges TCA..-RN../NN..

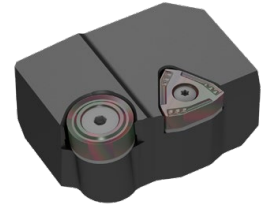
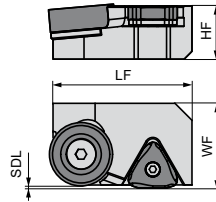

Tandem
74 611 ...

Designation	LF mm	HF mm	WF mm	SDL mm	Insert	
TCAXX-RN20NN15	55	22	39	1.2	RNMH 2008.. / NNUX 150820	01200
TCAXX-RN28NN15	90	40	65	1.0	RNMH 2810.. / NNUX 150820	01400
TCA12-RN50NN20	110	40	65	1.5	RNMH 5018.. / NNUX 201020	01600

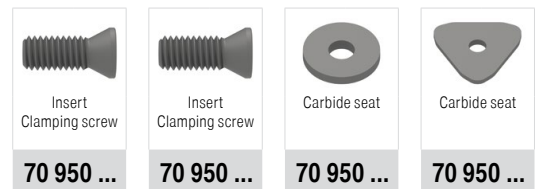

Spare parts for Article no.

74 611 01200	53000		54900	54600
74 611 01400	53000	52200	55000	54600
74 611 01600	53000	52500	55200	54700

The clamping screw 70 950 53000 corresponding to article no. 74 611 01200 can be used for both indexable inserts (RN.. and NN..). It can still be used for NN.. indexable inserts on all other sizes. For the RN.. indexable inserts, please use the clamping screws from the second column.

Tandem Cartridges TCA..-RN../WNEF

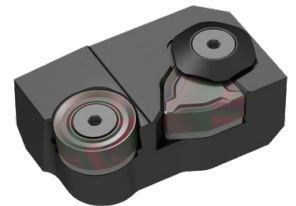
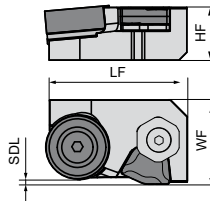

Tandem
74 611 ...

Designation	LF mm	HF mm	WF mm	SDL mm	Insert	
TCA12-RN38WNEF16	110	40	65	2.5	RNGH 3812.. / WNEF 161325	07200



Spare parts for Article no.

74 611 07200	52500	52600	52400	53500	55600	55100
--------------	-------	-------	-------	-------	-------	-------

Tandem Cartridges TCA..-RN../WNEU

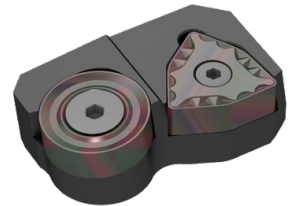
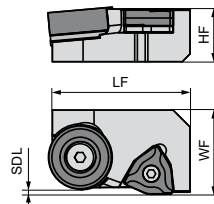

Tandem
74 611 ...

Designation	LF mm	HF mm	WF mm	SDL mm	Insert	
TCA12-RN38WNEU16	110	40	65	2.5	RNGH 3812.. / WNEU 1613/1425..	06200
TCA12-RN50WNEU16	110	40	65	3.5	RNMH 5018.. / WNEU 1613/1425..	06400

**Spare parts
for Article no.**

74 611 06200						52300	52500	55800	55100
74 611 06400						52300	52500	55800	55200

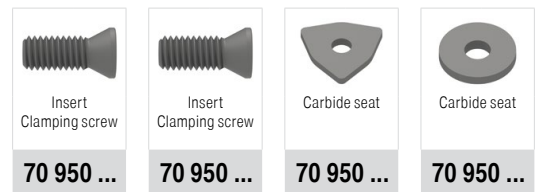

The clamping screws in the first column are suitable for the WN.. indexable inserts, the clamping screws in the second column for the RN.. indexable inserts.

Tandem Cartridges TCA..-RN../YN..

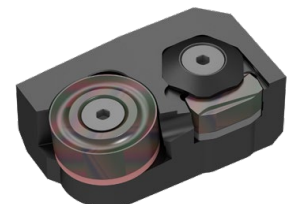
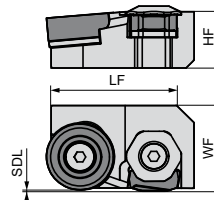

Tandem
74 611 ...

Designation	LF mm	HF mm	WF mm	SDL mm	Insert	
TCAXX-RN20YN20	64	22	39	1.0	RNMH 2008.. / YNUF 201220	00200
TCA12-RN38YN20	110	40	65	1.2	RNGH 3812.. / YNUF 201220	00400
TCA12-RN38YN27	110	40	65	1.2	RNGH 3812.. / YNUF 271220	00800
TCA12-RN50YN20	110	40	65	1.2	RNMH 5018.. / YNUF 201220	00600

**Spare parts
for Article no.**

74 611 00200						53000						
74 611 00400							52500	52600	52400	53500	56400	55100
74 611 00800							52500	52600	52400	53500	56700	55100
74 611 00600							52500	52600	52400	53500	56400	55200

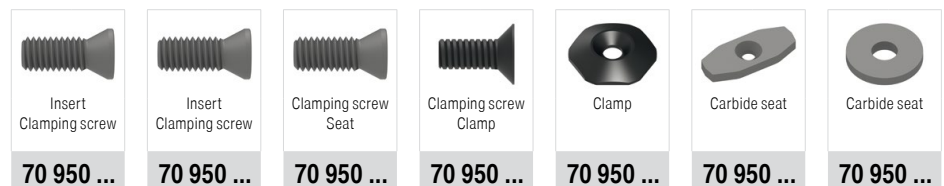



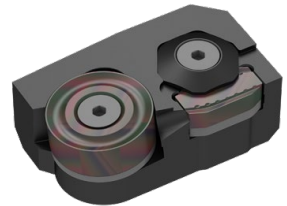
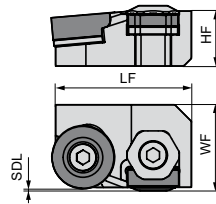



Tandem Cartridges TCA..-RN../LN..



Tandem
74 611 ...

Designation	LF mm	HF mm	WF mm	SDL mm	Insert	
TCA12-RN50LN23	110	40	65	1.2	RNMH 5018.. / LNGF 231225	04200

 Insert Clamping screw	 Clamping screw Seat	 Clamping screw Clamp	 Clamp	 Carbide seat	 Carbide seat
70 950 ...	70 950 ...	70 950 ...	70 950 ...	70 950 ...	70 950 ...
52500	52600	52400	53500	55200	54300





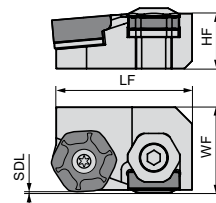

Spare parts
for Article no.
74 611 04200

Tandem Cartridges TCAS..-HN../LN..



NEW
Tandem
74 611 ...

Designation	LF mm	HF mm	WF mm	SDL mm	Insert	
TCAS12-HN28LN23	110	40	65	1.2	HNMH 2818.. / LNGF 231225	05200

 Nut	 Insert Clamping screw	 Insert Clamping screw	 Clamping screw Clamp	 Clamp	 Carbide seat	 Carbide seat
70 950 ...	70 950 ...	70 950 ...	70 950 ...	70 950 ...	70 950 ...	70 950 ...
53900	52500	52600	52400	53500	54300	54200

Spare parts
for Article no.
74 611 05200

Tandem Cartridges TCAS..-HN../NN..

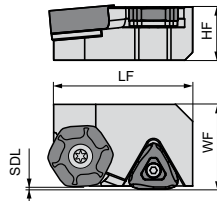

NEW
Tandem
74 611 ...

Designation	LF mm	HF mm	WF mm	SDL mm	Insert	
TCASXX-HN13NN15	55	22	39	1.2	HNMJ 1310.. / NNUX 150820	02200
TCAS12-HN28NN20	110	40	65	1.2	HNMH 2818.. / NNUX 201020	02400

**Spare parts
for Article no.**

Article no.	Nut	Insert Clamping screw	Insert Clamping screw	Carbide seat	Carbide seat
74 611 02200	53700	53000		54600	54000
74 611 02400	53900	53000	52500	54700	54200

i The clamping screw 70 950 53000 corresponding to article no. 74 611 02200 can be used for both indexable inserts (HN.. and NN..). With article no. 74 611 02400 it can only be used for NN.. indexable inserts. For the HN.. indexable insert, please use the clamping screw from the second column.

Tandem Cartridges TCAS..-HN../WNEF

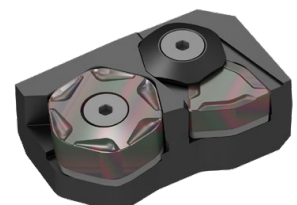
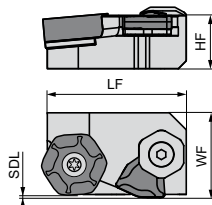

NEW
Tandem
74 611 ...

Designation	LF mm	HF mm	WF mm	SDL mm	Insert	
TCAS12-HN22WNEF16	110	40	65	2.5	HNMH 2215.. / WNEF 161325	09200

**Spare parts
for Article no.**

Article no.	Nut	Insert Clamping screw	Clamping screw Seat	Carbide seat	Carbide seat
74 611 09200	53800	53200	52600	55600	54100

Tandem Cartridges TCAS..HN../WNEU

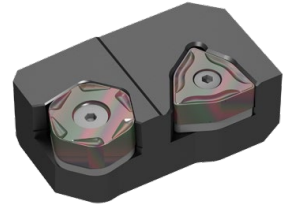
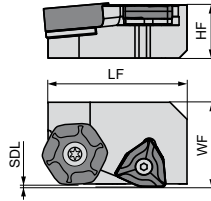

NEW
Tandem
74 611 ...

Designation	LF mm	HF mm	WF mm	SDL mm	Insert	
TCAS12-HN22WNEU16	110	40	65	2.5	HNMH 2215.. / WNEU 1613/1425..	08200
TCAS12-HN28WNEU16	110	40	65	3.5	HNMH 2818.. / WNEU 1613/1425..	08400

**Spare parts
for Article no.**

74 611 08200	53800	52300	53200	55800	54100
74 611 08400	53900	52300	52500	55800	54200

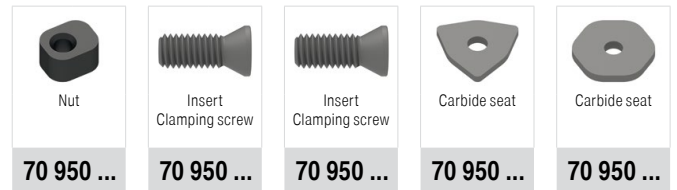

1 The clamping screws in the first column are suitable for the WN.. indexable inserts, the clamping screws in the second column for the HN.. indexable inserts.

Tandem Cartridges TCAS..HN../YN..

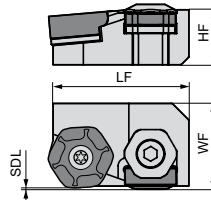

NEW
Tandem
74 611 ...

Designation	LF mm	HF mm	WF mm	SDL mm	Insert	
TCAS12-HN22YN20	110	40	65	1.2	HNMH 2215.. / YNUF 201220	03200
TCAS12-HN22YN27	110	40	65	1.2	HNMH 2215.. / YNUF 271220	03600
TCAS12-HN28YN20	110	40	65	1.2	HNMH 2818.. / YNUF 201220	03400

**Spare parts
for Article no.**

74 611 03200	53800	53200	52600	52400	53500	56400	54100
74 611 03600	53800	53200	52600	52400	53500	56700	54100
74 611 03400	53900	52500	52600	52400	53500	56400	54200

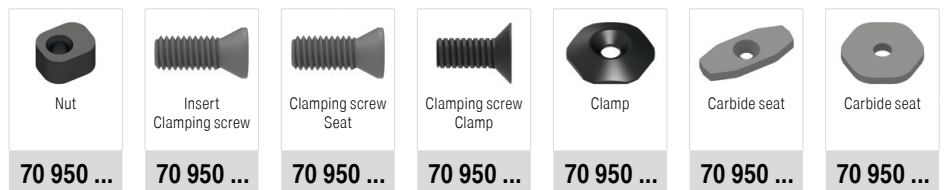

Tandem Cartridges TCA..-WNEF/WNEF

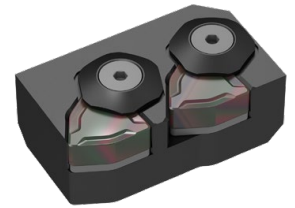
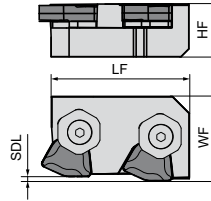

Tandem
74 611 ...

Designation	LF mm	HF mm	WF mm	SDL mm	Insert
TCA12-WNEF16WNEF16	110	40	65	2.5	WNEF 161325 / WNEF 161325

10200

Spare parts
for Article no.
74 611 10200



Clamping screw
Seat

70 950 ...

52600



Clamping screw
Clamp

70 950 ...

52400



Clamp

70 950 ...

53500





Carbide seat

70 950 ...



55600

Spare parts









Screws

	Article no.	Type, Designation	Length [mm]	Size of thread	Wrench size	
	70 950 52200	M8X30 DIN 7991 12.9	30	M8	SW5	
	70 950 52300	10006286/M8.0X30 SW5	30	M8	SW5	
	70 950 822	M6X16-25IP/10003048	16	M6	T25IP	
	70 950 52400	M10X20 DIN 7991 10.9	20	M10	SW6	
	70 950 52500	M10X35 DIN 7991 10.9	35	M10	SW6	
	70 950 52600	M5X8 DIN 7991 10.9	8	M5	SW3	
	70 950 52700	M6X12 SW4 DIN7991 10.9	6	M6	SW4	
	70 950 52800	10006285/M8.0X20 SW5	20	M8	SW5	
	70 950 839	10006887/M3.5x8,6/15IP	8.6	M3.5	T15IP	
	70 950 52900	M5X20 DIN 7991 10.9	20	M5	SW3	
	70 950 53000	S-M6X18/T20 12.9 50060196	18	M6	T20	
	70 950 53100	S-M4X8 ISO 10642 10.9	8	M4	SW2.5	
	70 950 53200	S-M8X35 ISO 10642 10.9	35	M8	SW5	
		70 950 53300	M8X16 DIN 6912 10.9	16	M8	SW6

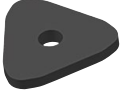
Claws

	Article no.	Type, Designation
	70 950 53400	KLF-D27
	70 950 53500	KLF-D38
	70 950 53600	SPP-33

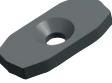
Shims

		Article no.	Type, Designation	Strength s [mm]
HNMH/J..		70 950 54200	U-HNMH2818	5.0
		70 950 54100	U-HNMH2215	5.0
		70 950 54000	U-HNMJ1310	3.0
LNGF..		70 950 54400	U-LNGF2310	6.0
		70 950 54300	U-LNGF2312	4.0
NNUX..		70 950 54700	U-NNUX2010	3.0
		70 950 54800	U-NNUX2712	5.0
		70 950 54600	U-NNUX1508	3.0
		70 950 54500	U-NNUX1208	3.0
RNGH../RNMH..		70 950 55100	U-RNGH3812	5.0
		70 950 55200	U-RNMH5018	5.0
		70 950 55000	U-RNMH2810	3.0
		70 950 54900	U-RNMH2008	3.0
TNGT..		70 950 55300	U-TNGT220815	3.0
WNEF../WNEU../WNGU../WNMF..		70 950 55500	U-WNMF1510	3.0
		70 950 55800	U-WNEU16-06	6.0
		70 950 55400	U-WNMF1106	3.0
		70 950 55700	U-WNEU16-05	5.0
		70 950 55600	U-WNEF1613	5.0
		70 950 56000	U-WNGU1510	3.0
		70 950 56100	U-WNGU1510-05	5.0
		70 950 55900	U-WNGU1010	3.0
		70 950 56200	U-WNMF96	4.75
YNGF../YNGX../YNUR../YNUX..		70 950 56400	U-YNUF2012	5.0
		70 950 56700	U-YNUF2712	5.0
		70 950 56300	U-YNUF1708	5.0
		70 950 56900	U-YNUX1006	3.0
		70 950 56800	U-YNUR2712	3.0
		70 950 56600	U-YNUF2410	5.0
		70 950 56500	U-YNGF2012	5.0
		70 950 57000	U-YNGX150815	3.0
		70 950 57100	U-YNGX150820	3.0
		70 950 57200	U-YNGX1712	3.0

Peeling heads and accessories

The use of innovative cutting materials and optimized tools provides a vital advantage

In addition to inserts, CERATIZIT also offers all the spare parts which are needed for bar peeling. All peeling heads and the associated spare parts are produced upon request.

Peeling heads for bars

Peeling head for bars – Ø 15 to 100 mm

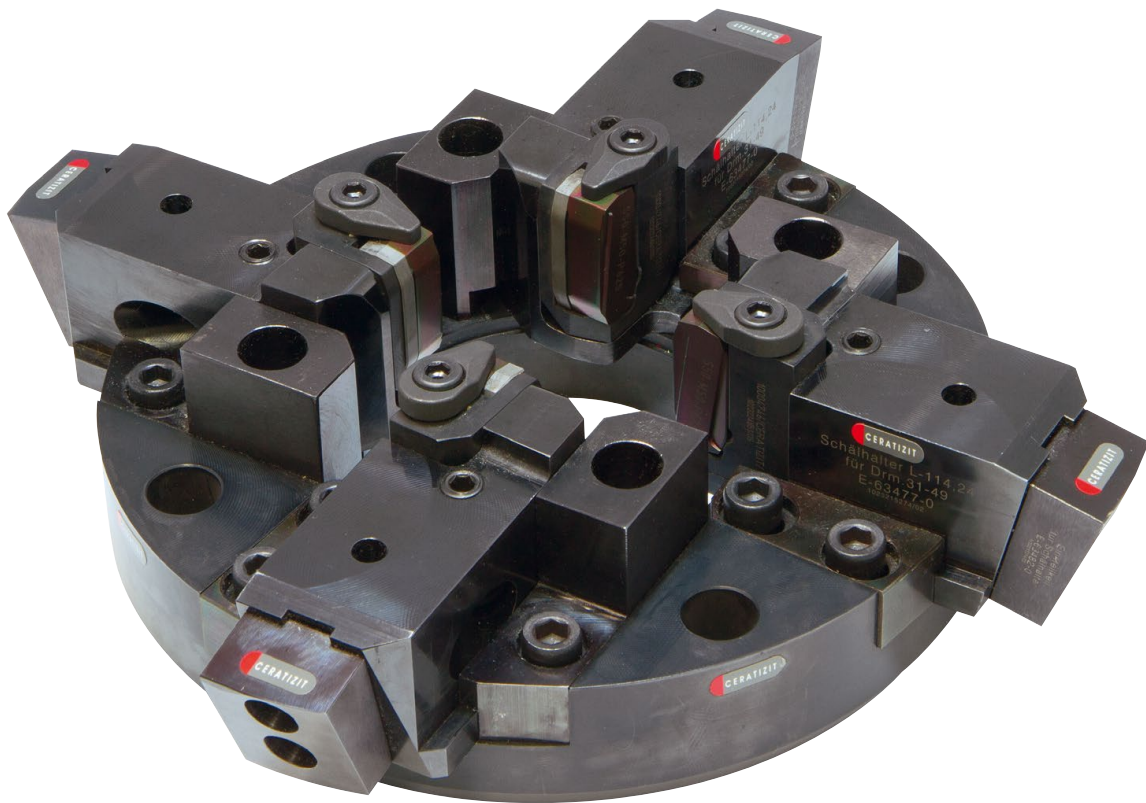

Peeling heads for bars – Ø 150 to 350 mm

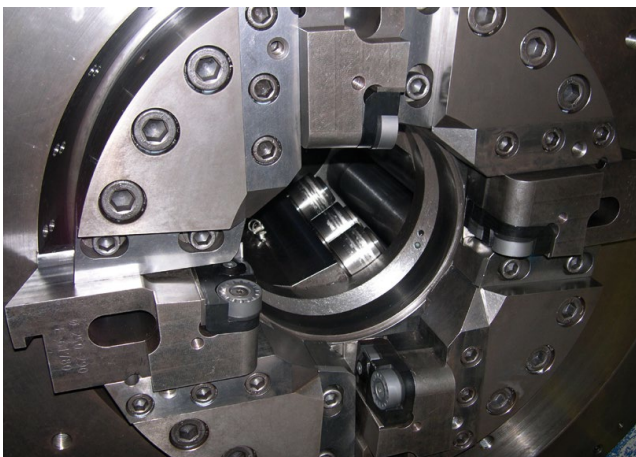

Peeling heads and accessories

In addition to inserts, CERATIZIT also offers all the spare parts which are needed for bar peeling.

Cartridges

- ▲ SINGLE cartridges
- ▲ TANDEM cartridges
- ▲ TRIO cartridges

Tool holders with defined length and adjusting wedge

- ▲ Integrated cartridge seat
- ▲ Integrated insert seat

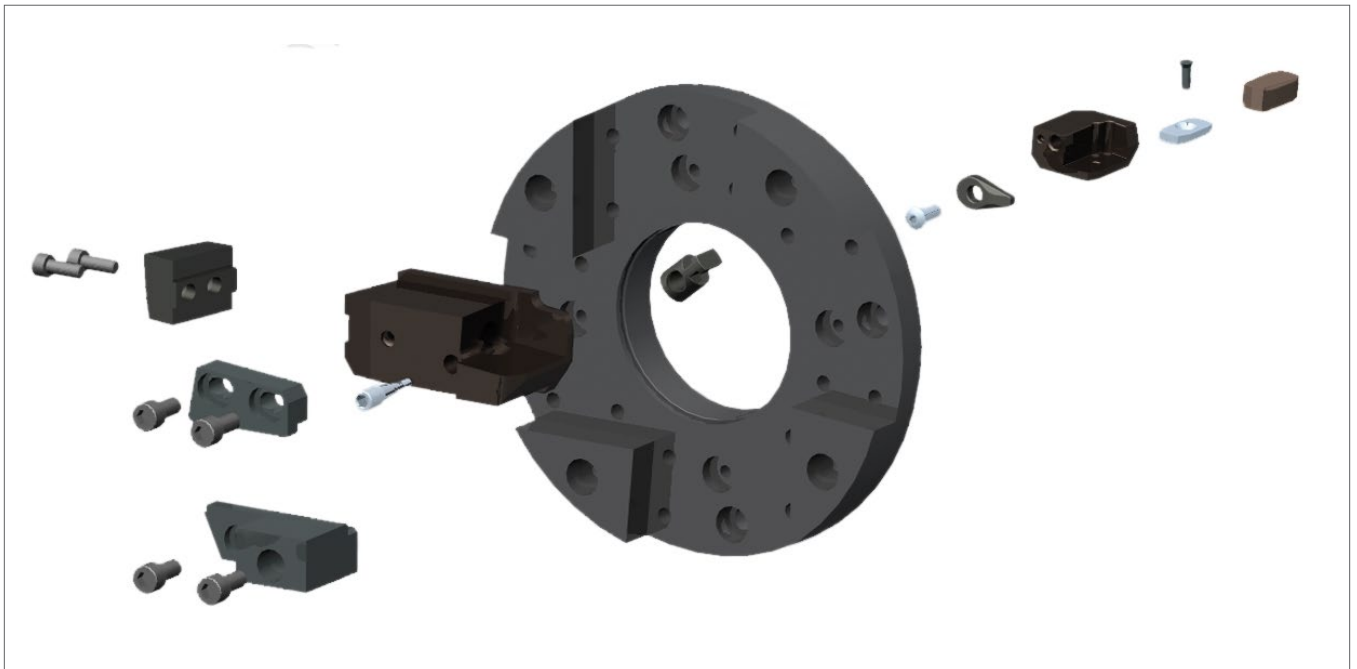

Spare parts

- ▲ Clamping claws
- ▲ Clamping screws
- ▲ Shims
- ▲ Adjustment wedges
- ▲ Clamping and guide bars

Clamping elements

- ▲ Locking tapers
- ▲ Locking pins

Guide components in steel and carbide

- ▲ Guide rollers
- ▲ Guide axes
- ▲ Guide plates

Peeling heads and spare parts upon request

All peeling heads and the associated spare parts are produced upon request.

If you are interested in CERATIZIT peeling heads and accessories, please send us your enquiry.

Clamping components



Locking pins

Adjusting wedges

Locking tapers

Clamping and guide bars

Guide components

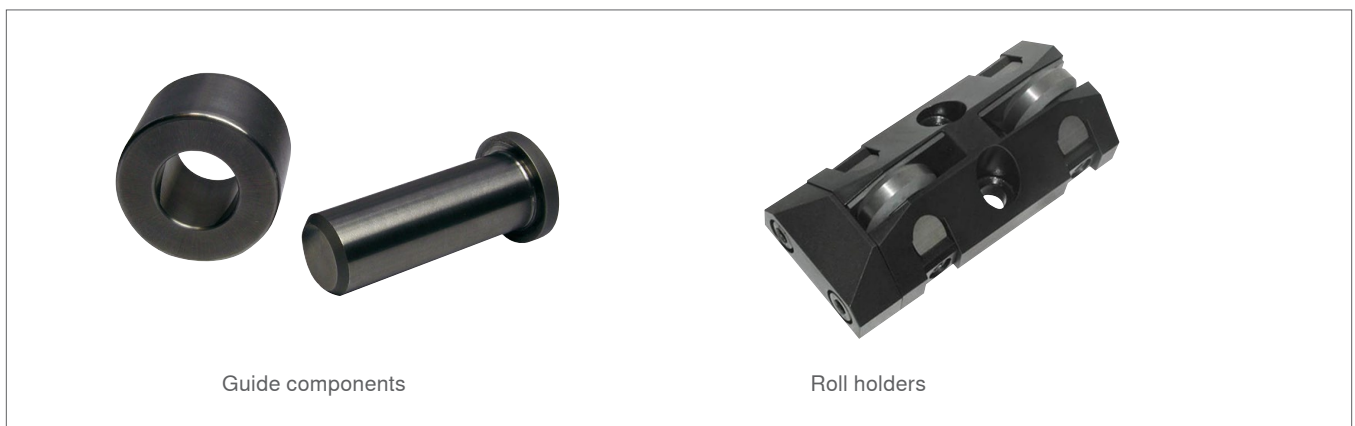

Guide components

Roll holders

Clamping and guide components upon request

All clamping and guide components and the associated spare parts are produced upon request.

If you are interested in CERATIZIT clamping and guide components, please send us your enquiry.

Tools and inserts for bar end machining and chamfering

Tool: Face milling cutter with chamfer insert

Indexable insert:



RPHX 1605M8

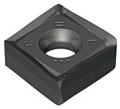

SNKU 150510SN-M50

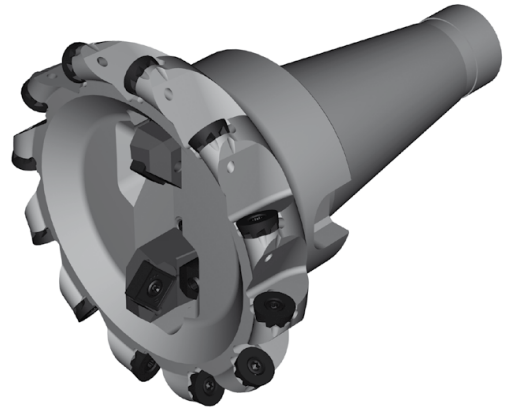

Tool: Face milling cutter with chamfer insert

Indexable insert:



OAKU 060508SR-M50



SDHT 1204AESN

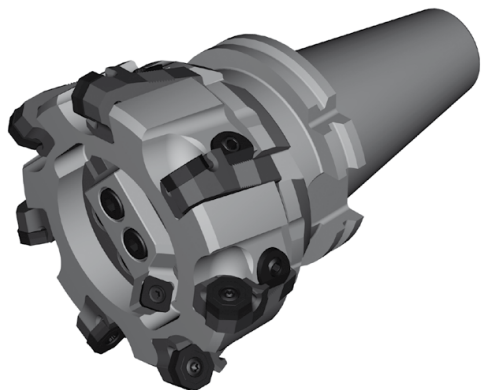

Tool: Face and chamfer head

Indexable insert:



LNUX 400614EN



SNMG 190612FN

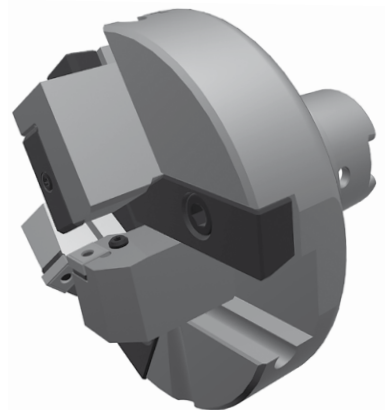

Tool: Face milling cutter with chamfer insert

Indexable insert:



OAKU 060508SR-M50



TCMT 220408EN-M55

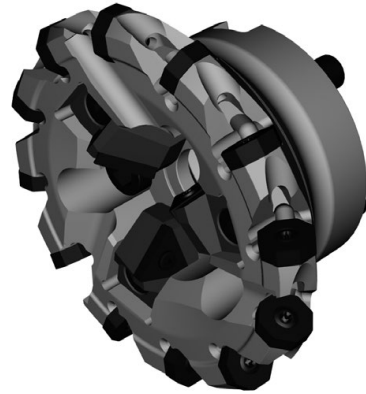

Tool: Face milling cutter with chamfer insert

Indexable insert:



OAKU 060508SR-M50



SDHT 1204AESN



Milling tools upon request

This page shows different examples of milling tools that we produce upon request according to the wishes and requirements of our customers.

If you are interested in CERATIZIT face milling cutters and chamfer heads, please send us your enquiry.

UNITED. EXPERIENCED. METAL CUTTING.



**SPECIALIST FOR INDEXABLE INSERT TOOLS
FOR TURNING, MILLING AND GROOVING**

The product brand CERATIZIT stands for high-quality indexable insert tools. The products are characterized by their high quality and contain the DNA of many years of experience in the development and production of carbide tools.

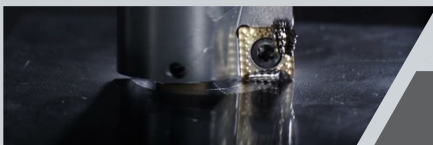

**THE QUALITY LABEL FOR
EFFICIENT BORE PRODUCTION**

High-precision drilling, reaming, countersinking and boring is a matter of expertise: efficient tooling solutions for drilling and mechatronic tools are therefore part of the KOMET brand name.



**EXPERTS FOR ROTATING TOOLS,
TOOL HOLDERS AND CLAMPING SOLUTIONS**

WNT is synonymous with product diversity: solid carbide and HSS rotating tools, tool holders and efficient workholding solutions are all part of this brand.



**CUTTING TOOLS
FOR THE AEROSPACE INDUSTRY**

Solid carbide drills specially developed for the aerospace industry bear the product name KLENK. The highly specialised products are specifically designed for machining lightweight materials.