

SELECTION

A close-up photograph of a lathe machine in operation. A large, polished metal cylindrical workpiece is being turned. A cutting tool with a PCBN insert is engaged with the workpiece, creating a fine chip. The tool has 'H3000C' and 'G7' markings on it. The background is blurred, showing the industrial setting.

HardCut

Hard turning with PCBN indexable inserts

CERATIZIT is a high-technology engineering group specialised in cutting tools and hard material solutions.

Tooling a Sustainable Future

www.ceratizit.com



Welcome!



Placing your order is quick and easy

Customer Service Centre

Freephone Number

UK: 0800 073 2073

Ireland: 1800 93 22 55

Freefax Number

UK: 0800 073 2074

E-Mail

info.uk@ceratizit.com



It couldn't be easier

Ordering via the Online Shop

<https://cuttingtools.ceratizit.com>



On-site technical support

Your Local Technical Sales Engineer

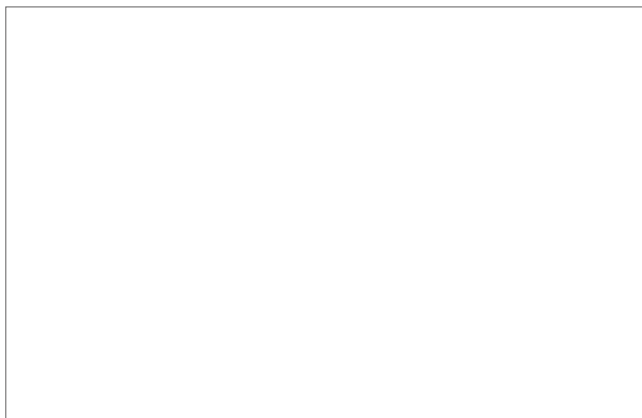

Your customer number

Tooling a Sustainable Future

CERATIZIT: a specialist in sustainable cutting tools and hard material solutions.

Are you looking for a reliable partner for your tooling and machining-process needs? Then look no further! CERATIZIT is not just a tool supplier. Our experts are also on hand to advise you with extensive industry knowledge and decades of experience.

What's more, anyone who wants to pay particular attention to their CO2 balance, will find in us a sustainability-conscious partner with a concrete strategy and target set out in our vision of becoming the number 1 sustainable company in our industry.

For more than 100 years, CERATIZIT has been a pioneer in the field of ambitious hard material solutions for machining and protection against wear. This allows us to guarantee our customers the highest levels of quality and access to the latest developments in the carbide sector – all-round cutting tools expertise from a single source.

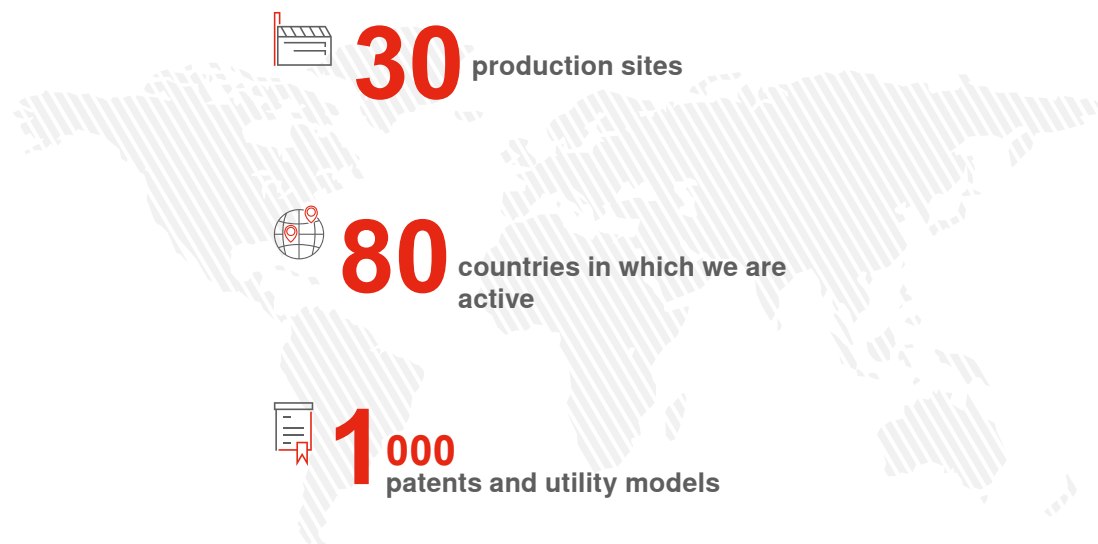

Editorial

Dear customers,

Extremely hard cutting materials allow you to machine hardened cast iron materials (hardness >55 HRC) with geometrically defined cutting edges. At the top end of the cutting material hardness scale are polycrystalline diamonds and cubic boron nitride, which is usually the first choice for hard machining. As your partner for premium-class machining solutions, who guarantees maximum tool life and optimal process security, we offer a wide range of PCBN cutting materials. Take a look at our portfolio of PCBN indexable inserts. Use our selection to find out more about hard machining and about the PCBN indexable inserts which are used in this area. Benefit from our application recommendations and use our tips to see for yourself what our PCBN cutting materials can do, and optimise your process.

Should you have any questions, our specialists in hard machining will be happy to help.

Your CERATIZIT team

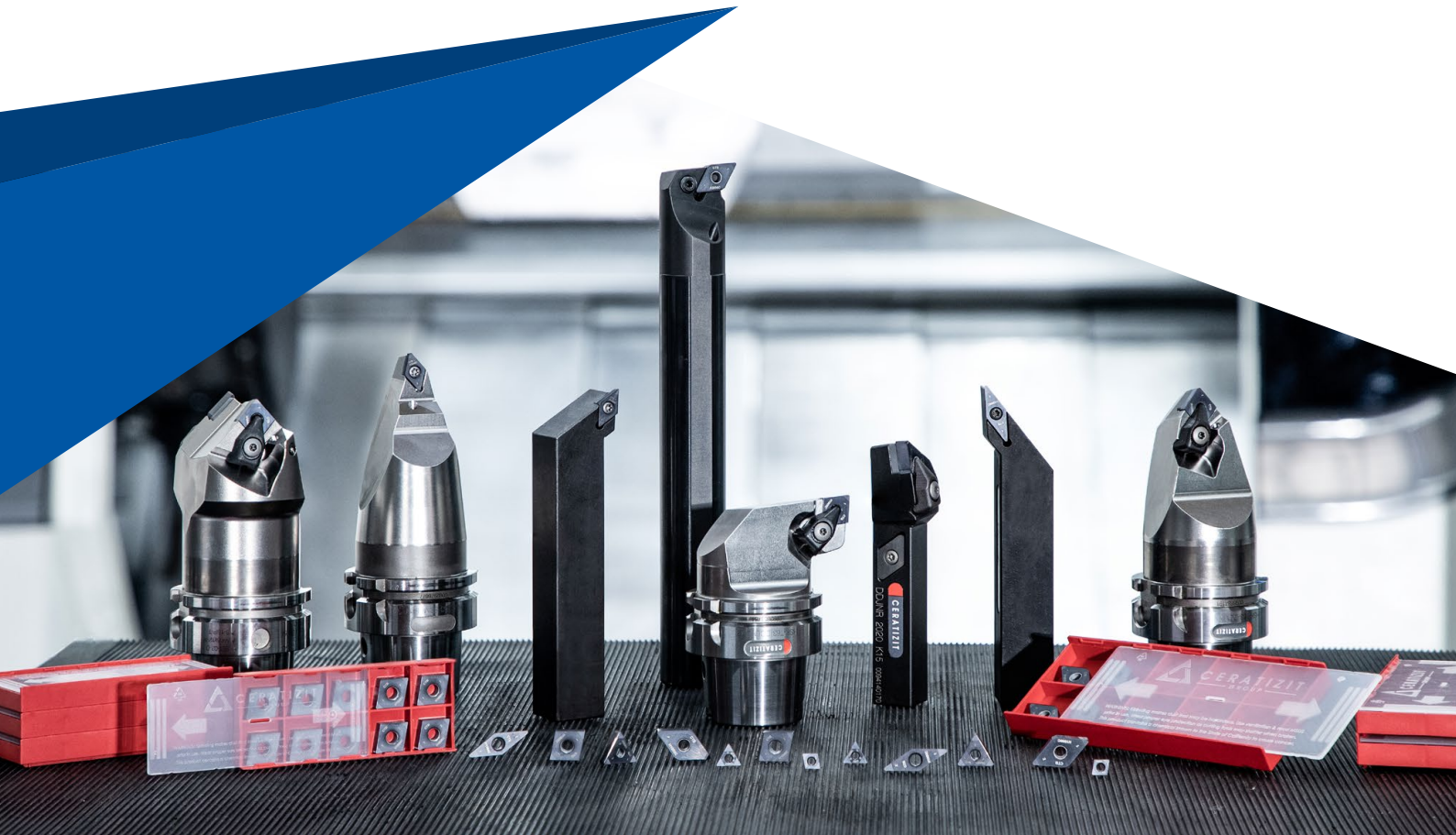

Cutting material – hardness comparison

PCBN is one of the hardest materials in the world. In addition to many other exceptional properties, it is this hardness which makes the material ideal for machining hard, abrasive components. PCBN has a greater chemical and thermal stability than diamond, which reacts with iron and has a maximum temperature limit of approx. 700°C (1300°F). PCBN is resistant up to temperatures exceeding 1000°C (1800°F) and is therefore ideal for the high machining temperatures when hard turning.

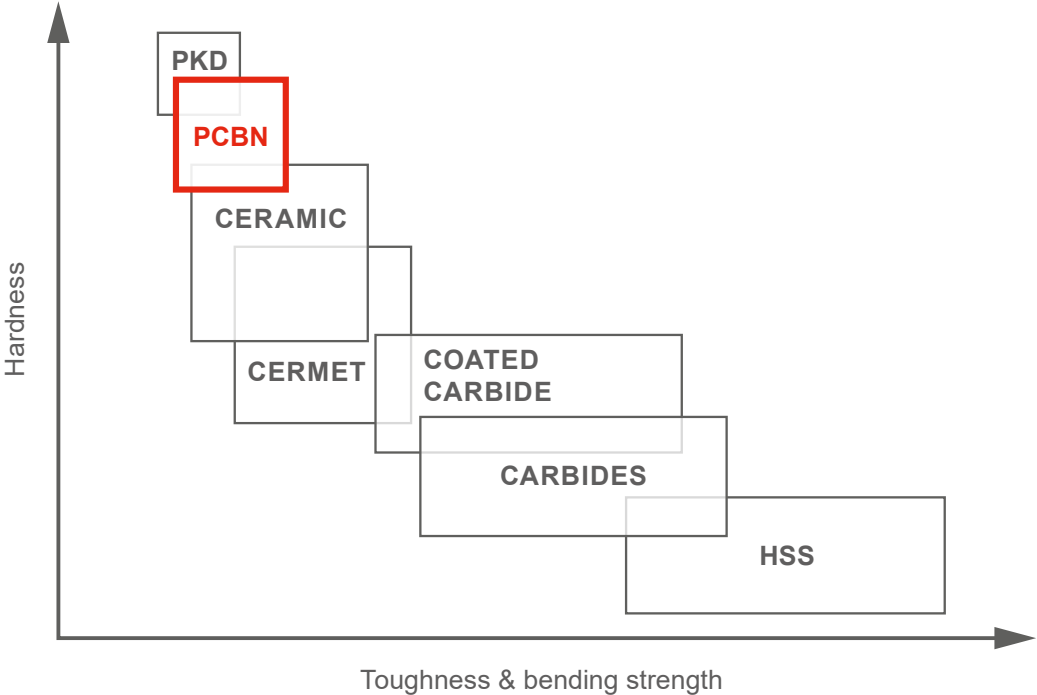

Table of contents

Introduction

Toolfinder – indexable inserts	6+7
Toolfinder – holders	8+9
Introduction to hard turning	10–18

Cutting edge preparation 19

Grade description 20

Selecting the correct PCBN indexable insert 21

Product programme 22–45

Cutting Data 46–49

Technical Information

Wet or dry machining	50
Advantages of hard turning over grinding	50
Impact of wear	51
Coating	52
Surface quality	53
Single-cut or dual-cut machining	54
ISO designation system	56–61
Types of wear	62
Measures in the case of problems	63+64
General formulae	65
Hardness comparison table	66
Material examples	67–69

Project engineering 70–73

CERATIZIT \ Performance

Premium quality tools for high performance.

The premium quality tools from the **CERATIZIT Performance** product line have been designed for specific applications and are distinguished by their outstanding performance. If you make high demands on the performance of your production and want to achieve the very best results, we recommend the Premium tools in this product line.

Toolfinder – indexable inserts

VNGA 30+31

○ ○ ○ □

F M R

RE 0,4 / 0,8

DNGA 24+25

○ ○ ○ □

F M R

RE 0,4 / 0,8 / 1,2

VCGW 43–45

○ ○ ○ □

F M R

RE 0,2 / 0,4 / 0,8

DCGW 37–39

○ ○ ○ □

F M R

RE 0,2 / 0,4 / 0,8

PCBN grade key CERATIZIT

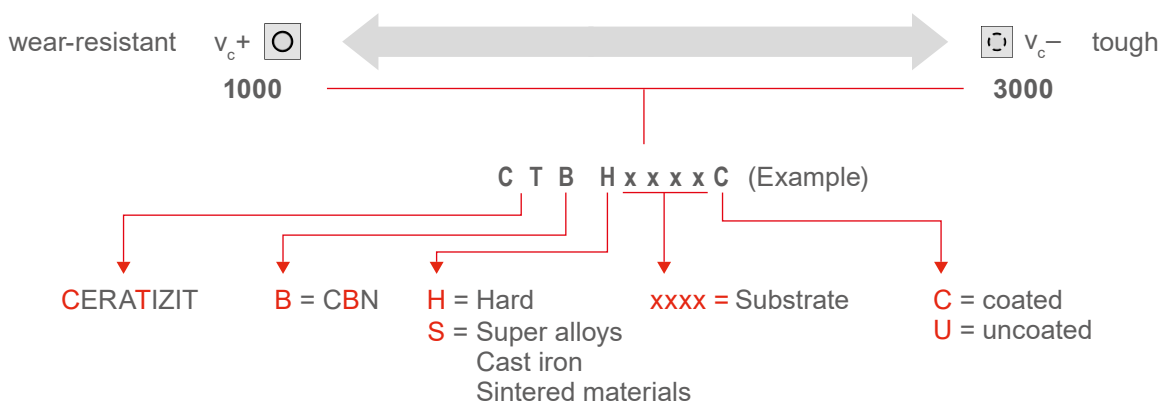

Symbol explanation

CTBH2000C PCBN grade

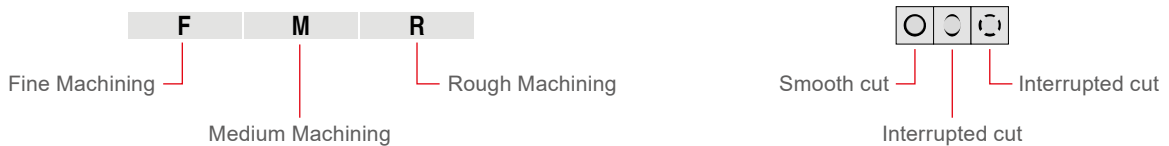

A detailed grades overview can be found on → **Page 20**

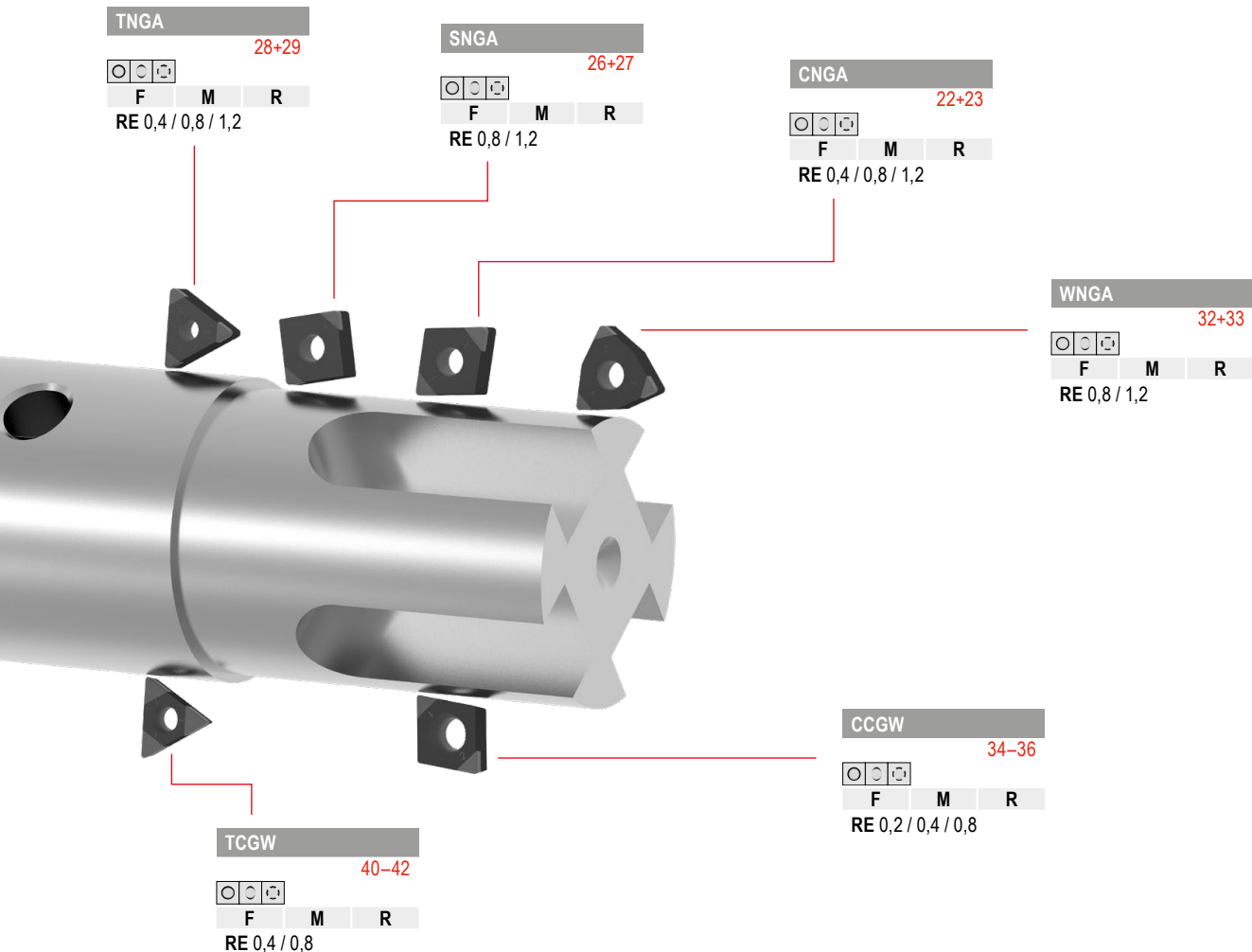

Toolfinder – holders

Tool holders and boring bars for negative inserts

can be found in the **2024 main catalogue – Chapter 9, Indexable insert turning tools** on the following pages:



Geometry	Tool holder	Boring bars	HSK-T	PSC
CN..	→ 09 18-21	→ 09 24+25	→ 09 22+25	→ 09 23
DN..	→ 09 31-34	→ 09 41+42	→ 09 34-36+42	→ 09 37-40
SN..	→ 09 47-53	→ 09 54	→ 09 53	
TN..	→ 09 58-60	→ 09 61		
VN..	→ 09 64		→ 09 65	→ 09 65+66
WN..	→ 09 71+72	→ 09 74+75	→ 09 73+75	→ 09 73

Tool holders and boring bars for positive inserts

can be found in the **2024 main catalogue – Chapter 9, Indexable insert turning tools** on the following pages:



Geometry	Tool holder	Boring bars	HSK-T	PSC
CC..	→ 09 85-91	→ 09 94-98	→ 09 92+98	→ 09 93
DC..	→ 09 109-115	→ 09 119-123	→ 09 116+123	→ 09 117+118
TC..	→ 09 148-151	→ 09 152		
VC..	→ 09 160-168	→ 09 172-174	→ 09 168-170+174	→ 09 170+171

Toolfinder – holders

Exchangeable cutting heads and base holders for negative inserts

can be found in the **2024 main catalogue – Chapter 9, Indexable insert turning tools** on the following pages:



Geometry	Exchangeable cutting heads	Square shank holder 0°	Square shank holder 90°	cylindrical	HSK-T	PSC
CN..	→ 09 187			→ 09 183	→ 09 180	→ 09 177
DN..	→ 09 187+188	→ 09 185	→ 09 186	Actively vibration-damped → 09 184	Vibration damped → 09 181	Vibration damped → 09 178
WN..	→ 09 188				Actively vibration-damped → 09 182	Actively vibration-damped → 09 179

Exchangeable cutting heads and base holders for positive inserts

can be found in the **2024 main catalogue – Chapter 9, Indexable insert turning tools** on the following pages:



Geometry	Exchangeable cutting heads	Square shank holder 0°	Square shank holder 90°	cylindrical	HSK-T	PSC
CC..	→ 09 189			→ 09 183	→ 09 180	→ 09 177
DC..	→ 09 189+190	→ 09 185	→ 09 186	Actively vibration-damped → 09 184	Vibration damped → 09 181	Vibration damped → 09 178
VC..	→ 09 190+191				Actively vibration-damped → 09 182	Actively vibration-damped → 09 179

Introduction to hard turning

Hard materials

The materials machined have a hardness of up to 67 HRC. Case-hardened steels are subject to soft pre-machining (unhardened) using carbide indexable inserts. After hardening (minimum hardness of steel 55 HRC) areas showing hardening distortions and also the running surfaces must be reworked.

When finish machining with PCBN, very high surface quality (up to R_a 0.2) and close tolerances can be achieved. In many cases, grinding is not necessary.

Turning instead of grinding

Advantage/benefit

- ▲ Change to a grinding machine is not necessary
- ▲ Faster cycle time
- ▲ Several machining operations can be carried out with one tool: longitudinal and face turning, external and internal machining in one set-up
- ▲ Roughing and finishing in one process
- ▲ Coolant substitution

Principle of hard turning

Chip formation when machining steel

The softening of the chip thanks to high cutting speeds is the basis of hard machining. Shear chips can be created on hardened steel as a result of the cutting energy introduced (high temperatures). Carbide indexable inserts have a higher flexural strength than PCBN and are therefore more suitable for soft machining. From a hardness of 50 HRC, the temperatures generated during the machining process are so high that the wear of the carbide indexable insert is uneconomically high. The reason for this is the insufficiently elevated-temperature hardness of the carbide. In contrast, PCBN has a higher hardness than carbide and can still be used cost-effectively at high temperatures.

Example:

Material:	100Cr6 (1.1645)
Feed:	$f = 0,1 \text{ mm/U}$
Cutting speed:	$v_c = 120 \text{ m/min}$

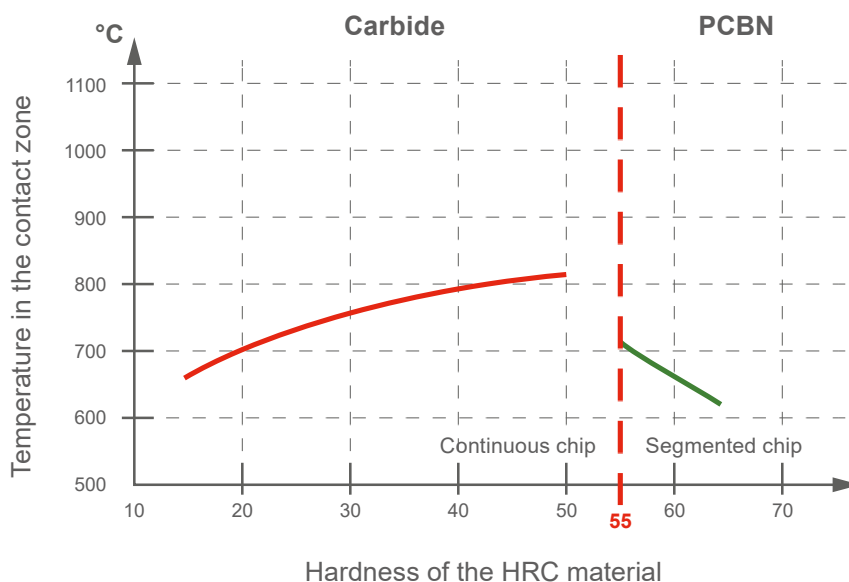

Hard machining with PCBN from 55 HRC

- up to 50 HRC use of carbide
- From 55 HRC use of PCBN

Segmented chip with chip thickness $h_m > 0.02$ mm

Due to the reduced width of cut of $h_m > 0.02$ mm, the material (chip) is cut out upwards, the individual chip segments remain stuck to one another, thus forming the typical saw tip structure.

Material: 100Cr6 (60-62 HRC)
Chip thickness: $h_m = 0,05$ mm

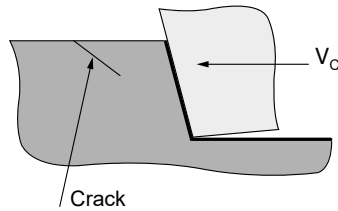

Crack on the surface of the steel

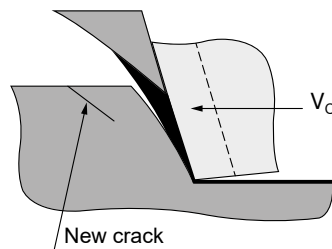

Chip segment is cut out, a new crack is created
Chip segments fuse into one segmented chip

Continuous chip with small chip thickness $h_m < 0.02$ mm

As a result of the reduced width of cut $h_m < 0.02$ mm, a continuous chip is created since the typical cracks are not created at this width of cut. The chip is evacuated across the tool cutting edge, so that there is no breakage and a continuous chip forms.

Material: 100Cr6 (60-62 HRC)
Chip thickness: $h_m = 0,005$ mm

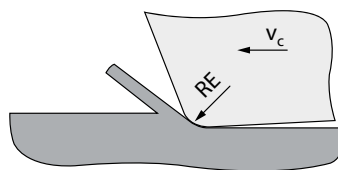
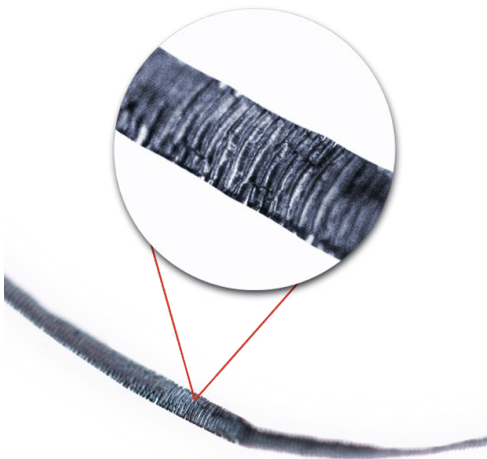

Application

- ▲ The basis for hard machining is the softening of the chip as a result of the high cutting speeds
→ Ideally, the chip is red hot.
This can be recognised by the medium-grey tempering colour on the cooled-down back of the chip.

Under optimal processing conditions the resulting shear chip is brittle and can easily be crumbled between the fingers.

CERATIZIT – the carbide concept for success

Carbide has become indispensable in numerous industries and production processes. Complex products and modern materials place increasingly high demand on tools, materials and precision processing.

Carbides are composite materials consisting of a hard material and a very tough binder metal. They are extremely hard, and are characterised by high wear resistance and high hot hardness. Carbide is used in various fields that require tools or components to be particularly wear-resistant, such as in the machining of hard materials. CERATIZIT composite carbides improve the quality of tools and components, give them a longer service life, reduce costs and ensure process reliability.

Carbides from CERATIZIT are made of super-strong tungsten carbide and a relatively soft binder metal such as cobalt. The two materials are fused in powder form. CERATIZIT offers more than 100 different carbide grades with different compositions. We have the perfect

solution for every application and industry. CERATIZIT masters the whole production process chain from powder production, moulding and sintering to finishing and surface treatment. We grind, polish or erode the blank and coat it with innovative wear-resistant coatings. This gives our product the properties required for industrial applications.

To make a finished carbide blank from a powder mix, you first need to press it into a mould. The resulting green compact can then be machined. Once it has been sintered at a temperature of between 1,300 and 1,500 degrees Celsius and a pressure of up to 100 bar, it is turned into a homogeneous and dense cutting material.

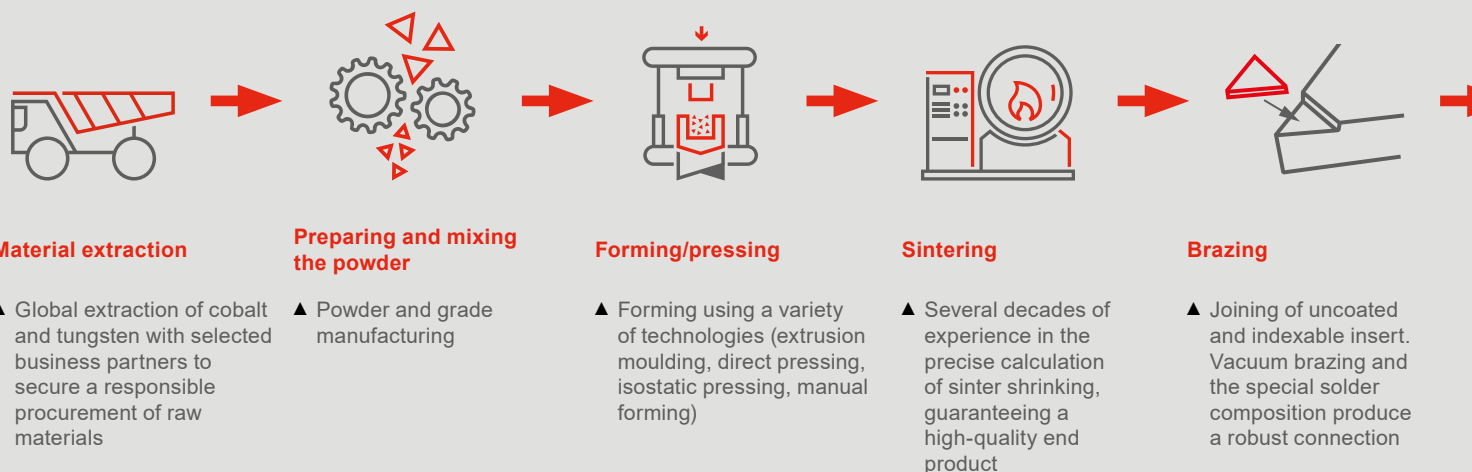

Carbide – composite material with valuable properties

The amount of metal binder used and the grain size of the tungsten carbide both have an impact on the performance characteristics of the carbide. The specific composition determines the hardness, flexural strength and fracture toughness of the cutting material. The tungsten carbide grains have an average size of 0.5 to 20 micrometres (µm). The softer binder metal, cobalt, fills the space in between.

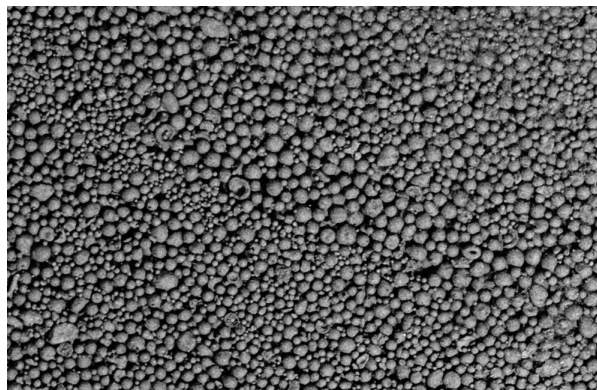

On the one hand, when extremely high toughness is required, the cobalt content can amount to as much as 30%. On the other, the cobalt content is reduced and the grain size decreased to the ultrafine range (e.g. 0.3 µm), in order to guarantee maximum wear resistance.

CERATIZIT offers a customised solution for every one of your applications, particularly for the machining sector and wear parts.

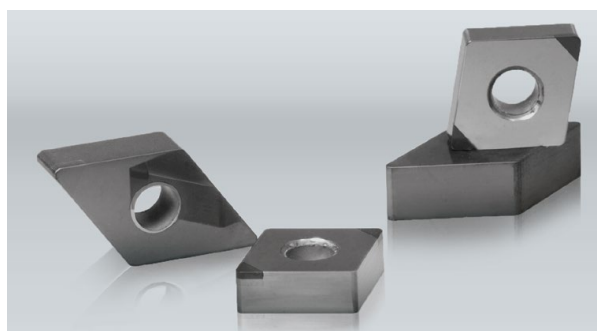

- Grinding**

▲ Peripheral grinding and chamfering; the indexable insert is ready for use
- Coating**

▲ Coating using the PVD process, metals such as titanium and aluminium are heated under vacuum, vaporous and using electric voltage, they stick to the surface of the indexable insert.
- Quality assurance**

▲ All products are subject to strict quality control tests by experienced specialists
- Delivery/dispatch**

▲ Automated high-tech shuttle warehouse, ensuring that your goods are ready for dispatch in next to no time.
- Recycling**

▲ We organise the entire process for you and also provide free collection containers.

PCBN – production of round blanks

Pyrolysis

of boron-halogen compounds
in a catalytic reaction



Boron nitride with a hexagonal lattice structure



PCBN – synthesis

Pressure: 5 – 9 GPa
Temperature: 1600 – 2100°C

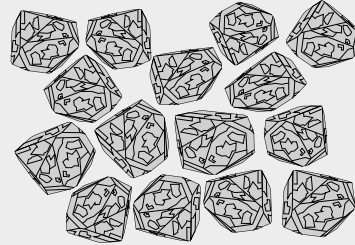

Boron nitride grains (grit) with cubic body and centred lattice

High hot hardness

Hardness at 800°C comparable with the hardness of carbide at room temperature

PCBN – production of indexable inserts

Round blank

Ø 40 - 100 mm



Separating the tips

Laser or wire erosion process



Brazing

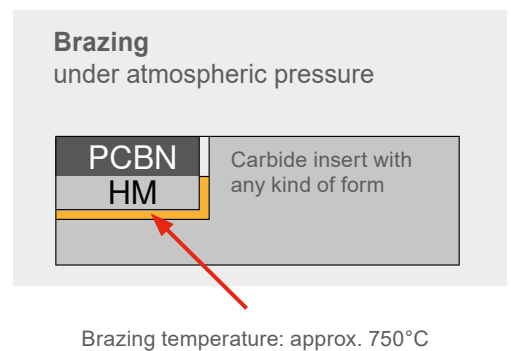
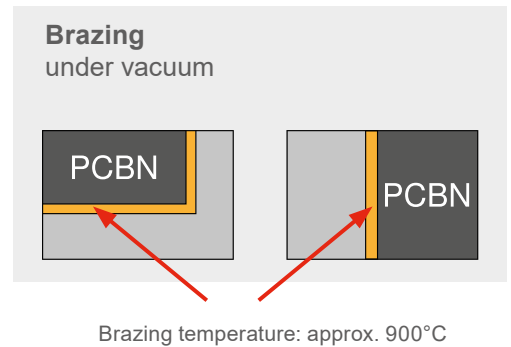
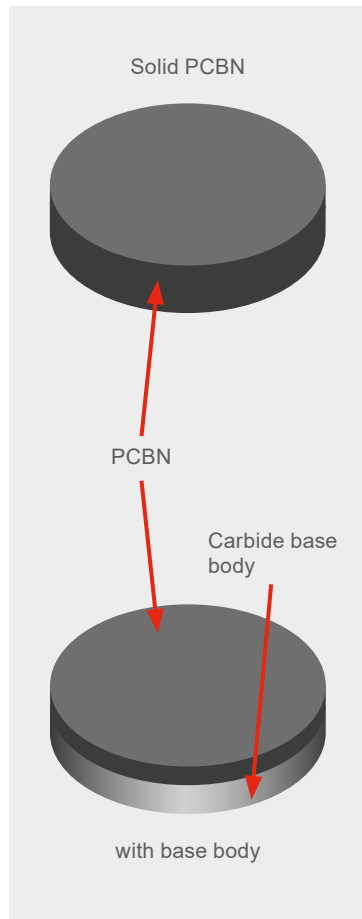

→ **Hot pressing**
of the PCBN grains

Binder

- ▲ Ceramic (TiC, TiN, TiCN, Al₂O₃)
- ▲ Metallic (WC-Co-Ni)

Pressure: ca. 5 GPa
Temperature: >1000°C

*Base body
flat cylindrical carbide substrate*

→ **PCBN round blanks**



Properties of PCBN

- ▲ Second hardest cutting material after diamond (4,700 N/mm²)
- ▲ High wear resistance (abrasion)
- ▲ High oxidation resistance up to 1,250°C
→ therefore suitable for the machining of iron alloys
- ▲ High compressive strength but low tensile strength
- ▲ Good thermal conductivity

→ **Grinding, chamfering, honing**
(coating when necessary)



→ **End product**
Ready-to-use indexable insert

PCBN-tipped inserts

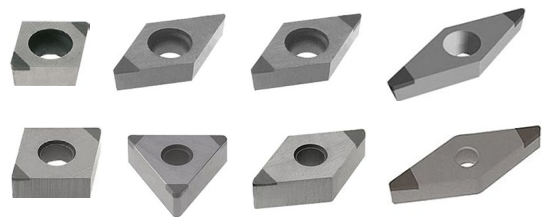

Solid PCBN inserts

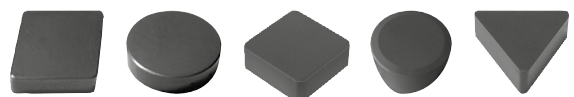

**Solid PCBN inserts with C-Clamp
clamping dimple**

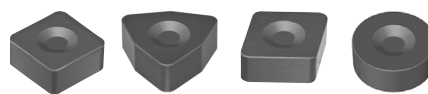

Solid PCBN inserts with hole



Requirements of the machine, clamping, workpiece

Stable machine

- ▲ Robust machine design, ideally specifically a machine for hard turning
- ▲ Extensive stress can lead to unstable processes on unstable machines

Backlash-free guides

- ▲ Spindle run-out $<0.7 \mu\text{m}$
- ▲ Repeatability of the axes $<0.8 \mu\text{m}$
- ▲ Hydrostatic bearings
- ▲ Good maintenance condition of the machine
- ▲ Can cause the indexable insert to break uncontrollably, hindering the dimensional accuracy of the workpiece

Steady rest and tailstock

- ▲ Absolutely necessary for long or thin-walled workpieces
- ▲ If the required surface quality cannot be achieved

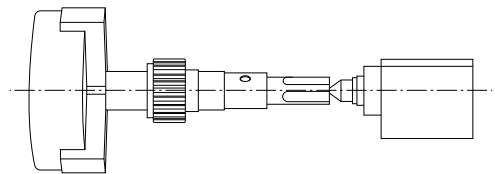

Tool interface

- ▲ Stable tool interface, avoid unnecessary overhangs
- ▲ Select the greatest possible tool interface
- ▲ Clamp the tool as short as possible

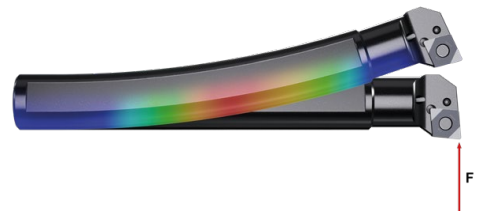

Natural vibrations of the machine

- ▲ Stable machine foundation
- ▲ To counteract vibrations from other machines
- ▲ It is best for the machine to be on an encapsulated foundation



Clamping and workpiece

Clamping

One-sided clamped workpieces

- ▲ Clamp workpiece as short as possible, observe length and diameter ratio approx. 2:1
- ▲ Can lead to vibrations in the process

Long thin-walled workpieces

- ▲ Support workpieces with steady rest or tailstock
- ▲ To counteract vibrations in the process

Soft moulded jaws or collet

- ▲ Positive clamping of the workpiece/in particular for thin-walled workpieces
- ▲ Stable manufacturing process

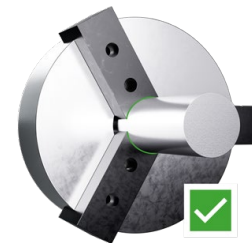
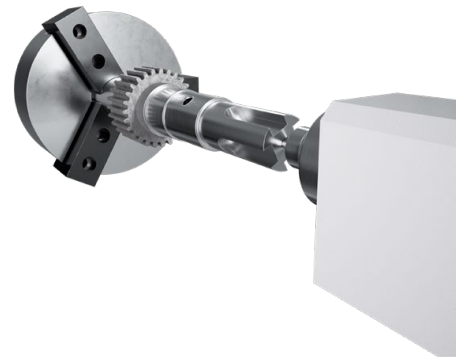

Workpiece pre-machining/soft machining

Burr formation

- ▲ Uncontrolled tool breakage when hard machining

Define tight dimension tolerances for pre-machining

- ▲ Better defined tool life when hard machining

Chamfers and radii

- ▲ Ensure a smooth entry and exit of the tool

Sharp edges

- ▲ Leads to edge breakages on cutting edge and workpiece

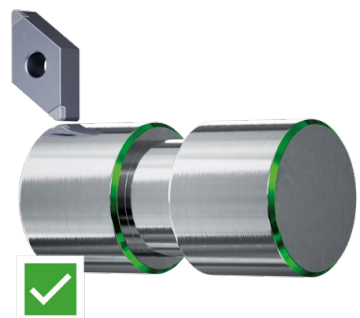

Material effect on hard machining

Hard machining with PCBN

When machining hardened steel, this is usually called hard machining. This machining mechanism involves self-induced hot machining. Here, a defined high temperature of approx. 550 to 750°C is needed in the shear zone. This required temperature is obtained by converting the existing energy into heat. This energy is available in the form of cutting speed v_c , feed f , depth of cut a_p and the chamfer geometries F-M-R of the PCBN cutting edges. Cooling is usually not necessary. Below are three tempering diagrams. You can see the drop in hardness as the temperature increases.

There are however significant differences here. For self-induced hot machining with our PCBN grades, the ideal hardness is in the shear zone at 40 to 45 HRC. This means that different machining temperatures between 550 to 750°C are required.

Tempering diagram 1.2379 (X155CrVMo 12 - 1)

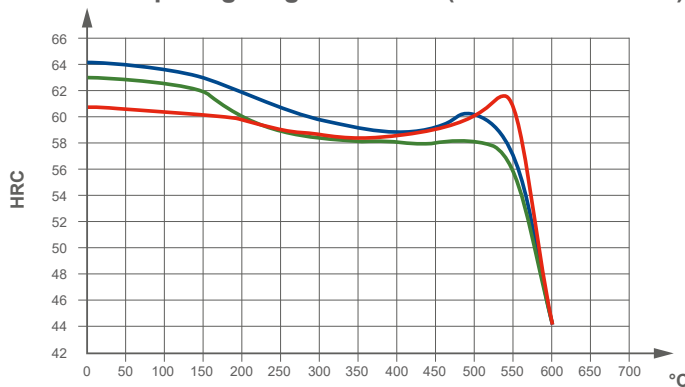

Hardening temperatures:

- At 980°C
- At 1020°C
- At 1050°C

Tempering diagram 1.7131 (16MnCr5)

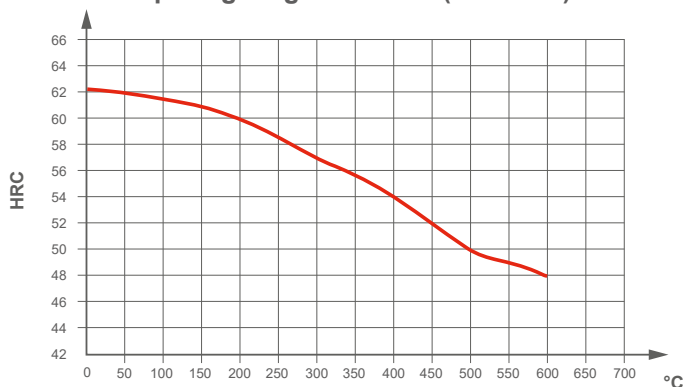

Tempering diagram 1.3505 (100Cr6)

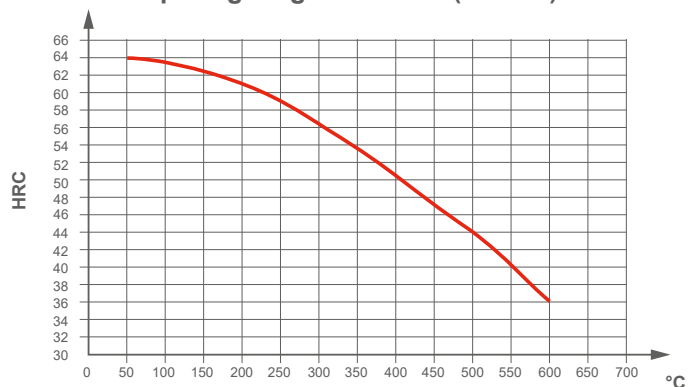

At approx. 600°C, steel 1.2379 still has a hardness of approx. 58 HRC, steel 1.7131 of approx. 48 HRC and steel 1.3505 only achieves approx. 36 HRC, whereby the original hardness is approx. 62 HRC.

Cutting edge preparation

The stability of a cutting edge increases as the chamfer angle and chamfer width increase, but at the same time the cutting force increases and subsequently also the temperature in the process.

A larger chamfer distributes the cutting force across a larger area of the cutting edge.

This increases the stability of the cutting edge, thereby facilitating higher feeds. If process stability and a constant tool life are the highest priority, then we recommend choosing a large chamfer.

If the highest priority is to achieve a very good

surface quality and optimum dimensional accuracy, then it is advisable to use a small chamfer for the manufacturing process. Vibrations, cutting forces and temperature are hereby reduced.

Hard turning in most cases is the finishing of the workpiece, the optimum cutting edge preparation is a deciding factor in order to reliably produce high-quality components with a long service life.

In the case of indexable inserts with no chip breaker, the correct chamfer design is vital, as well as the type of cutting edge. For this reason, the designation system has been extended with the following key to the various chamfer designs. The design and angle can be seen in the overview below.

Preparation key at CERATIZIT

Designation in line with ISO Type of cutting edge	CERATIZIT chamfer design	Definition
SN (chamfered and rounded)	014D	0,14 x 20°
EN (rounded)	rounded	

Chamfer design **SN**

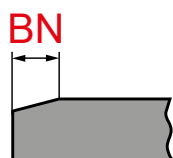

Chamfer width

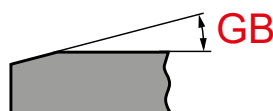

Chamfer angle

Type of cutting edge **EN**



CODE FOR CHAMFER ANGLE GB

A	B	C	D	E	F	G
5°	10°	15°	20°	25°	30°	35°

Precision and geometrical accuracy

Process stability, tool life

Examples	Chamfer width [mm]	Chamfer angle GB
CNGA 120408SN-009C	0,09	15°
DCGW 11T304SN-014D	0,14	20°

Grade description

PCBN grade

Features

CTBH1000C

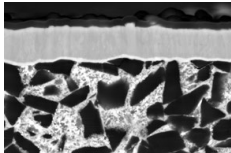

ISO | H10

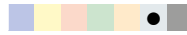

Specifications:

Composition: Cubic boron nitride (PCBN) 70% | binder phase ceramic | Grain size: 3 μm |
Layer system: PVD TiN/TiAlN

Recommended use:

High-performance grade for hard turning in a smooth and slightly interrupted cut. Ideal for extremely worn and hardened steel grades.

CTBH2000C

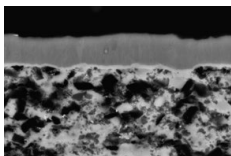

ISO | H20

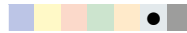

Specifications:

Composition: Cubic boron nitride (PCBN) 40% | binder phase ceramic | Grain size: 1 μm |
Layer system: PVD TiN/TiAlN

Recommended use:

Excellent surface qualities. First choice for hard-soft machining and surface layer. Perfect for very small-scale production and use in a wide variety of applications.

CTBH3000C

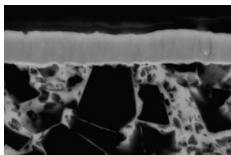

ISO | H30

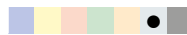

Specifications:

Composition: Cubic boron nitride (PCBN) 65% | binder phase ceramic | Grain size: 2-3 μm |
Layer system: PVD TiN/TiAlN

Recommended use:

Particularly suitable for strong to slightly interrupted cuts. Can also be used in unfavourable machining conditions such as vibrations.

Selecting the correct PCBN indexable insert

Interrupted cut Machining	Smooth cut	Continuous to slightly interrupted cut	Strong to slightly interrupted cut
Fine machining	CTBH1000C F EN rounded	CTBH2000C F EN rounded	CTBH3000C F 0,14mm x 20°
Medium machining	CTBH1000C M 0,09mm x 15°	CTBH2000C M 0,09mm x 15°	CTBH3000C M 0,18mm x 25°
Rough machining	CTBH1000C R 0,14mm x 20°	CTBH2000C R 0,14mm x 20°	CTBH3000C R 0,20mm x 35°

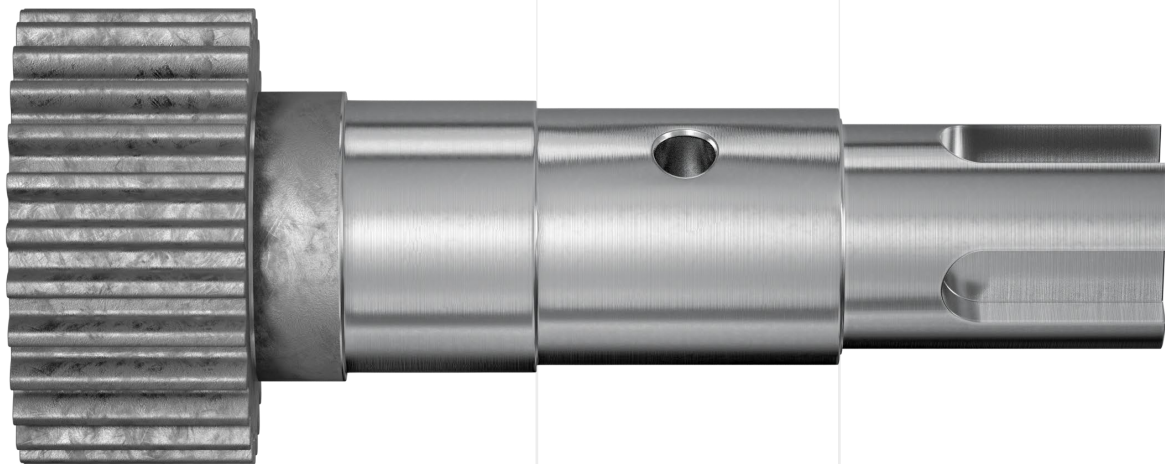

Interrupted cut	● ● ●	● ● ●	● ● ●
Cutting speed	● ● ●	● ● ●	● ● ●
Requirements on toughness	● ● ●	● ● ●	● ● ●

CNGA

Designation	L mm	S mm	D1 mm	IC mm
CNGA 1204..	12.9	4.76	5.13	12.7

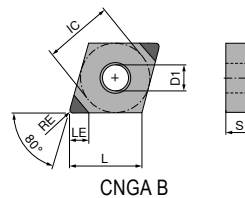

CNGA

▲ TCE(NOI) = Design and number of equipped cutting edge corners

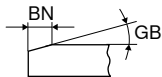

NEW	NEW	NEW
CTBH1000C	CTBH2000C	CTBH3000C
F	F	F
PCBN CNGA	PCBN CNGA	PCBN CNGA
71 003 ...	71 003 ...	71 003 ...
£ Y0/Y#	£ Y0/Y#	£ Y0/Y#
70.41 70002	70.41 80002	70.41 90002
70.41 70302	70.41 80302	70.41 90302
70.41 70602	70.41 80602	70.41 90602

ISO	RE mm	BN mm	GB	TCE (NOI)	LE mm
120404EN	0.4			B (2)	3.3
120404SN	0.4	0.14	20°	B (2)	3.3
120408EN	0.8			B (2)	3.3
120408SN	0.8	0.14	20°	B (2)	3.3
120412EN	1.2			B (2)	3.1
120412SN	1.2	0.14	20°	B (2)	3.1

P
M
K
N
S
H
O

CNGA

▲ TCE(NOI) = Design and number of equipped cutting edge corners

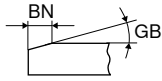

NEW	NEW	NEW
CTBH1000C	CTBH2000C	CTBH3000C
M PCBN CNGA	M PCBN CNGA	M PCBN CNGA
71 003 ...	71 003 ...	71 003 ...
£ Y0/Y#	£ Y0/Y#	£ Y0/Y#
70.41 70102	70.41 80102	70.41 90102
70.41 70402	70.41 80402	70.41 90402
70.41 70702	70.41 80702	70.41 90702

ISO	RE mm	BN mm	GB	TCE (NOI)	LE mm
120404SN	0.4	0.09	15°	B (2)	3.3
120404SN	0.4	0.18	25°	B (2)	3.3
120408SN	0.8	0.09	15°	B (2)	3.3
120408SN	0.8	0.18	25°	B (2)	3.3
120412SN	1.2	0.09	15°	B (2)	3.1
120412SN	1.2	0.18	25°	B (2)	3.1

P
M
K
N
S
H
O

CNGA

▲ TCE(NOI) = Design and number of equipped cutting edge corners

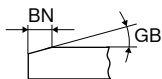

NEW	NEW	NEW
CTBH1000C	CTBH2000C	CTBH3000C
R PCBN CNGA	R PCBN CNGA	R PCBN CNGA
71 003 ...	71 003 ...	71 003 ...
£ Y0/Y#	£ Y0/Y#	£ Y0/Y#
70.41 70202	70.41 80202	70.41 90202
70.41 70502	70.41 80502	70.41 90502
70.41 70802	70.41 80802	70.41 90802

ISO	RE mm	BN mm	GB	TCE (NOI)	LE mm
120404SN	0.4	0.14	20°	B (2)	3.3
120404SN	0.4	0.20	35°	B (2)	3.3
120408SN	0.8	0.14	20°	B (2)	3.3
120408SN	0.8	0.20	35°	B (2)	3.3
120412SN	1.2	0.14	20°	B (2)	3.1
120412SN	1.2	0.20	35°	B (2)	3.1

P
M
K
N
S
H
O

DNGA

Designation	L mm	S mm	D1 mm	IC mm
DNGA 1506..	15.5	6.35	5.16	12.7

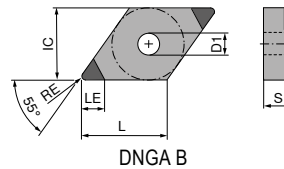

DNGA

▲ TCE(NOI) = Design and number of equipped cutting edge corners

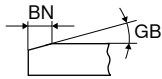

NEW		NEW		NEW	
CTBH1000C		CTBH2000C		CTBH3000C	
○ ○ □		○ ○ □		○ ○ □	
F		F		F	
PCBN		PCBN		PCBN	
DNGA		DNGA		DNGA	
71 017 ...		71 017 ...		71 017 ...	
£		£		£	
Y0/Y#		Y0/Y#		Y0/Y#	
70.41	70002	70.41	80002	70.41	90002
70.41	70302	70.41	80302	70.41	90302
70.41	70602	70.41	80602	70.41	90602

ISO	RE mm	BN mm	GB	TCE (NOI)	LE mm
150604EN	0.4			B (2)	3.6
150604SN	0.4	0.14	20°	B (2)	3.6
150608EN	0.8			B (2)	3.3
150608SN	0.8	0.14	20°	B (2)	3.3
150612EN	1.2			B (2)	3.0
150612SN	1.2	0.14	20°	B (2)	3.0

P
M
K
N
S
H
O

DNGA

▲ TCE(NOI) = Design and number of equipped cutting edge corners

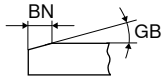

NEW	NEW	NEW
CTBH1000C	CTBH2000C	CTBH3000C
M	M	M
PCBN DNGA	PCBN DNGA	PCBN DNGA
71 017 ...	71 017 ...	71 017 ...
£ Y0/Y#	£ Y0/Y#	£ Y0/Y#
70.41 70102	70.41 80102	70.41 90102
70.41 70402	70.41 80402	70.41 90402
70.41 70702	70.41 80702	70.41 90702

ISO	RE mm	BN mm	GB	TCE (NOI)	LE mm
150604SN	0.4	0.09	15°	B (2)	3.6
150604SN	0.4	0.18	25°	B (2)	3.6
150608SN	0.8	0.09	15°	B (2)	3.3
150608SN	0.8	0.18	25°	B (2)	3.3
150612SN	1.2	0.09	15°	B (2)	3.0
150612SN	1.2	0.18	25°	B (2)	3.0

P
M
K
N
S
H
O

DNGA

▲ TCE(NOI) = Design and number of equipped cutting edge corners

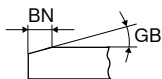

NEW	NEW	NEW
CTBH1000C	CTBH2000C	CTBH3000C
R	R	R
PCBN DNGA	PCBN DNGA	PCBN DNGA
71 017 ...	71 017 ...	71 017 ...
£ Y0/Y#	£ Y0/Y#	£ Y0/Y#
70.41 70202	70.41 80202	70.41 90202
70.41 70502	70.41 80502	70.41 90502
70.41 70802	70.41 80802	70.41 90802

ISO	RE mm	BN mm	GB	TCE (NOI)	LE mm
150604SN	0.4	0.14	20°	B (2)	3.6
150604SN	0.4	0.20	35°	B (2)	3.6
150608SN	0.8	0.14	20°	B (2)	3.3
150608SN	0.8	0.20	35°	B (2)	3.3
150612SN	1.2	0.14	20°	B (2)	3.0
150612SN	1.2	0.20	35°	B (2)	3.0

P
M
K
N
S
H
O

SNGA

Designation	L mm	S mm	D1 mm	IC mm
SNGA 1204..	12.7	4.76	5.16	12.7

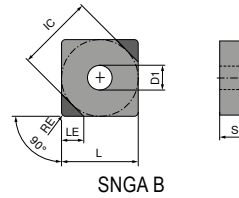

SNGA

▲ TCE(NOI) = Design and number of equipped cutting edge corners

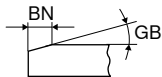

NEW	NEW	NEW
CTBH1000C	CTBH2000C	CTBH3000C
F	F	F
PCBN SNGA	PCBN SNGA	PCBN SNGA
71 039 ...	71 039 ...	71 039 ...
£ Y0/Y#	£ Y0/Y#	£ Y0/Y#
70.41 70002	70.41 80002	70.41 90002
		70.41 90002
70.41 70302	70.41 80302	70.41 90302

ISO	RE mm	BN mm	GB	TCE (NOI)	LE mm
120408EN	0.8			B (2)	3.8
120408SN	0.8	0.14	20°	B (2)	3.8
120412EN	1.2			B (2)	3.8
120412SN	1.2	0.14	20°	B (2)	3.8

P
M
K
N
S
H
O

SNGA

▲ TCE(NOI) = Design and number of equipped cutting edge corners

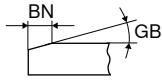

NEW	NEW	NEW
CTBH1000C	CTBH2000C	CTBH3000C
M PCBN SNGA	M PCBN SNGA	M PCBN SNGA
71 039 ...	71 039 ...	71 039 ...
£ Y0/Y#	£ Y0/Y#	£ Y0/Y#
70.41 70102	70.41 80102	70.41 90102
70.41 70402	70.41 80402	70.41 90402

ISO	RE mm	BN mm	GB	TCE (NOI)	LE mm
120408SN	0.8	0.09	15°	B (2)	3.8
120408SN	0.8	0.18	25°	B (2)	3.8
120412SN	1.2	0.09	15°	B (2)	3.8
120412SN	1.2	0.18	25°	B (2)	3.8

P
M
K
N
S
H
O

SNGA

▲ TCE(NOI) = Design and number of equipped cutting edge corners

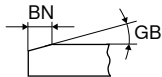

NEW	NEW	NEW
CTBH1000C	CTBH2000C	CTBH3000C
R PCBN SNGA	R PCBN SNGA	R PCBN SNGA
71 039 ...	71 039 ...	71 039 ...
£ Y0/Y#	£ Y0/Y#	£ Y0/Y#
70.41 70202	70.41 80202	70.41 90202
70.41 70502	70.41 80502	70.41 90502

ISO	RE mm	BN mm	GB	TCE (NOI)	LE mm
120408SN	0.8	0.14	20°	B (2)	3.8
120408SN	0.8	0.20	35°	B (2)	3.8
120412SN	1.2	0.14	20°	B (2)	3.8
120412SN	1.2	0.20	35°	B (2)	3.8

P
M
K
N
S
H
O

TNGA

Designation	L mm	S mm	D1 mm	IC mm
TNGA 1604..	16.5	4.76	3.81	9.52

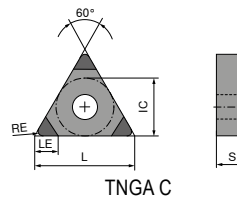

TNGA

▲ TCE(NOI) = Design and number of equipped cutting edge corners



NEW	NEW	NEW
CTBH1000C	CTBH2000C	CTBH3000C
F	F	F
PCBN TNGA	PCBN TNGA	PCBN TNGA
71 040 ...	71 040 ...	71 040 ...
£ Y0/Y#	£ Y0/Y#	£ Y0/Y#
97.81 70002	97.81 80002	97.81 90002
97.81 70302	97.81 80302	97.81 90302
97.81 70602	97.81 80602	97.81 90602

ISO	RE mm	BN mm	GB	TCE (NOI)	LE mm
160404EN	0.4			C (3)	3.6
160404SN	0.4	0.14	20°	C (3)	3.6
160408EN	0.8			C (3)	3.3
160408SN	0.8	0.14	20°	C (3)	3.3
160412EN	1.2			C (3)	3.0
160412SN	1.2	0.14	20°	C (3)	3.0

P
M
K
N
S
H
O

TNGA

▲ TCE(NOI) = Design and number of equipped cutting edge corners

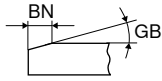

NEW	NEW	NEW
CTBH1000C	CTBH2000C	CTBH3000C
M	M	M
PCBN	PCBN	PCBN
TNGA	TNGA	TNGA
71 040 ...	71 040 ...	71 040 ...
£	£	£
Y0/Y#	Y0/Y#	Y0/Y#
97.81 70102	97.81 80102	97.81 90102
97.81 70402	97.81 80402	97.81 90402
97.81 70702	97.81 80702	97.81 90702

ISO	RE mm	BN mm	GB	TCE (NOI)	LE mm
160404SN	0.4	0.09	15°	C (3)	3.6
160404SN	0.4	0.18	25°	C (3)	3.6
160408SN	0.8	0.09	15°	C (3)	3.3
160408SN	0.8	0.18	25°	C (3)	3.3
160412SN	1.2	0.09	15°	C (3)	3.0
160412SN	1.2	0.18	25°	C (3)	3.0

P
M
K
N
S
H
O

TNGA

▲ TCE(NOI) = Design and number of equipped cutting edge corners

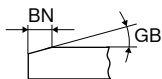

NEW	NEW	NEW
CTBH1000C	CTBH2000C	CTBH3000C
R	R	R
PCBN	PCBN	PCBN
TNGA	TNGA	TNGA
71 040 ...	71 040 ...	71 040 ...
£	£	£
Y0/Y#	Y0/Y#	Y0/Y#
97.81 70202	97.81 80202	97.81 90202
97.81 70502	97.81 80502	97.81 90502
97.81 70802	97.81 80802	97.81 90802

ISO	RE mm	BN mm	GB	TCE (NOI)	LE mm
160404SN	0.4	0.14	20°	C (3)	3.6
160404SN	0.4	0.20	35°	C (3)	3.6
160408SN	0.8	0.14	20°	C (3)	3.3
160408SN	0.8	0.20	35°	C (3)	3.3
160412SN	1.2	0.14	20°	C (3)	3.0
160412SN	1.2	0.20	35°	C (3)	3.0

P
M
K
N
S
H
O

VNGA

Designation	L mm	S mm	D1 mm	IC mm
VNGA 1604..	16.6	4.76	3.81	9.52

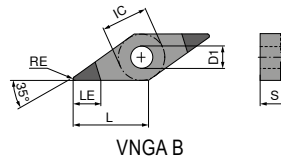

VNGA

▲ TCE(NOI) = Design and number of equipped cutting edge corners

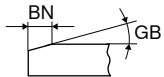

NEW	NEW	NEW
CTBH1000C	CTBH2000C	CTBH3000C
F	F	F
PCBN VNGA	PCBN VNGA	PCBN VNGA
71 042 ...	71 042 ...	71 042 ...
£ Y0/Y#	£ Y0/Y#	£ Y0/Y#
70.41 70002	70.41 80002	70.41 90002
70.41 70302	70.41 80302	70.41 90302

ISO	RE mm	BN mm	GB	TCE (NOI)	LE mm
160404EN	0.4			B (2)	5.1
160404SN	0.4	0.14	20°	B (2)	5.1
160408EN	0.8			B (2)	4.2
160408SN	0.8	0.14	20°	B (2)	4.2

P
M
K
N
S
H
O

VNGA

▲ TCE(NOI) = Design and number of equipped cutting edge corners

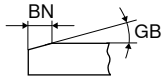

NEW	NEW	NEW
CTBH1000C	CTBH2000C	CTBH3000C
M PCBN VNGA	M PCBN VNGA	M PCBN VNGA
71 042 ...	71 042 ...	71 042 ...
£ Y0/Y#	£ Y0/Y#	£ Y0/Y#
70.41 70102	70.41 80102	70.41 90102
70.41 70402	70.41 80402	70.41 90402

ISO	RE mm	BN mm	GB	TCE (NOI)	LE mm
160404SN	0.4	0.09	15°	B (2)	5.1
160404SN	0.4	0.18	25°	B (2)	5.1
160408SN	0.8	0.09	15°	B (2)	4.2
160408SN	0.8	0.18	25°	B (2)	4.2

P
M
K
N
S
H
O

VNGA

▲ TCE(NOI) = Design and number of equipped cutting edge corners

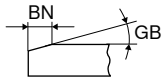

NEW	NEW	NEW
CTBH1000C	CTBH2000C	CTBH3000C
R PCBN VNGA	R PCBN VNGA	R PCBN VNGA
71 042 ...	71 042 ...	71 042 ...
£ Y0/Y#	£ Y0/Y#	£ Y0/Y#
70.41 70202	70.41 80202	70.41 90202
70.41 70502	70.41 80502	70.41 90502

ISO	RE mm	BN mm	GB	TCE (NOI)	LE mm
160404SN	0.4	0.14	20°	B (2)	5.1
160404SN	0.4	0.20	35°	B (2)	5.1
160408SN	0.8	0.14	20°	B (2)	4.2
160408SN	0.8	0.20	35°	B (2)	4.2

P
M
K
N
S
H
O

WNGA

Designation	L mm	S mm	D1 mm	IC mm
WNGA 0804..	8.5	4.76	5.13	12.7

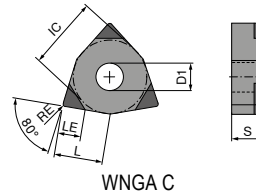

WNGA

▲ TCE(NOI) = Design and number of equipped cutting edge corners

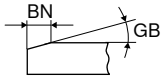

NEW	NEW	NEW
CTBH1000C	CTBH2000C	CTBH3000C
F	F	F
PCBN WNGA	PCBN WNGA	PCBN WNGA
71 044 ...	71 044 ...	71 044 ...
£ Y0/Y#	£ Y0/Y#	£ Y0/Y#
97.81 70002	97.81 80002	97.81 90002
97.81 70302	97.81 80302	97.81 90302

ISO	RE mm	BN mm	GB	TCE (NOI)	LE mm
080408EN	0.8			C (3)	3.3
080408SN	0.8	0.14	20°	C (3)	3.3
080412EN	1.2			C (3)	3.1
080412SN	1.2	0.14	20°	C (3)	3.1

P
M
K
N
S
H
O

WNGA

▲ TCE(NOI) = Design and number of equipped cutting edge corners

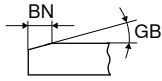

NEW	NEW	NEW
CTBH1000C	CTBH2000C	CTBH3000C
M	M	M
PCBN	PCBN	PCBN
WNGA	WNGA	WNGA
71 044 ...	71 044 ...	71 044 ...
£	£	£
Y0/Y#	Y0/Y#	Y0/Y#
97.81 70102	97.81 80102	97.81 90102
97.81 70402	97.81 80402	97.81 90402

ISO	RE mm	BN mm	GB	TCE (NOI)	LE mm
080408SN	0.8	0.09	15°	C (3)	3.3
080408SN	0.8	0.18	25°	C (3)	3.3
080412SN	1.2	0.09	15°	C (3)	3.1
080412SN	1.2	0.18	25°	C (3)	3.1

P
M
K
N
S
H
O

WNGA

▲ TCE(NOI) = Design and number of equipped cutting edge corners

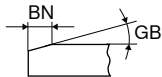

NEW	NEW	NEW
CTBH1000C	CTBH2000C	CTBH3000C
R	R	R
PCBN	PCBN	PCBN
WNGA	WNGA	WNGA
71 044 ...	71 044 ...	71 044 ...
£	£	£
Y0/Y#	Y0/Y#	Y0/Y#
97.81 70202	97.81 80202	97.81 90202
97.81 70502	97.81 80502	97.81 90502

ISO	RE mm	BN mm	GB	TCE (NOI)	LE mm
080408SN	0.8	0.14	20°	C (3)	3.3
080408SN	0.8	0.20	35°	C (3)	3.3
080412SN	1.2	0.14	20°	C (3)	3.1
080412SN	1.2	0.20	35°	C (3)	3.1

P
M
K
N
S
H
O

CCGW

Designation	L mm	S mm	D1 mm	IC mm
CCGW 0602..	6.45	2.38	2.8	6.35
CCGW 09T3..	9.70	3.97	4.4	9.52

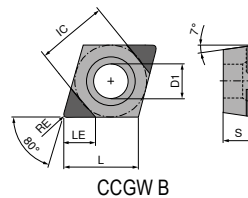

CCGW

▲ TCE(NOI) = Design and number of equipped cutting edge corners



NEW	NEW	NEW
CTBH1000C	CTBH2000C	CTBH3000C
F	F	F
PCBN CCGW	PCBN CCGW	PCBN CCGW

ISO	RE mm	BN mm	GB	TCE (NOI)	LE mm	71 000 ...		71 000 ...		71 000 ...	
						£ Y0/Y#		£ Y0/Y#		£ Y0/Y#	
060202EN	0.2			B (2)	2.9	70.41	70002	70.41	80002		
060202SN	0.2	0.14	20°	B (2)	2.9					70.41	90002
060204EN	0.4			B (2)	2.9	70.41	70302	70.41	80302		
060204SN	0.4	0.14	20°	B (2)	2.9					70.41	90302
09T302EN	0.2			B (2)	3.3	70.41	70602	70.41	80602		
09T302SN	0.2	0.14	20°	B (2)	3.3					70.41	90602
09T304EN	0.4			B (2)	3.3	70.41	70902	70.41	80902		
09T304SN	0.4	0.14	20°	B (2)	3.3					70.41	90902
09T308EN	0.8			B (2)	3.3	70.41	71202	70.41	81202		
09T308SN	0.8	0.14	20°	B (2)	3.3					70.41	91202

P
M
K
N
S
H
O

CCGW

▲ TCE(NOI) = Design and number of equipped cutting edge corners

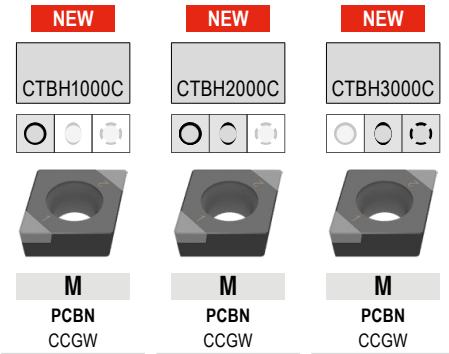
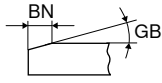

ISO	RE mm	BN mm	GB	TCE (NOI)	LE mm	71 000 ...	71 000 ...	71 000 ...
						£ Y0/Y#	£ Y0/Y#	£ Y0/Y#
060202SN	0.2	0.09	15°	B (2)	2.9	70.41 70102	70.41 80102	70.41 90102
060202SN	0.2	0.18	25°	B (2)	2.9			
060204SN	0.4	0.09	15°	B (2)	2.9	70.41 70402	70.41 80402	70.41 90402
060204SN	0.4	0.18	25°	B (2)	2.9			
09T302SN	0.2	0.09	15°	B (2)	3.3	70.41 70702	70.41 80702	70.41 90702
09T302SN	0.2	0.18	25°	B (2)	3.3			
09T304SN	0.4	0.09	15°	B (2)	3.3	70.41 71002	70.41 81002	70.41 91002
09T304SN	0.4	0.18	25°	B (2)	3.3			
09T308SN	0.8	0.09	15°	B (2)	3.3	70.41 71302	70.41 81302	70.41 91302
09T308SN	0.8	0.18	25°	B (2)	3.3			

P
M
K
N
S
H
O

CCGW

▲ TCE(NOI) = Design and number of equipped cutting edge corners

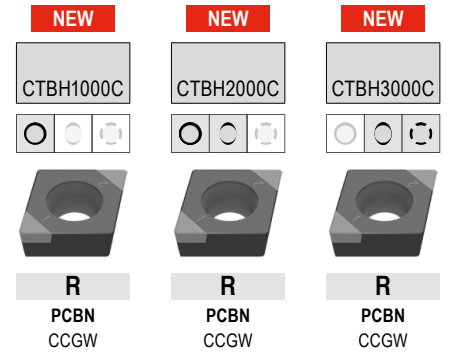
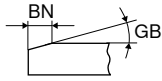

ISO	RE mm	BN mm	GB	TCE (NOI)	LE mm	71 000 ... £ Y0/Y#	71 000 ... £ Y0/Y#	71 000 ... £ Y0/Y#
060202SN	0.2	0.14	20°	B (2)	2.9	70.41 70202	70.41 80202	70.41 90202
060202SN	0.2	0.20	35°	B (2)	2.9			
060204SN	0.4	0.14	20°	B (2)	2.9	70.41 70502	70.41 80502	70.41 90502
060204SN	0.4	0.20	35°	B (2)	2.9			
09T302SN	0.2	0.14	20°	B (2)	3.3	70.41 70802	70.41 80802	70.41 90802
09T302SN	0.2	0.20	35°	B (2)	3.3			
09T304SN	0.4	0.14	20°	B (2)	3.3	70.41 71102	70.41 81102	70.41 91102
09T304SN	0.4	0.20	35°	B (2)	3.3			
09T308SN	0.8	0.14	20°	B (2)	3.3	70.41 71402	70.41 81402	70.41 91402
09T308SN	0.8	0.20	35°	B (2)	3.3			

P
M
K
N
S
H
O

DCGW

Designation	L mm	S mm	D1 mm	IC mm
DCGW 0702..	7.75	2.38	2.38	6.35
DCGW 11T3..	11.60	3.97	4.40	9.52

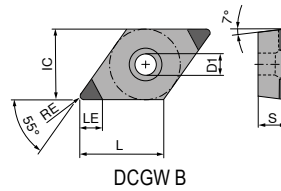

DCGW

▲ TCE(NOI) = Design and number of equipped cutting edge corners

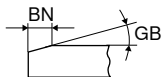

NEW		NEW		NEW	
CTBH1000C		CTBH2000C		CTBH3000C	
F		F		F	
PCBN DCGW		PCBN DCGW		PCBN DCGW	
71 007 ...		71 007 ...		71 007 ...	
£		£		£	
Y0/Y#		Y0/Y#		Y0/Y#	
70.41	70002	70.41	80002	70.41	90002
70.41	70302	70.41	80302	70.41	90302
70.41	71202	70.41	81202	70.41	91202
70.41	70602	70.41	80602	70.41	90602
70.41	70902	70.41	80902	70.41	90902
70.41	71302	70.41	81302	70.41	91302

ISO	RE mm	BN mm	GB	TCE (NOI)	LE mm
070202EN	0.2			B (2)	3.7
070202SN	0.2	0.14	20°	B (2)	3.7
070204EN	0.4			B (2)	3.6
070204SN	0.4	0.14	20°	B (2)	3.6
070208EN	0.8			B (2)	3.3
070208SN	0.8	0.14	20°	B (2)	3.3
11T302EN	0.2			B (2)	3.7
11T302SN	0.2	0.14	20°	B (2)	3.7
11T304EN	0.4			B (2)	3.6
11T304SN	0.4	0.14	20°	B (2)	3.6
11T308EN	0.8			B (2)	3.3
11T308SN	0.8	0.14	20°	B (2)	3.3

P
M
K
N
S
H
O

DCGW

▲ TCE(NOI) = Design and number of equipped cutting edge corners

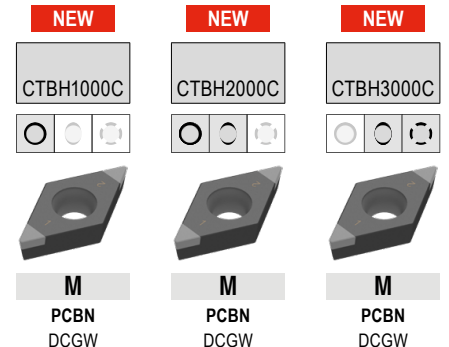
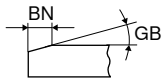

ISO	RE mm	BN mm	GB	TCE (NOI)	LE mm	71 007 ... £ Y0/Y#	71 007 ... £ Y0/Y#	71 007 ... £ Y0/Y#
070202SN	0.2	0.09	15°	B (2)	3.7	70.41 70102	70.41 80102	70.41 90102
070202SN	0.2	0.18	25°	B (2)	3.7			
070204SN	0.4	0.09	15°	B (2)	3.6	70.41 70402	70.41 80402	70.41 90402
070204SN	0.4	0.18	25°	B (2)	3.6			
070208SN	0.8	0.09	15°	B (2)	3.3	70.41 71402	70.41 81402	70.41 91402
070208SN	0.8	0.18	25°	B (2)	3.3			
11T302SN	0.2	0.09	15°	B (2)	3.7	70.41 70702	70.41 80702	70.41 90702
11T302SN	0.2	0.18	25°	B (2)	3.7			
11T304SN	0.4	0.09	15°	B (2)	3.6	70.41 71002	70.41 81002	70.41 91002
11T304SN	0.4	0.18	25°	B (2)	3.6			
11T308SN	0.8	0.09	15°	B (2)	3.3	70.41 71502	70.41 81502	70.41 91502
11T308SN	0.8	0.18	25°	B (2)	3.3			

P			
M			
K			
N			
S			
H		•	•
O			•

DCGW

▲ TCE(NOI) = Design and number of equipped cutting edge corners

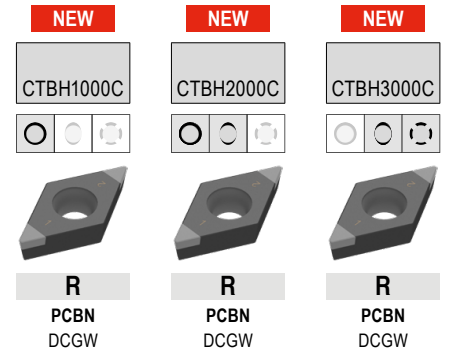
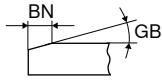

ISO	RE mm	BN mm	GB	TCE (NOI)	LE mm	71 007 ... £ Y0/Y#	71 007 ... £ Y0/Y#	71 007 ... £ Y0/Y#
070202SN	0.2	0.14	20°	B (2)	3.7	70.41 70202	70.41 80202	70.41 90202
070202SN	0.2	0.20	35°	B (2)	3.7			
070204SN	0.4	0.14	20°	B (2)	3.6	70.41 70502	70.41 80502	70.41 90502
070204SN	0.4	0.20	35°	B (2)	3.6			
070208SN	0.8	0.14	20°	B (2)	3.3	70.41 71602	70.41 81602	70.41 91602
070208SN	0.8	0.20	35°	B (2)	3.3			
11T302SN	0.2	0.14	20°	B (2)	3.7	70.41 70802	70.41 80802	70.41 90802
11T302SN	0.2	0.20	35°	B (2)	3.7			
11T304SN	0.4	0.14	20°	B (2)	3.6	70.41 71102	70.41 81102	70.41 91102
11T304SN	0.4	0.20	35°	B (2)	3.6			
11T308SN	0.8	0.14	20°	B (2)	3.3	70.41 71702	70.41 81702	70.41 91702
11T308SN	0.8	0.20	35°	B (2)	3.3			

P			
M			
K			
N			
S			
H		•	•
O			•

TCGW

Designation	L mm	S mm	D1 mm	IC mm
TCGW 1102..	11.0	2.38	2.8	6.35
TCGW 16T3..	16.5	3.97	4.4	9.52

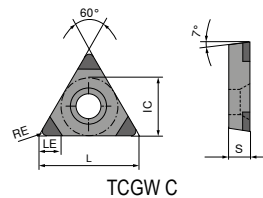

TCGW

▲ TCE(NOI) = Design and number of equipped cutting edge corners



NEW	NEW	NEW
CTBH1000C	CTBH2000C	CTBH3000C
F	F	F
PCBN TCGW	PCBN TCGW	PCBN TCGW
71 034 ...	71 034 ...	71 034 ...
£ Y0/Y#	£ Y0/Y#	£ Y0/Y#
97.81 70002	97.81 80002	97.81 90002
97.81 70302	97.81 80302	97.81 90302
97.81 70602	97.81 80602	97.81 90602
97.81 70902	97.81 80902	97.81 90902

ISO	RE mm	BN mm	GB	TCE (NOI)	LE mm
110204EN	0.4			C (3)	3.6
110204SN	0.4	0.14	20°	C (3)	3.6
110208EN	0.8			C (3)	3.3
110208SN	0.8	0.14	20°	C (3)	3.3
16T304EN	0.4			C (3)	3.6
16T304SN	0.4	0.14	20°	C (3)	3.6
16T308EN	0.8			C (3)	3.3
16T308SN	0.8	0.14	20°	C (3)	3.3

P
M
K
N
S
H
O

TCGW

▲ TCE(NOI) = Design and number of equipped cutting edge corners

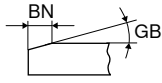

NEW	NEW	NEW
CTBH1000C	CTBH2000C	CTBH3000C
M	M	M
PCBN	PCBN	PCBN
TCGW	TCGW	TCGW
71 034 ...	71 034 ...	71 034 ...
£	£	£
Y0/Y#	Y0/Y#	Y0/Y#
97.81 70102	97.81 80102	97.81 90102
97.81 70402	97.81 80402	97.81 90402
97.81 70702	97.81 80702	97.81 90702
97.81 71002	97.81 81002	97.81 91002

ISO	RE mm	BN mm	GB	TCE (NOI)	LE mm
110204SN	0.4	0.09	15°	C (3)	3.6
110204SN	0.4	0.18	25°	C (3)	3.6
110208SN	0.8	0.09	15°	C (3)	3.3
110208SN	0.8	0.18	25°	C (3)	3.3
16T304SN	0.4	0.09	15°	C (3)	3.6
16T304SN	0.4	0.18	25°	C (3)	3.6
16T308SN	0.8	0.09	15°	C (3)	3.3
16T308SN	0.8	0.18	25°	C (3)	3.3

P
M
K
N
S
H
O

TCGW

▲ TCE(NOI) = Design and number of equipped cutting edge corners

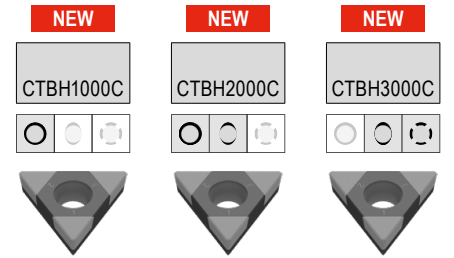
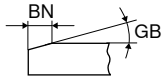

R
PCBN
TCGW

71 034 ...

£	Y0/Y#	70202	£	Y0/Y#	80202	£	Y0/Y#	90202
97.81			97.81			97.81		
97.81		70502	97.81		80502	97.81		90502
97.81		70802	97.81		80802	97.81		90802
97.81		71102	97.81		81102	97.81		91102

ISO	RE mm	BN mm	GB	TCE (NOI)	LE mm
110204SN	0.4	0.14	20°	C (3)	3.6
110204SN	0.4	0.20	35°	C (3)	3.6
110208SN	0.8	0.14	20°	C (3)	3.3
110208SN	0.8	0.20	35°	C (3)	3.3
16T304SN	0.4	0.14	20°	C (3)	3.6
16T304SN	0.4	0.20	35°	C (3)	3.6
16T308SN	0.8	0.14	20°	C (3)	3.3
16T308SN	0.8	0.20	35°	C (3)	3.3

P					
M					
K					
N					
S					
H					
O					

VCGW

Designation	L mm	S mm	D1 mm	IC mm
VCGW 1103..	11.1	3.18	2.9	6.35
VCGW 1604..	16.6	4.76	4.4	9.52

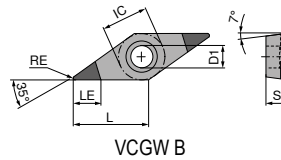

VCGW

▲ TCE(NOI) = Design and number of equipped cutting edge corners

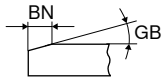

NEW	NEW	NEW
CTBH1000C	CTBH2000C	CTBH3000C
F	F	F
PCBN VCGW	PCBN VCGW	PCBN VCGW

ISO	RE mm	BN mm	GB	TCE (NOI)	LE mm	71 041 ...		71 041 ...		71 041 ...	
						£ Y0/Y#		£ Y0/Y#		£ Y0/Y#	
110302EN	0.2			B (2)	5.5	70.41	70002	70.41	80002		
110302SN	0.2	0.14	20°	B (2)	5.5					70.41	90002
110304EN	0.4			B (2)	5.1	70.41	70302	70.41	80302		
110304SN	0.4	0.14	20°	B (2)	5.1					70.41	90302
160402EN	0.2			B (2)	5.5	70.41	70602	70.41	80602		
160402SN	0.2	0.14	20°	B (2)	5.5					70.41	90602
160404EN	0.4			B (2)	5.1	70.41	70902	70.41	80902		
160404SN	0.4	0.14	20°	B (2)	5.1					70.41	90902
160408EN	0.8			B (2)	4.2	70.41	71202	70.41	81202		
160408SN	0.8	0.14	20°	B (2)	4.2					70.41	91202

P
M
K
N
S
H
O

VCGW

▲ TCE(NOI) = Design and number of equipped cutting edge corners

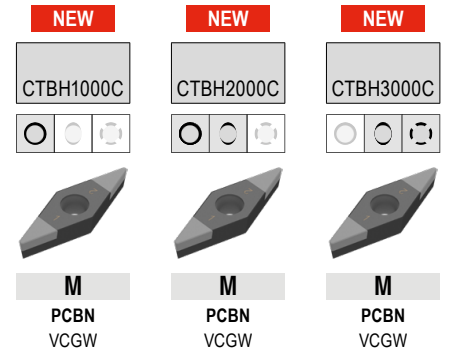
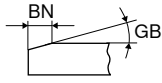

ISO	RE mm	BN mm	GB	TCE (NOI)	LE mm	71 041 ... £ Y0/Y#	71 041 ... £ Y0/Y#	71 041 ... £ Y0/Y#
110302SN	0.2	0.09	15°	B (2)	5.5	70.41 70102	70.41 80102	70.41 90102
110302SN	0.2	0.18	25°	B (2)	5.5			70.41 90102
110304SN	0.4	0.09	15°	B (2)	5.1	70.41 70402	70.41 80402	70.41 90402
110304SN	0.4	0.18	25°	B (2)	5.1			70.41 90402
160402SN	0.2	0.09	15°	B (2)	5.5	70.41 70702	70.41 80702	70.41 90702
160402SN	0.2	0.18	25°	B (2)	5.5			70.41 90702
160404SN	0.4	0.09	15°	B (2)	5.1	70.41 71002	70.41 81002	70.41 91002
160404SN	0.4	0.18	25°	B (2)	5.1			70.41 91002
160408SN	0.8	0.09	15°	B (2)	4.2	70.41 71302	70.41 81302	70.41 91302
160408SN	0.8	0.18	25°	B (2)	4.2			70.41 91302

P				
M				
K				
N				
S				
H				
O				

VCGW

▲ TCE(NOI) = Design and number of equipped cutting edge corners

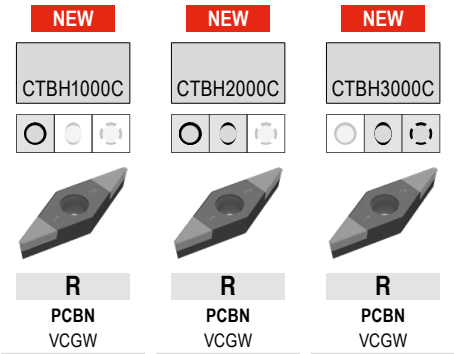
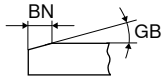



ISO	RE mm	BN mm	GB	TCE (NOI)	LE mm	71 041 ... £ Y0/Y#	71 041 ... £ Y0/Y#	71 041 ... £ Y0/Y#
110302SN	0.2	0.14	20°	B (2)	5.5	70.41 70202	70.41 80202	70.41 90202
110302SN	0.2	0.20	35°	B (2)	5.5			70.41 90202
110304SN	0.4	0.14	20°	B (2)	5.1	70.41 70502	70.41 80502	70.41 90502
110304SN	0.4	0.20	35°	B (2)	5.1			70.41 90502
160402SN	0.2	0.14	20°	B (2)	5.5	70.41 70802	70.41 80802	70.41 90802
160402SN	0.2	0.20	35°	B (2)	5.5			70.41 90802
160404SN	0.4	0.14	20°	B (2)	5.1	70.41 71102	70.41 81102	70.41 91102
160404SN	0.4	0.20	35°	B (2)	5.1			70.41 91102
160408SN	0.8	0.14	20°	B (2)	4.2	70.41 71402	70.41 81402	70.41 91402
160408SN	0.8	0.20	35°	B (2)	4.2			70.41 91402

P			
M			
K			
N			
S			
H			
O			

Cutting data standard values for negative PCBN inserts

Index	Cutting edges code negative insert*				Main Application	Extended application	CTBH 1000C			
	Material	Strength	Ra (theo.)	Cutting condition			EN-F			
							1,6–6,4			
							v_c	f	a_p	
H.1.1	Hardened steel	46–55 HRC	x	Smooth	●		200	0,06–0,15	0,05–0,5	
				x	Interrupted		○			
				x	Extremely interrupted					
H.1.2			56–60 HRC	x	Smooth	●		220	0,06–0,15	0,05–0,5
				x	Interrupted		○			
				x	Extremely interrupted					
H.1.3			61–65 HRC	x	Smooth	●		220	0,06–0,15	0,05–0,5
				x	Interrupted		○			
				x	Extremely interrupted					
H.1.4			66–70 HRC	x	Smooth	●		240	0,06–0,15	0,05–0,5
				x	Interrupted		○			
				x	Extremely interrupted					
H.2.1	Chilled iron	400 HB	x	Smooth						
			x	Interrupted						
			x	Extremely interrupted						
H.3.1	Hardened cast iron	55 HRC	x	Smooth						
			x	Interrupted						
			x	Extremely interrupted						

Index	Cutting edges code negative insert*				Main Application	Extended application	CTBH 2000C			
	Material	Strength	Ra (theo.)	Cutting condition			EN-F			
							1,6–6,4			
							v_c	f	a_p	
H.1.1	Hardened steel	46–55 HRC	x	Smooth	●		160	0,06–0,15	0,1–0,5	
				x	Interrupted	●		160	0,06–0,15	0,1–0,5
				x	Extremely interrupted		○			
H.1.2			56–60 HRC	x	Smooth	●		180	0,06–0,15	0,1–0,5
				x	Interrupted	●		180	0,06–0,15	0,1–0,5
				x	Extremely interrupted		○			
H.1.3			61–65 HRC	x	Smooth	●		180	0,06–0,15	0,1–0,5
				x	Interrupted	●		180	0,06–0,15	0,1–0,5
				x	Extremely interrupted		○			
H.1.4			66–70 HRC	x	Smooth	●		200	0,06–0,15	0,1–0,5
				x	Interrupted	●		200	0,06–0,15	0,1–0,5
				x	Extremely interrupted		○			
H.2.1	Chilled iron	400 HB	x	Smooth						
			x	Interrupted						
			x	Extremely interrupted						
H.3.1	Hardened cast iron	55 HRC	x	Smooth						
			x	Interrupted						
			x	Extremely interrupted						

Index	Cutting edges code negative insert*				Main Application	Extended application	CTBH 3000C			
	Material	Strength	Ra (theo.)	Cutting condition			SN-014D-F			
							1,0–3,2			
							v_c	f	a_p	
H.1.1	Hardened steel	46–55 HRC	x	Smooth		○	180	0,06–0,15	0,1–0,5	
				x	Interrupted	●		180	0,06–0,15	0,1–0,5
				x	Extremely interrupted	●		180	0,06–0,15	0,1–0,5
H.1.2			56–60 HRC	x	Smooth		○	200	0,06–0,15	0,1–0,5
				x	Interrupted	●		200	0,06–0,15	0,1–0,5
				x	Extremely interrupted	●		200	0,06–0,15	0,1–0,5
H.1.3			61–65 HRC	x	Smooth		○	200	0,06–0,15	0,1–0,5
				x	Interrupted	●		200	0,06–0,15	0,1–0,5
				x	Extremely interrupted	●		200	0,06–0,15	0,1–0,5
H.1.4			66–70 HRC	x	Smooth		○	220	0,06–0,15	0,1–0,5
				x	Interrupted	●		220	0,06–0,15	0,1–0,5
				x	Extremely interrupted	●		220	0,06–0,15	0,1–0,5
H.2.1	Chilled iron	400 HB	x	Smooth		○	200	0,08–0,15	0,1–0,4	
			x	Interrupted		○	180	0,05–0,12	0,1–0,4	
			x	Extremely interrupted		○	160	0,05–0,12	0,1–0,4	
H.3.1	Hardened cast iron	55 HRC	x	Smooth		○	200	0,08–0,15	0,1–0,4	
			x	Interrupted		○	180	0,05–0,12	0,1–0,4	
			x	Extremely interrupted		○	160	0,05–0,12	0,1–0,4	

 With our PCBN indexable inserts, we recommend dry machining – information about this can be found on page 50

 * Note chamfer width: The wider the chamfer, the more stable the cutting edge.

 The cutting data is strongly influenced by external conditions, such as the stability of the tool and workpiece clamping, material and type of machine. The specified values represent guideline cutting data that can be adjusted by approx. ±20% according to the usage conditions.

CTBH 1000C					
SN-009C-M			SN-014D-R		
1,0-3,2			0,5-1,6		
v_c	f	a_p	v_c	f	a_p
200	0,06-0,15	0,1-0,5	180	0,06-0,25	0,12-0,5
200	0,06-0,15	0,1-0,5	180	0,06-0,25	0,12-0,5
220	0,06-0,15	0,1-0,5	200	0,06-0,25	0,12-0,5
220	0,06-0,15	0,1-0,5	200	0,06-0,25	0,12-0,5
220	0,06-0,15	0,1-0,5	200	0,06-0,25	0,12-0,5
220	0,06-0,15	0,1-0,5	200	0,06-0,25	0,12-0,5
240	0,06-0,15	0,1-0,5	220	0,06-0,25	0,12-0,5
240	0,06-0,15	0,1-0,5	220	0,06-0,25	0,12-0,5

CTBH 2000C					
SN-009C-M			SN-014D-R		
1,0-4,5			0,8-3,0		
v_c	f	a_p	v_c	f	a_p
160	0,06-0,15	0,1-0,5	140	0,06-0,25	0,12-0,5
160	0,06-0,15	0,1-0,5	140	0,06-0,25	0,12-0,5
160	0,06-0,15	0,1-0,5	140	0,06-0,25	0,12-0,5
180	0,06-0,15	0,1-0,5	160	0,06-0,25	0,12-0,5
180	0,06-0,15	0,1-0,5	160	0,06-0,25	0,12-0,5
180	0,06-0,15	0,1-0,5	160	0,06-0,25	0,12-0,5
180	0,06-0,15	0,1-0,5	160	0,06-0,25	0,12-0,5
180	0,06-0,15	0,1-0,5	160	0,06-0,25	0,12-0,5
180	0,06-0,15	0,1-0,5	160	0,06-0,25	0,12-0,5
180	0,06-0,15	0,1-0,5	160	0,06-0,25	0,12-0,5
200	0,06-0,15	0,1-0,5	180	0,06-0,25	0,12-0,5
200	0,06-0,15	0,1-0,5	180	0,06-0,25	0,12-0,5
200	0,06-0,15	0,1-0,5	180	0,06-0,25	0,12-0,5

CTBH 3000C					
SN-018E-M			SN-020G-R		
1,6-3,2			0,8-3,0		
v_c	f	a_p	v_c	f	a_p
150	0,06-0,25	0,1-0,5	150	0,08-0,4	0,15-0,5
150	0,06-0,25	0,1-0,5	150	0,08-0,4	0,15-0,5
150	0,06-0,25	0,1-0,5	150	0,08-0,4	0,15-0,5
170	0,06-0,25	0,1-0,5	170	0,08-0,4	0,15-0,5
170	0,06-0,25	0,1-0,5	170	0,08-0,4	0,15-0,5
170	0,06-0,25	0,1-0,5	170	0,08-0,4	0,15-0,5
170	0,06-0,25	0,1-0,5	170	0,08-0,4	0,15-0,5
170	0,06-0,25	0,1-0,5	170	0,08-0,4	0,15-0,5
170	0,06-0,25	0,1-0,5	170	0,08-0,4	0,15-0,5
170	0,06-0,25	0,1-0,5	170	0,08-0,4	0,15-0,5
190	0,06-0,25	0,1-0,5	190	0,08-0,4	0,15-0,5
190	0,06-0,25	0,1-0,5	190	0,08-0,4	0,15-0,5
190	0,06-0,25	0,1-0,5	190	0,08-0,4	0,15-0,5
180	0,08-0,2	0,1-0,5	180	0,08-0,2	0,15-0,5
160	0,08-0,15	0,1-0,5	160	0,08-0,15	0,15-0,5
140	0,08-0,15	0,1-0,5	140	0,08-0,15	0,15-0,5
180	0,08-0,2	0,1-0,5	180	0,08-0,2	0,15-0,5
160	0,08-0,15	0,1-0,5	160	0,08-0,15	0,15-0,5
140	0,08-0,15	0,1-0,5	140	0,08-0,15	0,15-0,5

CNGA 120408 SN-009C B3-M CTBH1000C

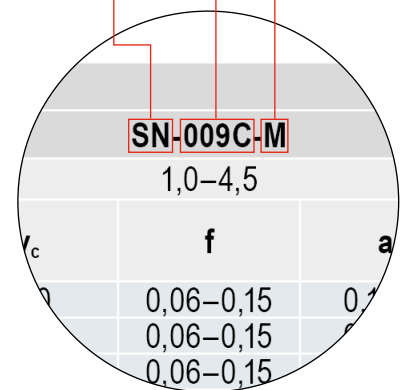



Cutting data standard values for positive PCBN inserts

Index	Cutting edges code positive insert*				Main Application	Extended application	CTBH 1000C			
	Material	Strength	Ra (theo.)	Cutting condition			EN-F			
							1,6–6,4			
							v_c	f	a_p	
H.1.1	Hardened steel	46–55 HRC	x	Smooth	●	○	230	0,06–0,15	0,1–0,5	
				x	Interrupted					
				x	Extremely interrupted					
H.1.2			56–60 HRC	x	Smooth	●	○	250	0,06–0,15	0,1–0,5
				x	Interrupted					
				x	Extremely interrupted					
H.1.3			61–65 HRC	x	Smooth	●	○	250	0,06–0,15	0,1–0,5
				x	Interrupted					
				x	Extremely interrupted					
H.1.4			66–70 HRC	x	Smooth	●	○	270	0,06–0,15	0,1–0,5
				x	Interrupted					
				x	Extremely interrupted					
H.2.1	Chilled iron	400 HB	x	Smooth						
			x	Interrupted						
			x	Extremely interrupted						
H.3.1	Hardened cast iron	55 HRC	x	Smooth						
			x	Interrupted						
			x	Extremely interrupted						

Index	Cutting edges code positive insert*				Main Application	Extended application	CTBH 2000C			
	Material	Strength	Ra (theo.)	Cutting condition			EN-F			
							1,6–6,4			
							v_c	f	a_p	
H.1.1	Hardened steel	46–55 HRC	x	Smooth	●		180	0,06–0,15	0,1–0,5	
				x	Interrupted	●		180	0,06–0,15	0,1–0,5
				x	Extremely interrupted		○			
H.1.2			56–60 HRC	x	Smooth	●		210	0,06–0,15	0,1–0,5
				x	Interrupted	●		210	0,06–0,15	0,1–0,5
				x	Extremely interrupted		○			
H.1.3			61–65 HRC	x	Smooth	●		210	0,06–0,15	0,1–0,5
				x	Interrupted	●		210	0,06–0,15	0,1–0,5
				x	Extremely interrupted		○			
H.1.4			66–70 HRC	x	Smooth	●		230	0,06–0,15	0,1–0,5
				x	Interrupted	●		230	0,06–0,15	0,1–0,5
				x	Extremely interrupted		○			
H.2.1	Chilled iron	400 HB	x	Smooth						
			x	Interrupted						
			x	Extremely interrupted						
H.3.1	Hardened cast iron	55 HRC	x	Smooth						
			x	Interrupted						
			x	Extremely interrupted						

Index	Cutting edges code positive insert*				Main Application	Extended application	CTBH 3000C			
	Material	Strength	Ra (theo.)	Cutting condition			SN-014D-F			
							1,0–3,2			
							v_c	f	a_p	
H.1.1	Hardened steel	46–55 HRC	x	Smooth		○	210	0,06–0,15	0,1–0,5	
				x	Interrupted	●		180	0,06–0,15	0,1–0,5
				x	Extremely interrupted	●		180	0,06–0,15	0,1–0,5
H.1.2			56–60 HRC	x	Smooth		○	230	0,06–0,15	0,1–0,5
				x	Interrupted	●		200	0,06–0,15	0,1–0,5
				x	Extremely interrupted	●		200	0,06–0,15	0,1–0,5
H.1.3			61–65 HRC	x	Smooth		○	200	0,06–0,15	0,1–0,5
				x	Interrupted	●		200	0,06–0,15	0,1–0,5
				x	Extremely interrupted	●		200	0,06–0,15	0,1–0,5
H.1.4			66–70 HRC	x	Smooth		○	250	0,06–0,15	0,1–0,5
				x	Interrupted	●		220	0,06–0,15	0,1–0,5
				x	Extremely interrupted	●		220	0,06–0,15	0,1–0,5
H.2.1	Chilled iron	400 HB	x	Smooth		○	230	0,08–0,15	0,1–0,4	
			x	Interrupted		○	210	0,05–0,12	0,1–0,4	
			x	Extremely interrupted		○	180	0,05–0,12	0,1–0,4	
H.3.1	Hardened cast iron	55 HRC	x	Smooth		○	230	0,08–0,15	0,1–0,4	
			x	Interrupted		○	210	0,05–0,12	0,1–0,4	
			x	Extremely interrupted		○	180	0,05–0,12	0,1–0,4	

 With our PCBN indexable inserts, we recommend dry machining – information about this can be found on page 50

 * Note chamfer width: The wider the chamfer, the more stable the cutting edge.

 The cutting data is strongly influenced by external conditions, such as the stability of the tool and workpiece clamping, material and type of machine. The specified values represent guideline cutting data that can be adjusted by approx. ±20% according to the usage conditions.

CTBH 1000C					
SN-009C-M			SN-014D-R		
1,0-3,2			0,5-1,6		
v_c	f	a_p	v_c	f	a_p
230	0,06-0,15	0,1-0,5	210	0,06-0,25	0,12-0,5
230	0,06-0,15	0,1-0,5	210	0,06-0,25	0,12-0,5
250	0,06-0,15	0,1-0,5	230	0,06-0,25	0,12-0,5
250	0,06-0,15	0,1-0,5	230	0,06-0,25	0,12-0,5
250	0,06-0,15	0,1-0,5	230	0,06-0,25	0,12-0,5
250	0,06-0,15	0,1-0,5	230	0,06-0,25	0,12-0,5
270	0,06-0,15	0,1-0,5	250	0,06-0,25	0,12-0,5
270	0,06-0,15	0,1-0,5	250	0,06-0,25	0,12-0,5

CTBH 2000C					
SN-009C-M			SN-014D-R		
1,0-4,5			0,8-3,0		
v_c	f	a_p	v_c	f	a_p
180	0,06-0,15	0,1-0,5	160	0,06-0,25	0,12-0,5
180	0,06-0,15	0,1-0,5	160	0,06-0,25	0,12-0,5
180	0,06-0,15	0,1-0,5	160	0,06-0,25	0,12-0,5
180	0,06-0,15	0,1-0,5	180	0,06-0,25	0,12-0,5
180	0,06-0,15	0,1-0,5	180	0,06-0,25	0,12-0,5
180	0,06-0,15	0,1-0,5	180	0,06-0,25	0,12-0,5
180	0,06-0,15	0,1-0,5	180	0,06-0,25	0,12-0,5
180	0,06-0,15	0,1-0,5	180	0,06-0,25	0,12-0,5
180	0,06-0,15	0,1-0,5	180	0,06-0,25	0,12-0,5
200	0,06-0,15	0,1-0,5	210	0,06-0,25	0,12-0,5
200	0,06-0,15	0,1-0,5	210	0,06-0,25	0,12-0,5
200	0,06-0,15	0,1-0,5	210	0,06-0,25	0,12-0,5

CTBH 3000C					
SN-018E-M			SN-020G-R		
1,6-3,2			0,8-3,0		
v_c	f	a_p	v_c	f	a_p
170	0,06-0,25	0,1-0,5	170	0,08-0,4	0,15-0,5
170	0,06-0,25	0,1-0,5	170	0,08-0,4	0,15-0,5
170	0,06-0,25	0,1-0,5	170	0,08-0,4	0,15-0,5
195	0,06-0,25	0,1-0,5	195	0,08-0,4	0,15-0,5
195	0,06-0,25	0,1-0,5	195	0,08-0,4	0,15-0,5
195	0,06-0,25	0,1-0,5	195	0,08-0,4	0,15-0,5
195	0,06-0,25	0,1-0,5	195	0,08-0,4	0,15-0,5
195	0,06-0,25	0,1-0,5	195	0,08-0,4	0,15-0,5
195	0,06-0,25	0,1-0,5	195	0,08-0,4	0,15-0,5
220	0,06-0,25	0,1-0,5	220	0,08-0,4	0,15-0,5
220	0,06-0,25	0,1-0,5	220	0,08-0,4	0,15-0,5
220	0,06-0,25	0,1-0,5	220	0,08-0,4	0,15-0,5
210	0,08-0,2	0,1-0,5	210	0,08-0,2	0,15-0,5
180	0,08-0,15	0,1-0,5	180	0,08-0,15	0,15-0,5
160	0,08-0,15	0,1-0,5	160	0,08-0,15	0,15-0,5
210	0,08-0,2	0,1-0,5	210	0,08-0,2	0,15-0,5
180	0,08-0,15	0,1-0,5	180	0,08-0,15	0,15-0,5
160	0,08-0,15	0,1-0,5	160	0,08-0,15	0,15-0,5

DCGW 11T304 SN-009C B4-M CTBH2000C

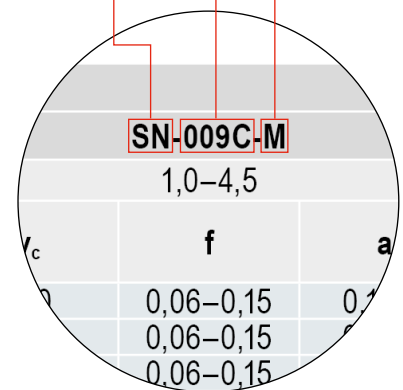

Wet or dry machining

The heat produced during hard turning is distributed as 80% to the chip, 10% to the component and 10% to the indexable insert. This underlines the importance of the correct chip removal from the cutting zone. There is therefore generally no need to use cooling lubricant. Machining without cooling lubricant supply is the ideal situation. PCBN indexable inserts withstand high temperatures, thus reducing the costs and problems associated with cooling lubricant. For some applications, cooling lubricant is however necessary to keep the temperature of the component constant. During the whole turning application, a continuous supply of cooling lubricant should be ensured. A temperature shock on the cutting edge must be avoided.

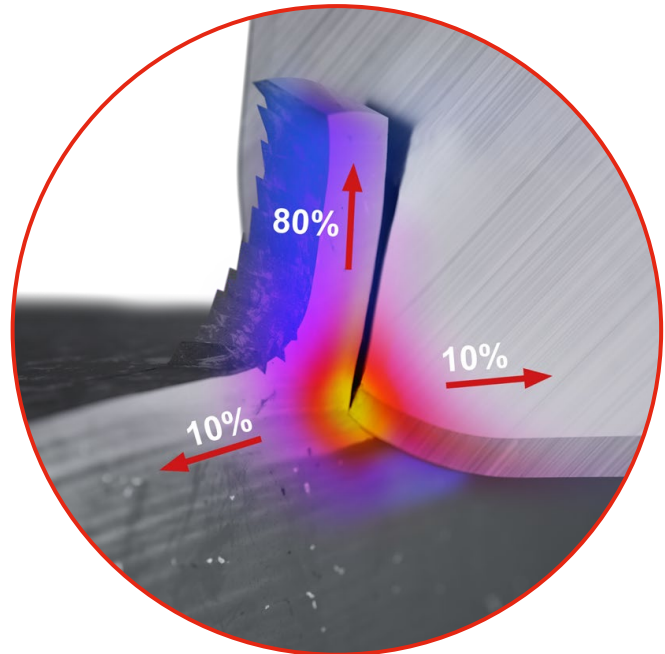

Advantages of hard turning over grinding

In the past, grinding was a common method used to finish components made of hardened steel. Today, hard turning is considered an efficient and cost-effective alternative. Hard turning can increase productivity massively and offers significant environmental benefits.

- ▲ High surface quality is possible (up to R_a 0.2 μm)
- ▲ Lower machine investment costs
- ▲ Shorter production time per workpiece
- ▲ Process flexibility (internal and external machining on one machine is possible)
- ▲ Complex geometries are easier to produce
- ▲ Shorter setup times
- ▲ Low tool costs (no formed grinding wheels)
- ▲ No cooling lubricant required
- ▲ Chips are more cost-efficient and easier to recycle
- ▲ No grinding sludge

Cutting data effect on wear

Cutting data and wear

Sufficient heat in the cutting zone leads to reduced cutting forces. If the cutting speed is too low, it generates too little energy and therefore less heat, which can subsequently cause a cutting edge breakage.

Crater wear affects the stability of the indexable insert, but only has a secondary effect on the surface quality of the workpiece. In contrast, flank wear affects the tolerance and geometrical accuracy.

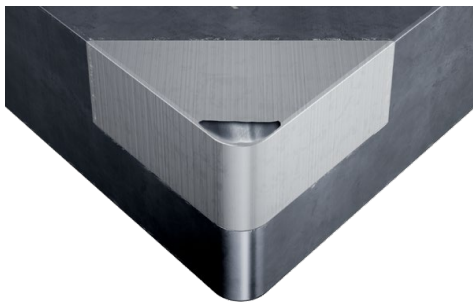

Crater wear

Crater wear is the most dominant type of wear when machining case-hardened steel.

It is caused by the chemical wear resulting from extremely high temperatures and forces, which are generated at the cutting edge contact point.

Crater wear weakens the cutting edge.

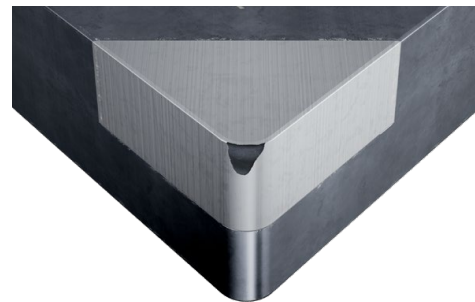

Flank wear

With abrasive steels such as bearing steel or tool steel, there is mainly flank wear.

This has a negative effect on the surface and dimensional accuracy.

Tool life related wear

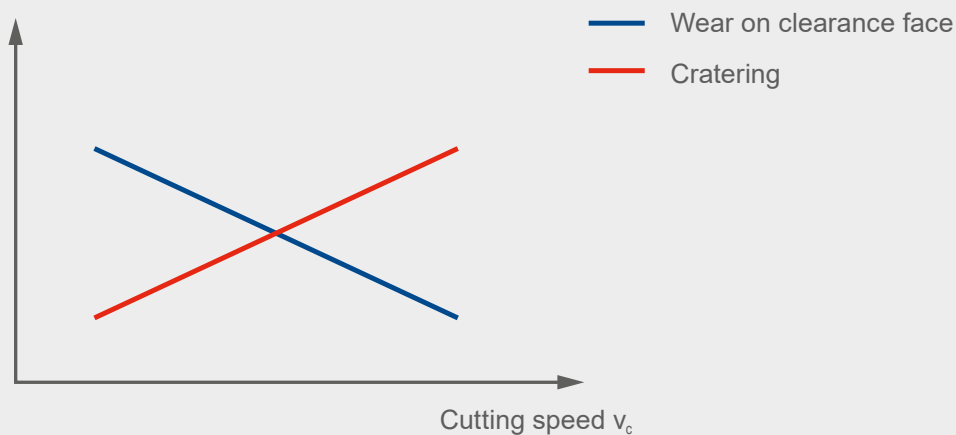

The matter of wear is extremely complex, but there are nevertheless ways to control it and ensure a stable and reliable production process. More information on this can be found on the next pages.

Benefits of the coating

The PVD layer system improves the oxidation resistance and protects against adhesion. The compressive stresses introduced by the coating process stabilise the system cutting material – cutting edge – coating. This leads to a better connection to the base material and a significantly greater process security.

By increasing the tool life and increasing the feeds, the machining times and the costs per workpiece are reduced significantly. The use of existing resources is hereby reduced and the competitiveness is increased considerably.

- ▲ The PVD coating protects the PCBN against the chemical interaction with oxygen during machining. Oxidation and diffusion wear are significantly reduced.
- ▲ At machining temperature, harder and more resistant to reactions than binder phase (TiN, TiCN)
- ▲ Offers additional wear protection especially for PCBN grades with a low CBN content.

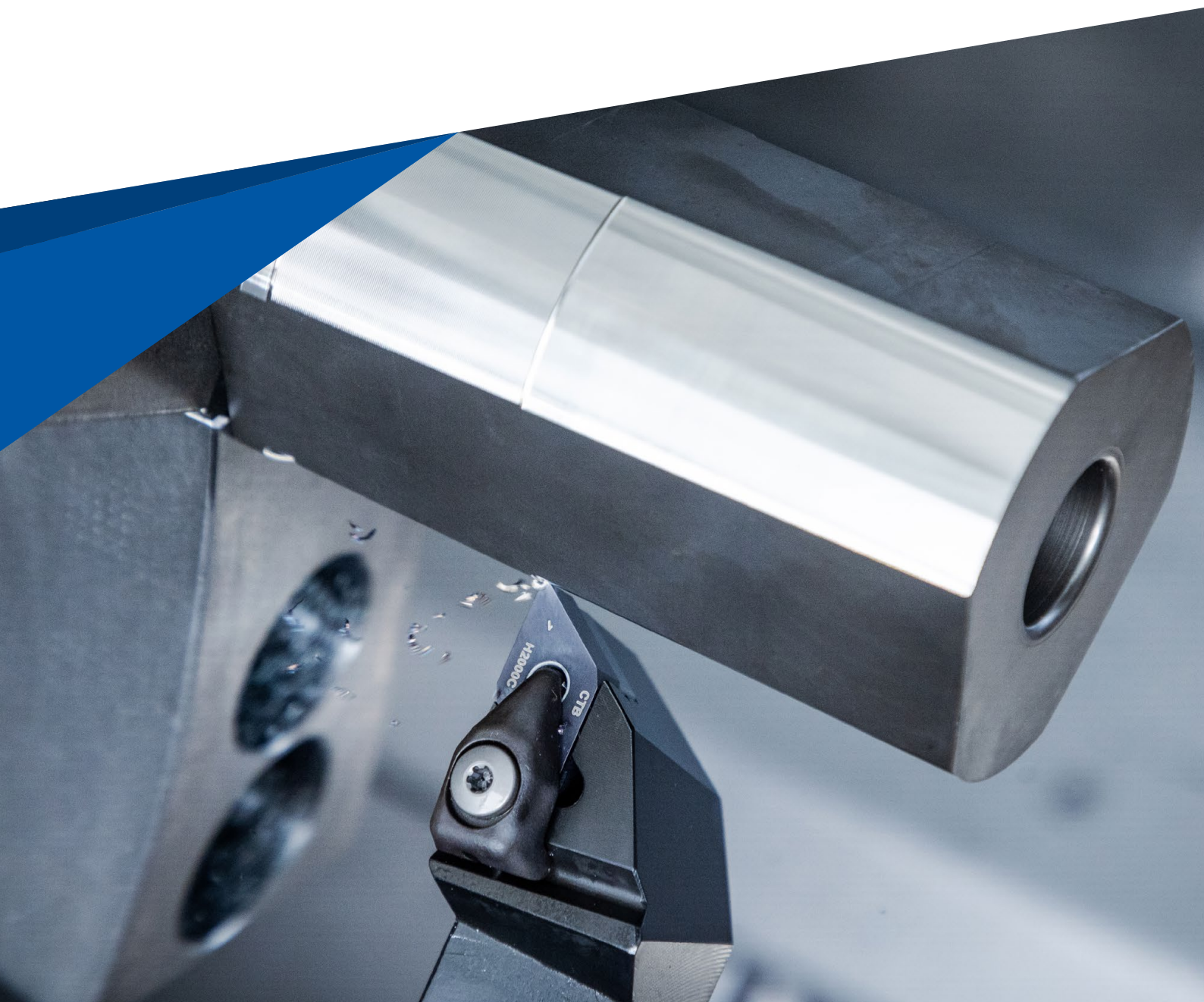

Criteria for an indexable insert change

A key criterion for the indexable insert change during hard turning is the surface quality. The definition of the surface quality of the design on the drawing provides a measurable parameter. When the specified value is reached, this leads to an indexable insert change.

The specified number of workpieces should be below 10-20% of the average tool life of an optimised production process. The exact number of workpieces must be defined for every process.

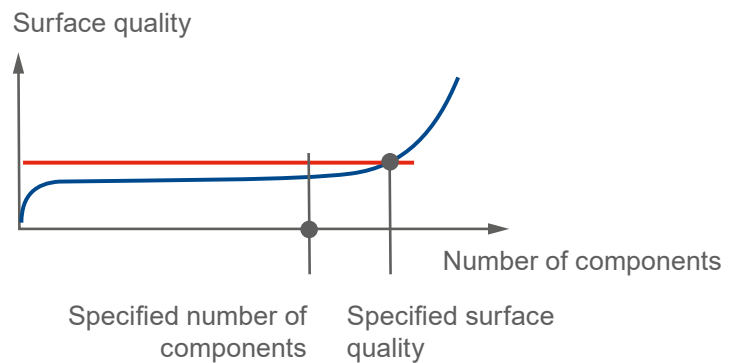

Calculating the surface quality

The theoretical surface profile ($R_z / R_t / R_a$) can be calculated based on the radius and feed. The desired surface quality can hereby be calculated in advance as long as all relevant environmental conditions are OK. For example, poorer values are obtained with unstable machines, unstable workpieces, poor clamping, defective and incorrect tool systems.

When hard turning with PCBN, the calculated theoretical profile height is essentially undercut. A special machining mechanism (self-induced hot machining) with a high cutting pressure is created. Through this, the theoretical profile is smoothed and the surface quality is improved.

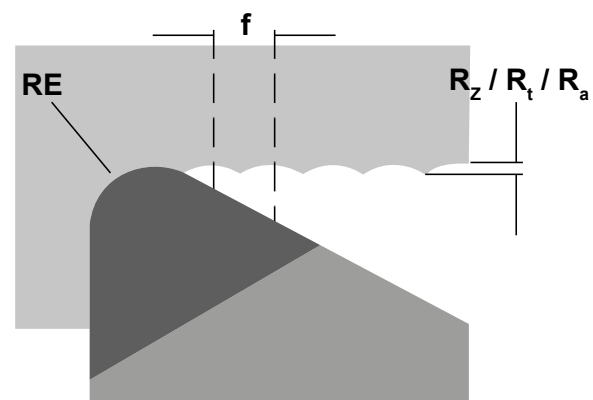

$$R_{th} = \frac{f^2}{8 \cdot r_\epsilon} \quad r_\epsilon = \frac{f^2}{8 \cdot R_{th}}$$

$$f = \sqrt{8 \cdot r_\epsilon \cdot R_{th}} \quad R_{th} \approx R_z$$

$$r_\epsilon = RE$$

Feed rate guide values for surface finish quality

Roughness range R_z in μm	R_{th}	Corresponds to R_a	Roughness index	ISO 1302	Corner radius RE in mm and feed f in mm/rev						
					RE = 0,1	RE = 0,2	RE = 0,4	RE = 0,8	RE = 1,2	RE = 1,6	RE = 2,4
63–100	$\sqrt{R_{th} 63}$	12,5–25	N11	$\frac{25}{\nabla}$	0,22*	0,32*	0,45*	0,63	0,78	0,9	1,1
40–63	$\sqrt{R_{th} 40}$	6,3–12,5	N10	$\frac{12,5}{\nabla}$	0,18*	0,25*	0,36	0,51	0,62	0,72	0,88
31,5–40	$\sqrt{R_{th} 31,5}$	4,9–6,3	N9	$\frac{6,3}{\nabla}$	0,16*	0,22*	0,32	0,45	0,55	0,63	0,78
25–31,5	$\sqrt{R_{th} 25}$	4,0–4,9			0,14*	0,2*	0,28	0,4	0,49	0,57	0,69
16–25	$\sqrt{R_{th} 16}$	2,5–4,0	N8	$\frac{3,2}{\nabla}$	0,11*	0,16	0,23	0,32	0,39	0,45	0,55
10–16	$\sqrt{R_{th} 10}$	1,6–2,5			0,09	0,13	0,18	0,25	0,31	0,36	0,44
6,3–10	$\sqrt{R_{th} 6,3}$	1,0–1,6	N7	$\frac{1,6}{\nabla}$	0,07	0,1	0,14	0,2	0,25	0,28	0,35
4–6,3	$\sqrt{R_{th} 4}$	0,8–1,0	N6	$\frac{0,8}{\nabla}$	0,06	0,08	0,11	0,16	0,2	0,23	0,28
2,5–4	$\sqrt{R_{th} 2,5}$	0,4–0,8	N5	$\frac{0,4}{\nabla}$	0,04	0,06	0,09	0,13	0,15	0,18	0,22
1,6–2,5	$\sqrt{R_{th} 1,6}$	0,2–0,4	N4	$\frac{0,2}{\nabla}$	0,04	0,05	0,07	0,1	0,12	0,14	0,18
1–1,6	$\sqrt{R_{th} 1}$	0,1–0,2	N3	$\frac{0,1}{\nabla}$	0,03	0,04	0,06	0,08	0,1	0,11	0,14

*Please ensure that the feed rate values used do not exceed the corner radius (RE).

 The feed rate values shown are recommended values and are based on purely theoretical calculations using the above-mentioned formula. These may however deviate in practice.

Single-cut or dual-cut machining

Whether single-cut or dual-cut machining should be selected, depends on the following factors:

- ▲ Machine capacity
- ▲ Dimensional accuracy
- ▲ Geometrical accuracy
- ▲ Surface quality

Often it is a case of balancing between accuracy and productivity.

Single-cut machining

By using a high-quality machine tool and stable clamping, a single cut machining process can produce acceptable surface qualities and stable dimensions in many applications.

Single-cut machining

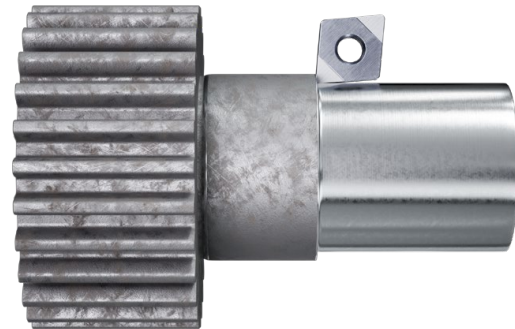

Dual-cut machining

In the case of unstable clamping, component batch fluctuations or where strict demands are placed on surface and dimension tolerances, dual-cut machining is advisable.

In this case it is advisable to work with two different widths of cut a_p .

Dual-cut machining

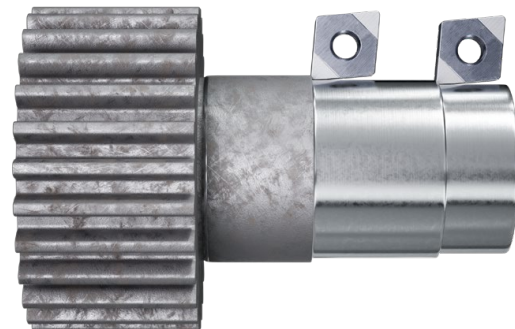



ISO designation system for inserts

Indexable inserts, CBN, ceramic – metric

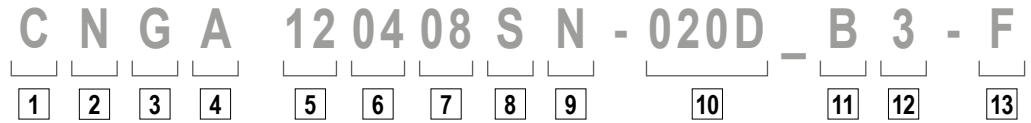

Indexable inserts, CBN, ceramic – inch

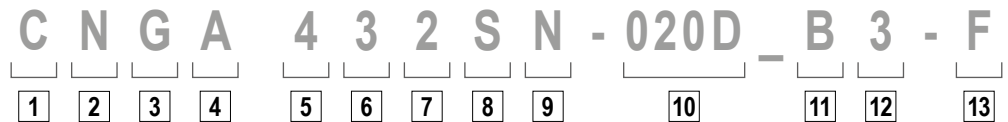

1

Insert shape

V	35°	Included angle
D	55°	
E	75°	
C	80°	Included angle
M	86°	
K	55°	Included angle
B	82°	
A	85°	Other shapes
L	90°	
P	108°	
H	120°	
O	135°	
R	-	
S	90°	
T	60°	
W	80°	

2

Clearance angle

α		α	
A	3°	F	25°
B	5°	G	30°
C	7°	N	0°
D	15°	P	11°
E	20°		

O Clearance angles not included within the standard for which particular information is necessary.

3

Tolerances

	IC±		BS		S	
	mm	inch	mm	inch	mm	inch
A	0,025	.0010	0,005	.0002	0,025	.001
F	0,013	.0005	0,005	.0002	0,025	.001
C	0,025	.0010	0,013	.0005	0,025	.001
H	0,013	.0005	0,013	.0005	0,025	.001
E	0,025	.0010	0,025	.0010	0,025	.001
G	0,025	.0010	0,025	.0010	0,13	.005
J	0,05-0,15*	.002-.006*	0,005	.0002	0,025	.001
K	0,05-0,15*	.002-.006*	0,013	.0005	0,025	.001
L	0,05-0,15*	.002-.006*	0,025	.0010	0,025	.001
M	0,05-0,15*	.002-.006*	0,05-0,20*	.003-.008*	0,13	.005
N	0,05-0,15*	.002-.006*	0,05-0,20*	.003-.008*	0,025	.001
U	0,08-0,25*	.003-.010*	0,13-0,38*	.005-.015*	0,13	.005

* Depends on insert size

6

Insert thickness

mm		inch		Code	
1,59	1/16	01	1		
2,38	3/32	02	1.5		
3,18	1/8	03	2		
3,97	5/32	T3	2.5		
4,76	3/16	04	3		
5,56	7/32	05	3.5		
6,35	1/4	06	4		
7,94	5/16	07	5		
9,52	3/8	09	6		

7

Corner radius

mm		inch		Code	
≤ 0,05	.0015	00	X0		
0,1	.004	01	0		
0,2	.008	02	.5		
0,4	1/64	04	1		
0,8	1/32	08	2		
1,2	3/64	12	3		
1,6	1/16	16	4		
2,0	5/64	20	5		
2,4	3/32	24	6		
2,8	7/64	28	7		
3,2	1/8	32	8		

RN 00
RC MO

8

Cutting edge

- F Sharp
- E rounded
- T chamfered
- S Chamfered and honed
- K Double-chamfered
- P Double-chamfered and honed
- R Round chamfer

9

Direction of cut

CBN and PCD segment orientation

-L -R

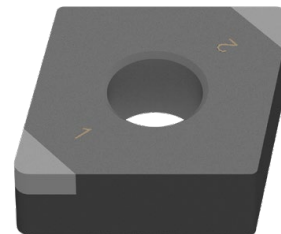

4

Characteristics

N		
R		
F		
A		
M, P		
G, P		
W		
T		
Q		
U		
B		
H		
C		
J		
X	Special version	

inch
Change at inscribed circle
IK < 1/4"

IK > 1/4"	IK < 1/4"
N / R / F	E
A / M / G	D
X	X

5

Cutting length

Type	ISO	ANSI	L		IC	
			mm	inch	mm	inch
C	06	2	6,4	.250	6,35	.250
	09	3	9,7	.382	9,525	.375
	12	4	12,9	.508	12,70	.500
	16	5	16,1	.634	15,875	.625
	19	6	19,3	.760	19,05	.750
	25	8	25,8	1.016	25,4	1.000
S	06	2	6,35	.250	6,35	.250
	09	3	9,525	.375	9,525	.375
	12	4	12,7	.500	12,7	.500
	15	5	15,875	.625	15,875	.625
	19	6	19,05	.750	19,05	.750
	25	8	25,4	1.000	25,4	1.000
D	07	2	7,7	.303	6,35	.250
	11	3	11,6	.457	9,525	.375
	15	4	15,5	.610	12,70	.500
V	11	2	11,1	.437	6,35	.250
	16	3	16,6	.653	9,525	.375
	22	4	22,10	.870	12,70	.500
T	06	2	6,9	.272	3,97	.156
	09	1.8	9,6	.378	5,56	.219
	11	2	11,0	.433	6,35	.250
	16	3	16,5	.650	9,525	.375
W	22	4	22,	.079	12,70	.039
	27	5	27,5	1.083	15,875	.625
	33	6	33,0	1.299	19,05	.750
	06	3	6,5	.256	9,525	.375
R	08	4	8,7	.331	12,70	.039
	10	5	10,9	.429	15,875	.625
R	06	2	6,35	.250	6,35	.250
	08	-	8,0	.315	8,0	.315
	09	3	9,52	.375	9,52	.375
	10	-	10,0	.394	10,0	.394
	12*	-	12,0	.472	12,0	.472
	12	4	12,7	.488	12,70	.488
	15	5	15,875	.625	15,875	.625
	16	-	16,0	.630	16,0	.630
	19	6	19,05	.750	19,05	.750
	25	8	25,0	.984	25,0	.984
	25*	-	25,4	1.000	25,4	1.000
	31	10	31,75	1.250	31,75	1.250
	32	-	32,0	1.260	32,0	1.260

* inch version

10

Chamfer type

mm	inch		
015	0,15	.006	A 05°
020	0,20	.008	B 10°
025	0,25	.010	C 15°
050	0,50	.020	D 20°
075	0,75	.030	E 25°
100	1,00	.040	F 30°
			G 35°

1) Two letters are assigned for double-chamfered cutting edges e.g. BE = chamfer angle 1 (y₁) = 10° chamfer angle 2 (y₂) = 25°

11

Number of cutting edges TCE(NOI)

Single sided		Complete insert thickness	
A		T	
B		U	
C		V	
D		W	
G		X	
H		Y	
Double sided		Entire clamping flat	
K		S	
L		F	
M		E	
N			
P			
Q			

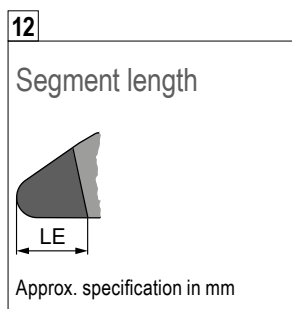

13

Chip breaker designation

F = Smooth cut
M = Interrupted cut
R = Strongly interrupted cut

A detailed chip breaker overview can be found in the main catalogue – Chapter 9 on → Pages 211–217

ISO designation system for tool holders

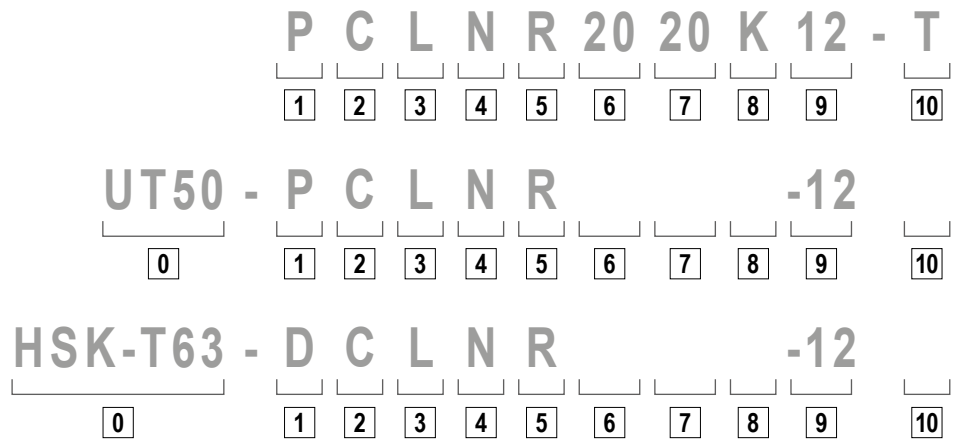

0

System/size

UT = UTS
according to ISO 26622
UT40 = UTS 40 mm
UT50 = UTS 50 mm
UT63 = UTS 63 mm

HSK-T
according to ISO 12164
HSK-T63 = 63 mm
HSK-T100 = 100 mm

1

Tool holder

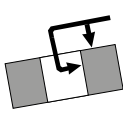
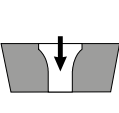
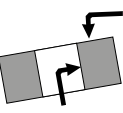
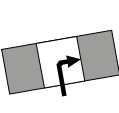
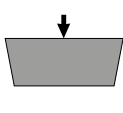
<p>D</p>  <p>Retained from above and via bore</p>	<p>S</p>  <p>Retained via centre screw</p>
<p>M</p>  <p>Retained from above and via bore</p>	<p>P</p>  <p>Retained via the bore</p>
<p>C</p>  <p>Retained from above</p>	<p>X</p> <p>Special version</p>

2

Insert shape

V 35°	Included angle
D 55°	
E 75°	
C 80°	Included angle
M 86°	
K 55°	Included angle
B 82°	
A 85°	Other shapes
L 90°	
P 108°	
H 120°	
O 135°	
R -	
S 90°	
T 60°	
W 80°	

6

Shank height



H

7

Shank width



B

8

Tool length

OAL			OAL		
mm	inch		mm	inch	
32	4.000	A	160	4.500	N
40	4.500	B	170	5.500	P
50	5.000	C	180	-	Q
60	6.000	D	200	6.000	R
70	7.000	E	250	7.000	S
80	8.000	F	300	8.000	T
90	5.500	G	350	5.500	U
100	5.625	H	400	3.500	V
110	5.300	J	450	3.500	W
125	14.000	K	500	3.750	Y
140	6.800	L	Special version		X
150	4.400	M			



OAL

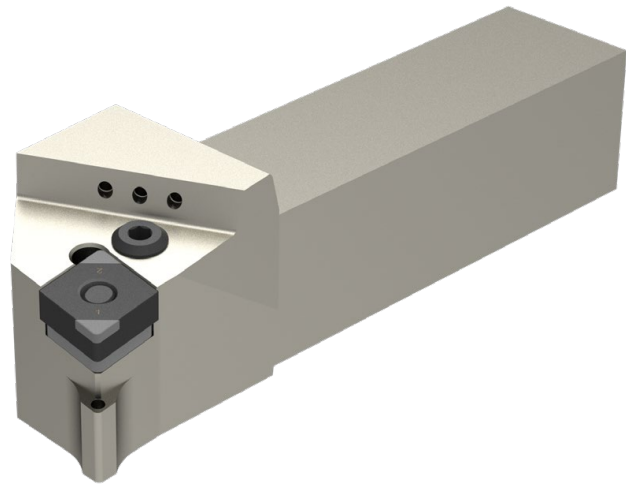

3

Style

A 90° B 75° C 90° D 45° E 60°
 F 90° G 90° H 107,5° J 93° K 75°
 L 95° M 50° N 63° P 117,5° R 75°
 S 45° T 60° U 93° V 72,5° W 60°
 Y 85°

4

Clearance angle

α	α
A 3°	F 25°
B 5°	G 30°
C 7°	N 0°
D 15°	P 11°
E 20°	

O Clearance angles not included within the standard for which particular information is necessary.

5

Direction of cut

R
 L
 N

9

Cutting length

L S R
 ABK T VDECM
 O H P W

10

Manufacturer specification

- T = Toggle
- Special length (mm)
- Insert thickness (deviating from standard)
- Special version (X.)
- Machine manufacturer (specific)
- DC = DirectCooling

ISO designation system for boring bars

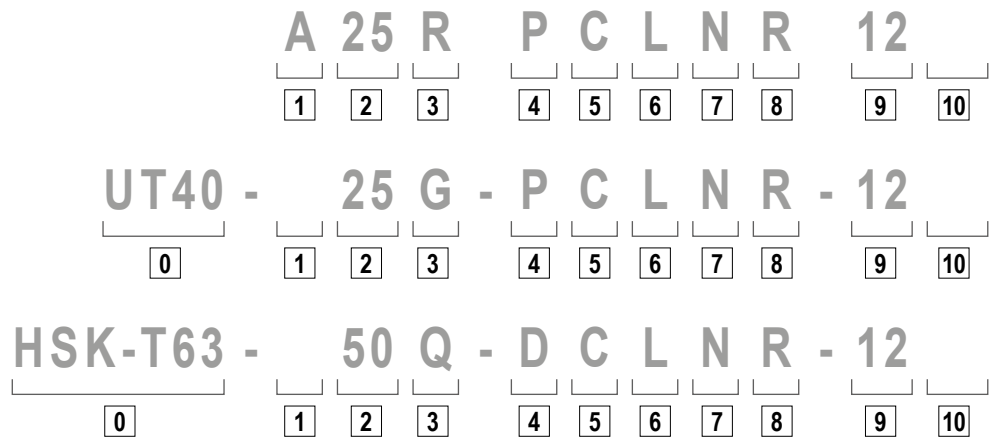

0

System/size

UT = UTS
according to ISO 26622
UT40 = UTS 40 mm
UT50 = UTS 50 mm
UT63 = UTS 63 mm

HSK-T
according to ISO 12164
HSK-T63 = 63 mm
HSK-T100 = 100 mm

1

Shank type

S Steel shank	E As C with coolant hole
A Steel shank with coolant hole	F As C with antivibration system
B Steel shank with antivibration system	G As C with coolant hole and antivibration system
D Steel shank with coolant hole and antivibration system	H Heavy metal
C Carbide shank with steel head	J Heavy metal with coolant hole

5

Insert shape

V 35°	Included angle
D 55°	
E 75°	
C 80°	
M 86°	
K 55°	Included angle
B 82°	
A 85°	
L 90°	
P 108°	
H 120°	
O 135°	
R -	
S 90°	
T 60°	
W 80°	

Other shapes

6

Style

*) CERATIZIT factory standard

7

Clearance angle

A 3°	F 25°
B 5°	G 30°
C 7°	N 0°
D 15°	P 11°
E 20°	

O Clearance angles not included within the standard for which particular information is necessary.



2

Shank type & size

DCONMS mm	DCONMS inch
08	
10	
12	
16	
20	
25	
32	
40	
50	
60	

A two-digit figure indicating the boring bar diameter in 1/16 of an inch.

3

Tool length

OAL		
mm	inch	
80	3	F
100	3,5	H
110	4	J
125	4,5	K
140	5	L
150	5,5	M
160	6	N
170	6,5	P
180	6,75	Q
200	7	R
250	8	S
300	10	T
350	12	U
400	14	V
450	16	W
500	18	Y
	20	
Special version		X

4

Clamping method

<p>D</p> <p>Retained from above and via bore</p>	<p>S</p> <p>Retained via centre screw</p>
<p>M</p> <p>Retained from above and via bore</p>	<p>P</p> <p>Retained via the bore</p>
<p>C</p> <p>Retained from above</p>	<p>X</p> <p>Special version</p>

8

Direction of cut

R

L

9

Cutting length

10

Manufacturer specification

T = Toggle
 Special length (mm)
 Insert thickness (deviating from standard)
 Special version (X..)
 Machine manufacturer (specific)

Types of wear

PCBN indexable inserts can be easily damaged if used incorrectly, or can even break. Frequent application errors include selecting the incorrect cutting material grade, incorrect cutting parameters (feed and cutting speed), and incorrect cutting edge preparation. In addition, unstable tools with a large overhang length and poor workpiece clamping can cause vibrations during hard turning.

Wear on clearance face



Cause

Abrasion on the flank: normal wear after a certain period of operation.

Remedy

- ▲ Reduction of cutting speed
- ▲ Increase feed (reduction of reaming length)
- ▲ Use more wear-resistant grade
- ▲ Reduce chamfer angle
- ▲ Use air cooling
- ▲ Use positive clearance angle

Edge breakages



Cause

Increased mechanical stress on the cutting edge results in chipping.

Remedy

- ▲ Use grade with higher PCBN content
- ▲ Reduction of cutting speed
- ▲ Increase chamfer angle and width
- ▲ Check centre height
- ▲ Reduce the feed
- ▲ Use larger corner radius
- ▲ Reduce vibrations
- ▲ Improve stability (tool, workpiece)

Cratering



Cause

The outgoing hot chip is causing cratering of the cutting insert on the clamping flat.

Remedy

- ▲ Use crater-resistant grades
- ▲ Reduction of cutting speed
- ▲ Increase the feed, thus reducing the reaming length
- ▲ Reduce chamfer angle

Notch wear



Cause

Necking at the maximum depth of cut.

Remedy

- ▲ Use grade with higher PCBN content
- ▲ Increase the cutting speed
- ▲ Reduce the feed
- ▲ Vary cutting depth
- ▲ Reduce chip thickness
- ▲ Increase corner radius (this reduces the setting angle)

Insert breakage

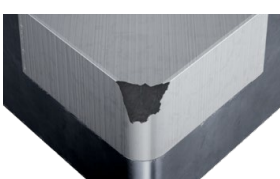

Cause

If a cutting insert is overloaded, insert breakage may occur.

Remedy

- ▲ Use a tougher cutting material
- ▲ Reduction of cutting speed
- ▲ Increase chamfer angle and width
- ▲ Reduce the feed
- ▲ Use larger corner radius
- ▲ Reduce vibrations
- ▲ Improve stability (tool, workpiece)
- ▲ Use more stable geometry
- ▲ Reduce cutting depth
- ▲ Check interference contours

Troubleshooting guide for turning

Problem

Type of wear

Workpiece problems

Wear on clearance face	Cratering	Notch wear	Cracks at right angles to the cutting edge	Edge chipping	Insert breakage	Chipping on the surface	Surface quality	Vibration	Burr formation	Remedy measures
	↓		↓			↓	↑	↓		Cutting speed v_c
↑	↑	↓	↓	↓		↑	↓	~	↑	Feed f
↑			↓	↓					↑	Depth of cut a_p
	↓		↓	↑	↑	↓	↓		↓	Chamfer angle 35°, heavily interrupted cut Chamfer angle 25°, continuous, slightly interrupted cut Chamfer angle 15°, continuous, slightly interrupted cut
		↑	↑	↑		↑	↓	↓		Corner radius larger ↑ smaller ↓
↓	↓		↓	↓	↑	↓	↓	↓	↓	Rounding
	↓	↑	↑	↑	↑					BH Wear resistance PCBN content BL toughness ↑ ↓
				~	~	~	~	~		Tool clamping
				~	~	~	~	~		Work piece clamping
				~	~	↓	↓	↓		Overhang
~				~	~	~	~	~		Tip height
○		○	○	○	○				●	Cooling lubricant

↑ raise, increase, large influence
↑ raise, increase, small influence

↓ avoid, reduce, large influence
↓ avoid, reduce, small influence

~ check, optimise
● use
○ do not use

Measures in the case of turning problems with PCBN

Troubleshooting

Problem	Possible causes	Remedy
Poor tool lives	<ul style="list-style-type: none"> ▲ Cutting speed not within the specifications ▲ Chip softening not carried out 	<ul style="list-style-type: none"> ▲ Increase the cutting speed ▲ Ideally, chip is red hot
Bad surface quality	<ul style="list-style-type: none"> ▲ Feed too high ▲ Corner radius too small 	<ul style="list-style-type: none"> ▲ Reduce feed ▲ Increase corner radius
Chatter marks	<ul style="list-style-type: none"> ▲ Tool overhang too long 	<ul style="list-style-type: none"> ▲ Reduce projection length ▲ Use more stable holder
Vibration	<ul style="list-style-type: none"> ▲ Cutting pressure too high ▲ Chip thickness too large ▲ Centre height incorrect ▲ Unstable tool or workpiece clamping ▲ Indexable insert radius too large, high recoil force 	<ul style="list-style-type: none"> ▲ Reduce cutting pressure ▲ Reduce chip thickness ▲ Check/adjust centre height ▲ Use smaller radius
Burrs on workpiece	<ul style="list-style-type: none"> ▲ With soft materials (sintered steel) ▲ Cutting pressure too high ▲ Corner radius too large ▲ Chamfer angle too large 	<ul style="list-style-type: none"> ▲ Use smaller radius ▲ Adjust chip thickness ▲ Increase cutting depth ▲ Increase cutting speed ▲ Reduce chamfer angle ▲ Use sharp cutting edge
Notch wear	<ul style="list-style-type: none"> ▲ Constant cutting depth leaving witness 	<ul style="list-style-type: none"> ▲ For dual-cut strategy, use different cutting depths ▲ Increase chamfer angle
Edge breakage on the workpiece	<ul style="list-style-type: none"> ▲ Sharp edge at the exit 	<ul style="list-style-type: none"> ▲ Change machining direction ▲ Reduce feed at entry and exit ▲ Program soft machining with chamfers and radii

General formulae

Cutting speed [m/min]

$$V_c = \frac{d \cdot \pi \cdot n}{1000}$$

Speed [rpm]

$$n = \frac{V_c \cdot 1000}{\pi \cdot d}$$

Feed [mm/rev]

$$f = \frac{V_f}{n}$$

Clamping cross-section [mm²]

$$A = a_p \cdot f$$

Feed rate [mm/min]

$$V_f = f \cdot n \quad [\text{mm/min}]$$

Chip volume [cm³/min]

$$Q = V_c \cdot a_p \cdot f \quad [\text{cm}^3/\text{min}]$$

Cutting length [m]

$$\text{SCL} = \frac{d \cdot 3,14 \cdot l_m}{1000 \cdot f_n}$$

Chip thickness

$$h = f \cdot \sin \alpha$$

Period of operation [min]

$$T_c = \frac{l_m}{f \cdot n}$$

KEY

V_c = Cutting speed [m/min]
 d = Turning diameter [mm]
 n = Speed [rpm]
 π = 3.141592
 f = Feed [mm/rev]
 V_f = Feed rate [mm/min]
 A = Clamping cross-section [mm²]
 a_p = Depth of cut [mm]
 Z = Number of flutes
 Q = Chip volume [cm³/min]
 a_e = Radial depth of cut [mm]

SCL = Cutting length [m]
 l_m = Turning length [mm]
 T_c = Period of operation [min]
 h = Chip thickness
 $\sin \alpha$ = Approach angle

Hardness comparison table

Tensile strength N/mm	Vickers HV	Brinell HB	Rockwell HRC	Shore C
575	180	171		
595	185	176		
610	190	181		
625	195	185		
640	200	190	12	
660	205	195	13	
675	210	199	14	
690	215	204	15	
705	220	209	15	28
720	225	214	16	
740	230	219	17	29
755	235	223	18	
770	240	228	20.3	30
785	245	233	21.3	
800	250	238	22.2	31
820	255	242	23.1	32
835	260	247	24	33
850	265	252	24.8	
865	270	257	25.6	
880	275	261	26.4	34
900	280	268	27.1	
915	285	271	27.8	35
930	290	276	28.5	
950	295	280	29.2	36
965	300	285	29.8	37
995	310	295	31	38
1030	320	304	32.2	39
1060	330	314	33.3	40
1095	340	323	34.3	41
1125	350	333	35.5	42
1155	360	342	36.6	43
1190	370	352	37.7	44
1220	380	361	38.8	45
1255	390	371	39.8	46
1290	400	380	40.8	47
1320	410	390	41.8	48
1350	420	399	42.7	
1385	430	409	43.6	49
1420	440	418	44.5	
1455	450	428	45.3	51
1485	460	437	46.1	52
1520	470	447	46.9	53
1555	480	465	47.7	54
1595	490	466	48.4	
1630	500	475	49.1	57
1665	510	485	49.8	58
1700	520	494	50.5	59
1740	530	504	51.1	60
1775	540	513	51.7	61
1810	550	523	52.3	62

Tensile strength N/mm	Vickers HV	Brinell HB	Rockwell HRC	Shore C
1845	560	532	53	63
1880	570	542	53.6	64
1920	580	551	54.1	65
1955	590	561	54.7	66
1995	600	570	55.2	67
2030	610	580	55.7	68
2070	620	589	56.3	69
2105	630	599	56.8	70
2145	640	608	57.3	71
2180	650	618	57.8	72
2210	660	628	58.3	73
2240	665	633	58.8	74
2280	670	638	59.3	
2310	675	643	59.8	75
2350	680	648	60.3	76
2380	685	653	61.1	77
2410	690	658	61.3	78
2450	695	663	61.7	79
2480	710	668	62.2	80
2520	720	678	62.6	81
2550	730	683	63.1	82
2590	740	693	63.5	
2630	750	703	63.9	83
2660	760	708	64.3	84
2700	770	718	64.7	85
2730	780	723	65.1	
2770	790	733	65.5	86
2800	800	738	65.9	
2840	810	748	66.3	87
2870	820	753	66.7	88
2910	830	763	67	
2940	840	768	67.4	89
2980	850		67.7	
3010	860		68.1	90
3050	870		68.4	
3080	880		68.7	91
3120	890		69	
3150	900		69.3	92
3190	910		69.6	
3220	920		69.9	
3260	930		70.1	

Conversion values are approximate, based on DIN EN ISO18265 (02-2004)

Extended Material Examples for the Cutting Data Tables

	Material sub-group	Index	Composition / Structure / Heat treatment	Tensile strength N/mm ² / HB / HRC
P	Unalloyed steel	P.1.1	< 0,15 % C Annealed	420 N/mm ² / 125 HB
		P.1.2	< 0,45 % C Annealed	640 N/mm ² / 190 HB
		P.1.3	< 0,45 % C Tempered	840 N/mm ² / 250 HB
		P.1.4	< 0,75 % C Annealed	910 N/mm ² / 270 HB
		P.1.5	< 0,75 % C Tempered	1010 N/mm ² / 300 HB
	Low-alloy steel	P.2.1	Annealed	610 N/mm ² / 180 HB
		P.2.2	Tempered	930 N/mm ² / 275 HB
		P.2.3	Tempered	1010 N/mm ² / 300 HB
		P.2.4	Tempered	1200 N/mm ² / 375 HB
	High-alloy steel and high-alloy tool steel	P.3.1	Annealed	680 N/mm ² / 200 HB
		P.3.2	Hardened and tempered	1100 N/mm ² / 300 HB
		P.3.3	Hardened and tempered	1300 N/mm ² / 400 HB
	Stainless steel	P.4.1	Ferritic / martensitic Annealed	680 N/mm ² / 200 HB
		P.4.2	Martensitic Tempered	1010 N/mm ² / 300 HB
M	Stainless steel	M.1.1	Austenitic / austenitic-ferritic Quenched	610 N/mm ² / 180 HB
		M.2.1	Austenitic Tempered	300 HB
		M.3.1	Austenitic / ferritic (Duplex)	780 N/mm ² / 230 HB
K	Grey cast iron	K.1.1	Pearlitic / ferritic	350 N/mm ² / 180 HB
		K.1.2	Pearlitic (martensitic)	500 N/mm ² / 260 HB
	Spherulitic graphite cast iron	K.2.1	Ferritic	540 N/mm ² / 160 HB
		K.2.2	Pearlitic	845 N/mm ² / 250 HB
	Malleable iron	K.3.1	Ferritic	440 N/mm ² / 130 HB
		K.3.2	Pearlitic	780 N/mm ² / 230 HB
N	Aluminium wrought alloy	N.1.1	Non-hardenable	60 HB
		N.1.2	Hardenable Age-hardened	340 N/mm ² / 100 HB
	Cast aluminium alloy	N.2.1	≤ 12 % Si, non-hardenable	250 N/mm ² / 75 HB
		N.2.2	≤ 12 % Si, hardenable Age-hardened	300 N/mm ² / 90 HB
		N.2.3	> 12 % Si, non-hardenable	440 N/mm ² / 130 HB
	Copper and copper alloys (bronze/brass)	N.3.1	Free-machining alloys, PB > 1 %	375 N/mm ² / 110 HB
		N.3.2	CuZn, CuSnZn	300 N/mm ² / 90 HB
		N.3.3	CuSn, lead-free copper and electrolytic copper	340 N/mm ² / 100 HB
Magnesium alloys	N.4.1	Magnesium and magnesium alloys	70 HB	
S	Heat-resistant alloys	S.1.1	Fe - basis Annealed	680 N/mm ² / 200 HB
		S.1.2	Fe - basis Age-hardened	950 N/mm ² / 280 HB
		S.2.1	Ni or Co basis Annealed	840 N/mm ² / 250 HB
		S.2.2	Ni or Co basis Age-hardened	1180 N/mm ² / 350 HB
		S.2.3	Ni or Co basis Cast	1080 N/mm ² / 320 HB
	Titanium alloys	S.3.1	Pure titanium	400 N/mm ²
		S.3.2	Alpha + beta alloys Age-hardened	1050 N/mm ² / 320 HB
S.3.3	Beta alloys	1400 N/mm ² / 410 HB		
H	Hardened steel	H.1.1	Hardened and tempered	46–55 HRC
		H.1.2	Hardened and tempered	56–60 HRC
		H.1.3	Hardened and tempered	61–65 HRC
		H.1.4	Hardened and tempered	66–70 HRC
	Chilled iron	H.2.1	Cast	400 HB
	Hardened cast iron	H.3.1	Hardened and tempered	55 HRC
O	Non-metal materials	O.1.1	Plastics, duroplastic	≤ 150 N/mm ²
		O.1.2	Plastics, thermoplastic	≤ 100 N/mm ²
		O.2.1	Aramid fibre-reinforced	≤ 1000 N/mm ²
		O.2.2	Glass/carbon-fibre reinforced	≤ 1000 N/mm ²
		O.3.1	Graphite	

* Tensile strength

The pages that follow give further information on our material examples for our usual indexes with additional international standards.

Overview of standards:

DIN

Deutsche Industrie Norm (German Standard)

AFNOR

Association Francaise de Normalisation (French Standard)

UNI

Unificazione Italiana (Italian Standard)

ČSN

Czechoslovakian Standard

BS

British Standards

SIS

Standardiseringen i Sverige (Swedish Standard)

UNE

Spanish Standard

JIS

Japanese Industrial Standard

GOST / GOCT

Soviet Standard

UNS

Unified Numbering System

USA

Under USA several American standards are summarized

Extract H materials:

Index	Material number	DIN	AFNOR	UNI	ČSN	BS	SIS	UNE	JIS	ГОСТ	UNS	USA				
H	H.1.1	1.2311	40 CrMnMo 7			19 520										
		1.2312	40 CrMnMoS 8 6	40 CMD 8 + S												
		1.2316	X 36 CrMo 17	Z 38 CD 17	X 38 CrMo 16 1 KU											
		1.2365	X 32 CrMoV 3 3	32 DCV 28	30 CrMoV 12 27 KU	19 541	BH 10			SKD 7	3Ch3M3F	T 20810	H 10			
		1.2567	X 30 WCrV 5 3	Z 32 WCV 5	X 30 WCrV 5 3 KU	19 720				SKD 4						
		1.2581	X 30 WCrV 9 3	Z 30 WCV 9	X 30 WCrV 9 3 KU	19 721	BH 21			SKD 5	3Ch2W8F	T 20821	H 21			
		1.2738	40 CrMnNiMo 8						F-5303							
		1.2885	X 32 CrMoCoV 3 3 3	30 DCKV 28												
		1.4028	X 30 Cr 13	Z 30 C 13	X 30 Cr 13	17 023	420 S 45	2304		SUS 420 J 2	30Ch13					
		1.4031	X 38 Cr 13	Z 40 C 14	X 40 Cr 14	17 024		2304	F-3404	SUS 420 J 2	40Ch13					
		1.4034	X 46 Cr 13	Z 40 C 14	X 40 Cr 14	17 029	420 S 45		F-3405		40Ch13					
		1.4112	X 90 CrMoV 18									S 44003				
		1.5122	37 MnSi 4				13 240									
		1.6358	X 2 NiCoMoTi 18 9 5													
		1.6582	34 CrNiMo 6	35 NCD 6	35 NiCrMo 6 (KW)	16 342	817 M 40	2541	F-128 / F-1270	SNCM 447	38Ch2N2MA			4340		
		1.7003	38 Cr 2	38 C 2	38 Cr 2											
		1.7006	46 Cr 2	42 C 2	45 Cr 2									5045		
		1.7030	28 Cr 4					530 A 30				30Ch		5130		
		1.7176	55 Cr 3	55 C 3	55 Cr 3		527 A 60	2253	F-1431	SUP 9 (A)	50ChGA	G 51550		5155		
		1.0961	60 SiCr 7	60 SC 7	60 SiCr 8					SUP 7				9262		
		1.1248	Ck 75	XC 75	C 75	12 081	060 A 78	1774; 1778				75	G 10780	1078; 1080		
		1.1273	90 Mn 4													
		H	H.1.2	1.2083	X 42 Cr 13	Z 40 C 14	X 41 Cr 13 KU	19 435			F-5263	SUS 420 J 2				
				1.2323	GS-48 CrMoV 6 7											
				1.2343	X 38 CrMoV 5 1	Z 38 CDV 5	X 37 CrMoV 5 1 KU	19 552	BH 11			F-5317	SKD 6	4Ch5MFS	T 28811	H 11
				1.2367	X 38 CrMoV 5 3											
				1.2510	100 MnCrW 4	90 MWCV 5	95 MnWCr 5 KU	19 314	BO 1	2140	F-5220	SKS 3		T 31501	O 1	
				1.2542	45 WCrV 7		45 WCrV 8 KU	19 732	BS 1	2710				T 41901	S 1	
1.2550	60 WCrV 7			55 WC 20	55 WCrV 8 KU	19 735										
1.2606	G-X 37 CrMoW 5 1															
1.2711	54 NiCrMoV 6			55 NCDV 6			19 662									
1.2713	55 NiCrMoV 6			55 NCDV 7			19 662			F-520.S	SKT 4	5ChNM	T 61206	L 6		
1.2764	X 19 NiCrMo 4															
1.2767	X 45 NiCrMo 4			Y 35 NCD 16	42 NiCrMo 15 7	19 655										
1.4109	X 65 CrMo 14															
1.4112	X 90 CrMoV 18											S 44003				
1.1157	40 Mn 4			35 M 5				150 M 36				40G	G 10390	1039		
1.1231	Ck 67			XC 68	C 70	12 071	060 A 67	1770				70	G 10700	1070		
1.1274	Ck 101			XC 100			060 A 96	1870		SUP 4			G 10950	1095		
H	H.1.3			1.2080	X 210 Cr 12	Z 200 C 12	X 210 Cr 13 KU	19 436	BD 3			SKD 1	Ch12	T 30403	D 3	
				1.2101	62 SiMnCr 4											
				1.2162	21 MnCr 5	20 NC 5			19 487				SCR 420 H			
		1.2201	G-X 165 CrV 12													
		1.2210	115 CrV 3	100 C 3	107 CrV 3 KU	19 421						T 61202	L 2			
		1.2341	X 6 CrMo 4													
		1.2379	X 155 CrVMo 12 1	Z 160 CDV 12	X 155 CrVMo 12 1 KU	19 573	BD 2			F-5211	SKD 11		T 30402	D 2		
		1.2419	105 WCr 6	105 WC 13	107 WCr 5 KU						SKS 31	ChWG				
		1.2601	X 165 CrMoV 12		X 165 CrMoV 12 KU	19 572		2310								

Index	Material number	DIN	AFNOR	UNI	ČSN	BS	SIS	UNE	JIS	ГОСТ	UNS	USA	
H	H.1.3	1.2721	50 NiCr 13										
		1.2735	15 NiCr 14	10 NC 12		16 240			SNC 22		T 51606		
		1.2833	100 V 1	Y1 105 V	102 V 2 KU	19 356	BW 2			SKS 43		T 72302	W 210
		1.2842	90 MnCrV 8	90 MV 8	90 MnVCr 8 KU	19 314	BO 2					T 31502	O 2
		1.3505	100 Cr 6	100 C 6	100 Cr 6	14 100	534 A 99	2258	F-131 / F-1310	SUJ 2	SchCh 15	G 52986	52100
		1.4112	X 90 CrMoV 18									S 44003	
		1.4125	X 105 CrMo 17	Z 100 CD 17	X 105 CrMo 17					SUS 440 C		S 44004	440 C
		1.8161	58 CrV 4				15 261						
		1.1520	C 70 W1										
	H.1.4	1.2363	X 100 CrMoV 5 1	Z 100 CDV 5	X 100 CrMoV 5 1 KU	19 571	BA 2	2260	F-5227	SKD 12		T 30102	A 2
		1.2436	X 210 CrW 12	Z 200 CW 12	X 215 CrW 12 1 KU	19 437		2312	F-5213	SKD 2			
		1.2880	G-X 165 CrCoMo 12										
		1.3202	S 12-1-4-5				19 858					T 12015	T15
		1.3207	S 10-4-3-10	Z 130 WKCDV 10-10-04	HS 10-4-3-10	19 861	BT 42		F-5553	SKH 57			
		1.3243	S 6-5-2-5	Z 85 WDKCV 06-05-05	HS 6-5-2-5	19 852		2723	F-5613	SKH 55	R6M5K5		
		1.3246	S 7-4-2-5	Z 110 WKCDV 07-05-04	HS 7-4-2-5	19 851						T 11341	M 41
		1.3247	S 2-10-1-8	Z 110 DKCWV 09-08-04	HS 2-9-1-8		BM 42			SKH 51		T 11342	M 42
		1.3249	S 2-9-2-8				BM 34					T 11333	M 33; M 34
		1.3257	S 18-1-2-15										
		1.3333	S 3-3-2		HS 3-3-2	19 820							
		1.3343	S 6-5-2	Z 85 WDCV 06-05-04-0	HS 6-5-2	19 830	BM 2	2722	F-5603	SKH 9; SKH 51	R6AM5	T 11302	M 2
		1.3344	S 6-5-3	Z 120 WDCV 06-05-04	HS 6-5-3		BM 4			SKH 52; SKH 53		T 11323	M 3 Cl. 2
		1.3346	S 2-9-1	Z 85 DCWV 08-04-02-0	HS 1-8-1		BM 1				H41	T 11301	H 41; M 1
		1.3348	S 2-9-2	Z 100 DCWV 09-04-02	HS 2-9-2			2782				T 11307	M 7
		1.3355	S 18-0-1	Z 80 WCV 18-04-01	HS 18-0-1	19 824	BT 1			SKH 2	R18	T 12001	T 1
		1.1654	C 110 W										
	H.3.1	0.9620	G-X 260 NiCr 4 2				Grade 2 A	0512-00					A 532 I B NiCr-LC
		0.9625	G-X 330 NiCr 4 2				Grade 2 B	0513-00					A 532 I A NiCr-HC
		0.9630	G-X 300 CrNiSi 9 5 2				Grade 2 C; D; E	0457-00					A 532 I D Ni-HiCr
		0.9635	G-X 330 CrMo 15 3				Grade 3 A; B						A 532 II C 15% CrMo-
		0.9640	G-X 300 CrMoNi 15 2				Grade 3 A; B						
		0.9645	G-X 260 CrMoNi 20 2				Grade 3 C						A 532 II D 20% CrMo-
		0.9650	G-X 260 Cr 27				Grade 3 D	0466-00					A 532 III A 25% Cr
0.9655		G-X 300 CrMo 27 1				Grade 3 E						A 532 III A 25% Cr	



**From consulting to
successful completion, we
realise your application-specific
project goals**

Developing optimal processes

Benefit from our innovative tool concepts, many years of experience and professional advice to increase your productivity

In order to machine increasingly complex workpieces cost effectively and to a high level of quality, all the process parameters need to be tailored to the specific task. Those who succeed in meeting these challenges will remain competitive on the global market. However, the reality is that businesses often do not have the capacity to analyse manufacturing processes and optimise them to make them more efficient. There is also usually not enough time to tailor new cutting materials, tool geometries or process technologies to the individual machining operations. This is precisely where our project engineering comes in. As one of the leading tool manufacturers and innovators in the machining industry, we develop ideal tool concepts for you based on key success factors such as efficiency, time and quality. Why are we the ideal system partner for you? We have many years of experience in the development of innovative tool solutions, can draw on sound technical expertise and provide first-rate service. What's more, with our leading product brands Cutting Solutions by CERATIZIT, KOMET, WNT and KLENK, we are a full-service provider in machining, offering one of the most comprehensive ranges of cutting tools and services. If you want to set the pace rather than risk falling behind the international competition, then get in touch with us now!

You can rely on us to implement your project successfully!



Project consulting



Project development & quotation

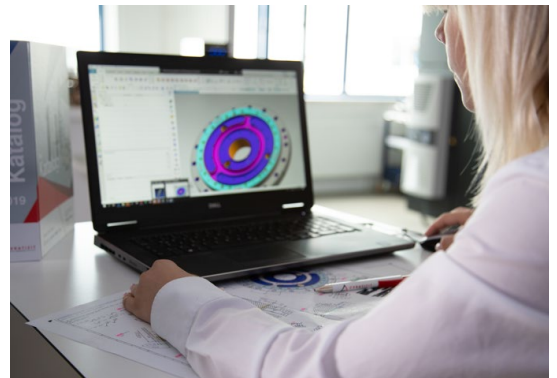

Project implementation



Ongoing support



We always keep your objectives in mind and provide you with advice across all industries in all application ranges. Benefit from our many years of experience and our innovative solutions.

The services we provide

- ▲ Consulting service for all applications and industries
- ▲ Needs-oriented advice on process optimisation
- ▲ Dedicated project manager

Our interdisciplinary project team develops the ideal machining concept for your individual specifications and objectives using high-end CERATIZIT tools.

The services we provide

- ▲ Development of a machining and tool concept
- ▲ Cycle time consideration
- ▲ Machining tests in our in-house Technical Centers
- ▲ Prognosis of the tooling requirement and tool costs per component
- ▲ Business quotation

Our expert team implements the concept on your machine, working closely with you and your dedicated CERATIZIT application engineer. This on-site support guarantees you will receive a stable and cost-effective manufacturing process for your product.

The services we provide

- ▲ Detailed planning of the machining process
- ▲ Tool design
- ▲ Collision monitoring
- ▲ Tool assembly
- ▲ Support from a dedicated application engineer when proving out the machining process and for CNC programming
- ▲ Tool documentation
- ▲ Regular project status reports

Even after successful implementation of the project, we are here for you. Your dedicated application engineer keeps an eye on your manufacturing processes, determines further potential for optimisation and provides you with ongoing support for all the challenges you face.

The services we provide

- ▲ Ongoing manufacturing support
- ▲ Series production support and process optimisation



ENGINEERS FIRST AND FOREMOST.

**JUST
OUR
THING**



**TECHNICAL SUPPORT.
WHEN YOU NEED IT MOST.**

**OUR WAREHOUSE IN YOUR
MACHINE SHOP.**

www.just-our-thing.com



**THE
Cutting Tool Solution**

CERATIZIT UK & IRELAND LTD
Europa Link \ UK-Sheffield S9 1XU
Tel.: +44 114 242 8 820
info.uk@ceratizit.com \ www.ceratizit.com



Part of the Plansee Group