

The tool selection for Sliding head machines

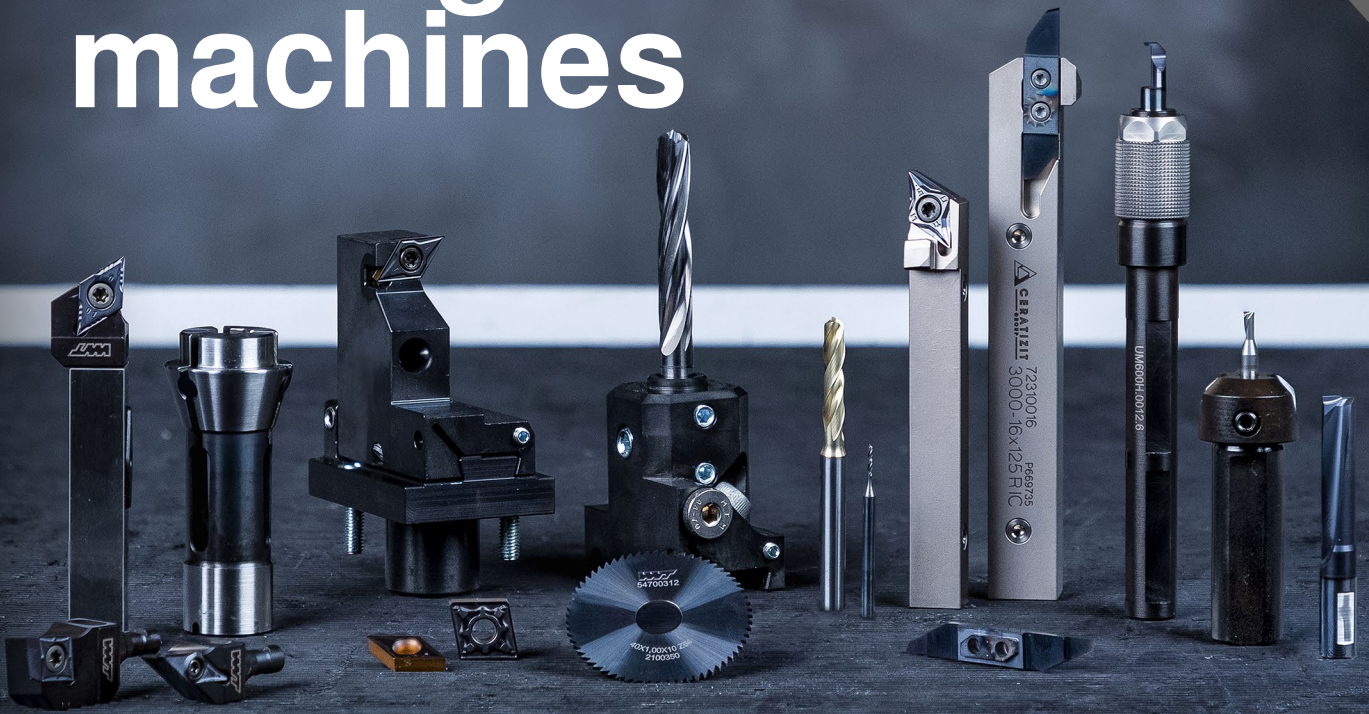

TEAM CUTTING TOOLS



klenk

CERATIZIT is a high-technology engineering group specialised in cutting tools and hard material solutions.

Tooling the Future

www.ceratizit.com

WE PROVIDE YOU WITH THE PERFECT MACHINING SOLUTION

Team Cutting Tools of the CERATIZIT Group

The machining industry today is extremely diverse and is becoming increasingly complex. Trends and innovations are moving quickly, and the possibilities and offerings seem virtually unlimited. For this reason it is all the more important to have a reliable and competent partner on board!

The Team Cutting Tools is not just a tool supplier; the experts on the team are also available to advise you with extensive industry knowledge and decades of experience in machining, in order to find you the perfect machining solution.

The Cutting Tool Solution is

**FULL RANGE
PRODUCT PORTFOLIO**

**INNOVATIVE
ORIENTATION**

**HIGHEST
TECHNICAL COMPETENCE**

**FAST AND EFFICIENT
AVAILABILITY**

**DEEP
INDUSTRY KNOWLEDGE**

**INDEPENDENT
QUALITY GUARANTEE**

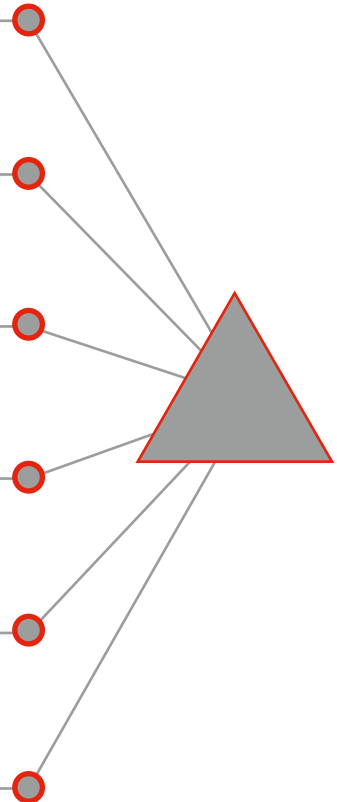

Contact us



Placing your order is quick and easy

Customer Service Centre

Freephone Number

UK: 0800 073 2073

Ireland: 1800 93 22 55

Freefax Number

UK: 0800 073 2074

E-Mail

info.uk@ceratizit.com



It couldn't be easier

Ordering via the Online Shop

<http://cuttingtools.ceratizit.com>



Manufacturing consulting and process optimization on site

Your personal application engineer

Your customer number

Solid drilling and bore machining

HSS drilling

Solid carbide drilling

Reamers

1

Threading

HSS taps

Circular and Thread Milling

Thread turning

2

Turning

Turning Tools

Multi-function tool - EcoCut

Grooving Tools

Miniature turning tools

3

Milling

Solid Carbide milling cutters

4

Workholding

Collets and reduction sleeves

5

Material examples and article no. index

6



E-COMMERCE SOLUTIONS

Benefit from more product data and machining knowledge online, accelerate and optimize your tool procurement processes or create a direct connection to your ERP system.

Instantly and accurately find the right tool from over 65,000 products from the brands CERATIZIT, WNT, KOMET and KLENK and order it conveniently. At cuttingtools.ceratizit.com, you now have access to one of the largest ranges of machining tools and can order products even quicker and easier thanks to countless new functions and options!

REGISTER NOW UNDER:

cuttingtools.ceratizit.com



SIMPLE TOOL AND ARTICLE SEARCH FUNCTION

- ▲ Simple article search function using the article number or product name
- ▲ Ideal filter options for quick tool search
- ▲ Recommendation of suitable accessories on the article page
- ▲ Access the latest article data at any time

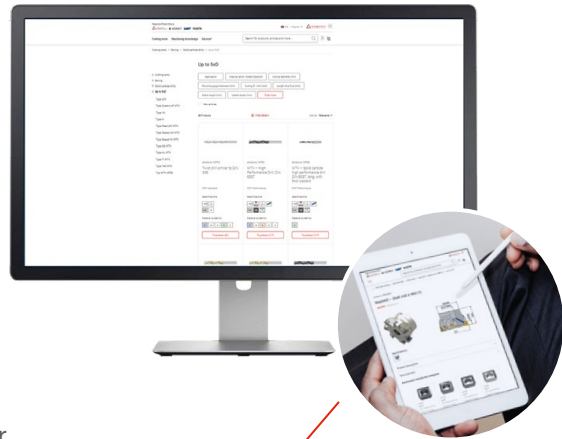

FAST ORDERING

- ▲ Online processes save time and money during the ordering process
- ▲ Add items to your basket quickly and easily
- ▲ High availability including a check in the basket
- ▲ Order 24 hours a day
- ▲ Quick delivery with tracking

EXCLUSIVE ONLINE DISCOUNTS

- ▲ Save money as well as time when ordering online

CONNECT TO ERP SYSTEMS

- ▲ All key data in your ERP system
- ▲ Optimise your internal procurement processes
- ▲ Avoid copy/paste errors with direct data transfer

FIRST-RATE SERVICE & ADVICE

- ▲ Free download of CAD and cutting data
- ▲ Download of forms, brochures and catalogues

PERSONALISED CUSTOMER ACCOUNT

- ▲ Retrieve prices with your personal customer discounts
- ▲ Set up several accounts with personalised order authorisations
- ▲ Save items for later
- ▲ View and print orders and invoices

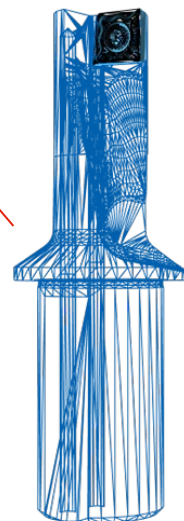

Questions about how to use the online shop and frequently asked questions can be found at: cuttingtools.ceratizit.com/gb/en/faq

FULL RANGE PRODUCT PORTFOLIO

Everything for machining from the spindle
to machine table



- ▲ Turning Tools
- ▲ Multifunction Tools
- ▲ Grooving Tools
- ▲ Milling Tools with indexable Inserts
- ▲ Tools made from ultra-hard cutting materials



- ▲ Indexable Insert Drilling
- ▲ Reaming and Countersinking
- ▲ Spindle Tooling
- ▲ Actuating Tools



- ▲ HSS Drilling
- ▲ Solid Carbide Drilling
- ▲ Taps and Thread Formers
- ▲ Circular and Thread Milling
- ▲ Thread Turning
- ▲ Miniature Turning Tools
- ▲ HSS Milling Cutters
- ▲ Solid Carbide Milling Cutters
- ▲ Tool Clamping
- ▲ Workpiece Clamping



- ▲ Solid Carbide Drilling and Milling for Aerospace Frame Assembly Industry



COMPREHENSIVE RANGE OF STANDARD-TOOLS

With a selection of cutting tools exclusively for machining applications, CERATIZIT has the most comprehensive product range on the market. Be it turning, drilling, milling, grooving, boring or clamping, we offer a broad selection of innovative, state-of-the-art products for every application – with 99% ex-stock availability.

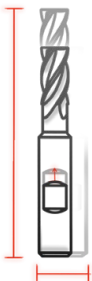

CUSTOM ADAPTATIONS TO THE STANDARD TOOL RANGE

The semi standard tool programm enables you to adapt your own standard tools in a wide variety of dimensions across many product areas – quickly and individually.

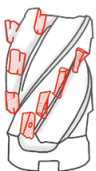

SPECIAL CUSTOM TOOLS & INDUSTRY-SPECIFIC TOOLS

As one of the leading tool manufacturers and innovative pulse generator in machining, we develop optimal tool concepts for you and develop special tools that are based on the most important success factors such as efficiency, time and quality.

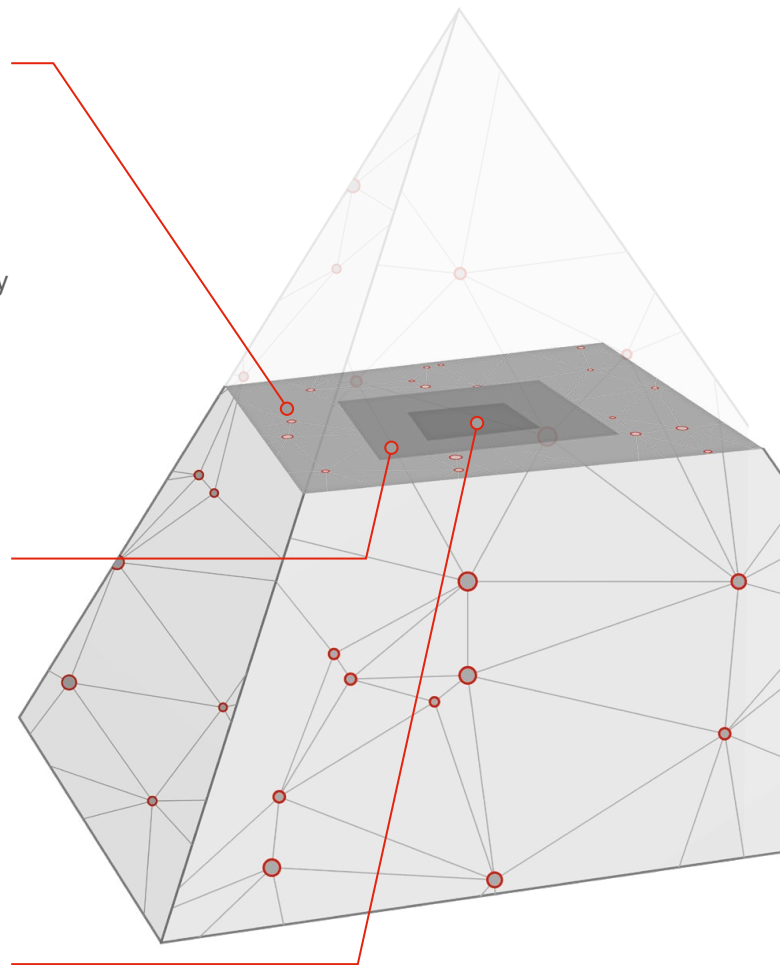

INNOVATIVE ORIENTATION

Machining at the highest technological level:

The Team Cutting Tools relies on future technologies such as the high-performance coating Dragonskin for best wear protection and up to 80 percent increased performance. Intelligent and customer-oriented digitization as well as sensor, monitoring and assistance systems make valuable contributions to constant, reliable process optimization.



TOOLSCOPE

Tool solutions with digital and sensory intelligence

FREETURN

The revolution in the turning process –
High Dynamic Turning with FreeTurn tools

ACTUATING TOOLS

The U-Axis system KOMtronic – efficient machining of
turning contours on non-rotationally symmetrical parts

ADDITIVE MANUFACTURING

3D printing compliments machining

DRAGONSKIN

The almost indestructible surface coating

TOOL-O-MAT

Tool „at the push of a button“ with the innovative
vending system





HIGHEST TECHNICAL COMPETENCE

Always up to date with market requirements thanks to individual technological support

Application technicians and industry experts from the Team Cutting Tools are not just at your side when it comes to tool instruction. In further training courses at our Technical Centres, we are happy to pass on our practical knowledge to you so that you are always up to date with the latest technology. Thanks to our regrinding, recycling and digital services as well as the CAD models, you can also produce more efficiently, easily, flexibly and in an environmentally friendly manner.

PERSONAL APPLICATION ENGINEER

Manufacturing consulting and process optimization on site

TOOL DATA

Cutting data and CAD models to assist you with your tool management or for simulating an operation

TECHNICAL TRAINING

Our engineers are provided with constant training to keep them up to speed on all technical matters. We will gladly share this knowledge with you. Use our Service for the further education of your metal cutting technicians in our Technical Centres.

SUSTAINABILITY

Solutions for forward thinking and economical metal cutting – e.g. Regrinding and Recycling

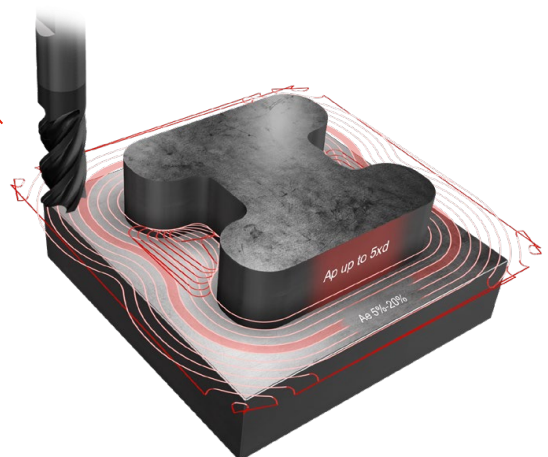



FAST AND EFFICIENT **AVAILABILITY**

The new portfolio: simple ways to new tools and service

With the most modern logistics center in Europe we ensure the shortest delivery times, with our Tool Supply 24/7 service for digitally simplified orders. The Tool-O-Mat, which can hold up to 840 different products, ensures that tools are ready when they are needed as a removal system on site. Payment is only made when withdrawn.

LOGISTICS AT THE HIGHEST LEVEL

A logistic center that can meet all requirements, 99 % delivery capacity with next day delivery, no minimum order quantity, custom logistic solutions for major customers.

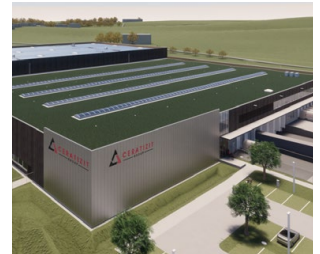

E-COMMERCE SOLUTIONS

Benefit from more product data and machining knowledge online, accelerate and optimize your tool procurement processes or create a direct connection to your ERP system.

3 WEEKS ON SPECIAL TOOLS

No time to lose? We deliver special tools within 3 weeks.

TOOL SUPPLY 24/7

We take over the complete procurement and storage process!

THE CATALOGUE FOR MACHINING

Extensive material from the main catalogue to industry catalogues and special promotions.

DEEP INDUSTRY KNOWLEDGE

Equipped for every industry sector:
our experts deliver comprehensive solutions!

Proven experts from numerous industrial sectors work in the Team Cutting Tools. Whether automotive and engines, aerospace, energy technology or heavy machining. We know from many years of experience all the challenges that every branch of industry brings – and we deliver the tailor-made solutions.

PROJECT ENGINEERING

Smart solution concepts for efficient machining processes

EXPERT KNOWLEDGE

More than 100 years engineering and manufacturing high performance cutting tools and developing the most optimal machining operations and processes for our customers.

INDUSTRY SPECIFIC TOOLS

Specific tools designed under the most demanding challenges of every industrial sector to increase the competitiveness of our customers.

INDIVIDUAL SPECIAL TOOLS

In partnership with the customer

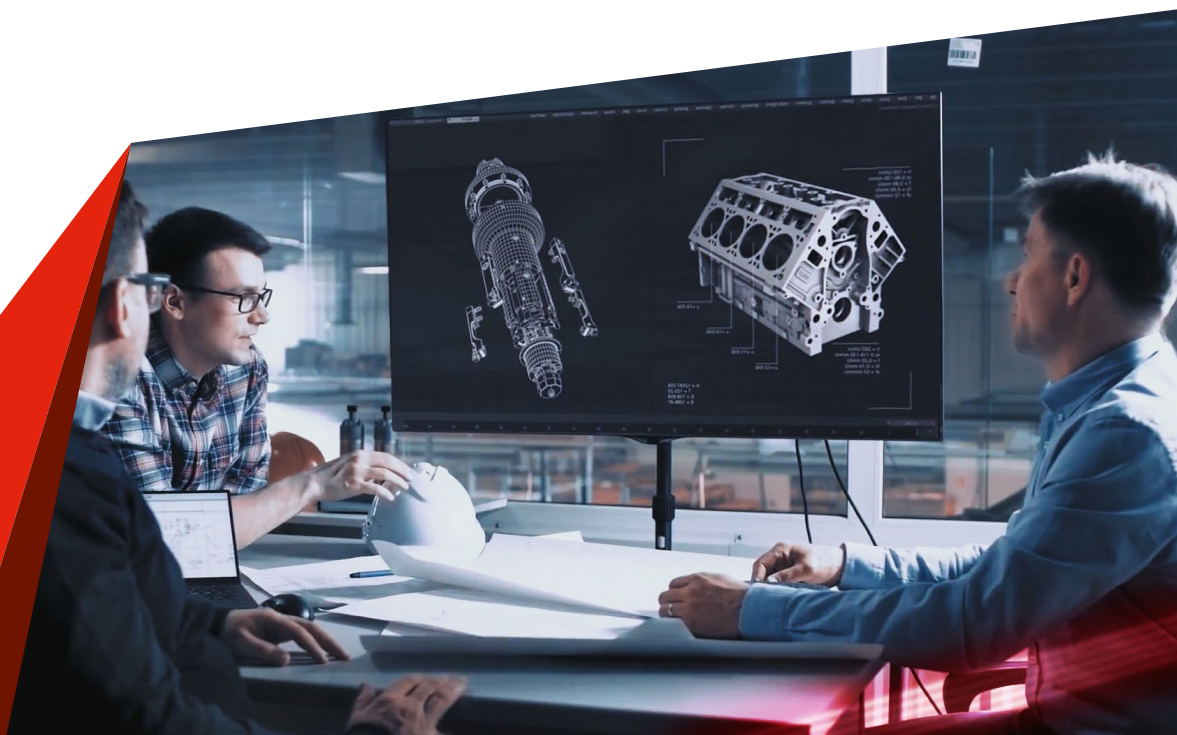



More options for sliding head turning with our new catalogue for sliding head tooling.

This catalogue gives you a good overview of the entire range of our tool portfolio especially for sliding head turning, perfectly tailored to specific needs, matched and tailored to the market.

In addition to the extensive selection of quality tools as a customer, you benefit from the high availability of these tools as well as the fast delivery. Also, our machining experts are at your disposal both in person and by phone for everyone, with technical expertise available to help your production process optimisation.

The catalogue for cutting tools

Additional tools for machining you can find in our online shop cuttingtools.ceratizit.com and in our main and clamping technology catalogue.



Solid drilling and bore machining

HSS drilling

Solid carbide drilling

Reamers

1

Threading

HSS taps

Circular and Thread Milling

Thread turning

2

Turning

Turning Tools

Multi-function tool – EcoCut

Grooving Tools

Miniature turning tools

3

Milling

Solid Carbide milling cutters

4

Workholding

Collets and reduction sleeves

5

Material examples and article no. index

6





Solid drilling and bore machining	HSS drilling	1
	Solid carbide drilling	
	Reamers	
Threading	HSS taps	2
	Circular and Thread Milling	
	Thread turning	
Turning	Turning Tools	3
	Multi-function tool - EcoCut	
	Grooving Tools	
	Miniature turning tools	
Milling	Solid Carbide milling cutters	4
Workholding	Collets and reduction sleeves	5
	Material examples and article no. index	6

Table of contents

Overview	2	Cutting Data	
Toolfinder	2	HSS cutting data	10-13
Symbol explanation	4	Solid carbide cutting data	33-42
List of contents		Reamer cutting data	70-78
HSS Drilling	5	Technical Information	
Solid Carbide Drilling	14+15	Solid Carbide Drilling	43-46
Reamers	47	Reamers	80
Product programme		Coatings	81
HSS Drilling	6-9		
Solid Carbide Drilling	16-32		
Reamers	48-69		

Overview



HSS Drilling

- ▲ Drill for universal application up to 10xD



Solid Carbide Drilling

- ▲ Selection of solid carbide drills and WTX drills
- ▲ High performance for universal application



Reamers

- ▲ HSS and solid carbide reaming from \varnothing 0.59 – 12 mm

Toolfinder

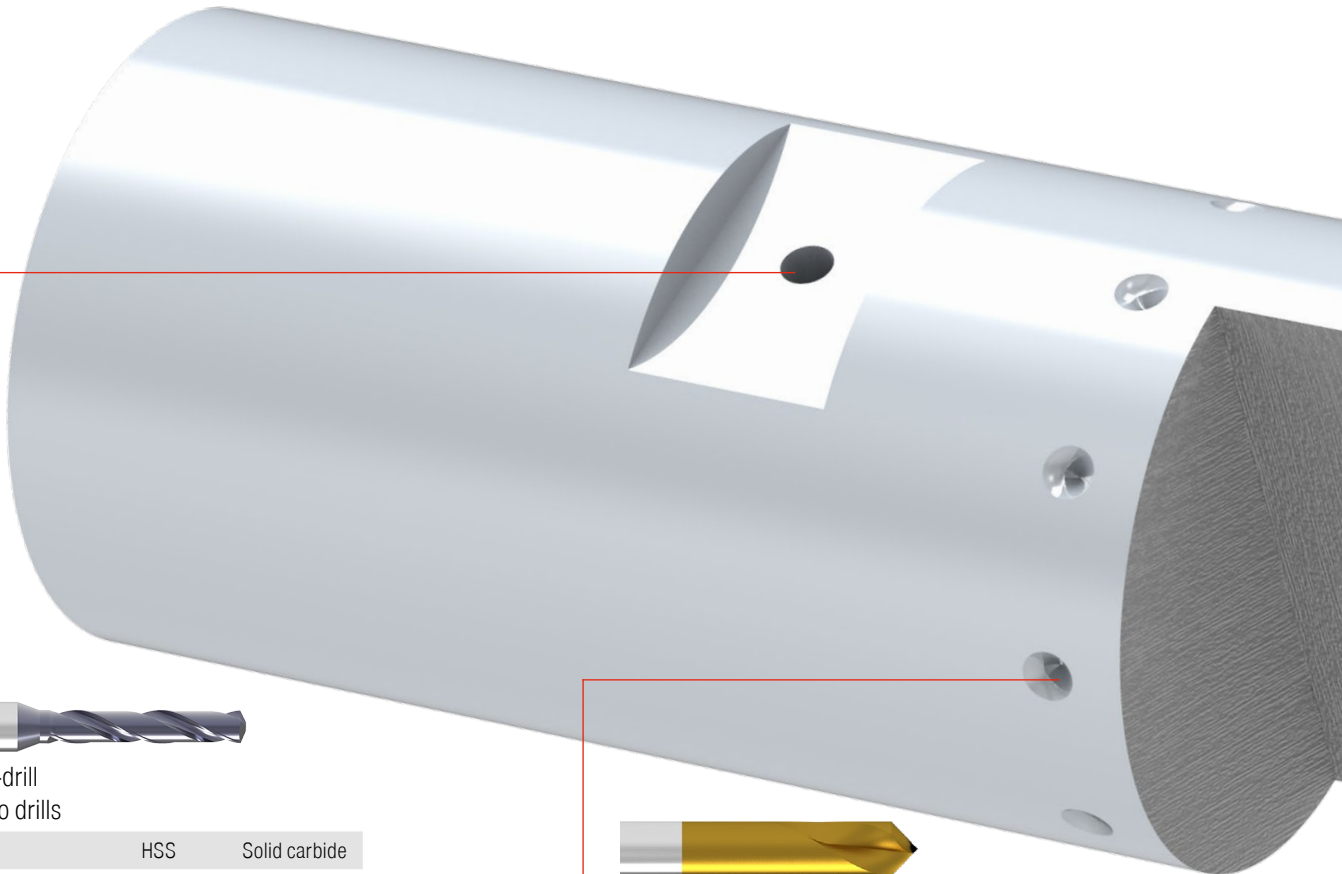

Mini-drill
Micro drills

	HSS	Solid carbide
DIN 1899	9	
5xD		29+30
8xD		30
12xD		31



NC Spot Drill

	HSS	Solid carbide
90°	9	32
120°	9	32

WNT \ Performance

Premium quality tools for high performance.

The premium quality tools from the **WNT Performance** product line have been designed for specific applications and are distinguished by their outstanding performance. If you make high demands on the performance of your production and want to achieve the very best results, we recommend the Premium tools in this product line.

WNT \ Standard

Quality tools for standard applications.

The quality tools of the **WNT Standard** product line are high quality, powerful and reliable and enjoy the highest trust of our customers worldwide. Tools from this product line are the first choice for many standard applications and guarantee optimal results.

KOMET \ Performance

Premium quality tools for high performance.

The premium quality tools from the **KOMET Performance** product line have been designed for specific applications and are distinguished by their outstanding performance. If you make high demands on the performance of your production and want to achieve the very best results, we recommend the Premium tools in this product line.

KOMET \ Standard

Quality tools for standard applications.

The quality tools of the **KOMET Standard** product line are high quality, high performance, reliable and enjoy the highest level of trust among our customers worldwide. Tools from this product line are the first choice for many standard applications and guarantee optimal results.



180° drills

Solid carbide	
3xD	21
5xD	28



Reamers

	HSS	Solid carbide
0,95-12,00	65-69	
0,59-12,05		48-64



Standard drills

	HSS	Solid carbide
3xD	6	16-20
5xD	7	22-27
10xD	8	

Symbol explanation



HSS drilling

Functional length Shank

≤ 10xD

DIN 1835
A

Point angle

◁ 130°

- = Main Application
- = Extended application



Solid carbide drilling

Functional length Shank

≤ 8xD

DIN 6535
HA

Version



Int. coolant supply



self-centering



Pilot hole necessary

Point angle

◁ 140°

- = Main Application
- = Extended application



Reamers

Shank

DIN 1835
A

DIN 6535
HA

Version



central internal coolant



lateral internal coolant

ZEFP = Number of flutes

- = Main Application
- = Extended application

HSS Drills Overview

Tool type	Material Coating	Point angle	Diameter in mm	Material	Coating	Performance
3xD without thro' coolant						
	UNI HSS-E TiN	118°	1-12	Steel P	Coated	6
	UNI HSS-E-PM TiN	130°	1-12	Stainless steel M, Cast iron K, Non-ferrous metals N, Heat-resistant S, Tempered steel H, Non metal materials O	Coated	6
5xD without thro' coolant						
	UNI HSS-E TiN	118°	0,9-12	Steel P	Coated	7
	UNI HSS-E-PM TiN	130°	1-12	Stainless steel M, Cast iron K, Non-ferrous metals N, Heat-resistant S, Tempered steel H, Non metal materials O	Coated	7
up to 10xD without thro' coolant						
	UNI HSS-E TiN	118°	1-12	Steel P	Coated	8
Mini-drill						
	N HSS-E-PM	118°	0,15-1,45	Steel P	Uncoated	9
NC Spot Drill						
	NC-A HSS TiN	90°	3-12	Steel P	Coated	9
	NC-A HSS TiN	120°	3-12	Steel P	Coated	9

Further dimensions and drills can be found in our → **main catalogue in Chapter 1 HSS drills**

High-performance twist drills similar to DIN 1897, extra-short

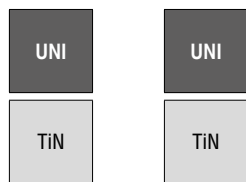
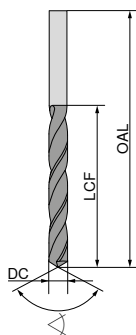
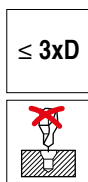

118° HSS-E 130° HSS-E-PM

DC _{hb} mm	DC inch	OAL mm	LCF mm	10 107 ...	10 113 ...
1.00		26	6	010 ¹⁾	010 ¹⁾
1.10		28	7	011 ¹⁾	011 ¹⁾
1.20		30	8	012 ¹⁾	012 ¹⁾
1.30		30	8	013 ¹⁾	013 ¹⁾
1.40		32	9	014 ¹⁾	014 ¹⁾
1.50		32	9	015 ¹⁾	015 ¹⁾
1.60		34	10	016 ¹⁾	016 ¹⁾
1.70		34	10	017 ¹⁾	017 ¹⁾
1.80		36	11	018 ¹⁾	018 ¹⁾
1.90		36	11	019 ¹⁾	019 ¹⁾
2.00		38	12	020 ¹⁾	020 ¹⁾
2.10		38	12	021 ¹⁾	021 ¹⁾
2.20		40	13	022 ¹⁾	022 ¹⁾
2.30		40	13	023 ¹⁾	023 ¹⁾
2.38	3/32	43	14	238 ¹⁾	238 ¹⁾
2.40		43	14	024 ¹⁾	024 ¹⁾
2.50		43	14	025 ¹⁾	025 ¹⁾
2.60		43	14	026 ¹⁾	026 ¹⁾
2.70		46	16	027 ¹⁾	027 ¹⁾
2.78	7/64	46	16	278 ¹⁾	278 ¹⁾
2.80		46	16	028 ¹⁾	028 ¹⁾
2.90		46	16	029 ¹⁾	029 ¹⁾
3.00		46	16	030 ¹⁾	030 ¹⁾
3.10		49	18	031 ¹⁾	031 ¹⁾
3.17	1/8	49	18	317 ¹⁾	317 ¹⁾
3.20		49	18	032 ¹⁾	032 ¹⁾
3.30		49	18	033 ¹⁾	033 ¹⁾
3.40		52	20	034 ¹⁾	034 ¹⁾
3.50		52	20	035 ¹⁾	035 ¹⁾
3.57	9/64	52	20	357 ¹⁾	357 ¹⁾
3.60		52	20	036 ¹⁾	036 ¹⁾
3.70		52	20	037 ¹⁾	037 ¹⁾
3.80		55	22	038 ¹⁾	038 ¹⁾
3.90		55	22	039 ¹⁾	039 ¹⁾
3.97	5/32	55	22	397 ¹⁾	397 ¹⁾
4.00		55	22	040 ¹⁾	040 ¹⁾
4.10		55	22	041 ¹⁾	041 ¹⁾
4.20		55	22	042 ¹⁾	042 ¹⁾
4.30		58	24	043 ¹⁾	043 ¹⁾
4.37	11/64	58	24	437 ¹⁾	437 ¹⁾
4.40		58	24	044 ¹⁾	044 ¹⁾
4.50		58	24	045 ¹⁾	045 ¹⁾
4.60		58	24	046 ¹⁾	046 ¹⁾
4.70		58	24	047 ¹⁾	047 ¹⁾
4.76	3/16	62	26	476 ¹⁾	476 ¹⁾
4.80		62	26	048 ¹⁾	048 ¹⁾
4.90		62	26	049 ¹⁾	049 ¹⁾
5.00		62	26	050 ¹⁾	050 ¹⁾
5.10		62	26	051 ¹⁾	051 ¹⁾
5.16	13/64	62	26	516 ¹⁾	516 ¹⁾
5.20		62	26	052 ¹⁾	052 ¹⁾
5.30		62	26	053 ¹⁾	053 ¹⁾
5.40		66	28	054 ¹⁾	054 ¹⁾
5.50		66	28	055 ¹⁾	055 ¹⁾
5.56	7/32	66	28	556 ¹⁾	556 ¹⁾

DC _{hb} mm	DC inch	OAL mm	LCF mm	10 107 ...	10 113 ...
5.60		66	28	056 ¹⁾	056 ¹⁾
5.70		66	28	057 ¹⁾	057 ¹⁾
5.80		66	28	058 ¹⁾	058 ¹⁾
5.90		66	28	059 ¹⁾	059 ¹⁾
5.95	15/64	66	28	595 ¹⁾	595 ¹⁾
6.00		66	28	060 ¹⁾	060 ¹⁾
6.10		70	31	061 ¹⁾	061 ¹⁾
6.20		70	31	062 ¹⁾	062 ¹⁾
6.30		70	31	063 ¹⁾	063 ¹⁾
6.35	1/4	70	31	635 ¹⁾	635 ¹⁾
6.40		70	31	064 ¹⁾	064 ¹⁾
6.50		70	31	065 ¹⁾	065 ¹⁾
6.60		70	31	066 ¹⁾	066 ¹⁾
6.70		70	31	067 ¹⁾	067 ¹⁾
6.75		74	34	0675 ¹⁾	0675 ¹⁾
6.80		74	34	068 ¹⁾	068 ¹⁾
6.90		74	34	069 ¹⁾	069 ¹⁾
7.00		74	34	070 ¹⁾	070 ¹⁾
7.10		74	34	071 ¹⁾	071 ¹⁾
7.14	9/32	74	34	714 ¹⁾	714 ¹⁾
7.20		74	34	072 ¹⁾	072 ¹⁾
7.30		74	34	073 ¹⁾	073 ¹⁾
7.40		74	34	074 ¹⁾	074 ¹⁾
7.50		74	34	075 ¹⁾	075 ¹⁾
7.60		79	37	076 ¹⁾	076 ¹⁾
7.70		79	37	077 ¹⁾	077 ¹⁾
7.80		79	37	078 ¹⁾	078 ¹⁾
7.90		79	37	079 ¹⁾	079 ¹⁾
7.94	5/16	79	37	794 ¹⁾	794 ¹⁾
8.00		79	37	080 ¹⁾	080 ¹⁾
8.10		79	37	081 ¹⁾	081 ¹⁾
8.20		79	37	082 ¹⁾	082 ¹⁾
8.30		79	37	083 ¹⁾	083 ¹⁾
8.40		79	37	084 ¹⁾	084 ¹⁾
8.50		79	37	085 ¹⁾	085 ¹⁾
8.60		84	40	086 ¹⁾	086 ¹⁾
8.70		84	40	087 ¹⁾	087 ¹⁾
8.73	11/32	84	40	873 ¹⁾	873 ¹⁾
8.80		84	40	088 ¹⁾	088 ¹⁾
8.90		84	40	089 ¹⁾	089 ¹⁾
9.00		84	40	090 ¹⁾	090 ¹⁾
9.10		84	40	091 ¹⁾	091 ¹⁾
9.20		84	40	092 ¹⁾	092 ¹⁾
9.30		84	40	093 ¹⁾	093 ¹⁾
9.40		84	40	094 ¹⁾	094 ¹⁾
9.50		84	40	095 ¹⁾	095 ¹⁾
9.60		89	43	096 ¹⁾	096 ¹⁾
9.70		89	43	097 ¹⁾	097 ¹⁾
9.80		89	43	098 ¹⁾	098 ¹⁾
9.90		89	43	099 ¹⁾	099 ¹⁾
10.00		89	43	100 ¹⁾	100 ¹⁾
10.10		89	43	101 ¹⁾	101 ¹⁾
10.20		89	43	102 ¹⁾	102 ¹⁾
10.30		89	43	103 ¹⁾	103 ¹⁾
10.40		89	43	104 ¹⁾	104 ¹⁾
10.50		89	43	105 ¹⁾	105 ¹⁾
11.00		95	47	110 ¹⁾	110 ¹⁾
11.11	7/16	95	47	111 ¹⁾	111 ¹⁾
11.50		95	47	115 ¹⁾	115 ¹⁾
12.00		102	51	120 ¹⁾	120 ¹⁾

P	●	●
M	●	●
K	●	●
N	○	○
S	○	○
H	○	○
O	○	○

1) self-centering

→ v_c Page 11

Twist drill to DIN 338, short

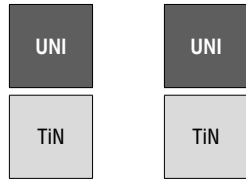
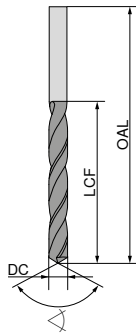

118° HSS-E 130° HSS-E-PM

10 171 ... 10 173 ...

DC _{h8} mm	DC inch	OAL mm	LCF mm	10 171 ...	10 173 ...
0.90		32	11	009 ¹⁾	
1.00		34	12	010 ¹⁾	010 ¹⁾
1.10		36	14	011 ¹⁾	011 ¹⁾
1.20		38	16	012 ¹⁾	012 ¹⁾
1.25		38	16	125 ¹⁾	
1.30		38	16	013 ¹⁾	013 ¹⁾
1.40		40	18	014 ¹⁾	014 ¹⁾
1.45		40	18	145 ¹⁾	
1.50		40	18	015 ¹⁾	015 ¹⁾
1.55		43	20	155 ¹⁾	
1.60		43	20	016 ¹⁾	016 ¹⁾
1.65		43	20	165 ¹⁾	
1.70		43	20	017 ¹⁾	017 ¹⁾
1.80		46	22	018 ¹⁾	018 ¹⁾
1.90		46	22	019 ¹⁾	019 ¹⁾
2.00		49	24	020 ¹⁾	020 ¹⁾
2.10		49	24	021 ¹⁾	021 ¹⁾
2.20		53	27	022 ¹⁾	022 ¹⁾
2.30		53	27	023 ¹⁾	023 ¹⁾
2.38	3/32	57	30	238 ¹⁾	238 ¹⁾
2.40		57	30	024 ¹⁾	024 ¹⁾
2.50		57	30	025 ¹⁾	025 ¹⁾
2.55		57	30	255 ¹⁾	
2.60		57	30	026 ¹⁾	026 ¹⁾
2.70		61	33	027 ¹⁾	027 ¹⁾
2.78	7/64	61	33	278 ¹⁾	278 ¹⁾
2.80		61	33	028 ¹⁾	028 ¹⁾
2.90		61	33	029 ¹⁾	029 ¹⁾
3.00		61	33	030 ¹⁾	030 ¹⁾
3.10		65	36	031 ¹⁾	031 ¹⁾
3.17	1/8	65	36	317 ¹⁾	317 ¹⁾
3.20		65	36	032 ¹⁾	032 ¹⁾
3.25		65	36	325 ¹⁾	
3.30		65	36	033 ¹⁾	033 ¹⁾
3.40		70	39	034 ¹⁾	034 ¹⁾
3.50		70	39	035 ¹⁾	035 ¹⁾
3.57	9/64	70	39	357 ¹⁾	357 ¹⁾
3.60		70	39	036 ¹⁾	036 ¹⁾
3.70		70	39	037 ¹⁾	037 ¹⁾
3.80		75	43	038 ¹⁾	038 ¹⁾
3.90		75	43	039 ¹⁾	039 ¹⁾
3.97	5/32	75	43	397 ¹⁾	397 ¹⁾
4.00		75	43	040 ¹⁾	040 ¹⁾
4.10		75	43	041 ¹⁾	041 ¹⁾
4.20		75	43	042 ¹⁾	042 ¹⁾
4.25		75	43	425 ¹⁾	
4.30		80	47	043 ¹⁾	043 ¹⁾
4.37	11/64	80	47	437 ¹⁾	437 ¹⁾
4.40		80	47	044 ¹⁾	044 ¹⁾
4.50		80	47	045 ¹⁾	045 ¹⁾
4.60		80	47	046 ¹⁾	046 ¹⁾
4.65		80	47	465 ¹⁾	
4.70		80	47	047 ¹⁾	047 ¹⁾
4.76	3/16	86	52	476 ¹⁾	476 ¹⁾
4.80		86	52	048 ¹⁾	048 ¹⁾
4.90		86	52	049 ¹⁾	049 ¹⁾
4.95		86	52	495 ¹⁾	
5.00		86	52	050 ¹⁾	050 ¹⁾
5.05		86	52	505 ¹⁾	
5.10		86	52	051 ¹⁾	051 ¹⁾
5.16	13/64	86	52	516 ¹⁾	516 ¹⁾

DC _{h8} mm	DC inch	OAL mm	LCF mm	10 171 ...	10 173 ...
5.20		86	52	052 ¹⁾	052 ¹⁾
5.30		86	52	053 ¹⁾	053 ¹⁾
5.40		93	57	054 ¹⁾	054 ¹⁾
5.50		93	57	055 ¹⁾	055 ¹⁾
5.55		93	57	555 ¹⁾	
5.56	7/32	93	57	556 ¹⁾	556 ¹⁾
5.60		93	57	056 ¹⁾	056 ¹⁾
5.70		93	57	057 ¹⁾	057 ¹⁾
5.75		93	57	575 ¹⁾	
5.80		93	57	058 ¹⁾	058 ¹⁾
5.90		93	57	059 ¹⁾	059 ¹⁾
5.95	15/64	93	57	595 ¹⁾	595 ¹⁾
6.00		93	57	060 ¹⁾	060 ¹⁾
6.10		101	63	061 ¹⁾	061 ¹⁾
6.20		101	63	062 ¹⁾	062 ¹⁾
6.30		101	63	063 ¹⁾	063 ¹⁾
6.35	1/4	101	63	635 ¹⁾	635 ¹⁾
6.40		101	63	064 ¹⁾	064 ¹⁾
6.50		101	63	065 ¹⁾	065 ¹⁾
6.60		101	63	066 ¹⁾	066 ¹⁾
6.70		101	63	067 ¹⁾	067 ¹⁾
6.75		109	69	675 ¹⁾	675 ¹⁾
6.80		109	69	068 ¹⁾	068 ¹⁾
6.90		109	69	069 ¹⁾	069 ¹⁾
7.00		109	69	070 ¹⁾	070 ¹⁾
7.10		109	69	071 ¹⁾	071 ¹⁾
7.14	9/32	109	69	714 ¹⁾	714 ¹⁾
7.20		109	69	072 ¹⁾	072 ¹⁾
7.30		109	69	073 ¹⁾	073 ¹⁾
7.40		109	69	074 ¹⁾	074 ¹⁾
7.45		109	69	745 ¹⁾	
7.50		109	69	075 ¹⁾	075 ¹⁾
7.60		117	75	076 ¹⁾	076 ¹⁾
7.70		117	75	077 ¹⁾	077 ¹⁾
7.80		117	75	078 ¹⁾	078 ¹⁾
7.90		117	75	079 ¹⁾	079 ¹⁾
7.94	5/16	117	75	794 ¹⁾	794 ¹⁾
8.00		117	75	080 ¹⁾	080 ¹⁾
8.10		117	75	081 ¹⁾	081 ¹⁾
8.20		117	75	082 ¹⁾	082 ¹⁾
8.30		117	75	083 ¹⁾	083 ¹⁾
8.40		117	75	084 ¹⁾	084 ¹⁾
8.50		117	75	085 ¹⁾	085 ¹⁾
8.60		125	81	086 ¹⁾	
8.70		125	81	087 ¹⁾	
8.73	11/32	125	81	873 ¹⁾	873 ¹⁾
8.80		125	81	088 ¹⁾	088 ¹⁾
8.90		125	81	089 ¹⁾	
9.00		125	81	090 ¹⁾	090 ¹⁾
9.10		125	81	091 ¹⁾	
9.20		125	81	092 ¹⁾	
9.30		125	81	093 ¹⁾	093 ¹⁾
9.35		125	81	935 ¹⁾	
9.40		125	81	094 ¹⁾	
9.50		125	81	095 ¹⁾	095 ¹⁾
9.60		133	87	096 ¹⁾	
9.70		133	87	097 ¹⁾	
9.80		133	87	098 ¹⁾	098 ¹⁾
9.90		133	87	099 ¹⁾	
10.00		133	87	100 ¹⁾	100 ¹⁾
10.10		133	87	101 ¹⁾	
10.20		133	87	102 ¹⁾	102 ¹⁾
10.30		133	87	103 ¹⁾	
10.40		133	87	104 ¹⁾	
10.50		133	87	105 ¹⁾	105 ¹⁾
10.55		133	87	955 ¹⁾	
11.00		142	94	110 ¹⁾	110 ¹⁾
11.11	7/16	142	94	111 ¹⁾	111 ¹⁾
11.20		142	94	112 ¹⁾	
11.30		142	94	113 ¹⁾	
11.40		142	94	114 ¹⁾	
11.50		142	94	115 ¹⁾	115 ¹⁾
11.60		142	94	116 ¹⁾	
12.00		151	101	120 ¹⁾	120 ¹⁾

P	●	●
M	●	●
K	●	●
N	○	○
S	○	○
H	○	○
O	○	○

1) self-centering → v_c Page 11

Twist drills, DIN 340, long

≤ 10xD

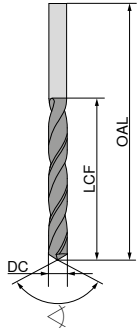

UNI

TiN



118°
HSS-E

10 270 ...

DC _{hb} mm	OAL mm	LCF mm	
1.0	56	33	010
1.1	60	37	011
1.2	65	41	012
1.3	65	41	013
1.4	70	45	014
1.5	70	45	015
1.6	76	50	016
1.7	76	50	017
1.8	80	53	018
1.9	80	53	019
2.0	85	56	020
2.1	85	56	021
2.2	90	59	022
2.3	90	59	023
2.4	95	62	024
2.5	95	62	025
2.6	95	62	026
2.7	100	66	027
2.8	100	66	028
2.9	100	66	029
3.0	100	66	030
3.1	106	69	031
3.2	106	69	032
3.3	106	69	033
3.4	112	73	034
3.5	112	73	035
3.6	112	73	036
3.7	112	73	037
3.8	119	78	038
3.9	119	78	039
4.0	119	78	040
4.1	119	78	041
4.2	119	78	042
4.3	126	82	043
4.4	126	82	044
4.5	126	82	045
4.6	126	82	046
4.7	126	82	047
4.8	132	87	048
4.9	132	87	049
5.0	132	87	050
5.1	132	87	051
5.2	132	87	052
5.3	132	87	053
5.4	139	91	054
5.5	139	91	055
5.6	139	91	056
5.7	139	91	057
5.8	139	91	058
5.9	139	91	059
6.0	139	91	060
6.1	148	97	061
6.2	148	97	062
6.3	148	97	063
6.4	148	97	064
6.5	148	97	065
6.6	148	97	066
6.7	148	97	067
6.8	156	102	068
6.9	156	102	069
7.0	156	102	070
7.1	156	102	071

10 270 ...

DC _{hb} mm	OAL mm	LCF mm	
7.2	156	102	072
7.3	156	102	073
7.4	156	102	074
7.5	156	102	075
7.6	165	109	076
7.7	165	109	077
7.8	165	109	078
7.9	165	109	079
8.0	165	109	080
8.1	165	109	081
8.2	165	109	082
8.3	165	109	083
8.4	165	109	084
8.5	165	109	085
8.6	175	115	086
8.7	175	115	087
8.8	175	115	088
8.9	175	115	089
9.0	175	115	090
9.1	175	115	091
9.2	175	115	092
9.3	175	115	093
9.4	175	115	094
9.5	175	115	095
9.6	184	121	096
9.7	184	121	097
9.8	184	121	098
9.9	184	121	099
10.0	184	121	100
10.1	184	121	101
10.2	184	121	102
10.3	184	121	103
10.4	184	121	104
10.5	184	121	105
11.0	195	128	110
11.5	195	128	115
12.0	205	134	120

P	●
M	●
K	●
N	○
S	○
H	
O	○

→ v_c Page 11

Twist drills, DIN 1899

- ▲ 4 facet
- ▲ with reinforced shank

Scope of supply:

- ▲ Pack quantity 5 pieces
- ▲ price per piece

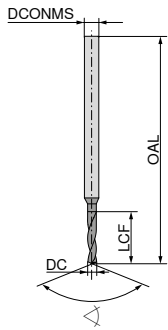

118°
HSS-E-PM

10 103 ...

DC _{-0,004} mm	OAL mm	LCF mm	DCONMS _{h8} mm	
0.15	25	0.8	1.0	00150
0.20	25	1.5	1.0	00200
0.25	25	1.9	1.0	00250
0.30	25	1.9	1.0	00300
0.35	25	2.4	1.0	00350
0.40	25	3.0	1.0	00400
0.45	25	3.0	1.0	00450
0.50	25	3.4	1.0	00500
0.55	25	3.9	1.0	00550
0.60	25	3.9	1.0	00600
0.65	25	4.2	1.0	00650
0.70	25	4.8	1.0	00700
0.75	25	4.8	1.0	00750
0.80	25	5.3	1.5	00800
0.85	25	5.3	1.5	00850
0.90	25	6.0	1.5	00900
0.95	25	6.0	1.5	00950
1.00	25	6.8	1.5	01000
1.05	25	6.8	1.5	01050
1.10	25	7.6	1.5	01100
1.15	25	7.6	1.5	01150
1.20	25	8.5	1.5	01200
1.25	25	8.5	1.5	01250
1.30	25	8.5	1.5	01300
1.35	25	9.5	1.5	01350
1.40	25	9.5	1.5	01400
1.45	25	9.5	1.5	01450

P	●
M	○
K	●
N	●
S	○
H	
O	○

→ v_c Page 12

NC spot drills, factory standard

- ▲ helical flutes

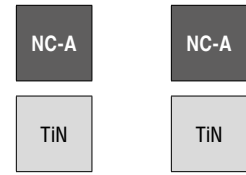
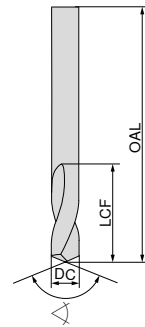

Right-hand
90°
HSS

10 522 ...



Left-hand
120°
HSS

10 512 ...

DC _{h6} mm	OAL mm	LCF mm		
3	46	12	030	030
4	55	12	040	040
5	62	14	050	050
6	66	16	060	060
8	79	21	080	080
10	89	25	100	100
12	102	30	120	120
P			25-55	25-55
M			20	20
K			30-55	30-55
N			65-85	65-85
S				
H				
O				

Material examples for cutting data tables

	Material sub-group	Index	Composition / Structure / Heat treatment	Tensile strength N/mm ² / HB / HRC	Material number	Material designation	Material number	Material designation
P	Unalloyed steel	P.1.1	< 0,15 % C Annealed	420 N/mm ² / 125 HB	1.0401	C15	1.1141	Ck15
		P.1.2	< 0,45 % C Annealed	640 N/mm ² / 190 HB	1.1191	C45E	1.0718	9SMnPb28
		P.1.3	< 0,45 % C Tempered	840 N/mm ² / 250 HB	1.1191	C45E	1.0535	C55
		P.1.4	< 0,75 % C Annealed	910 N/mm ² / 270 HB	1.1223	C60R	1.0535	C55
		P.1.5	< 0,75 % C Tempered	1010 N/mm ² / 300 HB	1.1223	C60R	1.0727	45S20
	Low-alloy steel	P.2.1	Annealed	610 N/mm ² / 180 HB	1.7131	16MnCr5	1.6587	17CrNiMo6
		P.2.2	Tempered	930 N/mm ² / 275 HB	1.7131	16MnCr5	1.6587	17CrNiMo6
		P.2.3	Tempered	1010 N/mm ² / 300 HB	1.7225	42CrMo4	1.3505	100Cr6
		P.2.4	Tempered	1200 N/mm ² / 375 HB	1.7225	42CrMo4	1.3505	100Cr6
	High-alloy steel and high-alloy tool steel	P.3.1	Annealed	680 N/mm ² / 200 HB	1.4021	X20Cr13	1.4034	X46Cr13
		P.3.2	Hardened and tempered	1100 N/mm ² / 300 HB	1.2343	X38CrMoV5-1	1.4034	X46Cr13
		P.3.3	Hardened and tempered	1300 N/mm ² / 400 HB	1.2343	X38CrMoV5-1	1.4034	X46Cr13
	Stainless steel	P.4.1	Ferritic / martensitic Annealed	680 N/mm ² / 200 HB	1.4016	X6Cr17	1.2316	X36CrMo16
		P.4.2	Martensitic Tempered	1010 N/mm ² / 300 HB	1.4112	X90CrMoV18	1.2316	X36CrMo16
M	Stainless steel	M.1.1	Austenitic / austenitic-ferritic Quenched	610 N/mm ² / 180 HB	1.4301	X5CrNi18-10	1.4571	X6CrNiMoTi17-12-2
		M.2.1	Austenitic Tempered	300 HB	1.4841	X15CrNiSi25-21	1.4539	X1NiCrMoCu25-20-5
		M.3.1	Austenitic / ferritic (Duplex)	780 N/mm ² / 230 HB	1.4462	X2CrNiMoN22-5-3	1.4501	X2CrNiMoCuWN25-7-4
K	Grey cast iron	K.1.1	Pearlitic / ferritic	350 N/mm ² / 180 HB	0.6010	GG-10	0.6025	GG-25
		K.1.2	Pearlitic (martensitic)	500 N/mm ² / 260 HB	0.6030	GG-30	0.6045	GG-45
	Spherulitic graphite cast iron	K.2.1	Ferritic	540 N/mm ² / 160 HB	0.7040	GGG-40	0.7060	GGG-60
		K.2.2	Pearlitic	845 N/mm ² / 250 HB	0.7070	GGG-70	0.7080	GGG-80
	Malleable iron	K.3.1	Ferritic	440 N/mm ² / 130 HB	0.8035	GTW-35-04	0.8045	GTW-45
		K.3.2	Pearlitic	780 N/mm ² / 230 HB	0.8165	GTS-65-02	0.8170	GTS-70-02
N	Aluminium wrought alloy	N.1.1	Non-hardenable	60 HB	3.0255	Al99,5	3.3315	AlMg1
		N.1.2	Hardenable Age-hardened	340 N/mm ² / 100 HB	3.1355	AlCuMg2	3.2315	AlMgSi1
	Cast aluminium alloy	N.2.1	≤ 12 % Si, non-hardenable	250 N/mm ² / 75 HB	3.2581	G-AlSi12	3.2163	G-AlSi9Cu3
		N.2.2	≤ 12 % Si, hardenable Age-hardened	300 N/mm ² / 90 HB	3.2134	G-AlSi5Cu1Mg	3.2373	G-AlSi9Mg
		N.2.3	> 12 % Si, non-hardenable	440 N/mm ² / 130 HB		G-AlSi17Cu4Mg		G-AlSi18CuNiMg
	Copper and copper alloys (bronze/brass)	N.3.1	Free-machining alloys, PB > 1 %	375 N/mm ² / 110 HB	2.0380	CuZn39Pb2 (Ms58)	2.0410	CuZn44Pb2
		N.3.2	CuZn, CuSnZn	300 N/mm ² / 90 HB	2.0331	CuZn15	2.4070	CuZn28Sn1As
		N.3.3	CuSn, lead-free copper and electrolytic copper	340 N/mm ² / 100 HB	2.0060	E-Cu57	2.0590	CuZn40Fe
Magnesium alloys	N.4.1	Magnesium and magnesium alloys	70 HB	3.5612	MgAl6Zn	3.5312	MgAl3Zn	
S	Heat-resistant alloys	S.1.1	Fe - basis Annealed	680 N/mm ² / 200 HB	1.4864	X12NiCrSi 36-16	1.4865	G-X40NiCrSi38-18
		S.1.2	Fe - basis Age-hardened	950 N/mm ² / 280 HB	1.4980	X6NiCrTiMoVB25-15-2	1.4876	X10NiCrAlTi32-20
		S.2.1	Ni or Co basis Annealed	840 N/mm ² / 250 HB	2.4631	NiCr20TiAl (Nimonic80A)	3.4856	NiCr22Mo9Nb
		S.2.2	Ni or Co basis Age-hardened	1180 N/mm ² / 350 HB	2.4668	NiCr19Nb5Mo3 (Inconel 718)	2.4955	NiFe25Cr20NbTi
		S.2.3	Ni or Co basis Cast	1080 N/mm ² / 320 HB	2.4765	CoCr20W15Ni	1.3401	G-X120Mn12
	Titanium alloys	S.3.1	Pure titanium	400 N/mm ²	3.7025	Ti99,8	3.7034	Ti99,7
		S.3.2	Alpha + beta alloys Age-hardened	1050 N/mm ² / 320 HB	3.7165	TiAl6V4	Ti-6246	Ti-6Al-2Sn-4Zr-6Mo
S.3.3	Beta alloys	1400 N/mm ² / 410 HB	Ti555.3	Ti-5Al-5V-5Mo-3Cr	R56410	Ti-10V-2Fe-3Al		
H	Hardened steel	H.1.1	Hardened and tempered	46-55 HRC				
		H.1.2	Hardened and tempered	56-60 HRC				
		H.1.3	Hardened and tempered	61-65 HRC				
		H.1.4	Hardened and tempered	66-70 HRC				
	Chilled iron	H.2.1	Cast	400 HB				
	Hardened cast iron	H.3.1	Hardened and tempered	55 HRC				
O	Non-metal materials	O.1.1	Plastics, duroplastic	≤ 150 N/mm ²				
		O.1.2	Plastics, thermoplastic	≤ 100 N/mm ²				
		O.2.1	Aramid fibre-reinforced	≤ 1000 N/mm ²				
		O.2.2	Glass/carbon-fibre reinforced	≤ 1000 N/mm ²				
		O.3.1	Graphite					

* Tensile strength

Cutting data standard values

Index	Drilling depth 3xD				Drilling depth 5xD				Hole depth 10xD	
	Type UNI-TiN 10 107 ...		Type UNI-PM-TiN 10 113 ...		Type UNI-TiN 10 171 ...		Type UNI-PM-TiN 10 173 ...		Type UNI-TiN 10 270 ...	
	v_c in m/min	F	v_c in m/min	F	v_c in m/min	F	v_c in m/min	F	v_c in m/min	F
P.1.1	46	6	44	6	46	6	44	6	41	6
P.1.2	39	5	37	5	39	5	37	5	35	5
P.1.3	35	5	33	5	35	5	33	5	31	5
P.1.4	32	5	31	5	32	5	31	5	29	5
P.1.5	28	5	26	5	28	5	26	5	25	5
P.2.1	35	5	32	6	35	5	32	6	31	5
P.2.2	24	4	23	5	24	4	23	5	22	4
P.2.3	21	4	19	5	21	4	19	5	19	4
P.2.4	19	3	18	4	19	3	18	4	17	3
P.3.1	17	4	21	4	17	4	21	4	16	4
P.3.2	13	3	16	3	13	3	16	3	12	3
P.3.3	12	3	15	3	12	3	15	3	10	2
P.4.1	18	4	14	3	18	4	14	3	16	4
P.4.2	17	3	14	2	17	3	14	2	15	3
M.1.1	15	4			15	4			13	4
M.2.1	12	3			14	4			8	3
M.3.1	10	3			10	3			9	3
K.1.1	41	6	46	6	41	6	46	6	37	6
K.1.2	33	6	37	6	33	6	37	6	30	6
K.2.1	35	6	39	6	35	6	39	6	32	6
K.2.2	27	5	30	5	27	5	30	5	24	5
K.3.1	35	6	39	6	35	6	39	6	32	6
K.3.2	27	5	30	5	27	5	30	5	24	5
N.1.1										
N.1.2										
N.2.1	75	6	69	6	75	6	69	6	67	6
N.2.2	60	5	55	5	60	5	55	5	54	5
N.2.3	52	5	48	5	52	5	48	5	47	5
N.3.1	69	5	64	5	69	5	64	5	62	5
N.3.2	41	4	39	4	41	4	39	4	37	4
N.3.3	55	4	52	4	55	4	52	4	50	4
N.4.1	70	5	60	5	70	6	65	6	50	6
S.1.1			7	2			7	2		
S.1.2			6	1			6	1		
S.2.1			6	2			6	2		
S.2.2										
S.2.3										
S.3.1	9	2			9	2			8	2
S.3.2	6	1			6	1			5	1
S.3.3										
H.1.1			6	1			6	1		
H.1.2										
H.1.3										
H.1.4										
H.2.1			10	3			10	3		
H.3.1										
O.1.1	29	4	23	4	29	4	23	4	26	4
O.1.2	29	4			29	4			26	4
O.2.1	29	4	23	4	29	4	23	4	26	4
O.2.2	29	4	23	4	29	4	23	4	26	4
O.3.1										



The cutting data depends extremely on the external conditions, e.g. stability of the tool and tool clamping, material and machine type. The indicated values are possible cutting data which have to be increased or reduced according to the application conditions.



When drilling tough materials which tend to jam, chips should be removed at drilling depth $\geq 4xD$ and the cutting speed v_c should be reduced as follows: at drilling depths $> 4xD$ by 10 %, at drilling depths $> 6xD$ by 15–20 %. It is also recommended to use an emulsion for cooling.

Cutting data standard values – micro drills 10 103 ...

Index	v _c in m/min	Nominal Ø in mm						
		Ø 0,15	Ø 0,20–0,25	Ø 0,30–0,35	Ø 0,40–0,55	Ø 0,60–0,75	Ø 0,80–0,95	Ø 1,00–1,45
		f mm/rev.	f mm/rev.	f mm/rev.	f mm/rev.	f mm/rev.	f mm/rev.	f mm/rev.
P.1.1	33	0,0090	0,0110	0,0150	0,0190	0,0260	0,0310	0,0500
P.1.2	28	0,0070	0,0090	0,0110	0,0140	0,0200	0,0240	0,0410
P.1.3	25	0,0070	0,0090	0,0110	0,0140	0,0200	0,0240	0,0410
P.1.4	23	0,0070	0,0090	0,0110	0,0140	0,0200	0,0240	0,0410
P.1.5	20	0,0070	0,0090	0,0110	0,0140	0,0200	0,0240	0,0410
P.2.1	20	0,0050	0,0070	0,0090	0,0110	0,0150	0,0200	0,0350
P.2.2	14	0,0040	0,0050	0,0070	0,0080	0,0120	0,0160	0,0290
P.2.3	12	0,0040	0,0050	0,0070	0,0080	0,0120	0,0160	0,0290
P.2.4	11	0,0030	0,0040	0,0050	0,0070	0,0090	0,0130	0,0240
P.3.1	15	0,0050	0,0070	0,0090	0,0110	0,0150	0,0200	0,0350
P.3.2	11	0,0040	0,0050	0,0070	0,0080	0,0120	0,0160	0,0290
P.3.3	10	0,0040	0,0050	0,0070	0,0080	0,0120	0,0160	0,0290
P.4.1	11	0,0040	0,0050	0,0070	0,0080	0,0120	0,0160	0,0290
P.4.2	10	0,0030	0,0040	0,0050	0,0070	0,0090	0,0130	0,0240
M.1.1	9	0,0040	0,0050	0,0070	0,0080	0,0120	0,0160	0,0290
M.2.1	8	0,0040	0,0050	0,0070	0,0080	0,0120	0,0160	0,0290
M.3.1								
K.1.1	35	0,0090	0,0110	0,0150	0,0190	0,0260	0,0310	0,0500
K.1.2	28	0,0090	0,0110	0,0150	0,0190	0,0260	0,0310	0,0500
K.2.1	30	0,0090	0,0110	0,0150	0,0190	0,0260	0,0310	0,0500
K.2.2	23	0,0070	0,0090	0,0110	0,0140	0,0200	0,0240	0,0410
K.3.1	30	0,0090	0,0110	0,0150	0,0190	0,0260	0,0310	0,0500
K.3.2	23	0,0070	0,0090	0,0110	0,0140	0,0200	0,0240	0,0410
N.1.1	70	0,0120	0,0140	0,0190	0,0240	0,0340	0,0380	0,0600
N.1.2	70	0,0120	0,0140	0,0190	0,0240	0,0340	0,0380	0,0600
N.2.1	59	0,0090	0,0110	0,0150	0,0190	0,0260	0,0310	0,0500
N.2.2	47	0,0070	0,0090	0,0110	0,0140	0,0200	0,0240	0,0410
N.2.3	41	0,0070	0,0090	0,0110	0,0140	0,0200	0,0240	0,0410
N.3.1	70	0,0070	0,0090	0,0110	0,0140	0,0200	0,0240	0,0410
N.3.2	42	0,0050	0,0070	0,0090	0,0110	0,0150	0,0200	0,0350
N.3.3	56	0,0050	0,0070	0,0090	0,0110	0,0150	0,0200	0,0350
N.4.1	42	0,0070	0,0090	0,0110	0,0140	0,0200	0,0240	0,0410
S.1.1	7	0,0030	0,0040	0,0050	0,0070	0,0090	0,0130	0,0240
S.1.2	6	0,0020	0,0030	0,0040	0,0050	0,0070	0,0100	0,0200
S.2.1	6	0,0030	0,0040	0,0050	0,0070	0,0090	0,0130	0,0240
S.2.2	4	0,0020	0,0030	0,0040	0,0050	0,0070	0,0100	0,0200
S.2.3	4	0,0020	0,0030	0,0040	0,0050	0,0070	0,0100	0,0200
S.3.1	6	0,0030	0,0040	0,0050	0,0070	0,0090	0,0130	0,0240
S.3.2	4	0,0020	0,0030	0,0040	0,0050	0,0070	0,0100	0,0200
S.3.3								
H.1.1								
H.1.2								
H.1.3								
H.1.4								
H.2.1								
H.3.1								
O.1.1	23	0,0070	0,0090	0,0110	0,0140	0,0200	0,0240	0,0410
O.1.2	23	0,0070	0,0090	0,0110	0,0140	0,0200	0,0240	0,0410
O.2.1	23	0,0070	0,0090	0,0110	0,0140	0,0200	0,0240	0,0410
O.2.2	23	0,0070	0,0090	0,0110	0,0140	0,0200	0,0240	0,0410
O.3.1								



The cutting data depends extremely on the external conditions, e.g. stability of the tool and tool clamping, material and machine type. The indicated values are possible cutting data which have to be increased or reduced according to the application conditions.

Feed rate guide values for HSS twist drills

Factor F	Drill diameter in mm															
	0,5	1	2	3	4	5	6	8	10	12	14	16	18	20	26	30
	Feed rate f in mm/rev.															
1	0,004	0,006	0,02	0,03	0,04	0,04	0,05	0,06	0,08	0,08	0,09	0,1	0,12	0,15	0,18	0,19
2	0,006	0,008	0,02	0,03	0,05	0,05	0,05	0,08	0,1	0,1	0,1	0,12	0,12	0,2	0,2	0,2
3	0,007	0,012	0,03	0,05	0,06	0,069	0,08	0,1	0,12	0,13	0,13	0,16	0,16	0,25	0,25	0,25
4	0,008	0,014	0,04	0,06	0,08	0,09	0,1	0,14	0,16	0,16	0,16	0,2	0,2	0,3	0,3	0,3
5	0,01	0,016	0,06	0,08	0,1	0,12	0,13	0,16	0,2	0,2	0,22	0,25	0,25	0,4	0,4	0,4
6	0,012	0,018	0,06	0,1	0,12	0,14	0,16	0,2	0,25	0,25	0,25	0,3	0,3	0,5	0,5	0,5
7	0,014	0,02	0,08	0,13	0,16	0,18	0,2	0,25	0,35	0,35	0,35	0,4	0,4	0,6	0,6	0,6
8	0,016	0,023	0,1	0,16	0,2	0,2	0,25	0,35	0,4	0,4	0,4	0,4	0,5	0,6	0,7	0,8
9	0,019	0,025	0,13	0,17	0,2	0,23	0,32	0,4	0,4	0,5	0,5	0,5	0,6	0,8	0,9	0,9

 All the indicated data are guide values only and represent average values.

Speed for HSS drills

v _c m/min	Drill diameter in mm																
	2,0	2,5	3,15	4,0	5,0	6,3	8,0	10,0	12,5	16,0	20,0	25,0	31,5	40,0	50,0	63,0	80,0
	Speed in U/min																
80	12500	10000	8000	6300	5000	4000	3200	2500	2000	1600	1250	1000	800	630	500	400	320
63	10000	8000	6300	5000	4000	3200	2500	2000	1600	1250	1000	800	630	500	400	320	250
50	8000	6300	5000	4000	3200	2500	2000	1600	1250	1000	800	630	500	400	320	250	200
40	6300	5000	4000	3200	2500	2000	1600	1250	1000	800	630	500	400	320	250	200	160
32	5000	4000	3200	2500	2000	1600	1250	1000	800	630	500	400	320	250	200	160	125
25	4000	3200	2500	2000	1600	1250	1000	800	630	500	400	320	250	200	160	125	100
20	3200	2500	2000	1600	1250	1000	800	630	500	400	320	250	200	160	125	100	80
16	2500	2000	1600	1250	1000	800	630	500	400	320	250	200	160	125	100	80	63
12	2000	1600	1250	1000	800	630	500	400	320	250	200	160	125	100	80	63	50
10	1600	1250	1000	800	630	500	400	320	250	200	160	125	100	80	63	50	40
8	1250	1000	800	630	500	400	320	250	200	160	125	100	80	63	50	40	32
6	1000	800	630	500	400	320	250	200	160	125	100	80	63	50	40	32	25
5	800	630	500	400	320	250	200	160	125	100	80	63	50	40	32	25	20
4	630	500	400	320	250	200	160	125	100	80	63	50	40	32	25	20	16
3	500	400	320	250	200	160	125	100	80	63	50	40	32	25	20	16	12

Peck frequency for deep drilling

- ▲ Drill must be sufficiently cooled
- ▲ By use of a drill with flat chip gullet profile (type WTL) chip transport is substantially improved
- ▲ For extremely deep drilling or when machining horizontally through coolant drills with internal coolant supply are recommended

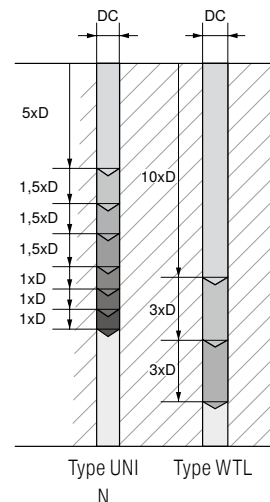











Solid carbide drills overview

	Product name	Tool type	Length	Diameter in mm Ø DC	Material	Coating	Performance	Standard	
					Steel P Stainless steel M Cast iron K Non-ferrous metals N Heat-resistant S Tempered steel H Non metal materials O	<input checked="" type="checkbox"/> coated <input type="checkbox"/> uncoated	WNT \ Performance WNT \ Standard		
3xD without thro' coolant									
	WTX	UNI	≤ 3xD	3-12	● ● ● ● ● ○	<input checked="" type="checkbox"/>	16		
	WPC	UNI	≤ 3xD	1-12	● ● ● ● ● ○	<input checked="" type="checkbox"/>	17		
3xD with thro' coolant									
	WTX	UNI	≤ 3xD	3-12	● ● ● ● ● ○	<input checked="" type="checkbox"/>	18		
	WTX	Ti	≤ 3xD	3-12	○ ● ● ● ● ●	<input checked="" type="checkbox"/>	19		
	WPC	UNI	≤ 3xD	1-12	● ● ● ● ● ○	<input checked="" type="checkbox"/>	20		
	WTX	180	≤ 3xD	3-12	● ● ● ● ● ○	<input checked="" type="checkbox"/>	21		
5xD without thro' coolant									
	WTX	UNI	≤ 5xD	3-12	● ● ● ● ● ○	<input checked="" type="checkbox"/>	22		
	WPC	UNI	≤ 5xD	3-12	● ● ● ● ● ○	<input checked="" type="checkbox"/>	23		
5xD with thro' coolant									
	WTX	UNI	≤ 5xD	3-12	● ● ● ● ● ○	<input checked="" type="checkbox"/>	24		
	WTX	Ti	≤ 5xD	3-12	○ ● ● ● ● ●	<input checked="" type="checkbox"/>	25		
	WTX	AL	≤ 5xD	2,5-12	● ● ● ● ● ○	<input checked="" type="checkbox"/>	26		
	WPC	UNI	≤ 5xD	1-12	● ● ● ● ● ○	<input checked="" type="checkbox"/>	27		
	WTX	180	≤ 5xD	3-12	● ● ● ● ● ○	<input checked="" type="checkbox"/>	28		

Further dimensions and drills can be found in our → **main catalogue in Chapter 2 Solid carbide drills**

Solid carbide drills overview

Product name	Tool type	Length	Diameter in mm	Material compatibility	Coating	Performance	Standard
5xD micro drill without thro' coolant	WTX MINI	≤ 5xD	0,1-2,9	Steel, Stainless steel, Cast iron, Non-ferrous metals, Heat-resistant, Tempered steel, Non metal materials	coated	WNT / Performance	WNT / Standard
	WTX MINI	≤ 5xD	0,1-2,9		<input checked="" type="checkbox"/>	29	
5xD micro drill with thro' coolant	WTX MICRO	≤ 5xD	0,8-2,9	Steel, Stainless steel, Cast iron, Non-ferrous metals, Heat-resistant, Tempered steel, Non metal materials	coated	WNT / Performance	WNT / Standard
	WTX MICRO	≤ 5xD	0,8-2,9		<input checked="" type="checkbox"/>	30	
8xD micro drill with thro' coolant	WTX MICRO	≤ 8xD	0,8-2,9	Steel, Stainless steel, Cast iron, Non-ferrous metals, Heat-resistant, Tempered steel, Non metal materials	coated	WNT / Performance	WNT / Standard
	WTX MICRO	≤ 8xD	0,8-2,9		<input checked="" type="checkbox"/>	30	
12xD micro drill with thro' coolant	WTX MICRO	≤ 12xD	0,8-2,9	Steel, Stainless steel, Cast iron, Non-ferrous metals, Heat-resistant, Tempered steel, Non metal materials	coated	WNT / Performance	WNT / Standard
	WTX MICRO	≤ 12xD	0,8-2,9		<input checked="" type="checkbox"/>	31	
NC Spot Drill	NC-A		2-12	Steel, Stainless steel, Cast iron, Non-ferrous metals, Heat-resistant, Tempered steel, Non metal materials	uncoated	WNT / Performance	WNT / Standard
	NC-A	$\angle 90^\circ$ $\angle 120^\circ$	2-12		<input type="checkbox"/>	32	

 Further dimensions and drills can be found in our → [main catalogue in Chapter 2 Solid carbide drills](#)

WTX – High Performance Drill, DIN 6537

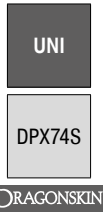
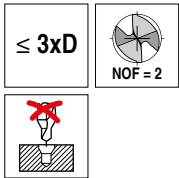

DRAGONSKIN



HA
 140°
 Solid carbide

11 777 ...

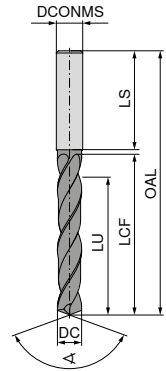

DC _{m7} mm	DCONMS _{h6} mm	OAL mm	LCF mm	LU mm	LS mm	
3.00	6	62	20	14	36	03000
3.10	6	62	20	14	36	03100
3.15	6	62	20	14	36	03150
3.20	6	62	20	14	36	03200
3.22	6	62	20	14	36	03220
3.25	6	62	20	14	36	03250
3.30	6	62	20	14	36	03300
3.40	6	62	20	14	36	03400
3.50	6	62	20	14	36	03500
3.60	6	62	20	14	36	03600
3.70	6	62	20	14	36	03700
3.80	6	66	24	17	36	03800
3.85	6	66	24	17	36	03850
3.90	6	66	24	17	36	03900
4.00	6	66	24	17	36	04000
4.10	6	66	24	17	36	04100
4.20	6	66	24	17	36	04200
4.25	6	66	24	17	36	04250
4.30	6	66	24	17	36	04300
4.35	6	66	24	17	36	04350
4.40	6	66	24	17	36	04400
4.45	6	66	24	17	36	04450
4.50	6	66	24	17	36	04500
4.60	6	66	24	17	36	04600
4.65	6	66	24	17	36	04650
4.70	6	66	24	17	36	04700
4.80	6	66	28	20	36	04800
4.90	6	66	28	20	36	04900
4.95	6	66	28	20	36	04950
5.00	6	66	28	20	36	05000
5.05	6	66	28	20	36	05050
5.10	6	66	28	20	36	05100
5.20	6	66	28	20	36	05200
5.30	6	66	28	20	36	05300
5.40	6	66	28	20	36	05400
5.50	6	66	28	20	36	05500
5.55	6	66	28	20	36	05550
5.60	6	66	28	20	36	05600
5.70	6	66	28	20	36	05700
5.75	6	66	28	20	36	05750
5.80	6	66	28	20	36	05800
5.90	6	66	28	20	36	05900
5.95	6	66	28	20	36	05950
6.00	6	66	28	20	36	06000
6.10	8	79	34	24	36	06100
6.20	8	79	34	24	36	06200
6.30	8	79	34	24	36	06300
6.40	8	79	34	24	36	06400
6.50	8	79	34	24	36	06500
6.60	8	79	34	24	36	06600
6.70	8	79	34	24	36	06700

11 777 ...

DC _{m7} mm	DCONMS _{h6} mm	OAL mm	LCF mm	LU mm	LS mm	
6.80	8	79	34	24	36	06800
6.90	8	79	34	24	36	06900
7.00	8	79	34	24	36	07000
7.10	8	79	41	29	36	07100
7.20	8	79	41	29	36	07200
7.30	8	79	41	29	36	07300
7.40	8	79	41	29	36	07400
7.45	8	79	41	29	36	07450
7.50	8	79	41	29	36	07500
7.60	8	79	41	29	36	07600
7.70	8	79	41	29	36	07700
7.80	8	79	41	29	36	07800
7.90	8	79	41	29	36	07900
8.00	8	79	41	29	36	08000
8.10	10	89	47	35	40	08100
8.20	10	89	47	35	40	08200
8.30	10	89	47	35	40	08300
8.40	10	89	47	35	40	08400
8.50	10	89	47	35	40	08500
8.60	10	89	47	35	40	08600
8.70	10	89	47	35	40	08700
8.80	10	89	47	35	40	08800
8.90	10	89	47	35	40	08900
9.00	10	89	47	35	40	09000
9.10	10	89	47	35	40	09100
9.20	10	89	47	35	40	09200
9.30	10	89	47	35	40	09300
9.35	10	89	47	35	40	09350
9.40	10	89	47	35	40	09400
9.45	10	89	47	35	40	09450
9.50	10	89	47	35	40	09500
9.60	10	89	47	35	40	09600
9.70	10	89	47	35	40	09700
9.80	10	89	47	35	40	09800
9.90	10	89	47	35	40	09900
10.00	10	89	47	35	40	10000
10.10	12	102	55	40	45	10100
10.20	12	102	55	40	45	10200
10.30	12	102	55	40	45	10300
10.40	12	102	55	40	45	10400
10.50	12	102	55	40	45	10500
10.55	12	102	55	40	45	10550
10.60	12	102	55	40	45	10600
10.70	12	102	55	40	45	10700
10.75	12	102	55	40	45	10750
10.80	12	102	55	40	45	10800
10.90	12	102	55	40	45	10900
11.00	12	102	55	40	45	11000
11.10	12	102	55	40	45	11100
11.20	12	102	55	40	45	11200
11.25	12	102	55	40	45	11250
11.30	12	102	55	40	45	11300
11.35	12	102	55	40	45	11350
11.40	12	102	55	40	45	11400
11.45	12	102	55	40	45	11450
11.50	12	102	55	40	45	11500
11.60	12	102	55	40	45	11600
11.70	12	102	55	40	45	11700
11.80	12	102	55	40	45	11800
11.90	12	102	55	40	45	11900
12.00	12	102	55	40	45	12000

P	●
M	
K	●
N	
S	
H	○
O	

→ v_c Page 34



Further dimensions and drills can be found in our
→ main catalogue in Chapter 2 Solid carbide drills

WPC – High Performance Drill, DIN 6537

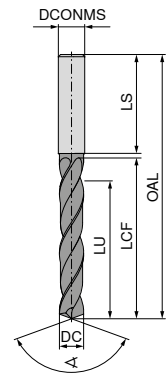
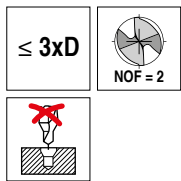

140°
Solid carbide

11 600 ...

DC _{m7} mm	DCONMS _{h6} mm	OAL mm	LCF mm	LU mm	LS mm	
1.00	4	45	5.0	4.5	32.0	010
1.10	4	45	5.5	5.0	31.5	011
1.20	4	45	6.0	5.4	31.0	012
1.30	4	45	6.5	5.9	31.5	013
1.40	4	45	7.0	6.3	30.0	014
1.50	4	50	7.5	6.8	35.0	015
1.60	4	50	8.0	7.2	34.5	016
1.70	4	50	8.5	7.7	34.0	017
1.80	4	50	9.0	8.1	33.5	018
1.90	4	50	9.5	8.6	33.0	019
2.00	6	58	14.0	11.0	36.0	020
2.10	6	58	14.0	11.0	36.0	021
2.20	6	58	14.0	11.0	36.0	022
2.30	6	58	14.0	11.0	36.0	023
2.40	6	58	14.0	11.0	36.0	024
2.50	6	58	14.0	11.0	36.0	025
2.60	6	58	14.0	11.0	36.0	026
2.70	6	58	14.0	11.0	36.0	027
2.80	6	58	14.0	11.0	36.0	028
2.90	6	58	14.0	11.0	36.0	029
3.00	6	62	20.0	14.0	36.0	030
3.10	6	62	20.0	14.0	36.0	031
3.20	6	62	20.0	14.0	36.0	032
3.30	6	62	20.0	14.0	36.0	033
3.40	6	62	20.0	14.0	36.0	034
3.50	6	62	20.0	14.0	36.0	035
3.60	6	62	20.0	14.0	36.0	036
3.70	6	62	20.0	14.0	36.0	037
3.80	6	66	24.0	17.0	36.0	038
3.90	6	66	24.0	17.0	36.0	039
4.00	6	66	24.0	17.0	36.0	040
4.10	6	66	24.0	17.0	36.0	041
4.20	6	66	24.0	17.0	36.0	042
4.30	6	66	24.0	17.0	36.0	043
4.40	6	66	24.0	17.0	36.0	044
4.50	6	66	24.0	17.0	36.0	045
4.60	6	66	24.0	17.0	36.0	046
4.65	6	66	24.0	17.0	36.0	900
4.70	6	66	24.0	17.0	36.0	047
4.80	6	66	28.0	20.0	36.0	048
4.90	6	66	28.0	20.0	36.0	049
5.00	6	66	28.0	20.0	36.0	050
5.10	6	66	28.0	20.0	36.0	051
5.20	6	66	28.0	20.0	36.0	052
5.30	6	66	28.0	20.0	36.0	053
5.40	6	66	28.0	20.0	36.0	054
5.50	6	66	28.0	20.0	36.0	055
5.55	6	66	28.0	20.0	36.0	902
5.60	6	66	28.0	20.0	36.0	056
5.70	6	66	28.0	20.0	36.0	057
5.80	6	66	28.0	20.0	36.0	058
5.90	6	66	28.0	20.0	36.0	059
6.00	6	66	28.0	20.0	36.0	060
6.10	8	79	34.0	24.0	36.0	061

11 600 ...

DC _{m7} mm	DCONMS _{h6} mm	OAL mm	LCF mm	LU mm	LS mm	
6.20	8	79	34.0	24.0	36.0	062
6.30	8	79	34.0	24.0	36.0	063
6.40	8	79	34.0	24.0	36.0	064
6.50	8	79	34.0	24.0	36.0	065
6.60	8	79	34.0	24.0	36.0	066
6.70	8	79	34.0	24.0	36.0	067
6.80	8	79	34.0	24.0	36.0	068
6.90	8	79	34.0	24.0	36.0	069
7.00	8	79	34.0	24.0	36.0	070
7.10	8	79	41.0	29.0	36.0	071
7.20	8	79	41.0	29.0	36.0	072
7.30	8	79	41.0	29.0	36.0	073
7.40	8	79	41.0	29.0	36.0	074
7.50	8	79	41.0	29.0	36.0	075
7.55	8	79	41.0	29.0	36.0	975
7.60	8	79	41.0	29.0	36.0	076
7.70	8	79	41.0	29.0	36.0	077
7.80	8	79	41.0	29.0	36.0	078
7.90	8	79	41.0	29.0	36.0	079
8.00	8	79	41.0	29.0	36.0	080
8.10	10	89	47.0	35.0	40.0	081
8.20	10	89	47.0	35.0	40.0	082
8.30	10	89	47.0	35.0	40.0	083
8.40	10	89	47.0	35.0	40.0	084
8.50	10	89	47.0	35.0	40.0	085
8.60	10	89	47.0	35.0	40.0	086
8.70	10	89	47.0	35.0	40.0	087
8.80	10	89	47.0	35.0	40.0	088
8.90	10	89	47.0	35.0	40.0	089
9.00	10	89	47.0	35.0	40.0	090
9.10	10	89	47.0	35.0	40.0	091
9.20	10	89	47.0	35.0	40.0	092
9.25	10	89	47.0	35.0	40.0	925
9.30	10	89	47.0	35.0	40.0	093
9.40	10	89	47.0	35.0	40.0	094
9.50	10	89	47.0	35.0	40.0	095
9.60	10	89	47.0	35.0	40.0	096
9.70	10	89	47.0	35.0	40.0	097
9.80	10	89	47.0	35.0	40.0	098
9.90	10	89	47.0	35.0	40.0	099
10.00	10	89	47.0	35.0	40.0	100
10.10	12	102	55.0	40.0	45.0	101
10.20	12	102	55.0	40.0	45.0	102
10.30	12	102	55.0	40.0	45.0	103
10.40	12	102	55.0	40.0	45.0	104
10.50	12	102	55.0	40.0	45.0	105
10.60	12	102	55.0	40.0	45.0	106
10.70	12	102	55.0	40.0	45.0	107
10.80	12	102	55.0	40.0	45.0	108
10.90	12	102	55.0	40.0	45.0	109
11.00	12	102	55.0	40.0	45.0	110
11.10	12	102	55.0	40.0	45.0	111
11.20	12	102	55.0	40.0	45.0	112
11.30	12	102	55.0	40.0	45.0	113
11.40	12	102	55.0	40.0	45.0	114
11.50	12	102	55.0	40.0	45.0	115
11.60	12	102	55.0	40.0	45.0	116
11.70	12	102	55.0	40.0	45.0	117
11.80	12	102	55.0	40.0	45.0	118
11.90	12	102	55.0	40.0	45.0	119
12.00	12	102	55.0	40.0	45.0	120

P	●
M	
K	●
N	
S	
H	
O	

→ v_c Page 40



Further dimensions and drills can be found in our
→ main catalogue in Chapter 2 Solid carbide drills

WTX – High Performance Drill, DIN 6537

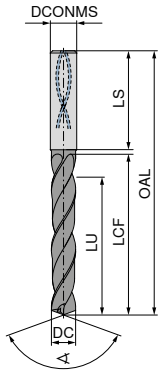
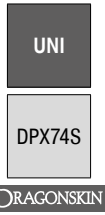
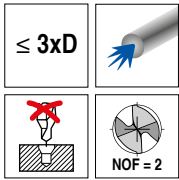

11 780 ...

DC _{m7} mm	DCONMS _{h6} mm	OAL mm	LCF mm	LU mm	LS mm	
3.00	6	62	20	14	36	03000
3.10	6	62	20	14	36	03100
3.15	6	62	20	14	36	03150
3.20	6	62	20	14	36	03200
3.22	6	62	20	14	36	03220
3.25	6	62	20	14	36	03250
3.30	6	62	20	14	36	03300
3.40	6	62	20	14	36	03400
3.50	6	62	20	14	36	03500
3.60	6	62	20	14	36	03600
3.70	6	62	20	14	36	03700
3.80	6	66	24	17	36	03800
3.85	6	66	24	17	36	03850
3.90	6	66	24	17	36	03900
4.00	6	66	24	17	36	04000
4.10	6	66	24	17	36	04100
4.20	6	66	24	17	36	04200
4.25	6	66	24	17	36	04250
4.30	6	66	24	17	36	04300
4.35	6	66	24	17	36	04350
4.40	6	66	24	17	36	04400
4.45	6	66	24	17	36	04450
4.50	6	66	24	17	36	04500
4.60	6	66	24	17	36	04600
4.65	6	66	24	17	36	04650
4.70	6	66	24	17	36	04700
4.80	6	66	28	20	36	04800
4.90	6	66	28	20	36	04900
4.95	6	66	28	20	36	04950
5.00	6	66	28	20	36	05000
5.05	6	66	28	20	36	05050
5.10	6	66	28	20	36	05100
5.20	6	66	28	20	36	05200
5.30	6	66	28	20	36	05300
5.40	6	66	28	20	36	05400
5.50	6	66	28	20	36	05500
5.55	6	66	28	20	36	05550
5.60	6	66	28	20	36	05600
5.70	6	66	28	20	36	05700
5.75	6	66	28	20	36	05750
5.80	6	66	28	20	36	05800
5.90	6	66	28	20	36	05900
5.95	6	66	28	20	36	05950
6.00	6	66	28	20	36	06000
6.10	8	79	34	24	36	06100
6.20	8	79	34	24	36	06200
6.30	8	79	34	24	36	06300
6.40	8	79	34	24	36	06400
6.50	8	79	34	24	36	06500
6.60	8	79	34	24	36	06600
6.70	8	79	34	24	36	06700

11 780 ...

DC _{m7} mm	DCONMS _{h6} mm	OAL mm	LCF mm	LU mm	LS mm	
6.80	8	79	34	24	36	06800
6.90	8	79	34	24	36	06900
7.00	8	79	34	24	36	07000
7.10	8	79	41	29	36	07100
7.20	8	79	41	29	36	07200
7.30	8	79	41	29	36	07300
7.40	8	79	41	29	36	07400
7.45	8	79	41	29	36	07450
7.50	8	79	41	29	36	07500
7.60	8	79	41	29	36	07600
7.70	8	79	41	29	36	07700
7.80	8	79	41	29	36	07800
7.90	8	79	41	29	36	07900
8.00	8	79	41	29	36	08000
8.10	10	89	47	35	40	08100
8.20	10	89	47	35	40	08200
8.30	10	89	47	35	40	08300
8.40	10	89	47	35	40	08400
8.50	10	89	47	35	40	08500
8.60	10	89	47	35	40	08600
8.70	10	89	47	35	40	08700
8.80	10	89	47	35	40	08800
8.90	10	89	47	35	40	08900
9.00	10	89	47	35	40	09000
9.10	10	89	47	35	40	09100
9.20	10	89	47	35	40	09200
9.30	10	89	47	35	40	09300
9.35	10	89	47	35	40	09350
9.40	10	89	47	35	40	09400
9.45	10	89	47	35	40	09450
9.50	10	89	47	35	40	09500
9.60	10	89	47	35	40	09600
9.70	10	89	47	35	40	09700
9.80	10	89	47	35	40	09800
9.90	10	89	47	35	40	09900
10.00	10	89	47	35	40	10000
10.10	12	102	55	40	45	10100
10.20	12	102	55	40	45	10200
10.30	12	102	55	40	45	10300
10.40	12	102	55	40	45	10400
10.50	12	102	55	40	45	10500
10.55	12	102	55	40	45	10550
10.60	12	102	55	40	45	10600
10.70	12	102	55	40	45	10700
10.75	12	102	55	40	45	10750
10.80	12	102	55	40	45	10800
10.90	12	102	55	40	45	10900
11.00	12	102	55	40	45	11000
11.10	12	102	55	40	45	11100
11.20	12	102	55	40	45	11200
11.25	12	102	55	40	45	11250
11.30	12	102	55	40	45	11300
11.35	12	102	55	40	45	11350
11.40	12	102	55	40	45	11400
11.45	12	102	55	40	45	11450
11.50	12	102	55	40	45	11500
11.60	12	102	55	40	45	11600
11.70	12	102	55	40	45	11700
11.80	12	102	55	40	45	11800
11.90	12	102	55	40	45	11900
12.00	12	102	55	40	45	12000

P	●
M	
K	●
N	
S	
H	○
O	

→ v_c Page 34



Further dimensions and drills can be found in our
→ main catalogue in Chapter 2 Solid carbide drills

WTX – High-performance drill, DIN 6537

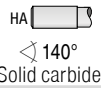
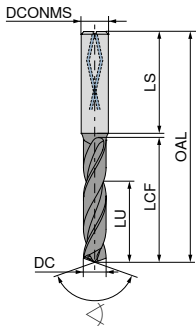
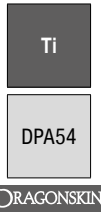
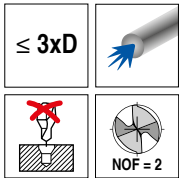

10 786 ...

DC _{m7} mm	DCONMS _{h6} mm	OAL mm	LCF mm	LU mm	LS mm	
3.00	6	62	20	14	36	030
3.10	6	62	20	14	36	031
3.20	6	62	20	14	36	032
3.30	6	62	20	14	36	033
3.40	6	62	20	14	36	034
3.50	6	62	20	14	36	035
3.60	6	62	20	14	36	036
3.70	6	62	20	14	36	037
3.80	6	66	24	17	36	038
3.90	6	66	24	17	36	039
3.97	6	66	24	17	36	900
4.00	6	66	24	17	36	040
4.10	6	66	24	17	36	041
4.20	6	66	24	17	36	042
4.23	6	66	24	17	36	901
4.30	6	66	24	17	36	043
4.40	6	66	24	17	36	044
4.50	6	66	24	17	36	045
4.60	6	66	24	17	36	046
4.70	6	66	24	17	36	047
4.80	6	66	28	20	36	048
4.90	6	66	28	20	36	049
5.00	6	66	28	20	36	050
5.10	6	66	28	20	36	051
5.20	6	66	28	20	36	052
5.30	6	66	28	20	36	053
5.40	6	66	28	20	36	054
5.50	6	66	28	20	36	055
5.56	6	66	28	20	36	902
5.60	6	66	28	20	36	056
5.70	6	66	28	20	36	057
5.80	6	66	28	20	36	058
5.90	6	66	28	20	36	059
6.00	6	66	28	20	36	060
6.10	8	79	34	24	36	061
6.20	8	79	34	24	36	062
6.30	8	79	34	24	36	063
6.35	8	79	34	24	36	903
6.40	8	79	34	24	36	064
6.50	8	79	34	24	36	065
6.60	8	79	34	24	36	066
6.70	8	79	34	24	36	067
6.80	8	79	34	24	36	068
6.90	8	79	34	24	36	069
7.00	8	79	34	24	36	070
7.10	8	79	41	29	36	071
7.20	8	79	41	29	36	072
7.30	8	79	41	29	36	073
7.40	8	79	41	29	36	074
7.50	8	79	41	29	36	075
7.60	8	79	41	29	36	076

10 786 ...

DC _{m7} mm	DCONMS _{h6} mm	OAL mm	LCF mm	LU mm	LS mm	
7.70	8	79	41	29	36	077
7.80	8	79	41	29	36	078
7.90	8	79	41	29	36	079
7.94	8	79	41	29	36	904
8.00	8	79	41	29	36	080
8.10	10	89	47	35	40	081
8.20	10	89	47	35	40	082
8.30	10	89	47	35	40	083
8.40	10	89	47	35	40	084
8.50	10	89	47	35	40	085
8.60	10	89	47	35	40	086
8.70	10	89	47	35	40	087
8.80	10	89	47	35	40	088
8.90	10	89	47	35	40	089
9.00	10	89	47	35	40	090
9.10	10	89	47	35	40	091
9.20	10	89	47	35	40	092
9.30	10	89	47	35	40	093
9.40	10	89	47	35	40	094
9.50	10	89	47	35	40	095
9.53	10	89	47	35	40	905
9.60	10	89	47	35	40	096
9.70	10	89	47	35	40	097
9.80	10	89	47	35	40	098
9.90	10	89	47	35	40	099
10.00	10	89	47	35	40	100
10.10	12	102	55	40	45	101
10.20	12	102	55	40	45	102
10.30	12	102	55	40	45	103
10.40	12	102	55	40	45	104
10.50	12	102	55	40	45	105
10.60	12	102	55	40	45	106
10.70	12	102	55	40	45	107
10.80	12	102	55	40	45	108
10.90	12	102	55	40	45	109
11.00	12	102	55	40	45	110
11.10	12	102	55	40	45	111
11.11	12	102	55	40	45	906
11.20	12	102	55	40	45	112
11.30	12	102	55	40	45	113
11.40	12	102	55	40	45	114
11.50	12	102	55	40	45	115
11.60	12	102	55	40	45	116
11.70	12	102	55	40	45	117
11.80	12	102	55	40	45	118
11.90	12	102	55	40	45	119
12.00	12	102	55	40	45	120

P	○
M	●
K	
N	
S	●
H	
O	

→ v_c Page 35



Further dimensions and drills can be found in our
→ main catalogue in Chapter 2 Solid carbide drills

WPC – High Performance Drill, DIN 6537

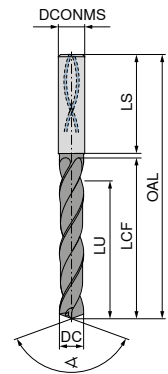
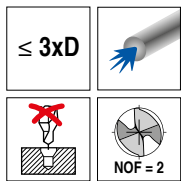

UNI
TiAlN



140°
Solid carbide

11 603 ...

DC _{m7} mm	DCONMS _{h6} mm	OAL mm	LCF mm	LU mm	LS mm	
1.00	4	45	6.0	4.5	32.0	010
1.10	4	45	6.6	5.0	31.5	011
1.20	4	45	7.2	5.4	31.0	012
1.30	4	45	7.8	5.9	31.5	013
1.40	4	45	8.4	6.3	30.0	014
1.50	4	50	9.0	6.8	35.0	015
1.60	4	50	9.6	7.2	34.5	016
1.70	4	50	10.2	7.7	34.0	017
1.80	4	50	10.8	8.1	33.5	018
1.90	4	50	11.4	8.6	33.0	019
2.00	4	50	12.0	9.0	33.0	020
2.10	4	55	12.6	9.5	37.5	021
2.20	4	55	13.2	9.9	37.0	022
2.30	4	55	13.8	10.4	36.5	023
2.40	4	55	14.4	10.8	36.0	024
2.50	4	55	15.0	11.3	35.5	025
2.60	4	55	15.6	11.7	35.5	026
2.70	4	55	16.2	12.2	35.0	027
2.80	4	55	16.8	12.6	34.0	028
2.90	4	55	17.4	13.1	34.0	029
3.00	6	62	20.0	14.0	36.0	030
3.10	6	62	20.0	14.0	36.0	031
3.20	6	62	20.0	14.0	36.0	032
3.25	6	62	20.0	14.0	36.0	890
3.30	6	62	20.0	14.0	36.0	033
3.40	6	62	20.0	14.0	36.0	034
3.50	6	62	20.0	14.0	36.0	035
3.60	6	62	20.0	14.0	36.0	036
3.70	6	62	20.0	14.0	36.0	037
3.80	6	66	24.0	17.0	36.0	038
3.90	6	66	24.0	17.0	36.0	039
4.00	6	66	24.0	17.0	36.0	040
4.10	6	66	24.0	17.0	36.0	041
4.20	6	66	24.0	17.0	36.0	042
4.30	6	66	24.0	17.0	36.0	043
4.40	6	66	24.0	17.0	36.0	044
4.50	6	66	24.0	17.0	36.0	045
4.60	6	66	24.0	17.0	36.0	046
4.65	6	66	24.0	17.0	36.0	900
4.70	6	66	24.0	17.0	36.0	047
4.80	6	66	28.0	20.0	36.0	048
4.90	6	66	28.0	20.0	36.0	049
5.00	6	66	28.0	20.0	36.0	050
5.10	6	66	28.0	20.0	36.0	051
5.20	6	66	28.0	20.0	36.0	052
5.30	6	66	28.0	20.0	36.0	053
5.40	6	66	28.0	20.0	36.0	054
5.50	6	66	28.0	20.0	36.0	055
5.55	6	66	28.0	20.0	36.0	902
5.60	6	66	28.0	20.0	36.0	056
5.70	6	66	28.0	20.0	36.0	057
5.80	6	66	28.0	20.0	36.0	058
5.90	6	66	28.0	20.0	36.0	059
6.00	6	66	28.0	20.0	36.0	060
6.10	8	79	34.0	24.0	36.0	061
6.20	8	79	34.0	24.0	36.0	062

11 603 ...

DC _{m7} mm	DCONMS _{h6} mm	OAL mm	LCF mm	LU mm	LS mm	
6.30	8	79	34.0	24.0	36.0	063
6.40	8	79	34.0	24.0	36.0	064
6.50	8	79	34.0	24.0	36.0	065
6.60	8	79	34.0	24.0	36.0	066
6.70	8	79	34.0	24.0	36.0	067
6.80	8	79	34.0	24.0	36.0	068
6.90	8	79	34.0	24.0	36.0	069
7.00	8	79	34.0	24.0	36.0	070
7.10	8	79	41.0	29.0	36.0	071
7.20	8	79	41.0	29.0	36.0	072
7.30	8	79	41.0	29.0	36.0	073
7.40	8	79	41.0	29.0	36.0	074
7.45	8	79	41.0	29.0	36.0	924
7.50	8	79	41.0	29.0	36.0	075
7.55	8	79	41.0	29.0	36.0	975
7.60	8	79	41.0	29.0	36.0	076
7.70	8	79	41.0	29.0	36.0	077
7.80	8	79	41.0	29.0	36.0	078
7.90	8	79	41.0	29.0	36.0	079
8.00	8	79	41.0	29.0	36.0	080
8.10	10	89	47.0	35.0	40.0	081
8.20	10	89	47.0	35.0	40.0	082
8.30	10	89	47.0	35.0	40.0	083
8.40	10	89	47.0	35.0	40.0	084
8.50	10	89	47.0	35.0	40.0	085
8.60	10	89	47.0	35.0	40.0	086
8.70	10	89	47.0	35.0	40.0	087
8.80	10	89	47.0	35.0	40.0	088
8.90	10	89	47.0	35.0	40.0	089
9.00	10	89	47.0	35.0	40.0	090
9.10	10	89	47.0	35.0	40.0	091
9.20	10	89	47.0	35.0	40.0	092
9.25	10	89	47.0	35.0	40.0	925
9.30	10	89	47.0	35.0	40.0	093
9.35	10	89	47.0	35.0	40.0	930
9.40	10	89	47.0	35.0	40.0	094
9.50	10	89	47.0	35.0	40.0	095
9.60	10	89	47.0	35.0	40.0	096
9.70	10	89	47.0	35.0	40.0	097
9.80	10	89	47.0	35.0	40.0	098
9.90	10	89	47.0	35.0	40.0	099
10.00	10	89	47.0	35.0	40.0	100
10.10	12	102	55.0	40.0	45.0	101
10.20	12	102	55.0	40.0	45.0	102
10.30	12	102	55.0	40.0	45.0	103
10.40	12	102	55.0	40.0	45.0	104
10.50	12	102	55.0	40.0	45.0	105
10.60	12	102	55.0	40.0	45.0	106
10.70	12	102	55.0	40.0	45.0	107
10.75	12	102	55.0	40.0	45.0	904
10.80	12	102	55.0	40.0	45.0	108
10.90	12	102	55.0	40.0	45.0	109
11.00	12	102	55.0	40.0	45.0	110
11.10	12	102	55.0	40.0	45.0	111
11.20	12	102	55.0	40.0	45.0	112
11.25	12	102	55.0	40.0	45.0	912
11.30	12	102	55.0	40.0	45.0	113
11.40	12	102	55.0	40.0	45.0	114
11.50	12	102	55.0	40.0	45.0	115
11.60	12	102	55.0	40.0	45.0	116
11.70	12	102	55.0	40.0	45.0	117
11.80	12	102	55.0	40.0	45.0	118
11.90	12	102	55.0	40.0	45.0	119
12.00	12	102	55.0	40.0	45.0	120

P	●
M	
K	●
N	
S	
H	
O	

→ v_c Page 40



Further dimensions and drills can be found in our
→ main catalogue in Chapter 2 Solid carbide drills

WTX – High Performance Drill, DIN 6537

- ▲ universal application
- ▲ four guidance lands

- ▲ polished chip flutes
- ▲ Type ALU 3xD on request

- ▲ PL = corner chamfers

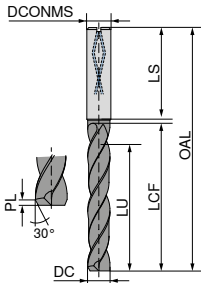
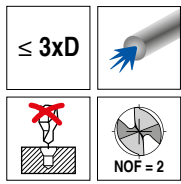

180
Ti800



HA

180°
Solid carbide

10 720 ...

DC _{m7} mm	DCONMS _{h6} mm	OAL mm	LCF mm	LU mm	LS mm	PL mm	
3.00	6	62	20	14	36	0.15	030
3.10	6	62	20	14	36	0.16	031
3.20	6	62	20	14	36	0.16	032
3.30	6	62	20	14	36	0.17	033
3.40	6	62	20	14	36	0.17	034
3.50	6	62	20	14	36	0.18	035
3.60	6	62	20	14	36	0.18	036
3.70	6	62	20	14	36	0.19	037
3.80	6	66	24	17	36	0.19	038
3.90	6	66	24	17	36	0.20	039
4.00	6	66	24	17	36	0.20	040
4.10	6	66	24	17	36	0.21	041
4.20	6	66	24	17	36	0.21	042
4.30	6	66	24	17	36	0.22	043
4.40	6	66	24	17	36	0.22	044
4.50	6	66	24	17	36	0.23	045
4.60	6	66	24	17	36	0.23	046
4.65	6	66	24	17	36	0.23	900
4.70	6	66	24	17	36	0.24	047
4.80	6	66	28	20	36	0.24	048
4.90	6	66	28	20	36	0.25	049
5.00	6	66	28	20	36	0.25	050
5.10	6	66	28	20	36	0.26	051
5.20	6	66	28	20	36	0.26	052
5.30	6	66	28	20	36	0.27	053
5.40	6	66	28	20	36	0.27	054
5.50	6	66	28	20	36	0.28	055
5.55	6	66	28	20	36	0.28	902
5.60	6	66	28	20	36	0.28	056
5.70	6	66	28	20	36	0.29	057
5.80	6	66	28	20	36	0.29	058
5.90	6	66	28	20	36	0.30	059
6.00	6	66	28	20	36	0.30	060
6.10	8	79	34	24	36	0.31	061
6.20	8	79	34	24	36	0.31	062
6.30	8	79	34	24	36	0.32	063
6.40	8	79	34	24	36	0.32	064
6.50	8	79	34	24	36	0.33	065
6.60	8	79	34	24	36	0.33	066
6.70	8	79	34	24	36	0.34	067
6.80	8	79	34	24	36	0.34	068
6.90	8	79	34	24	36	0.35	069
7.00	8	79	34	24	36	0.35	070
7.10	8	79	41	29	36	0.36	071
7.20	8	79	41	29	36	0.36	072
7.30	8	79	41	29	36	0.37	073
7.40	8	79	41	29	36	0.37	074
7.50	8	79	41	29	36	0.38	075
7.60	8	79	41	29	36	0.38	076
7.70	8	79	41	29	36	0.39	077
7.80	8	79	41	29	36	0.39	078
7.90	8	79	41	29	36	0.40	079
8.00	8	79	41	29	36	0.40	080
8.10	10	89	47	35	40	0.41	081

10 720 ...

DC _{m7} mm	DCONMS _{h6} mm	OAL mm	LCF mm	LU mm	LS mm	PL mm	
8.20	10	89	47	35	40	0.41	082
8.30	10	89	47	35	40	0.42	083
8.40	10	89	47	35	40	0.42	084
8.50	10	89	47	35	40	0.43	085
8.60	10	89	47	35	40	0.43	086
8.70	10	89	47	35	40	0.44	087
8.80	10	89	47	35	40	0.44	088
8.90	10	89	47	35	40	0.45	089
9.00	10	89	47	35	40	0.45	090
9.10	10	89	47	35	40	0.46	091
9.20	10	89	47	35	40	0.46	092
9.30	10	89	47	35	40	0.47	093
9.40	10	89	47	35	40	0.47	094
9.50	10	89	47	35	40	0.48	095
9.60	10	89	47	35	40	0.48	096
9.70	10	89	47	35	40	0.49	097
9.80	10	89	47	35	40	0.49	098
9.90	10	89	47	35	40	0.50	099
10.00	10	89	47	35	40	0.50	100
10.10	12	100	53	38	45	0.51	101
10.20	12	100	53	38	45	0.51	102
10.30	12	100	53	38	45	0.52	103
10.40	12	100	53	38	45	0.52	104
10.50	12	100	53	38	45	0.53	105
10.60	12	100	53	38	45	0.53	106
10.70	12	100	53	38	45	0.54	107
10.80	12	100	53	38	45	0.54	108
10.90	12	100	53	38	45	0.55	109
11.00	12	100	53	38	45	0.55	110
11.10	12	100	53	38	45	0.56	111
11.20	12	100	53	38	45	0.56	112
11.30	12	100	53	38	45	0.57	113
11.40	12	100	53	38	45	0.57	114
11.50	12	100	53	38	45	0.58	115
11.60	12	100	53	38	45	0.58	116
11.70	12	100	53	38	45	0.59	117
11.80	12	100	53	38	45	0.59	118
11.90	12	100	53	38	45	0.60	119
12.00	12	100	53	38	45	0.60	120

P	●
M	●
K	●
N	
S	
H	
O	

→ v_c Page 38



Further dimensions and drills can be found in our
→ main catalogue in Chapter 2 Solid carbide drills

WTX – High Performance Drill, DIN 6537

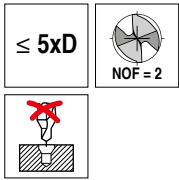

UNI
DPX74S
DRAGONSKIN

11 783 ...

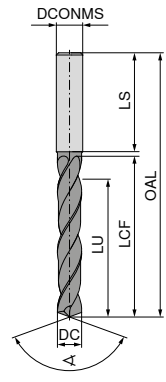

11 783 ...

DC _{m7} mm	DCONMS _{h6} mm	OAL mm	LCF mm	LU mm	LS mm	
3.00	6	66	28	23	36	03000
3.10	6	66	28	23	36	03100
3.15	6	66	28	23	36	03150
3.20	6	66	28	23	36	03200
3.22	6	66	28	23	36	03220
3.25	6	66	28	23	36	03250
3.30	6	66	28	23	36	03300
3.40	6	66	28	23	36	03400
3.50	6	66	28	23	36	03500
3.60	6	66	28	23	36	03600
3.70	6	66	28	23	36	03700
3.80	6	74	36	29	36	03800
3.85	6	74	36	29	36	03850
3.90	6	74	36	29	36	03900
4.00	6	74	36	29	36	04000
4.10	6	74	36	29	36	04100
4.20	6	74	36	29	36	04200
4.25	6	74	36	29	36	04250
4.30	6	74	36	29	36	04300
4.35	6	74	36	29	36	04350
4.40	6	74	36	29	36	04400
4.45	6	74	36	29	36	04450
4.50	6	74	36	29	36	04500
4.60	6	74	36	29	36	04600
4.65	6	74	36	29	36	04650
4.70	6	74	36	29	36	04700
4.80	6	82	44	35	36	04800
4.90	6	82	44	35	36	04900
4.95	6	82	44	35	36	04950
5.00	6	82	44	35	36	05000
5.05	6	82	44	35	36	05050
5.10	6	82	44	35	36	05100
5.20	6	82	44	35	36	05200
5.30	6	82	44	35	36	05300
5.40	6	82	44	35	36	05400
5.50	6	82	44	35	36	05500
5.55	6	82	44	35	36	05550
5.60	6	82	44	35	36	05600
5.70	6	82	44	35	36	05700
5.75	6	82	44	35	36	05750
5.80	6	82	44	35	36	05800
5.90	6	82	44	35	36	05900
5.95	6	82	44	35	36	05950
6.00	6	82	44	35	36	06000
6.10	8	91	53	43	36	06100
6.20	8	91	53	43	36	06200
6.30	8	91	53	43	36	06300
6.40	8	91	53	43	36	06400
6.50	8	91	53	43	36	06500
6.60	8	91	53	43	36	06600
6.70	8	91	53	43	36	06700

DC _{m7} mm	DCONMS _{h6} mm	OAL mm	LCF mm	LU mm	LS mm	
6.80	8	91	53	43	36	06800
6.90	8	91	53	43	36	06900
7.00	8	91	53	43	36	07000
7.10	8	91	53	43	36	07100
7.20	8	91	53	43	36	07200
7.30	8	91	53	43	36	07300
7.40	8	91	53	43	36	07400
7.45	8	91	53	43	36	07450
7.50	8	91	53	43	36	07500
7.60	8	91	53	43	36	07600
7.70	8	91	53	43	36	07700
7.80	8	91	53	43	36	07800
7.90	8	91	53	43	36	07900
8.00	8	91	53	43	36	08000
8.10	10	103	61	49	40	08100
8.20	10	103	61	49	40	08200
8.30	10	103	61	49	40	08300
8.40	10	103	61	49	40	08400
8.50	10	103	61	49	40	08500
8.60	10	103	61	49	40	08600
8.70	10	103	61	49	40	08700
8.80	10	103	61	49	40	08800
8.90	10	103	61	49	40	08900
9.00	10	103	61	49	40	09000
9.10	10	103	61	49	40	09100
9.20	10	103	61	49	40	09200
9.30	10	103	61	49	40	09300
9.35	10	103	61	49	40	09350
9.40	10	103	61	49	40	09400
9.45	10	103	61	49	40	09450
9.50	10	103	61	49	40	09500
9.60	10	103	61	49	40	09600
9.70	10	103	61	49	40	09700
9.80	10	103	61	49	40	09800
9.90	10	103	61	49	40	09900
10.00	10	103	61	49	40	10000
10.10	12	118	71	56	45	10100
10.20	12	118	71	56	45	10200
10.30	12	118	71	56	45	10300
10.40	12	118	71	56	45	10400
10.50	12	118	71	56	45	10500
10.55	12	118	71	56	45	10550
10.60	12	118	71	56	45	10600
10.70	12	118	71	56	45	10700
10.75	12	118	71	56	45	10750
10.80	12	118	71	56	45	10800
10.90	12	118	71	56	45	10900
11.00	12	118	71	56	45	11000
11.10	12	118	71	56	45	11100
11.20	12	118	71	56	45	11200
11.25	12	118	71	56	45	11250
11.30	12	118	71	56	45	11300
11.35	12	118	71	56	45	11350
11.40	12	118	71	56	45	11400
11.45	12	118	71	56	45	11450
11.50	12	118	71	56	45	11500
11.60	12	118	71	56	45	11600
11.70	12	118	71	56	45	11700
11.80	12	118	71	56	45	11800
11.90	12	118	71	56	45	11900
12.00	12	118	71	56	45	12000

P	●
M	
K	●
N	
S	
H	○
O	

→ v_c Page 34

Further dimensions and drills can be found in our
→ main catalogue in Chapter 2 Solid carbide drills

WPC – High Performance Drill, DIN 6537

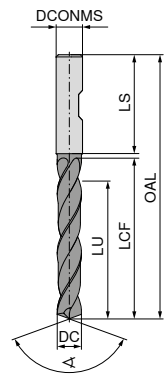
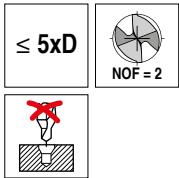

140°
Solid carbide

11 606 ...

DC _{m7} mm	DCONMS _{h6} mm	OAL mm	LCF mm	LU mm	LS mm	
3.00	6	66	28	23	36	030
3.10	6	66	28	23	36	031
3.20	6	66	28	23	36	032
3.30	6	66	28	23	36	033
3.40	6	66	28	23	36	034
3.50	6	66	28	23	36	035
3.60	6	66	28	23	36	036
3.70	6	66	28	23	36	037
3.80	6	74	36	29	36	038
3.90	6	74	36	29	36	039
4.00	6	74	36	29	36	040
4.10	6	74	36	29	36	041
4.20	6	74	36	29	36	042
4.30	6	74	36	29	36	043
4.40	6	74	36	29	36	044
4.50	6	74	36	29	36	045
4.60	6	74	36	29	36	046
4.65	6	74	36	29	36	900
4.70	6	74	36	29	36	047
4.80	6	82	44	35	36	048
4.90	6	82	44	35	36	049
5.00	6	82	44	35	36	050
5.10	6	82	44	35	36	051
5.20	6	82	44	35	36	052
5.30	6	82	44	35	36	053
5.40	6	82	44	35	36	054
5.50	6	82	44	35	36	055
5.55	6	82	44	35	36	902
5.60	6	82	44	35	36	056
5.70	6	82	44	35	36	057
5.80	6	82	44	35	36	058
5.90	6	82	44	35	36	059
6.00	6	82	44	35	36	060
6.10	8	91	53	43	36	061
6.20	8	91	53	43	36	062
6.30	8	91	53	43	36	063
6.40	8	91	53	43	36	064
6.50	8	91	53	43	36	065
6.60	8	91	53	43	36	066
6.70	8	91	53	43	36	067
6.80	8	91	53	43	36	068
6.90	8	91	53	43	36	069
7.00	8	91	53	43	36	070
7.10	8	91	53	43	36	071
7.20	8	91	53	43	36	072
7.30	8	91	53	43	36	073
7.40	8	91	53	43	36	074
7.50	8	91	53	43	36	075
7.55	8	91	53	43	36	975
7.60	8	91	53	43	36	076
7.70	8	91	53	43	36	077
7.80	8	91	53	43	36	078
7.90	8	91	53	43	36	079

11 606 ...

DC _{m7} mm	DCONMS _{h6} mm	OAL mm	LCF mm	LU mm	LS mm	
8.00	8	91	53	43	36	080
8.10	10	103	61	49	40	081
8.20	10	103	61	49	40	082
8.30	10	103	61	49	40	083
8.40	10	103	61	49	40	084
8.50	10	103	61	49	40	085
8.60	10	103	61	49	40	086
8.70	10	103	61	49	40	087
8.80	10	103	61	49	40	088
8.90	10	103	61	49	40	089
9.00	10	103	61	49	40	090
9.10	10	103	61	49	40	091
9.20	10	103	61	49	40	092
9.25	10	103	61	49	40	925
9.30	10	103	61	49	40	093
9.40	10	103	61	49	40	094
9.50	10	103	61	49	40	095
9.60	10	103	61	49	40	096
9.70	10	103	61	49	40	097
9.80	10	103	61	49	40	098
9.90	10	103	61	49	40	099
10.00	10	103	61	49	40	100
10.10	12	118	71	56	45	101
10.20	12	118	71	56	45	102
10.30	12	118	71	56	45	103
10.40	12	118	71	56	45	104
10.50	12	118	71	56	45	105
10.60	12	118	71	56	45	106
10.70	12	118	71	56	45	107
10.80	12	118	71	56	45	108
10.90	12	118	71	56	45	109
11.00	12	118	71	56	45	110
11.10	12	118	71	56	45	111
11.20	12	118	71	56	45	112
11.30	12	118	71	56	45	113
11.40	12	118	71	56	45	114
11.50	12	118	71	56	45	115
11.60	12	118	71	56	45	116
11.70	12	118	71	56	45	117
11.80	12	118	71	56	45	118
11.90	12	118	71	56	45	119
12.00	12	118	71	56	45	120

P	●
M	
K	●
N	
S	
H	
O	

→ v_c Page 41



Further dimensions and drills can be found in our
→ main catalogue in Chapter 2 Solid carbide drills

WTX – High Performance Drill, DIN 6537

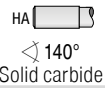
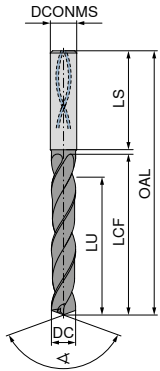
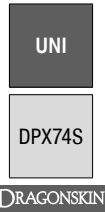
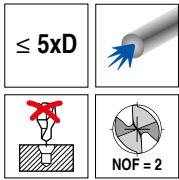

11 786 ...

DC _{m7} mm	DCONMS _{h6} mm	OAL mm	LCF mm	LU mm	LS mm	
3.00	6	66	28	23	36	03000
3.10	6	66	28	23	36	03100
3.15	6	66	28	23	36	03150
3.20	6	66	28	23	36	03200
3.22	6	66	28	23	36	03220
3.25	6	66	28	23	36	03250
3.30	6	66	28	23	36	03300
3.40	6	66	28	23	36	03400
3.50	6	66	28	23	36	03500
3.60	6	66	28	23	36	03600
3.70	6	66	28	23	36	03700
3.80	6	74	36	29	36	03800
3.85	6	74	36	29	36	03850
3.90	6	74	36	29	36	03900
4.00	6	74	36	29	36	04000
4.10	6	74	36	29	36	04100
4.20	6	74	36	29	36	04200
4.25	6	74	36	29	36	04250
4.30	6	74	36	29	36	04300
4.35	6	74	36	29	36	04350
4.40	6	74	36	29	36	04400
4.45	6	74	36	29	36	04450
4.50	6	74	36	29	36	04500
4.60	6	74	36	29	36	04600
4.65	6	74	36	29	36	04650
4.70	6	74	36	29	36	04700
4.80	6	82	44	35	36	04800
4.90	6	82	44	35	36	04900
4.95	6	82	44	35	36	04950
5.00	6	82	44	35	36	05000
5.05	6	82	44	35	36	05050
5.10	6	82	44	35	36	05100
5.20	6	82	44	35	36	05200
5.30	6	82	44	35	36	05300
5.40	6	82	44	35	36	05400
5.50	6	82	44	35	36	05500
5.55	6	82	44	35	36	05550
5.60	6	82	44	35	36	05600
5.70	6	82	44	35	36	05700
5.75	6	82	44	35	36	05750
5.80	6	82	44	35	36	05800
5.90	6	82	44	35	36	05900
5.95	6	82	44	35	36	05950
6.00	6	82	44	35	36	06000
6.10	8	91	53	43	36	06100
6.20	8	91	53	43	36	06200
6.30	8	91	53	43	36	06300
6.40	8	91	53	43	36	06400
6.50	8	91	53	43	36	06500
6.60	8	91	53	43	36	06600
6.70	8	91	53	43	36	06700

11 786 ...

DC _{m7} mm	DCONMS _{h6} mm	OAL mm	LCF mm	LU mm	LS mm	
6.80	8	91	53	43	36	06800
6.90	8	91	53	43	36	06900
7.00	8	91	53	43	36	07000
7.10	8	91	53	43	36	07100
7.20	8	91	53	43	36	07200
7.30	8	91	53	43	36	07300
7.40	8	91	53	43	36	07400
7.45	8	91	53	43	36	07450
7.50	8	91	53	43	36	07500
7.60	8	91	53	43	36	07600
7.70	8	91	53	43	36	07700
7.80	8	91	53	43	36	07800
7.90	8	91	53	43	36	07900
8.00	8	91	53	43	36	08000
8.10	10	103	61	49	40	08100
8.20	10	103	61	49	40	08200
8.30	10	103	61	49	40	08300
8.40	10	103	61	49	40	08400
8.50	10	103	61	49	40	08500
8.60	10	103	61	49	40	08600
8.70	10	103	61	49	40	08700
8.80	10	103	61	49	40	08800
8.90	10	103	61	49	40	08900
9.00	10	103	61	49	40	09000
9.10	10	103	61	49	40	09100
9.20	10	103	61	49	40	09200
9.30	10	103	61	49	40	09300
9.35	10	103	61	49	40	09350
9.40	10	103	61	49	40	09400
9.45	10	103	61	49	40	09450
9.50	10	103	61	49	40	09500
9.60	10	103	61	49	40	09600
9.70	10	103	61	49	40	09700
9.80	10	103	61	49	40	09800
9.90	10	103	61	49	40	09900
10.00	10	103	61	49	40	10000
10.10	12	118	71	56	45	10100
10.20	12	118	71	56	45	10200
10.30	12	118	71	56	45	10300
10.40	12	118	71	56	45	10400
10.50	12	118	71	56	45	10500
10.55	12	118	71	56	45	10550
10.60	12	118	71	56	45	10600
10.70	12	118	71	56	45	10700
10.75	12	118	71	56	45	10750
10.80	12	118	71	56	45	10800
10.90	12	118	71	56	45	10900
11.00	12	118	71	56	45	11000
11.10	12	118	71	56	45	11100
11.20	12	118	71	56	45	11200
11.25	12	118	71	56	45	11250
11.30	12	118	71	56	45	11300
11.35	12	118	71	56	45	11350
11.40	12	118	71	56	45	11400
11.45	12	118	71	56	45	11450
11.50	12	118	71	56	45	11500
11.60	12	118	71	56	45	11600
11.70	12	118	71	56	45	11700
11.80	12	118	71	56	45	11800
11.90	12	118	71	56	45	11900
12.00	12	118	71	56	45	12000

P	●
M	
K	●
N	
S	
H	○
O	

→ v_c Page 34



Further dimensions and drills can be found in our
→ main catalogue in Chapter 2 Solid carbide drills

WTX – High-performance drill, DIN 6537

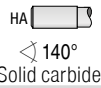
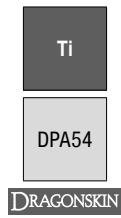
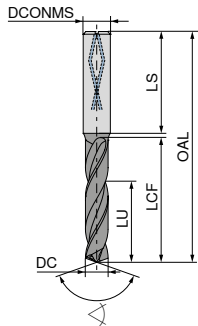
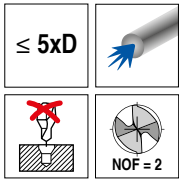

10 787 ...

DC _{m7} mm	DCONMS _{h6} mm	OAL mm	LCF mm	LU mm	LS mm	
3.00	6	66	28	23	36	030
3.10	6	66	28	23	36	031
3.20	6	66	28	23	36	032
3.30	6	66	28	23	36	033
3.40	6	66	28	23	36	034
3.50	6	66	28	23	36	035
3.60	6	66	28	23	36	036
3.70	6	66	28	23	36	037
3.80	6	74	36	29	36	038
3.90	6	74	36	29	36	039
3.97	6	74	36	29	36	900
4.00	6	74	36	29	36	040
4.10	6	74	36	29	36	041
4.20	6	74	36	29	36	042
4.23	6	74	36	29	36	901
4.30	6	74	36	29	36	043
4.40	6	74	36	29	36	044
4.50	6	74	36	29	36	045
4.60	6	74	36	29	36	046
4.70	6	74	36	29	36	047
4.80	6	82	44	35	36	048
4.90	6	82	44	35	36	049
5.00	6	82	44	35	36	050
5.10	6	82	44	35	36	051
5.20	6	82	44	35	36	052
5.30	6	82	44	35	36	053
5.40	6	82	44	35	36	054
5.50	6	82	44	35	36	055
5.56	6	82	44	35	36	902
5.60	6	82	44	35	36	056
5.70	6	82	44	35	36	057
5.80	6	82	44	35	36	058
5.90	6	82	44	35	36	059
6.00	6	82	44	35	36	060
6.10	8	91	53	43	36	061
6.20	8	91	53	43	36	062
6.30	8	91	53	43	36	063
6.35	8	91	53	43	36	903
6.40	8	91	53	43	36	064
6.50	8	91	53	43	36	065
6.60	8	91	53	43	36	066
6.70	8	91	53	43	36	067
6.80	8	91	53	43	36	068
6.90	8	91	53	43	36	069
7.00	8	91	53	43	36	070
7.10	8	91	53	43	36	071
7.20	8	91	53	43	36	072
7.30	8	91	53	43	36	073
7.40	8	91	53	43	36	074
7.50	8	91	53	43	36	075
7.60	8	91	53	43	36	076

10 787 ...

DC _{m7} mm	DCONMS _{h6} mm	OAL mm	LCF mm	LU mm	LS mm	
7.70	8	91	53	43	36	077
7.80	8	91	53	43	36	078
7.90	8	91	53	43	36	079
7.94	8	91	53	43	36	904
8.00	8	91	53	43	36	080
8.10	10	103	61	49	40	081
8.20	10	103	61	49	40	082
8.30	10	103	61	49	40	083
8.40	10	103	61	49	40	084
8.50	10	103	61	49	40	085
8.60	10	103	61	49	40	086
8.70	10	103	61	49	40	087
8.80	10	103	61	49	40	088
8.90	10	103	61	49	40	089
9.00	10	103	61	49	40	090
9.10	10	103	61	49	40	091
9.20	10	103	61	49	40	092
9.30	10	103	61	49	40	093
9.40	10	103	61	49	40	094
9.50	10	103	61	49	40	095
9.53	10	103	61	49	40	905
9.60	10	103	61	49	40	096
9.70	10	103	61	49	40	097
9.80	10	103	61	49	40	098
9.90	10	103	61	49	40	099
10.00	10	103	61	49	40	100
10.10	12	118	71	54	45	101
10.20	12	118	71	54	45	102
10.30	12	118	71	54	45	103
10.40	12	118	71	54	45	104
10.50	12	118	71	54	45	105
10.60	12	118	71	54	45	106
10.70	12	118	71	54	45	107
10.80	12	118	71	54	45	108
10.90	12	118	71	54	45	109
11.00	12	118	71	54	45	110
11.10	12	118	71	54	45	111
11.11	12	118	71	54	45	906
11.20	12	118	71	54	45	112
11.30	12	118	71	54	45	113
11.40	12	118	71	54	45	114
11.50	12	118	71	54	45	115
11.60	12	118	71	54	45	116
11.70	12	118	71	54	45	117
11.80	12	118	71	54	45	118
11.90	12	118	71	54	45	119
12.00	12	118	71	54	45	120

P	○
M	●
K	
N	
S	●
H	
O	

→ v_c Page 35



Further dimensions and drills can be found in our
→ main catalogue in Chapter 2 Solid carbide drills

WTX – High Performance Drill, DIN 6537

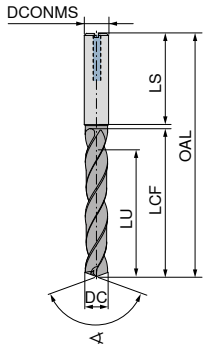
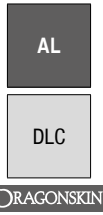
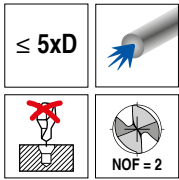

10 791 ...

DC _{h7} mm	DCONMS _{h6} mm	OAL mm	LCF mm	LU mm	LS mm	
2.5	4	57	21	17	28	02500
2.6	4	57	21	17	28	02600
2.7	4	57	21	17	28	02700
2.8	4	57	21	17	28	02800
2.9	4	57	21	17	28	02900
3.0	6	66	28	23	36	03000
3.1	6	66	28	23	36	03100
3.2	6	66	28	23	36	03200
3.3	6	66	28	23	36	03300
3.4	6	66	28	23	36	03400
3.5	6	66	28	23	36	03500
3.6	6	66	28	23	36	03600
3.7	6	66	28	23	36	03700
3.8	6	74	36	29	36	03800
3.9	6	74	36	29	36	03900
4.0	6	74	36	29	36	04000
4.1	6	74	36	29	36	04100
4.2	6	74	36	29	36	04200
4.3	6	74	36	29	36	04300
4.4	6	74	36	29	36	04400
4.5	6	74	36	29	36	04500
4.6	6	74	36	29	36	04600
4.7	6	74	36	29	36	04700
4.8	6	82	44	35	36	04800
4.9	6	82	44	35	36	04900
5.0	6	82	44	35	36	05000
5.1	6	82	44	35	36	05100
5.2	6	82	44	35	36	05200
5.3	6	82	44	35	36	05300
5.4	6	82	44	35	36	05400
5.5	6	82	44	35	36	05500
5.6	6	82	44	35	36	05600
5.7	6	82	44	35	36	05700
5.8	6	82	44	35	36	05800
5.9	6	82	44	35	36	05900
6.0	6	82	44	35	36	06000
6.1	8	91	53	43	36	06100
6.2	8	91	53	43	36	06200
6.3	8	91	53	43	36	06300
6.4	8	91	53	43	36	06400
6.5	8	91	53	43	36	06500
6.6	8	91	53	43	36	06600
6.7	8	91	53	43	36	06700
6.8	8	91	53	43	36	06800
6.9	8	91	53	43	36	06900
7.0	8	91	53	43	36	07000
7.1	8	91	53	43	36	07100
7.2	8	91	53	43	36	07200
7.3	8	91	53	43	36	07300
7.4	8	91	53	43	36	07400
7.5	8	91	53	43	36	07500

10 791 ...

DC _{h7} mm	DCONMS _{h6} mm	OAL mm	LCF mm	LU mm	LS mm	
7.6	8	91	53	43	36	07600
7.7	8	91	53	43	36	07700
7.8	8	91	53	43	36	07800
7.9	8	91	53	43	36	07900
8.0	8	91	53	43	36	08000
8.1	10	103	61	49	40	08100
8.2	10	103	61	49	40	08200
8.3	10	103	61	49	40	08300
8.4	10	103	61	49	40	08400
8.5	10	103	61	49	40	08500
8.6	10	103	61	49	40	08600
8.7	10	103	61	49	40	08700
8.8	10	103	61	49	40	08800
8.9	10	103	61	49	40	08900
9.0	10	103	61	49	40	09000
9.1	10	103	61	49	40	09100
9.2	10	103	61	49	40	09200
9.3	10	103	61	49	40	09300
9.4	10	103	61	49	40	09400
9.5	10	103	61	49	40	09500
9.6	10	103	61	49	40	09600
9.7	10	103	61	49	40	09700
9.8	10	103	61	49	40	09800
9.9	10	103	61	49	40	09900
10.0	10	103	61	49	40	10000
10.1	12	118	71	56	45	10100
10.2	12	118	71	56	45	10200
10.3	12	118	71	56	45	10300
10.4	12	118	71	56	45	10400
10.5	12	118	71	56	45	10500
10.6	12	118	71	56	45	10600
10.7	12	118	71	56	45	10700
10.8	12	118	71	56	45	10800
11.0	12	118	71	56	45	11000
11.1	12	118	71	56	45	11100
11.2	12	118	71	56	45	11200
11.3	12	118	71	56	45	11300
11.4	12	118	71	56	45	11400
11.5	12	118	71	56	45	11500
11.7	12	118	71	56	45	11700
11.8	12	118	71	56	45	11800
12.0	12	118	71	56	45	12000

P
M
K
N
S
H
O

→ v_c Page 35



Further dimensions and drills can be found in our
→ main catalogue in Chapter 2 Solid carbide drills

WPC – High Performance Drill, DIN 6537

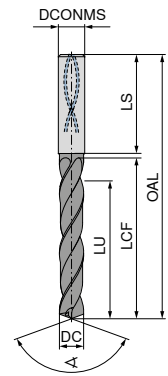
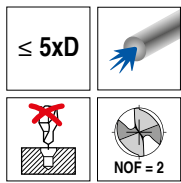

UNI
TiAIN



HA

140°
Solid carbide

11 609 ...

DC _{m7} mm	DCONMS _{h6} mm	OAL mm	LCF mm	LU mm	LS mm	
1.00	4	45	8.0	6.5	30.0	010
1.10	4	45	8.8	7.2	29.0	011
1.20	4	45	9.6	7.8	29.0	012
1.30	4	45	10.4	8.5	28.5	013
1.40	4	45	11.2	9.1	28.0	014
1.50	4	50	12.0	9.8	32.0	015
1.60	4	50	12.8	10.4	31.0	016
1.70	4	50	13.6	11.1	30.5	017
1.80	4	50	14.4	11.7	30.0	018
1.90	4	50	15.2	12.4	29.5	019
2.00	4	50	16.0	13.0	29.0	020
2.10	4	55	16.8	13.7	33.0	021
2.20	4	55	17.6	14.3	32.5	022
2.30	4	55	18.4	15.0	32.0	023
2.40	4	55	19.2	15.6	31.5	024
2.50	4	55	20.0	16.3	30.5	025
2.60	4	55	20.8	16.9	30.0	026
2.70	4	55	21.6	17.6	29.0	027
2.80	4	55	22.4	18.2	29.0	028
2.90	4	55	23.2	18.9	28.5	029
3.00	6	66	28.0	23.0	36.0	030
3.10	6	66	28.0	23.0	36.0	031
3.20	6	66	28.0	23.0	36.0	032
3.25	6	66	28.0	23.0	36.0	890
3.30	6	66	28.0	23.0	36.0	033
3.40	6	66	28.0	23.0	36.0	034
3.50	6	66	28.0	23.0	36.0	035
3.60	6	66	28.0	23.0	36.0	036
3.70	6	66	28.0	23.0	36.0	037
3.80	6	74	36.0	29.0	36.0	038
3.90	6	74	36.0	29.0	36.0	039
4.00	6	74	36.0	29.0	36.0	040
4.10	6	74	36.0	29.0	36.0	041
4.20	6	74	36.0	29.0	36.0	042
4.30	6	74	36.0	29.0	36.0	043
4.40	6	74	36.0	29.0	36.0	044
4.50	6	74	36.0	29.0	36.0	045
4.60	6	74	36.0	29.0	36.0	046
4.65	6	74	36.0	29.0	36.0	900
4.70	6	74	36.0	29.0	36.0	047
4.80	6	82	44.0	35.0	36.0	048
4.90	6	82	44.0	35.0	36.0	049
5.00	6	82	44.0	35.0	36.0	050
5.10	6	82	44.0	35.0	36.0	051
5.20	6	82	44.0	35.0	36.0	052
5.30	6	82	44.0	35.0	36.0	053
5.40	6	82	44.0	35.0	36.0	054
5.50	6	82	44.0	35.0	36.0	055
5.55	6	82	44.0	35.0	36.0	902
5.60	6	82	44.0	35.0	36.0	056
5.70	6	82	44.0	35.0	36.0	057
5.80	6	82	44.0	35.0	36.0	058
5.90	6	82	44.0	35.0	36.0	059
6.00	6	82	44.0	35.0	36.0	060
6.10	8	91	53.0	43.0	36.0	061
6.20	8	91	53.0	43.0	36.0	062

11 609 ...

DC _{m7} mm	DCONMS _{h6} mm	OAL mm	LCF mm	LU mm	LS mm	
6.30	8	91	53.0	43.0	36.0	063
6.40	8	91	53.0	43.0	36.0	064
6.50	8	91	53.0	43.0	36.0	065
6.60	8	91	53.0	43.0	36.0	066
6.70	8	91	53.0	43.0	36.0	067
6.80	8	91	53.0	43.0	36.0	068
6.90	8	91	53.0	43.0	36.0	069
7.00	8	91	53.0	43.0	36.0	070
7.10	8	91	53.0	43.0	36.0	071
7.20	8	91	53.0	43.0	36.0	072
7.30	8	91	53.0	43.0	36.0	073
7.40	8	91	53.0	43.0	36.0	074
7.45	8	91	53.0	43.0	36.0	924
7.50	8	91	53.0	43.0	36.0	075
7.55	8	91	53.0	43.0	36.0	975
7.60	8	91	53.0	43.0	36.0	076
7.70	8	91	53.0	43.0	36.0	077
7.80	8	91	53.0	43.0	36.0	078
7.90	8	91	53.0	43.0	36.0	079
8.00	8	91	53.0	43.0	36.0	080
8.10	10	103	61.0	49.0	40.0	081
8.20	10	103	61.0	49.0	40.0	082
8.30	10	103	61.0	49.0	40.0	083
8.40	10	103	61.0	49.0	40.0	084
8.50	10	103	61.0	49.0	40.0	085
8.60	10	103	61.0	49.0	40.0	086
8.70	10	103	61.0	49.0	40.0	087
8.80	10	103	61.0	49.0	40.0	088
8.90	10	103	61.0	49.0	40.0	089
9.00	10	103	61.0	49.0	40.0	090
9.10	10	103	61.0	49.0	40.0	091
9.20	10	103	61.0	49.0	40.0	092
9.25	10	103	61.0	49.0	40.0	925
9.30	10	103	61.0	49.0	40.0	093
9.35	10	103	61.0	49.0	40.0	930
9.40	10	103	61.0	49.0	40.0	094
9.50	10	103	61.0	49.0	40.0	095
9.60	10	103	61.0	49.0	40.0	096
9.70	10	103	61.0	49.0	40.0	097
9.80	10	103	61.0	49.0	40.0	098
9.90	10	103	61.0	49.0	40.0	099
10.00	10	103	61.0	49.0	40.0	100
10.10	12	118	71.0	56.0	45.0	101
10.20	12	118	71.0	56.0	45.0	102
10.30	12	118	71.0	56.0	45.0	103
10.40	12	118	71.0	56.0	45.0	104
10.50	12	118	71.0	56.0	45.0	105
10.60	12	118	71.0	56.0	45.0	106
10.70	12	118	71.0	56.0	45.0	107
10.75	12	118	71.0	56.0	45.0	904
10.80	12	118	71.0	56.0	45.0	108
10.90	12	118	71.0	56.0	45.0	109
11.00	12	118	71.0	56.0	45.0	110
11.10	12	118	71.0	56.0	45.0	111
11.20	12	118	71.0	56.0	45.0	112
11.25	12	118	71.0	56.0	45.0	912
11.30	12	118	71.0	56.0	45.0	113
11.40	12	118	71.0	56.0	45.0	114
11.50	12	118	71.0	56.0	45.0	115
11.60	12	118	71.0	56.0	45.0	116
11.70	12	118	71.0	56.0	45.0	117
11.80	12	118	71.0	56.0	45.0	118
11.90	12	118	71.0	56.0	45.0	119
12.00	12	118	71.0	56.0	45.0	120

P	●
M	
K	●
N	
S	
H	
O	

→ v_c Page 41



Further dimensions and drills can be found in our
→ main catalogue in Chapter 2 Solid carbide drills

WTX – High Performance Drill, DIN 6537

- ▲ universal application
- ▲ four guidance lands

- ▲ polished chip flutes
- ▲ Type ALU 5xD on request

- ▲ PL = corner chamfers

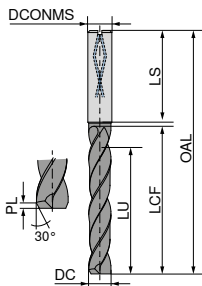
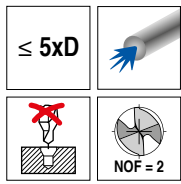

180
Ti800



HA

180°
Solid carbide

10 721 ...

DC _{m7} mm	DCONMS _{h6} mm	OAL mm	LCF mm	LU mm	LS mm	PL mm	
3.00	6	66	28	23	36	0.15	030
3.10	6	66	28	23	36	0.16	031
3.20	6	66	28	23	36	0.16	032
3.30	6	66	28	23	36	0.17	033
3.40	6	66	28	23	36	0.17	034
3.50	6	66	28	23	36	0.18	035
3.60	6	66	28	23	36	0.18	036
3.70	6	66	28	23	36	0.19	037
3.80	6	74	36	29	36	0.19	038
3.90	6	74	36	29	36	0.20	039
4.00	6	74	36	29	36	0.20	040
4.10	6	74	36	29	36	0.21	041
4.20	6	74	36	29	36	0.21	042
4.30	6	74	36	29	36	0.22	043
4.40	6	74	36	29	36	0.22	044
4.50	6	74	36	29	36	0.23	045
4.60	6	74	36	29	36	0.23	046
4.65	6	74	36	29	36	0.23	900
4.70	6	74	36	29	36	0.24	047
4.80	6	82	44	35	36	0.24	048
4.90	6	82	44	35	36	0.25	049
5.00	6	82	44	35	36	0.25	050
5.10	6	82	44	35	36	0.26	051
5.20	6	82	44	35	36	0.26	052
5.30	6	82	44	35	36	0.27	053
5.40	6	82	44	35	36	0.27	054
5.50	6	82	44	35	36	0.28	055
5.55	6	82	44	35	36	0.28	902
5.60	6	82	44	35	36	0.28	056
5.70	6	82	44	35	36	0.29	057
5.80	6	82	44	35	36	0.29	058
5.90	6	82	44	35	36	0.30	059
6.00	6	82	44	35	36	0.30	060
6.10	8	91	53	43	36	0.31	061
6.20	8	91	53	43	36	0.31	062
6.30	8	91	53	43	36	0.32	063
6.40	8	91	53	43	36	0.32	064
6.50	8	91	53	43	36	0.33	065
6.60	8	91	53	43	36	0.33	066
6.70	8	91	53	43	36	0.34	067
6.80	8	91	53	43	36	0.34	068
6.90	8	91	53	43	36	0.35	069
7.00	8	91	53	43	36	0.35	070
7.10	8	91	53	43	36	0.36	071
7.20	8	91	53	43	36	0.36	072
7.30	8	91	53	43	36	0.37	073
7.40	8	91	53	43	36	0.37	074
7.50	8	91	53	43	36	0.38	075
7.60	8	91	53	43	36	0.38	076
7.70	8	91	53	43	36	0.39	077
7.80	8	91	53	43	36	0.39	078
7.90	8	91	53	43	36	0.40	079
8.00	8	91	53	43	36	0.40	080
8.10	10	103	61	49	40	0.41	081

10 721 ...

DC _{m7} mm	DCONMS _{h6} mm	OAL mm	LCF mm	LU mm	LS mm	PL mm	
8.20	10	103	61	49	40	0.41	082
8.30	10	103	61	49	40	0.42	083
8.40	10	103	61	49	40	0.42	084
8.50	10	103	61	49	40	0.43	085
8.60	10	103	61	49	40	0.43	086
8.70	10	103	61	49	40	0.44	087
8.80	10	103	61	49	40	0.44	088
8.90	10	103	61	49	40	0.45	089
9.00	10	103	61	49	40	0.45	090
9.10	10	103	61	49	40	0.46	091
9.20	10	103	61	49	40	0.46	092
9.30	10	103	61	49	40	0.47	093
9.40	10	103	61	49	40	0.47	094
9.50	10	103	61	49	40	0.48	095
9.60	10	103	61	49	40	0.48	096
9.70	10	103	61	49	40	0.49	097
9.80	10	103	61	49	40	0.49	098
9.90	10	103	61	49	40	0.50	099
10.00	10	103	61	49	40	0.50	100
10.10	12	116	69	54	45	0.51	101
10.20	12	116	69	54	45	0.51	102
10.30	12	116	69	54	45	0.52	103
10.40	12	116	69	54	45	0.52	104
10.50	12	116	69	54	45	0.53	105
10.60	12	116	69	54	45	0.53	106
10.70	12	116	69	54	45	0.54	107
10.80	12	116	69	54	45	0.54	108
10.90	12	116	69	54	45	0.55	109
11.00	12	116	69	54	45	0.55	110
11.10	12	116	69	54	45	0.56	111
11.20	12	116	69	54	45	0.56	112
11.30	12	116	69	54	45	0.57	113
11.40	12	116	69	54	45	0.57	114
11.50	12	116	69	54	45	0.58	115
11.60	12	116	69	54	45	0.58	116
11.70	12	116	69	54	45	0.59	117
11.80	12	116	69	54	45	0.59	118
11.90	12	116	69	54	45	0.60	119
12.00	12	116	69	54	45	0.60	120

P	●
M	●
K	●
N	
S	
H	
O	

→ v_c Page 39



Further dimensions and drills can be found in our
→ main catalogue in Chapter 2 Solid carbide drills

WTX – High Performance Drills

▲ standard shank Ø 3 mm h6 for use
in heat shrink adapters

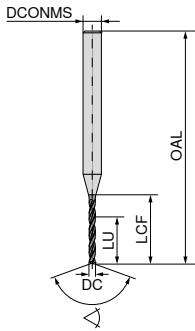
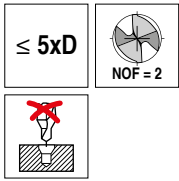

MINI
TiAlN



140°
Solid carbide

11 770 ...

DC _{+0,004} mm	DCONMS _{h6} mm	OAL mm	LCF mm	LU mm	
0.10	3	38	1.2	1.0	00100
0.15	3	38	2.0	1.7	00150
0.20	3	38	3.5	3.0	00200
0.25	3	38	3.5	3.0	00250
0.30	3	38	5.5	5.0	00300
0.35	3	38	5.5	5.0	00350
0.40	3	38	7.0	6.0	00400
0.45	3	38	7.0	6.0	00450
0.50	3	38	7.0	6.0	00500
0.55	3	38	7.0	6.0	00550
0.60	3	38	7.0	6.0	00600
0.65	3	38	7.0	6.0	00650
0.70	3	38	10.5	8.0	00700
0.75	3	38	10.5	8.0	00750
0.80	3	38	10.5	8.0	00800
0.85	3	38	10.5	8.0	00850
0.90	3	38	10.5	8.0	00900
0.95	3	38	10.5	8.0	00950
0.97	3	38	10.5	8.0	00970
0.98	3	38	10.5	8.0	00980
0.99	3	38	10.5	8.0	00990
1.00	3	38	10.5	8.0	01000
1.01	3	38	10.5	8.0	01010
1.02	3	38	10.5	8.0	01020
1.03	3	38	10.5	8.0	01030
1.05	3	38	10.5	8.0	01050
1.10	3	38	10.5	8.0	01100
1.15	3	38	10.5	8.0	01150
1.20	3	38	10.5	8.0	01200
1.25	3	38	10.5	8.0	01250
1.30	3	38	10.5	8.0	01300
1.35	3	38	10.5	8.0	01350
1.40	3	38	10.5	8.0	01400
1.45	3	38	10.5	8.0	01450
1.47	3	38	10.5	8.0	01470
1.48	3	38	10.5	8.0	01480
1.49	3	38	10.5	8.0	01490
1.50	3	38	10.5	8.0	01500
1.51	3	38	10.5	8.0	01510
1.52	3	38	10.5	8.0	01520
1.53	3	38	10.5	8.0	01530
1.55	3	38	10.5	8.0	01550
1.60	3	38	10.5	8.0	01600
1.65	3	38	10.5	8.0	01650
1.70	3	38	10.5	8.0	01700
1.75	3	38	10.5	8.0	01750

11 770 ...

DC _{+0,004} mm	DCONMS _{h6} mm	OAL mm	LCF mm	LU mm	
1.80	3	38	10.5	8.0	01800
1.85	3	38	12.0	8.0	01850
1.90	3	38	12.0	8.0	01900
1.95	3	38	12.0	8.0	01950
1.97	3	38	12.0	8.0	01970
1.98	3	38	12.0	8.0	01980
1.99	3	38	12.0	8.0	01990
2.00	3	42	13.0	9.0	02000
2.01	3	42	13.0	9.0	02010
2.02	3	42	13.0	9.0	02020
2.03	3	42	13.0	9.0	02030
2.05	3	42	13.0	9.0	02050
2.10	3	42	13.0	9.0	02100
2.15	3	42	13.0	9.0	02150
2.20	3	46	15.0	10.0	02200
2.25	3	46	15.0	10.0	02250
2.30	3	46	15.0	10.0	02300
2.35	3	46	15.0	10.0	02350
2.40	3	46	15.0	10.0	02400
2.45	3	46	15.0	10.0	02450
2.47	3	46	15.0	10.0	02470
2.48	3	46	15.0	10.0	02480
2.49	3	46	15.0	10.0	02490
2.50	3	46	15.0	10.0	02500
2.51	3	46	15.0	10.0	02510
2.52	3	46	15.0	10.0	02520
2.53	3	46	15.0	10.0	02530
2.60	3	46	15.0	10.0	02600
2.70	3	46	15.0	10.0	02700
2.80	3	46	15.0	10.0	02800
2.90	3	46	15.0	10.0	02900

P	○
M	○
K	●
N	●
S	○
H	
O	

→ v_c Page 36

WTX – High Performance Drills

- ▲ Specialised micro drill
- ▲ Universal application
- ▲ Extremely high process security
- ▲ Pilot drill for WTX Micro – high-performance deep hole drill

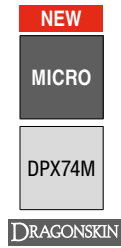
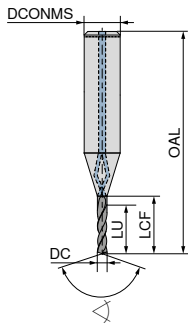
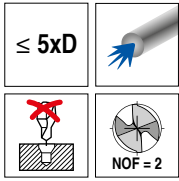

HA \sphericalangle 135°
Solid carbide

10 693 ...

DC _{m6} mm	DCONMS _{h6} mm	OAL mm	LCF mm	LU mm	
0.8	3	39	5.6	4.0	00800
0.9	3	39	6.3	4.5	00900
1.0	3	40	7.0	5.0	01000
1.1	3	41	7.7	5.5	01100
1.2	3	41	8.4	6.0	01200
1.3	3	42	9.1	6.5	01300
1.4	3	42	9.8	7.0	01400
1.5	3	43	10.5	7.5	01500
1.6	3	44	11.2	8.0	01600
1.7	3	44	11.9	8.5	01700
1.8	3	45	12.6	9.0	01800
1.9	3	45	13.3	9.5	01900
2.0	3	46	14.0	10.0	02000
2.1	3	47	14.7	10.5	02100
2.2	3	47	15.4	11.0	02200
2.3	3	48	16.1	11.5	02300
2.4	3	48	16.8	12.0	02400
2.5	3	49	17.5	12.5	02500
2.6	3	50	18.2	13.0	02600
2.7	3	50	18.9	13.5	02700
2.8	3	51	19.6	14.0	02800
2.9	3	51	20.3	14.5	02900

P	●
M	●
K	●
N	●
S	○
H	
O	

→ v_c Page 36

Minimum coolant pressure: 30 bar

WTX – High Performance Drills

- ▲ Specialised micro drill
- ▲ Universal application
- ▲ Extremely high process security

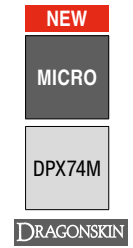
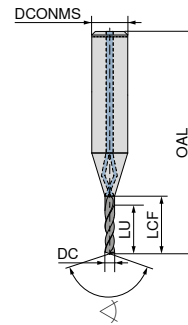
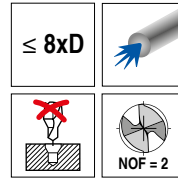

HA \sphericalangle 128°
Solid carbide

10 694 ...

DC _{h6} mm	DCONMS _{h6} mm	OAL mm	LCF mm	LU mm	
0.8	3	41	8	6.4	00800
0.9	3	42	9	7.2	00900
1.0	3	43	10	8.0	01000
1.1	3	44	11	8.8	01100
1.2	3	45	12	9.6	01200
1.3	3	46	13	10.4	01300
1.4	3	47	14	11.2	01400
1.5	3	47	15	12.0	01500
1.6	3	48	16	12.8	01600
1.7	3	49	17	13.6	01700
1.8	3	50	18	14.4	01800
1.9	3	51	19	15.2	01900
2.0	3	52	20	16.0	02000
2.1	3	53	21	16.8	02100
2.2	3	54	22	17.6	02200
2.3	3	55	23	18.4	02300
2.4	3	56	24	19.2	02400
2.5	3	56	25	20.0	02500
2.6	3	57	26	20.8	02600
2.7	3	58	27	21.6	02700
2.8	3	59	28	22.4	02800
2.9	3	60	29	23.2	02900

P	●
M	●
K	●
N	●
S	○
H	
O	

→ v_c Page 37

Minimum coolant pressure: 30 bar

WTX – High Performance Drills

- ▲ Specialised micro drill
- ▲ Universal application
- ▲ Extremely high process security
- ▲ Pilot drill: 5xD WTX – Micro – high-performance drill

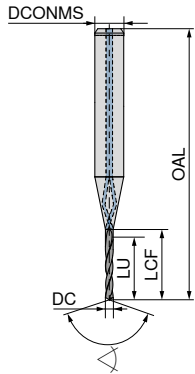
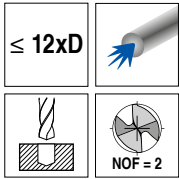

10 695 ...

DC _{h6} mm	DCONMS _{h6} mm	OAL mm	LCF mm	LU mm	
0.8	3	44	11.2	9.6	00800
0.9	3	46	12.6	10.8	00900
1.0	3	47	14.0	12.0	01000
1.1	3	48	15.4	13.2	01100
1.2	3	50	16.8	14.4	01200
1.3	3	51	18.2	15.6	01300
1.4	3	52	19.6	16.8	01400
1.5	3	53	21.0	18.0	01500
1.6	3	55	22.4	19.2	01600
1.7	3	56	23.8	20.4	01700
1.8	3	57	25.2	21.6	01800
1.9	3	59	26.6	22.8	01900
2.0	3	60	28.0	24.0	02000
2.1	3	61	29.4	25.2	02100
2.2	3	63	30.8	26.4	02200
2.3	3	64	32.2	27.6	02300
2.4	3	65	33.6	28.8	02400
2.5	3	67	35.0	30.0	02500
2.6	3	68	36.4	31.2	02600
2.7	3	69	37.8	32.4	02700
2.8	3	70	39.2	33.6	02800
2.9	3	72	40.6	34.8	02900

P	●
M	●
K	●
N	●
S	○
H	
O	

→ v_c Page 37

Minimum coolant pressure: 30 bar

NC Spot Drill, factory standard

▲ Spiral flutes

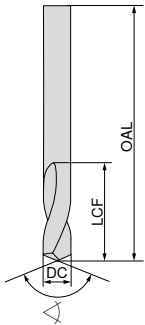

HA

120°

Solid carbide

10 703 ...

DC _{h5} mm	OAL mm	LCF mm	
2	32	6	002
3	32	8	003
4	40	10	004
5	50	13	005
6	50	13	006
8	60	23	008
10	70	24	010
12	70	24	012
P			○
M			
K			●
N			●
S			
H			
O			

→ v_c Page 42

Material examples for cutting data tables

	Material sub-group	Index	Composition / Structure / Heat treatment	Tensile strength N/mm ² / HB / HRC	Material number	Material designation	Material number	Material designation
P	Unalloyed steel	P.1.1	< 0,15 % C Annealed	420 N/mm ² / 125 HB	1.0401	C15	1.1141	Ck15
		P.1.2	< 0,45 % C Annealed	640 N/mm ² / 190 HB	1.1191	C45E	1.0718	9SMnPb28
		P.1.3	< 0,45 % C Tempered	840 N/mm ² / 250 HB	1.1191	C45E	1.0535	C55
		P.1.4	< 0,75 % C Annealed	910 N/mm ² / 270 HB	1.1223	C60R	1.0535	C55
		P.1.5	< 0,75 % C Tempered	1010 N/mm ² / 300 HB	1.1223	C60R	1.0727	45S20
	Low-alloy steel	P.2.1	Annealed	610 N/mm ² / 180 HB	1.7131	16MnCr5	1.6587	17CrNiMo6
		P.2.2	Tempered	930 N/mm ² / 275 HB	1.7131	16MnCr5	1.6587	17CrNiMo6
		P.2.3	Tempered	1010 N/mm ² / 300 HB	1.7225	42CrMo4	1.3505	100Cr6
		P.2.4	Tempered	1200 N/mm ² / 375 HB	1.7225	42CrMo4	1.3505	100Cr6
	High-alloy steel and high-alloy tool steel	P.3.1	Annealed	680 N/mm ² / 200 HB	1.4021	X20Cr13	1.4034	X46Cr13
		P.3.2	Hardened and tempered	1100 N/mm ² / 300 HB	1.2343	X38CrMoV5-1	1.4034	X46Cr13
		P.3.3	Hardened and tempered	1300 N/mm ² / 400 HB	1.2343	X38CrMoV5-1	1.4034	X46Cr13
	Stainless steel	P.4.1	Ferritic / martensitic Annealed	680 N/mm ² / 200 HB	1.4016	X6Cr17	1.2316	X36CrMo16
		P.4.2	Martensitic Tempered	1010 N/mm ² / 300 HB	1.4112	X90CrMoV18	1.2316	X36CrMo16
M	Stainless steel	M.1.1	Austenitic / austenitic-ferritic Quenched	610 N/mm ² / 180 HB	1.4301	X5CrNi18-10	1.4571	X6CrNiMoTi17-12-2
		M.2.1	Austenitic Tempered	300 HB	1.4841	X15CrNiSi25-21	1.4539	X1NiCrMoCu25-20-5
		M.3.1	Austenitic / ferritic (Duplex)	780 N/mm ² / 230 HB	1.4462	X2CrNiMoN22-5-3	1.4501	X2CrNiMoCuWN25-7-4
K	Grey cast iron	K.1.1	Pearlitic / ferritic	350 N/mm ² / 180 HB	0.6010	GG-10	0.6025	GG-25
		K.1.2	Pearlitic (martensitic)	500 N/mm ² / 260 HB	0.6030	GG-30	0.6045	GG-45
	Spherulitic graphite cast iron	K.2.1	Ferritic	540 N/mm ² / 160 HB	0.7040	GGG-40	0.7060	GGG-60
		K.2.2	Pearlitic	845 N/mm ² / 250 HB	0.7070	GGG-70	0.7080	GGG-80
	Malleable iron	K.3.1	Ferritic	440 N/mm ² / 130 HB	0.8035	GTW-35-04	0.8045	GTW-45
		K.3.2	Pearlitic	780 N/mm ² / 230 HB	0.8165	GTS-65-02	0.8170	GTS-70-02
N	Aluminium wrought alloy	N.1.1	Non-hardenable	60 HB	3.0255	Al99,5	3.3315	AlMg1
		N.1.2	Hardenable Age-hardened	340 N/mm ² / 100 HB	3.1355	AlCuMg2	3.2315	AlMgSi1
	Cast aluminium alloy	N.2.1	≤ 12 % Si, non-hardenable	250 N/mm ² / 75 HB	3.2581	G-AlSi12	3.2163	G-AlSi9Cu3
		N.2.2	≤ 12 % Si, hardenable Age-hardened	300 N/mm ² / 90 HB	3.2134	G-AlSi5Cu1Mg	3.2373	G-AlSi9Mg
		N.2.3	> 12 % Si, non-hardenable	440 N/mm ² / 130 HB		G-AlSi17Cu4Mg		G-AlSi18CuNiMg
	Copper and copper alloys (bronze/brass)	N.3.1	Free-machining alloys, PB > 1 %	375 N/mm ² / 110 HB	2.0380	CuZn39Pb2 (Ms58)	2.0410	CuZn44Pb2
		N.3.2	CuZn, CuSnZn	300 N/mm ² / 90 HB	2.0331	CuZn15	2.4070	CuZn28Sn1As
		N.3.3	CuSn, lead-free copper and electrolytic copper	340 N/mm ² / 100 HB	2.0060	E-Cu57	2.0590	CuZn40Fe
	Magnesium alloys	N.4.1	Magnesium and magnesium alloys	70 HB	3.5612	MgAl6Zn	3.5312	MgAl3Zn
	S	Heat-resistant alloys	S.1.1	Fe - basis Annealed	680 N/mm ² / 200 HB	1.4864	X12NiCrSi 36-16	1.4865
S.1.2			Fe - basis Age-hardened	950 N/mm ² / 280 HB	1.4980	X6NiCrTiMoVB25-15-2	1.4876	X10NiCrAlTi32-20
S.2.1			Ni or Co basis Annealed	840 N/mm ² / 250 HB	2.4631	NiCr20TiAl (Nimonic80A)	3.4856	NiCr22Mo9Nb
S.2.2			Ni or Co basis Age-hardened	1180 N/mm ² / 350 HB	2.4668	NiCr19Nb5Mo3 (Inconel 718)	2.4955	NiFe25Cr20NbTi
S.2.3			Ni or Co basis Cast	1080 N/mm ² / 320 HB	2.4765	CoCr20W15Ni	1.3401	G-X120Mn12
Titanium alloys		S.3.1	Pure titanium	400 N/mm ²	3.7025	Ti99,8	3.7034	Ti99,7
		S.3.2	Alpha + beta alloys Age-hardened	1050 N/mm ² / 320 HB	3.7165	TiAl6V4	Ti-6246	Ti-6Al-2Sn-4Zr-6Mo
		S.3.3	Beta alloys	1400 N/mm ² / 410 HB	Ti555.3	Ti-5Al-5V-5Mo-3Cr	R56410	Ti-10V-2Fe-3Al
H	Hardened steel	H.1.1	Hardened and tempered	46-55 HRC				
		H.1.2	Hardened and tempered	56-60 HRC				
		H.1.3	Hardened and tempered	61-65 HRC				
		H.1.4	Hardened and tempered	66-70 HRC				
	Chilled iron	H.2.1	Cast	400 HB				
	Hardened cast iron	H.3.1	Hardened and tempered	55 HRC				
O	Non-metal materials	O.1.1	Plastics, duroplastic	≤ 150 N/mm ²				
		O.1.2	Plastics, thermoplastic	≤ 100 N/mm ²				
		O.2.1	Aramid fibre-reinforced	≤ 1000 N/mm ²				
		O.2.2	Glass/carbon-fibre reinforced	≤ 1000 N/mm ²				
		O.3.1	Graphite					

* Tensile strength

Cutting data standard values – WTX – UNI

Index	Drilling depth 3xD UNI 11 777 ..., 11 780 ...					Drilling depth 5xD UNI 11 783 ..., 11 786 ...				
	V _c m/min without through coolant	V _c m/min with through coolant	Ø 3-5 mm/rev.	Ø 5-8 mm/rev.	Ø 8-12 mm/rev.	V _c m/min without through coolant	V _c m/min with through coolant	Ø 3-5 mm/rev.	Ø 5-8 mm/rev.	Ø 8-12 mm/rev.
	P.1.1	110	120	0,13	0,18	0,25	110	120	0,13	0,18
P.1.2	105	115	0,12	0,18	0,24	105	115	0,12	0,18	0,24
P.1.3	100	110	0,12	0,17	0,23	100	110	0,12	0,17	0,23
P.1.4	95	105	0,11	0,16	0,21	95	105	0,11	0,16	0,21
P.1.5	90	100	0,11	0,15	0,20	90	100	0,11	0,15	0,20
P.2.1	105	120	0,15	0,22	0,29	105	120	0,15	0,22	0,29
P.2.2	95	110	0,14	0,20	0,27	95	110	0,14	0,20	0,27
P.2.3	85	100	0,13	0,18	0,24	85	100	0,13	0,18	0,24
P.2.4	65	75	0,12	0,16	0,21	65	75	0,12	0,16	0,21
P.3.1	70	85	0,12	0,18	0,24	70	85	0,12	0,18	0,24
P.3.2	60	65	0,11	0,15	0,20	60	65	0,11	0,15	0,20
P.3.3	50	65	0,09	0,12	0,15	50	65	0,09	0,12	0,15
P.4.1	50	65	0,08	0,12	0,16	50	65	0,08	0,12	0,16
P.4.2	50	65	0,08	0,12	0,16	50	65	0,08	0,12	0,16
M.1.1										
M.2.1										
M.3.1										
K.1.1	85	120	0,17	0,26	0,36	85	120	0,17	0,26	0,36
K.1.2	75	100	0,15	0,22	0,29	75	100	0,15	0,22	0,29
K.2.1	100	160	0,17	0,25	0,34	100	160	0,17	0,25	0,34
K.2.2	75	100	0,15	0,22	0,29	75	100	0,15	0,22	0,29
K.3.1	80	90	0,16	0,23	0,32	80	90	0,16	0,23	0,32
K.3.2	70	80	0,14	0,19	0,25	70	80	0,14	0,19	0,25
N.1.1										
N.1.2										
N.2.1										
N.2.2										
N.2.3										
N.3.1										
N.3.2										
N.3.3										
N.4.1										
S.1.1										
S.1.2										
S.2.1										
S.2.2										
S.2.3										
S.3.1										
S.3.2										
S.3.3										
H.1.1	25	25	0,06	0,08	0,11	25	25	0,06	0,08	0,11
H.1.2										
H.1.3										
H.1.4										
H.2.1	35	35	0,08	0,11	0,14	35	35	0,08	0,11	0,14
H.3.1										
O.1.1										
O.1.2										
O.2.1										
O.2.2										
O.3.1										



The cutting data depends extremely on the external conditions, the material and machine type.
The indicated values are possible values which have to be increased or reduced according to the application conditions.

Cutting data standard values – WTX – Ti / AL

Index	Hole depth 3xD / 5xD Ti 10 786 ..., 10 787 ...							Drilling depth 5xD AL 10 791 ...							
	V _c m/min	Ø 3-4	Ø 4-5	Ø 5-6	Ø 6-8	Ø 8-10	Ø 10-12	V _c m/min	Ø 2-3	Ø 3-4	Ø 4-5	Ø 5-6	Ø 6-8	Ø 8-10	Ø 10-12
	with through coolant	f mm/rev.	f mm/rev.	f mm/rev.	f mm/rev.	f mm/rev.	f mm/rev.	with through coolant	f mm/rev.	f mm/rev.	f mm/rev.	f mm/rev.	f mm/rev.	f mm/rev.	f mm/rev.
P.1.1															
P.1.2															
P.1.3															
P.1.4															
P.1.5															
P.2.1															
P.2.2															
P.2.3															
P.2.4															
P.3.1															
P.3.2															
P.3.3															
P.4.1	75	0,03	0,04	0,05	0,06	0,08	0,10								
P.4.2	65	0,03	0,04	0,05	0,06	0,08	0,10								
M.1.1	70	0,03	0,04	0,05	0,06	0,08	0,10								
M.2.1	70	0,03	0,04	0,05	0,06	0,08	0,10								
M.3.1	70	0,03	0,04	0,05	0,06	0,08	0,10								
K.1.1															
K.1.2															
K.2.1															
K.2.2															
K.3.1															
K.3.2															
N.1.1								360	0,15	0,20	0,23	0,25	0,29	0,32	0,35
N.1.2								400	0,15	0,20	0,23	0,25	0,29	0,32	0,35
N.2.1								360	0,20	0,23	0,25	0,28	0,32	0,35	0,38
N.2.2								400	0,20	0,23	0,25	0,28	0,32	0,35	0,38
N.2.3								350	0,15	0,20	0,23	0,25	0,29	0,32	0,35
N.3.1								200	0,08	0,11	0,13	0,15	0,19	0,23	0,26
N.3.2								200	0,08	0,11	0,13	0,15	0,19	0,23	0,26
N.3.3								160	0,08	0,11	0,13	0,15	0,19	0,23	0,26
N.4.1															
S.1.1	45	0,02	0,02	0,02	0,04	0,05	0,07								
S.1.2	45	0,02	0,02	0,02	0,04	0,05	0,07								
S.2.1	40	0,02	0,02	0,02	0,04	0,05	0,07								
S.2.2	40	0,02	0,02	0,02	0,04	0,05	0,07								
S.2.3															
S.3.1	55	0,02	0,02	0,02	0,04	0,05	0,07								
S.3.2	45	0,02	0,02	0,02	0,04	0,05	0,07								
S.3.3															
H.1.1															
H.1.2															
H.1.3															
H.1.4															
H.2.1															
H.3.1															
O.1.1															
O.1.2															
O.2.1															
O.2.2															
O.3.1															

 The cutting data depends extremely on the external conditions, the material and machine type.
The indicated values are possible values which have to be increased or reduced according to the application conditions.

Cutting data standard values – WTX – MINI / MICRO

Index	Drilling depth 5xD Mini 11 770 ...					Drilling depth 5xD Micro 10 693 ...								
	V _c m/min without through coolant	< Ø 1,0	> Ø 1,0–1,5	> Ø 1,5–2,0	> Ø 2,0–2,9	V _c m/min with through coolant	V _c m/min MMS	< Ø 1,0	> Ø 1,0–1,25	> Ø 1,25–1,5	> Ø 1,5–2,0	> Ø 2,0–2,5	> Ø 2,5–3,0	
	f mm/rev.	f mm/rev.	f mm/rev.	f mm/rev.	f mm/rev.	f mm/rev.	f mm/rev.	f mm/rev.	f mm/rev.	f mm/rev.	f mm/rev.	f mm/rev.	f mm/rev.	
P.1.1	75	0,01	0,01	0,0125	0,015	60	50	0,024	0,028	0,034	0,05	0,07	0,095	
P.1.2	65	0,02	0,02	0,025	0,03	50	45	0,024	0,028	0,034	0,05	0,07	0,095	
P.1.3	65	0,01	0,01	0,0125	0,015	50	45	0,024	0,028	0,034	0,05	0,07	0,095	
P.1.4	65	0,01	0,01	0,0125	0,015	50	45	0,024	0,028	0,034	0,05	0,07	0,095	
P.1.5	70	0,01	0,01	0,0125	0,015	50	45	0,024	0,028	0,034	0,05	0,07	0,095	
P.2.1	70	0,01	0,01	0,0125	0,015	60	50	0,024	0,028	0,034	0,05	0,07	0,095	
P.2.2	65	0,01	0,01	0,0125	0,015	50	45	0,024	0,028	0,034	0,05	0,07	0,095	
P.2.3	65	0,02	0,02	0,025	0,03	50	45	0,024	0,028	0,034	0,05	0,07	0,095	
P.2.4	65	0,01	0,01	0,0125	0,015									
P.3.1						50	45	0,024	0,028	0,034	0,05	0,07	0,095	
P.3.2						40	35	0,024	0,028	0,034	0,05	0,07	0,095	
P.3.3														
P.4.1						40		0,012	0,015	0,018	0,028	0,04	0,06	
P.4.2						25		0,012	0,015	0,018	0,028	0,04	0,06	
M.1.1						30		0,012	0,015	0,018	0,028	0,04	0,06	
M.2.1						30		0,012	0,015	0,018	0,028	0,04	0,06	
M.3.1						30		0,012	0,015	0,018	0,028	0,04	0,06	
K.1.1	70	0,01	0,01	0,0125	0,015	60	50	0,024	0,028	0,034	0,05	0,07	0,095	
K.1.2	70	0,01	0,01	0,0125	0,015	60	50	0,024	0,028	0,034	0,05	0,07	0,095	
K.2.1	70	0,01	0,01	0,0125	0,015	60	50	0,024	0,028	0,034	0,05	0,07	0,095	
K.2.2	70	0,01	0,01	0,0125	0,015	60	50	0,024	0,028	0,034	0,05	0,07	0,095	
K.3.1	70	0,01	0,01	0,0125	0,015	60	50	0,024	0,028	0,034	0,05	0,07	0,095	
K.3.2	70	0,01	0,01	0,0125	0,015	60	50	0,024	0,028	0,034	0,05	0,07	0,095	
N.1.1	200	0,01	0,01	0,0125	0,015									
N.1.2	200	0,01	0,01	0,0125	0,015									
N.2.1	160	0,01	0,01	0,0125	0,015									
N.2.2	180	0,01	0,01	0,0125	0,015									
N.2.3	130	0,01	0,01	0,0125	0,015									
N.3.1	160	0,01	0,01	0,0125	0,015									
N.3.2	160	0,01	0,01	0,0125	0,015									
N.3.3	100	0,01	0,01	0,0125	0,015									
N.4.1	200	0,01	0,01	0,0125	0,015									
S.1.1						15		0,012	0,015	0,018	0,028	0,04	0,06	
S.1.2						15		0,012	0,015	0,018	0,028	0,04	0,06	
S.2.1						10		0,012	0,015	0,018	0,028	0,04	0,06	
S.2.2						10		0,012	0,015	0,018	0,028	0,04	0,06	
S.2.3														
S.3.1	30	0,01	0,01	0,0125	0,015	20		0,012	0,015	0,018	0,028	0,04	0,06	
S.3.2	20	0,01	0,01	0,0125	0,015	10		0,012	0,015	0,018	0,028	0,04	0,06	
S.3.3														
H.1.1														
H.1.2														
H.1.3														
H.1.4														
H.2.1														
H.3.1														
O.1.1														
O.1.2														
O.2.1														
O.2.2														
O.3.1														



The cutting data depends extremely on the external conditions, the material and machine type.
The indicated values are possible values which have to be increased or reduced according to the application conditions.

		Hole depth 8xD / 12xD Micro 10 694 ..., 10 695 ...						
Index	V _c m/min with through coolant	V _c m/min MMS	< Ø 1,0	> Ø 1,0-1,25	> Ø 1,25-1,5	> Ø 1,5-2,0	> Ø 2,0-2,5	> Ø 2,5-3,0
			f mm/rev.	f mm/rev.	f mm/rev.	f mm/rev.	f mm/rev.	f mm/rev.
P.1.1	60	50	0,024	0,028	0,034	0,05	0,07	0,095
P.1.2	50	45	0,024	0,028	0,034	0,05	0,07	0,095
P.1.3	50	45	0,024	0,028	0,034	0,05	0,07	0,095
P.1.4	50	45	0,024	0,028	0,034	0,05	0,07	0,095
P.1.5	50	45	0,024	0,028	0,034	0,05	0,07	0,095
P.2.1	60	50	0,024	0,028	0,034	0,05	0,07	0,095
P.2.2	50	45	0,024	0,028	0,034	0,05	0,07	0,095
P.2.3	50	45	0,024	0,028	0,034	0,05	0,07	0,095
P.2.4								
P.3.1	50	45	0,024	0,028	0,034	0,05	0,07	0,095
P.3.2	40	35	0,024	0,028	0,034	0,05	0,07	0,095
P.3.3								
P.4.1	40		0,012	0,015	0,018	0,028	0,04	0,06
P.4.2	25		0,012	0,015	0,018	0,028	0,04	0,06
M.1.1	30		0,012	0,015	0,018	0,028	0,04	0,06
M.2.1	30		0,012	0,015	0,018	0,028	0,04	0,06
M.3.1	30		0,012	0,015	0,018	0,028	0,04	0,06
K.1.1	60	50	0,024	0,028	0,034	0,05	0,07	0,095
K.1.2	60	50	0,024	0,028	0,034	0,05	0,07	0,095
K.2.1	60	05	0,024	0,028	0,034	0,05	0,07	0,095
K.2.2	60	50	0,024	0,028	0,034	0,05	0,07	0,095
K.3.1	60	50	0,024	0,028	0,034	0,05	0,07	0,095
K.3.2	60	50	0,024	0,028	0,034	0,05	0,07	0,095
N.1.1								
N.1.2								
N.2.1								
N.2.2								
N.2.3								
N.3.1								
N.3.2								
N.3.3								
N.4.1								
S.1.1	15		0,012	0,015	0,018	0,028	0,04	0,06
S.1.2	15		0,012	0,015	0,018	0,028	0,04	0,06
S.2.1	10		0,012	0,015	0,018	0,028	0,04	0,06
S.2.2	10		0,012	0,015	0,018	0,028	0,04	0,06
S.2.3								
S.3.1	20		0,012	0,015	0,018	0,028	0,04	0,06
S.3.2	10		0,012	0,015	0,018	0,028	0,04	0,06
S.3.3								
H.1.1								
H.1.2								
H.1.3								
H.1.4								
H.2.1								
H.3.1								
O.1.1								
O.1.2								
O.2.1								
O.2.2								
O.3.1								

Cutting data standard values – WTX – 180

Drilling depth 3xD Type 180 10 720 ...				
Index	v_c m/min	\emptyset 3-5	\emptyset 5-8	\emptyset 8-12
	with through coolant	f mm/rev.	f mm/rev.	f mm/rev.
P.1.1	90	0,09	0,13	0,18
P.1.2	85	0,09	0,13	0,17
P.1.3	80	0,09	0,12	0,16
P.1.4	75	0,08	0,12	0,16
P.1.5	70	0,08	0,11	0,15
P.2.1	90	0,11	0,16	0,21
P.2.2	80	0,10	0,14	0,19
P.2.3	70	0,09	0,13	0,17
P.2.4	55	0,09	0,12	0,16
P.3.1	60	0,09	0,13	0,17
P.3.2	50	0,08	0,11	0,14
P.3.3	50	0,06	0,09	0,11
P.4.1	50	0,06	0,09	0,11
P.4.2	50	0,06	0,09	0,11
M.1.1	45	0,06	0,09	0,11
M.2.1	40	0,05	0,07	0,10
M.3.1	40	0,05	0,07	0,10
K.1.1	95	0,12	0,19	0,26
K.1.2	80	0,11	0,16	0,21
K.2.1	130	0,12	0,18	0,25
K.2.2	80	0,11	0,16	0,21
K.3.1	70	0,12	0,17	0,23
K.3.2	65	0,10	0,14	0,18
N.1.1				
N.1.2				
N.2.1				
N.2.2				
N.2.3				
N.3.1				
N.3.2				
N.3.3				
N.4.1				
S.1.1				
S.1.2				
S.2.1				
S.2.2				
S.2.3				
S.3.1				
S.3.2				
S.3.3				
H.1.1				
H.1.2				
H.1.3				
H.1.4				
H.2.1				
H.3.1				
O.1.1				
O.1.2				
O.2.1				
O.2.2				
O.3.1				

Cutting data standard values – WTX – 180

Index	Drilling depth 5xD Type 180 10 721 ...			
	v_c m/min	\emptyset 3–5	\emptyset 5–8	\emptyset 8–12
	with through coolant	f mm/rev.	f mm/rev.	f mm/rev.
P.1.1	90	0,09	0,13	0,18
P.1.2	85	0,09	0,13	0,17
P.1.3	80	0,09	0,12	0,16
P.1.4	75	0,08	0,12	0,16
P.1.5	70	0,08	0,11	0,15
P.2.1	90	0,11	0,16	0,21
P.2.2	80	0,10	0,14	0,19
P.2.3	70	0,09	0,13	0,17
P.2.4	55	0,09	0,12	0,16
P.3.1	60	0,09	0,13	0,17
P.3.2	50	0,08	0,11	0,14
P.3.3	50	0,06	0,09	0,11
P.4.1	50	0,06	0,09	0,11
P.4.2	50	0,06	0,09	0,11
M.1.1	45	0,06	0,09	0,11
M.2.1	40	0,05	0,07	0,10
M.3.1	40	0,05	0,07	0,10
K.1.1	95	0,12	0,19	0,26
K.1.2	80	0,11	0,16	0,21
K.2.1	130	0,12	0,18	0,25
K.2.2	80	0,11	0,16	0,21
K.3.1	70	0,12	0,17	0,23
K.3.2	65	0,10	0,14	0,18
N.1.1				
N.1.2				
N.2.1				
N.2.2				
N.2.3				
N.3.1				
N.3.2				
N.3.3				
N.4.1				
S.1.1				
S.1.2				
S.2.1				
S.2.2				
S.2.3				
S.3.1				
S.3.2				
S.3.3				
H.1.1				
H.1.2				
H.1.3				
H.1.4				
H.2.1				
H.3.1				
O.1.1				
O.1.2				
O.2.1				
O.2.2				
O.3.1				

**Application Note:****Spot drilling with reduced feedrate**

1. Feedrate f [mm/U] should be multiplied by correction factor A_k
2. Drill with reduced feed rate until tool is fully engaged in workpiece by approximately $0.25 \times D$
3. Retract from the hole at double the feed rate f in mm/U – only with inclined surfaces

This operation is necessary in order to achieve maximum performance of the drill!
4. Drill the hole with feed rate f [mm/U] without pecking for chip evacuation

Correction factor A_k for f [mm/U] when spot drilling

Inclination workpiece surface	A_k to 3xD (10 720 ...)	A_k to 5xD (10 721 ...)
15°	0,5	0,25
30°	0,4	not recommended
45°	0,25	not recommended



For drilling on flat surfaces (inclination 0°) with the WTX – 180 5xD, we recommend the use of a pilot drill. (WTX – UNI 3xD)

Cutting data standard values – WPC – UNI

Index	Drilling depth 3xD UNI 11 600 ..., 11 603 ...							
	v_c m/min	v_c m/min	\emptyset 1–1,5	\emptyset 1,5–2	\emptyset 2–3	\emptyset 3–5	\emptyset 5–8	\emptyset 8–12
	without through coolant	with through coolant	f mm/rev.	f mm/rev.	f mm/rev.	f mm/rev.	f mm/rev.	f mm/rev.
P.1.1	75	85	0,05	0,06	0,08	0,11	0,15	0,20
P.1.2	70	80	0,05	0,05	0,07	0,10	0,14	0,19
P.1.3	70	75	0,05	0,05	0,07	0,10	0,14	0,18
P.1.4	65	70	0,04	0,05	0,07	0,09	0,13	0,18
P.1.5	60	70	0,04	0,05	0,06	0,09	0,12	0,17
P.2.1	70	85	0,06	0,07	0,09	0,13	0,18	0,24
P.2.2	65	75	0,05	0,06	0,08	0,11	0,16	0,22
P.2.3	55	70	0,05	0,06	0,07	0,10	0,15	0,20
P.2.4	45	55	0,05	0,06	0,07	0,10	0,13	0,17
P.3.1	50	55	0,05	0,05	0,07	0,10	0,15	0,20
P.3.2	40	45	0,04	0,05	0,06	0,09	0,12	0,16
P.3.3	35	45	0,04	0,04	0,06	0,07	0,10	0,13
P.4.1	35	45	0,03	0,04	0,05	0,07	0,10	0,13
P.4.2	35	45	0,03	0,04	0,05	0,07	0,10	0,13
M.1.1								
M.2.1								
M.3.1								
K.1.1	60	80	0,04	0,06	0,09	0,14	0,21	0,30
K.1.2	50	70	0,05	0,06	0,09	0,12	0,18	0,24
K.2.1	70	110	0,05	0,07	0,09	0,14	0,20	0,28
K.2.2	50	70	0,05	0,06	0,09	0,12	0,18	0,24
K.3.1	55	60	0,06	0,07	0,09	0,13	0,19	0,26
K.3.2	50	55	0,05	0,06	0,08	0,11	0,16	0,21
N.1.1								
N.1.2								
N.2.1								
N.2.2								
N.2.3								
N.3.1								
N.3.2								
N.3.3								
N.4.1								
S.1.1								
S.1.2								
S.2.1								
S.2.2								
S.2.3								
S.3.1								
S.3.2								
S.3.3								
H.1.1								
H.1.2								
H.1.3								
H.1.4								
H.2.1								
H.3.1								
O.1.1								
O.1.2								
O.2.1								
O.2.2								
O.3.1								



The cutting data depends extremely on the external conditions, the material and machine type.
The indicated values are possible values which have to be increased or reduced according to the application conditions.

Cutting data standard values – WPC – UNI

Index	Drilling depth 5xD UNI 11 606 ..., 11 609 ...							
	v_c m/min without through coolant	v_c m/min with through coolant	\emptyset 1–1,5 f mm/rev.	\emptyset 1,5–2 f mm/rev.	\emptyset 2–3 f mm/rev.	\emptyset 3–5 f mm/rev.	\emptyset 5–8 f mm/rev.	\emptyset 8–12 f mm/rev.
	P.1.1	75	85	0,05	0,06	0,08	0,11	0,15
P.1.2	70	80	0,05	0,05	0,07	0,10	0,14	0,19
P.1.3	70	75	0,05	0,05	0,07	0,10	0,14	0,18
P.1.4	65	70	0,04	0,05	0,07	0,09	0,13	0,18
P.1.5	60	70	0,04	0,05	0,06	0,09	0,12	0,17
P.2.1	70	85	0,06	0,07	0,09	0,13	0,18	0,24
P.2.2	65	75	0,05	0,06	0,08	0,11	0,16	0,22
P.2.3	55	70	0,05	0,06	0,07	0,10	0,15	0,20
P.2.4	45	55	0,05	0,06	0,07	0,10	0,13	0,17
P.3.1	50	55	0,05	0,05	0,07	0,10	0,15	0,20
P.3.2	40	45	0,04	0,05	0,06	0,09	0,12	0,16
P.3.3	35	45	0,04	0,04	0,06	0,07	0,10	0,13
P.4.1	35	45	0,03	0,04	0,05	0,07	0,10	0,13
P.4.2	35	45	0,03	0,04	0,05	0,07	0,10	0,13
M.1.1								
M.2.1								
M.3.1								
K.1.1	60	80	0,04	0,06	0,09	0,14	0,21	0,30
K.1.2	50	70	0,05	0,06	0,09	0,12	0,18	0,24
K.2.1	70	110	0,05	0,07	0,09	0,14	0,20	0,28
K.2.2	50	70	0,05	0,06	0,09	0,12	0,18	0,24
K.3.1	55	60	0,06	0,07	0,09	0,13	0,19	0,26
K.3.2	50	55	0,05	0,06	0,08	0,11	0,16	0,21
N.1.1								
N.1.2								
N.2.1								
N.2.2								
N.2.3								
N.3.1								
N.3.2								
N.3.3								
N.4.1								
S.1.1								
S.1.2								
S.2.1								
S.2.2								
S.2.3								
S.3.1								
S.3.2								
S.3.3								
H.1.1								
H.1.2								
H.1.3								
H.1.4								
H.2.1								
H.3.1								
O.1.1								
O.1.2								
O.2.1								
O.2.2								
O.3.1								



The cutting data depends extremely on the external conditions, the material and machine type.
The indicated values are possible values which have to be increased or reduced according to the application conditions.

Cutting data standard values – solid carbide NC spot drills

Index	NC Spot Drill NC-A 10 702 ..., 10 703 ...							
	v_c m/min without through coolant	$\varnothing 2-3$	$\varnothing 3-4$	$\varnothing 4-5$	$\varnothing 5-6$	$\varnothing 6-8$	$\varnothing 8-10$	$\varnothing 10-12$
		f mm/rev.	f mm/rev.	f mm/rev.	f mm/rev.	f mm/rev.	f mm/rev.	f mm/rev.
P.1.1	75	0,05	0,07	0,08	0,10	0,12	0,14	0,16
P.1.2	65	0,05	0,07	0,08	0,10	0,12	0,14	0,16
P.1.3	65	0,04	0,05	0,06	0,08	0,10	0,11	0,13
P.1.4	65	0,04	0,05	0,06	0,08	0,10	0,11	0,13
P.1.5	70	0,04	0,05	0,06	0,08	0,10	0,11	0,13
P.2.1	70	0,05	0,07	0,08	0,10	0,12	0,14	0,16
P.2.2	65	0,04	0,05	0,06	0,08	0,10	0,11	0,13
P.2.3	65	0,05	0,07	0,08	0,10	0,12	0,14	0,16
P.2.4	65	0,04	0,05	0,06	0,08	0,10	0,11	0,13
P.3.1								
P.3.2								
P.3.3								
P.4.1								
P.4.2								
M.1.1								
M.2.1								
M.3.1								
K.1.1	70	0,04	0,05	0,06	0,08	0,10	0,13	0,15
K.1.2	70	0,04	0,05	0,06	0,08	0,10	0,11	0,13
K.2.1	70	0,04	0,05	0,06	0,08	0,10	0,11	0,13
K.2.2	70	0,04	0,05	0,06	0,08	0,10	0,11	0,13
K.3.1	70	0,04	0,05	0,06	0,08	0,10	0,11	0,13
K.3.2	70	0,04	0,05	0,06	0,08	0,10	0,11	0,13
N.1.1	200	0,01	0,01	0,02	0,02	0,03	0,04	0,05
N.1.2	200	0,01	0,01	0,02	0,02	0,03	0,04	0,05
N.2.1	160	0,01	0,01	0,02	0,02	0,03	0,04	0,05
N.2.2	180	0,01	0,01	0,02	0,02	0,03	0,04	0,05
N.2.3	130	0,01	0,01	0,02	0,02	0,03	0,04	0,05
N.3.1	160	0,01	0,01	0,01	0,01	0,02	0,03	0,04
N.3.2	160	0,01	0,01	0,01	0,01	0,02	0,03	0,04
N.3.3	100	0,01	0,01	0,01	0,01	0,02	0,03	0,04
N.4.1								
S.1.1								
S.1.2								
S.2.1								
S.2.2								
S.2.3								
S.3.1								
S.3.2								
S.3.3								
H.1.1								
H.1.2								
H.1.3								
H.1.4								
H.2.1								
H.3.1								
O.1.1								
O.1.2								
O.2.1								
O.2.2								
O.3.1								



The cutting data depends extremely on the external conditions, the material and machine type.
The indicated values are possible values which have to be increased or reduced according to the application conditions.

Important application criteria for WTX drills

Axial offset

The axial run-out of the axis between a rotating work piece and a stationary tool must not exceed 0.04 mm. A larger run-out reduces tool life and drilling quality and can lead to tool breakage.

Run-out

The concentricity error when the tool is rotating should not exceed 0.015 mm.

Cooling lubricant

With internally cooled tools the coolant pressure should be min. 20 bar.

High-quality semi-synthetic or emulsion coolants with min. 10 % oil content and EP additives are recommended. This allows better life, and achieves higher tolerance accuracy and better surface quality. A fine filter system is recommended to prevent possible clogging of the coolant channels.

Drilling into solid

Due to the geometric design of the solid carbide drills, they are suitable for drilling into solid material.

With solid carbide drills $\leq 12xD$ drilling can be carried out in solid material without the need for centering and spot drilling operations.

Flute run-out

When using WTX drills a safety margin of at least 1 to 1.5xD must be maintained between the work piece and the flute outlet groove of the drill to ensure optimum chip evacuation and prevent chip clogging and tool fracture.

Peck drilling

Pecking should be avoided as there is a very high risk of fracture caused by chips left behind or flushed into the hole.

Secondary tools

If a smaller diameter WTX drill is used as a following tool in the same hole, it should have a smaller drill point angle to ensure that it centres properly.

Interrupted Cuts

Reduce the feedrate on entry to and from cross holes

Drill exit

To avoid severe burr formation, reduce v_c and f .

Workpiece clamping

To avoid tool breakages, care must be taken to ensure a proper workpiece clamping without vibration or workpiece deflection.

Tool holding

With optimum clamping high alignment accuracy and tolerances (IT7-8) are possible.

Due to the high surface quality reaming operations can often be dispensed with.

Machine Requirements

Please note the performance diagram

Cutting data table

To control the chip length (comma chip) the feed rates should be no lower than the lower limits quoted in the cutting data table.

Feed rate f in mm/rev.

Drilling capacity relative to the diameter: $v_c = 80$ m/min.

Tensile strength of the material = 600 N/mm²

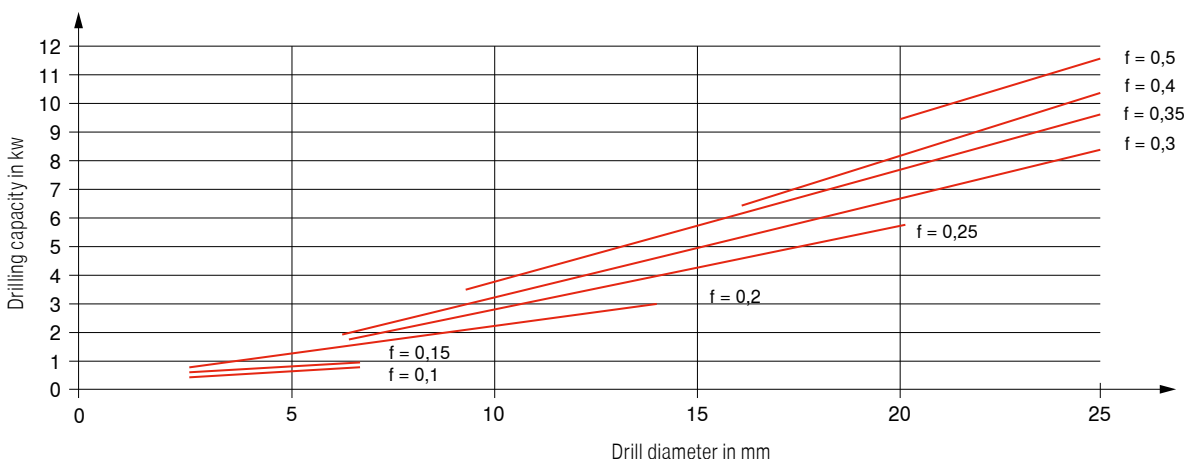

WTX – Micro – recommended application

General references

- ▲ During vertical machining, a pilot hole is not required for regular and straight surfaces from Ø 1.0 mm up to a length of 12xD due to the excellent self-centring. During horizontal drilling, a pilot drill must be used for irregular and angled surfaces.
The WTX Micro 5xD is recommended as a pilot drill.
- ▲ To guarantee problem-free insertion of the deep hole twist drill in the pilot hole, during horizontal machining 90° countersinking with suitable NC countersink is recommended.
- ▲ During vertical machining, drills from Ø 1.0 mm up to a length of 12xD can also be operated outside the pilot hole without a reduction in speed.
- ▲ For through holes, the feed per revolution must be reduced by 50% before exiting the hole.
- ▲ For long-chipping materials, pecking may be required every 3xD from a hole depth of 10xD. Peck drilling (retraction) should occur at the pilot hole depth.
- ▲ Due to the small thro' coolant Ø during micro drilling, effective filtration of the cooling medium is of the utmost importance.
Drill < Ø 2.0 mm Filter ≤ 0.010 mm
Drill < Ø 3.0 mm Filter ≤ 0.020 mm

- ▲ The longer the coolant is in the machine, suspended particles and particulate matter in the cooling medium prevent effective coolant flow. Regular replacement of the coolant is therefore recommended.
- ▲ A suitable clamping device with maximum radial run-out accuracy and balance quality is required for process-secure production.
Radial run-out accuracy ≤ 0.003 mm
Suitable for high-speed areas
- ▲ To guarantee a process-secure drilling process, a minimum pressure of 30 bar must be present.

1 Producing the pilot hole



- ▲ Pilot hole depth: min. 3xD
- ▲ It must be ensured that the prepared pilot hole is free from chips to avoid blocking of the micro deep hole twist drill cutting edges

2 Entering the pilot hole with a deep hole twist drill



- ▲ Speed 300 rpm (reverse rotation sometimes possible)
- ▲ Entry speed approx. 1000 mm/min
- ▲ Switch on cooling
- ▲ Increase parameters 0.5-1.0 mm before reaching the bottom of the pilot hole

3 Deep hole drilling



- ▲ At hole depth without pecking

4 Retracting the drill



- ▲ Retract drill approx. 1xD
- ▲ Reduce speed to 300 rpm
- ▲ Exit speed approx. 1000 mm/min
- ▲ Switch off emulsion before exiting the hole

Tolerances and angles

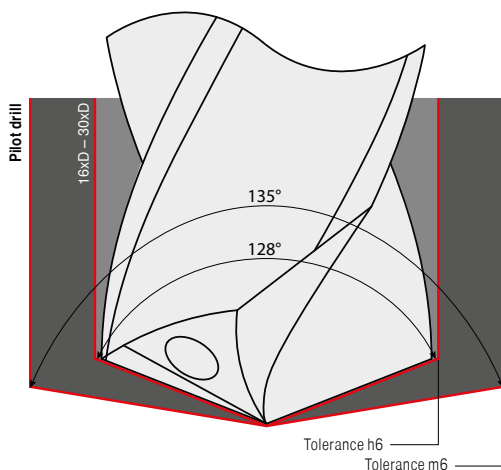

The following must apply to use the pilot and deep hole twist drill consecutively and without collisions:
 $\Delta D = \text{ØD (pilot hole)} - \text{ØD (deep hole)} > 0$

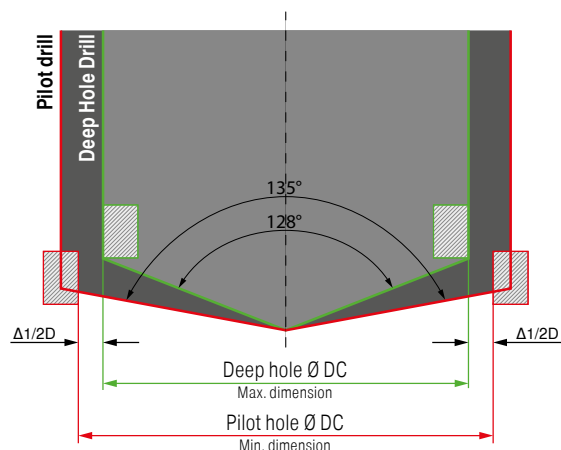

Recommendations for solid carbide drilling operations

Reasons for ...

Solutions ...

... Built-up edge

v_c too low
Too much material taken off at main cutting edge
Uncoated cutting edge

 Increase v_c
Reduce cut
Coating

... Corners broken off

Unstable conditions
Run out too high
Interrupted cut

 Change clamping
Optimize radial run-out
Reduce feed rate

... Heavy flank wear

v_c too low
Feed rate too low
Clearance angle too small

 Reduce v_c
Increase feed rate
Increase clearance angle

... Scoring on the tool flanks

Unstable conditions
Run out too high
Interrupted cut
Abrasive materials

 Change clamping
Correct radial run-out
Reduce feed rate
Thicker emulsion or oil

... Round chamfer wear

Unstable conditions
Run out too high
Back taper too small
Wrong emulsion or too thin emulsion

 More stable clamping
Check radial run-out
Increase back taper
Thicker emulsion or oil

... Material broken off at main cutting edge

Unstable conditions
Interrupted cut
Wrong type of tool
Max. tool life has been exceeded

 More stable clamping
Reduce feed rate
Optimize tool
Change tool earlier

... Heavy wear at chisel edge

v_c too low
Feed rate too high
Too much material taken off at main cutting edge

 Increase v_c
Reduce feed rate
Optimize cutting edge

... Material broken off at intersections, drill point and main cutting edge

Clearance angle too small
Too much material taken off at main cutting edge
Wrong tool

 Increase clearance angle
Optimize cutting edge
Other tool

... Plastic deformation of cutting corner

v_c too high
Insufficient emulsion
Wrong or no corner chamfer

 Reduce v_c
Increase amount of coolant
Correct corner chamfer

... Poor surface quality

Run out too high
Insufficient cooling
Unstable conditions

 Check radial run-out
More emulsion
Change toolholding

... Heavy burring on hole exit

Feed too high
Excessive honing of main cutting edge



 Reduce feed rate
Reduce cutting edge

Type overview – WTX High performance drilling tools

- ▲ good self-centring
- ▲ optimum swarf control
- ▲ precise radial run-out
- ▲ excellent alignment precision
- ▲ high-quality surface finish
- ▲ close drilling tolerances
- ▲ limited hardening of peripheral zones of the material
- ▲ good chip evacuation even with large drilling depths

 For all products that are marked with the video icon, a relevant product video can be viewed at cutting.tools/uk/type-overview-wtx





UNI		<ul style="list-style-type: none"> ▲ high-performance solid carbide drill for universal application, for all materials up to 1200 N/mm² 	DRAGONSKIN	
------------	---	---	-------------------	---

Ti		<ul style="list-style-type: none"> ▲ specialist for cost effective machining of titanium, titanium alloys and heat resistant alloys 	DRAGONSKIN	
-----------	---	--	-------------------	--

AL		<ul style="list-style-type: none"> ▲ solid carbide high performance drill specially for the machining of aluminium, copper and brass ▲ 6 facet geometry for excellent hole quality 	DRAGONSKIN	
-----------	---	--	-------------------	--

180		<ul style="list-style-type: none"> ▲ for inclined surfaces up to 45° and flat bottom holes 		
------------	---	---	--	--

MINI		<ul style="list-style-type: none"> ▲ solid carbide micro drill for the precise manufacture of very small holes from Ø 0.1 to 2.9 mm 		
-------------	---	--	--	--

MICRO		<ul style="list-style-type: none"> ▲ Universal high-performance micro drill ▲ Specialised geometry and coating ▲ Pilot drill for WTX Micro deep hole twist drill 	DRAGONSKIN	
--------------	---	---	-------------------	---

Coatings

DPX74S	<ul style="list-style-type: none"> ▲ Special TiAlN nanolayer coating ▲ Maximum application temperature: 1000 °C
DRAGONSKIN	

Ti800	<ul style="list-style-type: none"> ▲ AlTiN nanolayer coating ▲ Maximum application temperature: 1100 °C
--------------	---

DPX74M	<ul style="list-style-type: none"> ▲ Universal AlCrN-based monolayer coating developed for micro tools ▲ High oxidation, heat and wear resistance ▲ Maximum application temperature 1100 °C
DRAGONSKIN	

TiAlN	<ul style="list-style-type: none"> ▲ TiAlN multilayer coating ▲ Maximum application temperature: 900 °C
--------------	---

DPA54	<ul style="list-style-type: none"> ▲ Special multilayer coating ▲ High hardness and heat resistance ▲ Maximum application temperature: 800 °C
DRAGONSKIN	

DLC	<ul style="list-style-type: none"> ▲ Diamond-like carbon coating ▲ Specially for machining non-ferrous metals ▲ Maximum application temperature: 400 °C
DRAGONSKIN	

Reamers overview

Length	Diameter in mm Ø DC	Standard Tolerance	Material	Through hole	Blind hole	Int. coolant supply	coated	uncoated	KOMET \ Performance	KOMET \ Standard
			P Steel M Stainless steel K Cast iron N Non-ferrous metals S Heat-resistant H Tempered steel O Non metal materials				<input type="checkbox"/>	<input type="checkbox"/>		

Monomax

- ▲ adjustable monoblock reamer in 3xD and 5xD
- ▲ regrinding and re-tipping on the base body
- ▲ all common materials



short	5,60-12,00	H7 1/100	● ● ● ● ● ○	✓	✓	✓	<input checked="" type="checkbox"/>	<input type="checkbox"/>	48-50
-------	------------	-------------	-------------	---	---	---	-------------------------------------	--------------------------	-------

Fullmax

- ▲ High-speed reamer in shorter and longer version
- ▲ Reamers for machining steel, stainless and acid-resistant steels, cast materials, aluminium and hardened materials up to 63 HRC
- ▲ Extremely irregular pitch
- ▲ Standard shank ~ DIN 6535 HA



short	4,00-12,00 2,96-12,03	H7 1/100	● ● ● ○ ○ ●	✓	✓	✓	<input checked="" type="checkbox"/>	<input type="checkbox"/>	51-56
-------	--------------------------	-------------	-------------	---	---	---	-------------------------------------	--------------------------	-------



long	4,00-12,00 2,96-12,03	H7 1/100	● ● ● ● ○ ○ ●	✓	✓	✓	<input checked="" type="checkbox"/>	<input type="checkbox"/>	57-62
------	--------------------------	-------------	---------------	---	---	---	-------------------------------------	--------------------------	-------

Solid Carbide Reamers

- ▲ universal solid carbide reamer without thro' coolant
- ▲ extremely irregular pitch
- ▲ DIN 6535 HA shank



	0,59-12,05	1/100	● ○ ● ● ● ● ●	✓			<input type="checkbox"/>	<input type="checkbox"/>	63
--	------------	-------	---------------	---	--	--	--------------------------	--------------------------	----



	0,59-12,05	1/100	● ○ ● ● ○ ○ ●	✓			<input checked="" type="checkbox"/>	<input type="checkbox"/>	64
--	------------	-------	---------------	---	--	--	-------------------------------------	--------------------------	----

HSS Reamers

- ▲ HSS-E NC machine reamer
- ▲ DIN 1835 A shank



	0,95-12,00	1/100	● ● ● ● ● ● ●	✓			<input type="checkbox"/>	<input type="checkbox"/>	65
--	------------	-------	---------------	---	--	--	--------------------------	--------------------------	----

- ▲ HSS-E machine reamer



	0,95-12,00	1/100	● ○ ● ● ○ ● ●	✓			<input type="checkbox"/>	<input type="checkbox"/>	66+67
--	------------	-------	---------------	---	--	--	--------------------------	--------------------------	-------

- ▲ HSS-E automatic machine reamer DIN 8089



	4,00-12,00	H7	● ○ ● ● ● ○ ●	✓			<input type="checkbox"/>	<input type="checkbox"/>	68
--	------------	----	---------------	---	--	--	--------------------------	--------------------------	----



	3,76-12,00	1/100	● ○ ● ● ● ○ ●	✓			<input type="checkbox"/>	<input type="checkbox"/>	69
--	------------	-------	---------------	---	--	--	--------------------------	--------------------------	----

Monomax – Selection guide

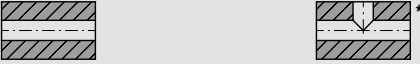
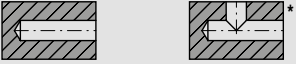
Ø		5,60 – 25,89 mm							
KOMET no. (3xD)		56J.93	56J.93	56J.65	56J.17	56J.71	56H.65	56H.65	56H.17
Lead angle		ASG4000	ASG3000	ASG0106	ASG0706	ASG3000	ASG3000	ASG0106	ASG0706
Lead angle		25°	45°	45°	45°/8°	45°	45°	45°	45°/8°
Grade / coating		DST	DST	DBG-P	DBC	TIN	DBG-P	DBG-P	DBC
Article no. (3xD)		40 635	40 625	40 652	40 648	40 605	40 657	40 644	40 640
Preferred type available		✓	✓	✓		✓			
Application		Through hole 				Blind hole 			
Material sub-group	Index								
P	Non alloyed steel	P.1.1							
		P.1.2							
		P.1.3							
		P.1.4	●	●					
		P.1.5					○	●	
	Low alloyed steel	P.2.1							
		P.2.2							
		P.2.3							
		P.2.4							
	High-alloy steel and high-alloy tool steel	P.3.1							
		P.3.2			●				
		P.3.3						●	
Stainless steel	P.4.1								
	P.4.2								
M	Stainless steel	M.1.1			●			●	
		M.2.1							
		M.3.1							
K	Grey cast iron	K.1.1					○	●	
		K.1.2							
	Spherulitic graphite cast iron	K.2.1	○	●				●	
		K.2.2							
	Malleable iron	K.3.1	○	●				●	
		K.3.2							
N	Aluminum alloys	N.1.1							
		N.1.2							
	Cast aluminium alloys	N.2.1				●			●
		N.2.2							
		N.2.3							
	Copper and copper alloys (Bronze, Brass)	N.3.1							
		N.3.2		○			●		
		N.3.3							
Magnesium alloys	N.4.1								
O	Non-metal materials	O.1.1							
		O.1.2							
		O.2.1							
		O.2.2							
		O.3.1				○			○

* for drilling with interrupted cut use coated HM-reamers

Monomax – High-speed reamers, short

- ▲ adjustable for smallest bore tolerances
- ▲ wear compensation within the tolerance zone
- ▲ retraction from the hole at 3-4 times the cutting feed rate
- ▲ up to tolerance class IT 5 with absolute process security, from the first hole

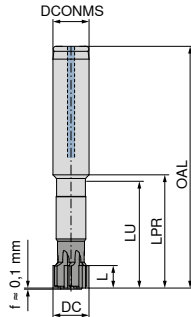

DST	DST	DBG-P	TIN	DBC
56J.93 ≤ 3xD ∠ 45° ASG3000 CERMET Through hole	56J.93 ≤ 3xD ∠ 25° ASG4000 CERMET Through hole	56J.65 ≤ 3xD ∠ 45° ASG0106 HM Through hole	56J.71 ≤ 3xD ∠ 45° ASG3000 HM Through hole	56J.17 ≤ 3xD ∠ 45/8° ASG0706 HM Through hole

DC _{H7} mm	OAL mm	L mm	LU mm	LPR mm	DCONMS _{h6} mm	ZEFP	40 625 ...	40 635 ...	40 652 ...	40 605 ...	40 648 ...
5,60 - 5,99	85	9.5	35	40	12	4	xxxx ²⁾	xxxx ²⁾	xxxx ¹⁾	xxxx ¹⁾	xxxx ¹⁾
6,00	85	9.5	35	40	12	4	060	060	06000	060	06000 ¹⁾
6,01 - 7,99	85	9.5	35	40	12	4	xxxx ²⁾	xxxx ²⁾	xxxx ¹⁾	xxxx ¹⁾	xxxx ¹⁾
8,00	85	9.5	35	40	12	4	080	080	08000	080	08000 ¹⁾
8,01 - 8,89	85	9.5	35	40	12	4	xxxx ²⁾	xxxx ²⁾	xxxx ¹⁾	xxxx ¹⁾	xxxx ¹⁾
8,90 - 9,89	95	9.5	45	50	12	6	xxxx ²⁾	xxxx ²⁾	xxxx ¹⁾	xxxx ¹⁾	xxxx ¹⁾
9,90 - 9,99	95	9.5	45	50	12	6	xxxx ²⁾	xxxx ²⁾	xxxx ¹⁾	xxxx ¹⁾	xxxx ¹⁾
10,00	95	9.5	45	50	12	6	100	100	10000	100	10000 ¹⁾
10,01 - 11,99	95	9.5	45	50	12	6	xxxx ²⁾	xxxx ²⁾	xxxx ¹⁾	xxxx ¹⁾	xxxx ¹⁾
12,00	95	9.5	45	50	12	6	120	120	12000	120	12000 ¹⁾

P	●	●	●	○		
M						
K	●	○		○		
N	○			●	●	
S						
H						
O						○

1) Not available ex stock, articles are non-returnable and cannot be exchanged / Delivery time 25 working days / Minimum order 2 pieces → v_c Page 71-74
 2) Not available ex stock, articles are non-returnable and cannot be exchanged / Delivery time 20 working days / Minimum order 2 pieces

Do not heat shrink tools!

For xxxx please indicate requested Ø in H7 in the order (e.g. 15.89 H7 → article no. 40 635 1589)!
 All other diameters and tolerance classes are also possible on request (e.g. 18.5^{+0.025} or 18 N7).

Monomax – High-speed reamers, short

- ▲ adjustable for smallest bore tolerances
- ▲ wear compensation within the tolerance zone
- ▲ retraction from the hole at 3-4 times the cutting feed rate
- ▲ up to tolerance class IT 5 with absolute process security, from the first hole

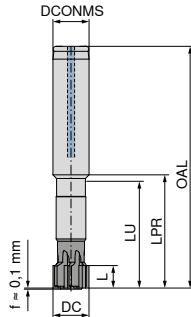

DC _{H7} mm	OAL mm	L mm	LU mm	LPR mm	DCONMS _{h6} mm	ZEFP	40 644 ...	40 657 ...	40 640 ...
5,60 - 5,99	85	9.5	35	40	12	4	xxxx ¹⁾	xxxx ¹⁾	xxxx ¹⁾
6,00	85	9.5	35	40	12	4	06000 ¹⁾	06000 ¹⁾	06000 ¹⁾
6,01 - 7,99	85	9.5	35	40	12	4	xxxx ¹⁾	xxxx ¹⁾	xxxx ¹⁾
8,00	85	9.5	35	40	12	4	08000 ¹⁾	08000 ¹⁾	08000 ¹⁾
8,01 - 8,89	85	9.5	35	40	12	4	xxxx ¹⁾	xxxx ¹⁾	xxxx ¹⁾
8,90 - 9,89	95	9.5	45	50	12	6	xxxx ¹⁾	xxxx ¹⁾	xxxx ¹⁾
9,90 - 9,99	95	9.5	45	50	12	6	xxxx ¹⁾	xxxx ¹⁾	xxxx ¹⁾
10,00	95	9.5	45	50	12	6	10000 ¹⁾	10000 ¹⁾	10000 ¹⁾
10,01 - 11,99	95	9.5	45	50	12	6	xxxx ¹⁾	xxxx ¹⁾	xxxx ¹⁾
12,00	95	9.5	45	50	12	6	12000 ¹⁾	12000 ¹⁾	12000 ¹⁾
P							•	•	
M							•		
K								•	
N									•
S									
H									
O									○

1) Not available ex stock, articles are non-returnable and cannot be exchanged / Delivery time 25 working days / Minimum order 2 pieces → v_c Page 71-74

Do not heat shrink tools!

For xxxx please indicate requested Ø in H7 in the order (e.g. 15.89 H7 → article no. 40 644 1589)!
All other diameters and tolerance classes are also possible on request (e.g. 18.5^{+0.025} or 18 N7).

Fullmax – High-performance machine reamers, short

- ▲ extremely irregular pitch
- ▲ designed for high-speed machining
- ▲ specialised geometries and coatings

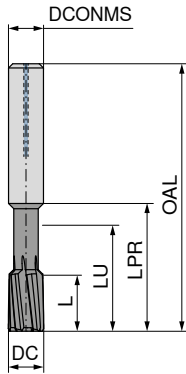

NEW
DBG-U



51P.57
HA
Left Hand Helix
◁ 30°
ASG2210
Solid carbide
Through hole

40 483 ...

DC _{H7} mm	OAL mm	L mm	LU mm	LPR mm	DCONMS _{h6} mm	ZEFP	
4	50	12	24	28	4	4	04000
5	64	12	31	36	6	4	05000
6	64	12	31	36	6	4	06000
7	70	16	31	36	8	6	07000
8	70	16	31	36	8	6	08000
9	80	16	35	40	10	6	09000
10	80	16	35	40	10	6	10000
11	90	20	40	45	12	6	11000
12	90	20	40	45	12	6	12000

P	●
M	●
K	●
N	○
S	○
H	○
O	

→ v_c Page 75

Fullmax – High-performance machine reamers, short

- ▲ extremely irregular pitch
- ▲ designed for high-speed machining
- ▲ specialised geometries and coatings
- ▲ tolerance: Ø 2,96 - 5,96 mm = +0,004 mm
- ▲ tolerance: Ø 5,97 - 20,05 mm = +0,005 mm

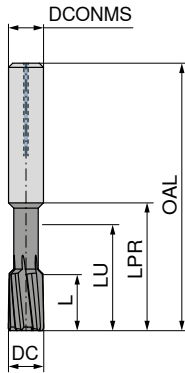

NEW
DBG-U



51P.57
HA
Left Hand Helix
◁ 30°
ASG2210
Solid carbide
Through hole

40 489 ...

DC +0,004/+0,005 mm	OAL mm	L mm	LU mm	LPR mm	DCONMS _{h6} mm	ZEFP	
2,96 - 3,96	50	12	24	28	4	4	xxxxx ¹⁾
3,97	50	12	24	28	4	4	03970
3,98	50	12	24	28	4	4	03980
3,99	50	12	24	28	4	4	03990
4,00	50	12	24	28	4	4	04000
4,01	50	12	24	28	4	4	04010
4,02	50	12	24	28	4	4	04020
4,03	50	12	24	28	4	4	04030
4,04 - 4,05	50	12	24	28	4	4	xxxxx ¹⁾
4,06 - 4,96	64	12	31	36	6	4	xxxxx ¹⁾
4,97	64	12	31	36	6	4	04970
4,98	64	12	31	36	6	4	04980
4,99	64	12	31	36	6	4	04990
5,00	64	12	31	36	6	4	05000
5,01	64	12	31	36	6	4	05010
5,02	64	12	31	36	6	4	05020
5,03	64	12	31	36	6	4	05030
5,04 - 5,96	64	12	31	36	6	4	xxxxx ¹⁾
5,97	64	12	31	36	6	4	05970
5,98	64	12	31	36	6	4	05980
5,99	64	12	31	36	6	4	05990
6,00	64	12	31	36	6	4	06000
6,01	64	12	31	36	6	4	06010
6,02	64	12	31	36	6	4	06020
6,03	64	12	31	36	6	4	06030
6,04 - 6,05	64	12	31	36	6	4	xxxxx ¹⁾
6,06 - 7,96	70	16	31	36	8	6	xxxxx ¹⁾
7,97	70	16	31	36	8	6	07970
7,98	70	16	31	36	8	6	07980
7,99	70	16	31	36	8	6	07990

P	●
M	●
K	●
N	○
S	○
H	○
O	

1) Not available ex stock, articles are non-returnable and cannot be exchanged / Delivery time 25 working days → v_c Page 75

This tool concept permits numerous tolerances. For sizes covered please refer to the table on → page 80.
For xxxxx please indicate required Ø in the order (e.g. Ø 8.82 mm → Article No. 40 489 08820)!

Fullmax – High-performance machine reamers, short

- ▲ extremely irregular pitch
- ▲ designed for high-speed machining
- ▲ specialised geometries and coatings
- ▲ tolerance: Ø 2,96 - 5,96 mm = +0,004 mm
- ▲ tolerance: Ø 5,97 - 20,05 mm = +0,005 mm

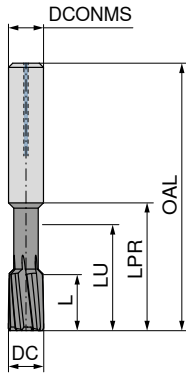

NEW
DBG-U



51P.57
HA HA
Left Hand Helix
◁ 30°
ASG2210
Solid carbide
Through hole

40 489 ...

DC +0,004/+0,005 mm	OAL mm	L mm	LU mm	LPR mm	DCONMS _{h6} mm	ZEFP	
8,00	70	16	31	36	8	6	08000
8,01	70	16	31	36	8	6	08010
8,02	70	16	31	36	8	6	08020
8,03	70	16	31	36	8	6	08030
8,04 - 8,05	70	16	31	36	8	6	xxxxx ¹⁾
8,06 - 9,96	80	16	35	40	10	6	xxxxx ¹⁾
9,97	80	16	35	40	10	6	09970
9,98	80	16	35	40	10	6	09980
9,99	80	16	35	40	10	6	09990
10,00	80	16	35	40	10	6	10000
10,01	80	16	35	40	10	6	10010
10,02	80	16	35	40	10	6	10020
10,03	80	16	35	40	10	6	10030
10,04 - 10,05	80	16	35	40	10	6	xxxxx ¹⁾
10,06 - 11,96	90	20	40	45	12	6	xxxxx ¹⁾
11,97	90	20	40	45	12	6	11970
11,98	90	20	40	45	12	6	11980
11,99	90	20	40	45	12	6	11990
12,00	90	20	40	45	12	6	12000
12,01	90	20	40	45	12	6	12010
12,02	90	20	40	45	12	6	12020
12,03	90	20	40	45	12	6	12030

P	●
M	●
K	●
N	○
S	○
H	○
O	○

1) Not available ex stock, articles are non-returnable and cannot be exchanged / Delivery time 25 working days

→ v_c Page 75

This tool concept permits numerous tolerances. For sizes covered please refer to the table on → page 80.
For xxxxx please indicate required Ø in the order (e.g. Ø 8.82 mm → Article No. 40 489 08820)!

Fullmax – High-performance machine reamers, short

- ▲ extremely irregular pitch
- ▲ designed for high-speed machining
- ▲ specialised geometries and coatings

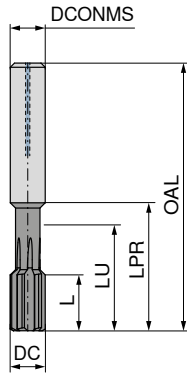

NEW
DBG-U



51M.57
HA straight flute
∠ 60°
ASG2110
Solid carbide
Blind hole

40 481 ...

DC _{H7} mm	OAL mm	L mm	LU mm	LPR mm	DCONMS _{h6} mm	ZEFP	
4	50	12	24	28	4	4	04000
5	64	12	31	36	6	4	05000
6	64	12	31	36	6	4	06000
7	70	16	31	36	8	6	07000
8	70	16	31	36	8	6	08000
9	80	16	35	40	10	6	09000
10	80	16	35	40	10	6	10000
11	90	20	40	45	12	6	11000
12	90	20	40	45	12	6	12000

P	●
M	●
K	●
N	○
S	○
H	○
O	

→ v_c Page 75

Fullmax – High-performance machine reamers, short

- ▲ extremely irregular pitch
- ▲ designed for high-speed machining
- ▲ specialised geometries and coatings
- ▲ tolerance: Ø 2,96 - 5,96 mm = +0,004 mm
- ▲ tolerance: Ø 5,97 - 20,05 mm = +0,005 mm

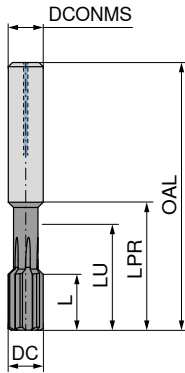

NEW
DBG-U



51M.57
HA straight flute
∠ 60°
ASG2110
Solid carbide
Blind hole

40 488 ...

DC +0,004/+0,005 mm	OAL mm	L mm	LU mm	LPR mm	DCONMS _{h6} mm	ZEFP	
2,96 - 3,96	50	12	24	28	4	4	xxxxx ¹⁾
3,97	50	12	24	28	4	4	03970
3,98	50	12	24	28	4	4	03980
3,99	50	12	24	28	4	4	03990
4,00	50	12	24	28	4	4	04000
4,01	50	12	24	28	4	4	04010
4,02	50	12	24	28	4	4	04020
4,03	50	12	24	28	4	4	04030
4,04 - 4,05	50	12	24	28	4	4	xxxxx ¹⁾
4,06 - 4,96	64	12	31	36	6	4	xxxxx ¹⁾
4,97	64	12	31	36	6	4	04970
4,98	64	12	31	36	6	4	04980
4,99	64	12	31	36	6	4	04990
5,00	64	12	31	36	6	4	05000
5,01	64	12	31	36	6	4	05010
5,02	64	12	31	36	6	4	05020
5,03	64	12	31	36	6	4	05030
5,04 - 5,96	64	12	31	36	6	4	xxxxx ¹⁾
5,97	64	12	31	36	6	4	05970
5,98	64	12	31	36	6	4	05980
5,99	64	12	31	36	6	4	05990
6,00	64	12	31	36	6	4	06000
6,01	64	12	31	36	6	4	06010
6,02	64	12	31	36	6	4	06020
6,03	64	12	31	36	6	4	06030
6,04 - 6,05	64	12	31	36	6	4	xxxxx ¹⁾
6,06 - 7,96	70	16	31	36	8	6	xxxxx ¹⁾
7,97	70	16	31	36	8	6	07970
7,98	70	16	31	36	8	6	07980
7,99	70	16	31	36	8	6	07990

P	●
M	●
K	●
N	○
S	○
H	○
O	

1) Not available ex stock, articles are non-returnable and cannot be exchanged / Delivery time 25 working days

This tool concept permits numerous tolerances. For sizes covered please refer to the table on → page 80.
For xxxxx please indicate required Ø in the order (e.g. Ø 8.82 mm → Article No. 40 488 08820)!

Fullmax – High-performance machine reamers, short

- ▲ extremely irregular pitch
- ▲ designed for high-speed machining
- ▲ specialised geometries and coatings
- ▲ tolerance: $\varnothing 2,96 - 5,96 \text{ mm} = +0,004 \text{ mm}$
- ▲ tolerance: $\varnothing 5,97 - 20,05 \text{ mm} = +0,005 \text{ mm}$

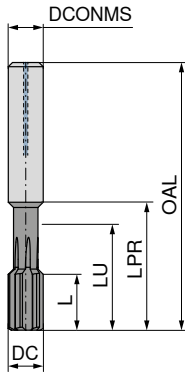

NEW
DBG-U



51M.57
HA straight flute
 $\sphericalangle 60^\circ$
ASG2110
Solid carbide
Blind hole

40 488 ...

DC <small>+0,004/+0,005</small> mm	OAL mm	L mm	LU mm	LPR mm	DCONMS _{h6} mm	ZEFP	
8,00	70	16	31	36	8	6	08000
8,01	70	16	31	36	8	6	08010
8,02	70	16	31	36	8	6	08020
8,03	70	16	31	36	8	6	08030
8,04 - 8,05	70	16	31	36	8	6	xxxxx ¹⁾
8,06 - 9,96	80	16	35	40	10	6	xxxxx ¹⁾
9,97	80	16	35	40	10	6	09970
9,98	80	16	35	40	10	6	09980
9,99	80	16	35	40	10	6	09990
10,00	80	16	35	40	10	6	10000
10,01	80	16	35	40	10	6	10010
10,02	80	16	35	40	10	6	10020
10,03	80	16	35	40	10	6	10030
10,04 - 10,05	80	16	35	40	10	6	xxxxx ¹⁾
10,06 - 11,96	90	20	40	45	12	6	xxxxx ¹⁾
11,97	90	20	40	45	12	6	11970
11,98	90	20	40	45	12	6	11980
11,99	90	20	40	45	12	6	11990
12,00	90	20	40	45	12	6	12000
12,01	90	20	40	45	12	6	12010
12,02	90	20	40	45	12	6	12020
12,03	90	20	40	45	12	6	12030

P	●
M	●
K	●
N	○
S	○
H	○
O	○

1) Not available ex stock, articles are non-returnable and cannot be exchanged / Delivery time 25 working days

This tool concept permits numerous tolerances. For sizes covered please refer to the table on → page 80.
For xxxxx please indicate required \varnothing in the order (e.g. $\varnothing 8.82 \text{ mm}$ → Article No. 40 488 08820)!

Fullmax – High-performance machine reamers, long

- ▲ extremely irregular pitch
- ▲ designed for high-speed machining
- ▲ specialised geometries and coatings

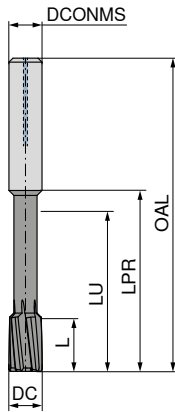

UNI	VA	ALU
DBG-U	DBQ	DBC-N



52P.57 HA	52S.44 HA	52N.17 HA
Left Hand Helix ◁ 30°	Left Hand Helix ◁ 30°	straight flute ◁ 30°
ASG2210	ASG2231	ASG2270
Solid carbide Through hole	Solid carbide Through hole	Solid carbide Through hole

DC _{H7} mm	OAL mm	L mm	LU mm	LPR mm	DCONMS _{h6} mm	ZEFP	40 484 ...	40 401 ...	40 471 ...
4	60	12	28	32	4	4	04000	04000	04000
5	76	12	35	40	6	4	05000	05000	05000
6	76	12	35	40	6	4	06000	06000	06000
7	101	16	60	65	8	6	07000	07000	07000
8	101	16	60	65	8	6	08000	08000	08000
9	108	16	63	68	10	6	09000	09000	09000
10	108	16	63	68	10	6	10000	10000	10000
11	130	20	80	85	12	6	11000	11000	11000
12	130	20	80	85	12	6	12000	12000	12000
P							●	●	
M							●	●	
K							●		
N							○		●
S							○		
H							○		
O									○

→ v_c Page 76+77

Fullmax – High-performance machine reamers, long

- ▲ extremely irregular pitch
- ▲ designed for high-speed machining
- ▲ specialised geometries and coatings
- ▲ tolerance: Ø 2,96 - 5,96 mm = +0,004 mm
- ▲ tolerance: Ø 5,97 - 20,05 mm = +0,005 mm

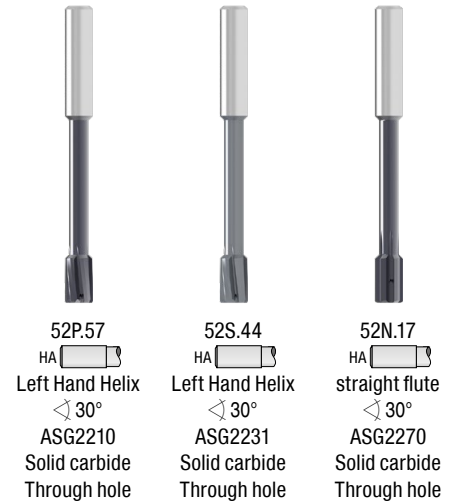
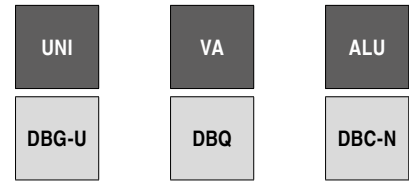
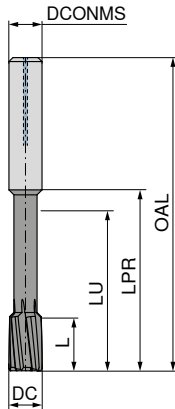

40 486 ... 40 403 ... 40 473 ...

DC +0,004/+0,005 mm	OAL mm	L mm	LU mm	LPR mm	DCONMS _{n6} mm	ZEFP			
2,96 - 3,96	60	12	28	32	4	4			
3,97	60	12	28	32	4	4			
3,98	60	12	28	32	4	4			
3,99	60	12	28	32	4	4			
4,00	60	12	28	32	4	4			
4,01	60	12	28	32	4	4			
4,02	60	12	28	32	4	4			
4,03	60	12	28	32	4	4			
4,04 - 4,05	60	12	28	32	4	4			
4,06 - 4,96	76	12	35	40	6	4			
4,97	76	12	35	40	6	4			
4,98	76	12	35	40	6	4			
4,99	76	12	35	40	6	4			
5,00	76	12	35	40	6	4			
5,01	76	12	35	40	6	4			
5,02	76	12	35	40	6	4			
5,03	76	12	35	40	6	4			
5,04 - 5,96	76	12	35	40	6	4			
5,97	76	12	35	40	6	4			
5,98	76	12	35	40	6	4			
5,99	76	12	35	40	6	4			
6,00	76	12	35	40	6	4			
6,01	76	12	35	40	6	4			
6,02	76	12	35	40	6	4			
6,03	76	12	35	40	6	4			
6,04 - 6,05	76	12	35	40	6	4			
6,06 - 7,96	101	16	60	65	8	6			
7,97	101	16	60	65	8	6			
7,98	101	16	60	65	8	6			

P	●	●	
M	●	●	
K	●		
N	○		●
S	○		
H	○		
O			○

1) Not available ex stock, articles are non-returnable and cannot be exchanged / Delivery time 25 working days
 2) Not available ex stock, articles are non-returnable and cannot be exchanged / Delivery time 32 working days

→ v_c Page 76+77

This tool concept permits numerous tolerances. For sizes covered please refer to the table on → page 80.
 For xxxxx please indicate required Ø in the order (e.g. Ø 8.82 mm → Article No. 40 486 08820)!

Fullmax – High-performance machine reamers, long

- ▲ extremely irregular pitch
- ▲ designed for high-speed machining
- ▲ specialised geometries and coatings
- ▲ tolerance: Ø 2,96 – 5,96 mm = +0,004 mm
- ▲ tolerance: Ø 5,97 – 20,05 mm = +0,005 mm

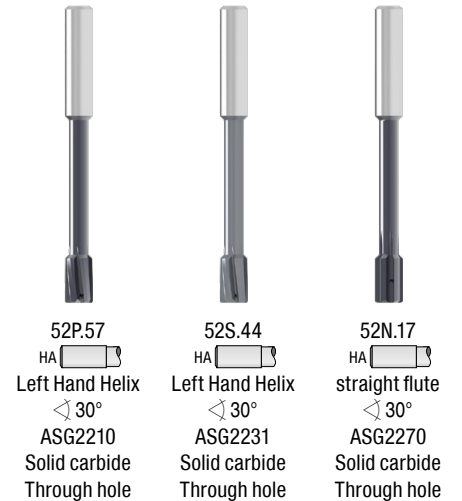
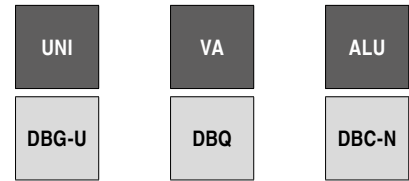
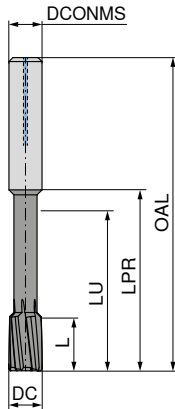

40 486 ... 40 403 ... 40 473 ...

DC +0,004/+0,005 mm	OAL mm	L mm	LU mm	LPR mm	DCONMS _{n6} mm	ZEFP	40 486 ...	40 403 ...	40 473 ...
7,99	101	16	60	65	8	6	07990	07990	07990 ¹⁾
8,00	101	16	60	65	8	6	08000	08000	08000 ¹⁾
8,01	101	16	60	65	8	6	08010	08010	08010 ¹⁾
8,02	101	16	60	65	8	6	08020	08020	08020 ¹⁾
8,03	101	16	60	65	8	6	08030	08030	08030 ¹⁾
8,04 - 8,05	101	16	60	65	8	6	xxxxx ¹⁾	xxxxx ²⁾	xxxxx ¹⁾
8,06 - 9,96	108	16	63	68	10	6	xxxxx ¹⁾	xxxxx ²⁾	xxxxx ¹⁾
9,97	108	16	63	68	10	6	09970	09970	09970 ¹⁾
9,98	108	16	63	68	10	6	09980	09980	09980 ¹⁾
9,99	108	16	63	68	10	6	09990	09990	09990 ¹⁾
10,00	108	16	63	68	10	6	10000	10000	10000 ¹⁾
10,01	108	16	63	68	10	6	10010	10010	10010 ¹⁾
10,02	108	16	63	68	10	6	10020	10020	10020 ¹⁾
10,03	108	16	63	68	10	6	10030	10030	10030 ¹⁾
10,04 - 10,05	108	16	63	68	10	6	xxxxx ¹⁾	xxxxx ²⁾	xxxxx ¹⁾
10,06 - 11,96	130	20	80	85	12	6	xxxxx ¹⁾	xxxxx ²⁾	xxxxx ¹⁾
11,97	130	20	80	85	12	6	11970	11970	11970 ¹⁾
11,98	130	20	80	85	12	6	11980	11980	11980 ¹⁾
11,99	130	20	80	85	12	6	11990	11990	11990 ¹⁾
12,00	130	20	80	85	12	6	12000	12000	12000 ¹⁾
12,01	130	20	80	85	12	6	12010	12010	12010 ¹⁾
12,02	130	20	80	85	12	6	12020	12020	12020 ¹⁾
12,03	130	20	80	85	12	6	12030	12030	12030 ¹⁾

P	●	●	
M	●	●	
K	●		
N	○		●
S	○		
H	○		
O			○

1) Not available ex stock, articles are non-returnable and cannot be exchanged / Delivery time 25 working days
 2) Not available ex stock, articles are non-returnable and cannot be exchanged / Delivery time 32 working days
 → v_c Page 76+77

This tool concept permits numerous tolerances. For sizes covered please refer to the table on → page 80.
 For xxxxx please indicate required Ø in the order (e.g. Ø 8.82 mm → Article No. 40 486 08820)!

Fullmax – High-performance machine reamers, long

- ▲ extremely irregular pitch
- ▲ designed for high-speed machining
- ▲ specialised geometries and coatings

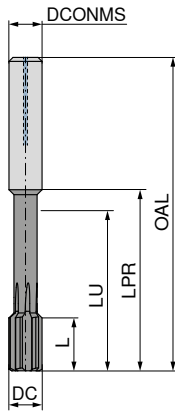

UNI	VA	ALU
DBG-U	DBQ	DBC-N
52M.57 HA straight flute ∠ 60° ASG2110 Solid carbide Blind hole	52T.45 HA straight flute ∠ 45° ASG2131 Solid carbide Blind hole	52Q.17 HA straight flute ∠ 60° ASG2170 Solid carbide Blind hole

DC _{H7} mm	OAL mm	L mm	LU mm	LPR mm	DCONMS _{h6} mm	ZEFP
4	60	12	28	32	4	4
5	76	12	35	40	6	4
6	76	12	35	40	6	4
7	101	16	60	65	8	6
8	101	16	60	65	8	6
9	108	16	63	68	10	6
10	108	16	63	68	10	6
11	130	20	80	85	12	6
12	130	20	80	85	12	6

40 485 ...	40 402 ...	40 472 ...
04000	04000	04000
05000	05000	05000
06000	06000	06000
07000	07000	07000
08000	08000	08000
09000	09000	09000
10000	10000	10000
11000	11000	11000
12000	12000	12000

P	●	●	
M	●	●	
K	●		
N	○		●
S	○		
H	○		
O			○

→ v_c Page 76+77

Fullmax – High-performance machine reamers, long

- ▲ extremely irregular pitch
- ▲ designed for high-speed machining
- ▲ specialised geometries and coatings
- ▲ tolerance: Ø 2,96 - 5,96 mm = +0,004 mm
- ▲ tolerance: Ø 5,97 - 20,05 mm = +0,005 mm

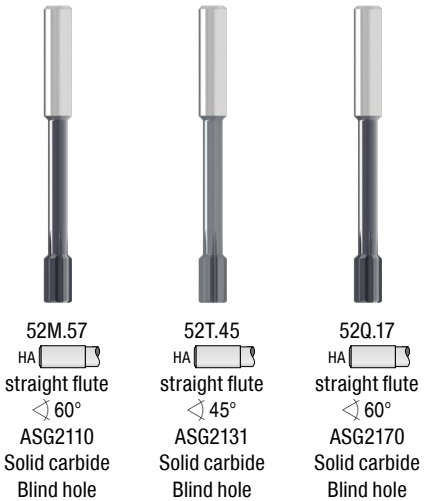
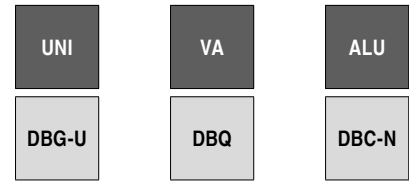
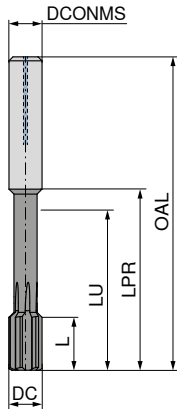

40 487 ...	40 404 ...	40 474 ...
52M.57 HA straight flute ∠60° ASG2110 Solid carbide Blind hole	52T.45 HA straight flute ∠45° ASG2131 Solid carbide Blind hole	52Q.17 HA straight flute ∠60° ASG2170 Solid carbide Blind hole
xxxxx ¹⁾	xxxxx ²⁾	xxxxx ¹⁾
03970	03970	03970 ¹⁾
03980	03980	03980 ¹⁾
03990	03990	03990 ¹⁾
04000	04000	04000 ¹⁾
04010	04010	04010 ¹⁾
04020	04020	04020 ¹⁾
04030	04030	04030 ¹⁾
xxxxx ¹⁾	xxxxx ²⁾	xxxxx ¹⁾
xxxxx ¹⁾	xxxxx ²⁾	xxxxx ¹⁾
04970	04970	04970 ¹⁾
04980	04980	04980 ¹⁾
04990	04990	04990 ¹⁾
05000	05000	05000 ¹⁾
05010	05010	05010 ¹⁾
05020	05020	05020 ¹⁾
05030	05030	05030 ¹⁾
xxxxx ¹⁾	xxxxx ²⁾	xxxxx ¹⁾
05970	05970	05970 ¹⁾
05980	05980	05980 ¹⁾
05990	05990	05990 ¹⁾
06000	06000	06000 ¹⁾
06010	06010	06010 ¹⁾
06020	06020	06020 ¹⁾
06030	06030	06030 ¹⁾
xxxxx ¹⁾	xxxxx ²⁾	xxxxx ¹⁾
xxxxx ¹⁾	xxxxx ²⁾	xxxxx ¹⁾
07970	07970	07970 ¹⁾
07980	07980	07980 ¹⁾

DC +0,004/+0,005 mm	OAL mm	L mm	LU mm	LPR mm	DCONMS _{n6} mm	ZEFP
2,96 - 3,96	60	12	28	32	4	4
3,97	60	12	28	32	4	4
3,98	60	12	28	32	4	4
3,99	60	12	28	32	4	4
4,00	60	12	28	32	4	4
4,01	60	12	28	32	4	4
4,02	60	12	28	32	4	4
4,03	60	12	28	32	4	4
4,04 - 4,05	60	12	28	32	4	4
4,06 - 4,96	76	12	35	40	6	4
4,97	76	12	35	40	6	4
4,98	76	12	35	40	6	4
4,99	76	12	35	40	6	4
5,00	76	12	35	40	6	4
5,01	76	12	35	40	6	4
5,02	76	12	35	40	6	4
5,03	76	12	35	40	6	4
5,04 - 5,96	76	12	35	40	6	4
5,97	76	12	35	40	6	4
5,98	76	12	35	40	6	4
5,99	76	12	35	40	6	4
6,00	76	12	35	40	6	4
6,01	76	12	35	40	6	4
6,02	76	12	35	40	6	4
6,03	76	12	35	40	6	4
6,04 - 6,05	76	12	35	40	6	4
6,06 - 7,96	101	16	60	65	8	6
7,97	101	16	60	65	8	6
7,98	101	16	60	65	8	6

P	●	●
M	●	●
K	●	
N	○	●
S	○	
H	○	
O		○

1) Not available ex stock, articles are non-returnable and cannot be exchanged / Delivery time 25 working days → v_c Page 76+77
 2) Not available ex stock, articles are non-returnable and cannot be exchanged / Delivery time 32 working days

This tool concept permits numerous tolerances. For sizes covered please refer to the table on → page 80.
 For xxxxx please indicate required Ø in the order (e.g. Ø 8.82 mm → Article no. 40 487 08820)!

Fullmax – High-performance machine reamers, long

- ▲ extremely irregular pitch
- ▲ designed for high-speed machining
- ▲ specialised geometries and coatings
- ▲ tolerance: Ø 2,96 - 5,96 mm = +0,004 mm
- ▲ tolerance: Ø 5,97 - 20,05 mm = +0,005 mm

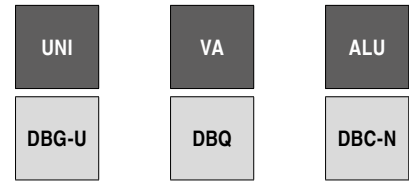
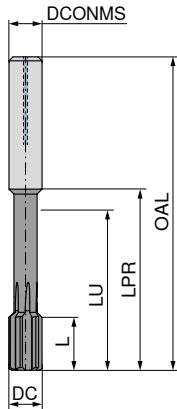

 52M.57 HA straight flute $\sphericalangle 60^\circ$ ASG2110 Solid carbide Blind hole	 52T.45 HA straight flute $\sphericalangle 45^\circ$ ASG2131 Solid carbide Blind hole	 52Q.17 HA straight flute $\sphericalangle 60^\circ$ ASG2170 Solid carbide Blind hole
--	--	--

DC +0,004/+0,005 mm	OAL mm	L mm	LU mm	LPR mm	DCONMS _{n6} mm	ZEFP
7,99	101	16	60	65	8	6
8,00	101	16	60	65	8	6
8,01	101	16	60	65	8	6
8,02	101	16	60	65	8	6
8,03	101	16	60	65	8	6
8,04 - 8,05	101	16	60	65	8	6
8,06 - 9,96	108	16	63	68	10	6
9,97	108	16	63	68	10	6
9,98	108	16	63	68	10	6
9,99	108	16	63	68	10	6
10,00	108	16	63	68	10	6
10,01	108	16	63	68	10	6
10,02	108	16	63	68	10	6
10,03	108	16	63	68	10	6
10,04 - 10,05	108	16	63	68	10	6
10,06 - 11,96	130	20	80	85	12	6
11,97	130	20	80	85	12	6
11,98	130	20	80	85	12	6
11,99	130	20	80	85	12	6
12,00	130	20	80	85	12	6
12,01	130	20	80	85	12	6
12,02	130	20	80	85	12	6
12,03	130	20	80	85	12	6

40 487 ...	40 404 ...	40 474 ...
07990	07990	07990 ¹⁾
08000	08000	08000 ¹⁾
08010	08010	08010 ¹⁾
08020	08020	08020 ¹⁾
08030	08030	08030 ¹⁾
xxxxx ¹⁾	xxxxx ²⁾	xxxxx ¹⁾
xxxxx ¹⁾	xxxxx ²⁾	xxxxx ¹⁾
09970	09970	09970 ¹⁾
09980	09980	09980 ¹⁾
09990	09990	09990 ¹⁾
10000	10000	10000 ¹⁾
10010	10010	10010 ¹⁾
10020	10020	10020 ¹⁾
10030	10030	10030 ¹⁾
xxxxx ¹⁾	xxxxx ²⁾	xxxxx ¹⁾
xxxxx ¹⁾	xxxxx ²⁾	xxxxx ¹⁾
11970	11970	11970 ¹⁾
11980	11980	11980 ¹⁾
11990	11990	11990 ¹⁾
12000	12000	12000 ¹⁾
12010	12010	12010 ¹⁾
12020	12020	12020 ¹⁾
12030	12030	12030 ¹⁾

P	●	●	
M	●	●	
K	●		
N	○		●
S	○		
H	○		
O			○

1) Not available ex stock, articles are non-returnable and cannot be exchanged / Delivery time 25 working days
 2) Not available ex stock, articles are non-returnable and cannot be exchanged / Delivery time 32 working days

→ v_c Page 76+77

This tool concept permits numerous tolerances. For sizes covered please refer to the table on → page 80.
 For xxxxx please indicate required Ø in the order (e.g. Ø 8.82 mm → Article no. 40 487 08820)!

NC machine reamers, DIN 8093-2B

- ▲ 0.01 mm steps
- ▲ extremely irregular pitch
- ▲ Ø 0.6-0.94 mm similar to DIN 8093-B
- ▲ Ø 0.95-3.75 mm with centres both ends
- ▲ Ø 3.76-12.05 mm with protected centres

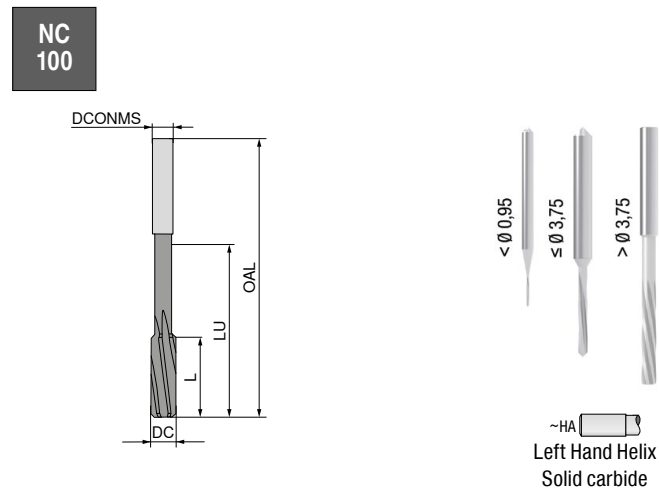

DC _{+0,004} mm	OAL mm	L mm	LU mm	DCONMS _{h6} mm	ZEFP	40 430 ...
0,59 - 0,64	45	5	7,5	3	4	xxxxx ¹⁾
0,65 - 0,74	45	5	7,5	3	4	xxxxx ¹⁾
0,75 - 0,84	45	6	8,0	3	4	xxxxx ¹⁾
0,85 - 0,95	45	6	8,0	3	4	xxxxx ¹⁾
0,96	50	6	17,5	3	3	00960 ¹⁾
0,97	50	6	17,5	3	3	00970 ¹⁾
0,98	50	6	17,5	3	3	00980 ²⁾
0,99	50	6	17,5	3	3	00990 ²⁾
1,00	50	6	17,5	3	3	01000 ²⁾
1,01	50	6	17,5	3	3	01010 ²⁾
1,02	50	6	17,5	3	3	01020 ²⁾
1,03	50	6	17,5	3	3	01030 ²⁾
1,04 - 1,06	50	6	17,5	3	3	xxxxx ²⁾
1,07 - 1,18	50	9	17,5	3	3	xxxxx ²⁾
1,19 - 1,32	50	9	17,5	3	3	xxxxx ²⁾
1,33 - 1,50	50	9	18,0	3	3	xxxxx ²⁾
1,51 - 1,70	50	10	18,0	3	3	xxxxx ²⁾
1,71 - 1,90	50	11	18,5	3	4	xxxxx ²⁾
1,91 - 1,97	50	12	18,5	3	4	xxxxx ²⁾
1,98	50	12	18,5	3	4	01980
1,99	50	12	18,5	3	4	01990
2,00	50	12	18,5	3	4	02000
2,01	50	12	18,5	3	4	02010
2,02	50	12	18,5	3	4	02020
2,03	50	12	18,5	3	4	02030
2,04 - 2,12	50	12	18,5	3	4	xxxxx ²⁾
2,13 - 2,36	50	12	18,5	3	4	xxxxx ²⁾
2,37 - 2,47	60	16	29,0	3	4	xxxxx ²⁾
2,48	60	16	29,0	3	4	02480
2,49	60	16	29,0	3	4	02490
2,50	60	16	29,0	3	4	02500
2,51	60	16	29,0	3	4	02510
2,52	60	16	29,0	3	4	02520
2,53	60	16	29,0	3	4	02530
2,54 - 2,65	60	16	29,0	3	4	xxxxx ²⁾
2,66 - 2,80	65	17	33,0	4	6	xxxxx ²⁾
2,81 - 2,96	65	17	33,0	4	6	xxxxx ²⁾
2,97	65	17	33,0	4	6	02970
2,98	65	17	33,0	4	6	02980
2,99	65	17	33,0	4	6	02990
3,00	65	17	33,0	4	6	03000
3,01	65	17	33,0	4	6	03010
3,02	65	17	33,0	4	6	03020
3,03	65	17	33,0	4	6	03030
3,04 - 3,35	65	18	33,0	4	6	xxxxx ²⁾
3,36 - 3,75	75	18	43,0	4	6	xxxxx ²⁾
3,76 - 3,96	75	19	43,0	4	6	xxxxx ²⁾
3,97	75	19	43,0	4	6	03970
3,98	75	19	43,0	4	6	03980
3,99	75	19	43,0	4	6	03990
4,00	75	19	43,0	4	6	04000
4,01	75	19	43,0	4	6	04010
4,02	75	19	43,0	4	6	04020
4,03	75	19	43,0	4	6	04030
4,04 - 4,25	75	19	43,0	4	6	xxxxx ²⁾
4,26 - 4,75	80	21	39,0	6	6	xxxxx ²⁾
4,76 - 4,96	93	23	52,0	6	6	xxxxx ²⁾
4,97	93	23	52,0	6	6	04970
4,98	93	23	52,0	6	6	04980
4,99	93	23	52,0	6	6	04990

40 430 ...

DC _{+0,004} mm	OAL mm	L mm	LU mm	DCONMS _{h6} mm	ZEFP	40 430 ...
5,00	93	23	52,0	6	6	05000
5,01	93	23	52,0	6	6	05010
5,02	93	23	52,0	6	6	05020
5,03	93	23	52,0	6	6	05030
5,04 - 5,30	93	23	52,0	6	6	xxxxx ²⁾
5,31 - 5,96	93	26	53,0	6	6	xxxxx ²⁾
5,97	93	26	53,0	6	6	05970
5,98	93	26	53,0	6	6	05980
5,99	93	26	53,0	6	6	05990
6,00	93	26	53,0	6	6	06000
6,01	93	26	53,0	6	6	06010
6,02	93	26	53,0	6	6	06020
6,03	93	26	53,0	6	6	06030
6,04 - 6,70	101	28	61,0	6	6	xxxxx ²⁾
6,71 - 7,50	109	31	68,0	8	6	xxxxx ²⁾
7,51 - 7,96	117	33	77,0	8	6	xxxxx ²⁾
7,97	117	33	77,0	8	6	07970
7,98	117	33	77,0	8	6	07980
7,99	117	33	77,0	8	6	07990
8,00	117	33	77,0	8	6	08000
8,01	117	33	77,0	8	6	08010
8,02	117	33	77,0	8	6	08020
8,03	117	33	77,0	8	6	08030
8,04	117	33	77,0	8	6	08040
8,05 - 8,50	117	33	77,0	8	6	xxxxx ²⁾
8,51 - 9,04	125	36	80,0	10	6	xxxxx ²⁾
9,05 - 9,50	125	36	80,0	10	6	xxxxx ²⁾
9,51 - 9,96	133	38	88,0	10	6	xxxxx ²⁾
9,97	133	38	88,0	10	6	09970
9,98	133	38	88,0	10	6	09980
9,99	133	38	88,0	10	6	09990
10,00	133	38	88,0	10	6	10000
10,01	133	38	88,0	10	6	10010
10,02	133	38	88,0	10	6	10020
10,03	133	38	88,0	10	6	10030
10,04	133	38	88,0	10	6	10040
10,05	133	38	88,0	10	6	10050
10,06 - 10,60	133	38	88,0	10	6	xxxxx ²⁾
10,61 - 11,80	142	41	97,0	10	6	xxxxx ²⁾
11,81 - 11,96	151	44	100,0	12	6	xxxxx ²⁾
11,97	151	44	100,0	12	6	11970
11,98	151	44	100,0	12	6	11980
11,99	151	44	100,0	12	6	11990
12,00	151	44	100,0	12	6	12000
12,01	151	44	100,0	12	6	12010
12,02	151	44	100,0	12	6	12020
12,03	151	44	100,0	12	6	12030
12,04	151	44	100,0	12	6	12040
12,05	151	44	100,0	12	6	12050

P	●
M	●
K	○
N	●
S	●
H	●
O	●

→ v_c Page 78

- 1) Not available ex stock, articles are non-returnable and cannot be exchanged / Delivery time 12 working days / Minimum order 3 pieces
- 2) Not available ex stock, articles are non-returnable and cannot be exchanged / Delivery time 12 working days

 This tool concept permits numerous tolerances. Please refer to the table on → page 80 for tolerances covered. For xxxxx please indicate required Ø in the order (e.g. Ø 8.05 mm → Article no. 40 430 08050)!

NC machine reamers, DIN 8093-2B

- ▲ 0.01 mm steps
- ▲ extremely irregular pitch
- ▲ Ø 0.6 - 0.94 mm similar to DIN 8093-B
- ▲ Ø 0.95 - 3.75 mm with centres both ends

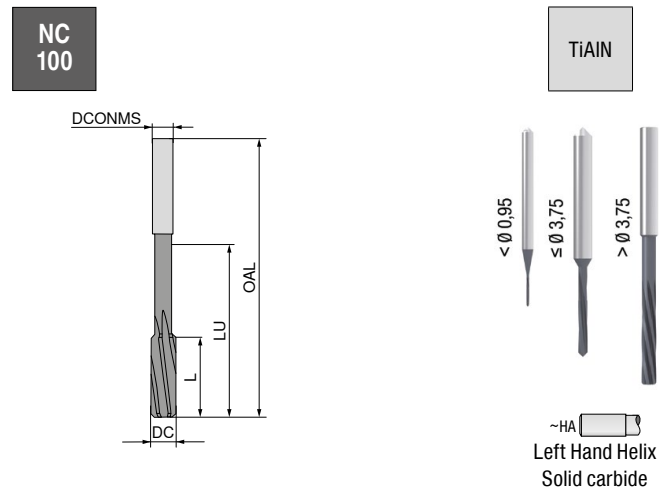

DC _{+0,004} mm	OAL mm	L mm	LU mm	DCONMS _{h6} mm	ZEPF	40 431 ...
1,00	50	6	17.5	3	3	01000 ¹⁾
1,01	50	6	17.5	3	3	01010 ¹⁾
1,02	50	6	17.5	3	3	01020 ¹⁾
1,03	50	6	17.5	3	3	01030 ¹⁾
1,04 - 1,06	50	6	17.5	3	3	xxxxx ¹⁾
1,07 - 1,18	50	9	17.5	3	3	xxxxx ¹⁾
1,19 - 1,32	50	9	17.5	3	3	xxxxx ¹⁾
1,33 - 1,50	50	9	18.0	3	3	xxxxx ¹⁾
1,51 - 1,70	50	10	18.0	3	3	xxxxx ¹⁾
1,71 - 1,90	50	11	18.5	3	4	xxxxx ¹⁾
1,91 - 1,97	50	12	18.5	3	4	xxxxx ¹⁾
1,98	50	12	18.5	3	4	01980
1,99	50	12	18.5	3	4	01990
2,00	50	12	18.5	3	4	02000
2,01	50	12	18.5	3	4	02010
2,02	50	12	18.5	3	4	02020
2,03	50	12	18.5	3	4	02030
2,04 - 2,12	50	12	18.5	3	4	xxxxx ¹⁾
2,13 - 2,36	50	12	18.5	3	4	xxxxx ¹⁾
2,37 - 2,47	60	16	29.0	3	4	xxxxx ¹⁾
2,48	60	16	29.0	3	4	02480
2,49	60	16	29.0	3	4	02490
2,50	60	16	29.0	3	4	02500
2,51	60	16	29.0	3	4	02510
2,52	60	16	29.0	3	4	02520
2,53	60	16	29.0	3	4	02530
2,54 - 2,65	60	16	29.0	3	4	xxxxx ¹⁾
2,66 - 2,80	65	17	33.0	4	6	xxxxx ¹⁾
2,81 - 2,96	65	17	33.0	4	6	xxxxx ¹⁾
2,97	65	17	33.0	4	6	02970
2,98	65	17	33.0	4	6	02980
2,99	65	17	33.0	4	6	02990
3,00	65	17	33.0	4	6	03000
3,01	65	17	33.0	4	6	03010
3,02	65	17	33.0	4	6	03020
3,03	65	17	33.0	4	6	03030
3,04 - 3,35	65	18	33.0	4	6	xxxxx ¹⁾
3,36 - 3,75	75	18	43.0	4	6	xxxxx ¹⁾
3,76 - 3,96	75	19	43.0	4	6	xxxxx ¹⁾
3,97	75	19	43.0	4	6	03970
3,98	75	19	43.0	4	6	03980
3,99	75	19	43.0	4	6	03990
4,00	75	19	43.0	4	6	04000
4,01	75	19	43.0	4	6	04010
4,02	75	19	43.0	4	6	04020
4,03	75	19	43.0	4	6	04030
4,04 - 4,25	75	19	43.0	4	6	xxxxx ¹⁾
4,26 - 4,75	80	21	39.0	6	6	xxxxx ¹⁾
4,76 - 4,96	93	23	52.0	6	6	xxxxx ¹⁾
4,97	93	23	52.0	6	6	04970
4,98	93	23	52.0	6	6	04980
4,99	93	23	52.0	6	6	04990
5,00	93	23	52.0	6	6	05000
5,01	93	23	52.0	6	6	05010
5,02	93	23	52.0	6	6	05020
5,03	93	23	52.0	6	6	05030
5,04 - 5,30	93	23	52.0	6	6	xxxxx ¹⁾
5,31 - 5,96	93	26	53.0	6	6	xxxxx ¹⁾
5,97	93	26	53.0	6	6	05970
5,98	93	26	53.0	6	6	05980

DC _{+0,004} mm	OAL mm	L mm	LU mm	DCONMS _{h6} mm	ZEPF	40 431 ...
5,99	93	26	53.0	6	6	05990
6,00	93	26	53.0	6	6	06000
6,01	93	26	53.0	6	6	06010
6,02	93	26	53.0	6	6	06020
6,03	93	26	53.0	6	6	06030
6,04 - 6,70	101	28	61.0	6	6	xxxxx ¹⁾
6,71 - 7,50	109	31	68.0	8	6	xxxxx ¹⁾
7,51 - 7,96	117	33	77.0	8	6	xxxxx ¹⁾
7,97	117	33	77.0	8	6	07970
7,98	117	33	77.0	8	6	07980
7,99	117	33	77.0	8	6	07990
8,00	117	33	77.0	8	6	08000
8,01	117	33	77.0	8	6	08010
8,02	117	33	77.0	8	6	08020
8,03	117	33	77.0	8	6	08030
8,04	117	33	77.0	8	6	08040
8,05 - 8,50	117	33	77.0	8	6	xxxxx ¹⁾
8,51 - 9,04	125	36	80.0	10	6	xxxxx ¹⁾
9,05 - 9,50	125	36	80.0	10	6	xxxxx ¹⁾
9,51 - 9,96	133	38	88.0	10	6	xxxxx ¹⁾
9,97	133	38	88.0	10	6	09970
9,98	133	38	88.0	10	6	09980
9,99	133	38	88.0	10	6	09990
10,00	133	38	88.0	10	6	10000
10,01	133	38	88.0	10	6	10010
10,02	133	38	88.0	10	6	10020
10,03	133	38	88.0	10	6	10030
10,04	133	38	88.0	10	6	10040
10,05	133	38	88.0	10	6	10050
10,06 - 10,60	133	38	88.0	10	6	xxxxx ¹⁾
10,61 - 11,80	142	41	97.0	10	6	xxxxx ¹⁾
11,81 - 11,96	151	44	100.0	12	6	xxxxx ¹⁾
11,97	151	44	100.0	12	6	11970
11,98	151	44	100.0	12	6	11980
11,99	151	44	100.0	12	6	11990
12,00	151	44	100.0	12	6	12000
12,01	151	44	100.0	12	6	12010
12,02	151	44	100.0	12	6	12020
12,03	151	44	100.0	12	6	12030
12,04	151	44	100.0	12	6	12040
12,05	151	44	100.0	12	6	12050

P	●
M	○
K	●
N	○
S	○
H	○
O	○

→ v_c Page 78

1) Not available ex stock, articles are non-returnable and cannot be exchanged /
Delivery time 12 working days

 This tool concept permits numerous tolerances. Please refer to the table on → **page 80** for tolerances covered. For xxxxx please indicate required Ø in the order (e.g. Ø 8.05 mm → Article no. 40 431 08050)!

NC machine reamers, DIN 212-3-B

- ▲ 0.01 mm steps
- ▲ tolerance: Ø 1.00 - Ø 5.50 mm = +0.004 mm
- ▲ tolerance: Ø 5.51 - Ø 12.00 mm = +0.005 mm

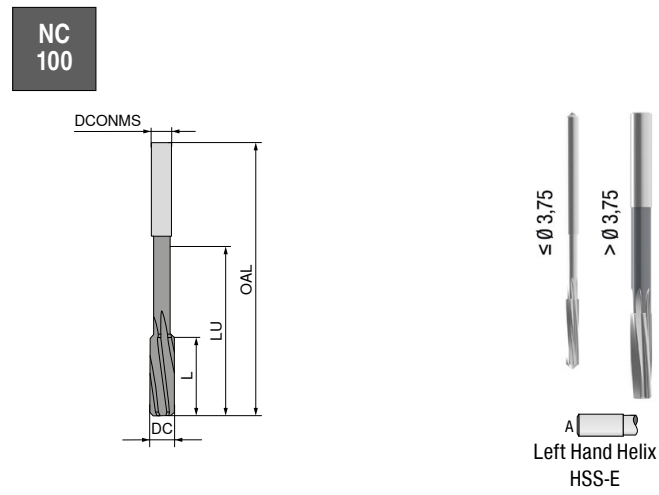

DC mm	OAL mm	L mm	LU mm	DCONMS _{h6} mm	ZEPF	
0,95 - 0,99	34	5.5	12.5	1	3	xxxxx ¹⁾
1,00	34	5.5	12.5	1	3	01000
1,01	34	5.5	12.5	1	3	01010
1,02	34	5.5	12.5	1	3	01020
1,03 - 1,06	34	5.5	12.5	1	3	xxxxx ¹⁾
1,07 - 1,18	36	6.5	13.0	1	3	xxxxx ¹⁾
1,19 - 1,32	38	7.5	14.0	2	3	xxxxx ¹⁾
1,33 - 1,41	40	8.0	15.5	2	3	xxxxx ¹⁾
1,42 - 1,49	40	8.0	15.5	2	3	xxxxx ¹⁾
1,50	40	8.0	15.5	2	3	01500
1,51	43	9.0	16.0	2	3	01510
1,52	43	9.0	16.0	2	3	01520
1,53 - 1,70	43	9.0	16.0	2	3	xxxxx ¹⁾
1,71 - 1,90	46	10.0	19.0	2	4	xxxxx ¹⁾
1,91 - 1,96	49	11.0	21.0	2	4	xxxxx ¹⁾
1,97	49	11.0	21.0	2	4	01970
1,98	49	11.0	21.0	2	4	01980
1,99	49	11.0	21.0	2	4	01990
2,00	49	11.0	21.0	2	4	02000
2,01	49	11.0	21.0	2	4	02010
2,02	49	11.0	21.0	2	4	02020
2,03 - 2,12	49	11.0	21.0	2	4	xxxxx ¹⁾
2,13 - 2,36	53	12.0	22.0	3	4	xxxxx ¹⁾
2,37 - 2,47	57	14.0	26.0	3	4	xxxxx ¹⁾
2,48	57	14.0	26.0	3	4	02480
2,49	57	14.0	26.0	3	4	02490
2,50	57	14.0	26.0	3	4	02500
2,51	57	14.0	26.0	3	4	02510
2,52	57	14.0	26.0	3	4	02520
2,53 - 2,65	57	14.0	26.0	3	4	xxxxx ¹⁾
2,66 - 2,96	61	15.0	30.0	3	6	xxxxx ¹⁾
2,97	61	15.0	30.0	3	6	02970
2,98	61	15.0	30.0	3	6	02980
2,99	61	15.0	30.0	3	6	02990
3,00	61	15.0	30.0	3	6	03000
3,01	61	15.0	30.0	3	6	03010
3,02	61	15.0	30.0	3	6	03020
3,03	61	15.0	30.0	3	6	03030 ¹⁾
3,04 - 3,35	65	16.0	34.0	4	6	xxxxx ¹⁾
3,36 - 3,75	70	18.0	39.0	4	6	xxxxx ¹⁾
3,76 - 3,96	75	19.0	44.0	4	6	xxxxx ¹⁾
3,97	75	19.0	44.0	4	6	03970
3,98	75	19.0	44.0	4	6	03980
3,99	75	19.0	44.0	4	6	03990
4,00	75	19.0	44.0	4	6	04000
4,01	75	19.0	44.0	4	6	04010
4,02	75	19.0	44.0	4	6	04020
4,03 - 4,25	75	19.0	44.0	4	6	xxxxx ¹⁾
4,26 - 4,75	80	21.0	48.0	5	6	xxxxx ¹⁾
4,76 - 4,96	86	23.0	54.0	5	6	xxxxx ¹⁾
4,97	86	23.0	54.0	5	6	04970
4,98	86	23.0	54.0	5	6	04980
4,99	86	23.0	54.0	5	6	04990
5,00	86	23.0	54.0	5	6	05000
5,01	86	23.0	54.0	5	6	05010
5,02	86	23.0	54.0	5	6	05020

40 115 ...

DC mm	OAL mm	L mm	LU mm	DCONMS _{h6} mm	ZEPF	
5,03 - 5,30	86	23.0	54.0	5	6	xxxxx ¹⁾
5,31 - 5,60	93	26.0	53.0	6	6	xxxxx ¹⁾
5,61 - 5,96	93	26.0	53.0	6	6	xxxxx ¹⁾
5,97	93	26.0	53.0	6	6	05970
5,98	93	26.0	53.0	6	6	05980
5,99	93	26.0	53.0	6	6	05990
6,00	93	26.0	53.0	6	6	06000
6,01	93	26.0	53.0	6	6	06010
6,02	93	26.0	53.0	6	6	06020
6,03	93	26.0	53.0	6	6	06030 ¹⁾
6,04 - 6,70	101	28.0	61.0	6	6	xxxxx ¹⁾
6,71 - 7,20	109	31.0	69.0	8	6	xxxxx ¹⁾
7,21 - 7,50	109	31.0	69.0	8	6	xxxxx ¹⁾
7,51 - 7,96	117	33.0	77.0	8	6	xxxxx ¹⁾
7,97	117	33.0	77.0	8	6	07970
7,98	117	33.0	77.0	8	6	07980
7,99	117	33.0	77.0	8	6	07990
8,00	117	33.0	77.0	8	6	08000
8,01	117	33.0	77.0	8	6	08010
8,02	117	33.0	77.0	8	6	08020
8,03 - 8,20	117	33.0	77.0	8	6	xxxxx ¹⁾
8,21 - 8,50	117	33.0	77.0	8	6	xxxxx ¹⁾
8,51 - 8,99	125	36.0	81.0	10	6	xxxxx ¹⁾
9,00	125	36.0	81.0	10	6	09000
9,01	125	36.0	81.0	10	6	09010
9,02	125	36.0	81.0	10	6	09020
9,03 - 9,20	125	36.0	81.0	10	6	xxxxx ¹⁾
9,21 - 9,50	125	36.0	81.0	10	6	xxxxx ¹⁾
9,51 - 9,96	133	38.0	89.0	10	6	xxxxx ¹⁾
9,97	133	38.0	89.0	10	6	09970
9,98	133	38.0	89.0	10	6	09980
9,99	133	38.0	89.0	10	6	09990
10,00	133	38.0	89.0	10	6	10000
10,01	133	38.0	89.0	10	6	10010
10,02	133	38.0	89.0	10	6	10020
10,03 - 10,20	133	38.0	89.0	10	6	xxxxx ¹⁾
10,21 - 10,60	133	38.0	89.0	10	6	xxxxx ¹⁾
10,61 - 11,20	142	41.0	98.0	10	6	xxxxx ¹⁾
11,21 - 11,80	142	41.0	98.0	10	6	xxxxx ¹⁾
11,81 - 11,96	151	44.0	106.0	10	6	xxxxx ¹⁾
11,97	151	44.0	106.0	10	6	11970
11,98	151	44.0	106.0	10	6	11980
11,99	151	44.0	106.0	10	6	11990
12,00	151	44.0	106.0	10	6	12000

P	●
M	●
K	●
N	●
S	●
H	●
O	●

→ v_c Page 79

1) Not available ex stock, articles are non-returnable and cannot be exchanged / Minimum order 5 pieces

This tool concept permits numerous tolerances. Please refer to the table on → page 80 for tolerances covered. For xxxx please indicate required Ø in the order (e.g. Ø 8.03 mm → Article no. 40 115 08030)!

Machine reamers, DIN 212-B

- ▲ 0.01 mm steps
- ▲ tolerance: Ø 0.95 - 5.50 mm = +0.004 mm
- ▲ tolerance: Ø 5.51 - 12.00 mm = +0.005 mm

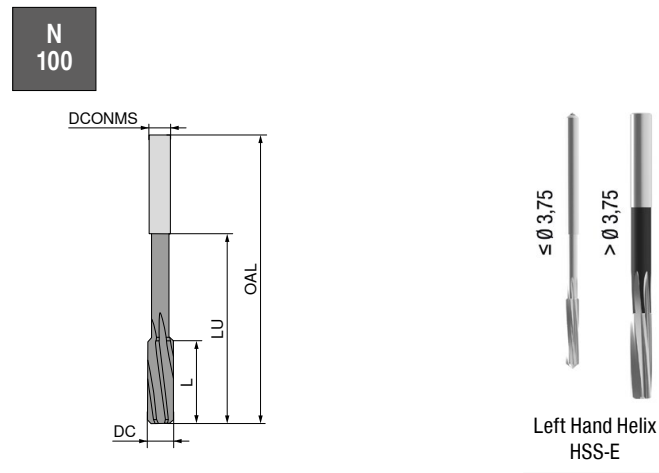

DC mm	OAL mm	L mm	LU mm	DCONMS _{h9} mm	ZEFP	
0,95 - 1,06	34	5.5	13	1.0	3	xxxxx ¹⁾
1,07 - 1,18	36	6.5	14	1.1	3	xxxxx ¹⁾
1,19 - 1,32	38	7.5	15	1.2	3	xxxxx ¹⁾
1,33 - 1,39	40	8.0	16	1.4	3	xxxxx ¹⁾
1,40 - 1,47	40	8.0	16	1.4	3	xxxxx ¹⁾
1,48	40	8.0	16	1.4	3	01480
1,49	40	8.0	16	1.4	3	01490
1,50	40	8.0	16	1.4	3	01500
1,51 - 1,70	43	9.0	18	1.6	3	xxxxx ¹⁾
1,71 - 1,90	46	10.0	20	1.8	4	xxxxx ¹⁾
1,91 - 1,97	49	11.0	22	2.0	4	xxxxx ¹⁾
1,98	49	11.0	22	2.0	4	01980
1,99	49	11.0	22	2.0	4	01990
2,00	49	11.0	22	2.0	4	02000
2,01	49	11.0	22	2.0	4	02010
2,02	49	11.0	22	2.0	4	02020
2,03	49	11.0	22	2.0	4	02030
2,04	49	11.0	22	2.0	4	02040
2,05	49	11.0	22	2.0	4	02050
2,06 - 2,09	49	11.0	22	2.0	4	xxxxx ¹⁾
2,10 - 2,12	49	11.0	22	2.0	4	xxxxx ¹⁾
2,13 - 2,36	53	12.0	24	2.2	4	xxxxx ¹⁾
2,37 - 2,49	57	14.0	26	2.5	4	xxxxx ¹⁾
2,50 - 2,59	57	14.0	26	2.5	4	xxxxx ¹⁾
2,60 - 2,65	57	14.0	26	2.5	4	xxxxx ¹⁾
2,66 - 2,80	61	15.0	30	2.8	6	xxxxx ¹⁾
2,81 - 2,94	61	15.0	29	3.0	6	xxxxx ¹⁾
2,95	61	15.0	29	3.0	6	02950
2,96	61	15.0	29	3.0	6	02960
2,97	61	15.0	29	3.0	6	02970
2,98	61	15.0	29	3.0	6	02980
2,99	61	15.0	29	3.0	6	02990
3,00	61	15.0	29	3.0	6	03000
3,01	65	16.0	33	3.2	6	03010
3,02	65	16.0	33	3.2	6	03020
3,03	65	16.0	33	3.2	6	03030
3,04	65	16.0	33	3.2	6	03040
3,05	65	16.0	33	3.2	6	03050
3,06	65	16.0	33	3.2	6	03060
3,07	65	16.0	33	3.2	6	03070
3,08 - 3,09	65	16.0	33	3.2	6	xxxxx ¹⁾
3,10 - 3,35	65	16.0	33	3.2	6	xxxxx ¹⁾
3,36 - 3,49	70	18.0	38	3.5	6	xxxxx ¹⁾
3,50 - 3,59	70	18.0	38	3.5	6	xxxxx ¹⁾
3,60 - 3,75	70	18.0	38	3.5	6	xxxxx ¹⁾
3,76 - 3,81	75	19.0	46	4.0	6	xxxxx ¹⁾
3,82 - 3,94	75	19.0	46	4.0	6	xxxxx ¹⁾
3,95	75	19.0	46	4.0	6	03950
3,96	75	19.0	46	4.0	6	03960
3,97	75	19.0	46	4.0	6	03970
3,98	75	19.0	46	4.0	6	03980
3,99	75	19.0	46	4.0	6	03990

40 140 ...

DC mm	OAL mm	L mm	LU mm	DCONMS _{h9} mm	ZEFP	
4,00	75	19.0	46	4.0	6	04000
4,01	75	19.0	46	4.0	6	04010
4,02	75	19.0	46	4.0	6	04020
4,03	75	19.0	46	4.0	6	04030
4,04	75	19.0	46	4.0	6	04040
4,05	75	19.0	46	4.0	6	04050
4,06	75	19.0	46	4.0	6	04060
4,07	75	19.0	46	4.0	6	04070
4,08	75	19.0	46	4.0	6	04080
4,09 - 4,20	75	19.0	46	4.0	6	xxxxx ¹⁾
4,21 - 4,25	75	19.0	46	4.0	6	xxxxx ¹⁾
4,26 - 4,75	80	21.0	51	4.5	5	xxxxx ¹⁾
4,76 - 4,95	86	23.0	57	5.0	6	xxxxx ¹⁾
4,96	86	23.0	57	5.0	6	04960
4,97	86	23.0	57	5.0	6	04970
4,98	86	23.0	57	5.0	6	04980
4,99	86	23.0	57	5.0	6	04990
5,00	86	23.0	57	5.0	6	05000
5,01	86	23.0	57	5.0	6	05010
5,02	86	23.0	57	5.0	6	05020
5,03	86	23.0	57	5.0	6	05030
5,04	86	23.0	57	5.0	6	05040
5,05	86	23.0	57	5.0	6	05050
5,06	86	23.0	57	5.0	6	05060
5,07	86	23.0	57	5.0	6	05070
5,08 - 5,20	86	23.0	57	5.0	6	xxxxx ¹⁾
5,21 - 5,30	86	23.0	57	5.0	6	xxxxx ¹⁾
5,31 - 5,94	93	26.0	56	5.6	6	xxxxx ¹⁾
5,95	93	26.0	56	5.6	6	05950
5,96	93	26.0	56	5.6	6	05960
5,97	93	26.0	56	5.6	6	05970
5,98	93	26.0	56	5.6	6	05980
5,99	93	26.0	56	5.6	6	05990

P	●
M	○
K	●
N	●
S	○
H	○
O	●

→ v_c Page 79

1) Not available ex stock, articles are non-returnable and cannot be exchanged / Delivery time 14 working days

This tool concept permits numerous tolerances. For achievable tolerances covered, please see the table on → page 80. For xxxxx please indicate required Ø in the order (e.g. Ø 10.06 mm → Article no. 40 140 10060)!

Machine reamers, DIN 212-B

- ▲ 0.01 mm steps
- ▲ tolerance: Ø 0.95 - 5.50 mm = +0.004 mm
- ▲ tolerance: Ø 5.51 - 12.00 mm = +0.005 mm

N
100

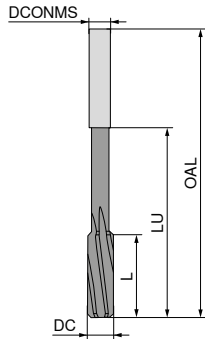

Left Hand Helix
HSS-E

DC mm	OAL mm	L mm	LU mm	DCONMS _{hg} mm	ZEFP	40 140 ...
6,00	93	26	56	5.6	6	06000
6,01	101	28	72	6.3	6	06010
6,02	101	28	72	6.3	6	06020
6,03	101	28	72	6.3	6	06030
6,04	101	28	72	6.3	6	06040
6,05	101	28	72	6.3	6	06050
6,06 - 6,11	101	28	72	6.3	6	xxxxx ¹⁾
6,12 - 6,34	101	28	72	6.3	6	xxxxx ¹⁾
6,35	101	28	72	6.3	6	06350
6,36	101	28	72	6.3	6	06360 ¹⁾
6,71 - 6,94	109	31	80	7.1	6	xxxxx ¹⁾
6,95	109	31	80	7.1	6	06950
6,96	109	31	80	7.1	6	06960
6,97	109	31	80	7.1	6	06970
6,98	109	31	80	7.1	6	06980
6,99	109	31	80	7.1	6	06990
7,00	109	31	80	7.1	6	07000
7,01	109	31	80	7.1	6	07010
7,02	109	31	80	7.1	6	07020
7,03	109	31	80	7.1	6	07030
7,04 - 7,50	109	31	80	7.1	6	xxxxx ¹⁾
7,51 - 7,63	117	33	80	7.1	6	xxxxx ¹⁾
7,64 - 7,94	117	33	80	8.0	6	xxxxx ¹⁾
7,95	117	33	84	8.0	6	07950
7,96	117	33	84	8.0	6	07960
7,97	117	33	84	8.0	6	07970
7,98	117	33	84	8.0	6	07980
7,99	117	33	84	8.0	6	07990
8,00	117	33	84	8.0	6	08000
8,01	117	33	84	8.0	6	08010
8,02	117	33	84	8.0	6	08020
8,03	117	33	84	8.0	6	08030
8,04	117	33	84	8.0	6	08040
8,05	117	33	84	8.0	6	08050
8,06 - 8,20	117	33	84	8.0	6	xxxxx ¹⁾
8,21 - 8,50	117	33	84	8.0	6	xxxxx ¹⁾
8,51 - 8,63	125	36	84	8.0	6	xxxxx ¹⁾
8,64 - 8,95	125	36	84	9.0	6	xxxxx ¹⁾
8,96	125	36	92	9.0	6	08960
8,97	125	36	92	9.0	6	08970
8,98	125	36	92	9.0	6	08980
8,99	125	36	92	9.0	6	08990
9,00	125	36	92	9.0	6	09000
9,01	125	36	92	9.0	6	09010
9,02	125	36	92	9.0	6	09020
9,03 - 9,50	125	36	92	9.0	6	xxxxx ¹⁾
9,51 - 9,63	133	38	92	9.0	6	xxxxx ¹⁾
9,64 - 9,95	133	38	92	10.0	6	xxxxx ¹⁾
9,96	133	38	101	10.0	6	09960
9,97	133	38	101	10.0	6	09970
9,98	133	38	101	10.0	6	09980
9,99	133	38	101	10.0	6	09990

40 140 ...

DC mm	OAL mm	L mm	LU mm	DCONMS _{hg} mm	ZEFP	40 140 ...
10,00	133	38	101	10.0	6	10000
10,01	133	38	101	10.0	6	10010
10,02	133	38	101	10.0	6	10020
10,03	133	38	101	10.0	6	10030
10,04	133	38	101	10.0	6	10040
10,05	133	38	101	10.0	6	10050
10,06 - 10,09	133	38	101	10.0	6	xxxxx ¹⁾
10,10	133	38	101	10.0	6	10100
10,11 - 10,19	133	38	101	10.0	6	xxxxx ¹⁾
10,20	133	38	101	10.0	6	10200
10,21 - 10,69	133	38	101	10.0	6	xxxxx ¹⁾
10,70 - 11,20	142	41	101	10.0	6	xxxxx ¹⁾
11,21 - 11,80	142	41	101	10.0	6	xxxxx ¹⁾
11,81 - 11,95	151	44	110	10.0	6	xxxxx ¹⁾
11,96	151	44	110	10.0	6	11960
11,97	151	44	110	10.0	6	11970
11,98	151	44	110	10.0	6	11980
11,99	151	44	110	10.0	6	11990
12,00	151	44	110	10.0	6	12000

P	●
M	○
K	●
N	●
S	○
H	●
O	●

→ v_c Page 79

1) Not available ex stock, articles are non-returnable and cannot be exchanged / Delivery time 14 working days



This tool concept permits numerous tolerances. For achievable tolerances covered, please see the table on → page 80. For xxxxx please indicate required Ø in the order (e.g. Ø 10.06 mm → Article no. 40 140 10060)!

Stub reamers, DIN 8089-B

AR

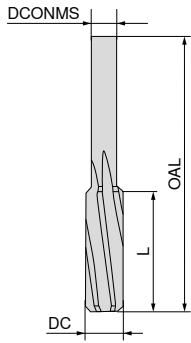

Left Hand Helix
HSS-E
Through hole

40 145 ...

DC _{H7} mm	OAL mm	L mm	DCONMS _{h8} mm	ZEPF	
4.0	56	20	3.55	6	040
4.5	63	22	4.00	6	045
5.0	63	22	4.00	6	050
5.5	63	22	5.00	6	055
6.0	63	22	5.00	6	060
6.5	63	22	5.00	6	065
7.0	71	25	6.30	6	070
8.0	71	25	6.30	6	080
9.0	71	25	8.00	6	090
10.0	71	25	8.00	6	100
11.0	80	28	10.00	6	110
12.0	80	28	10.00	6	120

P	●
M	○
K	●
N	●
S	○
H	
O	●

→ v_c Page 79

Stub reamers, DIN 8089-B

- ▲ 0.01 mm steps
- ▲ tolerance: Ø 3.76 - 5.50 mm = +0.004 mm
- ▲ tolerance: Ø 5.51 - 12.00 mm = +0.005 mm

AR
100

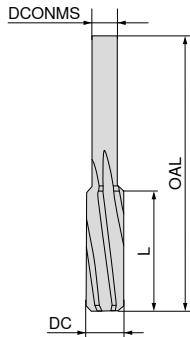

HSS-E
Left Hand Helix

40 139 ...

DC mm	OAL mm	L mm	DCONMS _{h8} mm	ZEFP	
3,76 - 3,81	56	20	3.55	6	xxxxx ¹⁾
3,82 - 3,94	56	20	3.55	6	xxxxx ¹⁾
3,95	56	20	3.55	6	03950
3,96	56	20	3.55	6	03960
3,97	56	20	3.55	6	03970
3,98	56	20	3.55	6	03980
3,99	56	20	3.55	6	03990
4,00	56	20	3.55	6	04000
4,01	56	20	3.55	6	04010
4,02	56	20	3.55	6	04020
4,03 - 4,20	56	20	3.55	6	xxxxx ¹⁾
4,21 - 4,25	56	20	3.55	6	xxxxx ¹⁾
4,26 - 4,75	63	22	4.00	6	xxxxx ¹⁾
4,76 - 4,94	63	22	4.00	6	xxxxx ¹⁾
4,95	63	22	4.00	6	04950
4,96	63	22	4.00	6	04960
4,97	63	22	4.00	6	04970
4,98	63	22	4.00	6	04980
4,99	63	22	4.00	6	04990
5,00	63	22	4.00	6	05000
5,01	63	22	4.00	6	05010
5,02	63	22	4.00	6	05020
5,03	63	22	4.00	6	05030
5,04	63	22	4.00	6	05040
5,05	63	22	4.00	6	05050
5,06 - 5,20	63	22	4.00	6	xxxxx ¹⁾
5,21 - 5,30	63	22	4.00	6	xxxxx ¹⁾
5,31 - 5,70	63	22	5.00	6	xxxxx ¹⁾
5,71 - 5,94	63	22	5.00	6	xxxxx ¹⁾
5,95	63	22	5.00	6	05950
5,96	63	22	5.00	6	05960
5,97	63	22	5.00	6	05970
5,98	63	22	5.00	6	05980
5,99	63	22	5.00	6	05990
6,00	63	22	5.00	6	06000
6,01	63	22	5.00	6	06010
6,02	63	22	5.00	6	06020
6,03 - 6,11	63	22	5.00	6	xxxxx ¹⁾
6,12 - 6,70	63	22	5.00	6	xxxxx ¹⁾
6,71 - 6,94	71	25	6.30	6	xxxxx ¹⁾
6,95	71	25	6.30	6	06950
6,96	71	25	6.30	6	06960
6,97	71	25	6.30	6	06970
6,98	71	25	6.30	6	06980
6,99	71	25	6.30	6	06990
7,00	71	25	6.30	6	07000
7,01	71	25	6.30	6	07010
7,02	71	25	6.30	6	07020
7,03 - 7,25	71	25	6.30	6	xxxxx ¹⁾
7,26 - 7,94	71	25	6.30	6	xxxxx ¹⁾
7,95	71	25	6.30	6	07950
7,96	71	25	6.30	6	07960

40 139 ...

DC mm	OAL mm	L mm	DCONMS _{h8} mm	ZEFP	
7,97	71	25	6.30	6	07970
7,98	71	25	6.30	6	07980
7,99	71	25	6.30	6	07990
8,00	71	25	6.30	6	08000
8,01	71	25	6.30	6	08010
8,02	71	25	6.30	6	08020
8,03	71	25	6.30	6	08030
8,04	71	25	6.30	6	08040
8,05 - 8,20	71	25	6.30	6	xxxxx ¹⁾
8,21 - 8,50	71	25	6.30	6	xxxxx ¹⁾
8,51 - 8,94	71	25	8.00	6	xxxxx ¹⁾
8,95	71	25	8.00	6	08950
8,96	71	25	8.00	6	08960
8,97	71	25	8.00	6	08970
8,98	71	25	8.00	6	08980
8,99	71	25	8.00	6	08990
9,00	71	25	8.00	6	09000
9,01	71	25	8.00	6	09010
9,02	71	25	8.00	6	09020
9,03 - 9,25	71	25	8.00	6	xxxxx ¹⁾
9,26 - 9,94	71	25	8.00	6	xxxxx ¹⁾
9,95	71	25	8.00	6	09950
9,96	71	25	8.00	6	09960
9,97	71	25	8.00	6	09970
9,98	71	25	8.00	6	09980
9,99	71	25	8.00	6	09990
10,00	71	25	8.00	6	10000
10,01	71	25	8.00	6	10010
10,02	71	25	8.00	6	10020
10,03 - 10,20	71	25	8.00	6	xxxxx ¹⁾
10,21 - 10,60	71	25	8.00	6	xxxxx ¹⁾
10,61 - 11,20	80	28	10.00	6	xxxxx ¹⁾
11,21 - 11,25	80	28	10.00	6	xxxxx ¹⁾
11,26 - 11,94	80	28	10.00	6	xxxxx ¹⁾
11,95	80	28	10.00	6	11950
11,96	80	28	10.00	6	11960
11,97	80	28	10.00	6	11970
11,98	80	28	10.00	6	11980
11,99	80	28	10.00	6	11990
12,00	80	28	10.00	6	12000

P	●
M	○
K	●
N	●
S	○
H	
O	●

→ v_c Page 79

1) Not available ex stock, articles are non-returnable and cannot be exchanged /
Delivery time 14 working days



This tool concept permits numerous tolerances.
For achievable tolerances covered, please see the table on → page 80.
For xxxxx please indicate required Ø in the order
(e.g. Ø 10.06 mm → Article no. 40 139 10060!)

Material examples for cutting data tables

	Material sub-group	Index	Composition / Structure / Heat treatment	Tensile strength N/mm ² / HB / HRC	Material number	Material designation	Material number	Material designation
P	Unalloyed steel	P.1.1	< 0,15 % C Annealed	420 N/mm ² / 125 HB	1.0401	C15	1.1141	Ck15
		P.1.2	< 0,45 % C Annealed	640 N/mm ² / 190 HB	1.1191	C45E	1.0718	9SMnPb28
		P.1.3	< 0,45 % C Tempered	840 N/mm ² / 250 HB	1.1191	C45E	1.0535	C55
		P.1.4	< 0,75 % C Annealed	910 N/mm ² / 270 HB	1.1223	C60R	1.0535	C55
		P.1.5	< 0,75 % C Tempered	1010 N/mm ² / 300 HB	1.1223	C60R	1.0727	45S20
	Low-alloy steel	P.2.1	Annealed	610 N/mm ² / 180 HB	1.7131	16MnCr5	1.6587	17CrNiMo6
		P.2.2	Tempered	930 N/mm ² / 275 HB	1.7131	16MnCr5	1.6587	17CrNiMo6
		P.2.3	Tempered	1010 N/mm ² / 300 HB	1.7225	42CrMo4	1.3505	100Cr6
		P.2.4	Tempered	1200 N/mm ² / 375 HB	1.7225	42CrMo4	1.3505	100Cr6
	High-alloy steel and high-alloy tool steel	P.3.1	Annealed	680 N/mm ² / 200 HB	1.4021	X20Cr13	1.4034	X46Cr13
		P.3.2	Hardened and tempered	1100 N/mm ² / 300 HB	1.2343	X38CrMoV5-1	1.4034	X46Cr13
		P.3.3	Hardened and tempered	1300 N/mm ² / 400 HB	1.2343	X38CrMoV5-1	1.4034	X46Cr13
	Stainless steel	P.4.1	Ferritic / martensitic Annealed	680 N/mm ² / 200 HB	1.4016	X6Cr17	1.2316	X36CrMo16
		P.4.2	Martensitic Tempered	1010 N/mm ² / 300 HB	1.4112	X90CrMoV18	1.2316	X36CrMo16
M	Stainless steel	M.1.1	Austenitic / austenitic-ferritic Quenched	610 N/mm ² / 180 HB	1.4301	X5CrNi18-10	1.4571	X6CrNiMoTi17-12-2
		M.2.1	Austenitic Tempered	300 HB	1.4841	X15CrNiSi25-21	1.4539	X1NiCrMoCu25-20-5
		M.3.1	Austenitic / ferritic (Duplex)	780 N/mm ² / 230 HB	1.4462	X2CrNiMoN22-5-3	1.4501	X2CrNiMoCuWN25-7-4
K	Grey cast iron	K.1.1	Pearlitic / ferritic	350 N/mm ² / 180 HB	0.6010	GG-10	0.6025	GG-25
		K.1.2	Pearlitic (martensitic)	500 N/mm ² / 260 HB	0.6030	GG-30	0.6045	GG-45
	Spherulitic graphite cast iron	K.2.1	Ferritic	540 N/mm ² / 160 HB	0.7040	GGG-40	0.7060	GGG-60
		K.2.2	Pearlitic	845 N/mm ² / 250 HB	0.7070	GGG-70	0.7080	GGG-80
	Malleable iron	K.3.1	Ferritic	440 N/mm ² / 130 HB	0.8035	GTW-35-04	0.8045	GTW-45
		K.3.2	Pearlitic	780 N/mm ² / 230 HB	0.8165	GTS-65-02	0.8170	GTS-70-02
N	Aluminium wrought alloy	N.1.1	Non-hardenable	60 HB	3.0255	Al99,5	3.3315	AlMg1
		N.1.2	Hardenable Age-hardened	340 N/mm ² / 100 HB	3.1355	AlCuMg2	3.2315	AlMgSi1
	Cast aluminium alloy	N.2.1	≤ 12 % Si, non-hardenable	250 N/mm ² / 75 HB	3.2581	G-AlSi12	3.2163	G-AlSi9Cu3
		N.2.2	≤ 12 % Si, hardenable Age-hardened	300 N/mm ² / 90 HB	3.2134	G-AlSi5Cu1Mg	3.2373	G-AlSi9Mg
		N.2.3	> 12 % Si, non-hardenable	440 N/mm ² / 130 HB		G-AlSi17Cu4Mg		G-AlSi18CuNiMg
	Copper and copper alloys (bronze/brass)	N.3.1	Free-machining alloys, PB > 1 %	375 N/mm ² / 110 HB	2.0380	CuZn39Pb2 (Ms58)	2.0410	CuZn44Pb2
		N.3.2	CuZn, CuSnZn	300 N/mm ² / 90 HB	2.0331	CuZn15	2.4070	CuZn28Sn1As
		N.3.3	CuSn, lead-free copper and electrolytic copper	340 N/mm ² / 100 HB	2.0060	E-Cu57	2.0590	CuZn40Fe
	Magnesium alloys	N.4.1	Magnesium and magnesium alloys	70 HB	3.5612	MgAl6Zn	3.5312	MgAl3Zn
	S	Heat-resistant alloys	S.1.1	Fe - basis Annealed	680 N/mm ² / 200 HB	1.4864	X12NiCrSi 36-16	1.4865
S.1.2			Fe - basis Age-hardened	950 N/mm ² / 280 HB	1.4980	X6NiCrTiMoVB25-15-2	1.4876	X10NiCrAlTi32-20
S.2.1			Ni or Co basis Annealed	840 N/mm ² / 250 HB	2.4631	NiCr20TiAl (Nimonic80A)	3.4856	NiCr22Mo9Nb
S.2.2			Ni or Co basis Age-hardened	1180 N/mm ² / 350 HB	2.4668	NiCr19Nb5Mo3 (Inconel 718)	2.4955	NiFe25Cr20NbTi
S.2.3			Ni or Co basis Cast	1080 N/mm ² / 320 HB	2.4765	CoCr20W15Ni	1.3401	G-X120Mn12
Titanium alloys		S.3.1	Pure titanium	400 N/mm ²	3.7025	Ti99,8	3.7034	Ti99,7
		S.3.2	Alpha + beta alloys Age-hardened	1050 N/mm ² / 320 HB	3.7165	TiAl6V4	Ti-6246	Ti-6Al-2Sn-4Zr-6Mo
		S.3.3	Beta alloys	1400 N/mm ² / 410 HB	Ti555.3	Ti-5Al-5V-5Mo-3Cr	R56410	Ti-10V-2Fe-3Al
H	Hardened steel	H.1.1	Hardened and tempered	46-55 HRC				
		H.1.2	Hardened and tempered	56-60 HRC				
		H.1.3	Hardened and tempered	61-65 HRC				
		H.1.4	Hardened and tempered	66-70 HRC				
	Chilled iron	H.2.1	Cast	400 HB				
	Hardened cast iron	H.3.1	Hardened and tempered	55 HRC				
O	Non-metal materials	O.1.1	Plastics, duroplastic	≤ 150 N/mm ²				
		O.1.2	Plastics, thermoplastic	≤ 100 N/mm ²				
		O.2.1	Aramid fibre-reinforced	≤ 1000 N/mm ²				
		O.2.2	Glass/carbon-fibre reinforced	≤ 1000 N/mm ²				
		O.3.1	Graphite					

* Tensile strength

Cutting data standard values for Monomax

Index	40 648 ... / 56J.17 – ASG0706			40 640... / 56H.17 – ASG0706			
	DBC			DBC			
	40 648 ... / 56J.17 – ASG0706			40 640... / 56H.17 – ASG0706			
	Grade / coating	5,6–8,899		5,6–8,899		8,9–12,00	
	Article no. / type	8,9–12,00		0,10–0,20		0,10–0,30	
Nominal Ø in mm	5,6–8,899		8,9–12,00		5,6–8,899		
Reaming Allowance Ø	0,10–0,20		0,10–0,30		0,10–0,20		
Number of flutes	4		6		4		
	v_c m/min	f mm/rev.	f mm/rev.	v_c m/min	f mm/rev.	f mm/rev.	
P.1.1							
P.1.2							
P.1.3							
P.1.4							
P.1.5							
P.2.1							
P.2.2							
P.2.3							
P.2.4							
P.3.1							
P.3.2							
P.3.3							
P.4.1							
P.4.2							
M.1.1							
M.2.1							
M.3.1							
K.1.1							
K.1.2							
K.2.1							
K.2.2							
K.3.1							
K.3.2							
N.1.1	150 (130–300)	0,40–0,60	0,40–0,60	150 (130–300)	0,40–0,60	0,40–0,60	
N.1.2	150 (130–300)	0,40–0,60	0,40–0,60	150 (130–300)	0,40–0,60	0,40–0,60	
N.2.1	200 (180–300)	0,40–0,60	0,40–0,60	200 (180–300)	0,40–0,60	0,40–0,60	
N.2.2	200 (180–300)	0,40–0,60	0,40–0,60	200 (180–300)	0,40–0,60	0,40–0,60	
N.2.3	200 (180–300)	0,40–0,60	0,40–0,60	200 (180–300)	0,40–0,60	0,40–0,60	
N.3.1							
N.3.2							
N.3.3							
N.4.1							
S.1.1							
S.1.2							
S.2.1							
S.2.2							
S.2.3							
S.3.1							
S.3.2							
S.3.3							
H.1.1							
H.1.2							
H.1.3							
H.1.4							
H.2.1							
H.3.1							
O.1.1							
O.1.2							
O.2.1							
O.2.2							
O.3.1	250 (220–270)	0,40–0,60	0,40–0,60	250 (220–270)	0,40–0,60	0,40–0,60	

 The cutting data depend extremely on the external conditions, the material and machine type.
The indicated values are possible values which have to be increased or reduced, inside the bracket, according to the application conditions.



Cutting data standard values for Monomax

Index	HM-DBG-P			HM-DBG-P		
	40 657 ... / 56H.65 – ASG3000			40 652 ... / 56J.65 – ASG0106		
	Grade / coating					
	Article no. / type					
	Nominal Ø in mm	5,6–8,899	8,9–12,00	5,6–8,899	8,9–12,00	
Reaming allowance Ø	0,10–0,20	0,10–0,30	0,10–0,20	0,10–0,30		
Number of flutes	4	6	4	6		
v_c m/min	f mm/rev.	f mm/rev.	v_c m/min	f mm/rev.	f mm/rev.	
P.1.1	150 (130–200)	0,30–0,50	0,50–0,70			
P.1.2	150 (130–200)	0,30–0,50	0,50–0,70			
P.1.3	150 (130–200)	0,30–0,50	0,50–0,70			
P.1.4	150 (130–200)	0,30–0,50	0,50–0,70			
P.1.5	150 (130–200)	0,30–0,50	0,50–0,70			
P.2.1	150 (130–200)	0,30–0,50	0,50–0,70			
P.2.2	150 (130–200)	0,30–0,50	0,50–0,70			
P.2.3	150 (130–200)	0,30–0,50	0,50–0,70			
P.2.4	60 (50–100)	0,20–0,30	0,40–0,50	60 (50–100)	0,20–0,30 0,40–0,50	
P.3.1				40 (35–60)	0,20–0,30 0,40–0,50	
P.3.2				40 (35–60)	0,20–0,30 0,40–0,50	
P.3.3				30 (25–50)	0,30–0,40 0,40–0,60	
P.4.1				45 (35–60)	0,30–0,40 0,40–0,60	
P.4.2				45 (35–60)	0,30–0,40 0,40–0,60	
M.1.1				30 (25–50)	0,30–0,40 0,40–0,60	
M.2.1				30 (25–50)	0,30–0,40 0,40–0,60	
M.3.1				30 (25–50)	0,30–0,40 0,40–0,60	
K.1.1	150 (130–220)	0,40–0,60	0,70–0,90			
K.1.2	150 (130–220)	0,40–0,60	0,70–0,90			
K.2.1	175 (150–300)	0,40–0,60	0,70–0,90			
K.2.2	120 (100–180)	0,30–0,50	0,50–0,70			
K.3.1	150 (130–250)	0,40–0,60	0,70–0,90			
K.3.2	120 (100–180)	0,30–0,50	0,50–0,70			
N.1.1						
N.1.2						
N.2.1						
N.2.2						
N.2.3						
N.3.1						
N.3.2						
N.3.3						
N.4.1						
S.1.1						
S.1.2						
S.2.1						
S.2.2						
S.2.3						
S.3.1						
S.3.2						
S.3.3						
H.1.1						
H.1.2						
H.1.3						
H.1.4						
H.2.1						
H.3.1						
O.1.1						
O.1.2						
O.2.1						
O.2.2						
O.3.1						

 The cutting data depend extremely on the external conditions, the material and machine type.
The indicated values are possible values which have to be increased or reduced, inside the bracket, according to the application conditions.

Cutting data standard values for Monomax

Index	DST			DST		
	Grade / coating	40 625 ... / 56J.93 – ASG3000		40 635 ... / 56J.93 – ASG4000		
	Article no. / type	40 625 ... / 56J.93 – ASG3000		40 635 ... / 56J.93 – ASG4000		
	Nominal Ø in mm	5,6–8,899	8,9–12,00	5,6–8,899	8,9–12,00	
	Reaming allowance Ø	0,10–0,20	0,10–0,30	0,10–0,20	0,10–0,30	
	Number of flutes		Number of flutes			
	4	6	4	6		
	v_c m/min	f mm/rev.	f mm/rev.	v_c m/min	f mm/rev.	f mm/rev.
P.1.1	150 (130–200)	0,30–0,50	0,50–0,70	150 (130–200)	0,40–0,60	0,70–0,90
P.1.2	150 (130–200)	0,30–0,50	0,50–0,70	150 (130–200)	0,40–0,60	0,70–0,90
P.1.3	150 (130–200)	0,30–0,50	0,50–0,70	150 (130–200)	0,40–0,60	0,70–0,90
P.1.4	150 (130–200)	0,30–0,50	0,50–0,70	150 (130–200)	0,40–0,60	0,70–0,90
P.1.5	150 (130–200)	0,30–0,50	0,50–0,70	150 (130–200)	0,40–0,60	0,70–0,90
P.2.1	150 (130–200)	0,30–0,50	0,50–0,70	150 (130–200)	0,40–0,60	0,70–0,90
P.2.2	150 (130–200)	0,30–0,50	0,50–0,70	150 (130–200)	0,40–0,60	0,70–0,90
P.2.3	150 (130–200)	0,30–0,50	0,50–0,70	150 (130–200)	0,40–0,60	0,70–0,90
P.2.4						
P.3.1						
P.3.2						
P.3.3						
P.4.1						
P.4.2						
M.1.1						
M.2.1						
M.3.1						
K.1.1						
K.1.2						
K.2.1	175 (150–300)	0,40–0,60	0,70–0,90	175 (150–300)	0,40–0,60	0,70–0,90
K.2.2	120 (100–150)	0,30–0,50	0,50–0,70	120 (100–180)	0,30–0,50	0,50–0,70
K.3.1	150 (130–250)	0,40–0,60	0,70–0,90	120 (100–180)	0,30–0,50	0,50–0,70
K.3.2	120 (100–180)	0,30–0,50	0,50–0,70	120 (100–180)	0,30–0,50	0,50–0,70
N.1.1						
N.1.2						
N.2.1						
N.2.2						
N.2.3						
N.3.1	150 (130–300)	0,40–0,60	0,60–0,90			
N.3.2	150 (130–300)	0,40–0,60	0,60–0,90			
N.3.3						
N.4.1						
S.1.1						
S.1.2						
S.2.1						
S.2.2						
S.2.3						
S.3.1						
S.3.2						
S.3.3						
H.1.1						
H.1.2						
H.1.3						
H.1.4						
H.2.1						
H.3.1						
O.1.1						
O.1.2						
O.2.1						
O.2.2						
O.3.1						

 The cutting data depend extremely on the external conditions, the material and machine type.
The indicated values are possible values which have to be increased or reduced, inside the bracket, according to the application conditions.

Cutting data standard values for Monomax

Index	HM-DBG-P			HM-TiN		
	40 644 ... / 56H.65 – ASG0106			40 605 ... / 56J.71 – ASG3000		
	Grade / coating			Grade / coating		
	Article no. / type			Article no. / type		
	Number of flutes			Number of flutes		
	v_c m/min	f mm/rev.	f mm/rev.	v_c m/min	f mm/rev.	f mm/rev.
P.1.1				100 (80–140)	0,30–0,50	0,50–0,70
P.1.2				100 (80–140)	0,30–0,50	0,50–0,70
P.1.3				100 (80–140)	0,30–0,50	0,50–0,70
P.1.4				100 (80–140)	0,30–0,50	0,50–0,70
P.1.5				100 (80–140)	0,30–0,50	0,50–0,70
P.2.1				100 (80–140)	0,30–0,50	0,50–0,70
P.2.2				100 (80–140)	0,30–0,50	0,50–0,70
P.2.3				100 (80–140)	0,30–0,50	0,50–0,70
P.2.4				100 (80–140)	0,30–0,50	0,50–0,70
P.3.1	30 (25–50)	0,30–0,40	0,40–0,60			
P.3.2	30 (25–50)	0,30–0,40	0,40–0,60			
P.3.3	30 (25–50)	0,30–0,40	0,40–0,60			
P.4.1	45 (35–60)	0,30–0,40	0,40–0,60			
P.4.2	45 (35–60)	0,30–0,40	0,40–0,60			
M.1.1	45 (35–60)	0,30–0,40	0,40–0,60			
M.2.1	45 (35–60)	0,30–0,40	0,40–0,60			
M.3.1	30 (25–50)	0,30–0,40	0,40–0,60			
K.1.1				80 (60–130)	0,40–0,60	0,70–0,90
K.1.2				80 (60–130)	0,40–0,60	0,70–0,90
K.2.1						
K.2.2						
K.3.1						
K.3.2						
N.1.1						
N.1.2						
N.2.1						
N.2.2						
N.2.3						
N.3.1				120 (–200)	0,40–0,60	0,60–0,90
N.3.2				120 (–200)	0,40–0,60	0,60–0,90
N.3.3				80 (–150)	0,40–0,60	0,60–0,90
N.4.1						
S.1.1						
S.1.2						
S.2.1						
S.2.2						
S.2.3						
S.3.1						
S.3.2						
S.3.3						
H.1.1						
H.1.2						
H.1.3						
H.1.4						
H.2.1						
H.3.1						
O.1.1						
O.1.2						
O.2.1						
O.2.2						
O.3.1						



The cutting data depend extremely on the external conditions, the material and machine type.
The indicated values are possible values which have to be increased or reduced, inside the bracket, according to the application conditions.

Cutting data standard values for Fullmax, short

Type UNI		40 481 ... / 40 483 ... / 40 488 ... / 40 489 ...							
		Ø 2,97 – 4,05		Ø 4,06 – 6,05		Ø 6,06 – 7,55		Ø 7,56 – 12,05	
Number of flutes		4		4		6		6	
Index	v_c m/min	f mm/rev.	Reaming allowance Ø mm	f mm/rev.	Reaming allowance Ø mm	f mm/rev.	Reaming allowance Ø mm	f mm/rev.	Reaming allowance Ø mm
P.1.1	200 (180–250)	0,65–0,80	0,10–0,20	0,75–0,90	0,10–0,20	1,40–1,60	0,20	1,65–1,80	0,20
P.1.2	200 (180–250)	0,65–0,80	0,10–0,20	0,75–0,90	0,10–0,20	1,40–1,60	0,20	1,65–1,80	0,20
P.1.3	200 (180–250)	0,65–0,80	0,10–0,20	0,75–0,90	0,10–0,20	1,40–1,60	0,20	1,65–1,80	0,20
P.1.4	200 (180–250)	0,65–0,80	0,10–0,20	0,75–0,90	0,10–0,20	1,40–1,60	0,20	1,65–1,80	0,20
P.1.5	200 (180–250)	0,65–0,80	0,10–0,20	0,75–0,90	0,10–0,20	1,40–1,60	0,20	1,65–1,80	0,20
P.2.1	200 (180–250)	0,65–0,80	0,10–0,20	0,75–0,90	0,10–0,20	1,40–1,60	0,20	1,65–1,80	0,20
P.2.2	200 (180–250)	0,65–0,80	0,10–0,20	0,75–0,90	0,10–0,20	1,40–1,60	0,20	1,65–1,80	0,20
P.2.3	200 (180–250)	0,65–0,80	0,10–0,20	0,75–0,90	0,10–0,20	1,40–1,60	0,20	1,65–1,80	0,20
P.2.4	65 (55–110)	0,45–0,50	0,10–0,20	0,45–0,60	0,10–0,20	1,00–1,10	0,20	1,20–1,30	0,20
P.3.1	40 (30–80)	0,40–0,60	0,10–0,20	0,50–0,70	0,10–0,20	1,00–1,30	0,20	1,10–1,40	0,20
P.3.2	40 (30–80)	0,40–0,60	0,10–0,20	0,50–0,70	0,10–0,20	1,00–1,30	0,20	1,10–1,40	0,20
P.3.3	40 (30–80)	0,40–0,60	0,10–0,20	0,50–0,70	0,10–0,20	1,00–1,30	0,20	1,10–1,40	0,20
P.4.1	45 (40–65)	0,45–0,50	0,10–0,20	0,45–0,60	0,10–0,20	1,00–1,10	0,20	1,20–1,30	0,20
P.4.2	45 (40–65)	0,45–0,50	0,10–0,20	0,45–0,60	0,10–0,20	1,00–1,10	0,20	1,20–1,30	0,20
M.1.1	40 (35–60)	0,40–0,60	0,10–0,20	0,50–0,70	0,10–0,20	1,00–1,30	0,20	1,10–1,40	0,20
M.2.1	40 (35–60)	0,40–0,60	0,10–0,20	0,50–0,70	0,10–0,20	1,00–1,30	0,20	1,10–1,40	0,20
M.3.1	40 (35–60)	0,40–0,60	0,10–0,20	0,50–0,70	0,10–0,20	1,00–1,30	0,20	1,10–1,40	0,20
K.1.1	200 (180–250)	0,80–1,00	0,10–0,20	0,90–1,20	0,10–0,20	1,50–1,90	0,20	1,50–1,90	0,20
K.1.2	200 (180–250)	0,80–1,00	0,10–0,20	0,90–1,20	0,10–0,20	1,50–1,90	0,20	1,50–1,90	0,20
K.2.1	225 (200–300)	0,80–1,00	0,10–0,20	0,90–1,20	0,10–0,20	1,50–1,90	0,20	1,50–1,90	0,20
K.2.2	120 (100–150)	0,60–0,90	0,10–0,20	0,70–1,00	0,10–0,20	1,20–1,60	0,20	1,20–1,60	0,20
K.3.1	225 (200–300)	0,80–1,00	0,10–0,20	0,90–1,20	0,10–0,20	1,50–1,90	0,20	1,50–1,90	0,20
K.3.2	120 (100–150)	0,60–0,90	0,10–0,20	0,70–1,00	0,10–0,20	1,20–1,60	0,20	1,20–1,60	0,20
N.1.1									
N.1.2									
N.2.1									
N.2.2									
N.2.3									
N.3.1	150 (120–250)	0,50–0,80	0,10–0,20	0,70–0,90	0,10–0,20	1,30–1,40	0,20	1,40–1,70	0,20
N.3.2	100 (80–150)	0,40–0,60	0,10–0,20	0,60–0,80	0,10–0,20	1,00–1,30	0,20	1,20–1,40	0,20
N.3.3									
N.4.1									
S.1.1									
S.1.2									
S.2.1	40 (30–60)	0,30–0,40	0,10–0,20	0,40–0,50	0,10–0,20	0,70–0,90	0,20	0,80–1,10	0,20
S.2.2	40 (30–60)	0,30–0,40	0,10–0,20	0,40–0,50	0,10–0,20	0,70–0,90	0,20	0,80–1,10	0,20
S.2.3									
S.3.1	30 (25–60)	0,30–0,40	0,10–0,20	0,40–0,50	0,10–0,20	0,70–0,90	0,20	0,80–1,10	0,20
S.3.2	30 (25–60)	0,30–0,40	0,10–0,20	0,40–0,50	0,10–0,20	0,70–0,90	0,20	0,80–1,10	0,20
S.3.3									
H.1.1	40 (35–60)	0,20–0,30	0,10–0,20	0,20–0,30	0,10–0,20	0,40–0,60	0,20	0,50–0,60	0,20
H.1.2	30 (25–50)	0,20–0,30	0,10–0,20	0,20–0,30	0,10–0,20	0,40–0,60	0,20	0,50–0,60	0,20
H.1.3	30 (25–50)	0,20–0,30	0,10–0,20	0,20–0,30	0,10–0,20	0,40–0,60	0,20	0,50–0,60	0,20
H.1.4									
H.2.1	40 (35–60)	0,50–0,60	0,10–0,20	0,60–0,90	0,10–0,20	1,10–1,60	0,20	1,20–1,60	0,20
H.3.1	40 (35–60)	0,50–0,60	0,10–0,20	0,60–0,90	0,10–0,20	1,10–1,60	0,20	1,20–1,60	0,20
O.1.1									
O.1.2									
O.2.1									
O.2.2									
O.3.1									

 The cutting data depend extremely on the external conditions, the material and machine type.
The indicated values are possible values which have to be increased or reduced, inside the bracket, according to the application conditions.

Cutting data standard values for Fullmax, long

Type UNI		40 484 ... / 40 485 ... / 40 486 ... / 40 487 ...							
		Ø 2,97 – 4,05		Ø 4,06 – 6,05		Ø 6,06 – 7,55		Ø 7,56 – 12,05	
Number of flutes		4		4		6		6	
Index	v_c m/min	f mm/rev.	Reaming allowance Ø mm	f mm/rev.	Reaming allowance Ø mm	f mm/rev.	Reaming allowance Ø mm	f mm/rev.	Reaming allowance Ø mm
P.1.1	180 (160–250)	0,60–0,80	0,10–0,20	0,70–0,90	0,10–0,20	1,30–1,60	0,20	1,40–1,80	0,20
P.1.2	180 (160–250)	0,60–0,80	0,10–0,20	0,70–0,90	0,10–0,20	1,30–1,60	0,20	1,40–1,80	0,20
P.1.3	180 (160–250)	0,60–0,80	0,10–0,20	0,70–0,90	0,10–0,20	1,30–1,60	0,20	1,40–1,80	0,20
P.1.4	180 (160–250)	0,60–0,80	0,10–0,20	0,70–0,90	0,10–0,20	1,30–1,60	0,20	1,40–1,80	0,20
P.1.5	180 (160–250)	0,60–0,80	0,10–0,20	0,70–0,90	0,10–0,20	1,30–1,60	0,20	1,40–1,80	0,20
P.2.1	180 (160–250)	0,60–0,80	0,10–0,20	0,70–0,90	0,10–0,20	1,30–1,60	0,20	1,40–1,80	0,20
P.2.2	180 (160–250)	0,60–0,80	0,10–0,20	0,70–0,90	0,10–0,20	1,30–1,60	0,20	1,40–1,80	0,20
P.2.3	180 (160–250)	0,60–0,80	0,10–0,20	0,70–0,90	0,10–0,20	1,30–1,60	0,20	1,40–1,80	0,20
P.2.4	80 (70–120)	0,40–0,50	0,10–0,20	0,40–0,60	0,10–0,20	0,90–1,10	0,20	1,00–1,20	0,20
P.3.1	20 (15–40)	0,32–0,50	0,10–0,20	0,32–0,50	0,10–0,20	0,48–0,60	0,20	0,48–0,60	0,20
P.3.2	20 (15–40)	0,32–0,50	0,10–0,20	0,32–0,50	0,10–0,20	0,48–0,60	0,20	0,48–0,60	0,20
P.3.3	20 (15–40)	0,32–0,50	0,10–0,20	0,32–0,50	0,10–0,20	0,48–0,60	0,20	0,48–0,60	0,20
P.4.1	20 (15–40)	0,32–0,50	0,10–0,20	0,32–0,50	0,10–0,20	0,48–0,60	0,20	0,48–0,60	0,20
P.4.2	20 (15–40)	0,32–0,50	0,10–0,20	0,32–0,50	0,10–0,20	0,48–0,60	0,20	0,48–0,60	0,20
M.1.1	20 (15–40)	0,32–0,50	0,10–0,20	0,32–0,50	0,10–0,20	0,48–0,60	0,20	0,48–0,60	0,20
M.2.1	20 (15–40)	0,32–0,50	0,10–0,20	0,32–0,50	0,10–0,20	0,48–0,60	0,20	0,48–0,60	0,20
M.3.1	15 (10–30)	0,32–0,50	0,10–0,20	0,32–0,50	0,10–0,20	0,48–0,60	0,20	0,48–0,60	0,20
K.1.1	120 (100–180)	0,60–0,80	0,10–0,20	0,70–0,90	0,10–0,20	1,30–1,60	0,20	1,30–1,60	0,20
K.1.2	120 (100–180)	0,60–0,80	0,10–0,20	0,70–0,90	0,10–0,20	1,30–1,60	0,20	1,30–1,60	0,20
K.2.1	200 (180–250)	0,60–0,80	0,10–0,20	0,70–0,90	0,10–0,20	1,30–1,60	0,20	1,30–1,60	0,20
K.2.2	120 (100–150)	0,50–0,60	0,10–0,20	0,50–0,70	0,10–0,20	1,00–1,30	0,20	1,00–1,30	0,20
K.3.1	200 (180–250)	0,60–0,80	0,10–0,20	0,70–0,90	0,10–0,20	1,30–1,60	0,20	1,30–1,60	0,20
K.3.2	120 (100–150)	0,50–0,60	0,10–0,20	0,50–0,70	0,10–0,20	1,00–1,30	0,20	1,00–1,30	0,20
N.1.1									
N.1.2									
N.2.1									
N.2.2									
N.2.3									
N.3.1	150 (130–250)	0,50–0,80	0,10–0,20	0,70–0,90	0,10–0,20	1,30–1,40	0,20	1,40–1,70	0,20
N.3.2	100 (80–150)	0,40–0,60	0,10–0,20	0,60–0,80	0,10–0,20	1,00–1,30	0,20	1,20–1,40	0,20
N.3.3									
N.4.1									
S.1.1									
S.1.2									
S.2.1	40 (30–60)	0,30–0,40	0,10–0,20	0,40–0,50	0,10–0,20	0,70–0,90	0,20	0,80–1,10	0,20
S.2.2	40 (30–60)	0,30–0,40	0,10–0,20	0,40–0,50	0,10–0,20	0,70–0,90	0,20	0,80–1,10	0,20
S.2.3									
S.3.1	30 (25–60)	0,30–0,40	0,10–0,20	0,40–0,50	0,10–0,20	0,70–0,90	0,20	0,80–1,10	0,20
S.3.2	30 (25–60)	0,30–0,40	0,10–0,20	0,40–0,50	0,10–0,20	0,70–0,90	0,20	0,80–1,10	0,20
S.3.3									
H.1.1	40 (35–60)	0,50–0,60	0,10–0,20	0,60–0,90	0,10–0,20	1,10–1,60	0,20	1,20–1,60	0,20
H.1.2	40 (35–60)	0,50–0,60	0,10–0,20	0,60–0,90	0,10–0,20	1,10–1,60	0,20	1,20–1,60	0,20
H.1.3	30 (25–50)	0,50–0,70	0,10–0,20	0,70–1,00	0,10–0,20	1,20–1,70	0,20	1,30–1,70	0,20
H.1.4									
H.2.1	40 (35–60)	0,50–0,60	0,10–0,20	0,60–0,90	0,10–0,20	1,10–1,60	0,20	1,20–1,60	0,20
H.3.1	40 (35–60)	0,50–0,60	0,10–0,20	0,60–0,90	0,10–0,20	1,10–1,60	0,20	1,20–1,60	0,20
O.1.1									
O.1.2									
O.2.1									
O.2.2									
O.3.1									

 The cutting data depend extremely on the external conditions, the material and machine type.
The indicated values are possible values which have to be increased or reduced, inside the bracket, according to the application conditions.

Cutting data standard values for Fullmax, long

Type VA		40 401 ... / 40 402 ... / 40 403 ... / 40 404 ...							
		Ø 2,97 – 4,05		Ø 4,06 – 6,05		Ø 6,06 – 7,55		Ø 7,56 – 12,05	
Number of flutes		4		4		6		6	
Index	v_c m/min	f mm/rev.	Reaming allowance Ø mm	f mm/rev.	Reaming allowance Ø mm	f mm/rev.	Reaming allowance Ø mm	f mm/rev.	Reaming allowance Ø mm
P.1.1									
P.1.2									
P.1.3									
P.1.4									
P.1.5									
P.2.1									
P.2.2									
P.2.3									
P.2.4									
P.3.1	20 (15–40)	0,32–0,50	0,10–0,20	0,32–0,50	0,10–0,20	0,48–0,60	0,20	0,48–0,60	0,20
P.3.2	20 (15–40)	0,32–0,50	0,10–0,20	0,32–0,50	0,10–0,20	0,48–0,60	0,20	0,48–0,60	0,20
P.3.3	20 (15–40)	0,32–0,50	0,10–0,20	0,32–0,50	0,10–0,20	0,48–0,60	0,20	0,48–0,60	0,20
P.4.1	20 (15–40)	0,32–0,50	0,10–0,20	0,32–0,50	0,10–0,20	0,48–0,60	0,20	0,48–0,60	0,20
P.4.2	20 (15–40)	0,32–0,50	0,10–0,20	0,32–0,50	0,10–0,20	0,48–0,60	0,20	0,48–0,60	0,20
M.1.1	20 (15–40)	0,32–0,50	0,10–0,20	0,32–0,50	0,10–0,20	0,48–0,60	0,20	0,48–0,60	0,20
M.2.1	15 (10–30)	0,32–0,50	0,10–0,20	0,32–0,50	0,10–0,20	0,48–0,60	0,20	0,48–0,60	0,20
M.3.1	15 (10–30)	0,32–0,50	0,10–0,20	0,32–0,50	0,10–0,20	0,48–0,60	0,20	0,48–0,60	0,20

Type ALU		40 471 ... / 40 472 ... / 40 473 ... / 40 474 ...							
		Ø 2,97 – 4,05		Ø 4,06 – 6,05		Ø 6,06 – 7,55		Ø 7,56 – 12,05	
Number of flutes		4		4		6		6	
Index	v_c m/min	f mm/rev.	Reaming allowance Ø mm	f mm/rev.	Reaming allowance Ø mm	f mm/rev.	Reaming allowance Ø mm	f mm/rev.	Reaming allowance Ø mm
N.1.1	200 (180–300)	0,50–0,60	0,10–0,20	0,60–0,90	0,10–0,20	1,10–1,60	0,20	1,20–1,60	0,20
N.1.2	200 (180–300)	0,50–0,60	0,10–0,20	0,60–0,90	0,10–0,20	1,10–1,60	0,20	1,20–1,60	0,20
N.2.1	200 (180–250)	0,50–0,70	0,10–0,20	0,70–1,00	0,10–0,20	1,20–1,70	0,20	1,30–1,70	0,20
N.2.2	200 (180–300)	0,50–0,70	0,10–0,20	0,70–1,00	0,10–0,20	1,20–1,70	0,20	1,30–1,70	0,20
N.2.3	200 (180–250)	0,50–0,70	0,10–0,20	0,70–1,00	0,10–0,20	1,20–1,70	0,20	1,30–1,70	0,20
N.3.1									
N.3.2									
N.3.3									
N.4.1									
O.3.1	250 (220–270)	0,50–0,70	0,10–0,20	0,70–1,00	0,10–0,20	1,20–1,70	0,20	1,30–1,70	0,20

 The cutting data depend extremely on the external conditions, the material and machine type.
The indicated values are possible values which have to be increased or reduced, inside the bracket, according to the application conditions.

Cutting data standard values for solid carbide reamers

Index	40 430 ...			40 430 ... / 40 431 ...									
	uncoated	to Ø 0.94 mm		uncoated	TiAlN	to Ø 5 mm		to Ø 8 mm		to Ø 10 mm		to Ø 12 mm	
	v_c m/min	f mm/rev.	Reaming allowance Ø mm	v_c m/min	v_c m/min	f mm/rev.	Reaming allowance Ø mm	f mm/rev.	Reaming allowance Ø mm	f mm/rev.	Reaming allowance Ø mm	f mm/rev.	Reaming allowance Ø mm
P.1.1	20	0,10	0,10	20	30	0,10	0,10	0,15	0,15	0,20	0,20	0,20	0,20
P.1.2	20	0,10	0,10	20	30	0,10	0,10	0,15	0,15	0,20	0,20	0,20	0,20
P.1.3	12	0,10	0,10	12	15	0,10	0,10	0,15	0,15	0,20	0,20	0,20	0,20
P.1.4	12	0,10	0,10	12	15	0,10	0,10	0,15	0,15	0,20	0,20	0,20	0,20
P.1.5	12	0,10	0,10	12	15	0,10	0,10	0,15	0,15	0,20	0,20	0,20	0,20
P.2.1	15	0,10	0,10	15	25	0,10	0,10	0,15	0,15	0,20	0,20	0,20	0,20
P.2.2	12	0,10	0,10	12	15	0,10	0,10	0,15	0,15	0,20	0,20	0,20	0,20
P.2.3	12	0,10	0,10	12	15	0,10	0,10	0,15	0,15	0,20	0,20	0,20	0,20
P.2.4	12	0,10	0,10	12	15	0,10	0,10	0,15	0,15	0,20	0,20	0,20	0,20
P.3.1	15	0,10	0,10	15	25	0,10	0,10	0,15	0,15	0,20	0,20	0,20	0,20
P.3.2	12	0,10	0,10	12	15	0,10	0,10	0,15	0,15	0,20	0,20	0,20	0,20
P.3.3	12	0,10	0,10	12	15	0,10	0,10	0,15	0,15	0,20	0,20	0,20	0,20
P.4.1													
P.4.2													
M.1.1					15	0,08	0,08	0,10	0,10	0,15	0,10	0,15	0,10
M.2.1					15	0,08	0,08	0,10	0,10	0,15	0,10	0,15	0,10
M.3.1					10	0,08	0,08	0,10	0,10	0,15	0,10	0,15	0,10
K.1.1	18	0,10	0,10	18	30	0,10	0,10	0,20	0,15	0,30	0,20	0,30	0,20
K.1.2	18	0,10	0,10	18	30	0,10	0,10	0,20	0,15	0,30	0,20	0,30	0,20
K.2.1	15	0,10	0,10	15	25	0,10	0,10	0,20	0,15	0,30	0,20	0,30	0,20
K.2.2	10	0,10	0,10	10	20	0,10	0,10	0,20	0,15	0,30	0,20	0,30	0,20
K.3.1	15	0,10	0,10	15	25	0,10	0,10	0,20	0,15	0,30	0,20	0,30	0,20
K.3.2	10	0,10	0,10	10	20	0,10	0,10	0,20	0,15	0,30	0,20	0,30	0,20
N.1.1	40	0,15	0,10	40		0,15	0,10	0,20	0,15	0,25	0,20	0,25	0,20
N.1.2	40	0,15	0,10	40		0,15	0,10	0,20	0,15	0,25	0,20	0,25	0,20
N.2.1	25	0,15	0,10	20		0,15	0,10	0,20	0,15	0,25	0,20	0,25	0,20
N.2.2	25	0,15	0,10	20		0,15	0,10	0,20	0,15	0,25	0,20	0,25	0,20
N.2.3													
N.3.1	30	0,15	0,10	30		0,15	0,10	0,20	0,15	0,25	0,20	0,25	0,20
N.3.2	30	0,15	0,10	30		0,15	0,10	0,20	0,15	0,25	0,20	0,25	0,20
N.3.3	30	0,15	0,10	30		0,15	0,10	0,20	0,15	0,25	0,20	0,25	0,20
N.4.1													
S.1.1					10	0,06	0,05	0,10	0,10	0,12	0,10	0,12	0,10
S.1.2					10	0,06	0,05	0,10	0,10	0,12	0,10	0,12	0,10
S.2.1					10	0,06	0,05	0,10	0,10	0,12	0,10	0,12	0,10
S.2.2					10	0,06	0,05	0,10	0,10	0,12	0,10	0,12	0,10
S.2.3					10	0,06	0,05	0,10	0,10	0,12	0,10	0,12	0,10
S.3.1					10	0,06	0,05	0,10	0,10	0,12	0,10	0,12	0,10
S.3.2					10	0,06	0,05	0,10	0,10	0,12	0,10	0,12	0,10
S.3.3					10	0,06	0,05	0,10	0,10	0,12	0,10	0,12	0,10
H.1.1					8	0,05	0,05	0,08	0,05	0,10	0,10	0,10	0,10
H.1.2					8	0,05	0,05	0,08	0,05	0,10	0,10	0,10	0,10
H.1.3													
H.1.4													
H.2.1					8	0,05	0,05	0,08	0,05	0,10	0,10	0,10	0,10
H.3.1													
O.1.1	40	0,15	0,10	40		0,15	0,10	0,20	0,15	0,25	0,20	0,25	0,20
O.1.2	40	0,15	0,10	40		0,15	0,10	0,20	0,15	0,25	0,20	0,25	0,20
O.2.1													
O.2.2													
O.3.1													

 The cutting data is strongly influenced by external conditions, such as the stability of the tool and workpiece clamping, material and type of machine. The specified values represent guideline cutting data that can be adjusted by approx. ±20% according to the usage conditions.

Cutting data for HSS-E reamers

Index	v _c m/min	40 115 ...						40 140 ... / 40 145 ... / 40 139 ...						
		to Ø 5 mm		to Ø 8 mm		to Ø 12 mm		to Ø 5 mm		to Ø 8 mm		to Ø 12 mm		
		f mm/rev.	Reaming allowance Ø mm	f mm/rev.	Reaming allowance Ø mm	f mm/rev.	Reaming allowance Ø mm	v _c m/min	f mm/rev.	Reaming allowance Ø mm	f mm/rev.	Reaming allowance Ø mm	f mm/rev.	Reaming allowance Ø mm
P.1.1	12	0,10	0,10	0,15	0,15	0,20	0,20	15	0,10	0,10-0,15	0,20	0,15-0,20	0,25	0,20
P.1.2	12	0,10	0,10	0,15	0,15	0,20	0,20	12	0,10	0,10-0,15	0,20	0,15-0,20	0,25	0,20
P.1.3	10	0,10	0,10	0,15	0,15	0,20	0,20	10	0,10	0,10-0,15	0,20	0,15-0,20	0,25	0,20
P.1.4	10	0,10	0,10	0,15	0,15	0,20	0,20	10	0,08	0,10-0,15	0,15	0,15-0,20	0,20	0,20
P.1.5	10	0,10	0,10	0,15	0,15	0,20	0,20	8	0,08	0,10-0,15	0,15	0,15-0,20	0,20	0,20
P.2.1	12	0,10	0,10	0,15	0,15	0,20	0,20	10	0,10	0,10-0,15	0,20	0,15-0,20	0,25	0,20
P.2.2	12	0,10	0,10	0,15	0,15	0,20	0,20	8	0,08	0,10-0,15	0,15	0,15-0,20	0,20	0,20
P.2.3	10	0,10	0,10	0,15	0,15	0,20	0,20	8	0,08	0,10-0,15	0,15	0,15-0,20	0,20	0,20
P.2.4	10	0,10	0,10	0,15	0,15	0,20	0,20	8	0,08	0,10-0,15	0,15	0,15-0,20	0,20	0,20
P.3.1	12	0,10	0,10	0,15	0,15	0,20	0,20	8	0,08	0,10-0,15	0,12	0,15-0,20	0,20	0,20
P.3.2	10	0,10	0,10	0,15	0,15	0,20	0,20	6	0,08	0,10-0,15	0,12	0,15-0,20	0,20	0,20
P.3.3	10	0,10	0,10	0,15	0,15	0,20	0,20	6	0,08	0,10-0,15	0,12	0,15-0,20	0,20	0,20
P.4.1								6	0,08	0,10-0,15	0,12	0,15-0,20	0,20	0,20
P.4.2								6	0,08	0,10-0,15	0,12	0,15-0,20	0,20	0,20
M.1.1								6	0,08	0,10	0,12	0,15	0,20	0,20
M.2.1								4	0,08	0,10	0,12	0,15	0,20	0,20
M.3.1								4	0,08	0,10	0,12	0,15	0,20	0,20
K.1.1	12	0,15	0,10	0,20	0,15	0,25	0,20	14	0,10	0,10-0,15	0,16	0,20	0,24	0,20
K.1.2	12	0,15	0,10	0,20	0,15	0,25	0,20	12	0,10	0,10-0,15	0,16	0,20	0,24	0,20
K.2.1	10	0,15	0,10	0,20	0,15	0,25	0,20	12	0,10	0,10-0,15	0,16	0,15-0,20	0,20	0,20
K.2.2	10	0,15	0,10	0,20	0,15	0,25	0,20	10	0,10	0,10-0,15	0,16	0,15-0,20	0,20	0,20
K.3.1	10	0,15	0,10	0,20	0,15	0,25	0,20	12	0,10	0,10-0,15	0,16	0,20	0,24	0,20
K.3.2	10	0,15	0,10	0,20	0,15	0,25	0,20	10	0,10	0,10-0,15	0,16	0,15-0,20	0,20	0,20
N.1.1	15	0,15	0,10	0,20	0,15	0,20	0,20	20	0,10	0,15	0,20	0,20	0,25	0,20
N.1.2	15	0,15	0,10	0,20	0,15	0,20	0,20	20	0,10	0,15	0,20	0,20	0,25	0,20
N.2.1								18	0,10	0,15	0,20	0,20	0,25	0,20
N.2.2								18	0,10	0,15	0,20	0,20	0,25	0,20
N.2.3														
N.3.1	20	0,15	0,10	0,20	0,15	0,20	0,20	18	0,10	0,15	0,18	0,30	0,20	0,30
N.3.2	20	0,15	0,10	0,20	0,15	0,20	0,20	15	0,10	0,15	0,18	0,30	0,20	0,30
N.3.3	20	0,15	0,10	0,20	0,15	0,20	0,20	15	0,10	0,15	0,18	0,30	0,20	0,30
N.4.1								18	0,10	0,15	0,18	0,30	0,20	0,30
S.1.1														
S.1.2														
S.2.1								4	0,08	0,10	0,12	0,15	0,16	0,20
S.2.2								4	0,08	0,10	0,12	0,15	0,16	0,20
S.2.3														
S.3.1								6	0,08	0,10	0,12	0,15	0,16	0,20
S.3.2								4	0,08	0,10	0,10	0,15	0,125	0,20
S.3.3														
H.1.1														
H.1.2														
H.1.3														
H.1.4														
H.2.1														
H.3.1														
O.1.1	25	0,15	0,10	0,20	0,15	0,20	0,20	15	0,15	0,15	0,20	0,20	0,25	0,20
O.1.2	25	0,15	0,10	0,20	0,15	0,20	0,20	12	0,12	0,15	0,16	0,20	0,20	0,20
O.2.1														
O.2.2														
O.3.1														



The cutting data is strongly influenced by external conditions, such as the stability of the tool and workpiece clamping, material and type of machine. The specified values represent guideline cutting data that can be adjusted by approx. ±20% according to the usage conditions.

Tolerance classes covered with 1/100 reamer

The most common tolerance is H7, so most reamers configured for an H7 fit tolerance.

With the 1/100 reamers, increments of 0.01 mm can be covered, but are also suitable for various other dimensions.

For example, a 1/100 reamer diameter 8.02 mm can be used for a 8.0 fit F7.

Other fit sizes shown in the table.

Tolerance zone	Nominal Ø in mm											
	1,0	2,0	3,0	4,0	5,0	6,0	7,0	8,0	9,0	10,0	11,0	12,0
A9				4,29	5,29	6,29	7,30	8,30	9,30	10,30	11,32	12,32
A11	1,31	2,31	3,31	4,32	5,32	6,32	7,35	8,35	9,35	10,35	11,37	12,37
B8				4,15	5,15	6,15	7,16	8,16	9,16	10,16		
B9				4,16	5,16	6,16	7,17	8,17	9,17	10,17	11,18	12,18
B10	1,17	2,17	3,17	4,17	5,17	6,17	7,19	8,19	9,19	10,19	11,20	12,20
B11	1,18	2,18	3,18	4,19	5,19	6,19	7,22	8,22	9,22	10,22	11,23	12,23
C8				4,08	5,08	6,08	7,09	8,09	9,09	10,09	11,11	12,11
C9	1,07	2,07	3,07	4,09	5,09	6,09	7,10	8,10	9,10	10,10	11,12	12,12
C10	1,09	2,09	3,09	4,10	5,10	6,10	7,12	8,12	9,12	10,12	11,14	12,14
C11	1,10	2,10	3,10	4,12	5,12	6,12	7,15	8,15	9,15	10,15	11,18	12,18
D7											11,06	12,06
D8				4,04	5,04	6,04	7,05	8,05	9,05	10,05	11,06	12,06
D9				4,05	5,05	6,05	7,06	8,06	9,06	10,06	11,08	12,08
D10	1,05	2,05	3,05	4,06	5,06	6,06	7,08	8,08	9,08	10,08	11,10	12,10
D11	1,06	2,06	3,06	4,08	5,08	6,08	7,10	8,10	9,10	10,10	11,13	12,13
E7							7,03	8,03	9,03	10,03	11,04	12,04
E8	1,02	2,02	3,02	4,03	5,03	6,03	7,04	8,04	9,04	10,04	11,05	12,05
E9	1,03	2,03	3,03	4,04	5,04	6,04	7,05	8,05	9,05	10,05	11,06	12,06
F7	1,01	2,01	3,01				7,02	8,02	9,02	10,02	11,02	12,02
F8	1,01	2,01	3,01	4,02	5,02	6,02	7,02	8,02	9,02	10,02	11,03	12,03
F9	1,02	2,02	3,02	4,03	5,03	6,03	7,03	8,03	9,03	10,03	11,04	12,04
F10				4,04	5,04	6,04	7,05	8,05	9,05	10,05	11,07	12,07
G7				4,01	5,01	6,01	7,01	8,01	9,01	10,01		
H7										10,01	11,01	12,01
H8				4,01	5,01	6,01	7,01	8,01	9,01	10,01	11,02	12,02
H9	1,01	2,01	3,01	4,02	5,02	6,02	7,02	8,02	9,02	10,02	11,03	12,03
H10	1,03	2,03	3,03	4,03	5,03	6,03	7,04	8,04	9,04	10,04	11,05	12,05
H11	1,04	2,04	3,04	4,05	5,05	6,05	7,06	8,06	9,06	10,06	11,08	12,08
H12	1,07	2,07	3,07	4,08	5,08	6,08	7,10	8,10	9,10	10,10	11,13	12,13
H13	1,11	2,11	3,11	4,14	5,14	6,14	7,18	8,18	9,18	10,18	11,22	12,22
J6				4,00	5,00	6,00	7,00	8,00	9,00	10,00	11,00	12,00
J7				4,00	5,00	6,00	7,00	8,00	9,00	10,00	11,00	12,00
J8	1,00	2,00	3,00	4,00	5,00	6,00	7,00	8,00	9,00	10,00	11,00	12,00
JS7				4,00	5,00	6,00	7,00	8,00	9,00	10,00	11,00	12,00
JS8	1,00	2,00	3,00	4,00	5,00	6,00	7,00	8,00	9,00	10,00	11,00	12,00
JS9	1,00	2,00	3,00	4,00	5,00	6,00	7,00	8,00	9,00	10,00	11,01	12,01
K8	0,99	1,99	2,99				6,99	7,99	8,99	9,99	10,99	11,99
M6							6,99	7,99	8,99	9,99	10,99	11,99
M7							6,99	7,99	8,99	9,99	10,99	11,99
M8	0,99	1,99	2,99	3,99	4,99	5,99	6,99	7,99	8,99	9,99	10,99	11,99
N6				3,99	4,99	5,99						
N7	0,99	1,99	2,99	3,99	4,99	5,99	6,99	7,99	8,99	9,99	10,99	11,99
N8	0,99	1,99	2,99	3,99	4,99	5,99	6,99	7,99	8,99	9,99	10,98	11,98
N9	0,98	1,98	2,98	3,99	4,99	5,99	6,99	7,99	8,99	9,99	10,98	11,98
N10	0,98	1,98	2,98	3,98	4,94	5,98	6,98	7,98	8,98	9,98	10,98	11,98
N11	0,98	1,98	2,98	3,98	4,94	5,98	6,98	7,98	8,98	9,98	10,97	11,97
P6	0,99	1,99	2,99								10,98	11,98
P7	0,99	1,99	2,99				6,98	7,98	8,98	9,98	10,98	11,98
P8	0,99	1,99	2,99	3,98	4,98	5,98					10,97	11,97
R6							6,98	7,98	8,98	9,98		
R7				3,98	4,98	5,98	6,98	7,98	8,98	9,98	10,97	11,97
S6				3,98	4,98	5,98					10,97	11,97
S7	0,98	1,98	2,98	3,98	4,98	5,98	6,97	7,97	8,97	9,97	10,97	11,97
U6							6,97	7,97	8,97	9,97		
U7				3,97	4,97	5,97	6,97	7,97	8,97	9,97		
X7				3,97	4,97	5,97						
X8	0,97	1,97	2,97				6,96	7,96	8,96	9,96	10,95	11,95
X9	0,97	1,97	2,97	3,96	4,96	5,96	6,95	7,95	8,95	9,95		
Z7	0,97	1,97	2,97	3,96	4,96	5,96	6,96	7,96	8,96	9,96	10,95	11,95
Z8	0,97	1,97	2,97	3,96	4,96	5,96	6,95	7,95	8,95	9,95	10,94	11,94
Z9				3,95	4,95	5,95						
Z10	0,96	1,96	2,96	3,95	4,95	5,95	6,94	7,94	8,94	9,94	10,93	11,93
ZA7	0,96	1,96	2,96	3,95	4,95	5,95	6,94	7,94	8,94	9,94		
ZA8							6,94	7,94	8,94	9,94	10,93	11,93
ZB8	0,95	1,95	2,95	3,94	4,94	5,94					10,90	11,90
ZB9	0,95	1,95	2,95	3,94	4,94	5,94	6,92	7,92	8,92	9,92	10,90	11,90

Coatings

HSS drilling

TiN

- ▲ TiN coating
- ▲ Maximum application temperature: 450 °C

Solid carbide drilling

DPX74S

- ▲ Special TiAlN nanolayer coating
- ▲ Maximum application temperature: 1000 °C

DRAGONSKIN

DPX74M

- ▲ Universal AlCrN-based monolayer coating developed for micro tools
- ▲ High oxidation, heat and wear resistance
- ▲ Maximum application temperature 1100 °C

DRAGONSKIN

DPA54

- ▲ Special multilayer coating
- ▲ High hardness and heat resistance
- ▲ Maximum application temperature: 800 °C

DRAGONSKIN

Ti800

- ▲ AlTiN nanolayer coating
- ▲ Maximum application temperature: 1100 °C

TiAlN

- ▲ TiAlN multilayer coating
- ▲ Maximum application temperature: 900 °C

DLC

- ▲ Diamond-like carbon coating
- ▲ Specially for machining non-ferrous metals
- ▲ Maximum application temperature: 400 °C

DRAGONSKIN

Reamers

DST

- ▲ Cermet, uncoated
- ▲ ISO | **P15** | **M10** | K10
- ▲ The uncoated cermet grade for finish machining stainless and hardened steel
- ▲ Particularly wear resistant thanks to high heat resistance

DBF-A

- ▲ AlCrN Multilayer coating
- ▲ specially developed for the machining of tempered materials < 62 HRC
- ▲ maximum application temperature: > 1100 °C

DBC

- ▲ Diamond-like carbon coating
- ▲ Specially for machining non-ferrous metals
- ▲ Maximum application temperature: 400 °C

DBG-U

- ▲ AlTiN Multilayer coating
- ▲ Especially for universal use in a variety of materials as well as for the machining of tempered materials < 62 HRC
- ▲ For high cutting speeds and suitable for MMS application
- ▲ Maximum application temperature: 1000 °C

TiAlN

- ▲ TiAlN multilayer coating
- ▲ Maximum application temperature: 900 °C

DBG-P

- ▲ AlTiN Multilayer coating
- ▲ Especially for universal use in a variety of materials at high cutting speeds
- ▲ Suitable for MMS application
- ▲ Maximum application temperature: 1000 °C

DBC-N

- ▲ Diamond-like ta-C-Multilayer-carbon coating
- ▲ Particularly hard and smooth coating and therefore especially for machining non-ferrous metals
- ▲ Maximum application temperature: 500 °C

DBQ

- ▲ AlCrN-Multilayer-Beschichtung
- ▲ Particularly suitable for machining stainless steels and titanium
- ▲ Low formation of built-up edges
- ▲ Maximum application temperature: > 1000 °C

TiN

- ▲ TiN multilayer coating
- ▲ Maximum application temperature: 400 °C





Solid drilling and bore machining	HSS drilling	1
	Solid carbide drilling	
	Reamers	
Threading	HSS taps	2
	Circular and Thread Milling	
	Thread turning	
Turning	Turning Tools	3
	Multi-function tool – EcoCut	
	Grooving Tools	
	Miniature turning tools	
Milling	Solid Carbide milling cutters	4
Workholding	Collets and reduction sleeves	5
	Material examples and article no. index	6

Table of contents

Toolfinder	2+3
Overview	2+3
Thread categories and thread types	4
Symbol explanation	5
List of contents	
Tapping	6+7
Thread milling	23
Circular Milling	29
Thread turning	42
Product programme	
Tapping	8-18
Thread milling	24-28
Circular Milling	30-36
Thread turning	43-70
Cutting Data	
Circular and Thread Milling	37-39
Thread turning	71+72
Technical Information	
Tapping	19-22
Circular and Thread Milling	40+41
Thread turning	73-76
General	77+78

WNT \ Performance

Premium quality tools for high performance.

The premium quality tools from the **WNT Performance** product line have been designed for specific applications and are distinguished by their outstanding performance. If you make high demands on the performance of your production and want to achieve the very best results, we recommend the Premium tools in this product line.

WNT \ Standard

Quality tools for standard applications.

The quality tools of the **WNT Standard** product line are high quality, powerful and reliable and enjoy the highest trust of our customers worldwide. Tools from this product line are the first choice for many standard applications and guarantee optimal results.

Toolfinder

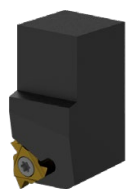

External thread turning
43-63



Internal thread turning
64-69



Thread milling
24-28

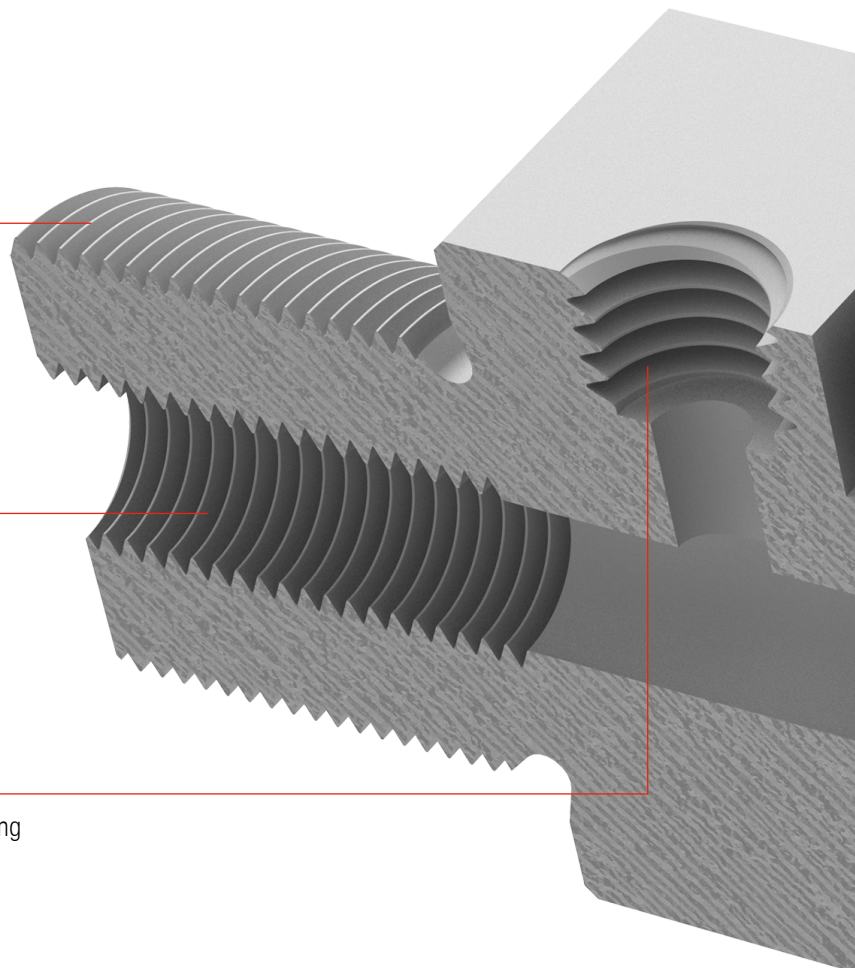

Overview



Tapping

- ▲ For through holes and blind holes
- ▲ All common thread types
- ▲ Universal application
- ▲ Static application
- ▲ Rotating application

8-18



Thread milling

- ▲ Excellent surface qualities
- ▲ For through holes and blind holes
- ▲ Universal application
- ▲ Various diameters with the same pitch

24-28



Circular Milling

- ▲ Circular milling
- ▲ Slot milling
- ▲ Multipurpose milling
- ▲ Universal application

30-36



Thread turning

- ▲ Size 06 insert
- ▲ Size 08 insert
- ▲ Size 11 insert
- ▲ Size 16 insert
- ▲ Internal and external thread
- ▲ Shank cross-section = 8 - 25 mm
- ▲ Universal application

43-70



Circular and slot milling
30-36



Tapping
8-18

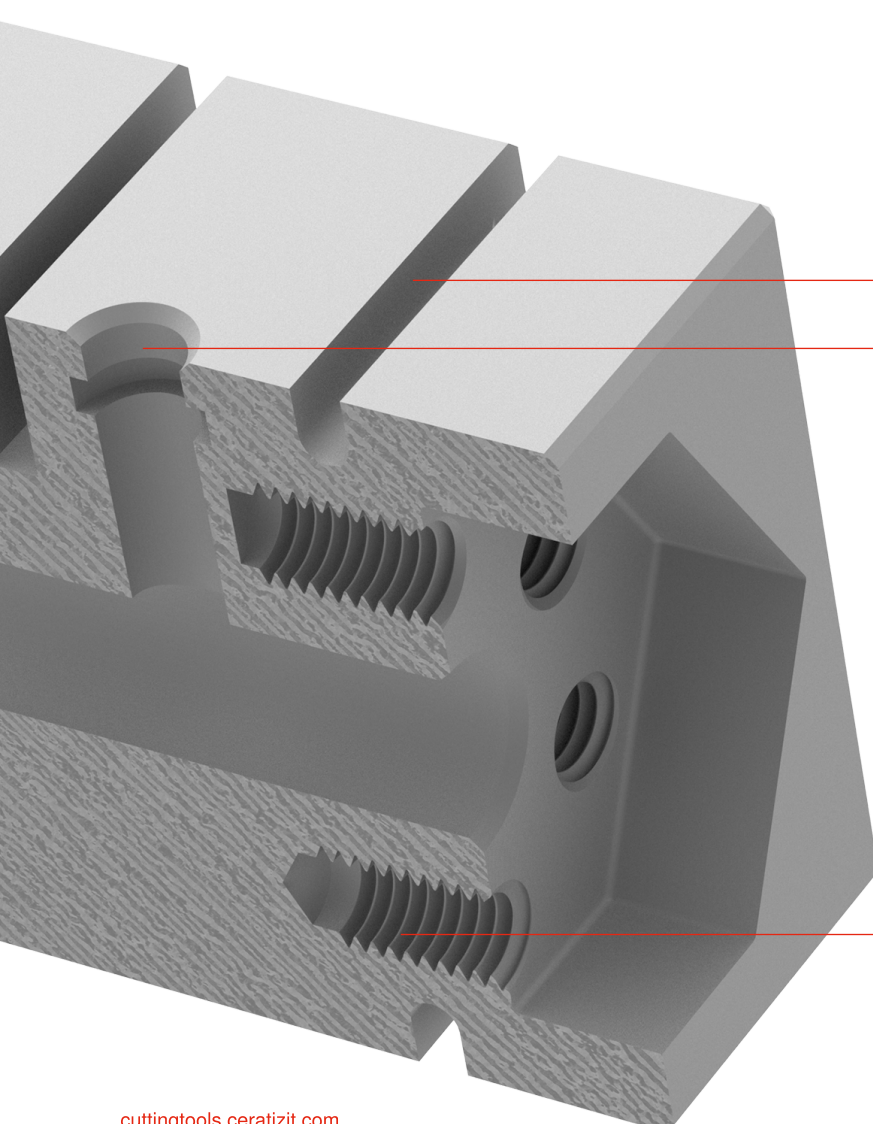

Thread types

M	ISO metric coarse thread DIN 13	UNC	Unified coarse thread ASME – B1.1	BSW	Whitworth thread BS84
MF	ISO Metric fine thread DIN 13	UNF	Unified fine thread ASME – B1.1	BSF	Whitworth fine thread
MJ	Metric thread for the aviation industry	UNJC	Unified Coarse Thread ASME – B1.15 and ISO 3161	UN	Unified thread
G	Whitworth pipe thread DIN-EN-ISO 228	UNJF	Unified fine thread ASME – B1.15 and ISO 3161	UNEF	American Unified Thread (Extra Fine)

Tap types

Tool type

Stabil	for through holes to 4xD
Salo-Rex	for blind holes up to 3xD, high helix angle for secure chip evacuation
SL	for blind holes up to 2xD, 15°, 25° or 30° helix angle

Application range

UNI	for universal application
------------	---------------------------

Circular and thread milling cutter types

Tool type

Micro Mill	Solid Carbide Circular End Milling Cutter	SGF	Thread milling cutter
Mini Mill	Circular milling cutter with solid carbide insert		

Profile Type Description

Full profile



- ▲ Core diameter does not have to be machined to the finished core diameter
- ▲ A minimum infeed of 0.07 mm is required
- ▲ Insert can only be used for one pitch

Partial profile



- ▲ Core diameter must be premachined to the final dimension
- ▲ A minimum infeed of 0.07 mm is required
- ▲ One threading insert can be used to machine several pitches
- ▲ The threading insert can therefore be used for any application

Mini Thread Turning Insert



- ▲ From a min. core hole diameter of $\varnothing 6$ mm or $\varnothing 8$ mm



Explanation of symbols – Taps

Chamfer form



Form B (with spiral point,
4 - 5 threads per chamfer)



Form C (without spiral point,
2 - 3 threads per chamfer)



Form D (without spiral point,
4 - 5 threads per chamfer)



Form E (without spiral point,
1.5 - 2 threads per chamfer)

Helix angle



Example: helix angle 42°

Tensile strength



Example up to 1100 N/mm²

Tolerances



Explanation of the tolerances can be found on
→ **Page 21**



Coloured rings

WNT \ Performance

An explanation of the coloured rings can be found on → **Page 20**

Thread types



Explanation of the thread types can be found on → **Page 4**

Tool Material



High-performance high speed steel

Hole type



Through hole



Blind hole

Explanation of symbols – Circular and thread milling cutters

Version



central internal coolant



lateral internal coolant



Solid carbide

Thread / Flank angle



Explanation of the thread types can be found on → **Page 4**



Flank angle 60°

Shank



Explanation of symbols – Thread turning

Flank angle



Flank angle 55°



Flank angle 60°

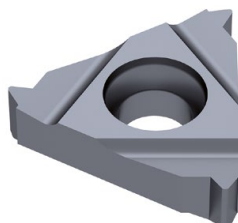

Applications



Full radius slot milling



Slot milling



Multipurpose milling



Chamfering and Deburring



Gear milling



IR = internal right, IL = internal left

Thread types



Explanation of the thread types can be found on → **Page 4**

- = **Main Application**
- = **Extended application**

Highlights

Through hole – machine taps right-hand, type Stabil HR



- ▲ Specialist for thread production in high-strength steels
- ▲ New optimised hard material/carbon coating delivers the very best results
- ▲ 4xD

Blind hole – machine taps right-hand, type SL HR



- ▲ Specialist for thread production in high-strength steels
- ▲ New optimised hard material/carbon coating delivers the very best results
- ▲ 2xD

Taps Overview

	Thread type	Application	Tolerance zone	Dimension	Material	Shank	Coating	Page No.
	M		ISO 2	Ø DC	Steel P Stainless steel M Cast iron K Non-ferrous metals N Heat-resistant Co Tempered steel H Non metal materials O			
	M		ISO 2 6H	M1 - M12	●●●●●●●●	DIN 371 with reinforced shank	nit. + vap.	8
	M		ISO 2 6H	M2 - M10	●●●●●●●●	DIN 371 with reinforced shank	TiN	8
	M		ISO 2X 6HX	M2 - M10	●●●●●●●●	DIN 371 with reinforced shank	AlTiN-HD	8
	M		ISO 2 6H	M2 - M12	●●●●●●●●	DIN 371 with reinforced shank	vap.	9
	M		ISO 2 6H	M2 - M12	●●●●●●●●	DIN 371 with reinforced shank	TiN	9
	M		ISO 2 6H	M3 - M12	●●●●●●●●	DIN 371 with reinforced shank	AlTiN-HD	10
	MF		ISO 2 6H	M4x0,5 - M10x1	●●●●●●●●	DIN 371 with reinforced shank	nit. + vap.	11
	MF		ISO 2 6H	M4x0,5 - M10x1	●●●●●●●●	DIN 371 with reinforced shank	TiN	11
	MF		ISO 2 6H	M4x0,5 - M6x0,5	●●●●●●●●	DIN 371 with reinforced shank	vap.	12
	MF		ISO 2 6H	M6x0,75 - M12x1,5	●●●●●●●●	DIN 374 with reduced shank	vap.	12

Taps Overview

	Thread type	Application	Tolerance zone	Dimension Ø DC	Material compatibility	Shank	Coating	Page No.
					P Steel M Stainless steel K Cast iron N Non-ferrous metals S Heat-resistant H Tempered steel O Non metal materials			
	G		ISO 228	1/8-28 - 1/2-14	● ● ● ● ● ● ● ● ● ●	DIN 5156 with reduced shank	TiN	13
	G		ISO 228	1/8-28 - 1/2-14	● ● ● ● ● ● ● ● ● ●	DIN 5156 with reduced shank	vap.	14
	G		ISO 228	1/8-28 - 1/2-14	● ● ● ● ● ● ● ● ● ●	DIN 5156 with reduced shank	vap.	14
	UNC		2B	Nr. 2-56 - 3/8-16	● ● ● ● ● ● ● ● ● ●	DIN 371 with reinforced shank	nit. + vap.	15
	UNC		2B	Nr. 2-56 - 3/8-16	● ● ● ● ● ● ● ● ● ●	DIN 371 with reinforced shank	vap.	16
	UNF		2B	Nr. 4-48 - 5/16-24	● ● ● ● ● ● ● ● ● ●	DIN 371 with reinforced shank	nit. + vap.	17
	UNF		2B	Nr. 4-48 - 5/16-24	● ● ● ● ● ● ● ● ● ●	DIN 371 with reinforced shank	vap.	18
	UNJF		3BX	Nr. 4-48 - 3/8-24	● ● ● ● ● ● ● ● ● ●	DIN 371 with reinforced shank	TiCN	
	UNJF		3BX	Nr. 4-48 - 3/8-24	● ● ● ● ● ● ● ● ● ●	DIN 371 with reinforced shank	TiCN	
	BSW		med.	1/8-40 - 3/8-16	● ● ● ● ● ● ● ● ● ●	DIN 371 with reinforced shank	nit. + vap.	
	BSW		med.	1/8-40 - 3/8-16	● ● ● ● ● ● ● ● ● ●	DIN 371 with reinforced shank	vap.	

Further dimensions and taps can be found in our → **main catalogue in Chapter 6 Taps**

The cutting data is highly dependent on external conditions, such as stability of the tool and workpiece clamping, material and machine type!
The values indicated represent possible cutting data which may need to be corrected depending on operating conditions !

This article can be found in our online shop at cuttingtools.ceratzit.com

Through hole – Machine taps, right hand

M **Stabil**

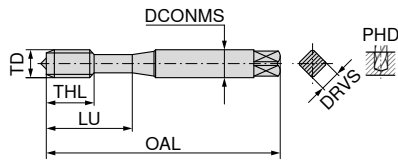

DIN 371 with reinforced shank

UNI	UNI	NEW HR
B 4-5	B 4-5	B 4-5
ISO 2 6H	ISO 2 6H	ISO 2X 6HX
nitr. + vap.	TiN	AlTiN- HD

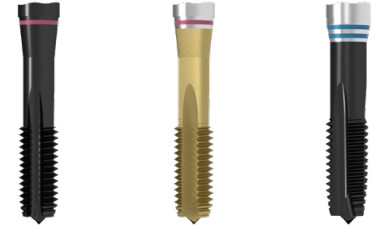

HSS-E ∠0° ≤ 1100 N/mm ² ≤ 4xD	HSS-E ∠0° ≤ 1100 N/mm ² ≤ 4xD	HSS-PM ∠0° ≤ 1400 N/mm ² ≤ 4xD
---	---	--

TD	TP	OAL	DCONMS	DRVS	PHD	THL	LU	Flutes
mm	mm	mm	mm	mm	mm	mm	mm	
M1	0.25	40	2.5	2.1	0.75	5	5	2
M1,2	0.25	40	2.5	2.1	0.95	5	5	2
M1,4	0.30	40	2.5	2.1	1.10	7	7	3
M1,6	0.35	40	2.5	2.1	1.25	8	11	3
M1,7	0.35	40	2.5	2.1	1.35	6	11	2
M1,8	0.35	40	2.5	2.1	1.45	6	11	2
M2	0.40	45	2.8	2.1	1.60	7	12	2
M2	0.40	45	2.8	2.1	1.60	7	12	3
M2,2	0.45	45	2.8	2.1	1.75	7	12	2
M2,5	0.45	50	2.8	2.1	2.05	9	14	2
M3	0.50	56	3.5	2.7	2.50	11	18	2
M3	0.50	56	3.5	2.7	2.50	11	18	3
M3,5	0.60	56	4.0	3.0	2.90	12	20	3
M4	0.70	63	4.5	3.4	3.30	13	21	2
M4	0.70	63	4.5	3.4	3.30	13	21	3
M5	0.80	70	6.0	4.9	4.20	15	25	2
M5	0.80	70	6.0	4.9	4.20	15	25	3
M6	1.00	80	6.0	4.9	5.00	17	30	3
M7	1.00	80	7.0	5.5	6.00	17	30	3
M8	1.25	90	8.0	6.2	6.80	20	35	3
M10	1.50	100	10.0	8.0	8.50	22	39	3
M12	1.75	110	12.0	9.0	10.20	24	44	3

22 501 ...	22 503 ...	22 468 ...	
010 ¹⁾			
012 ¹⁾			
014 ¹⁾			
016			
017			
018			
020	020	02000	
022			
025		02500	
		03000	
030	030		
035			
040	040	04000	
		05000	
050	050		
060	060	06000	
070			
080	080	08000	
100	100	10000	
120			
P	12	15	8
M	7	9	8
K	12	18	
N		12	10
S			4
H			
O			

1) Tol. ISO 1 4H ≤ M1.4

Blind hole - Machine taps, right hand

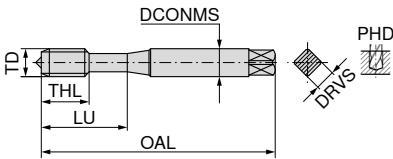
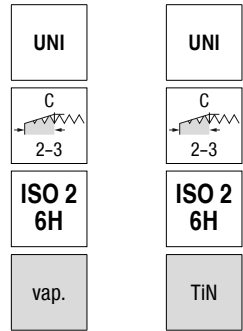

DIN 371 with reinforced shank



TD	TP	OAL	DCONMS	DRVS	PHD	THL	LU	Flutes
mm	mm	mm	mm	mm	mm	mm	mm	
M2	0.40	45	2.8	2.1	1.60	4.0	12	2
M2,2	0.45	45	2.8	2.1	1.75	4.5	12	2
M2,3	0.40	45	2.8	2.1	1.90	4.5	12	2
M2,5	0.45	50	2.8	2.1	2.05	5.0	15	2
M2,6	0.45	50	2.8	2.1	2.15	5.0	15	2
M3	0.50	56	3.5	2.7	2.50	6.0	18	3
M3,5	0.60	56	4.0	3.0	2.90	7.0	20	3
M4	0.70	63	4.5	3.4	3.30	7.0	21	3
M5	0.80	70	6.0	4.9	4.20	8.0	25	3
M6	1.00	80	6.0	4.9	5.00	10.0	30	3
M7	1.00	80	7.0	5.5	6.00	10.0	30	3
M8	1.25	90	8.0	6.2	6.80	14.0	35	3
M10	1.50	100	10.0	8.0	8.50	16.0	39	3
M12	1.75	110	12.0	9.0	10.20	18.0	44	3

22 518 ...	22 520 ...
020	020
022	
023	
025	
026	
030	030
035	
040	040
050	050
060	060
070	
080	080
100	100
120	120

P	12	15
M	7	9
K	12	18
N		12
S		
H		
O		



Blind hole – Machine taps, right hand

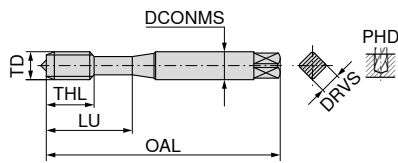
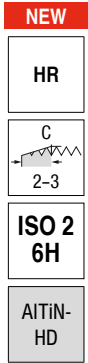

DIN 371 with reinforced shank



HSS-PM
 $\leq 25^\circ$
 $\leq 1400 \text{ N/mm}^2$
 $\leq 2xD$

22 469 ...

TD	TP	OAL	DCONMS	DRVS	PHD	THL	LU	Flutes	
mm	mm	mm	mm	mm	mm	mm	mm		
M3	0.50	56	3.5	2.7	2.5	11	18	3	03000
M4	0.70	63	4.5	3.4	3.3	13	21	3	04000
M5	0.80	70	6.0	4.9	4.2	15	25	3	05000
M6	1.00	80	6.0	4.9	5.0	17	30	3	06000
M8	1.25	90	8.0	6.2	6.8	20	35	3	08000
M10	1.50	100	10.0	8.0	8.5	22	39	3	10000
M12	1.75	110	12.0	9.0	10.2	24	44	3	12000
P									8
M									8
K									
N									10
S									4
H									
O									

Through hole – Machine taps, right hand

MF **Stabil**

UNI	UNI
ISO 2 6H	ISO 2 6H
nit. + vap.	TiN

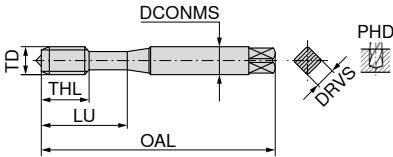

DIN 371 with reinforced shank

HSS-E	HSS-E
$\leq 1100 \text{ N/mm}^2$ $\leq 4xD$	$\leq 1100 \text{ N/mm}^2$ $\leq 4xD$

TD mm	TP mm	OAL mm	DCONMS mm	DRVS mm	PHD mm	THL mm	LU mm	Flutes
M4x0,5	0.50	63	4.5	3.4	3.5	10	21	3
M6x0,75	0.75	80	6.0	4.9	5.2	13	30	3
M5x0,5	0.50	70	6.0	4.9	4.5	11	25	3
M6x0,5	0.50	80	6.0	4.9	5.5	13	30	3
M8x1	1.00	90	8.0	6.2	7.0	17	35	3
M10x1	1.00	90	10.0	8.0	9.0	18	35	4

22 590 ...	22 550 ...
040	040
062	062
050	050
060	060
084	080
102	100

P	12	15
M	7	9
K	12	18
N		12
S		
H		
O		

2

Blind hole – Machine taps, right hand

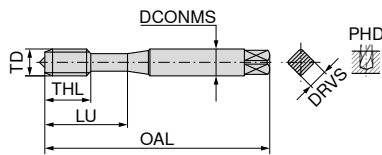
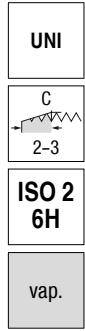

DIN 371 with reinforced shank



HSS-E
 $\angle 42^\circ$
 $\leq 1100 \text{ N/mm}^2$
 $\leq 3xD$

22 202 ...

TD mm	TP mm	OAL mm	DCONMS mm	DRVS mm	PHD mm	THL mm	LU mm	Flutes	
M4x0,5	0.50	63	4.5	3.4	3.5	5	21	3	040
M5x0,5	0.50	70	6.0	4.9	4.5	5	25	3	050
M6x0,75	0.75	80	6.0	4.9	5.2	8	30	3	062
M6x0,5	0.50	80	6.0	4.9	5.5	5	30	3	060

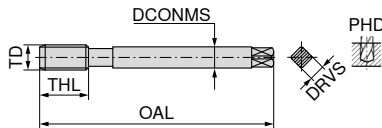

DIN 374 with reduced shank

22 553 ...

TD mm	TP mm	OAL mm	DCONMS mm	DRVS mm	PHD mm	THL mm	Flutes	
M6x0,75	0.75	80	4.5	3.4	5.2	8	3	062
M8x0,75	0.75	80	6.0	4.9	7.2	8	3	080
M8x1	1.00	90	6.0	4.9	7.0	10	3	082
M10x0,75	0.75	90	7.0	5.5	9.2	10	4	101
M10x1	1.00	90	7.0	5.5	9.0	10	3	100
M10x1,25	1.25	100	7.0	5.5	8.8	16	3	102
M12x1	1.00	100	9.0	7.0	11.0	11	4	120
M12x1,25	1.25	100	9.0	7.0	10.8	15	4	122
M12x1,5	1.50	100	9.0	7.0	10.5	15	4	124

P	12
M	7
K	12
N	
S	
H	
O	

Through hole - Machine taps, right hand

G **Stabil**

UNI



ISO 228

TiN

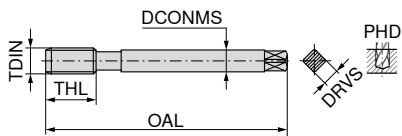

DIN 5156 with reduced shank



HSS-E
 $\leq 0^\circ$
 $\leq 1100 \text{ N/mm}^2$
 $\leq 4xD$

22 630 ...

TDIN	TP mm	OAL mm	DCONMS mm	DRVS mm	PHD mm	THL mm	Flutes	
1/8-28	0.907	90	7	5.5	8.80	18	3	012
1/4-19	1.337	100	11	9.0	11.80	22	3	025
3/8-19	1.337	100	12	9.0	15.25	22	3	037
1/2-14	1.814	125	16	12.0	19.00	25	4	050
P								15
M								9
K								18
N								12
S								
H								
O								

2

Blind hole - Machine taps, right hand

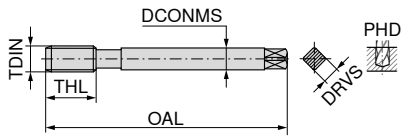
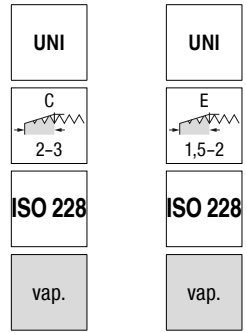

DIN 5156 with reduced shank



HSS-E $\leq 1100 \text{ N/mm}^2$ $\leq 3xD$ $\angle 42^\circ$
 HSS-E $\leq 1100 \text{ N/mm}^2$ $\leq 3xD$ $\angle 42^\circ$

TDIN	TP mm	OAL mm	DCONMS mm	DRVS mm	PHD mm	THL mm	Flutes
1/8-28	0.907	90	7	5.5	8.80	10	3
1/8-28	0.907	90	7	5.5	8.80	10	4
1/4-19	1.337	100	11	9.0	11.80	15	4
1/4-19	1.337	100	11	9.0	11.80	15	5
3/8-19	1.337	100	12	9.0	15.25	15	4
3/8-19	1.337	100	12	9.0	15.25	15	5
1/2-14	1.814	125	16	12.0	19.00	17	4
1/2-14	1.814	125	16	12.0	19.00	17	5

22 633 ...	22 635 ...
012	012
025	025
037	037
050	050

P	12	12
M	7	7
K	12	12
N		
S		
H		
O		

Through hole – Machine taps, right hand

UNC Stabil

UNI
B
4-5
2B
nitr. + vap.

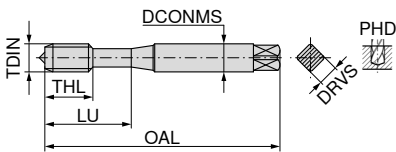

DIN 371 with reinforced shank



HSS-E
0°
≤ 1100 N/mm²
≤ 4xD

22 572 ...

TDIN	TP	OAL	DCONMS	DRVS	PHD	THL	LU	Flutes
	mm	mm	mm	mm	mm	mm	mm	
Nr. 2-56	0.454	45	2.8	2.1	1.85	7	12	2
Nr. 4-40	0.635	56	3.5	2.7	2.35	11	18	2
Nr. 6-32	0.794	56	4.0	3.0	2.85	12	20	3
Nr. 8-32	0.794	63	4.5	3.4	3.50	13	21	3
Nr. 10-24	1.058	70	6.0	4.9	3.90	15	25	3
Nr. 12-24	1.058	80	6.0	4.9	4.50	16	30	3
1/4-20	1.270	80	7.0	5.5	5.10	17	30	3
5/16-18	1.411	90	8.0	6.2	6.60	20	35	3
3/8-16	1.588	100	10.0	8.0	8.00	22	39	3

P	12
M	7
K	12
N	
S	
H	
O	

Blind hole – Machine taps, right hand

UNC Salo-Rex

UNI
C
2-3
2B
vap.

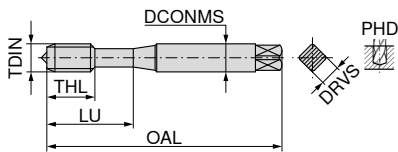

DIN 371 with reinforced shank



HSS-E
∠ 42°
≤ 1100 N/mm²
≤ 3xD

22 582 ...

TDIN	TP mm	OAL mm	DCONMS mm	DRVS mm	PHD mm	THL mm	LU mm	Flutes	
Nr. 2-56	0.454	45	2.8	2.1	1.85	4.5	12	2	002
Nr. 4-40	0.635	56	3.5	2.7	2.35	6.0	18	2	004
Nr. 6-32	0.794	56	4.0	3.0	2.85	7.0	20	3	006
Nr. 8-32	0.794	63	4.5	3.4	3.50	8.0	21	3	008
Nr. 10-24	1.058	70	6.0	4.9	3.90	10.0	25	3	010
1/4-20	1.270	80	7.0	5.5	5.10	13.0	30	3	025
5/16-18	1.411	90	8.0	6.2	6.60	14.0	35	3	031
3/8-16	1.588	100	10.0	8.0	8.00	16.0	39	3	037
P									12
M									7
K									12
N									
S									
H									
O									

Through hole - Machine taps, right hand

UNF Stabil

UNI



2B

nit. + vap.

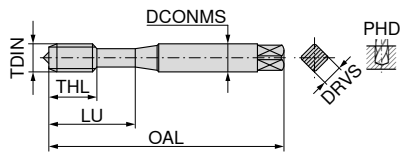

DIN 371 with reinforced shank



HSS-E
 $\angle 0^\circ$
 $\leq 1100 \text{ N/mm}^2$
 $\leq 4xD$

22 602 ...

TDIN	TP mm	OAL mm	DCONMS mm	DRVS mm	PHD mm	THL mm	LU mm	Flutes	
Nr. 4-48	0.529	56	3.5	2.7	2.40	11	18	2	004
Nr. 6-40	0.635	56	4.0	3.0	2.95	12	20	3	006
Nr. 8-36	0.706	63	4.5	3.4	3.50	13	21	3	008
Nr. 10-32	0.794	70	6.0	4.9	4.10	15	25	3	010
1/4-28	0.907	80	7.0	5.5	5.50	17	30	3	025
5/16-24	1.058	90	8.0	6.2	6.90	17	35	3	031
P									12
M									7
K									12
N									
S									
H									
O									

2

Blind hole – Machine taps, right hand

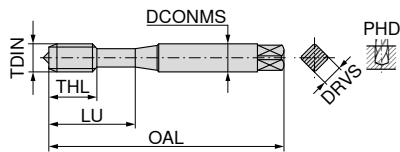
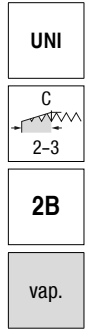

DIN 371 with reinforced shank



HSS-E
 $\sphericalangle 42^\circ$
 $\leq 1100 \text{ N/mm}^2$
 $\leq 3xD$

22 606 ...

TDIN	TP mm	OAL mm	DCONMS mm	DRVS mm	PHD mm	THL mm	LU mm	Flutes	
Nr. 4-48	0.529	56	3.5	2.7	2.40	6	18	2	004
Nr. 6-40	0.635	56	4.0	3.0	2.95	7	20	3	006
Nr. 8-36	0.706	63	4.5	3.4	3.50	8	21	3	008
Nr. 10-32	0.794	70	6.0	4.9	4.10	10	25	3	010
1/4-28	0.907	80	7.0	5.5	5.50	10	30	3	025
5/16-24	1.058	90	8.0	6.2	6.90	10	35	3	031
P									12
M									7
K									12
N									
S									
H									
O									

Tapped hole pilot diameter

M ISO metric coarse threads 6H to DIN 13 and DIN ISO 965-1 (M1-M1,4 = 5H)

Thread nominal Ø		Ø D ₁		Core hole	Thread nominal Ø		Ø D ₁		Core hole
D	P	min.	max.		D	P	min.	max.	
M1	0,25	0,729	0,785	0,75	M12	1,75	10,106	10,441	10,2
M1,1	0,25	0,829	0,885	0,85	M14	2,0	11,835	12,210	12
M1,2	0,25	0,929	0,985	0,95	M16	2,0	13,835	14,210	14
M1,4	0,3	1,075	1,142	1,1	M18	2,5	15,294	15,744	15,5
M1,6	0,35	1,221	1,321	1,25	M20	2,5	17,294	17,744	17,5
M1,8	0,35	1,421	1,521	1,45	M22	2,5	19,294	19,744	19,5
M2	0,4	1,567	1,679	1,6	M24	3,0	20,752	21,252	21
M2,2	0,45	1,713	1,838	1,75	M27	3,0	23,752	24,252	24
M2,5	0,45	2,013	2,138	2,05	M30	3,5	26,211	26,771	26,5
M3	0,5	2,459	2,599	2,5	M33	3,5	29,211	29,771	29,5
M3,5	0,6	2,850	3,010	2,9	M36	4,0	31,670	32,270	32
M4	0,7	3,242	3,422	3,3	M39	4,0	34,670	35,270	35
M4,5	0,75	3,688	3,878	3,7	M42	4,5	37,129	37,799	37,5
M5	0,8	4,134	4,334	4,2	M45	4,5	40,129	40,799	40,5
M6	1,0	4,917	5,153	5	M48	5,0	42,587	43,297	43
M7	1,0	5,917	6,153	6	M52	5,0	46,587	47,297	47
M8	1,25	6,647	6,912	6,8	M56	5,5	50,046	50,796	50,5
M9	1,25	7,647	7,912	7,8	M60	5,5	54,046	54,796	54,5
M10	1,5	8,376	8,676	8,5	M64	6,0	57,505	58,305	58
M11	1,5	9,376	9,676	9,5	M68	6,0	61,505	62,305	62

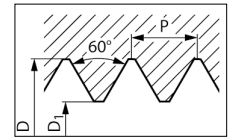

MF ISO metric fine threads 6H to DIN 13 and DIN ISO 965-1

Thread nominal Ø			Ø D ₁		Core hole	Thread nominal Ø			Ø D ₁		Core hole
D	x	P	min.	max.		D	x	P	min.	max.	
M2	x	0,25	1,729	1,774	1,75	M20	x	1,0	18,917	19,153	19
M2,2	x	0,25	1,929	1,974	1,95	M20	x	1,5	18,376	18,676	18,5
M2,5	x	0,35	2,121	2,221	2,15	M20	x	2,0	17,835	18,210	18
M3	x	0,35	2,621	2,721	2,65	M24	x	1,5	22,376	22,676	22,5
M3,5	x	0,35	3,121	3,221	3,15	M30	x	2,0	27,835	28,210	28
M4	x	0,35	3,621	3,721	3,65	M36	x	1,5	34,376	34,676	34,5
M4	x	0,5	3,459	3,599	3,5	M36	x	3,0	32,752	33,252	33
M4,5	x	0,5	3,959	4,099	4	M42	x	2,0	39,835	40,210	40
M5	x	0,5	4,459	4,599	4,5	M48	x	1,5	46,376	46,676	46,5
M6	x	0,5	5,459	5,599	5,5	M48	x	3,0	44,752	45,252	45
M6	x	0,75	5,188	5,378	5,2	M48	x	4,0	43,670	44,270	44
M8	x	0,75	7,188	7,378	7,2	M56	x	1,5	54,376	54,676	54,5
M8	x	1,0	6,917	7,153	7	M56	x	2,0	53,835	54,210	54
M10	x	0,75	9,188	9,378	9,2	M56	x	3,0	52,752	53,252	53
M10	x	1,0	8,917	9,153	9	M56	x	4,0	51,670	52,270	52
M10	x	1,25	8,647	8,912	8,8	M64	x	3,0	60,752	61,252	61
M12	x	1,0	10,917	11,153	11	M64	x	4,0	59,670	60,270	60
M12	x	1,5	10,376	10,676	10,5	M72	x	4,0	67,670	68,270	68
M14	x	1,25	12,647	12,912	12,8	M80	x	6,0	73,505	74,305	74
M16	x	1,0	14,917	15,153	15	M95	x	6,0	88,505	89,305	89
M16	x	1,5	14,376	14,676	14,5	M110	x	6,0	103,505	104,305	104

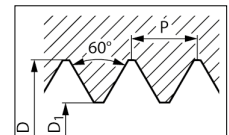

Dimensions in mm; P=Pitch

Tap Type Explanation

Through hole tap type Stabil

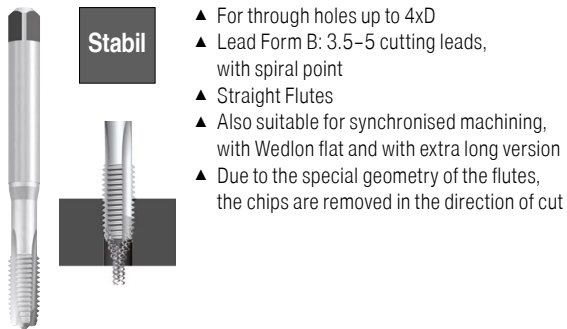

Stabil

- ▲ For through holes up to 4xD
- ▲ Lead Form B: 3.5–5 cutting leads, with spiral point
- ▲ Straight Flutes
- ▲ Also suitable for synchronised machining, with Weldon flat and with extra long version
- ▲ Due to the special geometry of the flutes, the chips are removed in the direction of cut

Blind hole tap type Salo-Rex

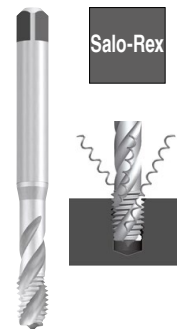

Salo-Rex

- ▲ For blind holes up to 3xD
- ▲ Lead Form C: 2–3 cutting leads, without spiral point
- ▲ Lead Form E: 1.5–2 cutting leads, without spiral point
- ▲ (35°, 42°, 45°, 50°) right hand helix
- ▲ Also suitable for synchronised machining, with Weldon flat, with extra long version and through coolant
- ▲ The high helix angle ensures chips are discharged effectively against the direction of cut

Blind hole tap type SL

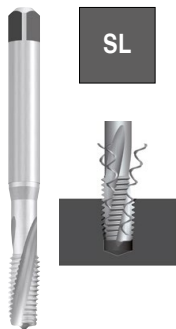

SL

- ▲ For blind holes up to 2xD
- ▲ Lead Form C: 2–3 cutting leads, without spiral point
- ▲ Lead Form E: 1.5–2 cutting leads, without spiral point
- ▲ (15°, 25°, 30°) slow right hand helix
- ▲ For steel, titanium alloys and Inconel 718
- ▲ Also suitable for synchronised machining, with extra long version and through coolant
- ▲ Also suitable for difficult operating conditions such as cross holes

Coloured rings – overview

WNT \ Performance

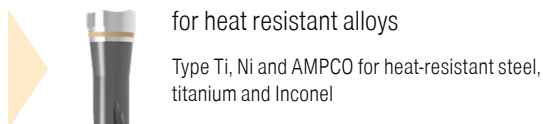

for heat resistant alloys

Type Ti, Ni and AMPCO for heat-resistant steel, titanium and Inconel

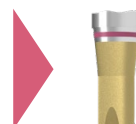

for universal application up to 1100 N/mm²

Type UNI for the all-purpose use



for steel up to 1400 N/mm²

Type HR for steel up to 1400 N/mm² tensile strength

Thread tolerances and recommended manufacturing tolerances

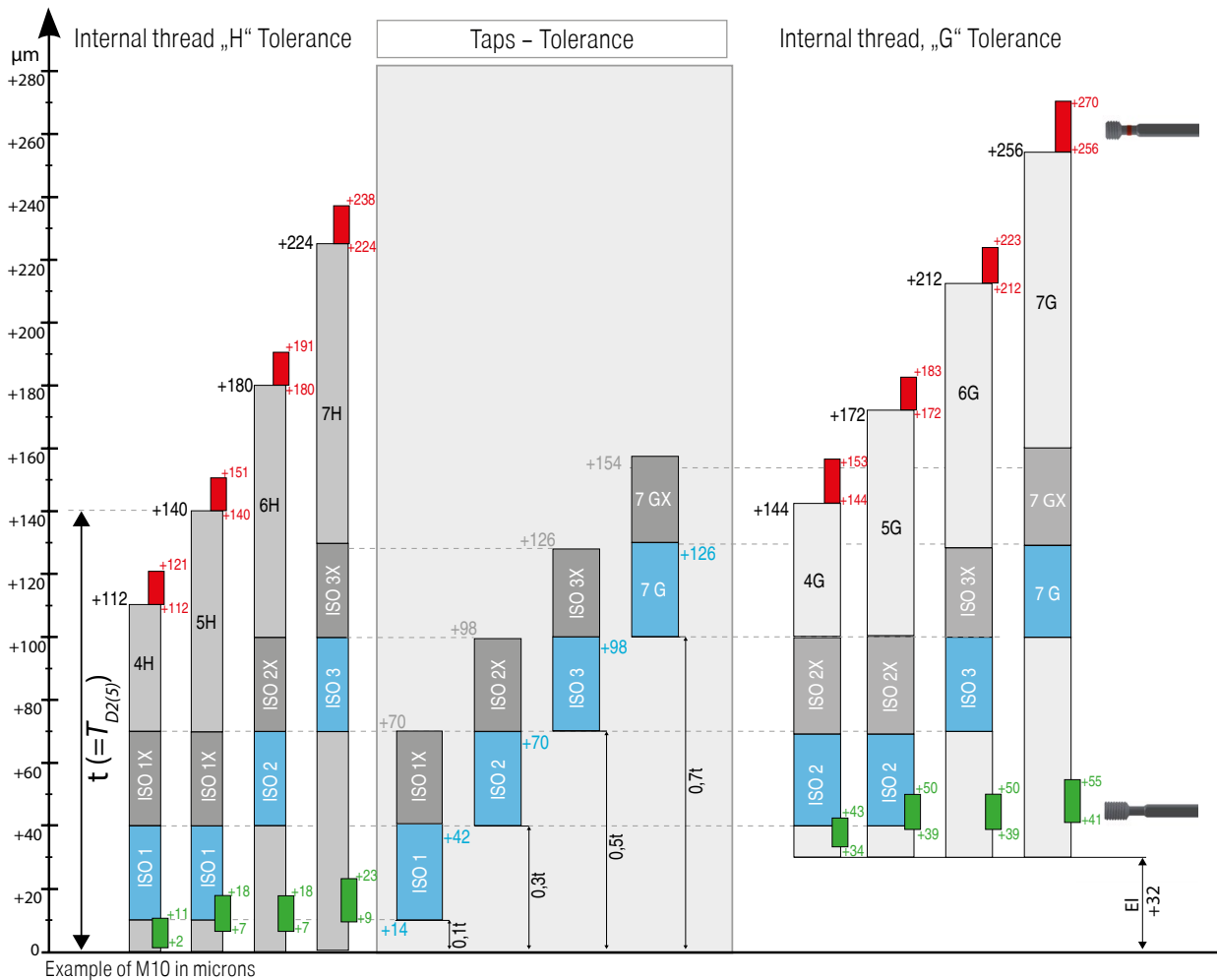

Workpieces to be plated require oversize taps.
The interference depends on the coating thickness and the flank angle.

at	60° Flank angle	Oversize $\hat{=}$ 4 x coating thickness
	55° Flank angle	Oversize $\hat{=}$ 4.331 x coating thickness
	30° Flank angle	Oversize $\hat{=}$ 7.727 x coating thickness

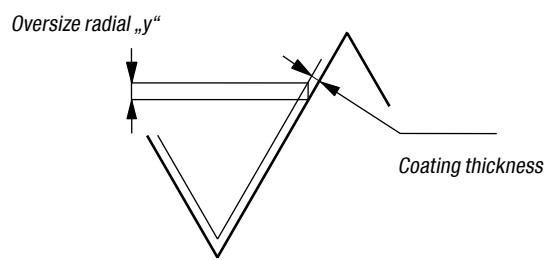

Application class of the tap Designation according to		Tolerance class of the internal thread to be cut					
DIN	ISO	4H	5H	6H	7H	8H	
4H	ISO1	4H	5H	-	-	-	
6H	ISO2	4G	5G	6H	-	-	
6G	ISO3	-	(4E)	6G	7H	8H	
7G	-	-	-	(6E)	7G	8G	

i For special applications, e.g. abrasive cast iron materials or plastics other dimensions have to be chosen which are determined on previous experience. In such cases an „X“ is added to the short designation of the tolerance, e.g. ISO 2X, however the tolerance zone assignment may be limited (6HX for tolerance zone 6H and 5G). In addition it should be taken into account that the dimensions of the internal thread do not only depend on the dimensions of the tap but on the material to be machined and all production conditions. For first taps and intermediate taps no thread dimensions are determined.

Troubleshooting

Poor tool life

Cause

- ▲ Overload fractures of the cutting edge on the lead
- ▲ Hardness or tool material not suitable for the application
- ▲ Core hole too small, or work hardened
- ▲ Insufficient lubrication or incorrect application parameters

Remedy

- ▲ A longer lead or more flutes for the same lead length, giving a greater number of cutting teeth
- ▲ In reground tools the hardness can be reduced, apply correct parameters for regrinding
- ▲ Increase frequency of changes or regrinding of the drill
- ▲ Use the correct operating parameters for drilling
- ▲ Select the correct lubricant and ensure adequate supply

Axial thread error

Cause

- ▲ Selected geometry is not suitable
- ▲ Spindle speed is wrong compared with feed (synchronisation error)
- ▲ Blind hole taps are used with high feed pressure
- ▲ Through hole taps are used with low feed pressure

Remedy

- ▲ Check programming and pitch control or machine synchronisation
- ▲ Use tapping chuck with length compensation
- ▲ Increase retraction feed pressure
- ▲ Increase feed pressure

Oversize thread

Cause

- ▲ Thread tolerances of tool and thread gauge do not match
- ▲ Burred tool edges after regrinding
- ▲ Cold pressure welding

Remedy

- ▲ Check the correct tolerances for tool and thread gauge
- ▲ Carefully deburr
- ▲ Use appropriate (positive) geometry
- ▲ Reduce cutting speed
- ▲ Use different surface treatment or coating
- ▲ Use tapping chuck with length compensation
- ▲ Use appropriate lubricant

Broken tool

Cause

- ▲ Tool is worn
- ▲ Tool has hit the bottom of the hole
- ▲ Weld deposits
- ▲ Core hole too small
- ▲ Chip trapping
- ▲ Incorrect cutting speed
- ▲ Chip trapping in the flute
- ▲ Insufficient cooling / lubrication

Remedy

- ▲ Employ set taps
- ▲ Use a tool with lower helix
- ▲ Use tools with a shorter / longer lead
- ▲ Check the pre-drilling depth and the thread depth
- ▲ Drill core hole deeper
- ▲ Correct cutting speed
- ▲ Use a different coating or surface treatment
- ▲ Use tool holder with length compensation
- ▲ Use suitable lubricant
- ▲ Use correct core hole
- ▲ Change geometry and / or flute type
- ▲ Note chip shape and chip formation

Thread milling cutters overview

	Thread type	Application	Angle	Diameter in mm Ø DC	Material	Pitch/thread	Profile type	Coating	WNT \ Performance	WNT \ Standard
	M	IR/IL	60°	5,8 - 7,8	HA	0,5 - 2,0	Partial profile	CWX 500	24	
	M	IR/IL	60°	1,18 - 4,10	HA	M1,6 - M6	Full profile	CWX 500	24	
	M	IR/IL	60°	2,4 - 11,6	HB	M3 - M14	Full profile	Ti 500	25	
	MF	IR/IL	60°	4,0 - 11,6	HB	M5x0,5 - M14x1,5	Full profile	Ti 500	25	
	G	IR/IL	55°	8,0 - 16,0	HB	G 1/8 - 28 - G 1/2 - 14	Full profile	Ti 500	25	
	BSW	IR/IL	55°	6,0 - 9,9	HB	BSW 5/16 - 18 - BSW 5/8 - 11	Full profile	Ti 500	26	
	BSF	IR/IL	55°	6,0 - 9,9	HB	BSF 3/8 - 20 - BSF 5/8 - 14	Full profile	Ti 500	26	
	UNC	IR/IL	60°	4,8 - 9,9	HB	UNC 1/4 - 20 - UNC 1/2 - 13	Full profile	Ti 500	26	
	UNF	IR/IL	60°	4,8 - 9,9	HB	UNF 1/4 - 28 - UNF 1/2 - 20	Full profile	Ti 500	27	
	M	IR/IL	60°	8,0 - 16,0	HB	0,5 - 3,0	Partial profile	Ti 500	28	

Further dimensions and thread milling cutters can be found in our → **main catalogue in Chapter 7 Circular- and Thread milling cutters**

MicroMill – Solid Carbide Circular Thread Milling Cutter – Partial profile

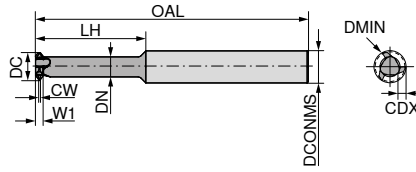
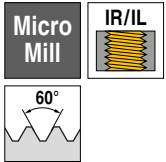

CWX500



HA

Solid carbide

53 053 ...

DC mm	TP mm	W1 mm	CW mm	CDX mm	LH mm	OAL mm	DN mm	DCONMS _{h6} mm	ZEFP	DMIN mm	
5.8	0,5 - 1,5	2	0.06	0.91	15.2	58	3.5	6	3	6	010
7.8	0,5 - 1,5	2	0.06	0.91	25.4	68	5.5	8	3	8	110
7.8	1,0 - 2,0	2	0.12	1.19	25.4	68	5.0	8	3	8	120

P	•
M	•
K	•
N	•
S	•
H	•
O	•

→ v_c/f_z Page 39

MicroMill – Solid Carbide Circular Thread Milling Cutter – Full profile

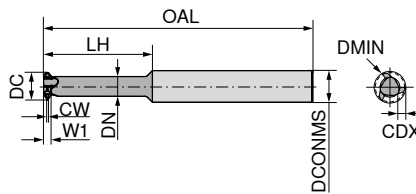
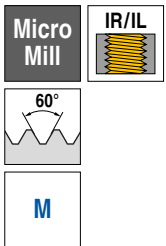

CWX500



HA

Solid carbide

53 052 ...

DC mm	Thread	TP mm	W1 mm	CW mm	CDX mm	LH mm	OAL mm	DN mm	DCONMS _{h6} mm	ZEFP	DMIN mm	
1.18	M1,6	0.35	0.40	0.04	0.19	4.0	32	0.64	3	3	1.38	160
1.38	M1,8	0.35	0.50	0.04	0.19	5.0	32	0.70	3	3	1.58	180
1.50	M2	0.40	0.56	0.05	0.22	5.0	32	0.90	3	4	1.70	200
1.95	M2,5	0.45	0.60	0.06	0.25	6.0	32	1.15	3	4	2.15	250
2.40	M3	0.50	0.60	0.06	0.27	7.0	32	1.60	3	4	2.60	300
2.80	M3,5	0.60	0.74	0.08	0.33	8.0	32	1.80	3	4	3.00	350
3.10	M4	0.70	0.82	0.09	0.38	9.0	44	1.98	5	4	3.30	400
3.60	M5	0.80	0.98	0.10	0.43	10.0	44	2.20	5	4	3.80	500
4.10	M6	1.00	0.98	0.13	0.54	12.2	44	2.70	5	4	4.30	600

P	•
M	•
K	•
N	•
S	•
H	•
O	•

→ v_c/f_z Page 39



When calculating the feedrate for circular milling it is important to know whether contour feed v_c or feed on the center path v_{fm} is used. Details on → Page 40+41.

Thread milling cutter

- ▲ Profile corrected
- ▲ Hard machining to $\varnothing DC = 4\text{ mm}$ possible

SGF

IR/IL

≤ 2xD

60°

M

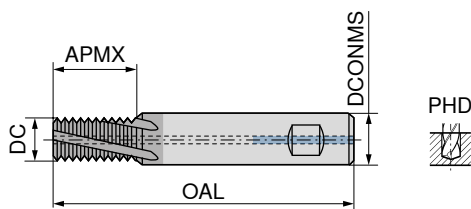

DC mm	Thread	TP mm	APMX mm	DCONMS _{h6} mm	OAL mm	ZAFP	PHD mm	
2.40	M3	0.50	6.5	4	42	2	2.50	030 ¹⁾
3.15	M4	0.70	9.0	6	55	3	3.30	040 ²⁾
4.00	M5	0.80	11.0	6	55	3	4.20	050 ²⁾
4.80	M6	1.00	13.0	6	55	3	5.00	060 ²⁾
6.00	M8	1.25	18.0	6	60	3	6.75	080
8.00	M10	1.50	21.0	8	70	3	8.50	100
9.90	M12	1.75	26.0	10	75	4	10.25	120
11.60	M14	2.00	30.0	12	85	4	12.00	140

- 1) DIN 6535 HA Shank / Without Through Coolant
- 2) Without Through Coolant

60°

MF

54 802 ...

DC mm	Thread	TP mm	APMX mm	DCONMS _{h6} mm	OAL mm	ZAFP	PHD mm	
4.0	M5	0.50	11	6	55	3	4.50	050 ¹⁾
4.8	M6	0.75	13	6	55	3	5.25	060 ¹⁾
6.0	M8	1.00	18	6	60	3	7.00	080
8.0	M10	1.25	21	8	70	3	8.75	100
9.9	M12	1.00	26	10	75	4	11.00	120
9.9	M12	1.25	26	10	75	4	10.75	121
9.9	M12	1.50	26	10	75	4	10.50	122
11.6	M14	1.00	30	12	85	4	13.00	140
11.6	M14	1.50	30	12	85	4	12.50	141

- 1) DIN 6535 HA Shank / Without Through Coolant

55°

G

54 804 ...

DC mm	Thread	TP mm	APMX mm	DCONMS _{h6} mm	OAL mm	ZAFP	PHD mm	
8.0	G 1/8-28	0.907	21	8	70	3	8.80	018
9.9	G 1/4-19	1.337	26	10	75	4	11.80	014
14.0	G 3/8-19	1.337	40	14	90	4	15.25	038
16.0	G 1/2-14	1.814	42	16	90	4	19.00	012



P	•
M	•
K	•
N	•
S	•
H	•
O	•

→ v_c/f_z Page 38

1 When calculating the feedrate for circular milling it is important to know whether contour feed v_r or feed on the center path v_{im} is used. Details on → **Page 40+41.**

Thread milling cutter

▲ Profile corrected

SGF  

$\leq 2xD$

55° 

BSW

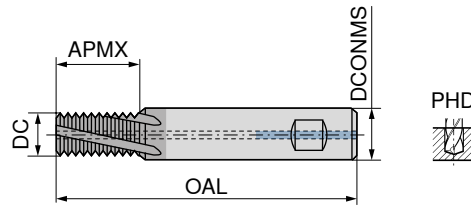

Ti500



HB 

Solid carbide

54 806 ...

DC mm	Thread	TP mm	APMX mm	DCONMS _{h6} mm	OAL mm	ZFP	PHD mm
6.0	BSW 5/16-18	1.411	18	6	60	3	6.50
6.0	BSW 3/8-16	1.588	18	6	60	3	7.90
8.0	BSW 7/16-14	1.814	21	8	70	3	9.25
8.0	BSW 1/2-12	2.117	21	8	70	3	10.50
9.9	BSW 5/8-11	2.309	26	10	75	4	13.50

516
038
716
012
058

55° 

BSF

DC mm	Thread	TP mm	APMX mm	DCONMS _{h6} mm	OAL mm	ZFP	PHD mm
6.0	BSF 3/8-20	1.270	18	6	60	3	8.3
6.0	BSF 5/16-22	1.155	18	6	60	3	6.8
8.0	BSF 1/2-16	1.588	21	8	70	3	11.1
8.0	BSF 7/16-18	1.411	21	8	70	3	9.7
9.9	BSF 5/8-14	1.814	26	10	75	4	14.0

54 808 ...

038
516
012
716
058

60° 

UNC

DC mm	Thread	TP mm	APMX mm	DCONMS _{h6} mm	OAL mm	ZFP	PHD mm
4.80	UNC 1/4-20	1.270	13	6	55	3	5.1
6.00	UNC 5/16-18	1.411	18	6	60	3	6.6
7.95	UNC 3/8-16	1.588	21	8	70	3	8.0
7.95	UNC 7/16-14	1.814	21	8	70	3	9.4
9.90	UNC 1/2-13	1.954	26	10	75	4	10.8

54 810 ...

014¹⁾
516
038
716
012

P	●
M	●
K	●
N	●
S	●
H	●
O	●

1) DIN 6535 HA Shank / Without Through Coolant

 When calculating the feedrate for circular milling it is important to know whether contour feed v_f or feed on the center path v_{fm} is used. Details on → **Page 40+41.**

Thread milling cutter

▲ Profile corrected

SGF

IR/IL

≤ 2xD

60°

UNF

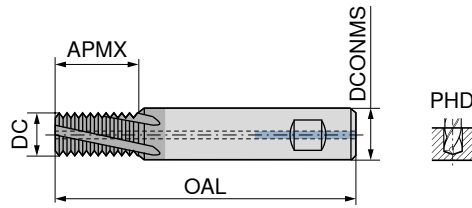

Ti500



HB
Solid carbide

54 812 ...
014 ¹⁾
516
038
716
012

DC mm	Thread	TP mm	APMX mm	DCONMS _{h6} mm	OAL mm	ZFP mm	PHD mm	
4.8	UNF 1/4-28	0.907	13	6	55	3	5.5	
6.0	UNF 5/16-24	1.058	18	6	60	3	6.9	
8.0	UNF 3/8-24	1.058	21	8	70	3	8.5	
8.0	UNF 7/16-20	1.270	21	8	70	3	9.9	
9.9	UNF 1/2-20	1.270	26	10	75	4	11.5	
P								●
M								●
K								●
N								●
S								●
H								●
O								●



1) Without Through Coolant

→ v_c/f_z Page 38

When calculating the feedrate for circular milling it is important to know whether contour feed v_c or feed on the center path v_{im} is used. Details on → Page 40+41.



Thread milling cutter

SGF  

≤ 2xD

60° 

M

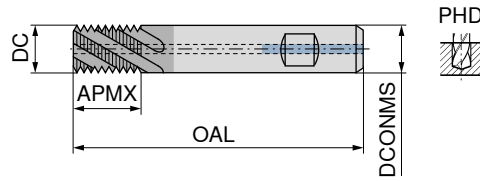

Ti500



HB 

Solid carbide

54 832 ...

















DC mm	TP mm	APMX mm	DCONMS _{n6} mm	OAL mm	ZEFP mm	PHD mm	
8	0.75	12	8	70	3	11	080
8	0.50	12	8	70	3	10	008
10	1.00	16	10	75	4	14	100
10	1.50	16	10	75	4	14	101
12	1.50	20	12	85	4	16	121
12	1.00	20	12	85	4	16	120
12	2.00	20	12	85	4	18	122
16	2.00	25	16	90	5	22	162
16	1.00	25	16	90	5	22	160
16	1.50	25	16	90	5	22	161
16	3.00	25	16	90	5	24	164

P	•
M	•
K	•
N	•
S	•
H	•
O	•

→ v_c/f_z Page 38

 When calculating the feedrate for circular milling it is important to know whether contour feed v_r or feed on the center path v_{im} is used. Details on → **Page 40+41.**

Circular milling cutters overview

	Application	Special feature	Width	Diameter in mm Ø DC	Steel P Stainless steel M Cast iron K Non-ferrous metals N Heat-resistant S Tempered steel H Non metal materials O	Coating	Page No.
			0,7 - 2,0	5,8 - 7,8	● ● ● ● ● ● ● ●	CWX 500	30
			2,0	5,8 - 7,8	● ● ● ● ● ● ● ●	CWX 500	30
		Cross-pitched	1,5 - 6,0	12 - 37	● ● ● ● ○ ○ ● ●	CWX 500	31
			1,0 - 6,0	10 - 22	● ● ● ● ○ ● ● ●	CWX 500	32
			1,0 - 5,0	12 - 22	● ● ● ● ○ ● ● ●	CWX 500	33
		15 - 45°	0,2 - 3,0	10 - 22	● ● ● ● ○ ● ● ●	CWX 500	34
		PDPT = 12 mm	0,5 - 1,5	37	● ● ● ● ○ ● ● ●	CWX 500	35
		extra short					36
		short					36

 Further dimensions and thread milling cutters can be found in our → **main catalogue in Chapter 7 Circular- and Thread milling cutters**

MicroMill – Solid Carbide Circular End Milling Cutter

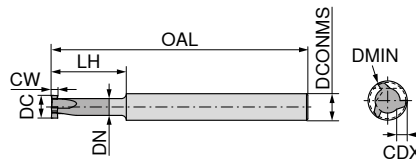

HA Solid carbide

53 050 ...

DC mm	CW ± 0.02 mm	CDX mm	LH mm	OAL mm	DN mm	DCONMS h_6 mm	ZEFP mm	DMIN mm	
5.8	0.7	0.8	15.2	58	3.8	6	3	6	070
	0.8	0.8	15.2	58	3.8	6	3	6	080
	0.9	0.8	15.2	58	3.8	6	3	6	090
	1.0	0.8	15.2	58	3.8	6	3	6	100
	1.5	0.8	15.2	58	3.8	6	3	6	150
7.8	0.7	1.2	25.4	68	5.0	8	3	8	170
	0.8	1.2	25.4	68	5.0	8	3	8	180
	0.9	1.2	25.4	68	5.0	8	3	8	190
	1.0	1.2	25.4	68	5.0	8	3	8	200
	1.5	1.2	25.4	68	5.0	8	3	8	250
	2.0	1.2	25.4	68	5.0	8	3	8	300

P	•
M	•
K	•
N	•
S	•
H	•
O	•

→ v_c/f_z Page 39

MicroMill – Solid Carbide Circular End Milling Cutter

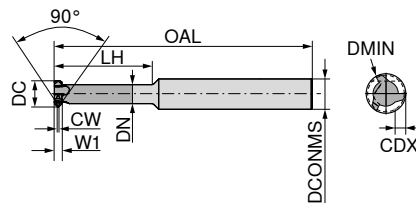

HA Solid carbide

53 051 ...

DC mm	W1 mm	CW mm	CDX mm	LH mm	OAL mm	DN mm	DCONMS h_6 mm	ZEFP mm	DMIN mm	
5.8	2	0.2	0.8	15	58	4.2	6	3	6	010
	2	0.2	0.8	25	68	4.2	6	3	6	020
7.8	2	0.2	1.2	25	68	5.0	8	3	8	110
	2	0.2	1.2	35	78	5.0	8	3	8	120

P	•
M	•
K	•
N	•
S	•
H	•
O	•

→ v_c/f_z Page 39

When calculating the feedrate for circular milling it is important to know whether contour feed v_r or feed on the center path v_{im} is used. Details on → Page 40+41.

MiniMill – Milling insert for groove milling, cross-pitched

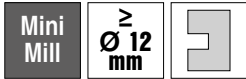

CWX500

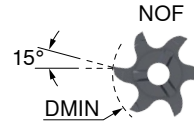
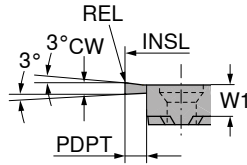
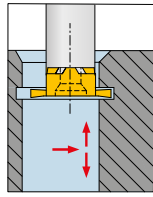

53 015 ...

Size	DMIN mm	INSL mm	CW _{-0,02} mm	PDPT mm	W1 mm	REL mm	NOF	
10	12	11.7	1.5	2.0	3.5	0.2	6	114
	12	11.7	2.0	2.0	3.5	0.2	6	119
14	16	15.7	1.5	2.5	4.5	0.2	6	314
	16	15.7	2.0	2.5	4.5	0.2	6	319
	16	15.7	2.5	2.5	4.5	0.2	6	324
18	18	17.7	2.0	4.0	5.8	0.2	6	419
	18	17.7	2.5	4.0	5.8	0.2	6	424
	18	17.7	3.0	4.0	5.8	0.2	6	429
	20	19.7	2.0	5.0	5.8	0.2	6	469
	20	19.7	2.5	5.0	5.8	0.2	6	474
	20	19.7	3.0	5.0	5.8	0.2	6	479
22	22	21.7	2.0	4.5	6.2	0.2	6	820
	22	21.7	2.5	4.5	6.2	0.2	6	825
	22	21.7	3.0	4.5	6.2	0.2	6	830
	22	21.7	4.0	4.5	6.2	0.2	6	840
	37	36.7	1.5	12.0	6.2	0.1	6	865
	37	36.7	2.0	12.0	6.2	0.2	6	870
P								●
M								●
K								●
N								●
S								○
H								
O								●

→ v_c/f_z Page 39



When calculating the feedrate for circular milling it is important to know whether contour feed v_t or feed on the center path v_{fm} is used. Details on → Page 40+41.

2

MiniMill – Milling insert for groove milling

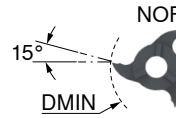
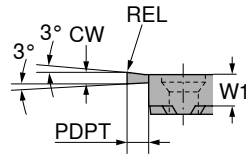
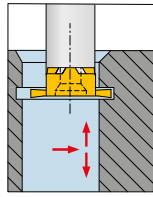
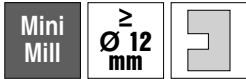

53 007 ...

Size	DMIN mm	CW _{0.02} mm	PDPT mm	W1 mm	REL mm	NOF	
10	10	1.0	1.5	3.50	0.1	3	010
	10	1.5	1.5	3.50	0.2	3	015
	10	2.0	1.5	3.50	0.2	3	020
	10	2.5	1.5	3.50	0.2	3	025
	12	1.5	2.0	3.50	0.2	6	114
	12	1.5	2.5	3.50	0.2	3	115
	12	2.0	2.0	3.50	0.2	6	119
	12	2.0	2.5	3.50	0.2	3	120
	12	2.5	2.5	3.50	0.2	3	125
14	14	1.0	2.5	4.50		3	210
	14	1.5	2.5	4.50	0.2	3	215
	14	2.0	2.5	4.50	0.2	3	220
	14	2.5	2.5	4.50	0.2	3	225
	16	1.5	3.5	4.50	0.2	3	315
	16	2.0	3.5	4.50	0.2	3	320
16	2.5	3.5	4.50	0.2	3	325	
18	18	1.5	3.5	5.75	0.1	6	414
	18	1.5	3.5	5.75	0.2	3	415
	18	2.0	3.5	5.75	0.2	6	419
	18	2.0	3.5	5.75	0.2	3	420
	18	2.5	3.5	5.75	0.2	3	425
	18	2.5	3.5	5.75	0.2	6	424
	18	3.0	3.5	5.75	0.2	6	429
	18	3.0	3.5	5.75	0.2	3	430
	18	4.0	3.5	5.75	0.2	3	440
22	22	1.0	4.5	6.20	0.1	6	810
	22	1.5	4.5	6.20	0.1	6	815
	22	1.5	4.5	5.70	0.2	3	515
	22	2.0	4.5	5.70	0.2	3	520
	22	2.0	4.5	6.20	0.2	6	820
	22	2.5	4.5	6.20	0.2	6	825
	22	2.5	4.5	5.70	0.2	3	525
	22	3.0	4.5	5.70	0.2	3	530
	22	3.0	4.5	6.20	0.2	6	830
	22	3.5	4.5	5.70	0.2	3	535
	22	4.0	4.5	5.70	0.2	3	540
	22	4.0	4.5	6.20	0.2	6	840

P	●
M	●
K	●
N	●
S	○
H	
O	●

→ v_c/f_z Page 39



When calculating the feedrate for circular milling it is important to know whether contour feed v_c or feed on the center path v_{fm} is used. Details on → Page 40+41.

MiniMill – Milling insert for groove milling with full radius



CWX500

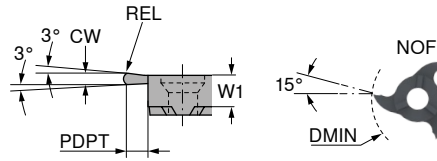
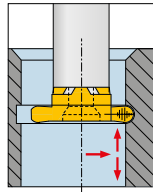

53 008 ...

Size	DMIN mm	CW ^{+0,03} mm	PDPT mm	W1 mm	REL mm	NOF	
10	12	2.2	2.5	3.50	1.1	3	011
14	16	2.2	3.5	4.60	1.1	3	111
18	18	2.2	3.5	5.75	1.1	3	211
22	22	1.0	4.5	5.75	0.5	3	305
	22	1.6	4.5	5.75	0.8	3	308
	22	2.0	4.5	5.75	1.0	3	310
	22	2.4	4.5	5.75	1.2	3	312
	22	2.8	4.5	5.75	1.4	3	314
	22	3.0	4.5	5.75	1.5	3	315
	22	4.0	4.5	5.75	2.0	3	320
	22	4.4	4.5	5.75	2.2	3	322
	22	5.0	4.5	5.75	2.5	3	325

P	•
M	•
K	•
N	•
S	○
H	
O	•

→ v_c/f_z Page 39



When calculating the feedrate for circular milling it is important to know whether contour feed v_c or feed on the center path v_m is used. Details on → Page 40+41.

2

MiniMill – Milling insert for groove milling and chamfering

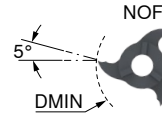
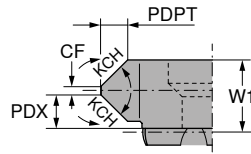
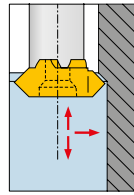
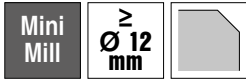

53 009 ...

Size	DMIN mm	CF _{-0,03} mm	PDPT mm	W1 mm	KCH °	PDX mm	NOF	
10	10	0.2	0.35	3.60	15	1.80	6	015
	10	0.2	0.45	3.60	20	1.80	6	020
	10	0.2	0.70	3.60	30	1.80	6	030
	10	0.2	1.20	3.60	45	1.80	6	045
	12	1.2	0.80	3.50	45	1.20	3	035
14	16	1.4	1.20	4.50	45	1.60	3	145
18	18	2.5	1.40	5.85	45	1.70	3	258
	18	0.2	2.20	5.75	45	3.00	6	259
22	22	2.0	1.70	5.85	45	2.00	3	358
	22	0.2	2.50	6.40	45	3.90	6	463
	22	3.0	3.00	9.40	45	3.25	3	394 ¹⁾

P	●
M	●
K	●
N	●
S	○
H	
O	●

1) Use clamping screw 73 082 006

→ v_c/f_z Page 39



When calculating the feedrate for circular milling it is important to know whether contour feed v_f or feed on the center path v_{fm} is used. Details on → Page 40+41.

MiniMill – Milling insert for part-off

- ▲ PDPT = 12,0 mm in combination with holder 53 003 624
- ▲ reduce feed rate by 50 %

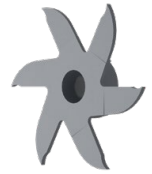
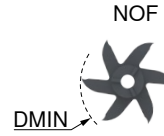
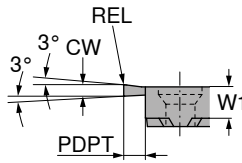
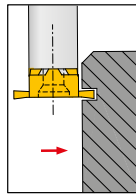
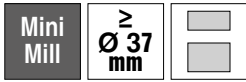

53 013 ...

Size	DMIN mm	CW ^{+0,02} mm	PDPT mm	W1 mm	REL mm	NOF	
22	37	0.5	12	5.6		6	705 ¹⁾
	37	0.6	12	5.7		6	706 ¹⁾
	37	0.8	12	6.0		6	708 ¹⁾
	37	1.0	12	6.2	0.1	6	710
	37	1.5	12	6.2	0.1	6	715
P							●
M							●
K							●
N							●
S							○
H							
O							●

1) The end face is not ground free to the center

When calculating the feedrate for circular milling it is important to know whether contour feed v_t or feed on the center path v_{fm} is used. Details on → Page 40+41.

2

MiniMill – Circular milling cutter, extra short

▲ Steel Version

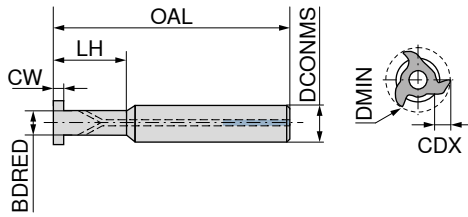

A

Steel

53 004 ...

Size	DCONMS _{h6} mm	BDRED mm	OAL mm	LH mm	DMIN mm	CW mm	CDX mm	torque moment Nm	
10	10	6.0	60	15.2	9,7 / 11,7	≤3,35	1,4 / 2,5	2,0	015
	13	8.0	70	25.7	13,7 / 15,7	≤4,35	2,5 / 3,5	3,5	217 225
18	10	9.0	60	17.0	17,7	≤5,6	3,5	4,5	417
	13	9.0	70	25.0	17,7	≤5,6	3,5	4,5	425
22	10	11.3	60	10.7	21,7	≤9,15	4,5	7,0	610
	13	11.3	70	25.7	21,7	≤9,15	4	7,0	625

MiniMill – Circular milling cutter, short

▲ Steel Version

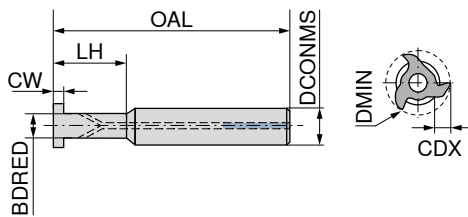

B

Steel

53 003 ...

Size	DCONMS _{h6} mm	BDRED mm	OAL mm	LH mm	DMIN mm	CW mm	CDX mm	torque moment Nm	
22	16	12	80	24	21,7	≤9,15	4,5	7,0	624

When calculating the feedrate for circular milling it is important to know whether contour feed v_f or feed on the center path v_{fm} is used. Details on → **Page 40+41.**

Spare parts Size	Key D		Clamping screw		Clamping screw	
	80 950 ...	110	73 082 ...	006	73 082 ...	004
10	T08	110	M2,6	002		
14	T10	112	M3,5	003		
18	T15	113	M4	004		
22			M5	006		

Clamping screw 73 082 006 only for insert 53 009 394

Material examples for cutting data tables

	Material sub-group	Index	Composition / Structure / Heat treatment	Tensile strength N/mm ² / HB / HRC	Material number	Material designation	Material number	Material designation
P	Unalloyed steel	P.1.1	< 0,15 % C Annealed	420 N/mm ² / 125 HB	1.0401	C15	1.1141	Ck15
		P.1.2	< 0,45 % C Annealed	640 N/mm ² / 190 HB	1.1191	C45E	1.0718	9SMnPb28
		P.1.3	< 0,45 % C Tempered	840 N/mm ² / 250 HB	1.1191	C45E	1.0535	C55
		P.1.4	< 0,75 % C Annealed	910 N/mm ² / 270 HB	1.1223	C60R	1.0535	C55
		P.1.5	< 0,75 % C Tempered	1010 N/mm ² / 300 HB	1.1223	C60R	1.0727	45S20
	Low-alloy steel	P.2.1	Annealed	610 N/mm ² / 180 HB	1.7131	16MnCr5	1.6587	17CrNiMo6
		P.2.2	Tempered	930 N/mm ² / 275 HB	1.7131	16MnCr5	1.6587	17CrNiMo6
		P.2.3	Tempered	1010 N/mm ² / 300 HB	1.7225	42CrMo4	1.3505	100Cr6
		P.2.4	Tempered	1200 N/mm ² / 375 HB	1.7225	42CrMo4	1.3505	100Cr6
	High-alloy steel and high-alloy tool steel	P.3.1	Annealed	680 N/mm ² / 200 HB	1.4021	X20Cr13	1.4034	X46Cr13
		P.3.2	Hardened and tempered	1100 N/mm ² / 300 HB	1.2343	X38CrMoV5-1	1.4034	X46Cr13
		P.3.3	Hardened and tempered	1300 N/mm ² / 400 HB	1.2343	X38CrMoV5-1	1.4034	X46Cr13
	Stainless steel	P.4.1	Ferritic / martensitic Annealed	680 N/mm ² / 200 HB	1.4016	X6Cr17	1.2316	X36CrMo16
		P.4.2	Martensitic Tempered	1010 N/mm ² / 300 HB	1.4112	X90CrMoV18	1.2316	X36CrMo16
M	Stainless steel	M.1.1	Austenitic / austenitic-ferritic Quenched	610 N/mm ² / 180 HB	1.4301	X5CrNi18-10	1.4571	X6CrNiMoTi17-12-2
		M.2.1	Austenitic Tempered	300 HB	1.4841	X15CrNiSi25-21	1.4539	X1NiCrMoCu25-20-5
		M.3.1	Austenitic / ferritic (Duplex)	780 N/mm ² / 230 HB	1.4462	X2CrNiMoN22-5-3	1.4501	X2CrNiMoCuWN25-7-4
K	Grey cast iron	K.1.1	Pearlitic / ferritic	350 N/mm ² / 180 HB	0.6010	GG-10	0.6025	GG-25
		K.1.2	Pearlitic (martensitic)	500 N/mm ² / 260 HB	0.6030	GG-30	0.6045	GG-45
	Spherulitic graphite cast iron	K.2.1	Ferritic	540 N/mm ² / 160 HB	0.7040	GGG-40	0.7060	GGG-60
		K.2.2	Pearlitic	845 N/mm ² / 250 HB	0.7070	GGG-70	0.7080	GGG-80
	Malleable iron	K.3.1	Ferritic	440 N/mm ² / 130 HB	0.8035	GTW-35-04	0.8045	GTW-45
		K.3.2	Pearlitic	780 N/mm ² / 230 HB	0.8165	GTS-65-02	0.8170	GTS-70-02
N	Aluminium wrought alloy	N.1.1	Non-hardenable	60 HB	3.0255	Al99,5	3.3315	AlMg1
		N.1.2	Hardenable Age-hardened	340 N/mm ² / 100 HB	3.1355	AlCuMg2	3.2315	AlMgSi1
	Cast aluminium alloy	N.2.1	≤ 12 % Si, non-hardenable	250 N/mm ² / 75 HB	3.2581	G-AlSi12	3.2163	G-AlSi9Cu3
		N.2.2	≤ 12 % Si, hardenable Age-hardened	300 N/mm ² / 90 HB	3.2134	G-AlSi5Cu1Mg	3.2373	G-AlSi9Mg
		N.2.3	> 12 % Si, non-hardenable	440 N/mm ² / 130 HB		G-AlSi17Cu4Mg		G-AlSi18CuNiMg
	Copper and copper alloys (bronze/brass)	N.3.1	Free-machining alloys, PB > 1 %	375 N/mm ² / 110 HB	2.0380	CuZn39Pb2 (Ms58)	2.0410	CuZn44Pb2
		N.3.2	CuZn, CuSnZn	300 N/mm ² / 90 HB	2.0331	CuZn15	2.4070	CuZn28Sn1As
		N.3.3	CuSn, lead-free copper and electrolytic copper	340 N/mm ² / 100 HB	2.0060	E-Cu57	2.0590	CuZn40Fe
	Magnesium alloys	N.4.1	Magnesium and magnesium alloys	70 HB	3.5612	MgAl6Zn	3.5312	MgAl3Zn
	S	Heat-resistant alloys	S.1.1	Fe - basis Annealed	680 N/mm ² / 200 HB	1.4864	X12NiCrSi 36-16	1.4865
S.1.2			Fe - basis Age-hardened	950 N/mm ² / 280 HB	1.4980	X6NiCrTiMoVB25-15-2	1.4876	X10NiCrAlTi32-20
S.2.1			Ni or Co basis Annealed	840 N/mm ² / 250 HB	2.4631	NiCr20TiAl (Nimonic80A)	3.4856	NiCr22Mo9Nb
S.2.2			Ni or Co basis Age-hardened	1180 N/mm ² / 350 HB	2.4668	NiCr19Nb5Mo3 (Inconel 718)	2.4955	NiFe25Cr20NbTi
S.2.3			Ni or Co basis Cast	1080 N/mm ² / 320 HB	2.4765	CoCr20W15Ni	1.3401	G-X120Mn12
Titanium alloys		S.3.1	Pure titanium	400 N/mm ²	3.7025	Ti99,8	3.7034	Ti99,7
		S.3.2	Alpha + beta alloys Age-hardened	1050 N/mm ² / 320 HB	3.7165	TiAl6V4	Ti-6246	Ti-6Al-2Sn-4Zr-6Mo
S.3.3	Beta alloys	1400 N/mm ² / 410 HB	Ti555.3	Ti-5Al-5V-5Mo-3Cr	R56410	Ti-10V-2Fe-3Al		
H	Hardened steel	H.1.1	Hardened and tempered	46-55 HRC				
		H.1.2	Hardened and tempered	56-60 HRC				
		H.1.3	Hardened and tempered	61-65 HRC				
		H.1.4	Hardened and tempered	66-70 HRC				
	Chilled iron	H.2.1	Cast	400 HB				
	Hardened cast iron	H.3.1	Hardened and tempered	55 HRC				
O	Non-metal materials	O.1.1	Plastics, duroplastic	≤ 150 N/mm ²				
		O.1.2	Plastics, thermoplastic	≤ 100 N/mm ²				
		O.2.1	Aramid fibre-reinforced	≤ 1000 N/mm ²				
		O.2.2	Glass/carbon-fibre reinforced	≤ 1000 N/mm ²				
		O.3.1	Graphite					

* Tensile strength

Cutting data standard values

Index	SFG VHM Ti 500 54 832 ...			SFG VHM Ti 500 54 800 ..., 54 802 ..., 54 804 ..., 54 806 ..., 54 808 ..., 54 810 ..., 54 812 ...			
	V _c m/min	8 mm	10–16 mm	V _c m/min	Ø 2,4–3,15	Ø 4	Ø 4,8–16
		f _z [mm/tooth]	f _z [mm/tooth]		f _z [mm/tooth]	f _z [mm/tooth]	f _z [mm/tooth]
P.1.1	150	0,03–0,07	0,05–0,15	150	0,03–0,04	0,03–0,06	0,05–0,15
P.1.2	150	0,03–0,07	0,05–0,15	150	0,03–0,04	0,03–0,06	0,05–0,15
P.1.3	120	0,03–0,07	0,05–0,10	120	0,02–0,03	0,02–0,06	0,05–0,10
P.1.4	120	0,03–0,06	0,04–0,06	120	0,01–0,02	0,03–0,05	0,04–0,06
P.1.5	120	0,03–0,06	0,04–0,06	120	0,01–0,02	0,03–0,05	0,04–0,06
P.2.1	120	0,03–0,06	0,04–0,06	120	0,01–0,02	0,03–0,05	0,04–0,06
P.2.2	120	0,03–0,06	0,04–0,06	120	0,01–0,02	0,03–0,05	0,04–0,06
P.2.3	80	0,03–0,06	0,04–0,06	80	0,01–0,02	0,03–0,05	0,04–0,06
P.2.4	70	0,03–0,06	0,04–0,06	70	0,01–0,02	0,03–0,05	0,04–0,06
P.3.1	80	0,03–0,06	0,04–0,06	80	0,01–0,02	0,03–0,05	0,04–0,06
P.3.2	70	0,03–0,06	0,04–0,06	70	0,01–0,02	0,03–0,05	0,04–0,06
P.3.3	60	0,03–0,06	0,04–0,06	60	0,01–0,02	0,03–0,05	0,04–0,06
P.4.1	50	0,03–0,06	0,04–0,06	50	0,01–0,02	0,03–0,05	0,04–0,06
P.4.2	50	0,03–0,06	0,04–0,06	50	0,01–0,02	0,03–0,05	0,04–0,06
M.1.1	120	0,04–0,07	0,05–0,12	120	0,03–0,04	0,03–0,04	0,05–0,12
M.2.1	120	0,04–0,07	0,05–0,12	120	0,03–0,04	0,03–0,04	0,05–0,12
M.3.1	120	0,04–0,07	0,05–0,12	120	0,03–0,04	0,03–0,04	0,05–0,12
K.1.1	140	0,04–0,07	0,07–0,15	140	0,03–0,07	0,03–0,07	0,07–0,12
K.1.2	100	0,04–0,07	0,07–0,15	100	0,03–0,07	0,03–0,07	0,07–0,12
K.2.1	140	0,04–0,07	0,07–0,15	140	0,03–0,07	0,03–0,07	0,07–0,12
K.2.2	120	0,04–0,07	0,07–0,15	120	0,03–0,07	0,03–0,07	0,07–0,10
K.3.1	140	0,04–0,07	0,07–0,15	140	0,03–0,07	0,03–0,07	0,07–0,10
K.3.2	100	0,04–0,07	0,07–0,15	100	0,03–0,07	0,03–0,07	0,07–0,10
N.1.1	400	0,05–0,08	0,07–0,15	400	0,05–0,07	0,05–0,07	0,07–0,15
N.1.2	350	0,05–0,08	0,07–0,15	350	0,05–0,07	0,05–0,07	0,07–0,15
N.2.1	350	0,05–0,08	0,07–0,15	350	0,05–0,07	0,05–0,07	0,07–0,15
N.2.2	250	0,05–0,08	0,07–0,15	250	0,05–0,07	0,05–0,07	0,07–0,15
N.2.3	200	0,05–0,08	0,07–0,15	200	0,05–0,07	0,05–0,07	0,07–0,15
N.3.1	160	0,05–0,08	0,07–0,15	160	0,05–0,07	0,05–0,07	0,07–0,15
N.3.2	160	0,05–0,08	0,07–0,15	160	0,05–0,07	0,05–0,07	0,07–0,15
N.3.3	160	0,05–0,08	0,07–0,15	160	0,05–0,07	0,05–0,07	0,07–0,15
N.4.1	160	0,05–0,08	0,07–0,15	160	0,05–0,07	0,05–0,07	0,07–0,15
S.1.1	100	0,02–0,04	0,04–0,10	100	0,02–0,04	0,02–0,04	0,04–0,10
S.1.2	80	0,02–0,04	0,04–0,10	80	0,02–0,04	0,02–0,04	0,04–0,10
S.2.1	60	0,03–0,05	0,04–0,06	60	0,01–0,02	0,03–0,05	0,04–0,06
S.2.2	40	0,03–0,05	0,04–0,06	40	0,01–0,02	0,03–0,05	0,04–0,06
S.2.3	40	0,03–0,05	0,04–0,06	40	0,01–0,02	0,03–0,05	0,04–0,06
S.3.1	100	0,02–0,04	0,04–0,10	100	0,02–0,04	0,02–0,04	0,04–0,10
S.3.2	80	0,03–0,05	0,04–0,06	80	0,01–0,02	0,03–0,05	0,04–0,06
S.3.3	60	0,03–0,05	0,04–0,06	60	0,01–0,02	0,03–0,05	0,04–0,06
H.1.1	60	0,01–0,02	0,03–0,05	60		0,01–0,02	0,03–0,05
H.1.2	50	0,01–0,02	0,03–0,05	50		0,01–0,02	0,03–0,05
H.1.3	40	0,01–0,02	0,03–0,05	40		0,01–0,02	0,03–0,05
H.1.4	30	0,01–0,02	0,03–0,05	30		0,01–0,02	0,03–0,05
H.2.1	60	0,01–0,02	0,03–0,05	60		0,01–0,02	0,03–0,05
H.3.1	50	0,01–0,02	0,03–0,05	50		0,01–0,02	0,03–0,05
O.1.1	180	0,05–0,10	0,07–0,25	180	0,01–0,05	0,05–0,10	0,07–0,25
O.1.2	220	0,05–0,10	0,07–0,25	220	0,01–0,05	0,05–0,10	0,07–0,25
O.2.1	120	0,05–0,10	0,07–0,25	120	0,01–0,05	0,05–0,10	0,07–0,25
O.2.2	120	0,05–0,10	0,07–0,25	120	0,01–0,05	0,05–0,10	0,07–0,25
O.3.1	400	0,05–0,10	0,07–0,25	400	0,01–0,05	0,05–0,10	0,07–0,25



The cutting data is strongly influenced by external conditions, such as the stability of the tool and workpiece clamping, material and type of machine. The specified values represent guideline cutting data that can be adjusted by approx. ±20% according to the usage conditions.

Cutting data standard values

MiniMill				MicroMill	
53 007 ..., 53 008 ..., 53 009 ..., 53 013 ..., 53 015 ...				53 050 ..., 53 051 ..., 53 052 ..., 53 053 ...	
Index	v_c m/min	f_z (drilling) [mm/tooth]	f_z (Threading) [mm/tooth]	v_c m/min	f_z [mm/tooth]
P.1.1	120 (80-200)	0,03-0,10	0,05-0,20	70 (40-120)	0,01-0,05
P.1.2	110 (70-190)	0,03-0,10	0,05-0,20	60 (40-110)	0,01-0,05
P.1.3	90 (60-150)	0,03-0,10	0,05-0,20	50 (30-80)	0,01-0,05
P.1.4	90 (60-150)	0,03-0,08	0,05-0,18	50 (30-80)	0,01-0,05
P.1.5	70 (50-120)	0,03-0,08	0,05-0,18	40 (30-70)	0,01-0,05
P.2.1	90 (60-150)	0,03-0,10	0,05-0,20	50 (30-80)	0,01-0,05
P.2.2	70 (50-120)	0,03-0,08	0,05-0,18	40 (30-70)	0,01-0,05
P.2.3	60 (40-110)	0,02-0,07	0,05-0,16	40 (20-70)	0,01-0,05
P.2.4	60 (40-100)	0,03-0,07	0,05-0,16	30 (20-60)	0,01-0,04
P.3.1	60 (40-100)	0,03-0,10	0,05-0,20	30 (20-60)	0,01-0,05
P.3.2	50 (30-80)	0,02-0,07	0,05-0,16	30 (20-50)	0,01-0,04
P.3.3	30 (20-60)	0,02-0,07	0,05-0,16	20 (10-40)	0,005-0,03
P.4.1	80 (50-130)	0,03-0,08	0,05-0,18	40 (30-70)	0,01-0,05
P.4.2	60 (40-110)	0,02-0,07	0,05-0,16	40 (20-70)	0,01-0,05
M.1.1	90 (60-150)	0,02-0,07	0,05-0,16	50 (30-80)	0,01-0,03
M.2.1	60 (40-110)	0,02-0,07	0,05-0,16	40 (20-70)	0,01-0,03
M.3.1	50 (30-90)	0,02-0,07	0,05-0,16	30 (20-50)	0,01-0,03
K.1.1	110 (70-190)	0,03-0,10	0,05-0,20	60 (40-110)	0,008-0,06
K.1.2	80 (50-140)	0,03-0,10	0,05-0,20	50 (30-80)	0,008-0,06
K.2.1	70 (50-120)	0,03-0,10	0,05-0,20	40 (30-70)	0,008-0,06
K.2.2	60 (40-100)	0,03-0,10	0,05-0,20	30 (20-60)	0,008-0,06
K.3.1	110 (70-190)	0,03-0,10	0,05-0,20	60 (40-110)	0,008-0,06
K.3.2	90 (60-160)	0,03-0,10	0,05-0,20	50 (30-90)	0,008-0,06
N.1.1	230 (150-390)	0,04-0,15	0,06-0,25	150 (90-260)	0,01-0,06
N.1.2	220 (140-370)	0,04-0,15	0,06-0,25	140 (90-240)	0,01-0,06
N.2.1	190 (120-320)	0,04-0,15	0,06-0,25	120 (70-210)	0,01-0,06
N.2.2	160 (110-270)	0,04-0,15	0,06-0,25	100 (60-180)	0,01-0,06
N.2.3	90 (60-160)	0,04-0,15	0,06-0,25	60 (40-110)	0,01-0,06
N.3.1	170 (110-280)	0,04-0,15	0,06-0,25	110 (70-180)	0,01-0,06
N.3.2	140 (90-240)	0,04-0,15	0,06-0,25	80 (50-150)	0,01-0,06
N.3.3	120 (80-210)	0,04-0,15	0,06-0,25	80 (50-140)	0,01-0,06
N.4.1	170 (110-280)	0,04-0,15	0,06-0,25	70 (40-120)	0,01-0,06
S.1.1	60 (40-100)	0,04-0,15	0,06-0,25	30 (20-50)	0,01-0,06
S.1.2	40 (30-70)	0,04-0,15	0,06-0,25	20 (10-30)	0,01-0,06
S.2.1	60 (40-100)	0,04-0,15	0,06-0,25	30 (20-50)	0,01-0,06
S.2.2	50 (30-80)	0,04-0,15	0,06-0,25	20 (10-40)	0,01-0,06
S.2.3	30 (20-60)	0,04-0,15	0,06-0,25	20 (10-30)	0,01-0,06
S.3.1	60 (40-100)	0,04-0,15	0,06-0,25	20 (10-40)	0,01-0,06
S.3.2	30 (20-60)	0,04-0,15	0,06-0,25	20 (10-30)	0,01-0,06
S.3.3	30 (20-50)	0,04-0,15	0,06-0,25	10 (10-20)	0,01-0,06
H.1.1	50 (30-90)	0,02-0,06	0,04-0,14	20 (10-40)	0,005-0,03
H.1.2					
H.1.3					
H.1.4					
H.2.1					
H.3.1	40 (30-70)	0,02-0,10		20 (10-40)	0,005-0,03
O.1.1	180 (120-310)	0,04-0,15	0,06-0,25	80 (50-130)	0,02-0,09
O.1.2	170 (110-280)	0,04-0,15	0,06-0,25	70 (40-120)	0,02-0,09
O.2.1	140 (90-230)	0,04-0,15	0,06-0,25	50 (30-100)	0,02-0,09
O.2.2	100 (70-170)	0,04-0,15	0,06-0,25	40 (30-70)	0,02-0,09
O.3.1	140 (90-230)	0,005-0,05	0,06-0,25	60 (40-110)	0,02-0,09



 The cutting data is strongly influenced by external conditions, such as the stability of the tool and workpiece clamping, material and type of machine. The specified values represent guideline cutting data that can be adjusted by approx. $\pm 20\%$ according to the usage conditions.

Milling Procedures

Climb milling

Characteristics:

- ① Tool rotation direction „right“
- ② Toolpath counter clockwise
- ③ Feed direction „outwards“

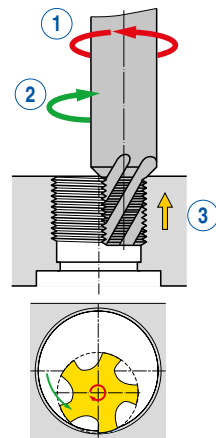

Conventional milling

Characteristics:

- ① Tool rotation direction „right“
- ② Toolpath clockwise
- ③ Feed direction „inwards“

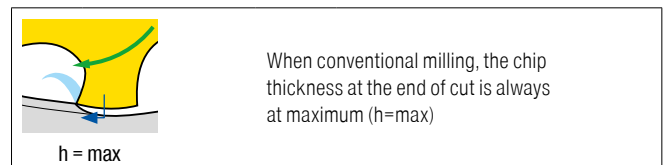
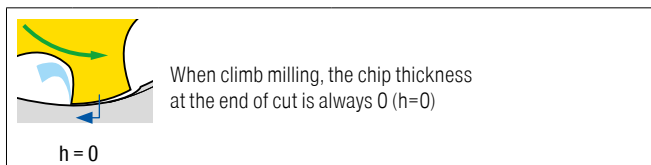
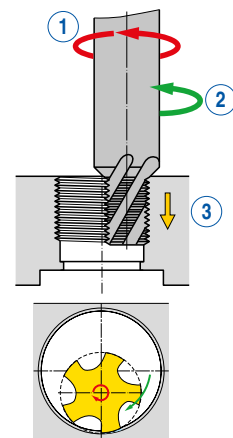

Feed rate calculation

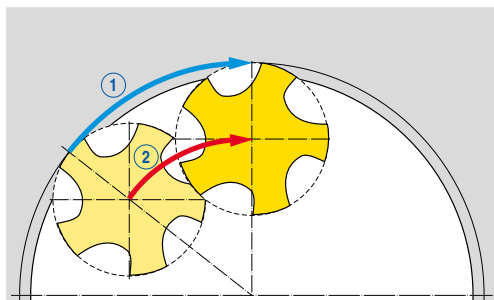

- ① Peripheral feedrate v_f
- ② Centerline feedrate v_{fm}

Peripheral feedrate v_f

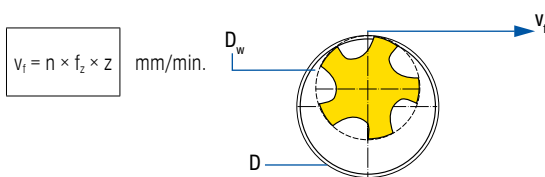

Centerline feedrate v_{fm}

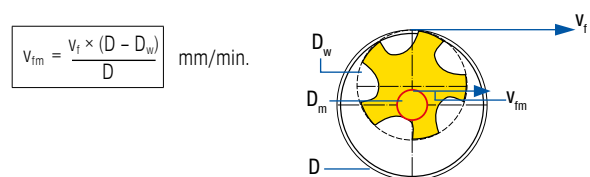

- D_w = Effective diameter in mm
- n = RPM in min^{-1}
- f_z = Feed per tooth in mm

- z = Number of cutting edges (radial)
- D = Nominal thread diameter = external profile diameter in mm
- D_w = Centre path diameter (D- D_w) in mm

Tips for the User

i With thread milling there are two different programme possibilities with the feed motion of the tool.

On the one hand the machine controls the feed at the diameter of the tool, on the other hand the feed control is the tool center line. In order to ascertain which method the machine control uses, the following method should be employed:

- ▲ Enter the thread milling routine into the control.
- ▲ Enter a safety margin into the program, so that the tool runs in air.
- ▲ Run the program through and check the operating time.
- ▲ Compare the actual time with the calculated theoretical time.

If the time is longer than the calculated time the feed is controlling the tool center line.
If the time is shorter than the calculated time the feed is controlling the diameter of the tool.

Numeric calculation of cutting data for thread milling

$$n = \frac{v_c \cdot 1000}{d \cdot \pi}$$

$$v_c = \frac{d \cdot \pi \cdot n}{1000}$$

$$v_f = f_z \cdot z \cdot n$$

$$n = \frac{v_f}{f_z \cdot z}$$

$$f_z = \frac{v_f}{z \cdot n}$$

Milling – external contour

$$v_{fm} = \frac{v_f \cdot (D + d)}{D}$$

$$v_f = \frac{D \cdot v_{fm}}{(D + d)}$$

Milling – internal contour

$$v_{fm} = \frac{v_f \cdot (D - d)}{D}$$

$$v_f = \frac{D \cdot v_{fm}}{(D - d)}$$

Helical plunging

$$U_{arc} = 0,25 \cdot v_{fm}$$

n	=	rpm	rev./min.
v _c	=	Cutting speed	m/min
d	=	Tool diameter	mm
D	=	Nominal thread-Ø	mm
v _f	=	Feed rate at the diameter	mm/min.

Ramping in the arc

$$U_{arc} = v_{fm}$$

v _{fm}	=	Feed rate at the centre	mm/min.
U _{arc}	=	programmed ramping feed rate	mm/min.
f _z	=	Feed per tooth	mm
z	=	number of cutting edges of the cutter	

Correction values for the internal thread milling

The cutting edge diameter of the thread milling cutter which is entered into the machine control, can be calculated as follows:

half the cutter Ø – 0.05 x pitch p

Example: M30x3
Cutter-Ø: 20 mm

$$\frac{\varnothing 20}{2} - (0,05 \cdot 3) = \underline{9,85 \text{ mm}}$$

9,85 mm is the cutting radius to be entered into the machine control

Thread turning tools overview

Full profile



- ▲ Improved quality of thread
- ▲ No burr formation
- ▲ No secondary operations
- ▲ Longer service lives

Partial profile



- ▲ One insert can be used for several pitches
- ▲ Reduced stock requirements

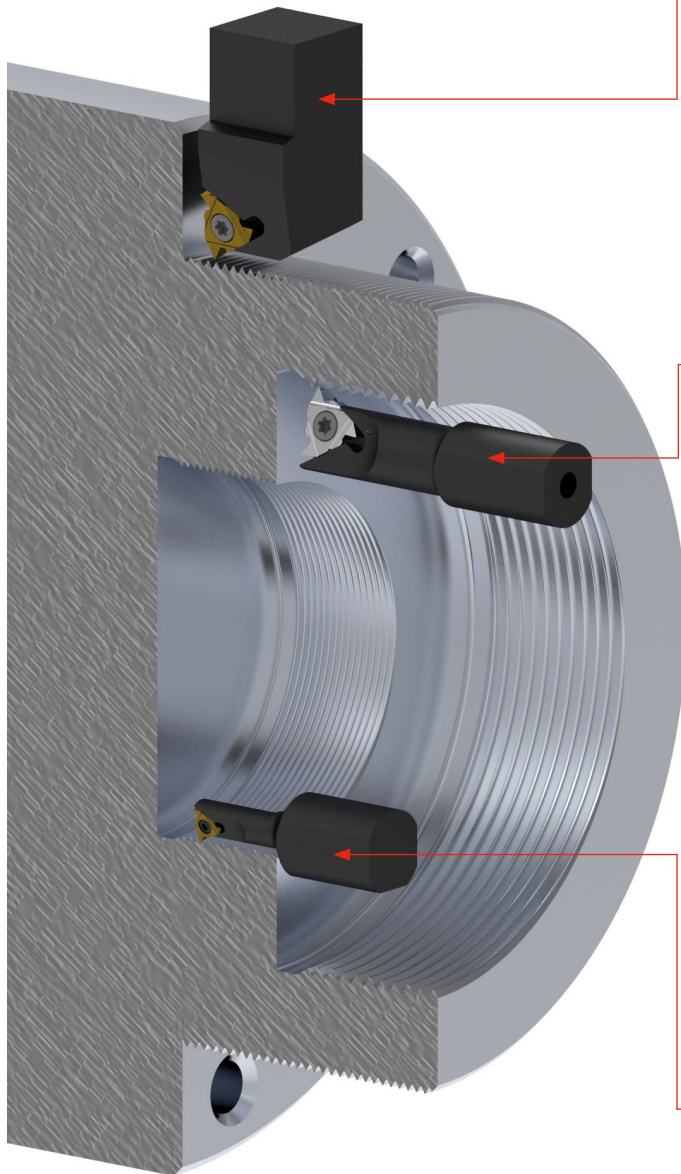

Standard external thread turning

Full profile

M	MJ	BSW	UN	UNC	UNF	UNEF
43+44	47	49+50	53+54	53+54	53+54	53+54

Partial profile

60°	55°
57	59

suitable holder



Standard internal thread turning

Full profile

M	MJ	BSW	UN	UNC	UNF	UNEF
45+46	48	51+52	55+56	55+56	55+56	55+56

Partial profile

60°	55°
58	60

suitable holder



Full profile / partial profile

Mini size 06 / 08



- ▲ Special inserts for low cutting speeds
- ▲ for diameters from 6 mm to 8 mm

Mini 06

Full profile

M	BSW
64	64

Partial profile

60°	55°
65	65

Mini 08

Full profile

M
66

Partial profile

60°	55°
66+67	67+68

suitable holder



Other thread turning tools

VertiClamp

→ Chapter Turning – Turning tools

UltraMini

M	MF	G	Tr
----------	-----------	----------	-----------

Full profile Partial profile Partial profile Partial profile

→ Chapter Turning – Miniature turning tools

Right hand external thread turning insert

▲ Full profile

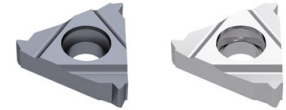
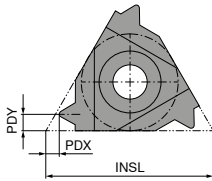

Designation	TP mm	INSL mm	PDX mm	PDY mm	ER	
					71 220 ...	71 220 ...
11 ER 0,35	0.35	11	0.8	0.4	204	604
11 ER 0,4	0.40	11	0.7	0.4	206	606
11 ER 0,45	0.45	11	0.7	0.4	208	608
11 ER 0,5	0.50	11	0.6	0.6	209	609
11 ER 0,6	0.60	11	0.6	0.6	210	610
11 ER 0,7	0.70	11	0.6	0.6	211	611
11 ER 0,75	0.75	11	0.6	0.6	212	612
11 ER 0,8	0.80	11	0.6	0.6	213	613
11 ER 1,0	1.00	11	0.7	0.7	214	614
11 ER 1,25	1.25	11	0.8	0.9	216	616
11 ER 1,5	1.50	11	0.8	1.0	218	618
11 ER 1,75	1.75	11	0.8	1.1	220	620
16 ER 0,35	0.35	16	0.8	0.4	234	634
16 ER 0,4	0.40	16	0.7	0.4	236	636
16 ER 0,45	0.45	16	0.7	0.4	238	638
16 ER 0,5	0.50	16	0.6	0.6	240	640
16 ER 0,7	0.70	16	0.6	0.6	241	641
16 ER 0,75	0.75	16	0.6	0.6	242	642
16 ER 0,8	0.80	16	0.6	0.6	243	643
16 ER 1,0	1.00	16	0.7	0.7	244	644
16 ER 1,25	1.25	16	0.8	0.9	246	646
16 ER 1,5	1.50	16	0.8	1.0	248	648
16 ER 1,75	1.75	16	0.9	1.2	250	650
16 ER 2,0	2.00	16	1.0	1.3	252	652
16 ER 2,5	2.50	16	1.1	1.5	254	654
16 ER 3,0	3.00	16	1.2	1.6	256	656
P					●	
M					●	○
K					●	●
N						●
S					○	○
H					○	
O						

→ v_c Page 72

Left hand external thread turning insert

▲ Full profile

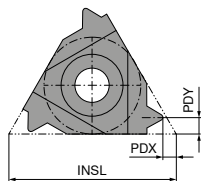

Designation	TP mm	INSL mm	PDX mm	PDY mm	EL	
					71 222 ...	71 222 ...
11 EL 0,35	0.35	11	0.8	0.4	204	604
11 EL 0,4	0.40	11	0.7	0.4	206	606
11 EL 0,45	0.45	11	0.7	0.4	208	608
11 EL 0,5	0.50	11	0.6	0.6	209	609
11 EL 0,6	0.60	11	0.6	0.6	210	610
11 EL 0,7	0.70	11	0.6	0.6	211	611
11 EL 0,75	0.75	11	0.6	0.6	212	612
11 EL 0,8	0.80	11	0.6	0.6	213	613
11 EL 1,0	1.00	11	0.7	0.7	214	614
11 EL 1,25	1.25	11	0.8	0.9	216	616
11 EL 1,5	1.50	11	0.8	1.0	218	618
11 EL 1,75	1.75	11	0.8	1.1	220	620
16 EL 0,35	0.35	16	0.8	0.4	234	634
16 EL 0,4	0.40	16	0.7	0.4	236	636
16 EL 0,45	0.45	16	0.7	0.4	238	638
16 EL 0,5	0.50	16	0.6	0.6	240	640
16 EL 0,7	0.70	16	0.6	0.6	241	641
16 EL 0,75	0.75	16	0.6	0.6	242	642
16 EL 0,8	0.80	16	0.6	0.6	243	643
16 EL 1,0	1.00	16	0.7	0.7	244	644
16 EL 1,25	1.25	16	0.8	0.9	246	646
16 EL 1,5	1.50	16	0.8	1.0	248	648
16 EL 1,75	1.75	16	0.9	1.2	250	650
16 EL 2,0	2.00	16	1.0	1.3	252	652
16 EL 2,5	2.50	16	1.1	1.5	254	654
16 EL 3,0	3.00	16	1.2	1.6	256	656
P					●	
M					●	○
K					●	●
N						●
S					○	○
H					○	
O						

→ v_c Page 72

Right hand internal thread turning insert

▲ Full profile

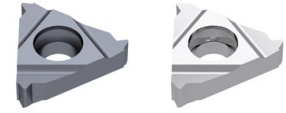
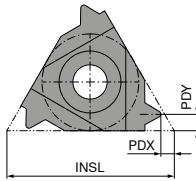

Designation	TP mm	INSL mm	PDX mm	PDY mm	IR	
					71 224 ...	71 224 ...
11 IR 0,35	0.35	11	0.8	0.3	204	604
11 IR 0,4	0.40	11	0.8	0.4	206	606
11 IR 0,45	0.45	11	0.8	0.4	208	608
11 IR 0,5	0.50	11	0.6	0.6	210	610
11 IR 0,7	0.70	11	0.6	0.6	211	611
11 IR 0,75	0.75	11	0.6	0.6	212	612
11 IR 0,8	0.80	11	0.6	0.6	213	613
11 IR 1,0	1.00	11	0.6	0.7	214	614
11 IR 1,25	1.25	11	0.8	0.9	216	616
11 IR 1,5	1.50	11	0.8	1.0	218	618
11 IR 1,75	1.75	11	0.9	1.1	220	620
11 IR 2,0	2.00	11	0.9	1.1	222	622
11 IR 2,5	2.50	11	0.9	1.1	224	624
16 IR 0,35	0.35	16	0.8	0.4	234	634
16 IR 0,4	0.40	16	0.7	0.4	236	636
16 IR 0,45	0.45	16	0.7	0.4	238	638
16 IR 0,5	0.50	16	0.6	0.6	240	640
16 IR 0,7	0.70	16	0.6	0.6	241	641
16 IR 0,75	0.75	16	0.6	0.6	242	642
16 IR 0,8	0.80	16	0.6	0.6	243	643
16 IR 1,0	1.00	16	0.7	0.7	244	644
16 IR 1,25	1.25	16	0.8	0.9	246	646
16 IR 1,5	1.50	16	0.8	1.0	248	648
16 IR 1,75	1.75	16	0.9	1.2	250	650
16 IR 2,0	2.00	16	1.0	1.3	252	652
16 IR 2,5	2.50	16	1.1	1.5	254	654
16 IR 3,0	3.00	16	1.1	1.5	256	656
P					●	
M					●	○
K					●	●
N						●
S					○	○
H					○	
O						

→ v_c Page 72

2

Left hand internal thread turning insert

▲ Full profile

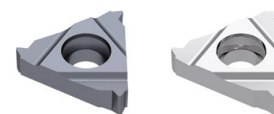
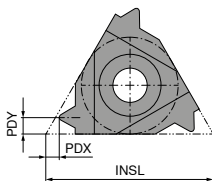

Designation	TP mm	INSL mm	PDX mm	PDY mm	IL	
					71 226 ...	71 226 ...
11 IL 0,35	0.35	11	0.8	0.3	204	604
11 IL 0,4	0.40	11	0.8	0.4	206	606
11 IL 0,45	0.45	11	0.8	0.4	208	608
11 IL 0,5	0.50	11	0.6	0.6	210	610
11 IL 0,7	0.70	11	0.6	0.6	211	611
11 IL 0,75	0.75	11	0.6	0.6	212	612
11 IL 0,8	0.80	11	0.6	0.6	213	613
11 IL 1,0	1.00	11	0.6	0.7	214	614
11 IL 1,25	1.25	11	0.8	0.9	216	616
11 IL 1,5	1.50	11	0.8	1.0	218	618
11 IL 1,75	1.75	11	0.9	1.1	220	620
11 IL 2,0	2.00	11	0.9	1.1	222	622
11 IL 2,5	2.50	11	0.9	1.1	224	624
16 IL 0,35	0.35	16	0.8	0.4	234	634
16 IL 0,4	0.40	16	0.7	0.4	236	636
16 IL 0,45	0.45	16	0.7	0.4	238	638
16 IL 0,5	0.50	16	0.6	0.6	240	640
16 IL 0,7	0.70	16	0.6	0.6	241	641
16 IL 0,75	0.75	16	0.6	0.6	242	642
16 IL 0,8	0.80	16	0.6	0.6	243	643
16 IL 1,0	1.00	16	0.7	0.7	244	644
16 IL 1,25	1.25	16	0.8	0.9	246	646
16 IL 1,5	1.50	16	0.8	1.0	248	648
16 IL 1,75	1.75	16	0.9	1.2	250	650
16 IL 2,0	2.00	16	1.0	1.3	252	652
16 IL 2,5	2.50	16	1.1	1.5	254	654
16 IL 3,0	3.00	16	1.2	1.6	256	656
P					●	
M					●	○
K					●	●
N						●
S					○	○
H					○	
O						

→ v_c Page 72

Right hand external thread turning insert

▲ Full profile

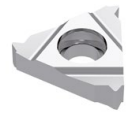
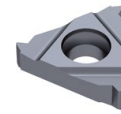
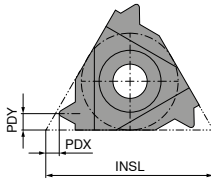
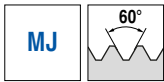

Designation	TP mm	INSL mm	PDX mm	PDY mm
11 ER 1,0	1.00	11	0.7	0.8
11 ER 1,25	1.25	11	0.8	0.9
11 ER 1,5	1.50	11	0.8	1.0
11 ER 2,0	2.00	11	0.9	1.0
16 ER 1,0	1.00	16	0.7	0.8
16 ER 1,25	1.25	16	0.8	0.9
16 ER 1,5	1.50	16	0.8	1.0
16 ER 2,0	2.00	16	1.0	1.3

	ER 71 286 ...	ER 71 286 ...
P	●	●
M	●	○
K	●	●
N	●	●
S	○	○
H	○	○
O		

→ v_c Page 72

Left hand external thread turning insert

▲ Full profile

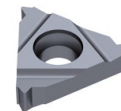
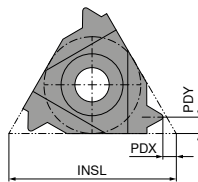

Designation	TP mm	INSL mm	PDX mm	PDY mm
11 EL 1,0	1.00	11	0.7	0.8
11 EL 1,25	1.25	11	0.8	0.9
11 EL 1,5	1.50	11	0.8	1.0
11 EL 2,0	2.00	11	0.9	1.0
16 EL 1,0	1.00	16	0.7	0.8
16 EL 1,25	1.25	16	0.8	0.9
16 EL 1,5	1.50	16	0.8	1.0
16 EL 2,0	2.00	16	1.0	1.3

	EL 71 287 ...	EL 71 287 ...
P	●	●
M	●	○
K	●	●
N	●	●
S	○	○
H	○	○
O		

→ v_c Page 72

Right hand internal thread turning insert

▲ Full profile

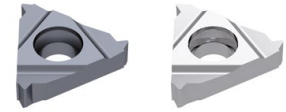
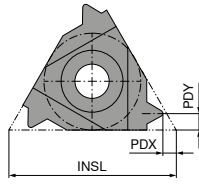
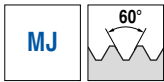

Designation	TP mm	INSL mm	PDX mm	PDY mm
11 IR 1,0	1.00	11	0.7	0.8
11 IR 1,25	1.25	11	0.8	0.9
11 IR 1,5	1.50	11	0.8	1.0
11 IR 2,0	2.00	11	0.9	1.0
16 IR 1,0	1.00	16	0.7	0.8
16 IR 1,25	1.25	16	0.8	0.9
16 IR 1,5	1.50	16	0.8	1.0
16 IR 2,0	2.00	16	1.0	1.3

	IR 71 284 ...	IR 71 284 ...
P	●	●
M	●	○
K	●	●
N	●	●
S	○	○
H	○	○
O		

→ v_c Page 72

Left hand internal thread turning insert

▲ Full profile

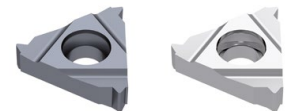
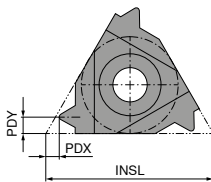

Designation	TP mm	INSL mm	PDX mm	PDY mm
11 IL 1,0	1.00	11	0.7	0.8
11 IL 1,25	1.25	11	0.8	0.9
11 IL 1,5	1.50	11	0.8	1.0
11 IL 2,0	2.00	11	0.9	1.0
16 IL 1,0	1.00	16	0.7	0.8
16 IL 1,25	1.25	16	0.8	0.9
16 IL 1,5	1.50	16	0.8	1.0
16 IL 2,0	2.00	16	1.0	1.3

	IL 71 285 ...	IL 71 285 ...
P	●	●
M	●	○
K	●	●
N	●	●
S	○	○
H	○	○
O		

→ v_c Page 72

Right hand external thread turning insert

▲ Full profile

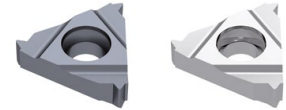
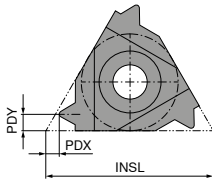

Designation	TPI 1/''	INSL mm	PDX mm	PDY mm	ER	
					71 228 ...	71 228 ...
11 ER 72	72	11	0.7	0.4	202	602
11 ER 60	60	11	0.7	0.4	204	604
11 ER 56	56	11	0.7	0.4	206	606
11 ER 48	48	11	0.6	0.6	208	608
11 ER 40	40	11	0.6	0.6	210	610
11 ER 36	36	11	0.6	0.6	212	612
11 ER 32	32	11	0.6	0.6	214	614
11 ER 28	28	11	0.6	0.7	216	616
11 ER 26	26	11	0.7	0.8	218	618
11 ER 24	24	11	0.7	0.8	220	620
11 ER 22	22	11	0.8	0.9	222	622
11 ER 20	20	11	0.8	0.9	224	624
11 ER 19	19	11	0.8	1.0	226	626
11 ER 18	18	11	0.8	1.0	228	628
11 ER 16	16	11	0.9	1.1	230	630
11 ER 14	14	11	0.9	1.1	232	632
16 ER 40	40	16	0.6	0.6	240	640
16 ER 36	36	16	0.6	0.6	242	642
16 ER 32	32	16	0.6	0.6	244	644
16 ER 28	28	16	0.6	0.7	246	646
16 ER 26	26	16	0.7	0.8	248	648
16 ER 24	24	16	0.7	0.8	250	650
16 ER 22	22	16	0.8	0.9	252	652
16 ER 20	20	16	0.8	0.9	254	654
16 ER 19	19	16	0.8	1.0	256	656
16 ER 18	18	16	0.8	1.0	258	658
16 ER 16	16	16	0.9	1.1	260	660
16 ER 14	14	16	1.0	1.2	262	662
16 ER 12	12	16	1.1	1.4	264	664
16 ER 11	11	16	1.1	1.5	266	666
16 ER 10	10	16	1.1	1.5	268	668
16 ER 9	9	16	1.2	1.7	270	670
16 ER 8	8	16	1.2	1.5	272	672
P					●	
M					●	○
K					●	●
N						●
S					○	○
H					○	
O						

→ v_c Page 72

Left hand external thread turning insert

▲ Full profile

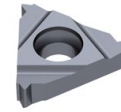
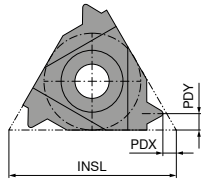

Designation	TPI 1/''	INSL mm	PDX mm	PDY mm	EL	
					71 229 ...	71 229 ...
11 EL 72	72	11	0.7	0.4	202	602
11 EL 60	60	11	0.7	0.4	204	604
11 EL 56	56	11	0.7	0.4	206	606
11 EL 48	48	11	0.6	0.6	208	608
11 EL 40	40	11	0.6	0.6	210	610
11 EL 36	36	11	0.6	0.6	212	612
11 EL 32	32	11	0.6	0.6	214	614
11 EL 28	28	11	0.6	0.7	216	616
11 EL 26	26	11	0.7	0.8	218	618
11 EL 24	24	11	0.7	0.8	220	620
11 EL 22	22	11	0.8	0.9	222	622
11 EL 20	20	11	0.8	0.9	224	624
11 EL 19	19	11	0.8	1.0	226	626
11 EL 18	18	11	0.8	1.0	228	628
11 EL 16	16	11	0.9	1.1	230	630
11 EL 14	14	11	0.9	1.1	232	632
16 EL 40	40	16	0.6	0.6	240	640
16 EL 36	36	16	0.6	0.6	242	642
16 EL 32	32	16	0.6	0.6	244	644
16 EL 28	28	16	0.6	0.7	246	646
16 EL 26	26	16	0.7	0.8	248	648
16 EL 24	24	16	0.7	0.8	250	650
16 EL 22	22	16	0.8	0.9	252	652
16 EL 20	20	16	0.8	0.9	254	654
16 EL 19	19	16	0.8	1.0	256	656
16 EL 18	18	16	0.8	1.0	258	658
16 EL 16	16	16	0.9	1.1	260	660
16 EL 14	14	16	1.0	1.2	262	662
16 EL 12	12	16	1.1	1.4	264	664
16 EL 11	11	16	1.1	1.5	266	666
16 EL 10	10	16	1.1	1.5	268	668
16 EL 9	9	16	1.2	1.7	270	670
16 EL 8	8	16	1.2	1.5	272	672
P					●	
M					●	○
K					●	●
N						●
S					○	○
H					○	
O						

→ v_c Page 72

Right hand internal thread turning insert

▲ Full profile

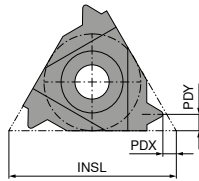

Designation	TPI 1/''	INSL mm	PDX mm	PDY mm	IR	
					71 230 ...	71 230 ...
11 IR 48	48	11	0.6	0.6	206	606
11 IR 40	40	11	0.6	0.6	208	608
11 IR 36	36	11	0.6	0.6	210	610
11 IR 32	32	11	0.6	0.6	212	612
11 IR 28	28	11	0.6	0.7	214	614
11 IR 26	26	11	0.7	0.8	216	616
11 IR 24	24	11	0.7	0.8	218	618
11 IR 22	22	11	0.8	0.9	220	620
11 IR 20	20	11	0.8	0.9	222	622
11 IR 19	19	11	0.8	1.0	224	624
11 IR 18	18	11	0.8	1.0	226	626
11 IR 16	16	11	0.9	1.1	228	628
11 IR 14	14	11	0.9	1.1	230	630
16 IR 40	40	16	0.6	0.6	240	640
16 IR 36	36	16	0.6	0.6	242	642
16 IR 32	32	16	0.6	0.6	244	644
16 IR 28	28	16	0.6	0.7	246	646
16 IR 26	26	16	0.7	0.8	248	648
16 IR 24	24	16	0.7	0.8	250	650
16 IR 22	22	16	0.8	0.9	252	652
16 IR 20	20	16	0.8	0.9	254	654
16 IR 19	19	16	0.8	1.0	256	656
16 IR 18	18	16	0.8	1.0	258	658
16 IR 16	16	16	0.9	1.1	260	660
16 IR 14	14	16	1.0	1.2	262	662
16 IR 12	12	16	1.1	1.4	264	664
16 IR 11	11	16	1.1	1.5	266	666
16 IR 10	10	16	1.1	1.5	268	668
16 IR 9	9	16	1.2	1.7	270	670
16 IR 8	8	16	1.2	1.5	272	672
P					●	
M					●	○
K					●	●
N						●
S					○	○
H					○	
O						

→ v_c Page 72

2

Left hand internal thread turning insert

▲ Full profile

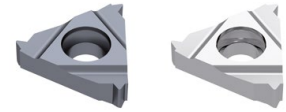
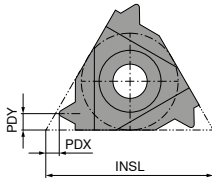

Designation	TPI 1/''	INSL mm	PDX mm	PDY mm	IL	
					71 231 ...	71 231 ...
11 IL 48	48	11	0.6	0.6	206	606
11 IL 40	40	11	0.6	0.6	208	608
11 IL 36	36	11	0.6	0.6	210	610
11 IL 32	32	11	0.6	0.6	212	612
11 IL 28	28	11	0.6	0.7	214	614
11 IL 26	26	11	0.7	0.8	216	616
11 IL 24	24	11	0.7	0.8	218	618
11 IL 22	22	11	0.8	0.9	220	620
11 IL 20	20	11	0.8	0.9	222	622
11 IL 19	19	11	0.8	1.0	224	624
11 IL 18	18	11	0.8	1.0	226	626
11 IL 16	16	11	0.9	1.1	228	628
11 IL 14	14	11	0.9	1.1	230	630
16 IL 40	40	16	0.6	0.6	240	640
16 IL 36	36	16	0.6	0.6	242	642
16 IL 32	32	16	0.6	0.6	244	644
16 IL 28	28	16	0.6	0.7	246	646
16 IL 26	26	16	0.7	0.8	248	648
16 IL 24	24	16	0.7	0.8	250	650
16 IL 22	22	16	0.8	0.9	252	652
16 IL 20	20	16	0.8	0.9	254	654
16 IL 19	19	16	0.8	1.0	256	656
16 IL 18	18	16	0.8	1.0	258	658
16 IL 16	16	16	0.9	1.1	260	660
16 IL 14	14	16	1.0	1.2	262	662
16 IL 12	12	16	1.1	1.4	264	664
16 IL 11	11	16	1.1	1.5	266	666
16 IL 10	10	16	1.1	1.5	268	668
16 IL 9	9	16	1.2	1.7	270	670
16 IL 8	8	16	1.2	1.5	272	672
P					●	
M					●	○
K					●	●
N						●
S					○	○
H					○	
O						

→ v_c Page 72

Right hand external thread turning insert

▲ Full profile

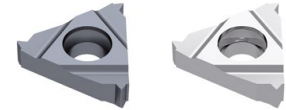
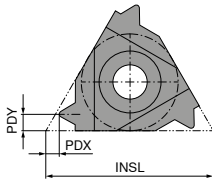

Designation	TPI 1/''	INSL mm	PDX mm	PDY mm	ER	
					71 264 ...	71 264 ...
11 ER 72	72.0	11	0.8	0.4	202	602
11 ER 64	64.0	11	0.8	0.4	204	604
11 ER 56	56.0	11	0.7	0.4	206	606
11 ER 48	48.0	11	0.6	0.6	208	608
11 ER 44	44.0	11	0.6	0.6	210	610
11 ER 40	40.0	11	0.6	0.6	212	612
11 ER 36	36.0	11	0.6	0.6	214	614
11 ER 32	32.0	11	0.6	0.6	216	616
11 ER 28	28.0	11	0.6	0.7	218	618
11 ER 27	27.0	11	0.7	0.8	220	620
11 ER 24	24.0	11	0.7	0.8	222	622
11 ER 20	20.0	11	0.8	0.9	224	624
11 ER 18	18.0	11	0.8	1.0	226	626
11 ER 16	16.0	11	0.9	1.1	228	628
11 ER 14	14.0	11	0.9	1.1	230	630
16 ER 72	72.0	16	0.8	0.4	232	632
16 ER 64	64.0	16	0.8	0.4	234	634
16 ER 56	56.0	16	0.7	0.4	236	636
16 ER 48	48.0	16	0.6	0.6	238	638
16 ER 44	44.0	16	0.6	0.6	240	640
16 ER 40	40.0	16	0.6	0.6	242	642
16 ER 36	36.0	16	0.6	0.6	244	644
16 ER 32	32.0	16	0.6	0.6	246	646
16 ER 28	28.0	16	0.6	0.7	248	648
16 ER 27	27.0	16	0.7	0.8	250	650
16 ER 24	24.0	16	0.7	0.8	252	652
16 ER 20	20.0	16	0.8	0.9	254	654
16 ER 18	18.0	16	0.8	1.0	256	656
16 ER 16	16.0	16	0.9	1.1	258	658
16 ER 14	14.0	16	1.0	1.2	260	660
16 ER 13	13.0	16	1.0	1.3	262	662
16 ER 12	12.0	16	1.1	1.4	264	664
16 ER 11,5	11.5	16	1.1	1.5	266	666
16 ER 11	11.0	16	1.1	1.5	268	668
16 ER 10	10.0	16	1.1	1.5	270	670
16 ER 9	9.0	16	1.2	1.7	272	672
16 ER 8	8.0	16	1.2	1.6	274	674

P	●	
M	●	○
K	●	●
N		●
S	○	○
H	○	
O		

→ v_c Page 72

Left hand external thread turning insert

▲ Full profile

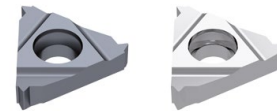
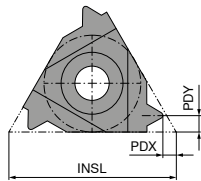

Designation	TPI 1/''	INSL mm	PDX mm	PDY mm	EL	
					71 266 ...	71 266 ...
11 EL 72	72.0	11	0.8	0.4	202	602
11 EL 64	64.0	11	0.8	0.4	204	604
11 EL 56	56.0	11	0.7	0.4	206	606
11 EL 48	48.0	11	0.6	0.6	208	608
11 EL 44	44.0	11	0.6	0.6	210	610
11 EL 40	40.0	11	0.6	0.6	212	612
11 EL 36	36.0	11	0.6	0.6	214	614
11 EL 32	32.0	11	0.6	0.6	216	616
11 EL 28	28.0	11	0.6	0.7	218	618
11 EL 27	27.0	11	0.7	0.8	220	620
11 EL 24	24.0	11	0.7	0.8	222	622
11 EL 20	20.0	11	0.8	0.9	224	624
11 EL 18	18.0	11	0.8	1.0	226	626
11 EL 16	16.0	11	0.9	1.1	228	628
11 EL 14	14.0	11	0.9	1.1	230	630
16 EL 72	72.0	16	0.8	0.4	232	632
16 EL 64	64.0	16	0.8	0.4	234	634
16 EL 56	56.0	16	0.7	0.4	236	636
16 EL 48	48.0	16	0.6	0.6	238	638
16 EL 44	44.0	16	0.6	0.6	240	640
16 EL 40	40.0	16	0.6	0.6	242	642
16 EL 36	36.0	16	0.6	0.6	244	644
16 EL 32	32.0	16	0.6	0.6	246	646
16 EL 28	28.0	16	0.6	0.7	248	648
16 EL 27	27.0	16	0.7	0.8	250	650
16 EL 24	24.0	16	0.7	0.8	252	652
16 EL 20	20.0	16	0.8	0.9	254	654
16 EL 18	18.0	16	0.8	1.0	256	656
16 EL 16	16.0	16	0.9	1.1	258	658
16 EL 14	14.0	16	1.0	1.2	260	660
16 EL 13	13.0	16	1.0	1.3	262	662
16 EL 12	12.0	16	1.1	1.4	264	664
16 EL 11,5	11.5	16	1.1	1.5	266	666
16 EL 11	11.0	16	1.1	1.5	268	668
16 EL 10	10.0	16	1.1	1.5	270	670
16 EL 9	9.0	16	1.2	1.7	272	672
16 EL 8	8.0	16	1.2	1.6	274	674
P					●	
M					●	○
K					●	●
N						●
S					○	○
H					○	
O						

→ v_c Page 72

Right hand internal thread turning insert

▲ Full profile

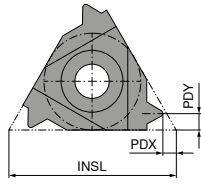

Designation	TPI 1/''	INSL mm	PDX mm	PDY mm	IR	
					71 268 ...	71 268 ...
11 IR 72	72.0	11	0.8	0.3	202	602
11 IR 64	64.0	11	0.8	0.4	204	604
11 IR 56	56.0	11	0.7	0.4	206	606
11 IR 48	48.0	11	0.6	0.6	208	608
11 IR 44	44.0	11	0.6	0.6	210	610
11 IR 40	40.0	11	0.6	0.6	212	612
11 IR 36	36.0	11	0.6	0.6	214	614
11 IR 32	32.0	11	0.6	0.6	216	616
11 IR 28	28.0	11	0.6	0.7	218	618
11 IR 27	27.0	11	0.7	0.8	220	620
11 IR 24	24.0	11	0.7	0.8	222	622
11 IR 20	20.0	11	0.8	0.9	224	624
11 IR 18	18.0	11	0.8	1.0	226	626
11 IR 16	16.0	11	0.9	1.1	228	628
11 IR 14	14.0	11	1.0	1.1	230	630
16 IR 72	72.0	16	0.8	0.3	232	632
16 IR 64	64.0	16	0.8	0.4	234	634
16 IR 56	56.0	16	0.7	0.4	236	636
16 IR 48	48.0	16	0.6	0.6	238	638
16 IR 44	44.0	16	0.6	0.6	240	640
16 IR 40	40.0	16	0.6	0.6	242	642
16 IR 36	36.0	16	0.6	0.6	244	644
16 IR 32	32.0	16	0.6	0.6	246	646
16 IR 28	28.0	16	0.6	0.7	248	648
16 IR 27	27.0	16	0.7	0.8	250	650
16 IR 24	24.0	16	0.7	0.8	252	652
16 IR 20	20.0	16	0.8	0.9	254	654
16 IR 18	18.0	16	0.8	1.0	256	656
16 IR 16	16.0	16	0.9	1.1	258	658
16 IR 14	14.0	16	1.0	1.2	260	660
16 IR 13	13.0	16	1.0	1.3	262	662
16 IR 12	12.0	16	1.1	1.4	264	664
16 IR 11,5	11.5	16	1.1	1.5	266	666
16 IR 11	11.0	16	1.1	1.5	268	668
16 IR 10	10.0	16	1.1	1.5	270	670
16 IR 9	9.0	16	1.2	1.7	272	672
16 IR 8	8.0	16	1.2	1.6	274	674
P					●	
M					●	○
K					●	●
N						●
S					○	○
H					○	
O						

→ v_c Page 72

Left hand internal thread turning insert

▲ Full profile

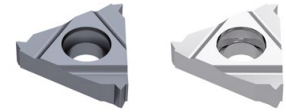
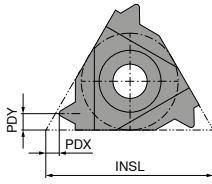

Designation	TPI 1/''	INSL mm	PDX mm	PDY mm	IL	
					71 270 ...	71 270 ...
11 IL 72	72.0	11	0.8	0.3	202	602
11 IL 64	64.0	11	0.8	0.4	204	604
11 IL 56	56.0	11	0.7	0.4	206	606
11 IL 48	48.0	11	0.6	0.6	208	608
11 IL 44	44.0	11	0.6	0.6	210	610
11 IL 40	40.0	11	0.6	0.6	212	612
11 IL 36	36.0	11	0.6	0.6	214	614
11 IL 32	32.0	11	0.6	0.6	216	616
11 IL 28	28.0	11	0.6	0.7	218	618
11 IL 27	27.0	11	0.7	0.8	220	620
11 IL 24	24.0	11	0.7	0.8	222	622
11 IL 20	20.0	11	0.8	0.9	224	624
11 IL 18	18.0	11	0.8	1.0	226	626
11 IL 16	16.0	11	0.9	1.1	228	628
11 IL 14	14.0	11	0.9	1.1	230	630
16 IL 72	72.0	16	0.8	0.3	232	632
16 IL 64	64.0	16	0.8	0.4	234	634
16 IL 56	56.0	16	0.7	0.4	236	636
16 IL 48	48.0	16	0.6	0.6	238	638
16 IL 44	44.0	16	0.6	0.6	240	640
16 IL 40	40.0	16	0.6	0.6	242	642
16 IL 36	36.0	16	0.6	0.6	244	644
16 IL 32	32.0	16	0.6	0.6	246	646
16 IL 28	28.0	16	0.6	0.7	248	648
16 IL 27	27.0	16	0.7	0.8	250	650
16 IL 24	24.0	16	0.7	0.8	252	652
16 IL 20	20.0	16	0.8	0.9	254	654
16 IL 18	18.0	16	0.8	1.0	256	656
16 IL 16	16.0	16	0.9	1.1	258	658
16 IL 14	14.0	16	1.0	1.2	260	660
16 IL 13	13.0	16	1.0	1.3	262	662
16 IL 12	12.0	16	1.1	1.4	264	664
16 IL 11,5	11.5	16	1.1	1.5	266	666
16 IL 11	11.0	16	1.1	1.5	268	668
16 IL 10	10.0	16	1.1	1.5	270	670
16 IL 9	9.0	16	1.2	1.7	272	672
16 IL 8	8.0	16	1.2	1.6	274	674
P					●	
M					●	○
K					●	●
N						●
S					○	○
H					○	
O						

→ v_c Page 72

Right hand external thread turning insert

▲ Partial profile

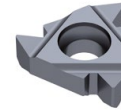
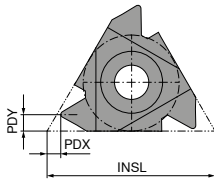

Designation	TP mm	INSL mm	PDX mm	PDY mm
16 ER A60	0,5 - 1,5	16	0.8	0.9
16 ER G60	1,75 - 3	16	1.2	1.7
16 ER AG60	0,5 - 3	16	1.2	1.7

	ER 71 206 ...	ER 71 206 ...
P	●	
M	●	○
K	●	●
N		●
S	○	○
H	○	
O		

ER 71 206 ...	ER 71 206 ...
240	640
242	642
244	644

→ v_c Page 72

Left hand external thread turning insert

▲ Partial profile

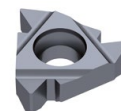
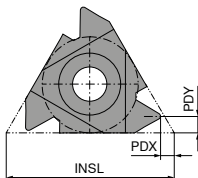

Designation	TP mm	INSL mm	PDX mm	PDY mm
16 EL A60	0,5 - 1,5	16	0.8	0.9
16 EL G60	1,75 - 3	16	1.2	1.7
16 EL AG60	0,5 - 3	16	1.2	1.7

	EL 71 208 ...	EL 71 208 ...
P	●	
M	●	○
K	●	●
N		●
S	○	○
H	○	
O		

EL 71 208 ...	EL 71 208 ...
240	640
242	642
244	644

→ v_c Page 72

Right hand internal thread turning insert

▲ Partial profile

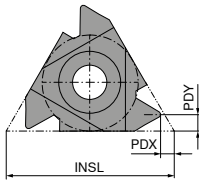

Designation	TP mm	INSL mm	PDX mm	PDY mm
11 IR A60	0,5 - 1,5	11	0.8	0.9
16 IR A60	0,5 - 1,5	16	0.8	0.9
16 IR G60	1,75 - 3	16	1.2	1.7
16 IR AG60	0,5 - 3	16	1.2	1.7

	IR 71 210 ...	IR 71 210 ...
P	●	●
M	●	○
K	●	●
N	●	●
S	○	○
H	○	○
O		

→ v_c Page 72

Left hand internal thread turning insert

▲ Partial profile

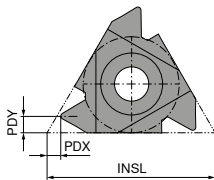

Designation	TP mm	INSL mm	PDX mm	PDY mm
11 IL A60	0,5 - 1,5	11	0.8	0.9
16 IL A60	0,5 - 1,5	16	0.8	0.9
16 IL G60	1,75 - 3	16	1.2	1.7
16 IL AG60	0,5 - 3	16	1.2	1.7

	IL 71 212 ...	IL 71 212 ...
P	●	●
M	●	○
K	●	●
N	●	●
S	○	○
H	○	○
O		

→ v_c Page 72

Right hand external thread turning insert

▲ Partial profile

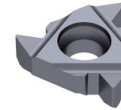
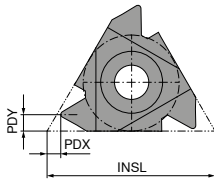

Designation	TPI 1/''	INSL mm	PDX mm	PDY mm
16 ER A55	48 - 16	16	0.8	0.9
16 ER G55	14 - 8	16	1.2	1.7
16 ER AG55	48 - 8	16	1.2	1.7

	ER 71 200 ...	ER 71 200 ...
P	●	●
M	●	○
K	●	●
N	●	●
S	○	○
H	○	○
O	○	○

ER 71 200 ...	ER 71 200 ...
240	640
242	642
244	644

→ v_c Page 72

Left hand external thread turning insert

▲ Partial profile

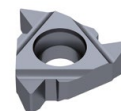
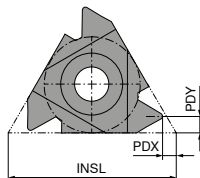

Designation	TPI 1/''	INSL mm	PDX mm	PDY mm
16 EL A55	48 - 16	16	0.8	0.9
16 EL AG55	48 - 8	16	1.2	1.7
16 EL G55	14 - 8	16	1.2	1.7

	EL 71 202 ...	EL 71 202 ...
P	●	●
M	●	○
K	●	●
N	●	●
S	○	○
H	○	○
O	○	○

EL 71 202 ...	EL 71 202 ...
240	640
244	644
242	642

→ v_c Page 72

Right hand internal thread turning insert

▲ Partial profile

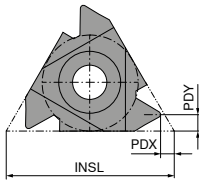

Designation	TPI 1/''	INSL mm	PDX mm	PDY mm
11 IR A55	48 - 16	11	0.8	0.9
16 IR A55	48 - 16	16	0.8	0.9
16 IR AG55	48 - 8	16	1.2	1.7
16 IR G55	14 - 8	16	1.2	1.7

	IR 71 204 ...	IR 71 204 ...
P	●	●
M	●	○
K	●	●
N	●	●
S	○	○
H	○	○
O		

→ v_c Page 72

Left hand internal thread turning insert

▲ Partial profile

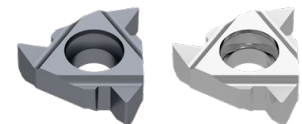
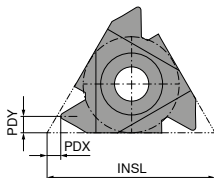

Designation	TPI 1/''	INSL mm	PDX mm	PDY mm
11 IL A55	48 - 16	11	0.8	0.9
16 IL A55	48 - 16	16	0.8	0.9
16 IL AG55	48 - 8	16	1.2	1.7
16 IL G55	14 - 8	16	1.2	1.7

	IL 71 203 ...	IL 71 203 ...
P	●	●
M	●	○
K	●	●
N	●	●
S	○	○
H	○	○
O		

→ v_c Page 72

Standard External Thread Turning Holder

▲ Tool Holder with Approach Angle $\beta = 1,5^\circ$

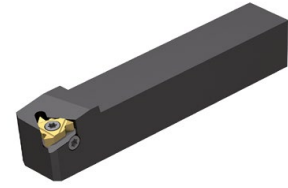
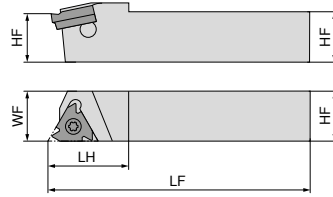

Illustrations show right-hand versions

Designation	HF mm	WF mm	LF mm	LH mm	Insert	torque moment Nm	Left-hand	Right-hand
							71 281 ...	71 280 ...
SE R/L 08 08 H11	8	11	100	16	11 ..	1,3	908 ¹⁾	908 ¹⁾
SE R/L 10 10 H11	10	12	100	18	11 ..	1,3	910 ¹⁾	910 ¹⁾
SE R/L 12 12 K11	12	12	125	20	11 ..	1,3	912 ¹⁾	912 ¹⁾
SE R/L 12 12 F16	12	16	80	22	16 ..	3,5	012	012
SE R/L 16 16 H16	16	16	100	25	16 ..	3,5	016	016
SE R/L 20 20 K16	20	20	125	30	16 ..	3,5	020	020
SE R/L 25 25 M16	25	25	150	30	16 ..	3,5	025	025
SE R/L 32 32 P16	32	32	170	30	16 ..	3,5	032	032

1) without shim

Spare parts for Article no.	Shim		Screw-U		Key D		Clamping screw	
	71 950 ...	71 950 ...	80 950 ...	71 950 ...	71 950 ...	71 950 ...	71 950 ...	
71 280 908 / 71 281 908					T08	110	230	
71 280 910 / 71 281 910					T08	110	230	
71 280 912 / 71 281 912					T08	110	230	
71 280 012	ER 16 / IL 16	121	234	T10	112	231		
71 281 012	EL 16 / IR 16	129	234	T10	112	231		
71 280 016	ER 16 / IL 16	121	234	T10	112	231		
71 281 016	EL 16 / IR 16	129	234	T10	112	231		
71 280 020	ER 16 / IL 16	121	234	T10	112	231		
71 281 020	EL 16 / IR 16	129	234	T10	112	231		
71 280 025	ER 16 / IL 16	121	234	T10	112	231		
71 281 025	EL 16 / IR 16	129	234	T10	112	231		
71 280 032	ER 16 / IL 16	121	234	T10	112	231		
71 281 032	EL 16 / IR 16	129	234	T10	112	231		

Shims for correction of helix angle see page → Page 70.

Standard Internal Thread Turning Holder

▲ Tool Holder with Approach Angle $\beta = 1,5^\circ$

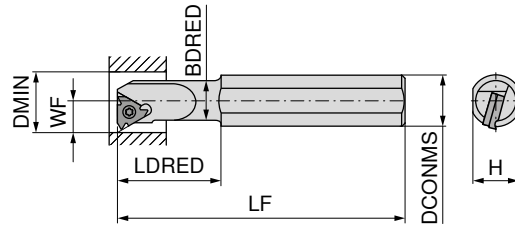

Illustrations show right-hand versions



Designation	H mm	LF mm	LDRED mm	DCONMS mm	BDRED mm	WF mm	DMIN mm	Insert	torque moment Nm	Left-hand	Right-hand
										71 283 ...	71 282 ...
SI R 0010 H11	9.0	100	25	10	9.5	7.4	12	11 ..	1,3		011 ¹⁾
SI R/L 0010 K11	14.0	125	25	16	10.0	7.4	12	11 ..	1,3	010 ¹⁾	010 ¹⁾
SI R 0013 L11	14.0	140	32	16	12.0	8.9	15	11 ..	1,3		013 ¹⁾
SI R/L 0013 M16	14.0	150	32	16	13.0	10.2	16	16 ..	3,5	015 ¹⁾	015 ¹⁾
SI R/L 0016 P16	18.0	170	40	20	15.0	11.7	19	16 ..	3,5	016 ¹⁾	016 ¹⁾
SI R/L 0020 P16	18.0	170	40	20	19.5	13.7	24	16 ..	3,5	020	020
SI R 0025 R16	22.6	200	40	25	24.5	16.2	29	16 ..	3,5		026
SI R/L 0032 S16	28.8	250	50	32	31.5	19.7	36	16 ..	3,5	032	032
SI R 0040 T16	36.0	300	50	40	39.5	23.7	44	16 ..	3,5		040

1) without shim

Spare parts for Article no.	Shim	Screw-U	Key D	Clamping screw		
	71 950 ...	71 950 ...	80 950 ...	71 950 ...		
71 282 011			T08	110	230	
71 282 010 / 71 283 010			T08	110	230	
71 282 013			T08	110	230	
71 282 015 / 71 283 015			T10	112	236	
71 282 016 / 71 283 016			T10	112	236	
71 282 020	EL 16 / IR 16	129	234	T10	112	231
71 283 020	ER 16 / IL 16	121	234	T10	112	231
71 282 026	EL 16 / IR 16	129	234	T10	112	231
71 282 032	EL 16 / IR 16	129	234	T10	112	231
71 283 032	ER 16 / IL 16	121	234	T10	112	231
71 282 040	EL 16 / IR 16	129	234	T10	112	231

Shims for correction of helix angle see page → Page 70.

Standard Internal Thread Turning Holder with thro' coolant

▲ Tool Holder with Approach Angle $\beta = 1,5^\circ$

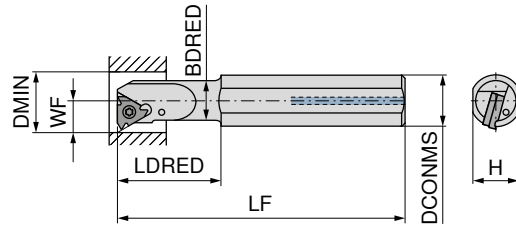

Illustrations show right-hand versions



Designation	H mm	LF mm	LDRED mm	DCONMS mm	BDRED mm	WF mm	DMIN mm	Insert	torque moment Nm	Left-hand	Right-hand
										71 283 ...	71 282 ...
SI R 0010 M11CB	9.0	150	25	10	9.5	7.4	12	11 ..	1,3		510 ²⁾
SI R 0012 P11CB	11.0	170	30	12	11.5	8.4	15	11 ..	1,3		512 ²⁾
SI R/L 0010 K11B	14.0	125	25	16	10.0	7.4	12	11 ..	1,3	310	310
SI R/L 0013 M16B	14.0	150	32	16	13.0	10.2	16	16 ..	3,5	315	315
SI R 0016 P16B	18.0	170	40	20	16.0	11.7	19	16 ..	3,5		316
SI R 0020 P16B	18.0	170	40	20	19.5	13.7	24	16 ..	3,5		320 ¹⁾
SI R/L 0032 S16B	28.8	250	50	32	31.5	19.7	36	16 ..	3,5	332 ¹⁾	332 ¹⁾

- 1) with shim seat
- 2) Carbide version

Spare parts for Article no.	Shim	Screw-U	Key D	Clamping screw		
	71 950 ...	71 950 ...	80 950 ...	71 950 ...		
71 282 510			T08	110	230	
71 282 512			T08	110	230	
71 282 310 / 71 283 310			T08	110	230	
71 282 315 / 71 283 315			T10	112	236	
71 282 316			T10	112	236	
71 282 320	EL 16 / IR 16	129	234	T10	112	231
71 282 332	EL 16 / IR 16	129	234	T10	112	231
71 283 332	ER 16 / IL 16	121	234	T10	112	231

1) Shims for correction of helix angle see page → Page 70.

Right hand internal thread turning insert – Mini size 06

- ▲ Full profile
- ▲ Thread production from diameter 6 mm

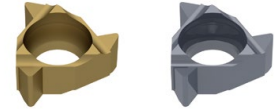
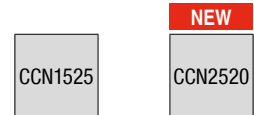
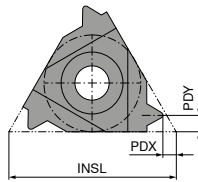

Designation	TP mm	PDX mm	PDY mm	INSL mm	IR	
					71 271 ...	71 224 ...
06 IR 0,5	0.50	0.9	0.5	6	110	35700
06 IR 0,75	0.75	0.8	0.5	6	112	36100
06 IR 1,0	1.00	0.7	0.6	6	114	36500
06 IR 1,25	1.25	0.6	0.6	6	116	36700
P					●	○
M					●	●
K					●	○
N					○	
S						●
H						○
O					○	

→ v_c Page 72

Right hand internal thread turning insert – Mini size 06

- ▲ Full profile
- ▲ Thread production from diameter 6 mm

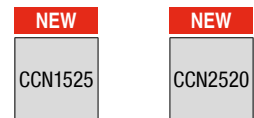
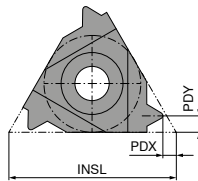

Designation	TPI 1/''	PDX mm	PDY mm	INSL mm	IR	
					71 230 ...	71 230 ...
06 IR 26	26	0.7	0.6	6	13500	33500
06 IR 22	22	0.6	0.6	6	13100	33100
06 IR 20	20	0.6	0.7	6	12900	32900
06 IR 18	18	0.6	0.7	6	12500	32500
P					●	○
M					●	●
K					●	○
N					○	
S						●
H						○
O					○	

→ v_c Page 72

Right hand internal thread turning insert – Mini size 06

- ▲ Partial profile
- ▲ Thread production from diameter 6 mm

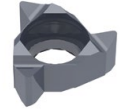
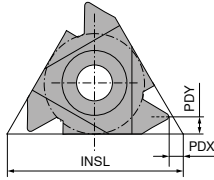

Designation	TP mm	INSL mm	PDX mm	PDY mm
06 IR A60	0,5 - 1,25	6	0.6	0.6

	IR 71 274 ...	IR 71 272 ...
P	●	○
M	●	●
K	●	○
N	○	○
S	○	●
H	○	○
O	○	○

IR	IR
71 274 ...	71 272 ...
210	30000

→ v_c Page 72

Right hand internal thread turning insert – Mini size 06

- ▲ Partial profile
- ▲ Thread production from diameter 6 mm

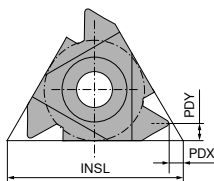

Designation	TPI 1/"	INSL mm	PDX mm	PDY mm
06 IR A55	48 - 20	6	0.5	0.6

	IR 71 272 ...	IR 71 272 ...
P	●	○
M	●	●
K	●	○
N	○	○
S	○	●
H	○	○
O	○	○

IR	IR
71 272 ...	71 272 ...
10100	30100

→ v_c Page 72

Right hand internal thread turning insert – Mini size 08

- ▲ Full profile
- ▲ Thread production from diameter 8 mm

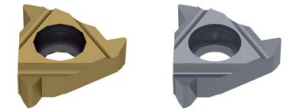
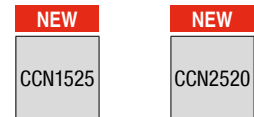
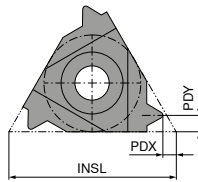

Designation	TP mm	PDX mm	PDY mm	INSL mm
08 IR 0,5	0.50	0.6	0.5	8
08 IR 0,75	0.75	0.6	0.5	8
08 IR 1,0	1.00	0.6	0.6	8
08 IR 1,25	1.25	0.6	0.7	8
08 IR 1,5	1.50	0.6	0.7	8
08 IR 1,75	1.75	0.6	0.8	8
08 IN 2,0	2.00	0.9	4.0	8

IR	IR
71 224 ...	71 224 ...
14300	34300
13700	33700
13300	33300
13100	33100
12900	32900
12700	32700
12500 ¹⁾	32500 ¹⁾

P	●	○
M	●	●
K	●	○
N	○	○
S		●
H		○
O	○	

1) Neutral version (N)

→ v_c Page 72

Neutral internal thread turning insert – Mini size 08

- ▲ Partial profile
- ▲ Thread production from diameter 8 mm

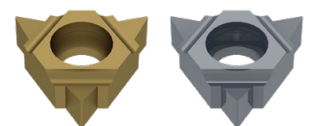
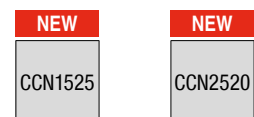
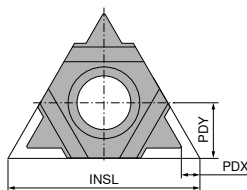

Designation	TP mm	INSL mm	PDX mm	PDY mm
08 IN M60	1,75 - 2,0	8	0.8	4

IN	IN
71 273 ...	71 273 ...
10800	30800

P	●	○
M	●	●
K	●	○
N	○	○
S		●
H		○
O	○	

→ v_c Page 72

Right hand internal thread turning insert – Mini size 08

- ▲ Partial profile
- ▲ Thread production from diameter 8 mm

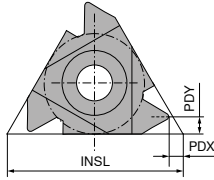

Designation	TP mm	PDX mm	PDY mm	INSL mm
08 IR A60	0,5 - 1,25	0.6	0.6	8
08 IR A60	0,5 - 1,5	0.6	0.7	8

	IR 71 272 ...	IR 71 272 ...
P	●	○
M	●	●
K	●	○
N	○	○
S		●
H		○
O	○	

	IR 71 272 ...	IR 71 272 ...
	10600	30600

→ v_c Page 72

Neutral internal thread turning insert – Mini size 08

- ▲ Partial profile
- ▲ Thread production from diameter 8 mm

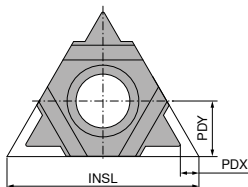

Designation	TPI 1/''	INSL mm	PDX mm	PDY mm
08 IN M55	14 - 11	8	0.9	4

	IN 71 273 ...	IN 71 273 ...
P	●	○
M	●	●
K	●	○
N	○	○
S		●
H		○
O	○	

	IN 71 273 ...	IN 71 273 ...
	10900	30900

→ v_c Page 72

Right hand internal thread turning insert – Mini size 08

- ▲ Partial profile
- ▲ Thread production from diameter 8 mm

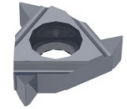
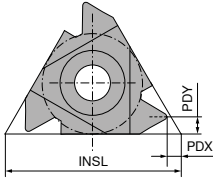

Designation	TPI 1/"	INSL mm	PDX mm	PDY mm
08 IR A55	48 - 16	8	0.6	0.7

	IR 71 272 ...	IR 71 272 ...
P	●	○
M	●	●
K	●	○
N	○	○
S	○	●
H	○	○
O	○	○

IR 71 272 ...	IR 71 272 ...
10700	30700

→ v_c Page 72

Right Hand Internal Thread Holder – Mini size 06

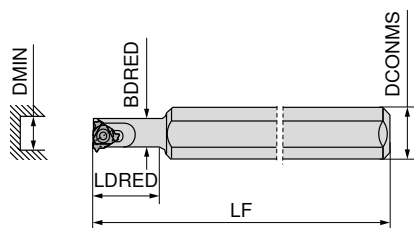

NEW
Right-hand
71 282 ...

Designation	LF mm	LDRED mm	DCONMS mm	BDRED mm	DMIN mm	Insert	torque moment Nm	
SI R 0005 H06	100	12	12	5.1	6	06 ..	0,6	00500
SI R 0005 H06 C	100	26	6	5.1	6	06 ..	0,6	10500 ¹⁾

1) Solid Carbide Shank with Thro' Coolant

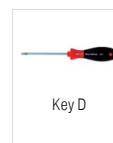

Key D



Clamping screw

80 950 ...

71 950 ...

Spare parts
for Article no.

71 282 00500	T06	108	23800
71 282 10500	T06	108	23800

Right Hand Internal Thread Holder – Mini size 08

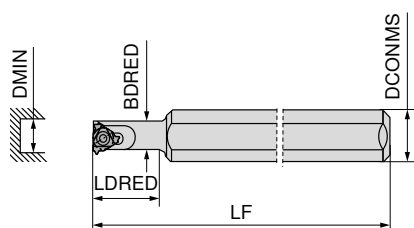

NEW
Right-hand
71 282 ...

Designation	LF mm	LDRED mm	DCONMS mm	BDRED mm	DMIN mm	Insert	torque moment Nm	
SI R 0007 K08	125	18	16	6.6	7.8	08 ..	0,6	00700
SI R 0007 K08C	125	30	8	6.6	7.8	08 ..	0,6	10700 ²⁾
SI R 0007 K08U	125	31	16	7.3	9.0	08 .N	0,6	00800 ¹⁾

1) Neutral insert indicated by marking (N)

2) Solid Carbide Shank with Thro' Coolant

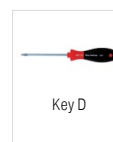

Key D



Clamping screw

80 950 ...

71 950 ...

Spare parts
for Article no.

71 282 00700	T06	108	23900
71 282 10700	T06	108	23900
71 282 00800	T06	108	23900

Shims for Standard Threading Inserts

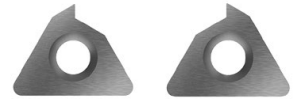

Pitch-angle β	AE 16 ER 16 / IL 16	AI 16 EL 16 / IR 16
	71 950 ...	71 950 ...
+ 4,5°	118	126
+ 3,5°	119	127
+ 2,5°	120	128
+ 1,5°	121	129
+ 0,5°	122	130
0°	123	131
- 0,5°	124	132
- 1,5°	125	133

Material examples for cutting data tables

	Material sub-group	Index	Composition / Structure / Heat treatment	Tensile strength N/mm ² / HB / HRC	Material number	Material designation	Material number	Material designation
P	Unalloyed steel	P.1.1	< 0,15 % C Annealed	420 N/mm ² / 125 HB	1.0401	C15	1.1141	Ck15
		P.1.2	< 0,45 % C Annealed	640 N/mm ² / 190 HB	1.1191	C45E	1.0718	9SMnPb28
		P.1.3	< 0,45 % C Tempered	840 N/mm ² / 250 HB	1.1191	C45E	1.0535	C55
		P.1.4	< 0,75 % C Annealed	910 N/mm ² / 270 HB	1.1223	C60R	1.0535	C55
		P.1.5	< 0,75 % C Tempered	1010 N/mm ² / 300 HB	1.1223	C60R	1.0727	45S20
	Low-alloy steel	P.2.1	Annealed	610 N/mm ² / 180 HB	1.7131	16MnCr5	1.6587	17CrNiMo6
		P.2.2	Tempered	930 N/mm ² / 275 HB	1.7131	16MnCr5	1.6587	17CrNiMo6
		P.2.3	Tempered	1010 N/mm ² / 300 HB	1.7225	42CrMo4	1.3505	100Cr6
		P.2.4	Tempered	1200 N/mm ² / 375 HB	1.7225	42CrMo4	1.3505	100Cr6
	High-alloy steel and high-alloy tool steel	P.3.1	Annealed	680 N/mm ² / 200 HB	1.4021	X20Cr13	1.4034	X46Cr13
		P.3.2	Hardened and tempered	1100 N/mm ² / 300 HB	1.2343	X38CrMoV5-1	1.4034	X46Cr13
		P.3.3	Hardened and tempered	1300 N/mm ² / 400 HB	1.2343	X38CrMoV5-1	1.4034	X46Cr13
	Stainless steel	P.4.1	Ferritic / martensitic Annealed	680 N/mm ² / 200 HB	1.4016	X6Cr17	1.2316	X36CrMo16
		P.4.2	Martensitic Tempered	1010 N/mm ² / 300 HB	1.4112	X90CrMoV18	1.2316	X36CrMo16
M	Stainless steel	M.1.1	Austenitic / austenitic-ferritic Quenched	610 N/mm ² / 180 HB	1.4301	X5CrNi18-10	1.4571	X6CrNiMoTi17-12-2
		M.2.1	Austenitic Tempered	300 HB	1.4841	X15CrNiSi25-21	1.4539	X1NiCrMoCu25-20-5
		M.3.1	Austenitic / ferritic (Duplex)	780 N/mm ² / 230 HB	1.4462	X2CrNiMoN22-5-3	1.4501	X2CrNiMoCuWN25-7-4
K	Grey cast iron	K.1.1	Pearlitic / ferritic	350 N/mm ² / 180 HB	0.6010	GG-10	0.6025	GG-25
		K.1.2	Pearlitic (martensitic)	500 N/mm ² / 260 HB	0.6030	GG-30	0.6045	GG-45
	Spherulitic graphite cast iron	K.2.1	Ferritic	540 N/mm ² / 160 HB	0.7040	GGG-40	0.7060	GGG-60
		K.2.2	Pearlitic	845 N/mm ² / 250 HB	0.7070	GGG-70	0.7080	GGG-80
	Malleable iron	K.3.1	Ferritic	440 N/mm ² / 130 HB	0.8035	GTW-35-04	0.8045	GTW-45
		K.3.2	Pearlitic	780 N/mm ² / 230 HB	0.8165	GTS-65-02	0.8170	GTS-70-02
N	Aluminium wrought alloy	N.1.1	Non-hardenable	60 HB	3.0255	Al99,5	3.3315	AlMg1
		N.1.2	Hardenable Age-hardened	340 N/mm ² / 100 HB	3.1355	AlCuMg2	3.2315	AlMgSi1
	Cast aluminium alloy	N.2.1	≤ 12 % Si, non-hardenable	250 N/mm ² / 75 HB	3.2581	G-AlSi12	3.2163	G-AlSi9Cu3
		N.2.2	≤ 12 % Si, hardenable Age-hardened	300 N/mm ² / 90 HB	3.2134	G-AlSi5Cu1Mg	3.2373	G-AlSi9Mg
		N.2.3	> 12 % Si, non-hardenable	440 N/mm ² / 130 HB		G-AlSi17Cu4Mg		G-AlSi18CuNiMg
	Copper and copper alloys (bronze/brass)	N.3.1	Free-machining alloys, PB > 1 %	375 N/mm ² / 110 HB	2.0380	CuZn39Pb2 (Ms58)	2.0410	CuZn44Pb2
		N.3.2	CuZn, CuSnZn	300 N/mm ² / 90 HB	2.0331	CuZn15	2.4070	CuZn28Sn1As
		N.3.3	CuSn, lead-free copper and electrolytic copper	340 N/mm ² / 100 HB	2.0060	E-Cu57	2.0590	CuZn40Fe
	Magnesium alloys	N.4.1	Magnesium and magnesium alloys	70 HB	3.5612	MgAl6Zn	3.5312	MgAl3Zn
	S	Heat-resistant alloys	S.1.1	Fe - basis Annealed	680 N/mm ² / 200 HB	1.4864	X12NiCrSi 36-16	1.4865
S.1.2			Fe - basis Age-hardened	950 N/mm ² / 280 HB	1.4980	X6NiCrTiMoVB25-15-2	1.4876	X10NiCrAlTi32-20
S.2.1			Ni or Co basis Annealed	840 N/mm ² / 250 HB	2.4631	NiCr20TiAl (Nimonic80A)	3.4856	NiCr22Mo9Nb
S.2.2			Ni or Co basis Age-hardened	1180 N/mm ² / 350 HB	2.4668	NiCr19Nb5Mo3 (Inconel 718)	2.4955	NiFe25Cr20NbTi
S.2.3			Ni or Co basis Cast	1080 N/mm ² / 320 HB	2.4765	CoCr20W15Ni	1.3401	G-X120Mn12
Titanium alloys		S.3.1	Pure titanium	400 N/mm ²	3.7025	Ti99,8	3.7034	Ti99,7
		S.3.2	Alpha + beta alloys Age-hardened	1050 N/mm ² / 320 HB	3.7165	TiAl6V4	Ti-6246	Ti-6Al-2Sn-4Zr-6Mo
		S.3.3	Beta alloys	1400 N/mm ² / 410 HB	Ti555.3	Ti-5Al-5V-5Mo-3Cr	R56410	Ti-10V-2Fe-3Al
H	Hardened steel	H.1.1	Hardened and tempered	46-55 HRC				
		H.1.2	Hardened and tempered	56-60 HRC				
		H.1.3	Hardened and tempered	61-65 HRC				
		H.1.4	Hardened and tempered	66-70 HRC				
	Chilled iron	H.2.1	Cast	400 HB				
	Hardened cast iron	H.3.1	Hardened and tempered	55 HRC				
	O	Non-metal materials	O.1.1	Plastics, duroplastic	≤ 150 N/mm ²			
O.1.2			Plastics, thermoplastic	≤ 100 N/mm ²				
O.2.1			Aramid fibre-reinforced	≤ 1000 N/mm ²				
O.2.2			Glass/carbon-fibre reinforced	≤ 1000 N/mm ²				
O.3.1			Graphite					

* Tensile strength

Cutting data standard values

	Mini CCN1525	Mini CCN2520	CCN20	CWK20
Index	v _c in m/min			
P.1.1	80	120	120	
P.1.2	80	120	120	
P.1.3	80	120	120	
P.1.4	80	80	80	
P.1.5	70	80	80	
P.2.1	50	80	80	
P.2.2	50	80	80	
P.2.3	50	80	80	
P.2.4	50	80	80	
P.3.1	50	50	50	
P.3.2	50	50	50	
P.3.3	50	50	50	
P.4.1	50	50	50	
P.4.2	50	50	50	
M.1.1	40	90	60	40
M.2.1	40	90	60	40
M.3.1	40	90	60	40
K.1.1	60	120	120	80
K.1.2	60	120	120	80
K.2.1	60	100	100	70
K.2.2	60	100	100	70
K.3.1	50	100	100	70
K.3.2	50	100	100	70
N.1.1	500			150
N.1.2	300			150
N.2.1	120			120
N.2.2	120			120
N.2.3	120			120
N.3.1	110			100
N.3.2	150			100
N.3.3	150			100
N.4.1	300			150
S.1.1		25	20	20
S.1.2		25	20	20
S.2.1		25	20	20
S.2.2		25	20	20
S.2.3		25	20	20
S.3.1		35	30	30
S.3.2		35	30	30
S.3.3		35	30	30
H.1.1		35	30	
H.1.2		35	30	
H.1.3		35	30	
H.1.4		35	30	
H.2.1		25	20	
H.3.1		25	20	
O.1.1	150			
O.1.2	150			
O.2.1	150			
O.2.2	150			
O.3.1	150			



The cutting data depends extremely on the external conditions, the material and machine type.
The indicated values are possible values which have to be increased or reduced according to the application conditions.

Pitch angle

Important Information about Standard Shims

- ▲ the pitch angle should be determined through calculation or by using the chart below.
- ▲ the standard threading holder is supplied with a 1.5° inclined insert seat and a shim without angular correction.
Hence the Tool holders are delivered with an angle of inclination β of 1.5°.



Without the appropriate correction of the helix angle, the following may occur

- ▲ the profile will be distorted.
- ▲ insufficient clearance angle.
- ▲ the tool life of the insert is greatly reduced.

Method 1: Calculation

Calculating the helix angle β:

$$\beta = \frac{20 \times TP}{DMIN}$$

20 = constant
β = Helix angle (°)
TP = Pitch (mm)
DMIN = Nominal diameter (mm)

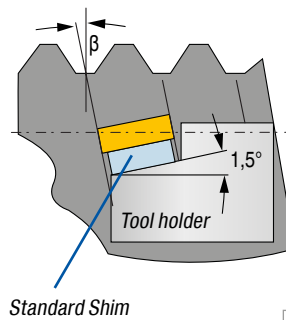

Example calculation

External thread M24 x 1.5
Feed towards chuck
DMIN = Nominal Ø: M24 = 24 mm
TP = Pitch: 1.5 mm

$$\beta = \frac{20 \times 1,5 \text{ mm}}{24 \text{ mm}}$$

β = 1,25°

Method 2: Diagram

From the flank Ø in the diagram, a line is drawn vertically upwards until it intersects with the line of the pitch of the thread to be produced. In the color-coded region in which it is now, a horizontal line to the edge of the chart indicates the appropriate factor.

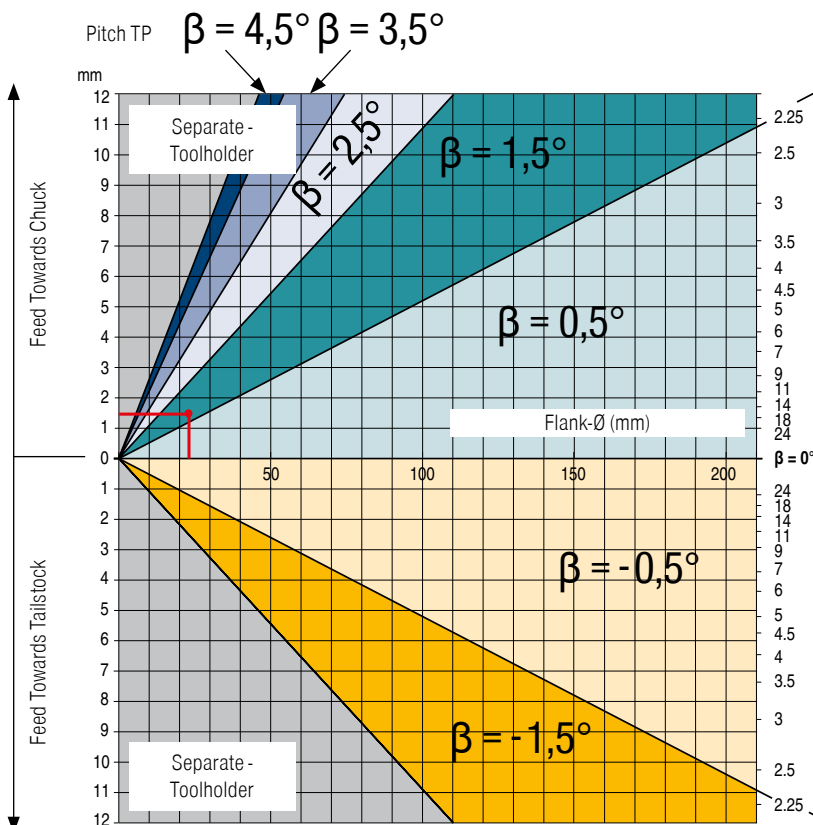

calculated pitch angle β value	Shim
0,0°–0,99°	0,5°
1,0°–1,99°	1,5°
2,0°–2,99°	2,5°
3,0°–3,99°	3,5°
4,0°–4,99°	4,5°
0,0°–(-0,99°)	-0,5°
-1,0°–(-1,99°)	-1,5°

Thread turning methods

External right-hand thread

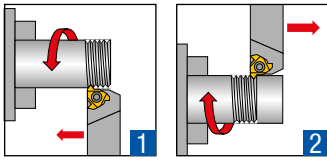

External left-hand thread

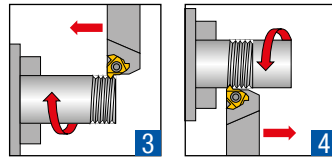

Internal right-hand thread

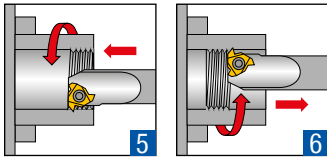

Internal left-hand thread

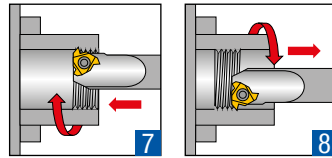

i The machining examples 2, 4, 6 and 8 require negative shims!
These shims can be found on → **Page 70.**

Thread infeed methods

Radial Infeed

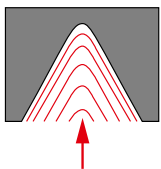

- ▲ for pitches less than 1.5 mm
- ▲ for short chipping materials
- ▲ for machining hardened materials
- ▲ simple and quick method

Flank infeed

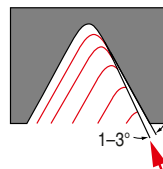

- ▲ for pitches larger than 1.5 mm
- ▲ with radial penetration the effective cutting edge length is too large, which may lead to chattering
- ▲ with trapezoidal and ACME threads, chip flow on three sides can be problematic

Alternating infeed

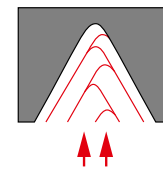

- ▲ with large pitches
- ▲ for long chipping materials
- ▲ uniform wear of the cutting edges
- ▲ complicated programming process

Recommended number of cuts and cutting depths

Standard Threading Inserts

Pitch (TP/TPI)	mm	0,50	0,75	1,00	1,25	1,50	1,75	2,00	2,50	3,00	3,50	4,00	4,50	5,00	5,50	6,00	8,00
	TPI	48	32	24	20	16	14	12	10	8	7	6	5,5	5	4,5	4	3
Number of passes		4-6	4-7	4-8	5-9	6-10	7-12	7-12	8-14	9-16	10-18	11-18	11-19	12-20	12-20	12-20	15-24
Number of passes	(CCN7525)	3-4	3-4	3-5	4-6	5-6	6-8	6-8	8-10								
Number of passes	Mini Inserts	6-9	6-11	6-12	8-14	9-15	11-18	11-18									

Multi edge thread turning insert

Standard	Insert	Insert size		Pitch (TP)	Number of flutes (NT)	Designation	Passes	Cutting depth per pass		
		IC	L mm					1	2	3
ISO external	M	3/8"	16	1,0 mm	3	3 ER 1.0 ISO 3M	2	0,38	0,25	
ISO external	M	3/8"	16	1,5 mm	2	3 ER 1.5 ISO 2M	3	0,42	0,30	0,20

Troubleshooting

Edge chipping

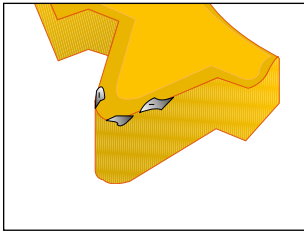

Cause

- ▲ Common in stainless materials
- ▲ Incorrect grade

Remedy

- ▲ Minimize tool overhang length
- ▲ Check that the insert is clamped
- ▲ Minimize vibration
- ▲ Use a tougher grade

Cratering

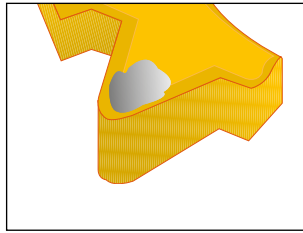

Cause

- ▲ Common in stainless materials
- ▲ Cutting speed too high
- ▲ Incorrect grade

Remedy

- ▲ Apply coolant
- ▲ Reduce depth of cut
- ▲ Use a harder grade

Built-up edge

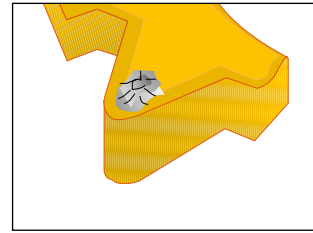

Cause

- ▲ Cutting speed too low
- ▲ Incorrect grade

Remedy

- ▲ Apply coolant
- ▲ Increase cutting speed
- ▲ Use a tougher grade

Thermal cracking

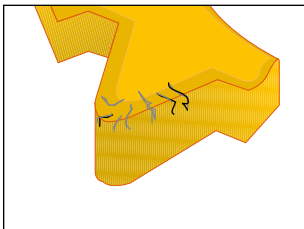

Cause

- ▲ Insufficient coolant
- ▲ Cutting speed too high
- ▲ Incorrect grade

Remedy

- ▲ Apply coolant
- ▲ Reduce cutting speed
- ▲ Use a tougher grade

Plastic deformation

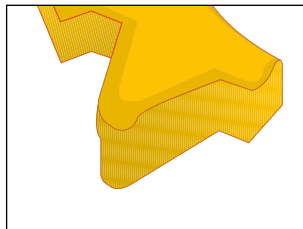

Cause

- ▲ Infeed too large
- ▲ Insufficient coolant
- ▲ Cutting speed too high
- ▲ Incorrect grade

Remedy

- ▲ Apply coolant
- ▲ Reduce depth of cut
- ▲ Reduce cutting speed
- ▲ Use a harder grade

Breakage

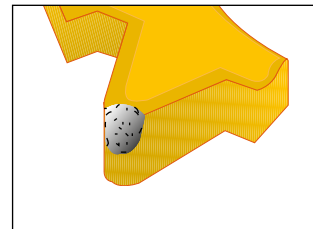

Cause

- ▲ Infeed too large
- ▲ Insufficient coolant
- ▲ Plastic deformation
- ▲ Instability
- ▲ Helix angle not appropriate
- ▲ Incorrect grade

Remedy

- ▲ Reduce depth of cut
- ▲ Check machine and tool stability
- ▲ Reduce cutting speed
- ▲ Check helix angle
- ▲ Use a tougher grade

Designation Key

Inserts

16	E	R	AG 60	16
Insert size	Insert	Cutting design	Pitch (TP/TPI)	Number of flutes (NT)
L 06 08 11 16 22	E I External Internal	R L N Right-hand Left-hand neutral	Full profile mm 0,35 G/Z 72-4 Partial profile mm A 0,5-1,5 AG 0,5-3,0 M 1,7-2,0 G 1,75-3,0 N 3,5-5,0 U 5,5-8,0 4,5-3,5 Flank angle 55° 60°	2M Multi-tooth insert with 2 teeth 3M Multi-tooth insert with 3 teeth

Example

16 ER AG 60

ER16 right hand – external insert with a pitch of 0.5-3.0 mm

Tool holder

SE	R	1212	F	16
Tool holder	Cutting design	Shank cross-section	Overall length	Insert size
SE SI External Internal	R L Right-hand Left-hand	Example External holder square shank Internal boring bar 1212 = 12 mm x 12 mm 0020 = 20 mm Diameter	F mm 80 H 100 K 125 L 140 M 150 P 170 R 200 S 250 T 300	L 06 08 11 16 22 IC. 5/32" 3/16" 1/4" 3/8" 1/2"

Properties

B with thro' coolant
C with carbide shank
U neutral holder

Example

SE R 1212 F 16

Right hand holder with 12 x 12 mm square shank, overall length of 80 mm, only suitable for an ER16 threading insert

Overview Thread Turning Types

Further thread turning options can be found in the chapters below.

Thread turning for automatic lathes

TiAlN coated carbide insert for external threading on automatic lathes.

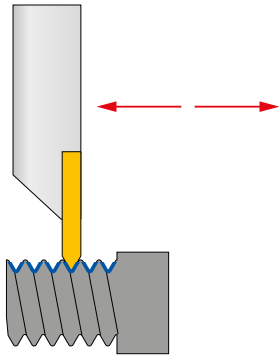

Carbide indexable inserts with a pitch of 0.25 mm–2.0 with appropriate tool holders can be found in chapter → **Turning**.

TC Threading System

Mono and Modular Systems for Internal and External Thread Turning.



TC thread inserts with appropriate tool holders can be found in chapter → **Grooving**.

UltraMini

TiN and TiAlN coated carbide cutting inserts for internal threading from $D_{\min.} \varnothing 2.4$ mm.

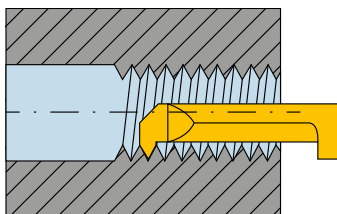

Cutting inserts for thread turning and other applications with the appropriate tool holders can be found in chapter → **Miniature turning**.

MiniCut

TiAlN carbide inserts for internal threading from $D_{\min.} \varnothing 8$ mm.

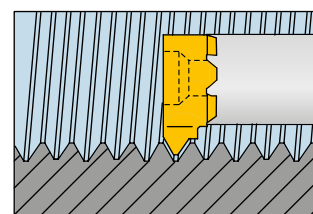

Cutting inserts for thread turning and other applications with the appropriate tool holders can be found in chapter → **Miniature turning**.

Coatings and Grades

HSS taps

vap.

- ▲ Vaporised
- ▲ Vaporisation (vapour-deposition) prevents cold welds from forming on the tool and increases the surface hardness and thus the wear resistance

vap.
+
nitr.

- ▲ Vaporized + Nitrated
- ▲ Combination of increased surface hardness and lubricant carrier

AlTiNHD

- ▲ AlTiN-based nanolayer hard material coating
- ▲ Maximum application temperature 500 °C

TiCN

- ▲ TiCN multilayer coating
- ▲ Maximum application temperature: 450 °C

TiN

- ▲ TiN coating
- ▲ Maximum application temperature: 450 °C

Thread milling cutters

CWX500

- ▲ Carbide, TiAlN-coated
- ▲ The universal carbide grade for almost all materials

Ti500

- ▲ TiAlN-coating
- ▲ Maximum application temperature: 500 °C

Circular milling cutters

CWX500

- ▲ Carbide, TiAlN-coated
- ▲ The universal carbide grade for almost all materials

Thread turning

CWK20

- ▲ Carbide, uncoated
- ▲ ISO | M10 | **K10** | **N10** | S10
- ▲ The wear-resistant carbide grade for machining aluminium and other non-ferrous metals

CCN20

- ▲ Carbide, TiAlN-coated
- ▲ ISO | **P20** | **M20** | **K20** | S20 | H20
- ▲ The all-round carbide grade for machining steels at low cutting speeds

CCN1525

- ▲ Carbide, TiN-coated
- ▲ ISO | **P25** | **M25** | **K25** | N25 | O25
- ▲ The coated carbide grade for machining steels and stainless steels at low cutting speeds

CCN2520

- ▲ Carbide, TiAlN-coated
- ▲ ISO | P25 | **M25** | K25 | **S25** | H25
- ▲ The coated carbide grade for the machining of stainless steels at medium to high cutting speeds

PROJECTS IN THE BEST OF HANDS

Smart solutions for efficient machining processes

Benefit from our innovative tool concepts, many years of experience and professional advice to increase your productivity. You can rely on us to implement your project successfully!





Solid drilling and bore machining

HSS drilling

Solid carbide drilling

Reamers

1

Threading

HSS taps

Circular and Thread Milling

Thread turning

2

ISO turning

→ Page 3-49

TriClamp

→ Page 50-55

XheadClamp

→ Page 56-61

Reverse-side machining

→ Page 62-103

VertiClamp

→ Page 104-130

Coolant connections

→ Page 131+132

Turning

Turning Tools

→ Page 3-171

Multi-function tool – EcoCut

→ Page 172-201

Grooving Tools

→ Page 204-287

Miniature turning tools

→ Page 288-342

3

Milling

Solid Carbide milling cutters

4

Workholding

Collets and reduction sleeves

5

Material examples and
article no. index

6

Table of contents

Overview	2
ISO turning	
Symbol explanation / Coding of the chip breaker	2
Toolfinder	3-6
Product programme	7-49
TriClamp	
Toolfinder	50
Product programme	51-55
XheadClamp	
Toolfinder	56
Product programme	57-61
Reverse-side machining	
Toolfinder	62+63
Product programme	64-103
VertiClamp	
Toolfinder	104+105
Product programme	106-130
Coolant connections	131+132
Technical Information	133-171

CERATIZIT \ Performance

Premium quality tools for high performance.

The premium quality tools from the **CERATIZIT Performance** product line have been designed for specific applications and are distinguished by their outstanding performance. If you make high demands on the performance of your production and want to achieve the very best results, we recommend the Premium tools in this product line.

WNT \ Performance

Premium quality tools for high performance.

The premium quality tools from the **WNT Performance** product line have been designed for specific applications and are distinguished by their outstanding performance. If you make high demands on the performance of your production and want to achieve the very best results, we recommend the Premium tools in this product line.

ISO turning

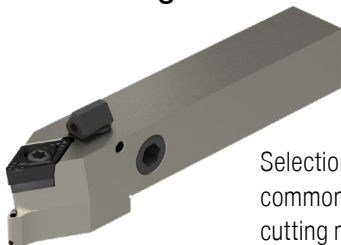

Selection of turning inserts with common ISO geometries in various cutting material grades.

VertiClamp



Specialised systems for use on sliding head lathes with vertically positioned indexable inserts.

TriClamp

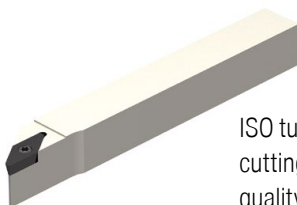

ISO turning inserts with optimised cutting edge for improving the surface quality or increasing the feed rate.

XheadClamp

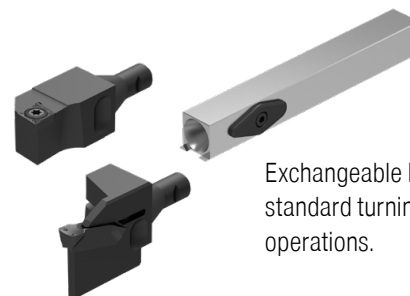

Exchangeable head system for standard turning and grooving operations.

Reverse-side machining

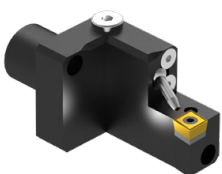

Flexible tool holder system for machining on the second spindle. There are modular, as well as monoblock tool holders available for turning, grooving, boring and threading on the back of the part.

Coding of the chip breakers

-M50

Inserts – Basic Type	Application range	Material		Chip breaker width
	F = Fine	1 = Steel	5 = Heat Resistant alloys	1 = Narrow
0 N = Negative Inserts	M = Medium	2 = Stainless steel	6 = Hard	↑ ↓
5 P = Positive Inserts	R = Rough	3 = Cast Iron	7 = Universal	
		4 = Non Ferrous Metals		9 = Wide

i Detailed information on the chip breakers can be found in the technical appendix → **pages 149–151**

Symbol explanation

CTCP125-P Carbide Grade

- F** Fine Machining
- M** Medium Machining
- R** Rough Machining



- Smooth cut
- Irregular cutting depth
- Interrupted cut

i A detailed overview of grades can be found in the technical appendix on → **page 168**

Toolfinder – ISO turning – application

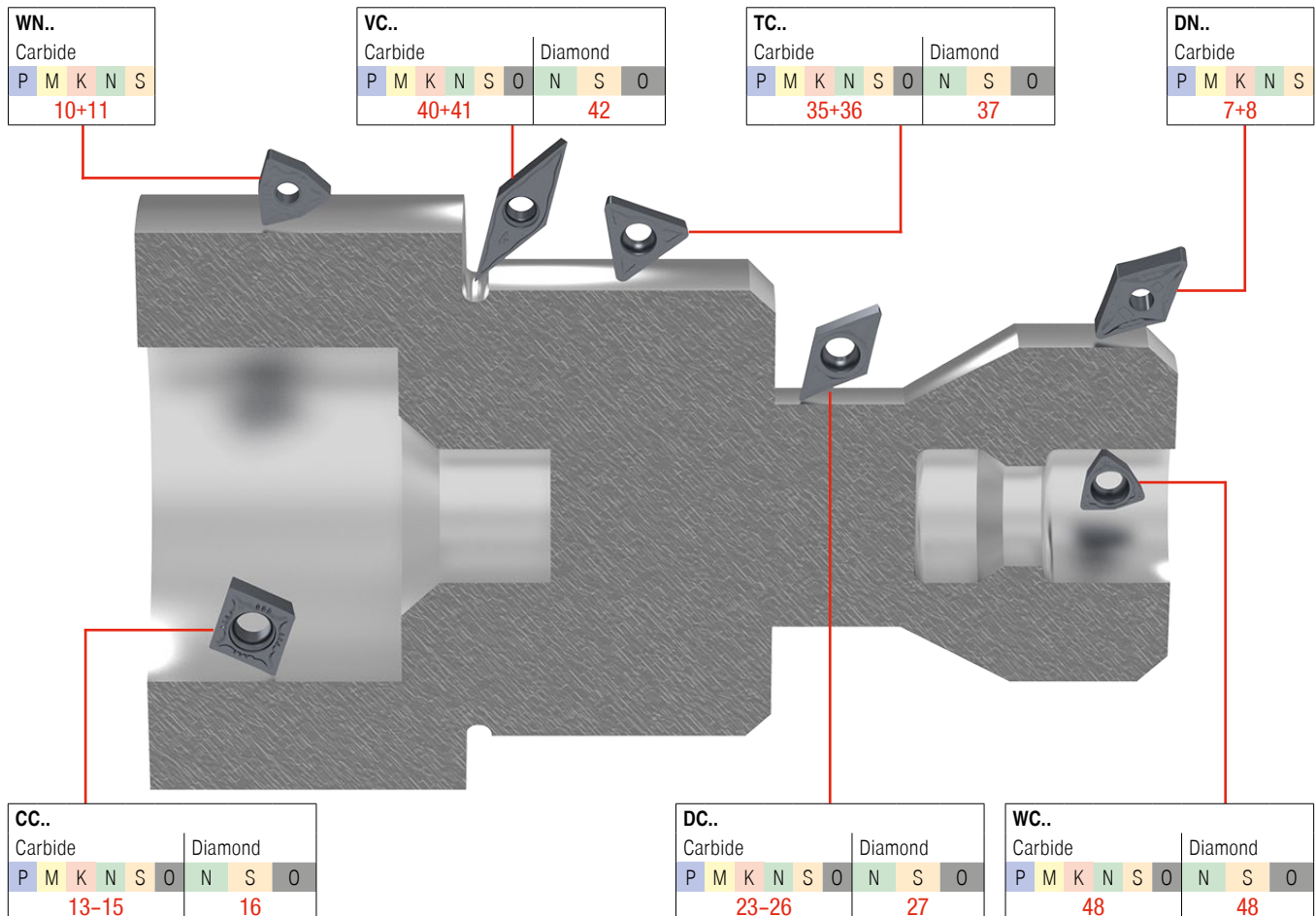

Toolfinder – negative inserts



Steel	Stainless steel	Cast iron	Non-ferrous metals	Heat-resistant	Tempered steel	Non-metal materials		
P	M	K	N	S	H	O	DN..	WN..

Sharp ↑ stable ↓	Fine	-F50		●	○	○			7	10
	Medium	-M50		●	○	○			7	10
		-M70		●	○	○			7	10

Sharp ↑ stable ↓	Fine	-F30		○	●	○			8	11
	Medium	-M30		○	●	○			8	11
		-M60		○	●	○			11	

Toolfinder – positive inserts



			Steel	Stainless steel	Cast iron	Non-ferrous metals	Heat-resistant	Tempered steel	Non-metal materials	Geometry				
			P	M	K	N	S	H	O	CC..	DC..	TC..	VC..	WC..
Sharp ↓ stable	Fine	-SF	●	○	○					13	23	35	40	48
	Medium	-SMF	●	○	○					13+14	23	35	40	
		-SM	●	○	○					13+14	24	35		
		-SMQ	●	○							24			
Sharp ↓ stable	Medium	-M25	○	●		●				14	24	35		
		-M55	○	●		●				14	24	35		
Sharp ↓ stable	Fine	-23P			○	●			○	14	25			
	Medium	-25P	●	●	○	●	●		○	14	25		40	
		-25Q	●	●	○	●	●		○	14	25		40	
		-27	●	●	○	●	●		○	15	25+26	26	40	
		-29			○	●			○	15	25+26			
		-M81		●		○				15	25+26			
Fine	-F05	●	●		●	●			15	25+26		36		
Sharp ↓ stable	Diamond				●			●	41	16	27	37	48	
		-CB1			●			●	41	16	27	37		
		-CB2			●			●	41	16		37		
		-CB3			●			●	41	16		37		



This article can be found in our online shop at cuttingtools.ceratizit.com



Toolfinder – holders





Toolholders and boring bars for negative inserts



Geometry	Tool holder
 DN..	9
 WN..	12

Toolholders and boring bars for positive inserts



Geometry	Tool holder	Tool holder DirectCooling	Boring bars
 CC..	17-20	18+19	21+22
 DC..	28-31	30+31	33
 TC..	38	45	39
 VC..	43		46+47
 WC..			49

DNMG / DNGU

Designation	L mm	S mm	D1 mm	IC mm
DN.. 1104..	11.6	4.76	3.81	9.52

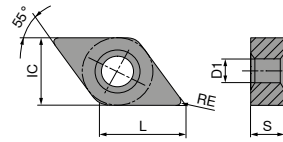

DNMG

		NEW		NEW		NEW		NEW		NEW	
		-F50		-F50		-F50		-M50		-M50	
		CTCP115-P		CTCP125-P		CTCP135-P		CTCP115-P		CTCP125-P	
		DRAGONSKIN		DRAGONSKIN		DRAGONSKIN		DRAGONSKIN		DRAGONSKIN	
		F		F		F		M		M	
		DNMG		DNMG		DNMG		DNMG		DNMG	
		76 134 ...		76 134 ...		76 134 ...		76 136 ...		76 136 ...	
ISO	RE mm										
110402EN	0.2		30201	50201	70201						
110404EN	0.4		30401	50401	70401		30401	50401		70401	
110408EN	0.8		30601	50601	70601		30601	50601		70601	
P			●	●	●		●	●		●	●
M					○						○
K			○	○			○	○			
N											
S											
H											
O											

DNMG

		NEW		NEW		NEW	
		-M70		-M70		-M70	
		CTCP115-P		CTCP125-P		CTCP135-P	
		DRAGONSKIN		DRAGONSKIN		DRAGONSKIN	
		M		M		M	
		DNMG		DNMG		DNMG	
		76 263 ...		76 263 ...		76 263 ...	
ISO	RE mm						
110408EN	0.8			30601	50601	70601	
110412EN	1.2			30801	50801	70801	
P				●	●	●	
M							○
K				○	○		
N							
S							
H							
O							

3

DNMG

ISO	RE mm						
110404EN	0.4						
110408EN	0.8						
110412EN	1.2						
P							
M							
K							
N							
S							
H							
O							

NEW	NEW	NEW	NEW	NEW	NEW
-F30 CTCM120	-F30 CTPM125	-F30 CTCM130	-M30 CTCM120	-M30 CTPM125	-M30 CTCM130
DRAGONSKIN	DRAGONSKIN	DRAGONSKIN	DRAGONSKIN	DRAGONSKIN	DRAGONSKIN
F DNMG	F DNMG	F DNMG	M DNMG	M DNMG	M DNMG
75 013 ...	75 013 ...	75 013 ...	75 014 ...	75 014 ...	75 014 ...

DNGU

ISO	RE mm		
1104008FN	0.08		
1104015FN	0.15		
P			
M			
K			
N			
S			
H			
O			

-F32 WPU7620	-F32 WUU7620
F DNGU	F DNGU
72 494 ...	72 401 ...

MaxiLock-S – SDJN 93° – Toolholder with screw clamping

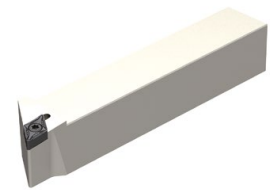
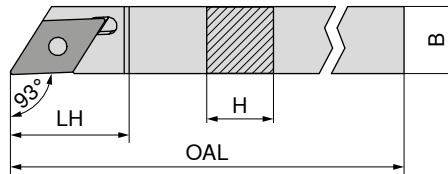

Illustrations show right-hand versions

ISO designation	H mm	B mm	OAL mm	LH mm	WF mm	torque moment Nm	Insert
SDJN R/L 1012 H11	10	12	100	21.3	12	3,2	DNGU 1104
SDJN R/L 1212 H11	12	12	100	21.3	12	3,2	DNGU 1104
SDJN R/L 1616 K11	16	16	125	21.3	16	3,2	DNGU 1104
SDJN R/L 2020 K11	20	20	125	21.3	20	3,2	DNGU 1104
SDJN R/L 2525 M11	25	25	150	21.3	25	3,2	DNGU 1104

Left-hand	Right-hand
70 699 ...	70 698 ...
010	010
012	012
016	016
020	020
025	025

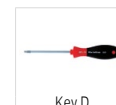

Key D

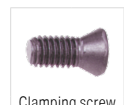

Clamping screw

Spare parts for Article no.

70 698 010 / 70 699 010
70 698 012 / 70 699 012
70 698 016 / 70 699 016
70 698 020 / 70 699 020
70 698 025 / 70 699 025

80 950 ...	72 950 ...
128	007
128	007
128	007
128	007
128	007

MaxiLock-N – PDJN 93° – Toolholder with lever clamping

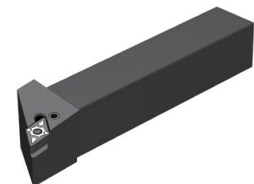
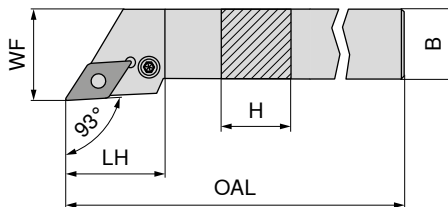

Illustrations show right-hand versions

ISO designation	H mm	B mm	OAL mm	LH mm	WF mm	torque moment Nm	Insert
PDJN R/L 1616 H11	16	16	100	30	20	3	DN.. 1104
PDJN R/L 2020 K11	20	20	125	30	25	3	DN.. 1104
PDJN R/L 2525 M11	25	25	150	30	32	3	DN.. 1104

Left-hand	Right-hand
70 541 ...	70 540 ...
116	116
12000 ¹⁾	12000 ¹⁾
12500 ¹⁾	12500 ¹⁾

1) nickel-plated



Key I

70 950 ...



Shim

70 950 ...



Assembly pin

70 950 ...



Lever

70 950 ...



Clamping screw

70 950 ...



Solid Carbide Seat D

70 950 ...

for Article no.

70 540 116 / 70 541 116
70 540 12000 / 70 541 12000
70 540 12500 / 70 541 12500

175	122	191	121	208	120
175	122	191	121	208	120
175	122	191	121	208	120

WNMG

Designation	L mm	S mm	D1 mm	IC mm
WNMG 0604..	6.5	4.76	3.81	9.52

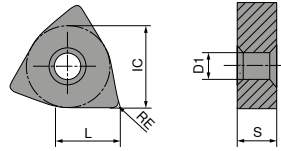

WNMG

		NEW		NEW		NEW		NEW		NEW	
		-F50		-F50		-F50		-M50		-M50	
		CTCP115-P		CTCP125-P		CTCP135-P		CTCP115-P		CTCP125-P	
		DRAGONSKIN		DRAGONSKIN		DRAGONSKIN		DRAGONSKIN		DRAGONSKIN	
		F		F		F		M		M	
		WNMG		WNMG		WNMG		WNMG		WNMG	
		76 157 ...		76 157 ...		76 157 ...		76 139 ...		76 139 ...	
ISO	RE mm	30401		50401		70401		30401		50401	
060404EN	0.4	30601		50601		70601		30601		50601	
060408EN	0.8										
P		●		●		●		●		●	
M						○				○	
K		○		○				○		○	
N											
S											
H											
O											

WNMG

		NEW		NEW		NEW	
		-M70		-M70		-M70	
		CTCP115-P		CTCP125-P		CTCP135-P	
		DRAGONSKIN		DRAGONSKIN		DRAGONSKIN	
		M		M		M	
		WNMG		WNMG		WNMG	
		76 273 ...		76 273 ...		76 273 ...	
ISO	RE mm	30601		50601		70601	
060408EN	0.8	30801		50801		70801	
060412EN	1.2						
P		●		●		●	
M						○	
K		○		○			
N							
S							
H							
O							

WNMG

ISO	RE mm	NEW -F30 CTCM120	-F30 CTPM125	NEW -F30 CTCM130	NEW -M30 CTCM120	-M30 CTPM125	NEW -M30 CTCM130
060404EN	0.4	10400	204	30400	10600	206	30600
060408EN	0.8	10600	206	30600	10800	208	30800
060412EN	1.2						

P	○	○	○	○	○	○	○
M	●	●	●	●	●	●	●
K							
N							
S			○				○
H							
O							

WNMG

ISO	RE mm	NEW -M60 CTCM120	-M60 CTPM125	NEW -M60 CTCM130
060408EN	0.8	10600	206	30600
060412EN	1.2	10800		30800

P	○	○	○
M	●	●	●
K			
N			
S			○
H			
O			

MaxiLock-N – PWLN 95° – Toolholder with lever clamping

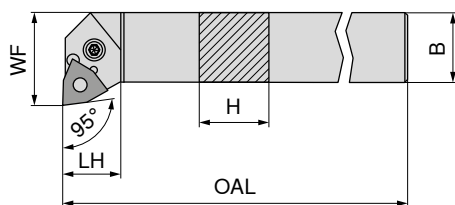

Illustrations show right-hand versions

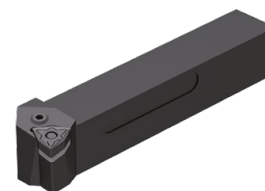

ISO designation	H mm	B mm	OAL mm	LH mm	WF mm	torque moment Nm	Insert	Left-hand	Right-hand
								70 543 ...	70 542 ...
PWLN R/L 1616 H06	16	16	100	20	22.5	3	WNMG 0604	116	11600 ¹⁾
PWLN R/L 2020 K06	20	20	125	26	25.0	3	WNMG 0604	12000 ¹⁾	12000 ¹⁾
PWLN R/L 2525 M06	25	25	150	19	32.0	3	WNMG 0604	125	12500 ¹⁾

1) nickel-plated

Spare parts for Article no.	Key I	Shim	Assembly pin	Lever	Clamping screw	Solid Carbide Seat W	
	70 950 ...	70 950 ...	70 950 ...	70 950 ...	70 950 ...	70 950 ...	
70 542 11600 / 70 543 116	SW2,5	175	122	191	185	208	127
70 542 12000 / 70 543 12000	SW2,5	175	122	191	185	208	127
70 542 12500 / 70 543 125	SW2,5	175	122	191	185	208	127

CCMT / CCGT / CCET

Designation	L mm	S mm	D1 mm	IC mm
CC.T 0602..	6.4	2.38	2.8	6.35
CC.T 09T3..	9.7	3.97	4.4	9.52

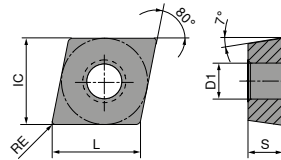

CCMT / CCGT

ISO	RE mm	NEW -SF CTCP115-P DRAGONSKIN	NEW -SF CTCP125-P DRAGONSKIN	NEW -SF CTCP125-P DRAGONSKIN	NEW -SF CTCP135-P DRAGONSKIN	NEW -SF CTCP135-P DRAGONSKIN
060202EN	0.2					
060204EN	0.4					
09T304EN	0.4					
09T308EN	0.8					
P		●	●	●	●	●
M					○	○
K		○	○	○		
N						
S						
H						
O						

ISO	RE mm	F CCMT 76 253 ...	F CCGT 76 251 ...	F CCMT 76 253 ...	F CCGT 76 251 ...	F CCMT 76 253 ...
060202EN	0.2					
060204EN	0.4					
09T304EN	0.4					
09T308EN	0.8					
P		●	●	●	●	●
M						
K		○	○	○	○	○
N						
S						
H						
O						

3

CCMT / CCGT

ISO	RE mm	NEW -SMF CTCP115-P DRAGONSKIN	NEW -SMF CTCP125-P DRAGONSKIN	NEW -SMF CTCP135-P DRAGONSKIN	NEW -SM CCGT 76 250 ...	NEW -SM CCGT 76 250 ...
060202EN	0.2					
060204EN	0.4					
060208EN	0.8					
09T304EN	0.4					
09T308EN	0.8					
P		●	●	●	●	●
M					○	○
K		○	○	○		
N						
S						
H						
O						

ISO	RE mm	F CCMT 76 249 ...	F CCMT 76 249 ...	F CCMT 76 249 ...	M CCGT 76 250 ...	M CCGT 76 250 ...
060202EN	0.2					
060204EN	0.4					
060208EN	0.8					
09T304EN	0.4					
09T308EN	0.8					
P		●	●	●	●	●
M					○	○
K		○	○	○		
N						
S						
H						
O						

CCMT

ISO	RE mm			
060204EN	0.4			
060208EN	0.8			
09T304EN	0.4			
09T308EN	0.8			

	NEW	NEW	NEW
	-SM CTCP115-P	-SM CTCP125-P	-SM CTCP135-P
	DRAGONSKIN	DRAGONSKIN	DRAGONSKIN
	M CCMT	M CCMT	M CCMT
	76 252 ...	76 252 ...	76 252 ...
	30401 30601	50401	70401 70601
	31601 31801	51601 51801	71601 71801
P	●	●	●
M			○
K	○	○	
N			
S			
H			
O			

CCMT

ISO	RE mm					
060204EN	0.4					
09T304EN	0.4					
09T308EN	0.8					

	NEW	NEW	NEW	NEW	NEW	
	-M25 CTCM120	-M25 CTPM125	-M25 CTCM130	-M55 CTCM120	-M55 CTPM125	-M55 CTCM130
	DRAGONSKIN	DRAGONSKIN	DRAGONSKIN	DRAGONSKIN	DRAGONSKIN	DRAGONSKIN
	F CCMT	F CCMT	F CCMT	M CCMT	M CCMT	M CCMT
	75 210 ...	75 210 ...	75 210 ...	75 211 ...	75 211 ...	75 211 ...
	10400	204	30400	10400	204	
	11600 11800	216 218	31600 31800	11600 11800	216 218	31600 31800
P	○	○	○	○	○	○
M	●	●	●	●	●	●
K						
N						
S			○			○
H						
O						

CCGT

		-23P H216T	-25P H210T	NEW -25P CTPX710	-25Q H210T	NEW -25Q CTPX710
		F CCGT	F CCGT	M CCGT	M CCGT	M CCGT
		70 255 ...	70 248 ...	70 248 ...	70 248 ...	70 248 ...
ISO	RE mm					
060202FN	0.2	652	636	70200		
060204FN	0.4	654	638	70400	678	75400
09T302FN	0.2		639	71400		
09T304FN	0.4	656	640	71600	680	76600
09T308FN	0.8	658	641	71800	681	76800
P				•		•
M				•		•
K		○	○		○	
N		•	•	•	•	•
S			○	•	○	•
H						
O		○	○		○	

CCXT / CCGT / CCMT / CCET

		-M81 CWN2120	-27 H10T	-27 CWN15	NEW -27 CTPX715	NEW -29 H216T	NEW -29 CTPX715	NEW -F05 CTPX710
		M CCXT	M CCGT	M CCGT	M CCGT	M CCMT	M CCMT	F CCET
		70 254 ...	70 254 ...	70 254 ...	70 254 ...	70 245 ...	70 245 ...	76 243 ...
ISO	RE mm							
060201FN	0.1							10100
060202FN	0.2	100	600	300	80200			10200
060204EN	0.4					60400	70400	
060204FN	0.4	102	602	302	80400			10400
09T302FN	0.2	104	604	304	81400			
09T304EN	0.4					61600	71600	
09T304FN	0.4	106	606	306	81600			
09T308EN	0.8					61800	71800	
09T308FN	0.8	108	608	308	81800			
P					•		•	•
M		•		○	•		•	•
K			○		○	○	○	
N		○	•	•	•	•	•	•
S					•		•	•
H								
O			○		○	○	○	

CCGT

Designation	L mm	S mm	D1 mm	IC mm
CCGT 0602..	6.4	2.38	2.8	6.35
CCGT 09T3..	9.7	3.97	4.4	9.52

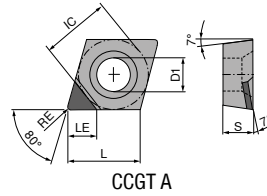

CCGT

▲ TCE(NOI) = Design and number of equipped cutting edge corners

ISO	RE mm	TCE (NOI)	LE mm	CCGT A					
				-CB1 CTDPD20	-CB1 CTDPD20	-Q-CB2 CTDPS30	-CB3 CTDPU20	-CB1 CTDCD10	-CB2 CTDCD10
				F DIAMOND CCGT 71 300 ...	F DIAMOND CCGT 71 305 ...	M DIAMOND CCGT 71 306 ...	R DIAMOND CCGT 71 302 ...	F DIAMOND CCGT 71 300 ...	M DIAMOND CCGT 71 301 ...
060202FN	0.2	A (1)	2.4					302	30200
060202FN	0.2	A (1)	3.3						
060202FN	0.2	A (1)	3.4	102					
060204FN	0.4	A (1)	2.2					304	304
060204FN	0.4	A (1)	3.1		104				
060204FN	0.4	A (1)	3.2	104			204		
060208FN	0.8	A (1)	2.0					30600	
060208FN	0.8	A (1)	3.0	10600					
09T302FN	0.2	A (1)	2.4						31200
09T302FN	0.2	A (1)	4.4						
09T302FN	0.2	A (1)	4.5	112					
09T304FN	0.4	A (1)	2.2					314	314
09T304FN	0.4	A (1)	4.2		114				
09T304FN	0.4	A (1)	4.3	114			214		
09T308FN	0.8	A (1)	2.0						31600
09T308FN	0.8	A (1)	4.1	118			218		
P									
M									
K									
N				•	•	•	•	•	•
S									
H									
O				•	•	•	•	•	•

MaxiLock-S – SCFC 90° – Toolholder with screw clamping

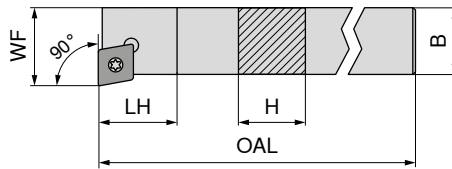

Illustrations show right-hand versions

ISO designation	H mm	B mm	OAL mm	LH mm	WF mm	torque moment Nm	Insert	Left-hand	Right-hand
								70 761 ...	70 760 ...
SCFC R 0808 D06	8	8	60	10	10	1,2	CC.. 0602		008
SCFC R/L 1010 E06	10	10	70	10	12	1,2	CC.. 0602	010	010
SCFC R/L 1212 F09	12	12	80	13	16	3,2	CC.. 09T3	012	012
SCFC R/L 1616 H09	16	16	100	13	20	3,2	CC.. 09T3	016	016

Key D	Combination Key	Clamping screw	Carbide type C	Threaded sleeve
80 950 ...	70 950 ...	70 950 ...	70 950 ...	70 950 ...

Spare parts for Article no.

70 760 008	110		112		
70 760 010 / 70 761 010	110		112		
70 760 012 / 70 761 012	113		113		
70 760 016 / 70 761 016		398	113	165	171

MaxiLock-S – SCAC 90° – Toolholder with screw clamping

▲ for sliding head lathes

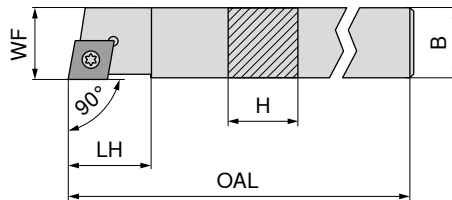

Illustrations show right-hand versions

ISO designation	H mm	B mm	OAL mm	LH mm	WF mm	torque moment Nm	Insert	Left-hand	Right-hand
								70 757 ...	70 756 ...
SCAC R/L 0808 D06	8	8	60	9	8	1,2	CC.. 0602	008	008
SCAC R/L 1010 E06	10	10	70	9	10	1,2	CC.. 0602	010	010
SCAC R/L 0808 K06	8	8	125	9	8	1,2	CC.. 0602	108	108
SCAC R/L 1010 M06	10	10	150	9	10	1,2	CC.. 0602	110	110
SCAC R/L 1212 F09	12	12	80	13	12	3,2	CC.. 09T3	012	012
SCAC R/L 1616 H09	16	16	100	13	16	3,2	CC.. 09T3	116	116
SCAC R/L 1212 M09	12	12	150	13	12	3,2	CC.. 09T3	112	112
SCAC R/L 1414 M09	14	14	150	13	14	3,2	CC.. 09T3	114	114

Key D	Combination Key	Clamping screw	Carbide type C	Threaded sleeve
80 950 ...	70 950 ...	70 950 ...	70 950 ...	70 950 ...

Spare parts for Article no.

70 756 108 / 70 757 108	110		112		
70 756 008 / 70 757 008	110		112		
70 756 110 / 70 757 110	110		112		
70 756 010 / 70 757 010	110		112		
70 756 112 / 70 757 112	113		113		
70 756 012 / 70 757 012	113		113		
70 756 114 / 70 757 114	113		113		
70 756 116 / 70 757 116		398	113	165	171

MaxiLock-S – SCAC 90° DC – Tool holder with screw clamping

▲ for sliding head lathes

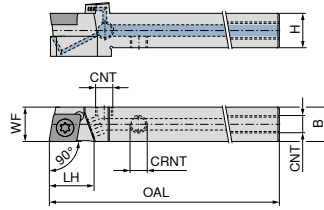
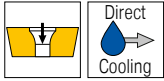

Illustrations show right-hand versions



NEW Left-hand **70 766 ...**
NEW Right-hand **70 766 ...**

ISO designation	H mm	B mm	OAL mm	LH mm	WF mm	CNT	CRNT	torque moment Nm	Insert	Left-hand	Right-hand
SCAC R/L 1212 F09 DC	12	12	80	13	12	M6	M6	3,2	CC.. 09T3	01201	01200
SCAC R/L 1212 M09 DC	12	12	150	13	12	M6	M6	3,2	CC.. 09T3	11201	11200
SCAC R/L 1616 H09 DC	16	16	100	13	16	G1/8"	M6	3,2	CC.. 09T3	01601	01600

Spare parts for Article no.

Article no.	Clamping screw	Carbide type C	Grubscrew	Grubscrew	Threaded sleeve
70 766 01200 / 70 766 01201	859			86700	
70 766 11200 / 70 766 11201	859			86700	
70 766 01600 / 70 766 01601	87900	165	88000	86700	171

Spare parts for Article no.

Article no.	Sealing plugs DC	Key D	O-Ring	Coolant nozzle DC	Coolant screw plug
70 766 01200 / 70 766 01201		120			
70 766 11200 / 70 766 11201		120			
70 766 01600 / 70 766 01601	87600	120	88100	87700	294

MaxiLock-S – SCDC 45° – Toolholder with screw clamping

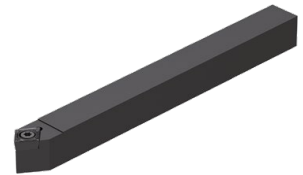
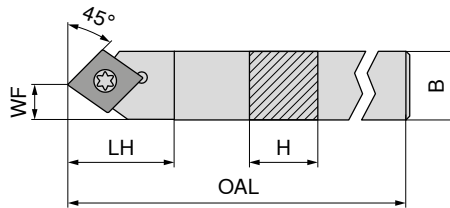

Neutral
70 752 ...

ISO designation	H mm	B mm	OAL mm	LH mm	WF mm	torque moment Nm	Insert	
SCDC L 0808 K06	8	8	125	13	4	1,2	CC.. 0602	008
SCDC L 1010 M06	10	10	150	13	5	1,2	CC.. 0602	010
SCDC L 1212 M09	12	12	150	18	6	3,2	CC.. 09T3	012
SCDC L 1414 M09	14	14	150	18	7	3,2	CC.. 09T3	014

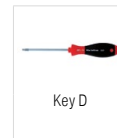

Key D

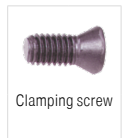

Clamping screw

80 950 ...

70 950 ...

Spare parts for Article no.

70 752 008	T08	110	M2,5x6	112
70 752 010	T08	110	M2,5x6	112
70 752 012	T15	113	M3,5x11	113
70 752 014	T15	113	M3,5x11	113

MaxiLock-S – SCDC 45° DC – Tool holder with screw clamping

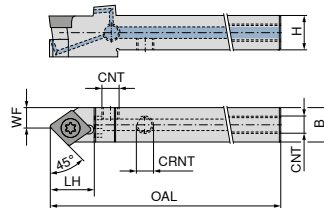

NEW
Neutral
70 767 ...

ISO designation	H mm	B mm	OAL mm	LH mm	WF mm	CNT	CRNT	torque moment Nm	Insert	
SCDC L 0808 K06 DC	8	8	125	13	4	M5	M5	1,2	CC.. 0602	00801
SCDC L 1010 M06 DC	10	10	150	13	5	M6	M6	1,2	CC.. 0602	01001
SCDC L 1212 M09 DC	12	12	150	18	6	M6	M6	3,2	CC.. 09T3	01201
SCDC L 1414 M09 DC	14	14	150	18	7	G1/8"	M6	3,2	CC.. 09T3	01401

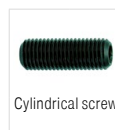

Cylindrical screw

83 950 ...

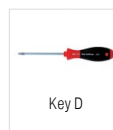

Key D

80 950 ...

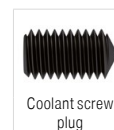

Coolant screw plug

70 950 ...

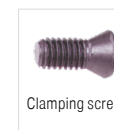

Clamping screw

70 950 ...



Grubscrew

70 950 ...

Spare parts for Article no.

70 767 00801	157	039	112	86700
70 767 01001		039	112	86700
70 767 01201		120	113	86700
70 767 01401		120	113	86700

MaxiLock-S – SCLC 95° – Toolholder with screw clamping

▲ for sliding head lathes

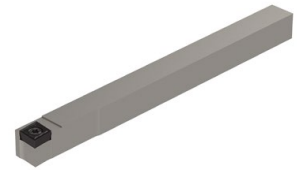
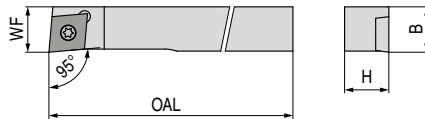

Illustrations show right-hand versions

ISO designation	H mm	B mm	OAL mm	WF mm	Insert
SCLC R/L 0808 H06	8	8	100	8	CC..0602
SCLC R/L 1010 H06	10	10	100	10	CC..0602
SCLC R/L 1212 H09	12	12	100	12	CC..09T3

Left-hand	Right-hand
72 353 ...	72 352 ...
008	008
010	010
012	012

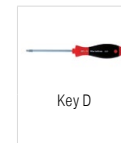

Key D

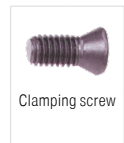

Clamping screw

Spare parts for Article no.

72 352 008 / 72 353 008	T08	110	M2,5x6	112
72 352 010 / 72 353 010	T08	110	M2,5x6	112
72 352 012 / 72 353 012	T15	113	M3,5x11	113

80 950 ...

70 950 ...

MaxiLock-S – SCLC 95° – Tool holder with thro' coolant

▲ for sliding head lathes

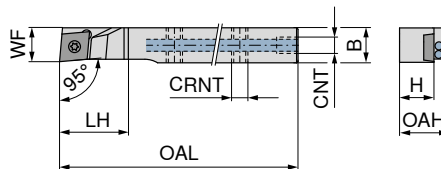

Illustrations show right-hand versions

ISO designation	H mm	B mm	OAL mm	LH mm	WF mm	CNT	CRNT	Insert
SCLC R/L 0808 H06 IC	8	8	100	16	8	M5	M5	CC..0602
SCLC R/L 1010 H06 IC	10	10	100	16	10	M5	M5	CC..0602
SCLC R/L 1212 H09 IC	12	12	100	19	12	M5	M5	CC..09T3
SCLC R/L 1616 K09 IC	16	16	125	19	16	M5	M5	CC..09T3

Left-hand	Right-hand
72 351 ...	72 350 ...
008	008
010	010
012	012
016	016



Cylindrical screw

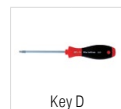

Key D



Clamping screw

Spare parts for Article no.

72 350 008 / 72 351 008	011	110	112
72 350 010 / 72 351 010	011	110	112
72 350 012 / 72 351 012	011	113	113
72 350 016 / 72 351 016	011	113	113

72 950 ...

80 950 ...

70 950 ...

MaxiLock-S – SCLC 95° – Boring bar with screw clamping

- ▲ A... = with thro' coolant
- ▲ S... = without thro' coolant

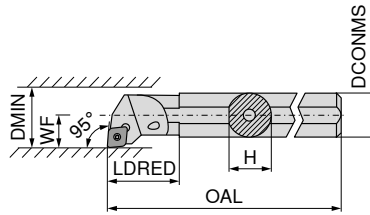

Illustrations show right-hand versions



ISO designation	DCONMS mm	H mm	OAL mm	LDRED mm	WF mm	DMIN mm	torque moment Nm	Insert	Left-hand	Right-hand
									70 717 ...	70 716 ...
A08F SCLC R/L 06	8	7.6	80	17	5	11	1,2	CC.. 0602	208	208
S08H SCLC R/L 06	8	7.2	100		5	11	1,2	CC.. 0602	008	008
A10H SCLC R/L 06	10	9.5	100	19	7	13	1,2	CC.. 0602	210	210
S10K SCLC R/L 06	10	9.0	125		7	13	1,2	CC.. 0602	010	010
A12K SCLC R/L 06	12	11.5	125	22	9	16	1,2	CC.. 0602	212	212
S12Q SCLC R/L 06	12	11.0	180		9	16	1,2	CC.. 0602	012	012
A16M SCLC R/L 06	16	14.0	150	50	9	18	1,2	CC.. 0602	116	116
A16M SCLC R/L 09	16	15.0	150	29	11	20	3,2	CC.. 09T3	216	216
S16R SCLC R/L 09	16	14.5	200		11	20	3,2	CC.. 09T3	016	016
A20Q SCLC R/L 09	20	18.5	180	32	13	25	3,2	CC.. 09T3	220	220
S20S SCLC R/L 09	20	18.0	250		13	25	3,2	CC.. 09T3	020	020
A25R SCLC R/L 09	25	23.0	200	36	17	32	3,2	CC.. 09T3	225	225
S25T SCLC R/L 09	25	23.0	300		17	32	3,2	CC.. 09T3	025	025

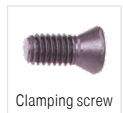
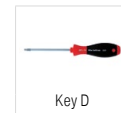

Spare parts for Article no.

	80 950 ...	70 950 ...
70 716 008 / 70 717 008	110	116
70 716 208 / 70 717 208	110	116
70 716 010 / 70 717 010	110	116
70 716 210 / 70 717 210	110	116
70 716 012 / 70 717 012	110	116
70 716 212 / 70 717 212	110	116
70 716 116 / 70 717 116	110	116
70 716 016 / 70 717 016	113	110
70 716 216 / 70 717 216	113	110
70 716 020 / 70 717 020	113	110
70 716 220 / 70 717 220	113	304
70 716 025 / 70 717 025	113	113
70 716 225 / 70 717 225	113	304

MaxiLock-S – SCLC 95° – Boring bar with screw clamping

▲ Type: Solid carbide

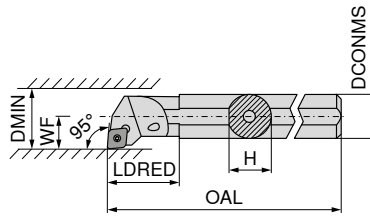

Illustrations show right-hand versions



ISO designation	DCONMS mm	H mm	OAL mm	LDRED mm	WF mm	DMIN mm	torque moment Nm	Insert	Left-hand	Right-hand
									70 719 ...	70 718 ...
E08H SCLC R/L 06	8	7.6	100		6	11	1,2	CC.. 0602	008	008
E10K SCLC R/L 06	10	9.0	125	22	7	13	1,2	CC.. 0602	010	010
E12Q SCLC R/L 06	12	11.5	180	26	9	16	1,2	CC.. 0602	012	012
E16R SCLC R/L 09	16	15.0	200	34	11	20	3,2	CC.. 09T3	016	016
E20S SCLC R/L 09	20	18.5	250	38	13	25	3,2	CC.. 09T3	020	020
E25T SCLC R/L 09	25	23.0	300	43	17	32	3,2	CC.. 09T3	025	025



Key D



Clamping screw

Spare parts for Article no.

Article no.	Key D	Clamping screw
70 719 008 / 70 718 008	T08	M2,5x5
70 719 010 / 70 718 010	T08	M2,5x5
70 719 012 / 70 718 012	T08	M2,5x5
70 719 016 / 70 718 016	T15	M3,5x7,2
70 719 020 / 70 718 020	T15	M3,5x8,6
70 719 025 / 70 718 025	T15	M3,5x11

MaxiLock-S – SCFC 90° – Boring bar with screw clamping

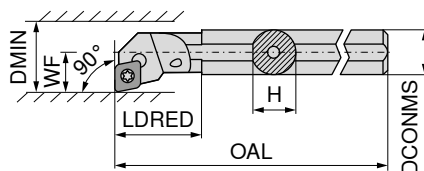

Illustrations show right-hand versions



ISO designation	DCONMS mm	H mm	OAL mm	LDRED mm	WF mm	DMIN mm	torque moment Nm	Insert	Left-hand	Right-hand
									70 793 ...	70 792 ...
A08F SCFC R/L 06	8	7.6	80	17	5	11	1,2	CC.. 0602	208	208
A10H SCFC R/L 06	10	9.5	100	19	7	13	1,2	CC.. 0602	210	210
A12K SCFC R/L 06	12	11.5	125	22	9	16	1,2	CC.. 0602	212	212



Key D



Clamping screw

Spare parts for Article no.

Article no.	Key D	Clamping screw
70 792 208 / 70 793 208	T08	M2,5x5
70 792 210 / 70 793 210	T08	M2,5x5
70 792 212 / 70 793 212	T08	M2,5x5

DCGT / DCMT / DCXT / DCET

Designation	L mm	S mm	D1 mm	IC mm
DC.T 0702..	7.75	2.38	2.8	6.35
DC.T 11T3..	11.60	3.97	4.4	9.52

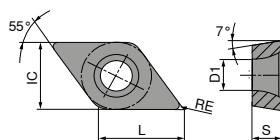

DCMT / DCGT

		NEW	NEW	NEW	NEW	NEW	NEW	
		-SF CTCP115-P	-SF CTCP125-P	-SF CTCP125-P	-SF CTCP135-P	-SMF CTCP115-P	-SMF CTCP125-P	-SMF CTCP135-P
		DRAGONSKIN	DRAGONSKIN	DRAGONSKIN	DRAGONSKIN	DRAGONSKIN	DRAGONSKIN	DRAGONSKIN
		F DCMT	F DCGT	F DCMT	F DCMT	F DCMT	F DCMT	F DCMT
		76 259 ...	76 257 ...	76 259 ...	76 259 ...	76 265 ...	76 265 ...	76 265 ...
ISO	RE mm							
070202EN	0.2		50201					
070204EN	0.4	30401		50401	70401		50401	70401
070208EN	0.8							70601
11T304EN	0.4	31601		51601	71601	31601	51601	71601
11T308EN	0.8	31801		51801	71801	31801	51801	71801
P		●	●	●	●	●	●	●
M					○			○
K		○	○	○	○	○	○	○
N								
S								
H								
O								

3

DCMT / DCGT

		NEW		NEW		NEW		NEW		NEW		NEW	
		-SM		-SM		-SM		-SM		-SMQ		-SMQ	
		CTCP115-P		CTCP125-P		CTCP125-P		CTCP135-P		CTCP135-P		CTCP115-P	
		DRAGONSKIN		DRAGONSKIN		DRAGONSKIN		DRAGONSKIN		DRAGONSKIN		DRAGONSKIN	
		M		M		M		M		M		M	
		DCMT		DCGT		DCMT		DCGT		DCMT		DCMT	
		76 258 ...		76 256 ...		76 258 ...		76 256 ...		76 258 ...		76 195 ...	
ISO	RE mm												
070202EN	0.2				50201			70201					
070204EN	0.4	30401				50401			70401		30401		50401
070208EN	0.8	30601				50601			70601				50401
11T304EL	0.4												51601
11T304EN	0.4	31601				51601			71601				51501
11T304ER	0.4												51701
11T308EN	0.8	31801				51801			71801				51801
11T312EN	1.2				52001								
P		●	●	●	●	●	●	●	●	●	●	●	●
M								○	○				
K		○	○	○							○		○
N													
S													
H													
O													

DCMT

		NEW		NEW		NEW		NEW	
		-M25		-M25		-M25		-M55	
		CTCM120		CTPM125		CTCM130		CTCM120	
		DRAGONSKIN		DRAGONSKIN		DRAGONSKIN		DRAGONSKIN	
		F		F		F		M	
		DCMT		DCMT		DCMT		DCMT	
		75 213 ...		75 213 ...		75 213 ...		75 214 ...	
ISO	RE mm								
070202EN	0.2		10200	202		30200			
070204EN	0.4		10400	204		30400		10400	204
070208EN	0.8							10600	206
11T302EN	0.2		11400	214		31400			
11T304EN	0.4		11600	216		31600		11600	216
11T308EN	0.8		11800	218		31800		11800	218
P			○	○	○	○	○	○	○
M			●	●	●	●	●	●	●
K									
N									
S						○			○
H									
O									



DCGT

ISO	RE mm	-FM37 WUU7610	-FM37 WPU7610	-FM37 WPU7620
0702006FN	0.06	006	706	506
0702015FN	0.15	015	715	515
0702035FN	0.35	035	735	535
11T3008FN	0.08	038	738	538
11T3015FN	0.15	045	745	
11T3035FN	0.35	065	765	565
P		○	●	●
M			●	○
K			○	●
N		●	○	○
S		○	●	○
H				
O		●	○	○

DCGT

ISO	RE mm	-23P H216T	-25P H210T	NEW -25P CTPX710 DRAGONSKIN	-25Q H210T	NEW -25Q CTPX710 DRAGONSKIN	-27 H10T	-27 CWN15
070202FN	0.2		632	70200			600	300
070204FN	0.4	654	634	70400			602	302
11T302FN	0.2		635	71400			604	304
11T304FL	0.4				670	75700		
11T304FN	0.4	664	636	71600	660	75600	606	306
11T304FR	0.4				680	75800		
11T308FL	0.8				672			
11T308FN	0.8	666	638	71800	662	76000	608	308
11T308FR	0.8				682			
P				●		●		
M				●		●		○
K		○	○		○		○	
N		●	●	●	●	●	●	●
S			○	●	○	●		
H								
O		○	○		○		○	

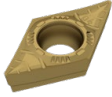
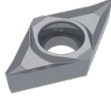
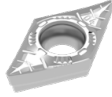
DCXT / DCGT / DCMT / DCET

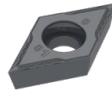
		-M81 CWN2120	NEW -27 CTPX715 DRAGONSKIN	NEW -29 H216T	NEW -29 CTPX715 DRAGONSKIN	NEW -F05 CTPX710 DRAGONSKIN
						
		M DCXT	M DCGT	M DCMT	M DCMT	F DCET
		70 260 ...	70 260 ...	70 246 ...	70 246 ...	76 254 ...
ISO	RE mm					
0702005FN	0.05					10200
070201FN	0.10					10400
0702015FN	0.15					10600
070202FN	0.20	100	80200			10800
070204FN	0.40	102	80400			
070204EN	0.40			60400	70400	
11T3005FN	0.05					11400
11T301FN	0.10					11600
11T3015FN	0.15					11800
11T302FN	0.20	104	81400			12000
11T304EN	0.40			61600	71600	
11T304FN	0.40	106	81600			12200
11T308EN	0.80			61800	71800	
11T308FN	0.80	108	81800			
P			●		●	●
M		●			●	●
K			○	○	○	
N		○	●	●	●	●
S			●		●	●
H						
O			○	○	○	

DCGT

Designation	L mm	S mm	D1 mm	IC mm
DCGT 0702..	7.75	2.38	2.8	6.35
DCGT 11T3..	11.60	3.97	4.4	9.52

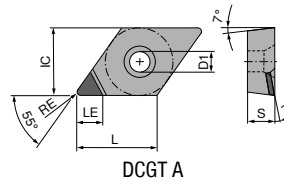

DCGT

▲ TCE(NOI) = Design and number of equipped cutting edge corners

-CB1 CTDPD20	-CB1 CTDPS30	-CB2 CTDPS30	-CB3 CTDPU20	-CB1 CTDCD10	-CB2 CTDCD10
F DIAMOND DCGT	F DIAMOND DCGT	M DIAMOND DCGT	R DIAMOND DCGT	F DIAMOND DCGT	M DIAMOND DCGT
71 310 ...	71 310 ...	71 311 ...	71 312 ...	71 310 ...	71 311 ...

ISO	RE mm	TCE (NOI)	LE mm	71 310 ...	71 310 ...	71 311 ...	71 312 ...	71 310 ...	71 311 ...
070201FN	0.1	A (1)	3.8	10100	20100				
070202FN	0.2	A (1)	2.6					302	30200
070202FN	0.2	A (1)	3.7	102	202	202		304	304
070204FN	0.4	A (1)	2.3						
070204FN	0.4	A (1)	3.4	104	204	204	204		
070208FN	0.8	A (1)	2.0						308
070208FN	0.8	A (1)	3.0	108		208			
11T301FN	0.1	A (1)	4.8	11100	21100	21100			
11T302FN	0.2	A (1)	2.6					31200	31200
11T302FN	0.2	A (1)	4.7	112	212	212			
11T304FN	0.4	A (1)	2.3						
11T304FN	0.4	A (1)	4.3	114	214	214	214		
11T308FN	0.8	A (1)	2.0						318
11T308FN	0.8	A (1)	4.0	118	218	218	218	318	318

P									
M									
K									
N				•	•	•	•	•	•
S									
H									
O				•	•	•	•	•	•

3

MaxiLock-S – SDJC 93° – Toolholder with screw clamping

▲ for sliding head lathes

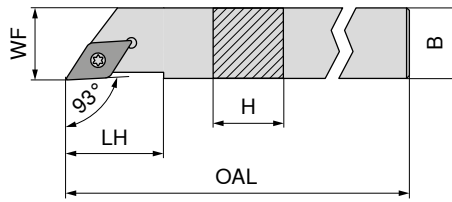

Illustrations show right-hand versions

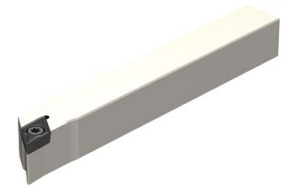

ISO designation	H mm	B mm	OAL mm	LH mm	WF mm	torque moment Nm	Insert
SDJC R/L 0808 H07	8	8	100	13.0	8	1,2	DC.. 0702
SDJC R/L 1010 H07	10	10	100	13.0	10	1,2	DC.. 0702
SDJC R/L 1212 H07	12	12	100	14.5	12	1,2	DC.. 0702
SDJC R/L 1616 K07	16	16	125	33.0	16	1,2	DC.. 0702
SDJC R/L 1212 H11	12	12	100	22.0	12	3,2	DC.. 11T3
SDJC R/L 1616 K11	16	16	125	33.0	16	3,2	DC.. 11T3
SDJC R/L 2020 K11	20	20	125		20		DC.. 11T3

Left-hand	Right-hand
70 685 ...	70 684 ...
108	108
110	110
112	112
116	116
212	212
216	216
220	220

Spare parts

Insert

DC.. 0702	T08	110	002
DC.. 11T3	T15	113	006

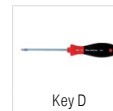

Key D



Clamping screw

80 950 ...

72 950 ...

MaxiLock-S – SDJC 93° – Tool holder with thro' coolant

▲ for sliding head lathes

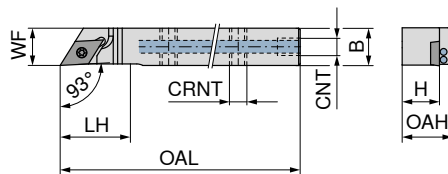

Illustrations show right-hand versions



ISO designation	H mm	B mm	OAL mm	LH mm	WF mm	CNT	CRNT	Insert
SDJC L 0808 H07 IC	8	8	100	17	8	M5	M5	DC.. 0702
SDJC R/L 1010 H07 IC	10	10	100	17	10	M5	M5	DC.. 0702
SDJC R/L 1212 H07 IC	12	12	100	17	12	M5	M5	DC.. 0702
SDJC R/L 1616 K07 IC	16	16	125	17	16	G1/8"	M5	DC.. 0702
SDJC R/L 1010 H11 IC	10	10	100	22	10	M5	M5	DC.. 11T3
SDJC R/L 1212 H11 IC	12	12	100	22	12	M5	M5	DC.. 11T3
SDJC R/L 1616 K11 IC	16	16	125	22	16	G1/8"	M5	DC.. 11T3
SDJC R/L 2020 K11 IC	20	20	125	22	20	G1/8"	M5	DC.. 11T3

Left-hand	Right-hand
72 357 ...	72 356 ...
008	
010	010
012	012
016	016
110	110
112	112
116	116
120	120

Spare parts

Insert CNT

DC.. 0702 M5			
DC.. 0702 G1/8"	010	011	002
DC.. 11T3 M5		011	006
DC.. 11T3 G1/8"	010	011	006



Cylindrical screw



Cylindrical screw



Key D



Clamping screw

72 950 ...

72 950 ...

80 950 ...

72 950 ...

MaxiLock-S – SDAC 90° – Toolholder with screw clamping

▲ for sliding head lathes

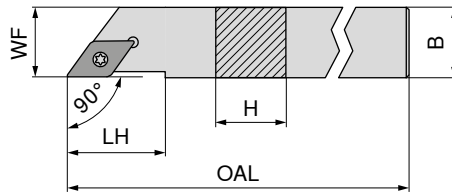

Illustrations show right-hand versions



ISO designation	H mm	B mm	OAL mm	LH mm	WF mm	torque moment Nm	Insert	Left-hand	Right-hand
								70 789 ...	70 788 ...
SDAC R/L 0808 K07	8	8	125	14	8	1,2	DC.. 0702	008	008
SDAC R/L 1010 M07	10	10	150	14	10	1,2	DC.. 0702	010	010
SDAC R/L 1212 M07	12	12	150	14	12	1,2	DC.. 0702	012	012
SDAC R/L 1414 M11	14	14	150	21	14	3,2	DC.. 11T3	014	014

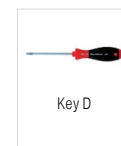

Key D

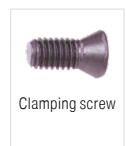

Clamping screw

**Spare parts
for Article no.**

		80 950 ...		70 950 ...
70 788 008 / 70 789 008	T08	110	M2,5x6	112
70 788 010 / 70 789 010	T08	110	M2,5x6	112
70 788 012 / 70 789 012	T08	110	M2,5x6	112
70 788 014 / 70 789 014	T15	113	M3,5x11	113

MaxiLock-S – SDAC 90° DC – Tool holder with screw clamping

▲ for sliding head lathes

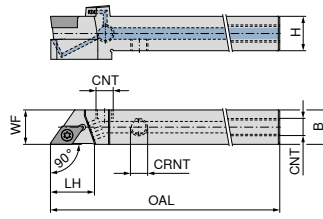
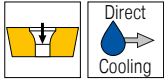

Illustrations show right-hand versions



ISO designation	H mm	B mm	OAL mm	LH mm	WF mm	CNT	CRNT	torque moment Nm	Insert	NEW Left-hand 70 771 ...	NEW Right-hand 70 771 ...
SDAC R/L 0808 K07 DC	8	8	125	14	8	M5	M5	1,2	DC.. 0702	00801	00800
SDAC R/L 1010 M07 DC	10	10	150	14	10	M6	M6	1,2	DC.. 0702	01001	01000
SDAC R/L 1212 M07 DC	12	12	150	14	12	M6	M6	1,2	DC.. 0702	01201	01200
SDAC R/L 1212 M11 DC	12	12	150	21	12	M6	M6	3,2	DC.. 11T3	11201	11200

Spare parts for Article no.

Article no.	Cylindrical screw 83 950 ...	Key D 80 950 ...	Clamping screw 70 950 ...	Grubscrew 70 950 ...
70 771 00800	157	110	112	
70 771 00801	157	039	112	
70 771 01000 / 70 771 01001		039	112	86700
70 771 01200 / 70 771 01201		039	112	86700
70 771 11200 / 70 771 11201		113	113	86700



MaxiLock-S – SDNC 62.5° – Toolholder with screw clamping

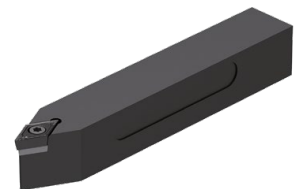
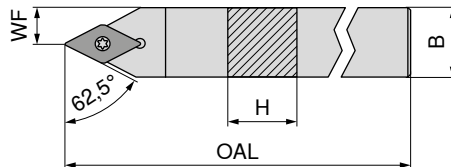

ISO designation	H mm	B mm	OAL mm	WF mm	torque moment Nm	Insert	Neutral 70 680 ...
SDNC N 0808 D07	8	8	60	4.0	1,2	DC.. 0702	008
SDNC N 1010 E07	10	10	70	5.0	1,2	DC.. 0702	010
SDNC N 1212 F07	12	12	80	6.0	1,2	DC.. 0702	012
SDNC N 1616 H11	16	16	100	8.0	3,2	DC.. 11T3	016
SDNC N 2020 K11	20	20	125	10.0	3,2	DC.. 11T3	020
SDNC N 2525 M11	25	25	150	12.5	3,2	DC.. 11T3	025

Spare parts for Article no.

Article no.	Key D 80 950 ...	Combination Key 70 950 ...	Clamping screw 70 950 ...	Solid Carbide Seat D 70 950 ...	Threaded sleeve 70 950 ...
70 680 008	110		112		
70 680 010	110		112		
70 680 012	110		112		
70 680 016		398	113	106	171
70 680 020		398	113	106	171
70 680 025		398	113	106	171

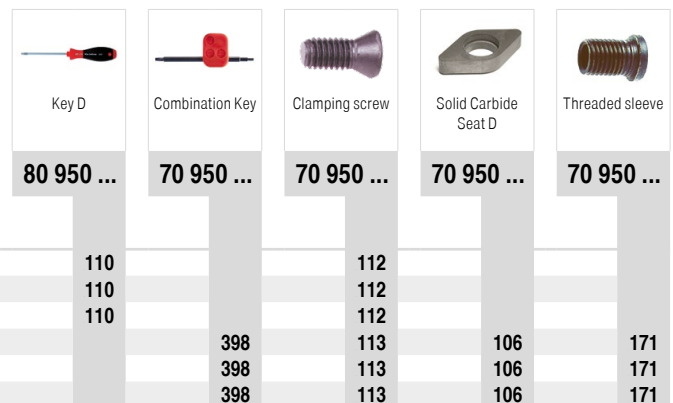

MaxiLock-S – SDNC 62.5° DC – Tool holder with screw clamping

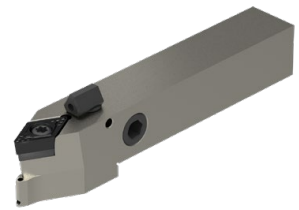
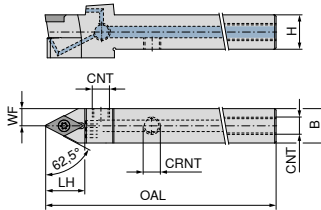

NEW
Neutral
70 774 ...

ISO designation	H mm	B mm	OAL mm	WF mm	CNT	CRNT	torque moment Nm	Insert	
SDNC N 1212 F07 DC	12	12	80	6.0	M6	M6	1,2	DC.. 0702	01200
SDNC N 1212 M07 DC	12	12	150	6.0	M6	M6	1,2	DC.. 0702	11200
SDNC N 1212 M11 DC	12	12	150	6.0	M6	M6	3,2	DC.. 11T3	21200
SDNC N 1616 H11 DC	16	16	100	8.0	G1/8"	M6	3,2	DC.. 11T3	01600
SDNC N 2020 K11 DC	20	20	125	10.0	G1/8"	M6	3,2	DC.. 11T3	02000
SDNC N 2525 M11 DC	25	25	150	12.5	G1/8"	M6	3,2	DC.. 11T3	02500

Spare parts for Article no.

Article no.	Clamping screw	Solid Carbide Seat D	Grubscrew	Grubscrew	Threaded sleeve
70 774 01200	857			86700	
70 774 11200	857			86700	
70 774 01600	87900	106	88000	86700	171
70 774 02000	87900	106	88000	86700	171
70 774 21200	859			86700	
70 774 02500	87900	106	88000	86700	171

Spare parts for Article no.

Article no.	Sealing plugs DC	Key D	O-Ring	Coolant nozzle DC	Coolant screw plug
70 774 01200		039			
70 774 11200		039			
70 774 01600	87600	120	88100	87700	294
70 774 02000	87600	120	88100	87700	294
70 774 21200		120			
70 774 02500	87600	120	88100	87700	294

MaxiLock-S – SDNC 62.5° – Toolholder with screw clamping

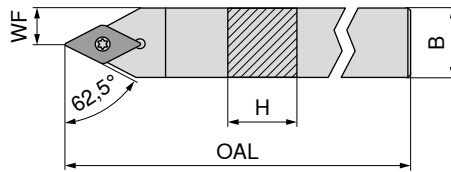

Neutral
70 784 ...

ISO designation	H mm	B mm	OAL mm	WF mm	torque moment Nm	Insert	
SDNC N 0808 K07	8	8	125	4	1,2	DC.. 0702	008
SDNC N 1010 M07	10	10	150	5	1,2	DC.. 0702	010
SDNC N 1212 M07	12	12	150	6	1,2	DC.. 0702	012
SDNC N 1414 M11	14	14	150	7	3,2	DC.. 11T3	014

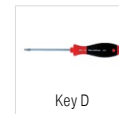

80 950 ...

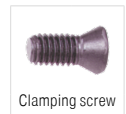

Clamping screw

70 950 ...

Spare parts for Article no.				
70 784 008	T08	110	M2,5x6	112
70 784 010	T08	110	M2,5x6	112
70 784 012	T08	110	M2,5x6	112
70 784 014	T15	113	M3,5x11	113

MaxiLock-S – SDUC 93° – Boring bar with screw clamping

- ▲ A... = with thro' coolant
- ▲ S... = without thro' coolant

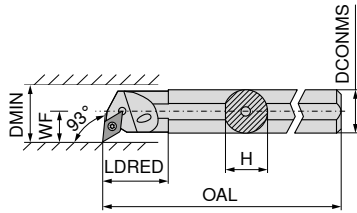

Illustrations show right-hand versions



ISO designation	DCONMS mm	H mm	OAL mm	LDRED mm	WF mm	DMIN mm	torque moment Nm	Insert
S12Q SDUC R/L 07	12	11.0	180		9	17	1,2	DC.. 0702
A12K SDUC R/L 07	12	11.5	125	22	9	16	1,2	DC.. 0702
S16R SDUC R/L 07	16	15.0	200		11	21	1,2	DC.. 0702
A16M SDUC R/L 07	16	15.0	150	29	11	20	1,2	DC.. 0702
S20S SDUC R 07	20	18.0	250		13	25	1,2	DC.. 0702
A20Q SDUC R/L 07	20	18.5	180	32	13	25	1,2	DC.. 0702
S20S SDUC R 11	20	18.0	250		13	25	3,2	DC.. 11T3
A20Q SDUC R/L 11	20	18.5	180	32	13	25	3,2	DC.. 11T3

Left-hand 70 737 ...	Right-hand 70 736 ...
012	012
212	212
016	016
216	216
	020
220	220
	120
320	320

Spare parts

Insert

- DC.. 0702
- DC.. 11T3

Key D	Clamping screw
80 950 ...	70 950 ...
110	112
113	110

MaxiLock-S – SDUC 93° – Boring bar with screw clamping

- ▲ Type: Solid carbide

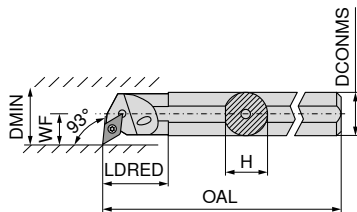

Illustrations show right-hand versions



ISO designation	DCONMS mm	H mm	OAL mm	LDRED mm	WF mm	DMIN mm	torque moment Nm	Insert
E12Q SDUC R/L 07	12	11.5	180	26	9	16	1,2	DC.. 0702
E16R SDUC R/L 07	16	15.0	200	34	11	20	1,2	DC.. 0702
E20S SDUC R/L 11	20	18.5	250	38	13	25	3,2	DC.. 11T3
E25T SDUC R/L 11	25	23.0	300	43	17	32	3,2	DC.. 11T3

Left-hand 70 739 ...	Right-hand 70 738 ...
012	012
016	016
120	120
125	125

Spare parts
for Article no.

- 70 739 012 / 70 738 012
- 70 739 016 / 70 738 016
- 70 739 120 / 70 738 120
- 70 739 125 / 70 738 125

Key D	Clamping screw
80 950 ...	70 950 ...
110	112
110	112
113	304
113	113

MaxiLock-S – SDQC 107.5° – Boring bar with screw clamping

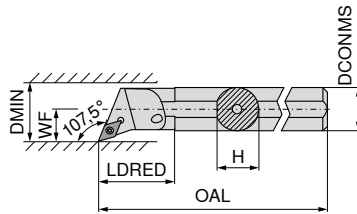

Illustrations show right-hand versions



ISO designation	DCONMS mm	H mm	OAL mm	LDRED mm	WF mm	DMIN mm	torque moment Nm	Insert	Left-hand	Right-hand
									70 741 ...	70 740 ...
A10H SDQC R/L 07	10	9.0	100	22	7	12.5	1,2	DC.. 0702	210	210
A12K SDQC R/L 07	12	11.5	125	22	9	16.0	1,2	DC.. 0702	212	212
A16M SDQC R/L 07	16	15.0	150	29	11	20.0	1,2	DC.. 0702	216	216
A20Q SDQC R/L 07	20	18.5	180	32	13	25.0	1,2	DC.. 0702	220	220
A25R SDQC R/L 11	25	23.0	200	36	17	32.0	3,2	DC.. 11T3	225	225

Spare parts for Article no.

Article no.	80 950 ...	70 950 ...	70 950 ...	70 950 ...	70 950 ...
70 740 210 / 70 741 210	110			112	
70 740 212 / 70 741 212	110			112	
70 740 216 / 70 741 216	110			112	
70 740 220 / 70 741 220	110			112	
70 740 225 / 70 741 225		398		113	171

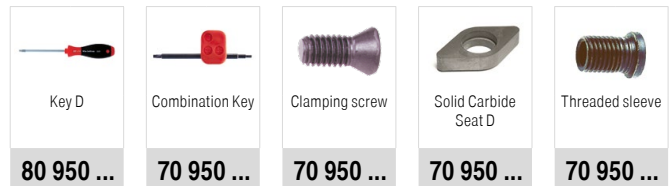

MaxiLock-S – SDXC 93° – Boring bar with screw clamping

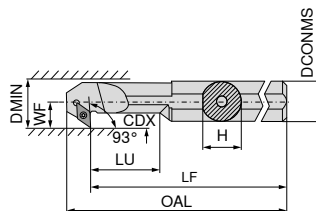

Illustrations show right-hand versions



ISO designation	DCONMS mm	H mm	LF mm	OAL mm	LU mm	WF mm	DMIN mm	CDX mm	torque moment Nm	Insert	Left-hand	Right-hand
											70 733 ...	70 732 ...
A12K SDXC R/L 07	12	11.5	125	137.0	24	9	16	4.5	1,2	DC.. 0702	212	212
A16M SDXC R/L 07	16	15.0	150	162.0	36	11	20	4.5	1,2	DC.. 0702	216	216
A20Q SDXC R/L 11	20	18.5	180	196.5	40	13	25	6.5	3,2	DC.. 11T3	220	220
A25R SDXC R/L 11	25	23.0	200	216.8	50	17	32	9.5	3,2	DC.. 11T3	225	225

Spare parts for Article no.

Article no.	80 950 ...	70 950 ...
70 733 212 / 70 732 212	110	112
70 733 216 / 70 732 216	110	112
70 733 220 / 70 732 220	113	304
70 733 225 / 70 732 225	113	304

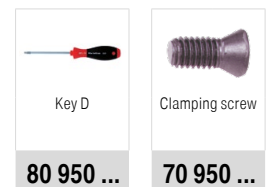

TCMT / TCGT

Designation	L mm	S mm	D1 mm	IC mm
TCMT 0902..	9.6	2.38	2.5	5.56
TC.T 1102..	11.0	2.38	2.8	6.35

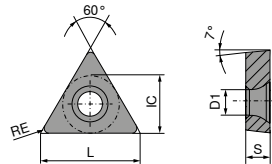



TCMT / TCGT

		NEW	NEW	NEW	NEW	NEW	NEW
		-SF CTCP125-P	-SMF CTCP115-P	-SMF CTCP135-P	-SM CTCP115-P	-SM CTCP125-P	-SM CTCP135-P
		DRAGONSKIN	DRAGONSKIN	DRAGONSKIN	DRAGONSKIN	DRAGONSKIN	DRAGONSKIN
		F TCMT	F TCMT	F TCMT	M TCMT	M TCMT	M TCGT
		76 275 ...	76 284 ...	76 284 ...	76 274 ...	76 274 ...	76 270 ...
ISO	RE mm						
090204EN	0.4					50401	70401
110202EN	0.2						71401
110204EN	0.4	51601			31601	51601	71601
110208EN	0.8	51801	31801	71801	31801		71801
P		●	●	○	●	●	●
M				○			○
K		○	○		○	○	
N							
S							
H							
O							

TCMT

		NEW		NEW	NEW	NEW
		-M25 CTCM120	-M25 CTPM125	-M25 CTCM130	-M55 CTCM120	-M55 CTPM125
		DRAGONSKIN	DRAGONSKIN	DRAGONSKIN	DRAGONSKIN	DRAGONSKIN
		F TCMT	F TCMT	F TCMT	M TCMT	M TCMT
		75 217 ...	75 217 ...	75 217 ...	75 218 ...	75 218 ...
ISO	RE mm					
090204EN	0.4				10400	204
110204EN	0.4	11600	216	31600	11600	216
P		○	○	○	○	○
M		●	●	●	●	●
K						
N						
S				○		○
H						
O						

TCGT

		NEW
-27 H10T	-27 CWN15	-27 CTPX715
○ ○ ⊕	○ ○ ⊕	DRAGONSKIN ○ ○ ⊕
		
M TCGT	M TCGT	M TCGT
70 276 ...	70 276 ...	70 276 ...
600	300	71400
602	302	81600

ISO	RE mm			
110202FN	0.2			
110204FN	0.4			
P				●
M			○	●
K		○		○
N		●	●	●
S				●
H				
O		○		○

TCGT / TCGW

Designation	L mm	S mm	D1 mm	IC mm
TCG. 0902..	9.6	2.38	2.5	5.56
TCG. 1102..	11.0	2.38	2.8	6.35

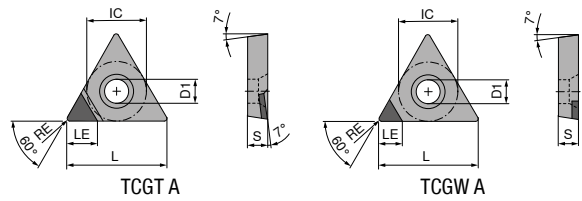

TCGW / TCGT

▲ TCE(NOI) = Design and number of equipped cutting edge corners

ISO	RE mm	TCE (NOI)	LE mm	Insert Options				
				CTDPD20	CTDPD20	-CB1 CTDPD20	-CB2 CTDPS30	CTDPS30
090202FN	0.2	A (1)	3.7	100	100	112	212	20001
090204FN	0.4	A (1)	3.4	102	102	114	214	20101
090208FN	0.8	A (1)	3.0	104	10001			
110202FN	0.2	A (1)	3.7	106	10101	122	222	
110204FN	0.4	A (1)	3.4	108	10201	124	224	20201
110208FN	0.8	A (1)	3.0	110	10301			

Material	CTDPD20	CTDPD20	-CB1 CTDPD20	-CB2 CTDPS30	CTDPS30
P					
M					
K					
N	•	•	•	•	•
S					
H					
O	•	•	•	•	•

3

MaxiLock-S – STAC 90° – Toolholder with screw clamping

▲ for sliding head lathes

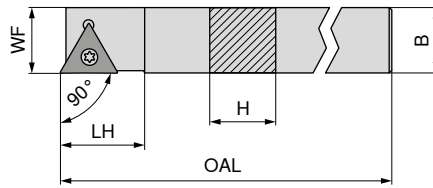

Illustrations show right-hand versions



ISO designation	H mm	B mm	OAL mm	LH mm	WF mm	torque moment Nm	Insert
STAC R/L 1010 K09	10	10	125	12	10	1	TC.. 0902
STAC R/L 1212 K11	12	12	125	15	12	1,2	TC.. 1102
STAC R 1414 K11	14	14	125	15	14	1,2	TC.. 1102

Left-hand	Right-hand
70 769 ...	70 768 ...
010	010
012	012
	014

Spare parts for Article no.

70 769 012 / 70 768 012	T08	110	M2,5x6	112
70 768 014	T08	110	M2,5x6	112

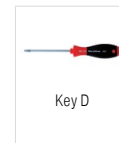

80 950 ...

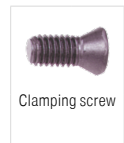

70 950 ...

MaxiLock-S – STCC 90° – Toolholder with screw clamping

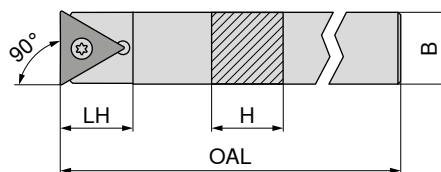

ISO designation	H mm	B mm	OAL mm	LH mm	torque moment Nm	Insert
STCC N 0808 K09	8	8	125	11	1	TC.. 0902
STCC N 1010 K11	10	10	125	15	1,2	TC.. 1102
STCC N 1212 K11	12	12	125	15	1,2	TC.. 1102
STCC N 1414 K11	14	14	125	21	1,2	TC.. 1102
STCC N 1616 K11	16	16	125	24	1,2	TC.. 1102

Neutral
70 782 ...
008
010
012
014
016

Spare parts for Article no.

70 782 010	T08	110	M2,5x6	112
70 782 012	T08	110	M2,5x6	112
70 782 014	T08	110	M2,5x6	112
70 782 016	T08	110	M2,5x6	112

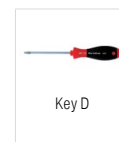

80 950 ...

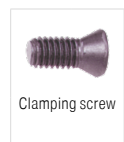

70 950 ...

MaxiLock-S – STFC 90° – Boring bar with screw clamping

- ▲ A... = with thro' coolant
- ▲ S... = without thro' coolant

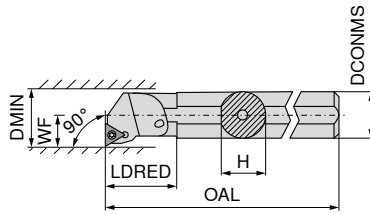

Illustrations show right-hand versions



ISO designation	DCONMS mm	H mm	OAL mm	LDRED mm	WF mm	DMIN mm	torque moment Nm	Insert	Left-hand	Right-hand
									70 729 ...	70 728 ...
A10H STFC R/L 09	10	9.5	100	19	7	13	1	TC.. 0902	210	210
A12K STFC R/L 11	12	11.5	125	22	9	16	1,2	TC.. 1102	212	212
A16M STFC R/L 11	16	15.0	150	29	11	20	1,2	TC.. 1102	216	216

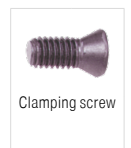
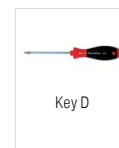

**Spare parts
for Article no.**

Article no.	Key D	Clamping screw
70 729 212 / 70 728 212	T08	110 M2,5x6
70 729 216 / 70 728 216	T08	110 M2,5x6

VC GT / VC MT / VC ET

Designation	L mm	S mm	D1 mm	IC mm
VC.T 1103..	11.1	3.18	2.9	6.35

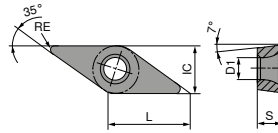

VC GT / VC MT

		NEW	NEW	NEW	NEW	NEW	NEW
		-SF CTCP115-P	-SF CTCP125-P	-SF CTCP135-P	-SMF CTCP115-P	-SMF CTCP125-P	-SMF CTCP135-P
		DRAGONSKIN	DRAGONSKIN	DRAGONSKIN	DRAGONSKIN	DRAGONSKIN	DRAGONSKIN
		F VCGT	F VCGT	F VCGT	F VCMT	F VCMT	F VCMT
		76 277 ...	76 277 ...	76 277 ...	76 288 ...	76 288 ...	76 285 ...
ISO	RE mm						
110302EN	0.2	31401	51401	71401			71401
110304EN	0.4	31601	51601	71601	31601	51601	
110308EN	0.8	31801	51801	71801			71601
P		•	•	•	•	•	•
M				○			○
K		○	○		○	○	
N							
S							
H							
O							

VC GT

			NEW				NEW
		-25P H210T	-25P CTPX710	-25Q H210T	-27 H10T	-27 CWN15	-27 CTPX715
			DRAGONSKIN				DRAGONSKIN
		F VCGT	M VCGT	M VCGT	M VCGT	M VCGT	M VCGT
		70 282 ...	70 282 ...	70 282 ...	70 280 ...	70 280 ...	70 280 ...
ISO	RE mm						
110302FN	0.2		71400		606	306	81400
110304FL	0.4	638		670			
110304FN	0.4	640	71600		608	308	81600
110304FR	0.4			680			
110308FN	0.8				610	310	71800
P			•				•
M			•			○	•
K		○		○	○		○
N		•	•	•	•	•	•
S		○	•	○			•
H							
O		○		○	○		○

VCET

NEW

-F05
CTPX710

DRAGONSKIN



F
VCET
76 255 ...

ISO	RE mm	
1103005FN	0.05	11400
1103015FN	0.15	11800
110301FN	0.10	11600
110302FN	0.20	12000
110304FN	0.40	12200
P		•
M		•
K		
N		•
S		•
H		
O		

VCGT

Designation	L mm	S mm	D1 mm	IC mm
VCGT 1103..	11.1	3.18	2.9	6.35

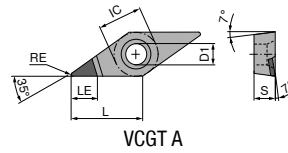

VCGT

▲ TCE(NOI) = Design and number of equipped cutting edge corners

ISO	RE mm	TCE (NOI)	LE mm	-CB1 CTDPD20		-CB1 CTDPS30		-CB2 CTDPS30		-CB3 CTDPU20		-CB1 CTDCD10		-CB2 CTDCD10	
				Diagram	Image	Diagram	Image	Diagram	Image	Diagram	Image	Diagram	Image	Diagram	Image
				F	F	M	R	F	M						
				DIAMOND VCGT		DIAMOND VCGT		DIAMOND VCGT		DIAMOND VCGT		DIAMOND VCGT		DIAMOND VCGT	
				71 330 ...		71 330 ...		71 331 ...		71 332 ...		71 330 ...		71 331 ...	
110301FN	0.1	A (1)	3.0										31000		
110301FN	0.1	A (1)	5.4	11000									312	312	
110302FN	0.2	A (1)	3.0										314		
110302FN	0.2	A (1)	4.6	112	21200	212							314		
110304FN	0.4	A (1)	3.0												
110304FN	0.4	A (1)	3.9	114	214	214		214							
110308FN	0.8	A (1)	3.3					21800							
P															
M															
K															
N				•	•	•	•	•	•	•	•	•	•	•	•
S															
H															
O				•	•	•	•	•	•	•	•	•	•	•	•

MaxiLock-S – SVJC 93° – Toolholder with screw clamping

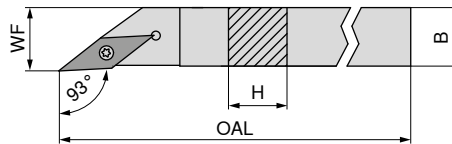

Illustrations show right-hand versions

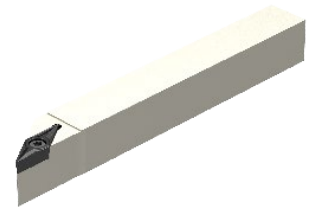

ISO designation	H mm	B mm	OAL mm	WF mm	torque moment Nm	Insert	Left-hand 70 697 ...	Right-hand 70 696 ...
SVJC R/L 0808 H11	8	8	100	8	1,2	VC.. 1103	008	008
SVJC R/L 1010 H11	10	10	100	10	1,2	VC.. 1103	010	010
SVJC R/L 1212 H11	12	12	100	12	1,2	VC.. 1103	112	112
SVJC R/L 1616 K11	16	16	125	16	1,2	VC.. 1103	116	116



Key D



Clamping screw

80 950 ...

70 950 ...

110

112

Spare parts

Insert

VC.. 1103

MaxiLock-S – SVAC 90° – Toolholder with screw clamping

▲ for sliding head lathes

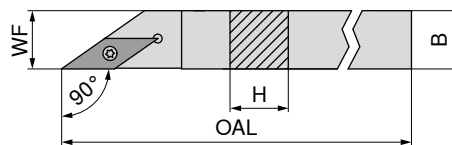

Illustrations show right-hand versions

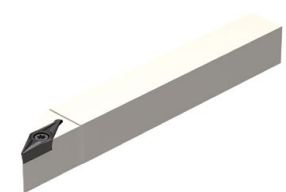

ISO designation	H mm	B mm	OAL mm	WF mm	torque moment Nm	Insert	Left-hand 70 695 ...	Right-hand 70 694 ...
SVAC R/L 0808 H11	8	8	100	8	1,2	VC.. 1103	008	008
SVAC R/L 1010 H11	10	10	100	10	1,2	VC.. 1103	010	010
SVAC R/L 1212 H11	12	12	100	12	1,2	VC.. 1103	012	012



Key D



Clamping screw

80 950 ...

70 950 ...

Spare parts

for Article no.

70 694 008 / 70 695 008	T08	110	M2,5x6	112
70 694 010 / 70 695 010	T08	110	M2,5x6	112
70 694 012 / 70 695 012	T08	110	M2,5x6	112

MaxiLock-S – SVVC 72.5° – Toolholder with screw clamping

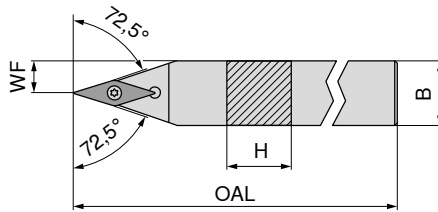

Neutral
70 692 ...

ISO designation	H mm	B mm	OAL mm	WF mm	torque moment Nm	Insert
SVVC N 1212 F11	12	12	80	6	1,2	VC.. 1103
SVVC N 1616 H11	16	16	100	8	1,2	VC.. 1103
SVVC N 2020 K11	20	20	125	10	1,2	VC.. 1103

012
016
020

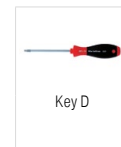

80 950 ...

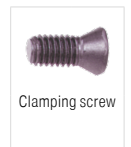

70 950 ...

Spare parts for Article no.

70 692 012	110	112
70 692 016	110	112
70 692 020	110	112

MaxiLock-S – SVXC 91° – Toolholder with screw clamping

▲ for sliding head lathes

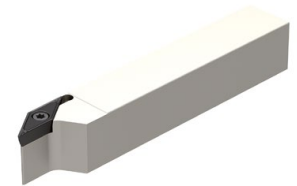
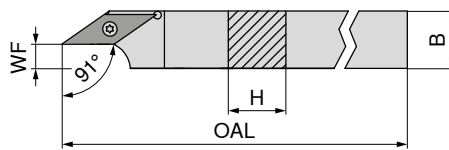

Illustrations show right-hand versions

ISO designation	H mm	B mm	OAL mm	WF mm	torque moment Nm	Insert
SVXC R/L 1010 H11	10	10	100	2.5	1,2	VC.. 1103
SVXC R/L 1212 H11	12	12	100	4.5	1,2	VC.. 1103
SVXC R/L 1616 K11	16	16	125	8.5	1,2	VC.. 1103

Left-hand
70 691 ...

Right-hand
70 690 ...

010
012
016

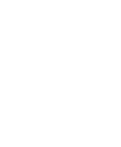

80 950 ...

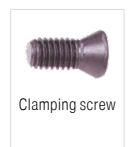

70 950 ...

Spare parts for Article no.

70 691 010 / 70 690 010	T08	110	M2,5x6	112
70 691 012 / 70 690 012	T08	110	M2,5x6	112
70 691 016 / 70 690 016	T08	110	M2,5x6	112

MaxiLock-S – SVJC 93° DC – Tool holder with screw clamping

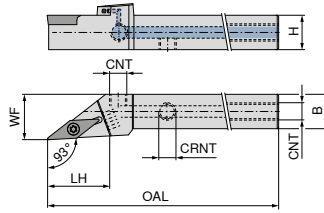

Illustrations show right-hand versions

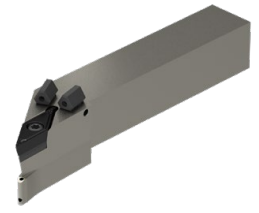

NEW
Left-hand **70 780 ...**
NEW
Right-hand **70 780 ...**

ISO designation	H mm	B mm	OAL mm	WF mm	CNT	CRNT	torque moment Nm	Insert		
SVJC R/L 1212 F11 DC	12	12	80	16	M6	M6	1,2	VC.. 1103		01201
SVJC R/L 1616 H11 DC	16	16	100	20	G1/8"	M6	1,2	VC.. 1103		01601

Sealing plugs DC	Key D	O-Ring	Coolant nozzle DC	Coolant screw plug	Clamping screw	Grubscrew	Grubscrew
70 950 ...	80 950 ...	70 950 ...	70 950 ...	70 950 ...	70 950 ...	70 950 ...	70 950 ...

Spare parts for Article no.

70 780 01200 / 70 780 01201					039							86700
70 780 01600 / 70 780 01601		87600			039	88100	87700	294	857	857	88000	86700

MaxiLock-S – SVVC 72.5° DC – Tool holder with screw clamping

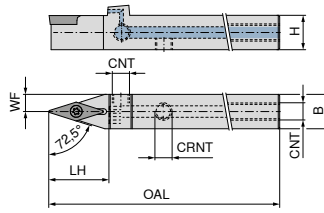
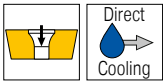

NEW
Neutral **70 781 ...**

ISO designation	H mm	B mm	OAL mm	WF mm	CNT	CRNT	torque moment Nm	Insert	
SVVC N 1212 F11 DC	12	12	80	6	M6	M6	1,2	VC.. 1103	01200
SVVC N 1616 H11 DC	16	16	100	8	G1/8"	M6	1,2	VC.. 1103	01600
SVVC N 2020 K11 DC	20	20	125	10	G1/8"	M6	1,2	VC.. 1103	02000

Sealing plugs DC	Key D	O-Ring	Coolant nozzle DC	Coolant screw plug	Clamping screw	Grubscrew	Grubscrew
70 950 ...	80 950 ...	70 950 ...	70 950 ...	70 950 ...	70 950 ...	70 950 ...	70 950 ...

Spare parts for Article no.

70 781 01200					039							86700
70 781 01600		87600			039	88100	87700	294	857	857	88000	86700
70 781 02000		87600			039	88100	87800	294	857	857	88000	86700

MaxiLock-S – SVUC 93° – Boring bar with screw clamping

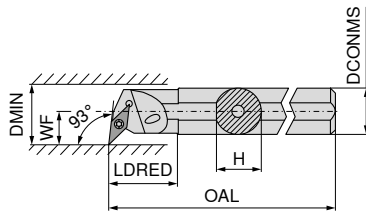

Illustrations show right-hand versions



ISO designation	DCONMS mm	H mm	OAL mm	LDRED mm	WF mm	DMIN mm	torque moment Nm	Insert
A16M SVUC R/L 11	16	15.0	150	29	11	20	1,2	VC.. 1103
A20Q SVUC R/L 11	20	18.5	180	32	13	25	1,2	VC.. 1103
A25R SVUC R/L 11	25	23.0	200	36	17	32	1,2	VC.. 1103

Left-hand	Right-hand
70 745 ...	70 744 ...
216	216
220	220
225	225

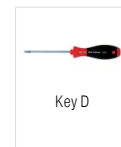

Key D

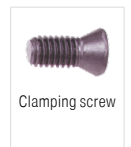

Clamping screw

Spare parts for Article no.

70 744 216 / 70 745 216
70 744 220 / 70 745 220
70 744 225 / 70 745 225

Left-hand	Right-hand
80 950 ...	70 950 ...
110	112
110	112
110	112

MaxiLock-S – SVUC 93° – Boring bar with screw clamping

▲ Type: Solid carbide

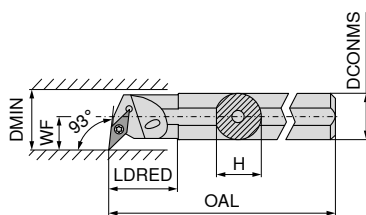

Illustrations show right-hand versions



ISO designation	DCONMS mm	H mm	OAL mm	LDRED mm	WF mm	DMIN mm	torque moment Nm	Insert
E16R SVUC R/L 11	16	15.0	200	34	11	20	1,2	VC.. 1103
E20S SVUC R/L 11	20	18.5	250	38	13	25	1,2	VC.. 1103

Left-hand	Right-hand
70 747 ...	70 746 ...
016	016
020	020

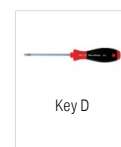

Key D

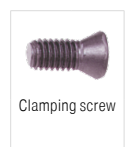

Clamping screw

Spare parts for Article no.

70 746 016 / 70 747 016
70 746 020 / 70 747 020

Left-hand	Right-hand
80 950 ...	70 950 ...
110	112
110	112
M2,5x6	M2,5x6
T08	T08

MaxiLock-S – SVJC 93° – Boring bar with screw clamping

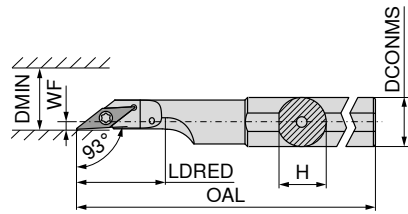

Illustrations show right-hand versions



ISO designation	DCONMS mm	H mm	OAL mm	LDRED mm	WF mm	DMIN mm	torque moment Nm	Insert
A16M SVJC R/L 11	16	15	150	30	2	22	1,2	VC.. 1103
A20M SVJC R/L 11	20	19	150	38	2	25	1,2	VC.. 1103

Left-hand 70 727 ...	Right-hand 70 726 ...
216	216
220	220

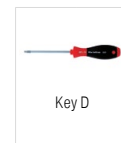

Key D

80 950 ...

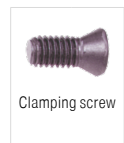

Clamping screw

70 950 ...

Spare parts

for Article no.

70 727 216 / 70 726 216	110	112
70 727 220 / 70 726 220	110	112

WCGT / WCGW

Designation	L mm	S mm	D1 mm	IC mm
WCGW 0201..	2.70	1.58	2.3	3.97
WCGT 0201..	2.71	1.59	2.1	3.97

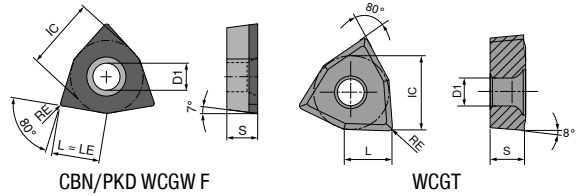

WCGT

-SF TCM10	-SF CTPP430	-SF H216T
F	F	F
CERMET WCGT	WCGT	WCGT
70 287 ...	70 287 ...	70 287 ...
900	450	600
902	452	602

ISO	RE mm			
020102EN	0.2			
020104EN	0.4			
P		●	●	
M		○	●	
K		○	○	○
N			○	●
S			○	
H				
O				○

WCGW

▲ TCE(NOI) = Design and number of equipped cutting edge corners

CTDPD20
F
DIAMOND WCGW
71 154 ...
100
102

ISO	RE mm	TCE (NOI)	LE mm	
020102FN	0.2	F	2.7	
020104FN	0.4	F	2.7	
P				
M				
K				
N				●
S				
H				
O				●

MaxiLock-S – SWUC 93° – Boring bar with screw clamping

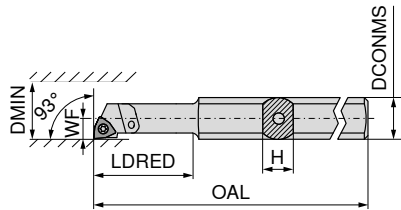

Illustrations show right-hand versions



ISO designation	H mm	OAL mm	LDRED mm	WF mm	DCONMS mm	DMIN mm	torque moment Nm	Insert	Left-hand	Right-hand
									70 731 ...	70 730 ...
A0508H SWUC R/L 02	7	100	24	2.9	8	5.8	0,4	WC.. 0201..	005	005
A0608H SWUC R/L 02	7	100	24	3.9	8	7.8	0,4	WC.. 0201..	006	006

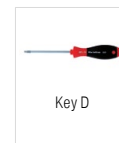

Key D

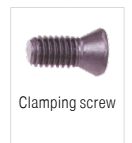

Clamping screw

Spare parts for Article no.

70 731 005 / 70 730 005	T06	108	M1,8x3,4	334
70 731 006 / 70 730 006	T06	108	M1,8x3,4	334

MaxiLock-S – SWUC 93° – Boring bar with screw clamping

▲ with carbide core

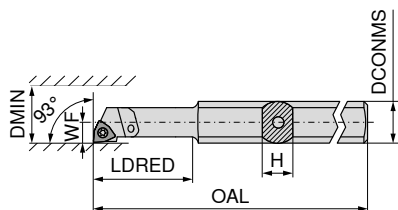

Illustrations show right-hand versions



ISO designation	H mm	OAL mm	LDRED mm	WF mm	DCONMS mm	DMIN mm	torque moment Nm	Insert	Left-hand	Right-hand
									70 743 ...	70 742 ...
E-A0508H SWUC R/L 02	7	100	24	2.9	8	5.8	0,4	WC.. 0201..	005	005
E-A0608H SWUC R/L 02	7	100	24	3.9	8	7.8	0,4	WC.. 0201..	006	006
SET							0,4	WC.. 0201..	999	999

Set includes boring bars 70 743 005 and 70 743 006 or 70 742 005 and 70 742 006

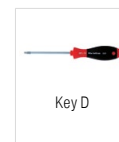

Key D



Clamping screw

Spare parts for Article no.

70 743 005 / 70 742 005	T06	108	M1,8x3,4	334
70 743 006 / 70 742 006	T06	108	M1,8x3,4	334

Toolfinder – TriClamp

- ▲ Indexable inserts with ground wiper geometry
Improves surface quality or increases feed rate
- ▲ Turning in all three contour directions
Maximum flexibility without changing the tool
- ▲ Smallest corner radii 0.0–0.2 mm
Generates sharp edges
- ▲ Perfect chip control
Reduces downtime
- ▲ High cutting depths can be achieved
Reduces the retraction distance

Application directions



TriClamp system

VPET	→ Page 51
VPGT	→ Page 51
VPXT	→ Page 51

P – 11° clearance angle

Precision ↑

E – Extremely high precision
G – High precision
X – Precision sintered

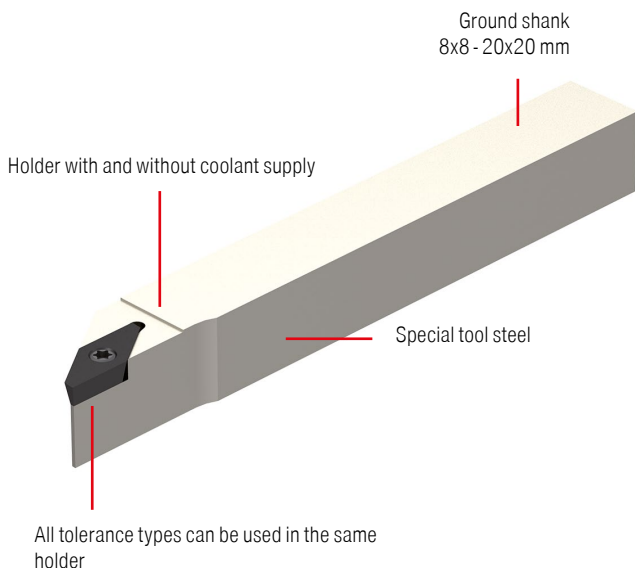
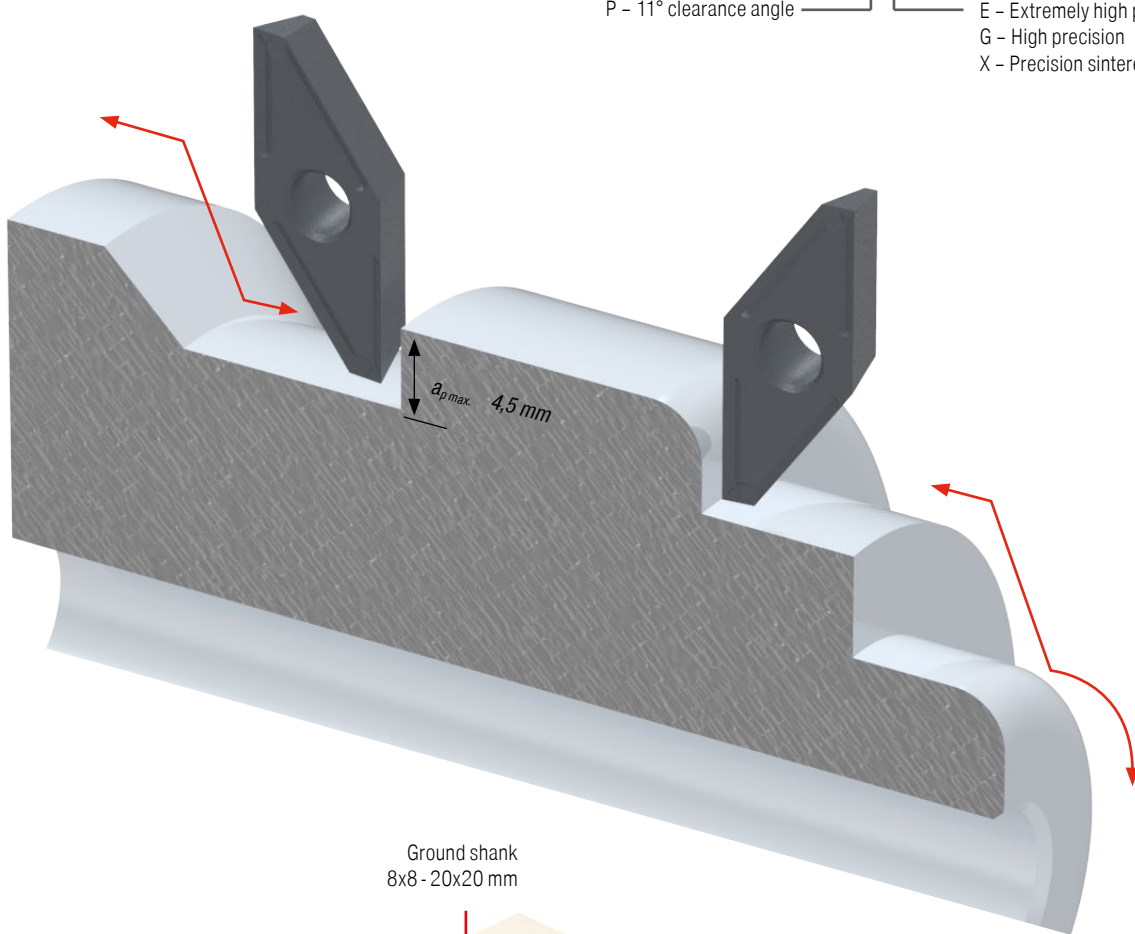

Tool holder

90°	→ Page 53
91°	→ Page 54
93°	→ Page 53–59

VPGT / VPET / VPXT

Designation	L mm	S mm	D1 mm	IC mm
VP.T 1003..	10	3.18	4.4	6.35

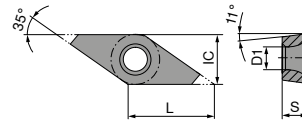

VPGT

ISO	RE mm	-FL WPU7610		-FR WPU7610		-FL TiAIN+		-FR TiAIN+		NEW -FL WUU7620		NEW -FR WUU7620	
		○	○	○	○	○	○	○	○	○	○	○	○
		F VPGT 72 405 ...		F VPGT 72 404 ...		F VPGT 72 493 ...		F VPGT 72 492 ...		F VPGT 72 493 ...		F VPGT 72 492 ...	
1003ZZ	0.00	760 ²⁾		760 ¹⁾		500 ²⁾		500 ¹⁾		70000 ²⁾		70000 ¹⁾	
1003008	0.08	728 ²⁾		728 ¹⁾		508 ²⁾		508 ¹⁾		70800 ²⁾		70800 ¹⁾	
1003015	0.15	735 ²⁾		735 ¹⁾		515 ²⁾		515 ¹⁾		71500 ²⁾		71500 ¹⁾	
P		●		●		●		●		●		●	
M		○		○		○		○		○		○	
K		●		●		●		●		●		●	
N		○		○		○		○		○		○	
S		○		○		○		○		○		○	
H													
O		○		○		○		○		○		○	

1) Note ! Right hand insert for right hand holder

2) Note ! Left hand insert for left hand holder

VPET

ISO	RE mm	-FL WUU7610		-FR WUU7610		-FL WPU7610		-FR WPU7610		-FL WPU7620		-FR WPU7620	
		○	○	○	○	○	○	○	○	○	○	○	○
		F VPET 72 403 ...		F VPET 72 402 ...		F VPET 72 403 ...		F VPET 72 402 ...		F VPET 72 403 ...		F VPET 72 402 ...	
1003ZZ	0.00	060 ²⁾		060 ¹⁾		760 ²⁾		760 ¹⁾		560 ²⁾		560 ¹⁾	
1003008	0.08	028 ²⁾		028 ¹⁾		728 ²⁾		728 ¹⁾		528 ²⁾		528 ¹⁾	
1003015	0.15	035 ²⁾		035 ¹⁾		735 ²⁾		735 ¹⁾		535 ²⁾		535 ¹⁾	
P		●		●		●		●		●		●	
M		○		○		○		○		○		○	
K		●		●		●		●		●		●	
N		○		○		○		○		○		○	
S		○		○		○		○		○		○	
H													
O		○		○		○		○		○		○	

1) Note ! Right hand insert for right hand holder

2) Note ! Left hand insert for left hand holder

VPXT

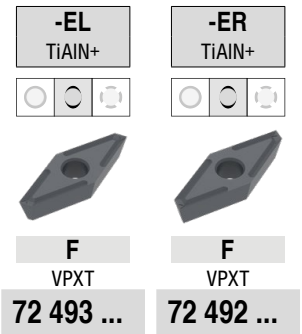

ISO	RE mm	72 493 ...	72 492 ...
1003015	0.15	615 ²⁾	615 ¹⁾
1003035	0.35	635 ²⁾	635 ¹⁾
P		●	●
M		○	○
K		●	●
N		○	○
S		○	○
H			
O		○	○

- 1) Note ! Right hand insert for right hand holder
- 2) Note ! Left hand insert for left hand holder

TriClamp – SVAP 90° – Toolholder with screw clamping

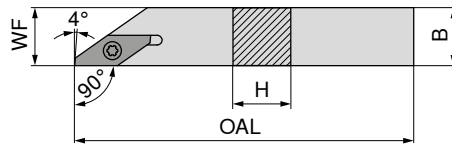

Illustrations show right-hand versions

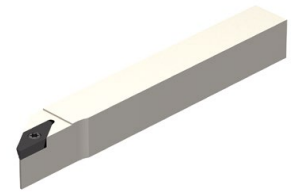

ISO designation	H mm	B mm	OAL mm	WF mm	Insert
SVAP R/L 0808 H10	8	8	100	8	VP.. 1003
SVAP R/L 1010 H10	10	10	100	10	VP.. 1003
SVAP R/L 1212 H10	12	12	100	12	VP.. 1003

Left-hand	Right-hand
72 382 ...	72 380 ...
008	008
010	010
012	012

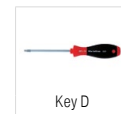

Key D

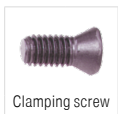

Clamping screw

Spare parts
Insert

VP.. 1003

T08

80 950 ...	72 950 ...
110	002

TriClamp – SVJP 93° – Toolholder with screw clamping

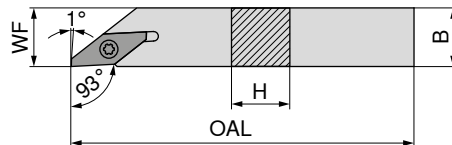

Illustrations show right-hand versions

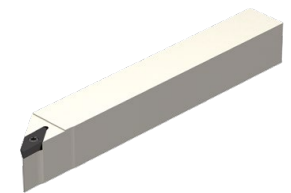

ISO designation	H mm	B mm	OAL mm	WF mm	Insert
SVJP R/L 0808 H10	8	8	100	8	VP.. 1003
SVJP R/L 1010 H10	10	10	100	10	VP.. 1003
SVJP R/L 1212 H10	12	12	100	12	VP.. 1003
SVJP R/L 1616 K10	16	16	125	16	VP.. 1003

Left-hand	Right-hand
72 386 ...	72 384 ...
008	008
010	010
012	012
016	016

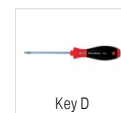

Key D

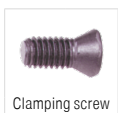

Clamping screw

Spare parts
Insert

VP.. 1003

T08

80 950 ...	72 950 ...
110	002

TriClamp – SVXP 91° – Toolholder with screw clamping

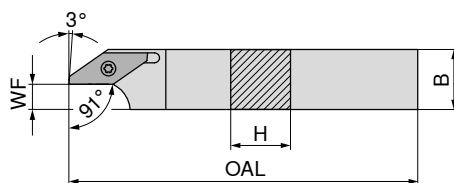

Illustrations show right-hand versions

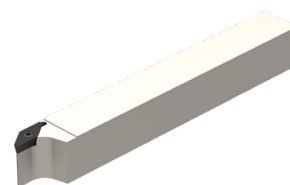

ISO designation	B mm	H mm	OAL mm	WF mm	Insert	Left-hand 72 390 ...	Right-hand 72 388 ...
SVXP R/L 0808 H10	8	8	100	1	VP.. 1003	008	008
SVXP R/L 1010 H10	10	10	100	3	VP.. 1003	010	010
SVXP R/L 1212 H10	12	12	100	5	VP.. 1003	012	012
SVXP R/L 1616 K10	16	16	125	9	VP.. 1003	016	016

Spare parts

Insert

VP.. 1003

Part	Left-hand	Right-hand
Key D	80 950 ...	72 950 ...
Clamping screw		
Part	T08	110
Part		002

TriClamp – SVJP 93°-IC – Tool holder with screw clamping and thro' coolant

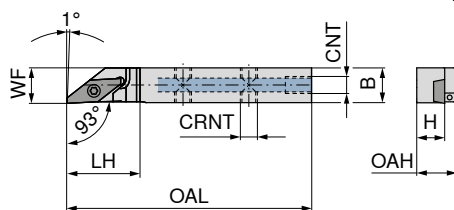

Illustrations show right-hand versions



ISO designation	H mm	B mm	LH mm	WF mm	OAL mm	OAH mm	CRNT	GNT	Insert	Left-hand 72 361 ...	Right-hand 72 360 ...
SVJP R/L 0810 H10 IC	8	10	21	10	100	11.5	M5	M5	VP.. 1003	008	008
SVJP R/L 1010 H10 IC	10	10	21	10	100	13.5	M5	M5	VP.. 1003	010	010
SVJP R/L 1212 H10 IC	12	12	21	12	100	15.5	M5	M5	VP.. 1003	012	012
SVJP R/L 1616 K10 IC	16	16	21	16	125	19.5	M5	G1/8"	VP.. 1003	016	016
SVJP R/L 2020 K10 IC	20	20	21	20	125	23.5	M5	G1/8"	VP.. 1003	020	020

Spare parts for Article no.

72 360 008 / 72 361 008							M5x4	011	T08	110	002
72 360 010 / 72 361 010							M5x4	011	T08	110	002
72 360 012 / 72 361 012							M5x4	011	T08	110	002
72 360 016 / 72 361 016				G1/8"			M5x4	010	T08	110	002
72 360 020 / 72 361 020				G1/8"			M5x4	010	T08	110	002

Suitable accessories can be found on → Page 131+132

TriClamp – SVJP 93°-VIC – Reinforced tool holder with screw clamping and thro' coolant

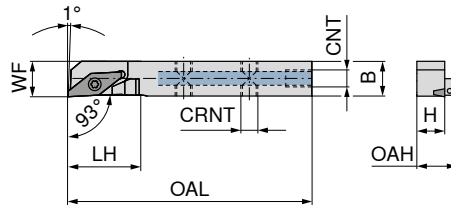

Illustrations show right-hand versions



ISO designation	H mm	B mm	LH mm	WF mm	OAL mm	OAH mm	CRNT	CNT	Insert
SVJP R/L 0810 H10 VIC	8	10	21	10	100	11.5	M5	M5	VP.. 1003
SVJP R/L 1010 H10 VIC	10	10	21	10	100	13.5	M5	M5	VP.. 1003
SVJP R/L 1212 H10 VIC	12	12	21	12	100	15.5	M5	M5	VP.. 1003

Left-hand	Right-hand
72 363 ...	72 362 ...
008	008
010	010
012	012

Spare parts

Insert

VP.. 1003



Cylindrical screw

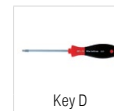

Key D



Clamping screw

72 950 ...

80 950 ...

72 950 ...

M5x4

011

T08

110

002

TriClamp – SVJP 93°-VIC – Reinforced tool holder with screw clamping and thro' coolant

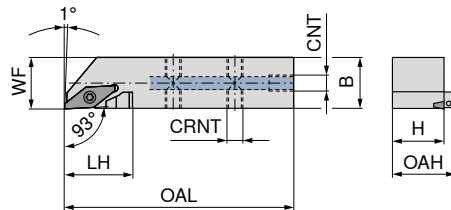

Illustrations show right-hand versions



ISO designation	H mm	B mm	LH mm	WF mm	OAL mm	OAH mm	CRNT	CNT	Insert
SVJP R/L 1616 K10 VIC	16	16	21	16	125	19.5	M5	G1/8"	VP.. 1003
SVJP R/L 2020 K10 VIC	20	20	21	20	125	23.5	M5	G1/8"	VP.. 1003

Left-hand	Right-hand
72 365 ...	72 364 ...
016	016
020	020

Spare parts

Insert

VP.. 1003



Cylindrical screw



Cylindrical screw

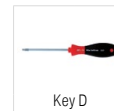

Key D

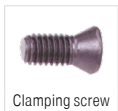

Clamping screw

72 950 ...

72 950 ...

80 950 ...

72 950 ...

G1/8"

010

M5x4

011

T08

110

002



Suitable accessories can be found on → **Page 131+132**

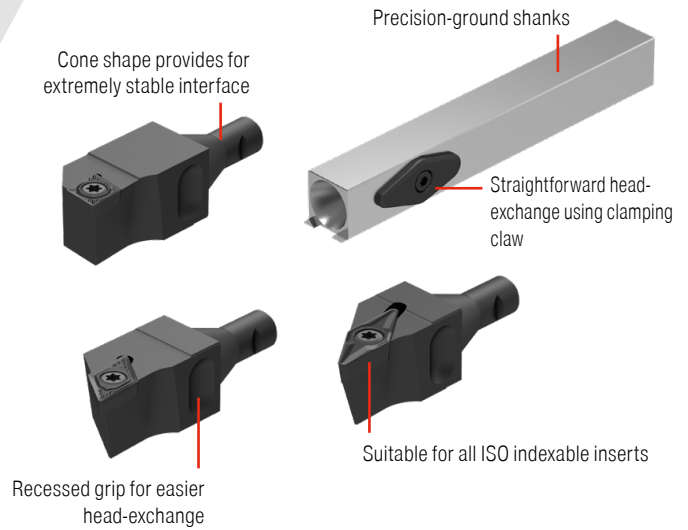

Highlights

- ▲ Quick and easy head-exchange
Reduced downtime
- ▲ Uniform height and lengths
No setup time required
- ▲ High repeatability of $\pm 7.5 \mu\text{m}$
Low reject rate
- ▲ Ground base holder
Maximum precision
- ▲ Secure positioning of heads
Repeat inspections not required

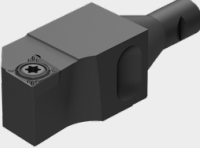

Overview

Exchangeable heads

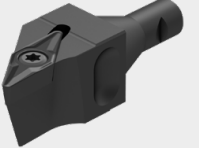
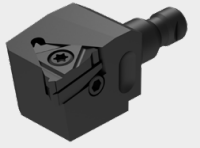
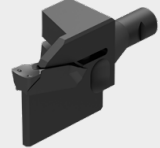
CC.T	DC.T	VC.T	External thread	GX grooving	
					
SCLC 95°	SDJC 93° / SDAC 90° / SDNC 62,5°	SVJC 93°	11.. / 16..	GX09	GX16
→ 57	→ 57+58	→ 59	→ 59+60	→ 60	

Basic holder

SZID 12: OAL = 63 mm	SZID 12: OAL = 93 mm
SZID 16: OAL = 63 mm	SZID 16: OAL = 89 mm

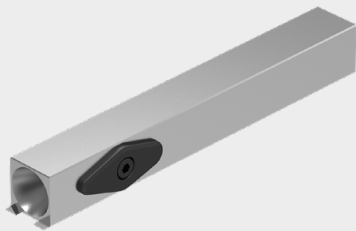

→ 61

XheadClamp – SCLC 95° exchangeable head turning tool

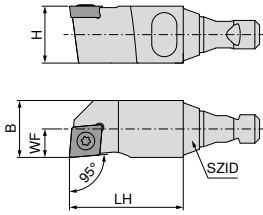

Illustrations show right-hand versions



ISO designation	SZID	H mm	B mm	LH mm	WF mm	Insert	Left-hand	Right-hand
							72 809 ...	72 808 ...
SCLC R/L 06 BH12	12	12	12	24	6	CC.. 0602	221	221
SCLC R/L 06 BH16	16	16	16	28	8	CC.. 0602	621	621
SCLC R/L 09 BH12	12	12	12	24	6	CC.. 09T3	222	222
SCLC R/L 09 BH16	16	16	16	28	8	CC.. 09T3	622	622

Spare parts	Insert	Key D	Combination Key	Clamping screw
CC.. 0602	T08	110	M2,5x6	112
CC.. 09T3	T15/SW	398	M3,5x11	113

Suitable indexable inserts can be found in the ISO turning section on → Page 13–16.

XheadClamp – SDJC 93° exchangeable head turning tool

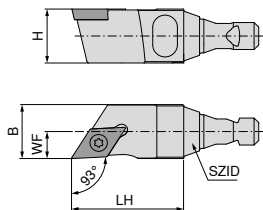

Illustrations show right-hand versions



ISO designation	SZID	H mm	B mm	LH mm	WF mm	Insert	Left-hand	Right-hand
							72 811 ...	72 810 ...
SDJC R/L 07-BH12	12	12	12	24	6	DC.. 0702	230	230
SDJC R/L 07-BH16	16	16	16	28	8	DC.. 0702	630	630
SDJC R/L 11-BH12	12	12	12	24	6	DC.. 11T3	231	231
SDJC R/L 11-BH16	16	16	16	28	8	DC.. 11T3	631	631

Spare parts	Insert	Key D	Combination Key	Clamping screw
DC.. 0702	T08	110	M2,5x6	112
DC.. 11T3	T15	113	M4x11	174

Suitable indexable inserts can be found in the ISO turning section on → Page 23–27.

XheadClamp – SDAC 90° exchangeable head turning tool

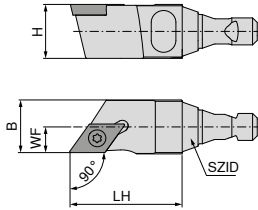



Illustrations show right-hand versions



ISO designation	SZID	B mm	H mm	WF mm	LH mm	Insert	NEW Left-hand 72 811 ...	NEW Right-hand 72 810 ...
SDACR 07-BH12	12	12	12	6	24	DC.. 0702	228	228
SDACR 07-BH16	16	16	16	8	28	DC.. 0702	628	628
SDACR 11-BH12	12	12	12	6	24	DC.. 11T3	229	229
SDACR 11-BH16	16	16	16	8	28	DC.. 11T3	629	629

Spare parts for Article no.

72 810 229 / 72 811 229								
72 810 228 / 72 811 228							110	113
72 810 628 / 72 811 628							110	112
72 810 629 / 72 811 629							398	113

		
Key D	Combination Key	Clamping screw
80 950 ...	70 950 ...	70 950 ...

 Suitable indexable inserts can be found in the ISO turning section on → **Page 23–27.**

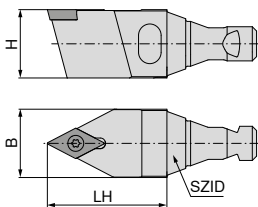

XheadClamp – SDNC 62.5° exchangeable head turning tool



ISO designation	SZID	H mm	B mm	LH mm	Insert	NEW Neutral 72 814 ...
SDNC N 07-BH12	12	12	12	28	DC.. 0702	232
SDNC N 07-BH16	16	16	16	28	DC.. 0702	632
SDNC N 11-BH12	12	12	12	24	DC.. 11T3	233
SDNC N 11-BH16	16	16	16	28	DC.. 11T3	633

Spare parts for Article no.

72 814 232								
72 814 632							110	112
72 814 233							110	112
72 814 633							398	113

		
Key D	Combination Key	Clamping screw
80 950 ...	70 950 ...	70 950 ...

 Suitable indexable inserts can be found in the ISO turning section on → **Page 23–27.**

XheadClamp – SVJC 93° exchangeable head turning tool

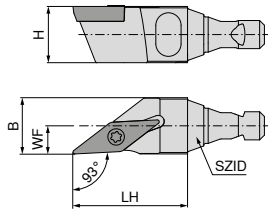

Illustrations show right-hand versions



ISO designation	SZID	H mm	B mm	LH mm	WF mm	Insert	Left-hand 72 813 ...	Right-hand 72 812 ...
SVJC R/L 11-BH12	12	12	12	24	6	VC.. 1103	234	234
SVJC R/L 11-BH16	16	16	16	28	8	VC.. 1103	634	634

Spare parts

Insert	T08	80 950 ...	M2,5x6	70 950 ...
VC.. 1103		110		112

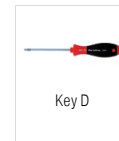

Key D

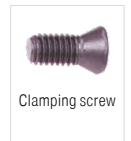

Clamping screw

Suitable indexable inserts can be found in the ISO turning section on → **Page 40–42.**

XheadClamp – Exchangeable head standard external threading tool

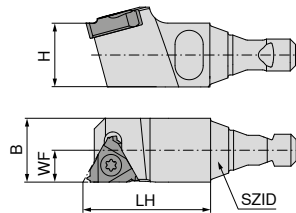

Illustrations show right-hand versions



Designation	SZID	H mm	LH mm	WF mm	Insert	NEW Left-hand 72 803 ...	NEW Right-hand 72 802 ...
SE R/L 11-BH12	12	12	24	6	11 ..	241	241
SE R/L 11-BH16	16	16	28	8	11 ..	641	641

for Article no.

72 802 241 / 72 803 241	110	230
72 802 641 / 72 803 641	110	230

Suitable indexable inserts can be found in **Chapter 2, Thread turning.**

XheadClamp – Exchangeable head standard external threading tool

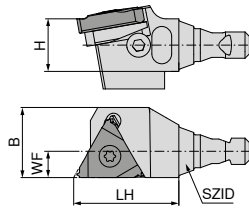

Illustrations show right-hand versions

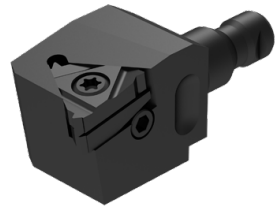

	NEW Left-hand 72 805 ...	NEW Right-hand 72 804 ...
	242	242
	642	642

Designation	SZID	H mm	LH mm	WF mm	Insert
SE R/L 16-BH12	12	12	24	16	16 ..
SE R/L 16-BH16	16	16	28	18	16 ..

Shim	Screw-U	Key D	Clamping screw	
71 950 ...	71 950 ...	80 950 ...	71 950 ...	
72 805 242	129	234	110	231
72 805 642	129	234	110	231
72 804 242	121	234	110	231
72 804 642	121	234	110	231

Spare parts for Article no.

72 805 242	129	234	110	231
72 805 642	129	234	110	231
72 804 242	121	234	110	231
72 804 642	121	234	110	231

Suitable indexable inserts can be found in **Chapter 2, Thread turning**.

XheadClamp – GX 09/16 exchangeable head grooving tool holder

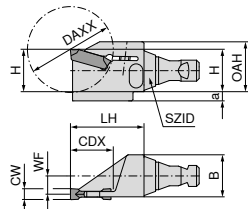

Illustrations show right-hand versions

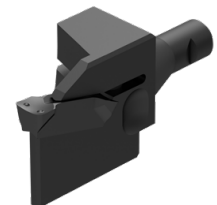

Designation	SZID	B mm	H mm	OAH mm	LH mm	CDX mm	DAXX mm	WF mm	CW mm	a mm	for grooving inserts	Left-hand 72 801 ...	Right-hand 72 800 ...
												GX09-1 R/L -BH12	12
GX09-1 R/L -BH16	16	16	16	19	28	16.0	32	7.5	0,60-2,50	3.5	GX 09-1	116	116
GX09-2 R/L -BH12	12	12	12	15	24	12.5	25	5.0	0,60-3,00	4.0	GX 09-2	212	212
GX09-2 R/L -BH16	16	16	16	19	28	16.0	32	7.0	0,60-3,00	3.5	GX 09-2	216	216
GX16-1 R/L -BH12	12	12	12	15	24	12.5	25	5.5	0,60-2,50	4.0	GX 16-1	612	612
GX16-1 R/L -BH16	16	16	16	19	28	16.0	32	7.5	0,60-2,50	3.5	GX 16-1	616	616
GX16-2 R/L -BH12	12	12	12	15	24	12.5	25	5.0	0,60-3,50	4.0	GX 16-2	712	712
GX16-2 R/L -BH16	16	16	16	19	28	16.0	32	7.0	0,60-3,50	3.5	GX 16-2	716	716

Key D	Clamping screw			
80 950 ...	70 950 ...			
GX 09-1	T15	113	M4x11	174
GX 09-2	T15	113	M4x11	174
GX 16-1	T15	113	M4x11	174
GX 16-2	T15	113	M4x11	174

Spare parts for grooving inserts

GX 09-1	T15	113	M4x11	174
GX 09-2	T15	113	M4x11	174
GX 16-1	T15	113	M4x11	174
GX 16-2	T15	113	M4x11	174

Suitable indexable inserts can be found in the grooving tools section on → **Page 229**

XheadClamp - Base holder

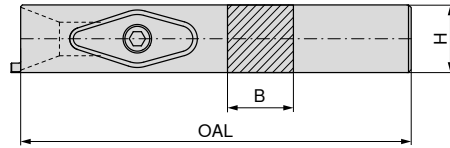

Illustrations show right-hand versions

ISO designation	H mm	B mm	OAL mm	For exchange- able heads	Left-hand	Right-hand
					72 841 ...	72 840 ...
BHSH.12X63 R/L	12	12	63	BH12	263	263
BHSH.12X93 R/L	12	12	93	BH12	293	293
BHSH.16X63 R/L	16	16	63	BH16	663	663
BHSH.16X89 R/L	16	16	89	BH16	693	693

Spare parts For exchangeable heads					Clamping screw	Clamp	Key I
					72 950 ...	72 950 ...	70 950 ...
BH12	SR.BHSH.12	801	PR.BHSH.12	800	SW2,5	175	
BH16	SR.BHSH.16	803	PR.BHSH.16	802	SW3	176	



Reverse-side machining – highlights

▲ **Speed**

Ultra-fast tool change by tightening / loosening just one bolt

▲ **Flexibility**

Flexible on all machines

Base holders are installed in the same way on all machines and remain in the machines

▲ **Precision**

Most accurate height adjustment possible

▲ **Set-up time optimisation**

Presetting via an adjustment screw directly in the machine or externally in the presetting device

▲ **Cooling**

Optional coolant overpressure by attaching a coolant attachment

Reverse-side machining – Toolfinder

Modular tools



Distance plates

→ Page 68

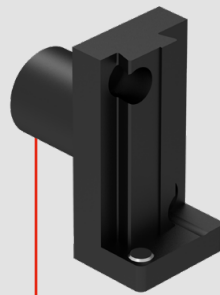

CITIZIEN

→ Page 64

DOOSAN

→ Page 64

HANHWA

→ Page 65

MAIER

→ Page 65

STAR

→ Page 66

TORNOS

→ Page 66

CITIZEN / GILDEMEISTER / HANHWA / TORNOS / TSUGAMI

→ Page 67

TORNOS / TSUGAMI

→ Page 67

Accessories

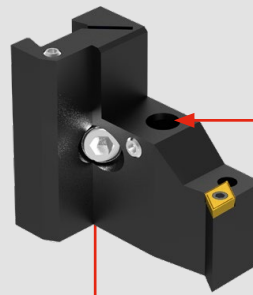

Turning Holder

CC / DC / VC → Page 69-71

Thread turning holder

→ Page 72

Grooving tool holder

TX → Page 73

Drills and boring bars

→ Page 74

Cutting inserts

→ Page 75+76

Collet Chuck

→ Page 77

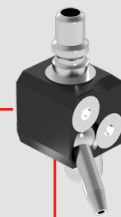

Coolant insert

→ Page 100

Setting Device

Using the adjustment device, you can set our modular holder to the right height outside the machine, which is a plus in terms of flexibility and time.

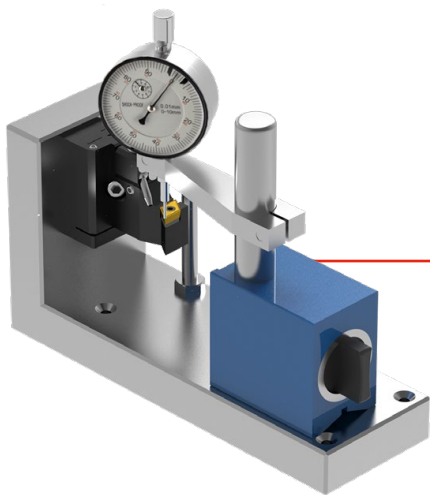

Setting Device

→ Page 103

Detailed information on using the adjustment device

→ Page 155+156

Monoblock tools

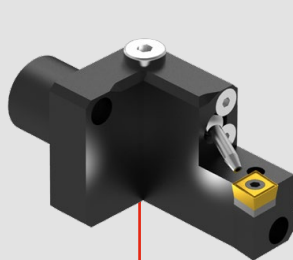

STAR

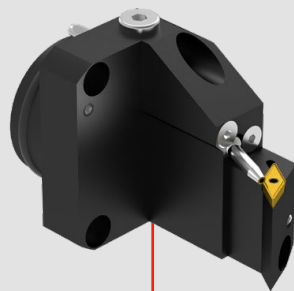

TSUGAMI

- Turning Holder CC / DC / VC → Page 78-82
- Thread turning holder → Page 83
- Grooving tool holder TX → Page 84
- Drills and boring bars → Page 96
- Cutting inserts → Page 98

- Turning Holder CC / DC / VC → Page 85-93
- Thread turning holder → Page 94
- Grooving tool holder TX → Page 95
- Drills and boring bars → Page 97
- Cutting inserts → Page 99

Accessories

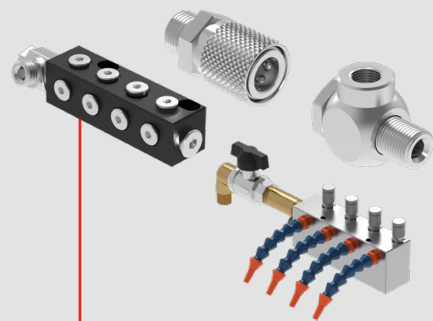

- Coolant manifold → Page 100+101
- Coolant nozzles → Page 101
- Screw plug → Page 101
- Coolant connection → Page 101+102
- Threaded adapter → Page 102
- Coolant hoses → Page 102
- Coupler connector → Page 102
- Quick-coupler → Page 102
- Protection plug → Page 102

Machine base holder for CITIZEN

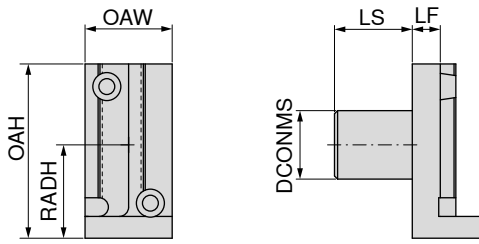

NEW

72 951 ...

Designation	DCONMS mm	OAW mm	OAH mm	LF mm	LS mm	RADH mm	
CI.GH 3/4"-40	19.05	28	56	9	40	30	07004
CI.GH 25-30	25.00	28	56	9	30	30	07002
CI.GH 1"-60	25.40	28	56	9	60	30	07003
CI.GH 31-15	31.00	34	58	9	15	32	07001

suitable for the following machines:

Article no.	Machine manufacturer	Machine type
72 951 07001	Citizen	A32-VII with drive
72 951 07002	Citizen	L12 / A20 / CL20 with drive
72 951 07003	Citizen	A20 / A32 / C32 / L32 / M32 without drive
72 951 07004	Citizen	C16 / L12 / L20 / M16

Machine base holder for DOOSAN

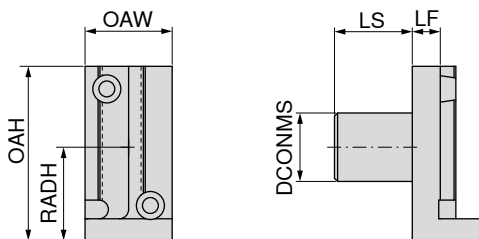

NEW

72 952 ...

Designation	DCONMS mm	OAW mm	OAH mm	LF mm	LS mm	RADH mm	
DO.GH 32-25	32	34	56	9	25	30	07001

suitable for the following machines:

Article no.	Machine manufacturer	Machine type
72 952 07001	Doosan	Puma ST20G

Machine base holder for HANWHA

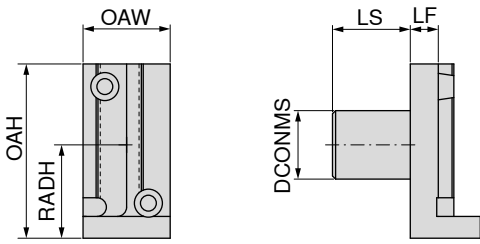

NEW

72 953 ...

Designation	DCONMS mm	OAW mm	OAH mm	LF mm	LS mm	RADH mm
HA.GH 25-40	25	28	56	9	40	30
HA.GH 32-27	32	38	56	34	27	30
HA.GH 33-40	33	28	56	9	40	30

07003

07002

07001

suitable for the following machines:

Article no.	Machine manufacturer	Machine type
72 953 07001	Hanwha	XD20 / 26 / 32 / 38
72 953 07002	Hanwha	XD38H
72 953 07003	Hanwha	XE26

Machine base holder for MAIER

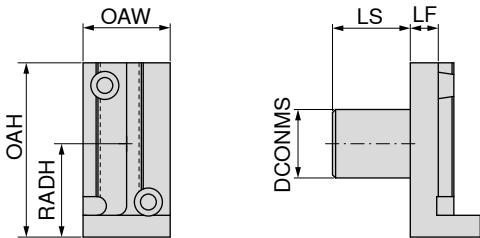

NEW

72 954 ...

Designation	DCONMS mm	OAW mm	OAH mm	LF mm	LS mm	RADH mm
MA.GH 34-20	34	38	56	9	20	30

07001

suitable for the following machines:

Article no.	Machine manufacturer	Machine type
72 954 07001	Maier	ML26 / ML32 / ML12C / ML16C / ML16D / ML20

Machine base holder for STAR

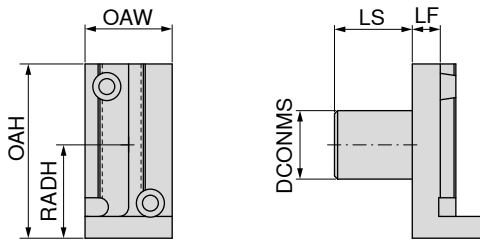

NEW

72 955 ...

Designation	DCONMS mm	OAW mm	OAH mm	LF mm	LS mm	RADH mm	
ST.GH 22-20	22	38	56	9	20	30	07001
ST.GH 22-25	22	28	56	9	25	30	07002

suitable for the following machines:

Article no.	Machine manufacturer	Machine type
72 955 07001	Star	SR32 / SR32J / SR32JN (from mach. no 161)
72 955 07002	Star	ECAS12 / ECAS20 / SR20RIII / SR20N / SR20JN / SR32J / SR10J / SR16R / SR20R / SR20RII

Machine base holder for TORNOS

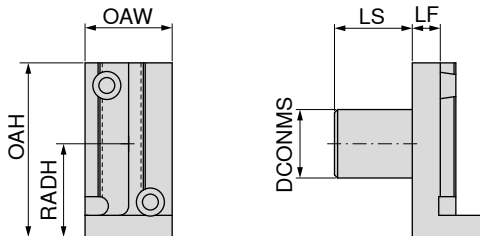

NEW

72 956 ...

Designation	DCONMS mm	OAW mm	OAH mm	LF mm	LS mm	RADH mm	
TO.GH 20-100	20	28	56	9	100	30	07002
TO.GH 25-100	25	28	56	9	100	30	07001

suitable for the following machines:

Article no.	Machine manufacturer	Machine type
72 956 07001	Tornos	Deco 7 / 10 / 13 / 20 (Ø25)
72 956 07002	Tornos	Deco 7 / 10 / 13 / 20 (Ø20)

Machine base holder for CITIZEN / GILDEMEISTER / HANWHA / TORNOS / TSUGAMI

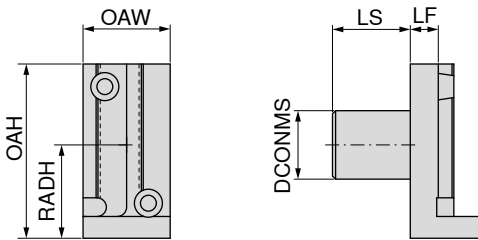

NEW

72 958 ...

Designation	DCONMS mm	OAW mm	OAH mm	LF mm	LS mm	RADH mm
C/CI/GI/HA/TO/TS.GH 20-40	20	28	56	9	40	30

07001

suitable for the following machines:

Article no.	Machine manufacturer	Machine type
72 958 07001	Citizen	K16
	Gildemeister	Sprint 20
	Hanwha	SL 12H
	Tornos	Delta 20 / Gamma 20
	Tsugami	BO 125 / 205

Machine base holder for TORNOS / TSUGAMI

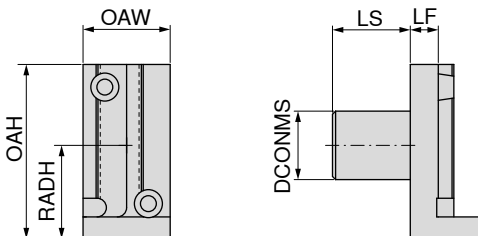

NEW

72 958 ...

Designation	DCONMS mm	OAW mm	OAH mm	LF mm	LS mm	RADH mm
TO/TS.GH 32-50	32	28	56	9	50	30

07002

suitable for the following machines:

Article no.	Machine manufacturer	Machine type
72 958 07001	Tornos	Delta 385 without drive
	Tsugami	BO 385 / BH 38

Distance plate

▲ flexible adjustment of the projection length

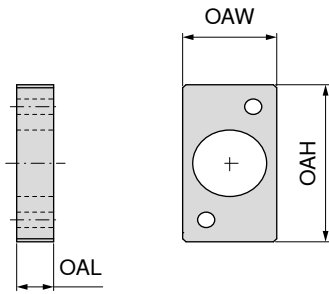

NEW

72 951 ...

Designation	OAW mm	OAH mm	OAL mm	Base holder
CI.DP-GH1"-60-11	28	52	11	CI.GH1"-60
CI.DP-GH25-30-11	28	52	11	CI.GH25-30
CI.DP-GH3/4"-40-11	28	52	11	CI.GH3/4"-40

04006
04005
04007

Distance plate

▲ flexible adjustment of the projection length

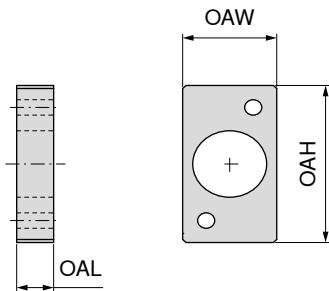

NEW

72 953 ...

Designation	OAW mm	OAH mm	OAL mm	Base holder
HA.DP-GH33-40-11	35	52	11	HA.GH33-40

04004

Distance plate

▲ flexible adjustment of the projection length

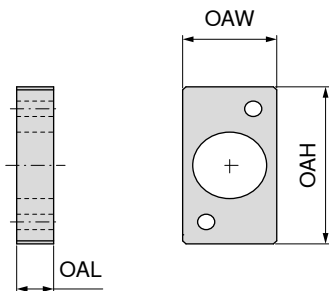

NEW

72 955 ...

Designation	OAW mm	OAH mm	OAL mm	Base holder
ST.DP-GH22-25-11	28	52	11	ST.GH22-25

04003

Tool holder block with screw clamping for CC.. Indexable inserts

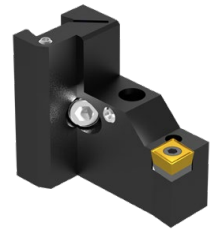
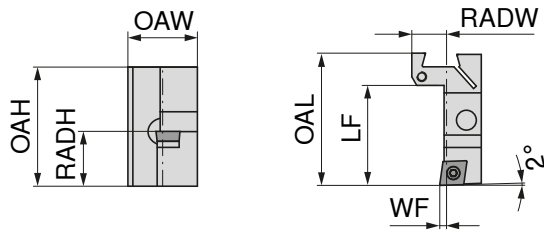



NEW

72 981 ...

Designation	OAW mm	OAH mm	LF mm	RADW mm	RADH mm	WF mm	OAL mm	Insert
MU.AH-CC09-R	28	48	41	14	22	2.5	54	CC.. 09T3

08001

			
Key D	Clamping screw	Carbide type C	Threaded sleeve
80 950 ...	70 950 ...	70 950 ...	70 950 ...
113	113	165	171

Spare parts
for Article no.
72 981 08001

 Suitable indexable inserts can be found in the ISO turning section on → **Page 13–16.**

3

Tool holder block (double) with screw clamping for CC.. / DC.. Indexable inserts

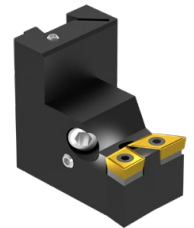
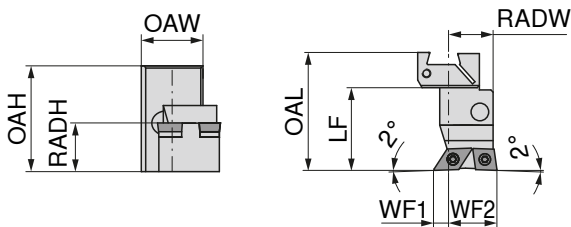







NEW

double

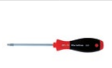
72 981 ...

Designation	OAH mm	LF mm	RADW mm	RADH mm	OAL mm	WF1 mm	WF2 mm	Insert
MU.AH-CC09-L-DC11-R	48	38	20	22	54	22	7	CC.. 09T3 / DC.. 11T3

08011

					
Key D	Combination Key	Clamping screw	Solid Carbide Seat D	Carbide type C	Threaded sleeve
80 950 ...	70 950 ...	70 950 ...	70 950 ...	70 950 ...	70 950 ...
113	398	113	106	165	171

Spare parts
for Article no.
72 981 08011

 Suitable CC.. Indexable inserts can be found in the ISO turning section on → **Page 13–16.**
Suitable DC.. Indexable inserts can be found in the ISO turning section on → **Page 23–27.**

Tool holder block (double) with screw clamping for CC.. / DC.. Indexable inserts

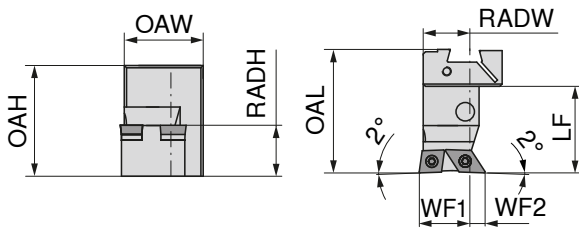







NEW

double

72 981 ...

Designation	OAH mm	LF mm	RADW mm	RADH mm	OAL mm	WF1 mm	WF2 mm	Insert	
MU.AH-CC09-R-DC11-L	48	38	20	22	54	22	7	CC.. 09T3 / DC.. 11T3	08010

Spare parts
for Article no.
72 981 08010

					
Key D	Combination Key	Clamping screw	Solid Carbide Seat D	Carbide type C	Threaded sleeve
80 950 ...	70 950 ...	70 950 ...	70 950 ...	70 950 ...	70 950 ...
113	398	113	106	165	171

i Suitable CC.. Indexable inserts can be found in the ISO turning section on → **Page 13–16.**
 Suitable DC.. Indexable inserts can be found in the ISO turning section on → **Page 23–27.**

Tool holder block with screw clamping for DC.. Indexable inserts

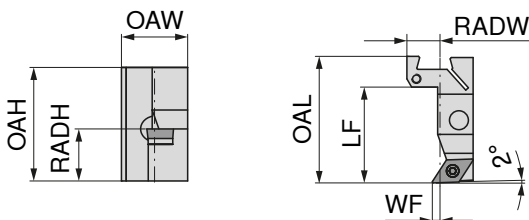





NEW

72 981 ...

Designation	OAW mm	OAH mm	LF mm	RADW mm	RADH mm	WF mm	OAL mm	Insert	
MU.AH-DC07-R	28	48	41	14	22	3.0	54	DC.. 0702	08002
MU.AH-DC11-R	28	48	41	14	22	3.5	54	DC.. 11T3	08003

Spare parts
for Article no.
72 981 08002
72 981 08003

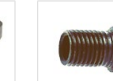
				
Key D	Combination Key	Clamping screw	Solid Carbide Seat D	Threaded sleeve
80 950 ...	70 950 ...	70 950 ...	70 950 ...	70 950 ...
110	398	112 113	106	171

i Suitable indexable inserts can be found in the ISO turning section on → **Page 23–27.**

Tool holder block with screw clamping for VC.. Indexable inserts

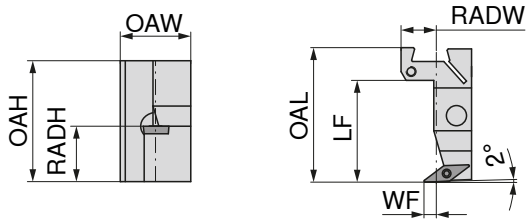



NEW

72 981 ...

Designation	OAW mm	OAH mm	LF mm	RADW mm	RADH mm	WF mm	OAL mm	Insert	
MU.AH-VC11-R	28	48	41	14	22	5.0	54	VC.. 1103	08004
MU.AH-VC16-R	28	48	41	14	22	14.5	54	VC.. 1604	08005

Spare parts
for Article no.
72 981 08004
72 981 08005

 Key D	 Combination Key	 Clamping screw	 Solid Carbide Seat V	 Threaded sleeve
80 950 ...	70 950 ...	70 950 ...	70 950 ...	70 950 ...
110	398	112 113	107	171

 (VC.. 1103) Suitable indexable inserts can be found in the ISO turning section on → Page 40–42.
(VC.. 1604) Suitable indexable inserts can be found in our OnlineShop.

3

Tool holder block with screw clamping for VC.. Indexable inserts

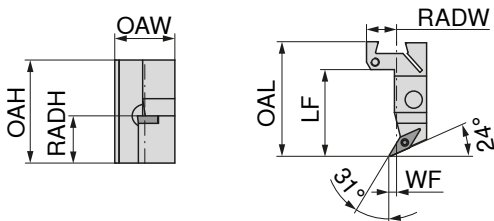



NEW

72 981 ...

Designation	OAW mm	OAH mm	LF mm	RADW mm	RADH mm	WF mm	OAL mm	Insert	
MU.AH-VC11-24-R	28	48	41	14	22	3	54	VC.. 1103	08006

Spare parts
for Article no.
72 981 08006

 Key D	 Clamping screw
80 950 ...	70 950 ...
110	112

 Suitable indexable inserts can be found in the ISO turning section on → Page 40–42.

Tool holders for right external thread-turning inserts

- ▲ Tool holder with approach angle 1.5°
- ▲ Thread-turning inserts with pitch max. 1.5 mm

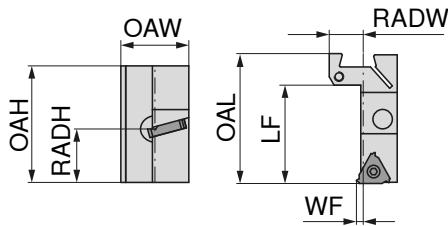

NEW

Right-hand

72 981 ...

Designation	OAW mm	OAH mm	LF mm	RADW mm	RADH mm	WF mm	OAL mm	Insert
MU.AH-ER16-R	28	48	41	14	22	3	54	16 ER..

08007

Tool holders for left external thread-turning inserts

- ▲ Tool holder with approach angle 1.5°
- ▲ Thread-turning inserts with pitch max. 1.5 mm

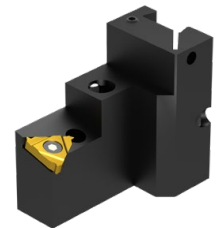
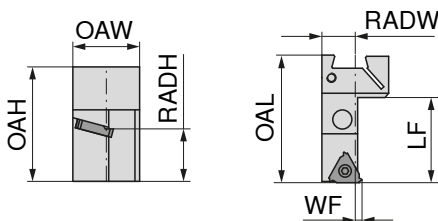

NEW

Left-hand

72 981 ...

Designation	OAW mm	OAH mm	LF mm	RADW mm	RADH mm	WF mm	OAL mm	Insert
MU.AH-ER16-L	28	48	34	14	22	3	54	16 EL..

08008

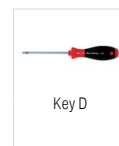

80 950 ...

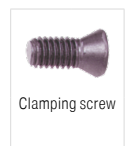

71 950 ...

Spare parts for Article no.

72 981 08008
72 981 08007

112
112

231
231

Suitable indexable inserts can be found in **Chapter 2, Thread turning.**

Tool holder block for TX grooving inserts

▲ Insert width 0.5-4.0 mm

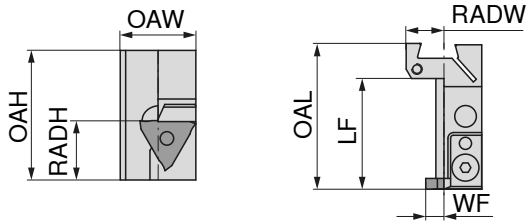

NEW

Right-hand

72 986 ...

Designation	OAW mm	OAH mm	LF mm	RADW mm	RADH mm	WF mm	OAL mm	Insert	
MU.AH-TX-R	28	48	41	14	22	7	54	TX R/N/L...2/3/4	16001

Spare parts
for Article no.
72 986 16001

			
Clamp	Lock washer	Countersunk screw	Guide pin with flange
72 950 ...	72 950 ...	72 950 ...	72 950 ...
19001	19002	19003	19004

 Suitable indexable inserts can be found in the main catalogue, **Chapter 11 Grooving tools.**

Tool holder blocks for drills and boring bars

▲ with inner high-pressure coolant supply through the tool

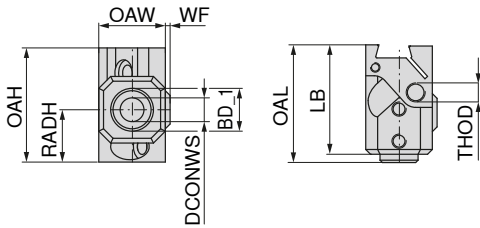

NEW



72 982 ...

Designation	DCONWS mm	BD_1 mm	OAW mm	OAH mm	LB mm	WF mm	OAL mm	RADH mm	THOD	
MU.AH-BH06IK	6	12	28	48	46.0		48.5	22	M6	03001
MU.AH-BH08IK	8	14	28	48	46.0		48.5	22	M8	03002
MU.AH-BH10IK	10	16	28	48	46.0		49.5	22	M8	03003
MU.AH-BH12IK	12	18	28	48	50.0		52.5	22	M10	03004
MU.AH-BH14IK	14	19	28	48	50.5		54.0	22	M10	03005
MU.AH-BH16IK	16	21	28	48	50.5	2	54.0	22	M10	03006

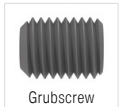

72 950 ...

Spare parts
for Article no.

72 982 03001	19011
72 982 03004	19013
72 982 03005	19013
72 982 03006	19013

Tool holders for clamping inserts

- ▲ Thro' coolant directly through base holder
- ▲ Also suitable for collet chucks

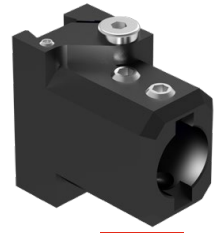
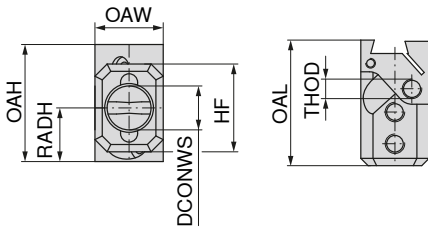

NEW



72 983 ...

Designation	DCONWS _{H6} mm	HF mm	OAW mm	OAH mm	RADH mm	OAL mm	CRNT
MU.AH-S20IK	20	36	28	48	22	51.5	M8x1

20001

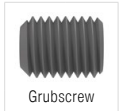

Grubscrew

83 950 ...

Spare parts
for Article no.
72 983 20001

464

Clamping insert for UltraMini cutting inserts

▲ with inner high-pressure coolant supply through the tool

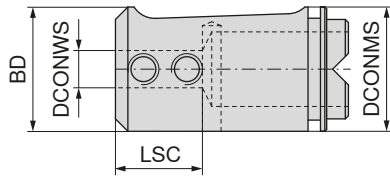

72 995 ...

Designation	DCONMS _{g6} mm	DCONWS mm	BD _{g6} mm	LSC mm	
MU.ULTRAMINI.KH-DM4	20	4	20	13	08001
MU.ULTRAMINI.KH-DM5	20	5	20	14	08002
MU.ULTRAMINI.KH-DM6	20	6	20	14	08003
MU.ULTRAMINI.KH-DM7	20	7	20	14	08004
MU.ULTRAMINI.KH-DM8	20	8	20	19	08005



Spare parts

DCONWS	
4	19009
5 - 7	19010
8	19012

Suitable UltraMini cutting inserts can be found on → **Page 290–309**

ER collet chuck (mini lock nut)

▲ with inner high-pressure coolant supply through the tool

Scope of supply:

Base body without lock nut

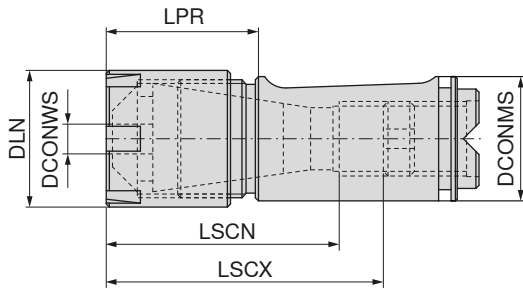

72 984 ...

Designation	LPR mm	DCONMS _{g6} mm	DLN mm	LSCX mm	LSCN mm	for collet	
MU.S20-SPZH-ER16-IK	25.0	20	22	55	38	426E (ER16)	06001
MU.S20-SPZH-ER20-IK	27.5	20	28	56	40	428E (ER20)	06002



83 950 ...

**Spare parts
for Article no.**

72 984 06001	058
72 984 06002	059

Sealing discs can be found in our clamping technology catalogue, Chapter Adapters and accessories on → **Page 269.**

Rear holder with screw clamping for CC.. Indexable inserts

▲ for STAR SR 20 R-IV / 20 JII / 32 JII / 38 / SW 12 / 20 / SV 20 R

Scope of supply:

Holder with coolant nozzle and screw plug, without coolant connection

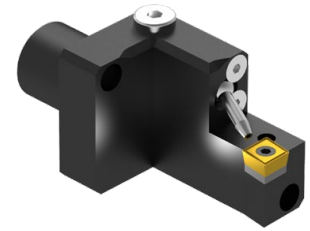
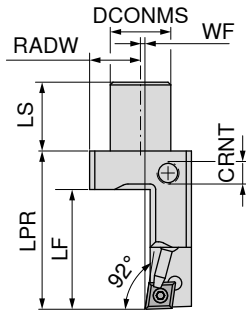

NEW

72 955 ...

Designation	DCONMS mm _{g6}	LS mm	LF mm	WF mm	LPR mm	RADW mm	CRNT	Insert	
ST.SR20R4-RE-K-CC09-L-IK	22	25	43.5	1.5	77.5	18.5	M8x1	CC.. 09T3	08005
ST.SR20R4-RE-K-CC09-R-IK	22	25	43.5	1.5	57.5	18.5	M8x1	CC.. 09T3	08004

Screw plug	Countersunk screw	Coolant nozzle	Combination Key	Clamping screw	Carbide type C	Threaded sleeve	Alu ring	
72 950 ...	72 950 ...	72 989 ...	70 950 ...	70 950 ...	70 950 ...	70 950 ...	72 950 ...	
19006	19007	10002	398	113	165	171	19008	
72 955 08005	19006	19007	10002	398	113	165	171	19008

Spare parts for Article no.

72 955 08005	19006	19007	10002	398	113	165	171	19008
72 955 08004	19006	19007	10002	398	113	165	171	19008

Suitable indexable inserts can be found in the ISO turning section on → Page 13–16.

Rear holder with screw clamping for DC.. Indexable inserts

▲ for STAR SR 20 R-IV / 20 JII / 32 JII / 38 / SW 12 / 20 / SV 20 R

Scope of supply:

Holder with coolant nozzle and screw plug, without coolant connection

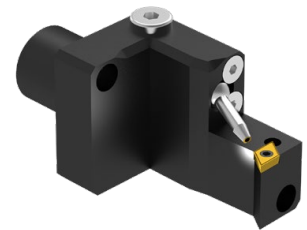
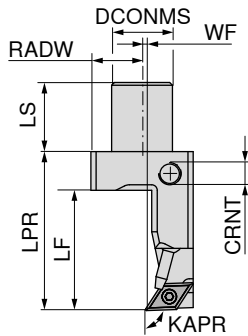

NEW

72 955 ...







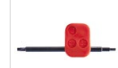

Designation	DCONMS _{g6} mm	LS mm	LF mm	WF mm	LPR mm	RADW mm	CRNT	KAPR °	Insert	
ST.SR20R4-RE-K-DC07-R-IK	22	25	43.5	1.5	57.5	18.5	M8x1	92	DC.. 0702	08006
ST.SR20R4-RE-K-DC11-R-IK	22	25	43.5	1.0	57.5	18.5	M8x1	92	DC.. 11T3	08008
ST.SR20R4-RE-L-DC07-R-IK	22	25	43.5	1.5	77.5	18.5	M8x1	92	DC.. 0702	08007
ST.SR20R4-RE-L-DC11-R-IK	22	25	43.5	1.0	77.5	18.5	M8x1	92	DC.. 11T3	08009

Spare parts for Article no.

Article no.	70 950 ...	70 950 ...	70 950 ...	72 950 ...	72 950 ...
72 955 08006		112			19008
72 955 08008	398	113		19005	19008
72 955 08007		112			19008
72 955 08009	398	113	106	19005	19008

Spare parts for Article no.

Article no.	72 950 ...	72 950 ...	80 950 ...	72 989 ...
72 955 08006		19006	19007	110
72 955 08008		19006	19007	110
72 955 08007		19006	19007	110
72 955 08009		19006	19007	110

 Combination Key 70 950 ...	 Clamping screw 70 950 ...	 Solid Carbide Seat D 70 950 ...	 Threaded bush 72 950 ...	 Alu ring 72 950 ...
 Screw plug 72 950 ...	 Countersunk screw 72 950 ...	 Key D 80 950 ...	 Coolant nozzle 72 989 ...	

1 Suitable indexable inserts can be found in the ISO turning section on → Page 40–42.

Rear holder with screw clamping for DC.. Indexable inserts

▲ for STAR SR 20 R-IV / 20 JII / 32 JII / 38 / SW 12 / 20 / SV 20 R

Scope of supply:

Holder with coolant nozzle and screw plug, without coolant connection

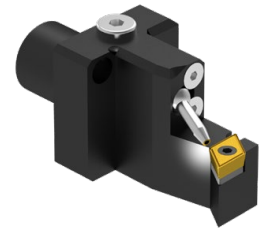
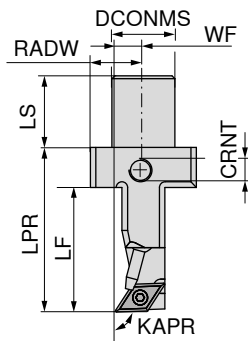

NEW

72 955 ...

Designation	DCONMS mm _{g6}	LS mm	LF mm	WF mm	LPR mm	RADW mm	CRNT	KAPR °	Insert	
ST.SR20R4-RX-K-DC11-R-1K	22	25	43.5	10	57.5	18.5	M8x1	92	DC.. 11T3	08010
ST.SR20R4-RX-L-DC11-R-1K	22	25	43.5	10	77.5	18.5	M8x1	92	DC.. 11T3	08011

Screw plug	Countersunk screw	Coolant nozzle	Combination Key	Clamping screw	Solid Carbide Seat D	Threaded sleeve	Alu ring	
72 950 ...	72 950 ...	72 989 ...	70 950 ...	70 950 ...	70 950 ...	70 950 ...	72 950 ...	
19006	19007	10002	398	113	106	171	19008	
72 955 08010	19006	19007	10002	398	113	106	171	19008

Spare parts for Article no.

72 955 08010	19006	19007	10002	398	113	106	171	19008
72 955 08011	19006	19007	10002	398	113	106	171	19008

 Suitable indexable inserts can be found in the ISO turning section on → Page 40–42.

Rear holder with screw clamping for VC.. Indexable inserts

▲ for STAR SR 20 R-IV / 20 JII / 32 JII / 38 / SW 12 / 20 / SV 20 R

Scope of supply:

Holder with coolant nozzle and screw plug, without coolant connection

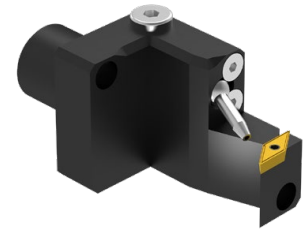
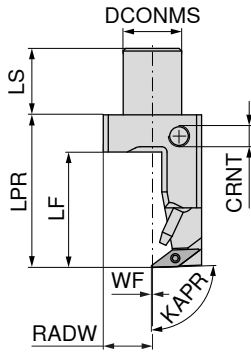

NEW

72 955 ...

Designation	DCONMS mm _{g6}	LS mm	LF mm	WF mm	LPR mm	RADW mm	CRNT	KAPR °	Insert	
ST.SR20R4-RE-K-VC11-R-1K	22	25	43.5	0.5	57.5	18.5	M8x1	92	VC.. 1103	08012
ST.SR20R4-RE-L-VC11-R-1K	22	25	43.5	0.5	77.5	18.5	M8x1	92	VC.. 1103	08013

Screw plug	Countersunk screw	Key D	Coolant nozzle	Clamping screw	Alu ring
72 950 ...	72 950 ...	80 950 ...	72 989 ...	70 950 ...	72 950 ...
19006	19007	110	10002	112	19008
19006	19007	110	10002	112	19008

Spare parts for Article no.

72 955 08012
72 955 08013

Suitable indexable inserts can be found in the ISO turning section on → Page 40–42.

Rear holder with screw clamping for VC.. Indexable inserts

▲ for STAR SR 20 R-IV / 20 JII / 32 JII / 38 / SW 12 / 20 / SV 20 R

Scope of supply:

Holder with coolant nozzle and screw plug, without coolant connection

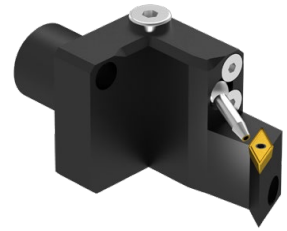
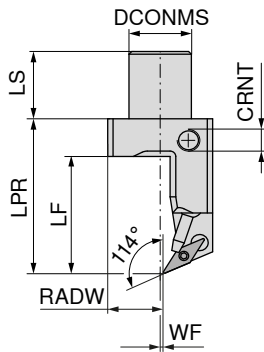

NEW

72 955 ...

Designation	DCONMS _{g6} mm	LS mm	LF mm	WF mm	LPR mm	RADW mm	CRNT	Insert	
ST.SR20R4-RE-K-VC11-24-R-IK	22	25	43.5	1.1	57.5	18.5	M8x1	VC.. 1103	08014
ST.SR20R4-RE-L-VC11-24-R-IK	22	25	43.5	1.1	77.5	18.5	M8x1	VC.. 1103	08015

Screw plug	Countersunk screw	Key D	Coolant nozzle	Clamping screw	Alu ring
72 950 ...	72 950 ...	80 950 ...	72 989 ...	70 950 ...	72 950 ...
19006	19007	110	10002	112	19008
19006	19007	110	10002	112	19008

Spare parts for Article no.

72 955 08014
72 955 08015

Suitable indexable inserts can be found in the ISO turning section on → **Page 40–42.**

Rear holder for right outer thread-turning inserts (ER 16..)

- ▲ for **STAR** SR 20 R-IV / 20 JII / 32 JII / 38 / SW 12 / 20 / SV 20 R
- ▲ Tool holder with approach angle 1.5°
- ▲ Thread-turning inserts with pitch max. 1.5 mm

Scope of supply:

Holder with coolant nozzle and screw plug, without coolant connection

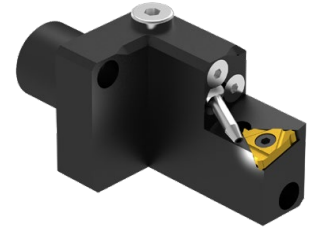
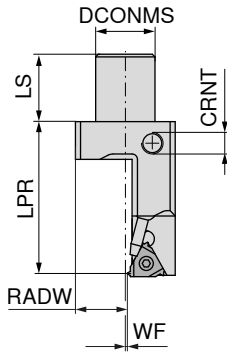

NEW
Right-hand
72 955 ...

Designation	DCONMS _{g6} mm	LS mm	WF mm	LPR mm	RADW mm	CRNT	Insert	
ST.SR20R4-RE-K-ER16-R-1K	22	25	0.7	57.5	18.5	M8x1	16 ER..	08016
ST.SR20R4-RE-L-ER16-R-1K	22	25	0.7	77.5	18.5	M8x1	16 ER..	08017

Screw plug	Countersunk screw	Key D	Coolant nozzle	Clamping screw	Alu ring
72 950 ...	72 950 ...	80 950 ...	72 989 ...	71 950 ...	72 950 ...
19006	19007	112	10002	231	19008
19006	19007	112	10002	231	19008

Spare parts
for Article no.
72 955 08016
72 955 08017

Suitable indexable inserts can be found in **Chapter 2, Thread turning.**

Rear holder for TX grooving inserts

▲ for **STAR** SR 20 R-IV / 20 JII / 32 JII / 38 / SW 12 / 20 / SV 20 R
▲ Insert width 0.5-4.0 mm

Scope of supply:

Holder with coolant nozzle and screw plug, without coolant connection

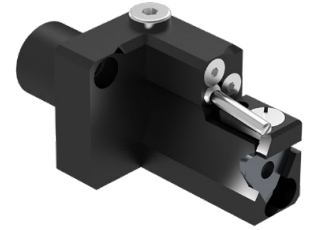
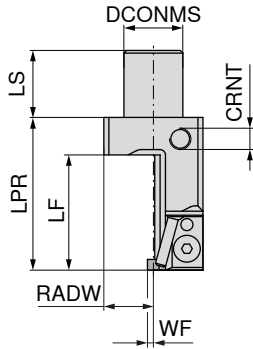

NEW

72 955 ...

Designation	DCONMS _{g6} mm	LS mm	LF mm	WF mm	LPR mm	RADW mm	CRNT	Insert	
ST.SR20R4-RE-K-TX-R-IK	22	25	43	2	57	18.5	M8x1	TX R/N/L ...2/3/4	16018
ST.SR20R4-RE-L-TX-R-IK	22	25	43	2	77	18.5	M8x1	TX R/N/L ...2/3/4	16019

Screw plug	Clamp	Lock washer	Countersunk screw	Coolant nozzle	Guide pin with flange	Alu ring
72 950 ...	72 950 ...	72 950 ...	72 950 ...	72 989 ...	72 950 ...	72 950 ...
19006	19001	19002	19003	10001	19004	19008
72 955 16018	19006	19001	19002	10001	19004	19008
72 955 16019	19006	19001	19002	10001	19004	19008

Spare parts for Article no.

72 955 16018	19006	19001	19002	19003	10001	19004	19008
72 955 16019	19006	19001	19002	19003	10001	19004	19008

Suitable indexable inserts can be found in the main catalogue, **Chapter 11 Grooving tools.**

Rear holder with screw clamping for CC.. Indexable inserts

▲ for **TSUGAMI** B0 266 / 326 / 386 / 38T / HS 267 / 237 / 38M / BW 269 / 329

Scope of supply:

Holder with coolant nozzle and screw plug, without coolant connection

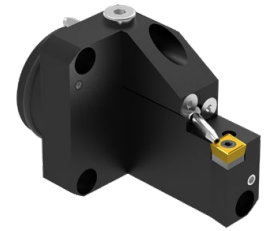
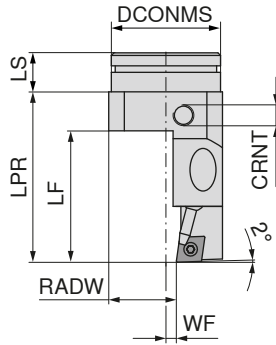





NEW

72 957 ...
08001

Designation	DCONMS _{g6} mm	LS mm	LF mm	WF mm	LPR mm	RADW mm	CRNT	Insert
TS.RE42.65-CC09-R-1K	42	15	50.5	4	65.5	26	M8x1	CC.. 09T3

Spare parts
for Article no.
72 957 08001

 Screw plug 72 950 ... 19006	 Countersunk screw 72 950 ... 19007	 Key D 80 950 ... 113	 Coolant nozzle 72 989 ... 10002	 Clamping screw 70 950 ... 113	 Carbide type C 70 950 ... 165	 Threaded sleeve 70 950 ... 171	 Alu ring 72 950 ... 19008
--	---	---	--	---	--	---	--

 Suitable indexable inserts can be found in the ISO turning section on → **Page 13–16.**

Rear holder with screw clamping for DC.. Indexable inserts

▲ for **TSUGAMI** B0 266 / 326 / 386 / 38T / HS 267 / 237 / 38M / BW 269 / 329

Scope of supply:



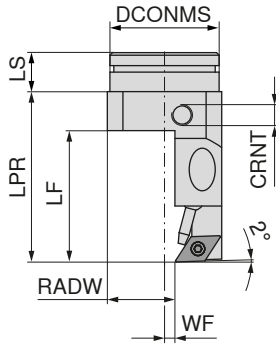





Holder with coolant nozzle and screw plug, without coolant connection



NEW

72 957 ...

Designation	DCONMS _{g6} mm	LS mm	LF mm	WF mm	LPR mm	RADW mm	CRNT	Insert	
TS.RE42.65-DC11-R-1K	42	15	50.5	4	65.5	26	M8x1	DC.. 11T3	08002

 Screw plug	 Countersunk screw	 Coolant nozzle	 Combination Key	 Clamping screw	 Solid Carbide Seat D	 Threaded sleeve	 Alu ring
72 950 ...	72 950 ...	72 989 ...	70 950 ...	70 950 ...	70 950 ...	70 950 ...	72 950 ...
19006	19007	10002	398	113	106	171	19008

Spare parts
for Article no.
72 957 08002

 Suitable indexable inserts can be found in the ISO turning section on → **Page 40–42.**

Rear holder (double) with screw clamping for CC.. / DC.. Indexable inserts

▲ for **TSUGAMI** B0 266 / 326 / 386 / 38T / HS 267 / 237 / 38M / BW 269 / 329

Scope of supply:

Holder with coolant nozzle and screw plug, without coolant connection

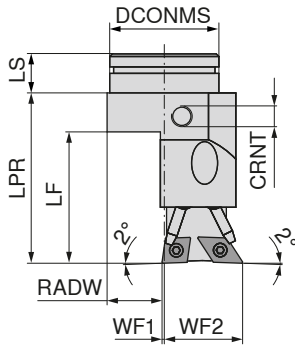

NEW
double
72 957 ...

Designation	DCONMS _{g6} mm	LS mm	LF mm	LPR mm	WF1 mm	WF2 mm	RADW mm	CRNT	Insert	
TS.RD42.65-CC09-R-DC11-L-IK	42	15	50.5	65.5	1	30	21	M8x1	CC.. 09T3 / DC.. 11T3	08009

Spare parts
for Article no.
72 957 08009

70 950 ...	70 950 ...	70 950 ...	70 950 ...	72 950 ...
113	106	165	171	19008

Spare parts
for Article no.
72 957 08009

72 950 ...	72 950 ...	80 950 ...	72 989 ...	70 950 ...
19006	19007	113	10002	398

Suitable CC.. Indexable inserts can be found in the ISO turning section on → **Page 13–16.**
Suitable DC.. Indexable inserts can be found in the ISO turning section on → **Page 23–27.**

3

Overhead rear holder with screw clamping for DC.. Indexable inserts

▲ for **TSUGAMI** B0 266 / 326 / 386 / 38T / HS 267 / 237 / 38M / BW 269 / 329

Scope of supply:

Holder with coolant nozzle and screw plug, without coolant connection

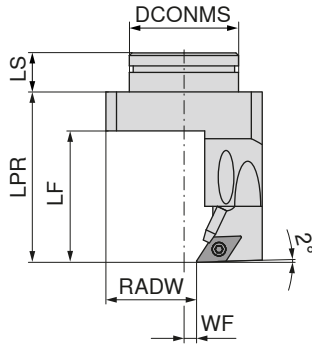









NEW

72 957 ...

Designation	DCONMS _{g6} mm	LS mm	LF mm	LPR mm	WF mm	RADW mm	Insert	
TS.RY42.65-DC11-R-1K	42	15	50.5	65.5	4.5	34.5	DC.. 11T3	08007

**Spare parts
for Article no.
72 957 08007**

							
Screw plug	Countersunk screw	Coolant nozzle	Combination Key	Clamping screw	Solid Carbide Seat D	Threaded sleeve	Alu ring
72 950 ...	72 950 ...	72 989 ...	70 950 ...	70 950 ...	70 950 ...	70 950 ...	72 950 ...
19006	19007	10002	398	113	106	171	19008

 Suitable indexable inserts can be found in the ISO turning section on → **Page 23–27.**

Rear holder (double) with screw clamping for DC.. Indexable inserts

▲ for **TSUGAMI** B0 266 / 326 / 386 / 38T / HS 267 / 237 / 38M / BW 269 / 329

Scope of supply:



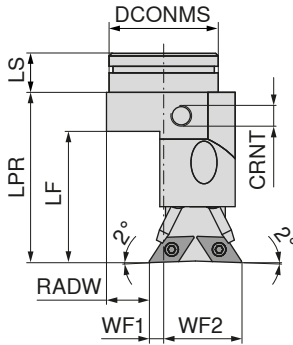





Holder with coolant nozzle and screw plug, without coolant connection



NEW
double
72 957 ...
08011

Designation	DCONMS _{g6} mm	LS mm	LF mm	LPR mm	WF1 mm	WF2 mm	RADW mm	CRNT	Insert
TS.RD42.65-DC11-R-DC11-L-1K	42	15	50.5	65.5	5.5	30	16.5	M8x1	DC.. 11T3

Spare parts
for Article no.
72 957 08011

 Screw plug 72 950 ... 19006	 Countersunk screw 72 950 ... 19007	 Coolant nozzle 72 989 ... 10002	 Combination Key 70 950 ... 398	 Clamping screw 70 950 ... 113	 Solid Carbide Seat D 70 950 ... 106	 Threaded sleeve 70 950 ... 171	 Alu ring 72 950 ... 19008
---	--	---	--	--	---	--	---

 Suitable indexable inserts can be found in the ISO turning section on → **Page 40–42.**

Rear holder with screw clamping for VC.. Indexable inserts

▲ for **TSUGAMI** B0 266 / 326 / 386 / 38T / HS 267 / 237 / 38M / BW 269 / 329

Scope of supply:



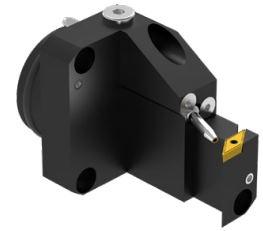
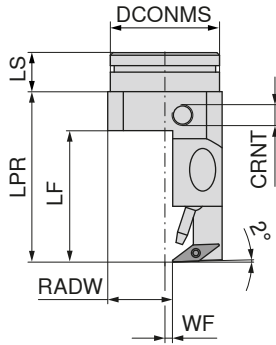



Holder with coolant nozzle and screw plug, without coolant connection



NEW

72 957 ...

Designation	DCONMS _{g6} mm	LS mm	LF mm	LPR mm	WF mm	RADW mm	CRNT	Insert	
TS.RE42.65-VC11-R-1K	42	15	50.5	65.5	3	25	M8x1	VC.. 1103	08003

					
Screw plug	Countersunk screw	Key D	Coolant nozzle	Clamping screw	Alu ring
72 950 ...	72 950 ...	80 950 ...	72 989 ...	70 950 ...	72 950 ...
19006	19007	110	10002	112	19008

Spare parts
for Article no.
72 957 08003

 Suitable indexable inserts can be found in the ISO turning section on → **Page 40–42.**

Rear holder with screw clamping for VC.. Indexable inserts

▲ for TSUGAMI B0 266 / 326 / 386 / 38T / HS 267 / 237 / 38M / BW 269 / 329

Scope of supply:



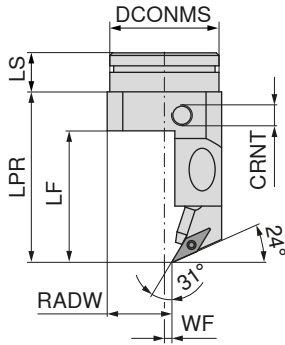

Holder with coolant nozzle and screw plug, without coolant connection

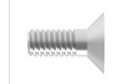

NEW

72 957 ...

Designation	DCONMS _{g6} mm	LS mm	LF mm	LPR mm	WF mm	RADW mm	CRNT	Insert	
TS.RE42.65-VC11-24-R-1K	42	15	50.5	65.5	3	25	M8x1	VC.. 1103	08004

 Screw plug 72 950 ... 19006	 Countersunk screw 72 950 ... 19007	 Key D 80 950 ... 110	 Coolant nozzle 72 989 ... 10002	 Clamping screw 70 950 ... 112	 Alu ring 72 950 ... 19008
--	---	--	--	--	--

Spare parts
for Article no.
72 957 08004

 Suitable indexable inserts can be found in the ISO turning section on → Page 40–42.

Overhead rear holder with screw clamping for VC.. Indexable inserts

▲ for **TSUGAMI** B0 266 / 326 / 386 / 38T / HS 267 / 237 / 38M / BW 269 / 329

Scope of supply:



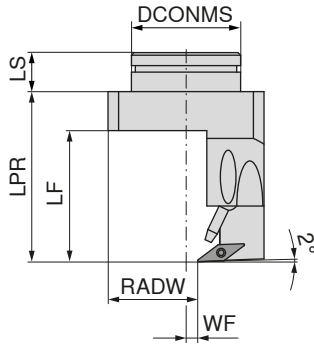



Holder with coolant nozzle and screw plug, without coolant connection



NEW

72 957 ...

Designation	DCONMS _{g6} mm	LS mm	WF mm	LF mm	LPR mm	RADW mm	CRNT	Insert	
TS.RY42.65-VC11-R-1K	42	15	3	50.5	65.5	25	M8x1	VC.. 1103	08008

 Screw plug	 Countersunk screw	 Key D	 Coolant nozzle	 Clamping screw	 Alu ring
72 950 ...	72 950 ...	80 950 ...	72 989 ...	70 950 ...	72 950 ...
19006	19007	110	10002	112	19008

Spare parts
for Article no.
72 957 08008

 Suitable indexable inserts can be found in the ISO turning section on → **Page 40–42.**

Rear holder (double) with screw clamping for VC.. / DC.. Indexable inserts

▲ for **TSUGAMI** B0 266 / 326 / 386 / 38T / HS 267 / 237 / 38M / BW 269 / 329

Scope of supply:

Holder with coolant nozzle and screw plug, without coolant connection

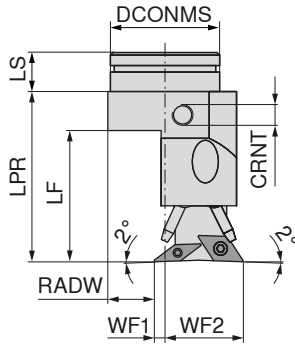

NEW
double
72 957 ...

Designation	DCONMS mm _{g6}	LS mm	LF mm	LPR mm	WF1 mm	WF2 mm	RADW mm	CRNT	Insert	
TS.RD42.65-VC11-R-DC11-L-1K	42	15	50.5	65.5	4	30	18	M8x1	VC.. 1103 / DC.. 11T3	08010

Spare parts
for Article no.
72 957 08010

70 950 ...	70 950 ...	70 950 ...	70 950 ...	72 950 ...
398	113	106	171	19008

Spare parts
for Article no.
72 957 08010

72 950 ...	72 950 ...	80 950 ...	72 989 ...
19006	19007	110	10002

Suitable indexable inserts can be found in the ISO turning section on → **Page 40–42.**

3

Rear holder for right outer thread-turning inserts (ER 16..)

- ▲ for **TSUGAMI** B0 266 / 326 / 386 / 38T / HS 267 / 237 / 38M / BW 269 / 329
- ▲ Tool holder with approach angle 1.5°
- ▲ Thread-turning inserts with pitch max. 1.5 mm





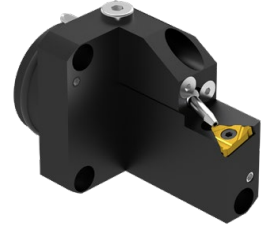
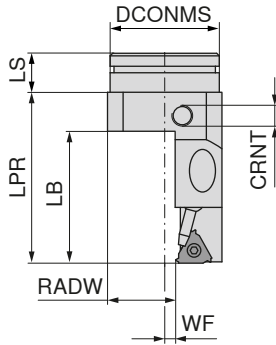

Scope of supply:

Holder with coolant nozzle and screw plug, without coolant connection



NEW
Right-hand
72 957 ...

Designation	DCONMS _{g6} mm	LS mm	LF mm	WF mm	LPR mm	RADW mm	CRNT	Insert	
TS.RE42.65-ER16-R-IK	42	15	50.5	4	65.5	26	M8x1	16 ER..	08005

 Screw plug	 Countersunk screw	 Key D	 Coolant nozzle	 Clamping screw	 Alu ring
72 950 ...	72 950 ...	80 950 ...	72 989 ...	71 950 ...	72 950 ...
19006	19007	112	10002	231	19008

Spare parts
for Article no.
72 957 08005

 Suitable indexable inserts can be found in **Chapter 2, Thread turning.**

Rear holder for TX grooving inserts

▲ for **TSUGAMI** B0 266 / 326 / 386 / 38T / HS 267 / 237 / 38M / BW 269 / 329
▲ Insert width 0.5-4.0 mm

Scope of supply:

Holder with coolant nozzle and screw plug, without coolant connection

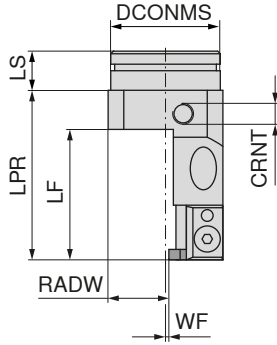

NEW
72 957 ...

Designation	DCONMS _{g6} mm	LS mm	LF mm	WF mm	LPR mm	RADW mm	CRNT	Insert	
TS.RE42.65-TX-R-IK	42	15	50	1	65.5	23	M8x1	TX R/N/L ...2/3/4	16006

**Spare parts
for Article no.**
72 957 16006

Screw plug	Clamp	Lock washer	Countersunk screw	Coolant nozzle	Guide pin with flange	Alu ring
72 950 ...	72 950 ...	72 950 ...	72 950 ...	72 989 ...	72 950 ...	72 950 ...
19006	19001	19002	19003	10001	19004	19008

Suitable indexable inserts can be found in the main catalogue, **Chapter 11 Grooving tools.**

Rear holder for drills and boring bars

▲ for **STAR** SR 20 R-IV / 20 JII / 32 JII / 38 / SW 12 / 20 / SV 20 R

▲ with inner high-pressure coolant supply through the tool

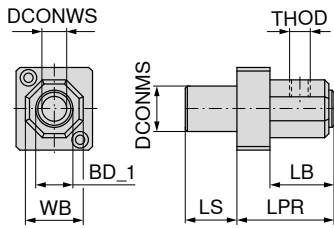

NEW



72 955 ...

Designation	DCONMS mm ^{g6}	DCONWS mm	BD_1 mm	LPR mm	LS mm	WB mm	LB mm	THOD	
ST.SR20R4-BH-06-1K	22	6	12	47	25	28	31	M6	03020
ST.SR20R4-BH-08-1K	22	8	14	47	25	28	31	M8	03021
ST.SR20R4-BH-10-1K	22	10	16	47	25	28	31	M8	03022
ST.SR20R4-BH-12-1K	22	12	18	47	25	28	31	M10	03023
ST.SR20R4-BH-14-1K	22	14	19	47	25	28	31	M10	03024
ST.SR20R4-BH-66-1K	22	16	21	47	25	32	31	M10	03025

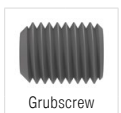

Grubscrew

72 950 ...

Spare parts
for Article no.
72 955 03020
72 955 03023
72 955 03024
72 955 03025

19011
19013
19013
19013

Rear holder for drills and boring bars

▲ for **TSUGAMI** B0 266 / 326 / 386 / 38T / HS 267 / 237 / 38M / BW 269 / 329

▲ with inner high-pressure coolant supply through the tool

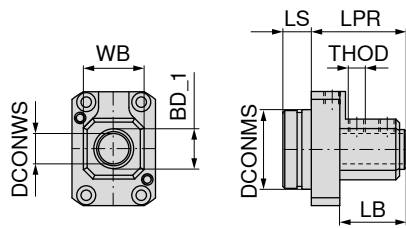

NEW



72 957 ...

Designation	DCONMS mm ^{g6}	DCONWS mm	BD_1 mm	LPR mm	LS mm	WB mm	LB mm	THOD	
TS.RE42.65-BH-06-1K	42	6	12	50	15	28	35	M6	03012
TS.RE42.65-BH-08-1K	42	8	14	50	15	28	35	M8	03013
TS.RE42.65-BH-10-1K	42	10	16	50	15	28	35	M8	03014
TS.RE42.65-BH-12-1K	42	12	18	50	15	28	35	M10	03015
TS.RE42.65-BH-14-1K	42	14	18	50	15	28	35	M10	03016
TS.RE42.65-BH-16-1K	42	16	21	50	15	32	35	M10	03017

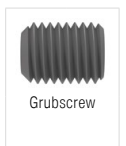

72 950 ...

Spare parts
for Article no.
72 957 03012
72 957 03015
72 957 03016
72 957 03017

19011
19013
19013
19013

Rear holder for clamping inserts

- ▲ for **STAR** SR 20 R-IV / 20 JII / 32 JII / 38 / SW 12 / 20 / SV 20 R
- ▲ Thro' coolant directly through base holder
- ▲ Also suitable for collet holders

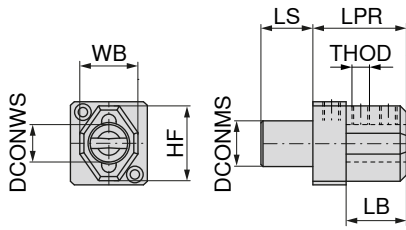

NEW



72 955 ...

Designation	DCONMS _{G6} mm	DCONWS _{H6} mm	HF mm	LS mm	LB mm	WB mm	LPR mm	CRNT
ST.SR20R4-S20-1K	22	20	36	25	29	28	45	M8x1

20027

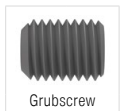

Grubscrew

83 950 ...

Spare parts
for Article no.
72 955 20027

464

 Suitable cutting inserts and collet holders can be found on → **Page 76+77**

Rear holder for clamping inserts

- ▲ for **TSUGAMI** B0 266 / 326 / 386 / 38T / HS 267 / 237 / 38M / BW 269 / 329
- ▲ Thro' coolant directly through base holder
- ▲ Also suitable for collet holders

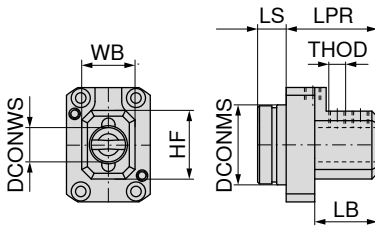

NEW



72 957 ...

Designation	DCONMS _{g6}	DCONWS _{H6}	HF	LS	LB	WB	LPR	CRNT	
	mm	mm	mm	mm	mm	mm	mm		
TS.RE42.65-S-20-IK	42	20	36	15	33	28	48	M8x1	20018

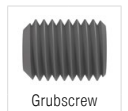

Grubscrew

83 950 ...

Spare parts
for Article no.
72 957 20018

464

 Suitable cutting inserts and collet holders can be found on → **Page 76+77**

Coolant attachment for height-adjustable insert holder, left



NEW

Left-hand

72 985 ...

Designation	for
MU.KS-KA-AH-L	MU.AH-...-L

09003

Coolant attachment for STAR

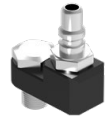
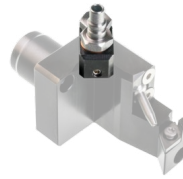

NEW

72 955 ...

Designation
ST.KS-KA-STAR

09026

Coolant attachment for height-adjustable insert holder, right



NEW

Right-hand

72 985 ...

Designation	for
MU.KS-KA-AH-R	MU.AH-...-R

09001

Coolant distributor for high-pressure connections - 6 outlets

Scope of supply:
without quick-couplers



NEW

72 991 ...

Designation
MU.KSV-45-30-35x6

12003

Coolant attachment for height-adjustable insert holder, double



NEW

double

72 985 ...

Designation	for
MU.KS-KA-AH-D	MU.AH-...-R/L

09002

Coolant distributor for high-pressure connections - 7 outlets

Scope of supply:
without quick-couplers



NEW

72 991 ...

Designation
MU.KSV-80-30-30x7

12002

Coolant distributor for high-pressure connections - 8 outlets

Scope of supply:
without quick-couplers



NEW

72 991 ...

12001

Designation

MU.KSV-110-30-30x8

Coolant distributor for STAR SR 32

▲ 4x high-pressure and 4x low-pressure connections (G1/8")

Scope of supply:
without quick-couplers

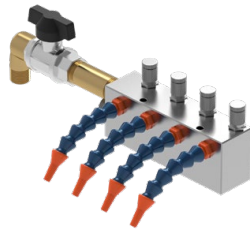

NEW

72 991 ...

12004

Designation

MU.KSV-45-30-35x6

Coolant nozzle for high-pressure applications



NEW

72 989 ...

10002

Designation

MU.KS-KD-HD

Coolant nozzle for TX grooving tool holder



NEW

72 989 ...

10001

Designation

MU.KS-KD-HO

Coolant nozzle for low-pressure applications



NEW

72 989 ...

10003

Designation

MU.KS-KD-ND

G1/8" screw plug

- ▲ Max. 200 bar/2900 psi
- ▲ No sealing ring required



NEW

72 950 ...

010

Designation

VS.G1/8

THSZMS

G1/8"

Angled coolant connection - short



NEW

short

72 987 ...

18001

Designation

MU.KS-KA-VU-K

THOD

M8x1

Angled coolant connection - long



NEW

long

72 987 ...

18002

Designation

MU.KS-KA-VU-L

THOD

M8x1

Angled coolant connection for distributor



NEW

72 987 ...

Designation	THOD	THID	
MU.KS-KA-KSV	G1/8"	G1/8"	18003

Threaded adapter

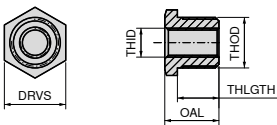

NEW

72 988 ...

THID	THOD	THLGH	DRVS	OAL	
		mm	mm	mm	
M8x1	G1/4"	11.5	17	15.0	01003
M8x1	M12x1	11.5	14	15.0	01001
M8x1	M14x1	11.5	17	15.0	01002
M8x1	G1/8"	11.5	14	23.5	01004

Flexible coolant hoses

- ▲ incl. prefitted quick-coupler and coupler connector
- ▲ extremely flexible
- ▲ pressure-resistant up to 300 bar



NEW

72 990 ...

Designation	BD	CND	OAL	
	mm	mm	mm	
MU.KSS-DN3-150	6.0	3	150	11005
MU.KSS-DN3-250	6.0	3	250	11006
MU.KSS-DN5-200	9.5	5	200	11001
MU.KSS-DN5-300	9.5	5	300	11002
MU.KSS-DN5-400	9.5	5	400	11003
MU.KSS-DN5-500	9.5	5	500	11004

Coupler connector

- ▲ pressure-resistant up to at least 400 bar

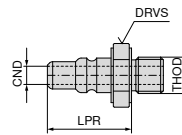

NEW

72 992 ...

Designation	LPR	CND	DRVS	OAL	
	mm	mm	mm	mm	
MU.KSKS-M8x1	18.5	4	12	19	13001

Quick-coupler

- ▲ pressure-resistant up to at least 400 bar
- ▲ rapid change of coolant distribution without screws thanks to click system

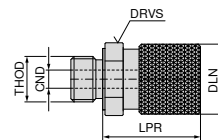

NEW

72 993 ...

THOD	BD	DLN	LPR	CND	
	mm	mm	mm	mm	
G1/8"	16	15.5	21.5	4	15001

Sealing plugs

- ▲ for closing off the quick-coupler to protect against contamination

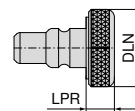

NEW

72 994 ...

Designation	LPR	DLN	
	mm	mm	
MU.KSVS	5.5	15.5	17001

Adjustment device for setting height of tool block holder

- ▲ Reduced setup times thanks to convenient presetting away from the machine
- ▲ prevention of machine downtimes
- ▲ best positional accuracy following tool change by presetting away from the machine

Scope of supply:

72 996 05001: Adjustment device with dial gauge and dial gauge stand
72 996 05002: Adjustment device without dial gauge and dial gauge stand

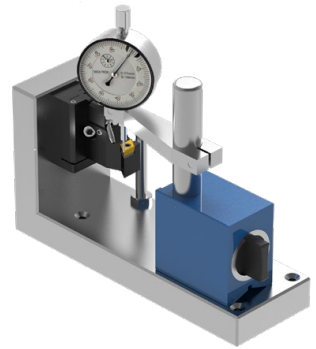

NEW

72 996 ...

Designation	
MU.EV MAX	05001
MU.EV MAX-OMU	05002

 Information on correct usage, and any conversions required can be found on → [Page 155+156](#)

Toolfinder – VertiClamp

- ▲ Vertical arrangement of cutting edges
Less space required
- ▲ Second cutting edge can still be used in the event of breakage
Minimises costs
- ▲ Insert seat protected against swarf
Increases the service life of the holder
- ▲ High changeover precision
Reduces unproductive times
- ▲ Large selection of indexable inserts and geometries
Increases flexibility
- ▲ Optional coolant supply to cutting edge
Increases service life and improves surface quality

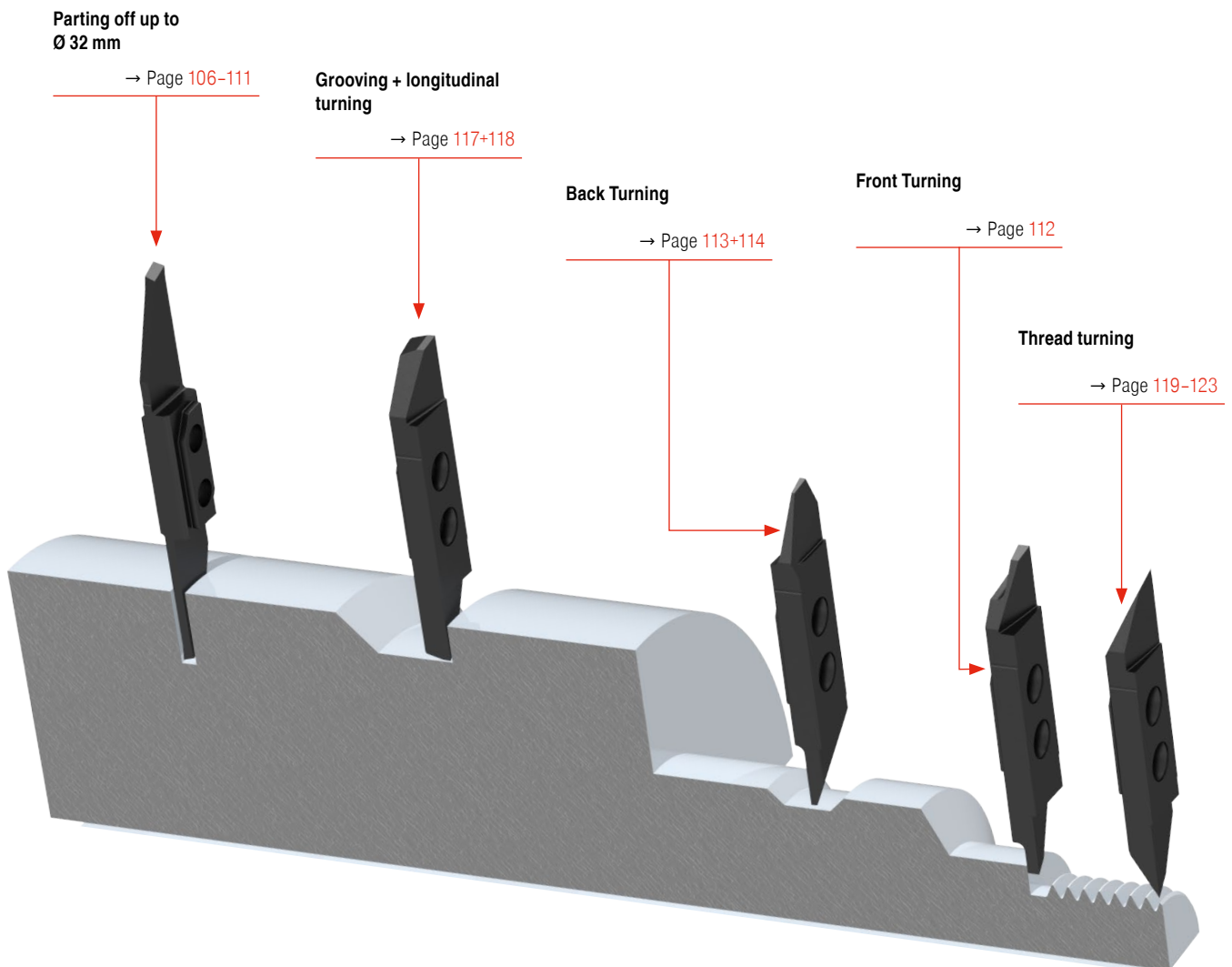
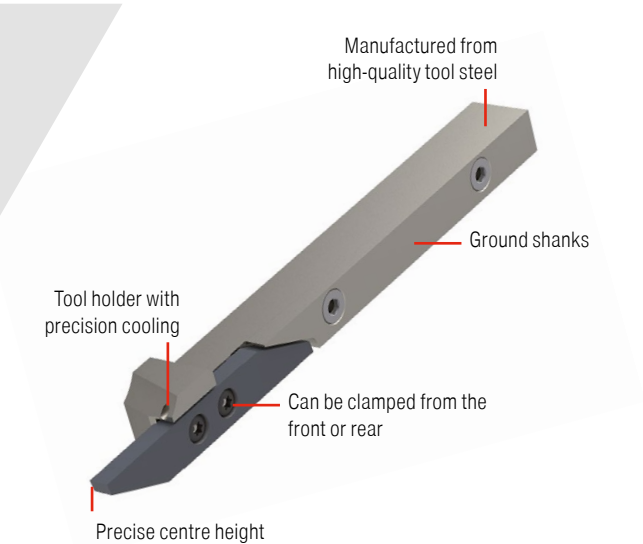

Overview – VertiClamp

Inserts

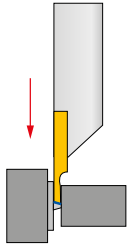
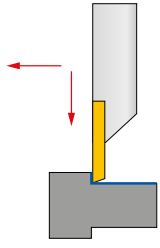
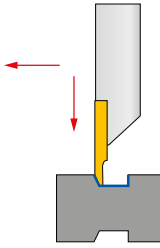
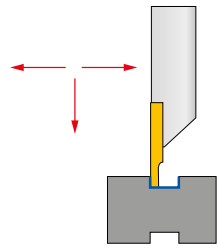
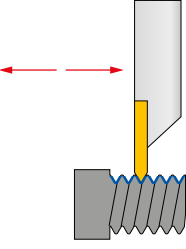
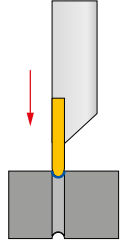
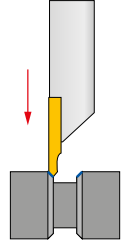
<p>Parting</p>  <p>→ Page 106-111</p>	<p>Front Turning</p>  <p>→ Page 112</p>	<p>Back Turning</p>  <p>→ Page 113+114</p>	<p>Grooving + longitudinal turning</p>  <p>→ Page 115-118</p>
<p>Thread turning</p>  <p>→ Page 119-123</p>	<p>Radius Grooving</p>  <p>→ Page 124</p>	<p>Chamfers</p>  <p>→ Page 125</p>	

Tool holder

<p>Standard tool holders</p>  <p>normal with through coolant</p> <p>→ Page 127 → Page 127</p>	<p>Offset tool holders</p>  <p>→ Page 128 → Page 129</p>	<p>Contra tool holders</p>  <p>→ Page 130</p>
--	---	--

3002 L / 3002 LV / 3002 R / 3002 RV

Designation	CW mm	PDPT mm
3002-0,8-6	0.8	6
3002-0,8-10	0.8	10
3002-1,0-6	1.0	6
3002-1,0-13	1.0	13
3002-1,2-6	1.2	6
3002-1,5-8	1.5	8
3002-1,5-16	1.5	16
3002-1,8-8	1.8	8
3002-2,0-10	2.0	10
3002-2,0-16	2.0	16
3002-2,5-13	2.5	13
3002-2,5-16	2.5	16
3002-3,0-16	3.0	16

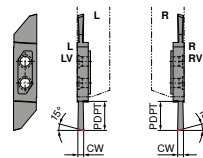

3002 L/LV / 3002 R/RV

3002 L / 3002 LV / 3002 R / 3002 RV

▲ for parting off

	WPU7620	WPU7620	WPU7620	WPU7620
	F	F	F	F
	3002 L	3002 LV	3002 R	3002 RV
	72 420 ...	72 422 ...	72 416 ...	72 418 ...
ISO				
3002-0,8-6	510	510	510	510
3002-0,8-10	530	530	530	530
3002-1,0-6	512	512	512	512
3002-1,0-13	532	532	532	532
3002-1,2-6	514	514	514	514
3002-1,5-8	516	516	516	516
3002-1,5-16	536	536	536	536
3002-1,8-8	518	518	518	518
3002-2,0-10	520	520	520	520
3002-2,0-16	540	540	540	540
3002-2,5-13	522 ¹⁾	522 ¹⁾	522 ¹⁾	522 ¹⁾
3002-2,5-16	542 ¹⁾	542 ¹⁾	542 ¹⁾	542 ¹⁾
3002-3,0-16	524 ¹⁾	524 ¹⁾	524 ¹⁾	524 ¹⁾
P	●	●	●	●
M	●	●	●	●
K	○	○	○	○
N	○	○	○	○
S	●	●	●	●
H				
O	○	○	○	○

1) used with tool holders with 12 mm and larger shank size

3002 L / 3002 LN / 3002 LV / 3002 R / 3002 RN / 3002 RV

Designation	CW mm	PDPT mm
3002-1,5-8	1.5	8
3002-1,5-10	1.5	10
3002-1,5-16	1.5	16
3002-2,0-10	2.0	10
3002-2,0-16	2.0	16
3002-2,5-13	2.5	13
3002-2,5-16	2.5	16
3002-3,0-16	3.0	16

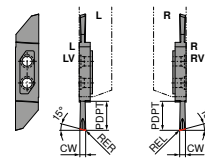

3002 L/LV / 3002 R/RV

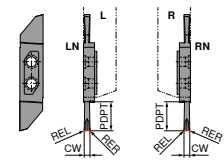

3002 LN / 3002 RN

3002 L / 3002 LN / 3002 LV / 3002 R / 3002 RN / 3002 RV

▲ for parting off

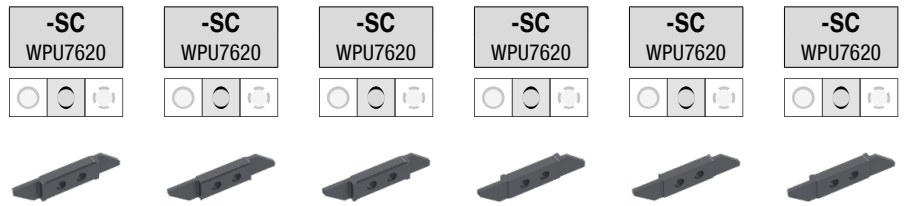

ISO	REL mm	RER mm	3002 L		3002 LN		3002 LV		3002 R		3002 RN		3002 RV	
			72 432 ...	72 426 ...	72 434 ...	72 428 ...	72 424 ...	72 430 ...						
3002-1,5-8	0.00	0.08	508				508							508
3002-1,5-8	0.08	0.00				510			508			510		
3002-1,5-10	0.08	0.08				530						530		528
3002-1,5-16	0.08	0.00							528					
3002-1,5-16	0.00	0.08	528											
3002-2,0-10	0.08	0.08				512						512		
3002-2,0-10	0.08	0.00							510					510
3002-2,0-10	0.00	0.08	510											
3002-2,0-16	0.08	0.08				532						532		530
3002-2,0-16	0.08	0.00							530					
3002-2,5-13	0.08	0.08				514 ¹⁾						514 ¹⁾		
3002-2,5-13	0.08	0.00							512 ¹⁾					512 ¹⁾
3002-2,5-13	0.00	0.08	512 ¹⁾											
3002-2,5-16	0.08	0.08				534 ¹⁾						534 ¹⁾		
3002-2,5-16	0.08	0.00							532 ¹⁾					532 ¹⁾
3002-2,5-16	0.00	0.08	532 ¹⁾											
3002-3,0-16	0.08	0.08				516 ¹⁾						516 ¹⁾		
3002-3,0-16	0.08	0.00							514 ¹⁾					514 ¹⁾
3002-3,0-16	0.00	0.08	514 ¹⁾											
P			●	●	●	●	●	●	●	●	●	●	●	●
M			●	●	●	●	●	●	●	●	●	●	●	●
K			○	○	○	○	○	○	○	○	○	○	○	○
N			○	○	○	○	○	○	○	○	○	○	○	○
S			●	●	●	●	●	●	●	●	●	●	●	●
H														
O			○	○	○	○	○	○	○	○	○	○	○	○

1) used with tool holders with 12 mm and larger shank size

3002 L / 3002 LV / 3002 R / 3002 RV

Designation	CW mm	PDPT mm	s mm
3002-0,8-10	0.8	10	2
3002-0,8-10	1.0	10	2
3002-1,0-13	1.0	13	2
3002-1,5-8-06	1.5	8	2
3002-1,5-8-12	1.5	8	2
3002-1,5-16	1.5	16	2
3002-2,0-10-06	2.0	10	2
3002-2,0-10-12	2.0	10	2
3002-2,0-16-12	2.0	16	2
3002-2,0-16-06	2.0	16	2
3002-2,5-13-12	2.5	13	2
3002-2,5-13-06	2.5	13	2
3002-2,5-16-12	2.5	16	2
3002-2,5-16-06	2.5	16	2
3002-3,0-16-12	3.0	16	2
3002-3,0-16-06	3.0	16	2

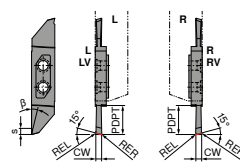

3002 L/LV / 3002 R/RV

3002 L / 3002 LV / 3002 R / 3002 RV

▲ for parting off

-SPT WPU7620	-SPT WPU7620	-SPT WPU7620	-SPT WPU7620
F 3002 L	F 3002 LV	F 3002 R	F 3002 RV
72 440 ...	72 442 ...	72 436 ...	72 438 ...

ISO	REL mm	RER mm	72 440 ...	72 442 ...	72 436 ...	72 438 ...
3002-0,8-10	0.00	0.00	50600	50600	50600	50600
3002-1,0-13	0.00	0.00	52800	52800	52800	52800
3002-1,5-16	0.00	0.00	53000	53000	53000	53000
3002-1,5-8-06	0.00	0.05	540	540		540
3002-1,5-8-06	0.05	0.00			540	
3002-1,5-8-12	0.00	0.05	570	570		570
3002-1,5-8-12	0.05	0.00			570	
3002-2,0-10-06	0.00	0.05	572	572		572
3002-2,0-10-06	0.05	0.00			572	
3002-2,0-10-12	0.00	0.05	582	582		582
3002-2,0-10-12	0.05	0.00			582	
3002-2,0-16-06	0.00	0.05	552	552		552
3002-2,0-16-06	0.05	0.00			552	
3002-2,0-16-12	0.00	0.05	592	592		592
3002-2,0-16-12	0.05	0.00			592	
3002-2,5-13-06	0.00	0.05	554	554		554
3002-2,5-13-06	0.05	0.00			554	
3002-2,5-13-12	0.00	0.05	584	584		584
3002-2,5-13-12	0.05	0.00			584	
3002-2,5-16-06	0.00	0.05	574	574		574
3002-2,5-16-06	0.05	0.00			574	
3002-2,5-16-12	0.00	0.05	594	594		594
3002-2,5-16-12	0.05	0.00			594	
3002-3,0-16-06	0.00	0.05	556	556		556
3002-3,0-16-06	0.05	0.00			556	
3002-3,0-16-12	0.00	0.05	586	586		586
3002-3,0-16-12	0.05	0.00			586	

P	●	●	●	●
M	●	●	●	●
K	○	○	○	○
N	○	○	○	○
S	●	●	●	●
H				
O	○	○	○	○

3002 LN / 3002 RN

Designation	CW mm	PDPT mm	s mm	β°
3002-1,0-10	1.0	10	2	20
3002-1,5-10-06	1.5	10	2	6
3002-1,5-10-12	1.5	10	2	12
3002-1,5-16	1.5	16	2	20
3002-2,0-10-06	2.0	10	2	6
3002-2,0-10-12	2.0	10	2	12
3002-2,0-16-12	2.0	16	2	12
3002-2,0-16-06	2.0	16	2	6
3002-2,5-13-12	2.5	13	2	12
3002-2,5-13-06	2.5	13	2	6
3002-2,5-16-06	2.5	16	2	6
3002-2,5-16-12	2.5	16	2	12
3002-3,0-16-12	3.0	16	2	12
3002-3,0-16-06	3.0	16	2	6

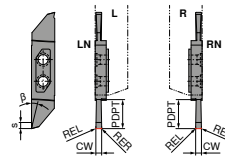

3002 LN / 3002 RN

3002 LN / 3002 RN

▲ for parting off

ISO	REL mm	RER mm
3002-1,0-10	0.05	0.05
3002-1,5-10-06	0.05	0.05
3002-1,5-10-12	0.05	0.05
3002-1,5-16	0.05	0.05
3002-2,0-10-06	0.05	0.05
3002-2,0-10-12	0.05	0.05
3002-2,0-16-06	0.05	0.05
3002-2,0-16-12	0.05	0.05
3002-2,5-13-06	0.05	0.05
3002-2,5-13-12	0.05	0.05
3002-2,5-16-06	0.05	0.05
3002-2,5-16-12	0.05	0.05
3002-3,0-16-06	0.05	0.05
3002-3,0-16-12	0.05	0.05

-SPT WPU7620	-SPT WPU7620
F 3002 LN	F 3002 RN
72 515 ...	72 514 ...
50800	50800
550	550
580	580
53000	53000
572	572
582	582
552	552
592	592
554	554
584	584
574	574
594	594
556	556
586	586

P	●	●
M	●	●
K	○	○
N	○	○
S	●	●
H		
O	○	○

3

3002 L-16 / 3002 LV-16 / 3002 R-16 / 3002 RV-16

Designation	CW mm	PDPT mm
3002-0,8-..	0.8	6
3002-1,0-..	1.0	6
3002-1,2-..	1.2	6

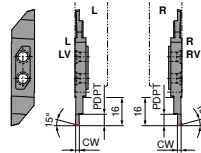

3002 L/LV / 3002 R/RV

3002 L-16 / 3002 LV-16 / 3002 R-16 / 3002 RV-16

▲ For parting off with pick-up spindle

	WPU7620	WPU7620	WPU7620	WPU7620
	F	F	F	F
	3002 L-16	3002 LV-16	3002 R-16	3002 RV-16
	72 497 ...	72 499 ...	72 496 ...	72 498 ...

ISO	3002 L-16	3002 LV-16	3002 R-16	3002 RV-16
3002-0,8-6-16	510	510	510	510
3002-1,0-6-16	51200	51200	51200	51200
3002-1,2-6-16	514	514	514	514
P	●	●	●	●
M	●	●	●	●
K	○	○	○	○
N	○	○	○	○
S	●	●	●	●
H				
O	○	○	○	○

3002 L / 3002 LN / 3002 LV / 3002 R / 3002 RN / 3002 RV

Designation	CW mm	PDPT mm
3002-2,0-10..	2	10

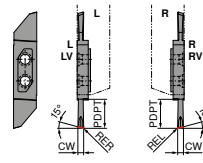

3002 L/LV / 3002 R/RV

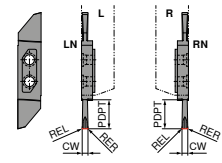

3002 LN / 3002 RN

3002 L / 3002 LN / 3002 LV / 3002 R / 3002 RN / 3002 RV

- ▲ For parting off
- ▲ **E**: Blade with rounded cutting edge
- ▲ **F**: Blade with sharp cutting edge

	-GS WPU7620	-GS WPU7620	-GS WPU7620	-GS WPU7620	-GS WPU7620	-GS WPU7620
	F 3002 L	F 3002 LN	F 3002 LV	F 3002 R	F 3002 RN	F 3002 RV
	72 501 ...	72 505 ...	72 507 ...	72 500 ...	72 504 ...	72 506 ...
ISO	REL mm	RER mm				
3002-2,0-10 E	0.2	0.2				
3002-2,0-10 E	0.2	0.0				
3002-2,0-10 E	0.0	0.2	512			
3002-2,0-10 F	0.2	0.2		512		
3002-2,0-10 F	0.2	0.0			512	
3002-2,0-10 F	0.0	0.2	552			512
				552	552	552

P	●	●	●	●	●	●
M	●	●	●	●	●	●
K	○	○	○	○	○	○
N	○	○	○	○	○	○
S	●	●	●	●	●	●
H						
O	○	○	○	○	○	○

3

3003 L / 3003 R

Designation	CBMD	CW mm	CF mm	s mm	PDPT mm
3003-3,4-..	-SPU	3.4	0.2	1.2	8
3003-3,4-..		3.4	1.0	-	8

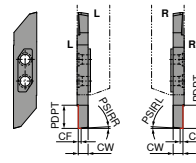

3003 L / 3003 R

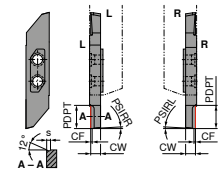

-SPU 3002 L / 3002 R

3003 L / 3003 R

▲ for front turning

	WPU7620	WPU7620	-SPU WPU7620	-SPU WPU7620
	F 3003 L	F 3003 R	F 3003 L	F 3003 R
	72 446 ...	72 444 ...	72 521 ...	72 520 ...
ISO				
3003-3,4-8	510	510	510	510

P	●	●	●	●
M	●	●	●	●
K	○	○	○	○
N	○	○	○	○
S	●	●	●	●
H				
O	○	○	○	○

3004 L / 3004 LV / 3004 R / 3004 RV

Designation	CRE mm	CW mm	PDPT mm	PNA °	β°
3004-3,2-5 35015	0.15	3.2	11	35	55
3004-3,2-5 35035	0.35	3.2	11	35	55
3004-3,2-6 29008	0.08	3.2	11	29	61
3004-3,2-6 29015	0.15	3.2	11	29	61
3004-3,2-6 29035	0.35	3.2	11	29	61
3004-3,2-6 29075	0.75	3.2	11	29	61

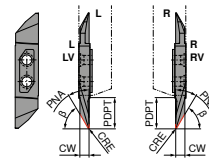

3004 L/LV / 3004 R/RV

3004 L / 3004 LV / 3004 R / 3004 RV

▲ for back turning

	-SP WPU7620	-SP WPU7620	-SP WPU7620	-SP WPU7620
	F 3004 L	F 3004 LV	F 3004 R	F 3004 RV
	72 562 ...	72 563 ...	72 560 ...	72 561 ...
ISO				
3004-3,2-5 35015	514		514	
3004-3,2-5 35035	516		516	
3004-3,2-6 29008	508	508	508	508
3004-3,2-6 29015	510	510	510	510
3004-3,2-6 29035	512	512	512	512
3004-3,2-6 29075	515	515	515	515

P	●	●	●	●
M	●	●	●	●
K	○	○	○	○
N	○	○	○	○
S	●	●	●	●
H				
O	○	○	○	○

3004 L / 3004 R

Designation	CW mm	CF mm	PDPT mm	a ₁ mm
3004-0,8-...	0.8	0.5	6	2.0
3004-1,0-...	1.0	0.5	6	2.2
3004-1,2-...	1.2	0.5	8	2.4
3004-1,5-...	1.5	0.5	8	2.7
3004-1,8-...	1.8	0.5	8	3.0

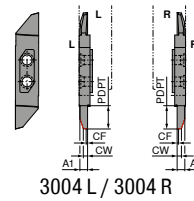

3004 L / 3004 R

▲ for back turning

WPU7620	WPU7620
F 3004 L	F 3004 R
72 457 ...	72 456 ...

ISO	3004 L	3004 R
3004-0,8-6	504	504
3004-1,0-6	506	506
3004-1,2-8	508	508
3004-1,5-8	510	510
3004-1,8-8	512	512
P	●	●
M	●	●
K	○	○
N	○	○
S	●	●
H		
O	○	○

3002-015 L / 3002-015 LV / 3002-015 R / 3002-015 RV

Designation	CW mm	CF mm	PDPT mm	β°	$a_{p\max}$ mm
3002-015-..	2	0.3	10	1,5	0.45

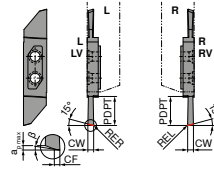

3002-015 L/LV / 3002-015 R/RV

3002-015 L / 3002-015 LV / 3002-015 R / 3002-015 RV

▲ For turning and parting off

	WPU7620	WPU7620	WPU7620	WPU7620
	F	F	F	F
	3002-015 L	3002-015 LV	3002-015 R	3002-015 RV
	72 517 ...	72 519 ...	72 516 ...	72 518 ...
	510	510	510	510

ISO	3002-015-2,0-10	510	510	510	510
P		●	●	●	●
M		●	●	●	●
K		○	○	○	○
N		○	○	○	○
S		●	●	●	●
H					
O		○	○	○	○

3

3002-015 L / 3002-015 LV / 3002-015 R / 3002-015 RV

Designation	CW mm	CF mm	PDPT mm	β°	$a_{p\max}$ mm
3002-015-..	2	0.3	10	15	0.45

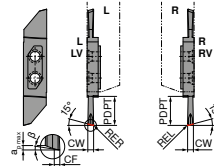

3002-015 L/LV / 3002-015 R/RV

3002-015 L / 3002-015 LV / 3002-015 R / 3002-015 RV

▲ For turning and parting off

	-SC WPU7620	-SC WPU7620	-SC WPU7620	-SC WPU7620
	F 3002-015 L	F 3002-015 LV	F 3002-015 R	F 3002-015 RV
	72 511 ...	72 513 ...	72 510 ...	72 512 ...
	510	510	510	510

ISO	REL mm	RER mm
3002-015-2,0-10	0.15	0.00
3002-015-2,0-10	0.00	0.15

P	●	●	●	●
M	●	●	●	●
K	○	○	○	○
N	○	○	○	○
S	●	●	●	●
H				
O	○	○	○	○

3005 L / 3005 R

Designation	CW mm	PDPT mm	b mm
3005-1,0-...	1.0	2.5	8
3005-1,5-...	1.5	3.0	8
3005-2,0-...	2.0	4.0	8
3005-2,5-...	2.5	5.0	8
3005-3,0-...	3.0	6.0	8

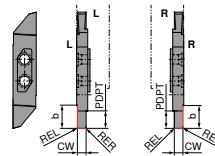

3005 L / 3006 R

3005 L / 3005 R

▲ for grooving and turning

ISO	REL mm	RER mm
3005-1,0-2,5	0.05	0.05
3005-1,5-3	0.05	0.05
3005-2,0-4	0.05	0.05
3005-2,5-5	0.05	0.05
3005-3,0-6	0.05	0.05

WPU7620		WPU7620	
<input type="checkbox"/>	<input type="checkbox"/>	<input type="checkbox"/>	<input type="checkbox"/>
F 3005 L		F 3005 R	
72 466 ...		72 464 ...	
518		518	
510		510	
512		512	
514		514	
516		516	

P	●	●
M	●	●
K	○	○
N	○	○
S	●	●
H		
O	○	○

3005 L / 3005 R

Designation	CW mm	PDPT mm	b mm	β°
3005-0,8-2,5	0.8	2.5	8	10
3005-1,0-3,5	1.0	3.5	8	10
3005-1,5-4	1.5	4.0	8	10
3005-1,5-4 R08	1.5	4.0	8	10
3005-2,0-5	2.0	5.0	8	10
3005-2,0-5 R08	2.0	5.0	8	10
3005-2,0-5 R15	2.0	5.0	8	10
3005-2,5-6	2.5	6.0	8	10
3005-2,5-6 R08	2.5	6.0	8	10
3005-2,5-6 R15	2.5	6.0	8	10
3005-3,0-6	3.0	6.0	8	10
3005-3,0-6 R08	3.0	6.0	8	10
3005-3,0-6 R15	3.0	6.0	8	10

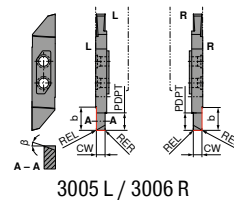

3005 L / 3005 R

▲ for grooving and turning

ISO	REL mm	RER mm
3005-0,8-2,5	0.00	0.00
3005-1,0-3,5	0.00	0.00
3005-1,5-4	0.00	0.00
3005-1,5-4 R08	0.08	0.08
3005-2,0-5	0.00	0.00
3005-2,0-5 R08	0.08	0.08
3005-2,0-5 R15	0.15	0.15
3005-2,5-6	0.00	0.00
3005-2,5-6 R08	0.08	0.08
3005-2,5-6 R15	0.15	0.15
3005-3,0-6	0.00	0.00
3005-3,0-6 R08	0.08	0.08
3005-3,0-6 R15	0.15	0.15

P	●	●
M	●	●
K	○	○
N	○	○
S	●	●
H		
O	○	○

-CP WPU7620	-CP WPU7620
F 3005 L	F 3005 R
72 470 ...	72 468 ...
508	508
518	518
510	528
519	519
512	512
522	522
532	532
514	514
524	524
534	534
516	516
526	526
536	536

3006 L / 3006 R

Designation	TP mm	CW mm	PDPT mm	PNA °	CF mm
3006-2-6-...	0,25 - 2,0	2	6	60	0.035
3006-3-10-..	0,25 - 2,0	3	10	60	0.035

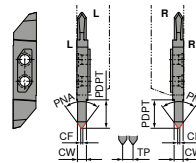

3006 L / 3006 R

3006 L / 3006 R

▲ For thread turning (partial profile)



ISO	F 3006 L 72 478 ...	F 3006 R 72 476 ...
3006-2-6-60	510	510
3006-3-10-60	512	512
P	●	●
M	●	●
K	○	○
N	○	○
S	●	●
H		
O	○	○

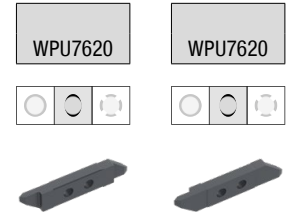

3

3006 VP L / 3006 VP R

Designation	TP mm	TD mm	CW mm	PDPT mm	b mm	PNA °
3006-0,15..	0.15	M0,6	0.16	0.275	8	60
3006-0,25..	0.25	M1 - M1,2	0.28	0.275	8	60
3006-0,35..	0.35	M1,6 - M1,8	0.36	0.275	8	60
3006-0,35..	0.35	M1,6 - M1,8	0.38	0.275	8	60
3006-0,4-..	0.40	M2	0.44	0.275	8	60
3006-0,45..	0.45	M2,2 - M2,5	0.50	0.275	8	60
3006-0,5-..	0.50	M3	0.70	1.400	8	60
3006-0,6-..	0.60	M3,5	0.80	1.400	8	60
3006-0,7-..	0.70	M4	0.90	1.800	8	60
3006-0,75..	0.75	M4,5	0.95	1.900	8	60
3006-0,8-..	0.80	M5	1.00	2.000	8	60
3006-1,0-..	1.00	M6 - M7	1.20	2.400	8	60
3006-1,25..	1.25	M8 - M9	1.45	2.900	8	60
3006-1,5-..	1.50	M10 - M11	1.74	3.400	8	60
3006-1,75..	1.75	M12	1.95	3.900	8	60
3006-2,0-..	2.00	M14 - M16	2.20	4.000	8	60

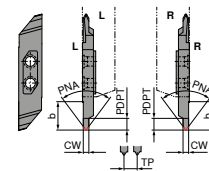

3006 L / 3006 R

3006 VP L / 3006 VP R

▲ For thread turning (full profile)

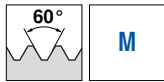

WPU7620	WPU7620
F	F
3006 VP L	3006 VP R
72 474 ...	72 472 ...

ISO	3006 VP L	3006 VP R
3006-0,15-10-60 VP	50800	50800
3006-0,25-10-60 VP	510	510
3006-0,35-10-60 VP	512	512
3006-0,4-10-60 VP	514	514
3006-0,45-10-60 VP	516	516
3006-0,5-10-60 VP	518	518
3006-0,6-10-60 VP	520	520
3006-0,7-10-60 VP	522	522
3006-0,75-10-60 VP	524	524
3006-0,8-10-60 VP	526	526
3006-1,0-10-60 VP	528	528
3006-1,25-10-60 VP	530	530
3006-1,5-10-60 VP	532	532
3006-1,75-10-60 VP	534	534
3006-2,0-10-60 VP		53600
P	●	●
M	●	●
K	○	○
N	○	○
S	●	●
H		
O	○	○

3006 VP L / 3006 VP R

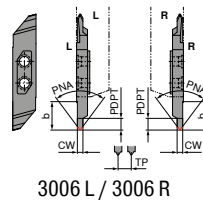

Designation	TP mm	CW mm	PDPT mm	b mm	PNA °
3006-13 U..	1.954	2.4	4.2	8	60
3006-14 U..	1.814	2.2	3.9	8	60
3006-16 U..	1.588	1.8	3.6	8	60
3006-18 U..	1.411	1.6	3.4	8	60
3006-20 U..	1.270	1.4	2.9	8	60
3006-24 U..	1.058	1.2	2.4	8	60
3006-28 U..	0.907	1.2	2.2	8	60
3006-32 U..	0.794	1.0	2.0	8	60
3006-36 U..	0.705	0.8	1.8	8	60
3006-40 U..	0.635	0.8	1.8	8	60
3006-44 U..	0.577	0.8	1.4	8	60
3006-48 U..	0.529	0.6	1.4	8	60

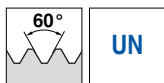

3006 VP L / 3006 VP R

▲ for thread turning (full profile UN)



NEW	NEW
WPU7620	WPU7620
<input type="checkbox"/> <input type="checkbox"/> <input type="checkbox"/>	<input type="checkbox"/> <input type="checkbox"/> <input type="checkbox"/>
	
F 3006 VP L	F 3006 VP R
72 531 ...	72 530 ...

ISO	3006 VP L	3006 VP R
3006-13 UN 10-60 VP	52400	52400
3006-14 UN 10-60 VP	52200	52200
3006-16 UN 10-60 VP	52000	52000
3006-18 UN 10-60 VP	51800	51800
3006-20 UN 10-60 VP	51600	51600
3006-24 UN 10-60 VP	51400	51400
3006-28 UN 10-60 VP	51200	51200
3006-32 UN 10-60 VP	51000	51000
3006-36 UN 10-60 VP	50800	50800
3006-40 UN 10-60 VP	50600	50600
3006-44 UN 10-60 VP	50400	50400
3006-48 UN 10-60 VP	50200	50200
P	●	●
M	●	●
K	○	○
N	○	○
S	●	●
H		
O	○	○

3

3006 L / 3006 R

Designation	TP mm	CW mm	PDPT mm	PNA °	CF mm
3006-2-6-...	0,25 - 2,0	2	6	55	0.035
3006-3-10-..	0,25 - 2,0	3	10	55	0.035

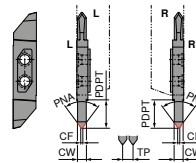

3006 L / 3006 R

3006 L / 3006 R

▲ For thread turning (partial profile)



WPU7620	WPU7620
F	F
3006 L	3006 R
72 527 ...	72 526 ...

ISO	72 527 ...	72 526 ...
3006-2-6-55	50000	50000
3006-3-10-55	50200	50200
P	●	●
M	●	●
K	○	○
N	○	○
S	●	●
H	○	○
O	○	○

3006 VP L / 3006 VP R

Designation	TP mm	TD mm	CW mm	PDPT mm	b mm	PNA °
3006-G11-..	2.309	1-11 - 6-11	2.54	5.0	8	55
3006-G14-..	1.814	1/2-14 - 7/8-14	2.00	4.5	8	55
3006-G19-..	1.337	1/4-19 - 3/8-19	1.48	3.3	8	55
3006-G28-..	0.907	1/8-28 - 1/16-28	1.00	2.3	8	55

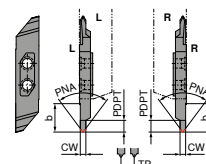

3006 L / 3006 R

3006 VP L / 3006 VP R

▲ For thread turning (full profile)

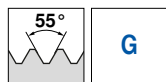

WPU7620	WPU7620
F	F
3006 VP L	3006 VP R
72 529 ...	72 528 ...

ISO	3006 VP L	3006 VP R
3006-G11-10-55 VP	51100	51100
3006-G14-10-55 VP	51400	51400
3006-G19-10-55 VP	51900	51900
3006-G28-10-55 VP	52800	52800
P	●	●
M	●	●
K	○	○
N	○	○
S	●	●
H		
O	○	○

3

3007 L / 3007 R

Designation	CW mm	b mm	PDPT mm	CRE mm	s mm	β°
3007-R0,25-2..	0.5	12	2.0	0.25	2	6
3007-R0,5-2,5..	1.0	12	2.5	0.50	2	6
3007-R0,6-2,5..	1.2	12	2.5	0.60	2	6
3007-R0,75-3..	1.5	12	3.0	0.75	2	6
3007-R0,8-3-1..	1.6	12	3.0	0.80	2	6
3007-R1,0-10	2.0	12	10.0	1.00	2	6
3007-R1,5-10	3.0	12	10.0	1.50	2	6
3007-R1,5-16	3.0	17	16.0	1.50	2	6

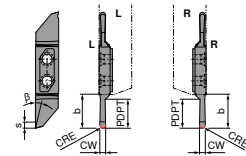

3007 L / 3008 R

3007 L / 3007 R

▲ for radius turning

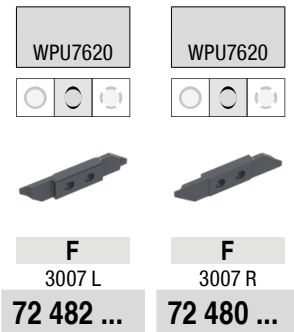

ISO	F 3007 L 72 482 ...	F 3007 R 72 480 ...
3007-R0,25-2-10	510	510
3007-R0,5-2,5-10	512	512
3007-R0,6-2,5-10	514	514
3007-R0,75-3-10	516	516
3007-R0,8-3-10	518	518
3007-R1,0-10	520	520
3007-R1,5-10	522	522
3007-R1,5-16	524	524
P	●	●
M	●	●
K	○	○
N	○	○
S	●	●
H		
O	○	○

3012 L / 3012 R / 3001 L / 3001 R

Designation	CW mm	PDPT mm	b mm	PNA °	CF mm
3012-2-6-...	2.0	2	10	60	0.035
3012-2-10-...	2.0	10	12	90	0.02
3001-3,5-...	3.5	11	-	-	-

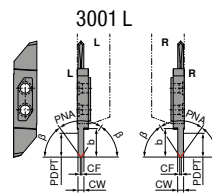
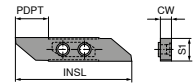
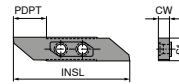

3001 R

3012 L / 3012 R

3012 L / 3012 R

▲ for chamfering

NEW	NEW
WPU7620	WPU7620
F	F
3012 L	3012 R
72 486 ...	72 484 ...

ISO	3012-2-6-60	3012-2-10-45
P	●	●
M	●	●
K	○	○
N	○	○
S	●	●
H	○	○
O	○	○

3

3012 L / 3012 R / 3001 L / 3001 R

Designation	CW mm	PDPT mm	S1 mm	INSL mm
3001-3,5-...	3.5	11	8	40.5
3001-3,6-...	3.6	17	8	51.5
3012-2-10..	2.0	10	8	40.0
3012-2-6-...	2.0	2	8	40.0

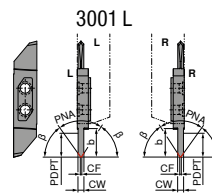



3001 R

3012 L / 3012 R

3001 L / 3001 R

▲ Blank

ISO
3001-3,5-10
3001-3,6-17

	NEW	NEW
	WUU7620	WUU7620
		
	3001 L 72 414 ...	3001 R 72 412 ...
	11000	11000
	13000	13000

VertiClamp – Standard tool holder

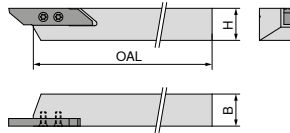

Illustrations show right-hand versions

ISO designation	H mm	B mm	OAL mm	Insert	Left-hand		Right-hand	
					72 302 ...	72 300 ...	72 302 ...	72 300 ...
3000-08x100 .	8	8	100	30..	008		008	
3000-10x100 .	10	10	100	30..	010		010	
3000-12x100 .	12	12	100	30..	012		012	
3000-16x125 .	16	16	125	30..	016		016	
3000-20x125 .	20	20	125	30..	020		020	
3000-25x150 .	25	25	150	30..	025		025	

Spare parts for Article no.

Article no.	Insert	80 950 ...	72 950 ...
72 300 016 / 72 302 016	T08	110	005
72 300 008 / 72 302 008	T08	110	004
72 300 010 / 72 302 010	T08	110	005
72 300 012 / 72 302 012	T08	110	005
72 300 020 / 72 302 020	T08	110	005
72 302 025	T08	110	005

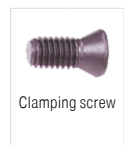
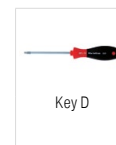

VertiClamp – Standard holder with thro' coolant

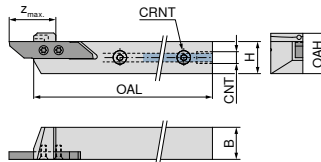

Illustrations show right-hand versions

ISO designation	H mm	B mm	OAL mm	OAH mm	z _{max} mm	CRNT	CNT	Insert	Left-hand		Right-hand	
									72 311 ...	72 310 ...	72 311 ...	72 310 ...
3000-08x100 .IC	8	12	100	12.2	26	M5	M5	30..	008		008	
3000-10x100 .IC	10	12	100	14.0	26	M5	M5	30..	010		010	
3000-12x100 .IC	12	12	100	16.0	26	M5	M5	30..	012		012	
3000-16x100 .IC	16	16	125	20.0	26	M5	G1/8"	30..	016		016	
3000-20x100 .IC	20	20	125	24.0	26	M5	G1/8"	30..	020		020	
3000-25x100 .IC	25	25	125	29.0	26	M5	G1/8"	30..	025		025	

Spare parts for Article no.

Article no.	Insert	72 950 ...	72 950 ...	80 950 ...	72 950 ...
72 310 008 / 72 311 008	M5x4	011	T08	110	004
72 310 010 / 72 311 010	M5x4	011	T08	110	005
72 310 012 / 72 311 012	M5x4	011	T08	110	005
72 310 016 / 72 311 016	G1/8"	010	T08	110	005
72 310 020 / 72 311 020	G1/8"	010	T08	110	005
72 310 025 / 72 311 025	G1/8"	010	T08	110	005

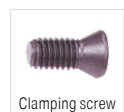

VertiClamp – Offset tool holder

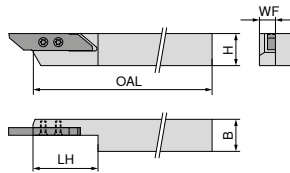

Illustrations show right-hand versions



ISO designation	H mm	B mm	OAL mm	LH mm	WF mm	Insert
3000-10x100 .A	10	10	100	37	8	30..
3000-12x100 .A	12	12	100	37	8	30..
3000-16x125 .A	16	16	125	37	8	30..

Left-hand	Right-hand
72 309 ...	72 308 ...
006	006
008	008
010	010

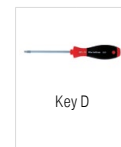

Key D

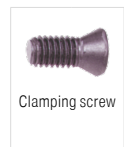

Clamping screw

Spare parts for Article no.

72 308 006 / 72 309 006	T08	110	004
72 308 008 / 72 309 008	T08	110	004
72 308 010 / 72 309 010	T08	110	004

80 950 ...

72 950 ...

VertiClamp – Offset holder with thro' coolant

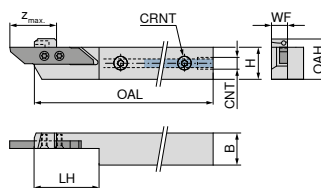

Illustrations show right-hand versions



ISO designation	H mm	B mm	OAL mm	WF mm	LH mm	OAH mm	Z _{max} mm	CNT	CRNT	Insert
3000-16x125 .A IC	16	16	125	8	37	20	27	G1/8"	M5	30..

NEW Left-hand	NEW Right-hand
72 315 ...	72 314 ...
016	016



Cylindrical screw



Cylindrical screw



Key D

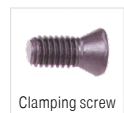

Clamping screw

Spare parts for Article no.

72 314 016 / 72 315 016	G1/8"	010	M5x4	011	T08	110	004
-------------------------	-------	-----	------	-----	-----	-----	-----

72 950 ...

72 950 ...

80 950 ...

72 950 ...

VertiClamp – Offset holder with offset insert seat

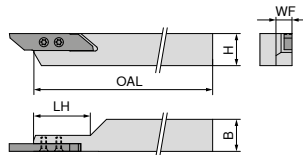

Illustrations show right-hand versions



ISO designation	H mm	B mm	OAL mm	LH mm	WF mm	Insert
3000-10x100 .AV	10	10	100	28	8	30..
3000-12x100 .AV	12	12	100	28	8	30..
3000-16x125 .AV	16	16	125	28	8	30..

NEW	NEW
Left-hand	Right-hand
72 317 ...	72 316 ...
010	010
012	
016	016

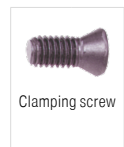
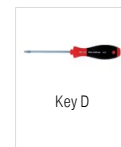

80 950 ...	72 950 ...

Spare parts
for Article no.

72 316 010 / 72 317 010	T08	110	004
72 317 012	T08	110	004
72 316 016 / 72 317 016	T08	110	004

VertiClamp – Offset holder with offset insert seat and thro' coolant

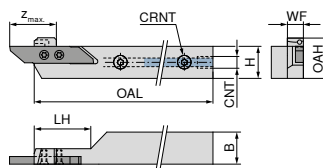

Illustrations show right-hand versions



ISO designation	H mm	B mm	OAL mm	OAH mm	z _{max} mm	CRNT	CNT	Insert
3000-16x125 .AV IC	16	16	125	20	27	M5	G1/8"	30..

NEW	NEW
Left-hand	Right-hand
72 313 ...	72 312 ...
016	016

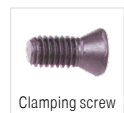

72 950 ...	72 950 ...	80 950 ...	72 950 ...

Spare parts
for Article no.

72 312 016 / 72 313 016	G1/8"	010	M5x4	011	T08	110	004
-------------------------	-------	-----	------	-----	-----	-----	-----

VertiClamp – Combi tool holder

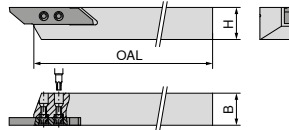

ISO designation	H mm	B mm	OAL mm	Insert	Left-hand		Right-hand	
					72 306 ...	72 304 ...		
3000-08x100 .C	8	8	100	30..	008		008	
3000-10x100 .C	10	10	100	30..	010		010	
3000-12x100 .C	12	12	100	30..	012		012	
3000-16x125 .C	16	16	125	30..	016		016	
3000-20x125 .C	20	20	125	30..	020		020	

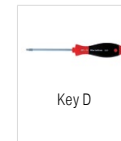

Spare parts for Article no.		80 950 ...	72 950 ...	72 950 ...
72 304 008 / 72 306 008	T08	110	003	008
72 304 010 / 72 306 010	T08	110	003	008
72 304 012 / 72 306 012	T08	110	003	008
72 304 016 / 72 306 016	T08	110	003	008
72 304 020 / 72 306 020	T08	110	003	008

Reducer fitting

- ▲ Max. 200 bar/2900 psi
- ▲ No sealing ring required

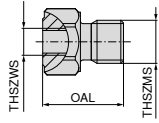

72 301 ...

Designation	THSZWS	THSZMS	OAL mm	
RV.100.M6-M5	M5	M6	18	002
RV.100.M8x1-M5	M5	M8x1	15	008
RV.100.M10x1-M5	M5	M10x1	15	007
RV.100.G1/8-M5	M5	G1/8"	15	006

Hose (connecting piece/connecting piece)

- ▲ Max. 200 bar/2900 psi

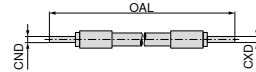

72 305 ...

Designation	CND mm	CXD mm	OAL mm	
HDKS.150.4-4	4	4	150	003
HDKS.200.4-4	4	4	200	014
HDKS.300.4-4	4	4	300	025
HDKS.500.4-4	4	4	500	037

Reducer fitting

- ▲ Max. 200 bar/2900 psi
- ▲ Includes sealing ring

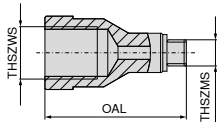

72 301 ...

Designation	THSZWS	THSZMS	OAL mm	
RV.100.M5-M6	M6	M5	15	001
RV.100.M5-M8x1	M8x1	M5	23	003
RV.100.M5-M10x1	M10x1	M5	27	005
RV.100.M5-G1/8	G1/8"	M5	27	004

Hose (connecting piece/thread)

- ▲ Max. 200 bar/2900 psi
- ▲ No sealing ring required

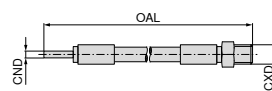

72 305 ...

Designation	THSZMS	CXD mm	OAL mm	
HDKS.150.M5-4	M5	4	150	010
HDKS.200.M5-4	M5	4	200	021
HDKS.300.M5-4	M5	4	300	033
HDKS.500.M5-4	M5	4	500	045



Sealing ring

72 950 ...

Spare parts for Article no.

72 301 001	009
72 301 003	009
72 301 005	009
72 301 004	009

Straight fitting

▲ Max. 200 bar/2900 psi

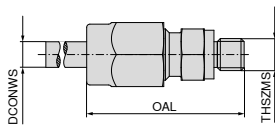

72 307 ...

Designation	DCONWS mm	THSZMS	OAL mm	
KA. M5-4	4	M5	27	009
KA. G1/8-4	4	G1/8"	32	003

Swivel fitting

▲ Max. 200 bar/2900 psi

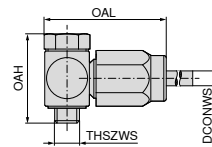

72 307 ...

Designation	DCONWS mm	OAH mm	THSZMS	OAL mm	
KA.SV.M5-4	4	21	M5	28	017
KA.SV.G1/8-4	4	30	G1/8"	37	012

Quick connection (coupling)

▲ Max. 200 bar/2900 psi

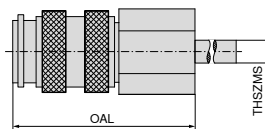

72 319 ...

Designation	THSZMS	OAL mm	
KIG.M5	M5	26	001

Quick connection (connector)

▲ Max. 200 bar/2900 psi
▲ No sealing ring required

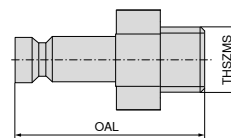

72 320 ...

Designation	THSZMS	OAL mm	
SAG.M5	M5	20	001

Material examples for cutting data tables

	Material sub-group	Index	Composition / Structure / Heat treatment	Tensile strength N/mm ² / HB / HRC	Material number	Material designation	Material number	Material designation
P	Unalloyed steel	P.1.1	< 0,15 % C Annealed	420 N/mm ² / 125 HB	1.0401	C15	1.1141	Ck15
		P.1.2	< 0,45 % C Annealed	640 N/mm ² / 190 HB	1.1191	C45E	1.0718	9SMnPb28
		P.1.3	< 0,45 % C Tempered	840 N/mm ² / 250 HB	1.1191	C45E	1.0535	C55
		P.1.4	< 0,75 % C Annealed	910 N/mm ² / 270 HB	1.1223	C60R	1.0535	C55
		P.1.5	< 0,75 % C Tempered	1010 N/mm ² / 300 HB	1.1223	C60R	1.0727	45S20
	Low-alloy steel	P.2.1	Annealed	610 N/mm ² / 180 HB	1.7131	16MnCr5	1.6587	17CrNiMo6
		P.2.2	Tempered	930 N/mm ² / 275 HB	1.7131	16MnCr5	1.6587	17CrNiMo6
		P.2.3	Tempered	1010 N/mm ² / 300 HB	1.7225	42CrMo4	1.3505	100Cr6
		P.2.4	Tempered	1200 N/mm ² / 375 HB	1.7225	42CrMo4	1.3505	100Cr6
	High-alloy steel and high-alloy tool steel	P.3.1	Annealed	680 N/mm ² / 200 HB	1.4021	X20Cr13	1.4034	X46Cr13
		P.3.2	Hardened and tempered	1100 N/mm ² / 300 HB	1.2343	X38CrMoV5-1	1.4034	X46Cr13
		P.3.3	Hardened and tempered	1300 N/mm ² / 400 HB	1.2343	X38CrMoV5-1	1.4034	X46Cr13
	Stainless steel	P.4.1	Ferritic / martensitic Annealed	680 N/mm ² / 200 HB	1.4016	X6Cr17	1.2316	X36CrMo16
		P.4.2	Martensitic Tempered	1010 N/mm ² / 300 HB	1.4112	X90CrMoV18	1.2316	X36CrMo16
M	Stainless steel	M.1.1	Austenitic / austenitic-ferritic Quenched	610 N/mm ² / 180 HB	1.4301	X5CrNi18-10	1.4571	X6CrNiMoTi17-12-2
		M.2.1	Austenitic Tempered	300 HB	1.4841	X15CrNiSi25-21	1.4539	X1NiCrMoCu25-20-5
		M.3.1	Austenitic / ferritic (Duplex)	780 N/mm ² / 230 HB	1.4462	X2CrNiMoN22-5-3	1.4501	X2CrNiMoCuWN25-7-4
K	Grey cast iron	K.1.1	Pearlitic / ferritic	350 N/mm ² / 180 HB	0.6010	GG-10	0.6025	GG-25
		K.1.2	Pearlitic (martensitic)	500 N/mm ² / 260 HB	0.6030	GG-30	0.6045	GG-45
	Spherulitic graphite cast iron	K.2.1	Ferritic	540 N/mm ² / 160 HB	0.7040	GGG-40	0.7060	GGG-60
		K.2.2	Pearlitic	845 N/mm ² / 250 HB	0.7070	GGG-70	0.7080	GGG-80
	Malleable iron	K.3.1	Ferritic	440 N/mm ² / 130 HB	0.8035	GTW-35-04	0.8045	GTW-45
		K.3.2	Pearlitic	780 N/mm ² / 230 HB	0.8165	GTS-65-02	0.8170	GTS-70-02
N	Aluminium wrought alloy	N.1.1	Non-hardenable	60 HB	3.0255	Al99,5	3.3315	AlMg1
		N.1.2	Hardenable Age-hardened	340 N/mm ² / 100 HB	3.1355	AlCuMg2	3.2315	AlMgSi1
	Cast aluminium alloy	N.2.1	≤ 12 % Si, non-hardenable	250 N/mm ² / 75 HB	3.2581	G-AlSi12	3.2163	G-AlSi9Cu3
		N.2.2	≤ 12 % Si, hardenable Age-hardened	300 N/mm ² / 90 HB	3.2134	G-AlSi5Cu1Mg	3.2373	G-AlSi9Mg
		N.2.3	> 12 % Si, non-hardenable	440 N/mm ² / 130 HB		G-AlSi17Cu4Mg		G-AlSi18CuNiMg
	Copper and copper alloys (bronze/brass)	N.3.1	Free-machining alloys, PB > 1 %	375 N/mm ² / 110 HB	2.0380	CuZn39Pb2 (Ms58)	2.0410	CuZn44Pb2
		N.3.2	CuZn, CuSnZn	300 N/mm ² / 90 HB	2.0331	CuZn15	2.4070	CuZn28Sn1As
		N.3.3	CuSn, lead-free copper and electrolytic copper	340 N/mm ² / 100 HB	2.0060	E-Cu57	2.0590	CuZn40Fe
	Magnesium alloys	N.4.1	Magnesium and magnesium alloys	70 HB	3.5612	MgAl6Zn	3.5312	MgAl3Zn
	S	Heat-resistant alloys	S.1.1	Fe – basis Annealed	680 N/mm ² / 200 HB	1.4864	X12NiCrSi 36-16	1.4865
S.1.2			Fe – basis Age-hardened	950 N/mm ² / 280 HB	1.4980	X6NiCrTiMoVB25-15-2	1.4876	X10NiCrAlTi32-20
S.2.1			Ni or Co basis Annealed	840 N/mm ² / 250 HB	2.4631	NiCr20TiAl (Nimonic80A)	3.4856	NiCr22Mo9Nb
S.2.2			Ni or Co basis Age-hardened	1180 N/mm ² / 350 HB	2.4668	NiCr19Nb5Mo3 (Inconel 718)	2.4955	NiFe25Cr20NbTi
S.2.3			Ni or Co basis Cast	1080 N/mm ² / 320 HB	2.4765	CoCr20W15Ni	1.3401	G-X120Mn12
Titanium alloys		S.3.1	Pure titanium	400 N/mm ²	3.7025	Ti99,8	3.7034	Ti99,7
		S.3.2	Alpha + beta alloys Age-hardened	1050 N/mm ² / 320 HB	3.7165	TiAl6V4	Ti-6246	Ti-6Al-2Sn-4Zr-6Mo
		S.3.3	Beta alloys	1400 N/mm ² / 410 HB	Ti555.3	Ti-5Al-5V-5Mo-3Cr	R56410	Ti-10V-2Fe-3Al
H	Hardened steel	H.1.1	Hardened and tempered	46–55 HRC				
		H.1.2	Hardened and tempered	56–60 HRC				
		H.1.3	Hardened and tempered	61–65 HRC				
		H.1.4	Hardened and tempered	66–70 HRC				
	Chilled iron	H.2.1	Cast	400 HB				
	Hardened cast iron	H.3.1	Hardened and tempered	55 HRC				
O	Non-metal materials	O.1.1	Plastics, duroplastic	≤ 150 N/mm ²				
		O.1.2	Plastics, thermoplastic	≤ 100 N/mm ²				
		O.2.1	Aramid fibre-reinforced	≤ 1000 N/mm ²				
		O.2.2	Glass/carbon-fibre reinforced	≤ 1000 N/mm ²				
		O.3.1	Graphite					

* Tensile strength

Cutting data standard values

Index	DRAGONSKIN								CWN2120	CTPX710 -M34	CTPX710 -25P/-25Q	CTPX715 -27	H210T	H10T/ H216T	CWN15	WUU7610	WPU7610	WPU7620
	TCM10	CTCP115	CTCP125	CTCP135	CTCM120	CTPM125	CTCM130	CTPP430										
P.1.1	309	370	295	210	229	203	184	215		325	340	275				85	110	115
P.1.2	266	315	250	175	200	171	152	190		286	300	236				50	65	70
P.1.3	227	270	210	145	173	142	123	165		250	260	200				50	65	70
P.1.4	213	250	200	135	164	132	113	160		238	250	188				50	65	70
P.1.5	193	230	180	120	150	118	98	150		220	235	170				50	65	70
P.2.1	273	325	260	180	204	176	157	200		292	300	242				50	65	70
P.2.2	210	250	195	130	161	130	110	160		235	250	185				50	65	70
P.2.3	193	230	180	120	150	118	98	140		220	235	170				50	65	70
P.2.4	144	170	130	85	116	81	61	110		175	190	125				50	65	70
P.3.1	219	200	170	150	159	142	124	140		140	150	138				50	65	70
P.3.2	167	140	105	95	116	97	81	100		85	95	81				50	65	70
P.3.3	114	85	40	35	73	51	38	70		30	35	24				50	65	70
P.4.1	219	200	170	155	159	142	124	140		140	155	138				50	65	70
P.4.2	193	170	135	125	138	119	103	120		113	130	109				50	65	70
M.1.1	219			155	159	142	124	140	130	140	150	138			100		55	65
M.2.1				95	116	97	81	100	85	85	90	81			55		40	45
M.3.1				135	146	128	111	130	115	124	130	120			85		55	65
K.1.1		255	170					140				200	170	140			110	115
K.1.2		235	160					130				160	130	115			110	115
K.2.1	260	270	180					140				190	180	150			110	115
K.2.2	215	205	160					140				150	130	110			110	115
K.3.1	300	250	200					100				210	190	170			110	115
K.3.2	205	210	160					100				180	160	140			110	115
N.1.1								300	1750	1840	1840	1750	1650	1400	1650	180	200	220
N.1.2								315	1500	1600	1600	1500	1350	1100	1400	180	200	220
N.2.1								270	1250	1250	1250	1200	1200	950	1250	180	200	220
N.2.2								140	1250	1250	1250	1200	1100	950	1200	180	200	220
N.2.3								180	700	750	750	700	600	500	750	180	200	220
N.3.1								200	650	650	650	625	525	425	600	180	200	220
N.3.2								200	600	630	630	600	500	400	570	180	200	220
N.3.3								200	480	500	500	475	375	275	460	180	200	220
N.4.1								200	330	340	340	325	275	225	280	180	200	220
S.1.1							35	65		100	110	40	43			40	45	45
S.1.2							26	50		80	85	30	33			40	45	45
S.2.1							20	45		63	75	30	33			35	40	40
S.2.2							20	40		40	45	24	25			35	40	40
S.2.3							18	40		38	43	20	20					
S.3.1							110	65		95	100	110	110					
S.3.2							63	50		55	60	70	70			35	45	45
S.3.3							45	40		40	45	50	50			35	45	45
H.1.1																		
H.1.2																		
H.1.3																		
H.1.4																		
H.2.1																		
H.3.1																		
O.1.1												140	160	130		180	200	220
O.1.2																180	200	220
O.2.1												150	140	105				
O.2.2																		
O.3.1																		

The cutting data is strongly influenced by external conditions, such as the stability of the tool and workpiece clamping, material and type of machine. The specified values represent guideline cutting data that can be adjusted by approx. ±20% according to the usage conditions.

Machinability of non-ferrous metals with carbide indexable inserts

	Material group	Material examples	Machinability of aluminium alloys		Comments	
				*		
N	Pure aluminium	non hardenable	Al 99,5	W7	5	<ul style="list-style-type: none"> ▲ Snarl chips ▲ Possibly bad surface ▲ Excessive built-up edge ▲ Long tool life ▲ Use coolant emulsion
			Al 99,5	F13	4	
			Al 99	W8	5	
			Al 99	F14	4	
	Aluminium wrought alloys	non hardenable	Al Mn	W10	5	<ul style="list-style-type: none"> ▲ Snarl, continuous or fragmented chip ▲ Large feed rates necessary for good swarf control ▲ Built-up edge ▲ Long tool life ▲ Emulsion coolant is advantageous
			Al Mn	F16	4	
			Al Mg 1	W10	5	
			Al Mg 1	F19	4	
			Al Mg 3	W18	4	
			Al Mg 3	F25	3	
			Al Mg 5	W25	4	
			AL Mg 5	F28	2	
			Al Mg 4,5 Mn	W27	4	
			Al Mg 4,5 Mn	G35	3	
		hardenable	Al Mg Si 0,5	W	4	<ul style="list-style-type: none"> ▲ Good swarf control with higher feed rates ▲ Very good swarf control ▲ No built up edge ▲ Very good surface quality ▲ Good swarf control ▲ Good surface quality ▲ Little built-up edge
			Al Mg Si 0,5	F13-25	3	
			Al Mg Si 1	W	4	
			Al Mg Si 1	F21-30	3	
			Al Mg Si Pb	F20-28	2	
			Al Cu Si Pb	F28-37	1	
			Al Cu Mg Pb	F34-37	1	
			Al Cu Mg 1	W	3	
			Al Cu Mg 1	F33-40	2	
			Al Cu Mg 2	W	3	
	Al Cu Mg 2	F40-47	2			
	Al Cu Si Mn	W	3			
	Al Cu Si Mn	F43-46	2			
	Al Zn Mg Cu 1,5	F50-52	2			
	Al Sn 6 Cu		1			
	Cast Aluminium Alloys	non hardenable	G-Al Si 12		3	<ul style="list-style-type: none"> ▲ Good swarf control ▲ Built-up edge ▲ Higher Si content results in lower tool life ▲ High wear of the carbide ▲ Good swarf control ▲ Good surface quality ▲ Long tool life
			G-Al Si 10 Mg		3	
			G-Al Si 5 Mg		2	
			G-Al Si 7 Mg (9 Mg)		2	
			G-Al Si Cu 3		2	
			G-Al Si 6 Cu 4		2	
			G-Al Mg 3 (Mg 5)		2	
G-Al Mg 9				2		
G-Al Mg 10				2		
G-Al Mg 3 Si (5 Si)				2		
G-Al Cu 4 Ti (Mg)				2		
G-Al Si 12 Cu Mg Ni				2		
Copper wrought alloys		Cu Ag				
		Cu As				
		Cu Cd				
		Cu Cd Sn				
		Cu Mg				
		Cu Mn				
	brass	Cu Zn Al				
		Cu Sn				
	bronze	Cu Sn Zn				
		Cu Ni				
		Cu Ni Fe				
		Cu Al				
0	Non metal materials	Duroplastics				
		Fibre-reinforced plastics				
		hard rubber				

* 1 = good machinability, 5 = bad machinability

3

Cutting data standard values for diamond cutting materials CTD PD20 / PS30 / PU20 / CD10 / MD05

Index	Material group		$a_p = 0,04-0,4 \text{ mm}$		$a_p = 0,4-1,0 \text{ mm}$		$a_p = 0,4-2,5 \text{ mm}$	
			Surface roughness R_z in μm		Surface roughness R_z in μm		Surface roughness R_z in μm	
			2,5-5,0	5,0-10	2,5-5,0	5,0-10	2,5-5,0	5,0-10
			CTD ...	CTD ...	CTD ...	CTD ...	CTD ...	CTD ...
N.1.1 N.1.2	Aluminium wrought alloys without Si $f=0,05-0,5 \text{ mm/rev.}$	Tool Material v_c in m/min	PD20 / PU20 / CD10 / MD05 400-2500	PD20 / PU20 / CD10 / MD05 400-2500	PD20 / PU20 / CD10 / MD05 400-2000	PD20 / PU20 / CD10 / MD05 400-2000	PD20 / PU20 / CD10 / MD05 400-1600	PD20 / PU20 / CD10 / MD05 400-1600
		Tool Material v_c in m/min		PD20 / CD10 400-2500		PD20 / CD10 400-2000		PD20 / CD10 400-1600
		Tool Material v_c in m/min	PD20 / PU20 400-2500	PD20 / PU20 400-2500	PD20 / PU20 400-2000	PD20 / PU20 400-2000	PD20 / PU20 400-1600	PD20 / PU20 400-1600
N.2.1	Cast Aluminium Alloys Si \leq 12% - hardened or Si=12-20% - non hardened $f=0,05-0,5 \text{ mm/rev.}$	Tool Material v_c in m/min	PS30 / PU20 / CD10 / MD05 600-2000	PS30 / PU20 / CD10 / MD05 600-2200	PS30 / PU20 / CD10 / MD05 600-1800	PS30 / PU20 / CD10 / MD05 600-2000	PS30 / PU20 / CD10 / MD05 600-1500	PS30 / PU20 / CD10 / MD05 600-1800
		Tool Material v_c in m/min	PD20 / PU20 / CD10 400-2000	PD20 / PU20 / CD10 400-2200	PD20 / PU20 / CD10 400-1800	PS30 / PU20 / CD10 600-2000	PS30 / PU20 / CD10 400-1500	PS30 / PU20 / CD10 400-1800
		Tool Material v_c in m/min	PS30 600-2000	PS30 600-2200	PS30 600-1800	PS30 600-2000	PS30 600-1500	
N.2.2 N.2.3	Aluminium cast alloys Si=12-20% $f=0,05-0,5 \text{ mm/rev.}$	Tool Material v_c in m/min	PU20 / CD10 / MD05 800-1200	PU20 / CD10 / MD05 400-1800	PU20 / CD10 / MD05 700-1000	PU20 / CD10 / MD05 400-1500	PU20 / CD10 / MD05 600-900	PU20 / CD10 / MD05 400-1200
		Tool Material v_c in m/min		PU20 / CD10 600-1800		PU20 / CD10 600-1500		PU20 / CD10 600-1200
		Tool Material v_c in m/min		PU20 600-1800		PU20 600-1500		
N.3.1 N.3.2 N.3.3	Copper and copper wrought alloys $f=0,05-0,5 \text{ mm/rev.}$	Tool Material v_c in m/min	PD20 / PU20 / CD10 / MD05 400-1800	PD20 / PU20 / CD10 / MD05 300-1600	PD20 / PU20 / CD10 / MD05 400-1600	PS30 / PU20 / CD10 / MD05 300-1600	PD20 / PU20 / CD10 / MD05 400-1400	PD20 / PU20 / CD10 / MD05 400-1500
		Tool Material v_c in m/min	PU20 / CD10 300-1500	PD20 / PU20 / CD10 300-1500	PD20 / PU20 / CD10 400-1600	PS30 / PU20 / CD10 300-1500	PD20 / PU20 / CD10 400-1500	PD20 / PU20 / CD10 300-1400
		Tool Material v_c in m/min		PD20 / PU20 300-1800		PS30 / PU20 300-1700	PD20 / PU20 300-1600	PS30 / PU20 200-1300
O.1.1 O.1.2	Plastic materials without reinforcement (acrylic glass) $f=0,05-0,7 \text{ mm/rev.}$	Tool Material v_c in m/min		PD20 / CD10 / MD05 400-1200		PD20 / CD10 / MD05 300-1000		PS30 / CD10 / MD05 200-1000
		Tool Material v_c in m/min		PD20 / CD10 300-1200		PD20 / CD10 200-1000		PS30 / CD10 200-900
		Tool Material v_c in m/min		PD20 / CD10 400-1200		PD20 / CD10 300-1000		PD20 / CD10 200-1000
O.2.1 O.2.2	Plastic materials with reinforcement (glass-fibre, carbon-fibre reinforced) $f=0,05-0,7 \text{ mm/rev.}$	Tool Material v_c in m/min	PS30 / PU20 / CD10 / MD05 500-1000		PS30 / PU20 / CD10 / MD05 400-900	PS30 / PU20 / CD10 / MD05 300-900	PS30 / PU20 / CD10 / MD05 300-800	PS30 / PU20 / CD10 / MD05 200-1200
		Tool Material v_c in m/min	PS30 / PU20 / CD10 400-900		PS30 / PU20 / CD10 300-800	PS30 / PU20 / CD10 200-900	PS30 / PU20 / CD10 200-800	PS30 / PU20 / CD10 200-1400
		Tool Material v_c in m/min	PU20 500-1000		PU20 400-800	PU20 300-1000	PU20 300-800	
O.3.1	Graphite	Tool Material v_c in m/min	PD20 / PS30 / PU20 / CD10 100-3000		PD20 / PS30 / PU20 / CD10 100-3000		PD20 / PS30 / PU20 / CD10 100-3000	

Smooth cut	Irregular cutting depth	Interrupted cut
------------	-------------------------	-----------------

Cutting data standard values for the CB chip breaker geometries

-CB1

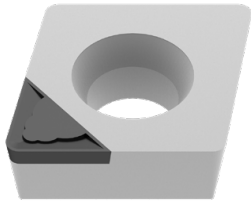

3D-Chip Breaker -CB1				
Corner Radius	a _p in mm		f _z in mm/rev.	
	min.	max.	min.	max.
0,1 mm	0,05	0,30	0,02	0,05
0,2 mm	0,06	0,40	0,03	0,08
0,4 mm	0,10	0,80	0,04	0,15
0,8 mm	0,15	1,00	0,08	0,20
1,2 mm	0,30	1,50	0,12	0,25

- ▲ Finish and Superfinish
- ▲ Extremely sharp cutting edge geometry
- ▲ Depth of Cut a_p: 0.05–1.5 mm
- ▲ Smallest cutting pressure for highest accuracies
- ▲ For machining of thin-walled and unstable workpieces

-CB2

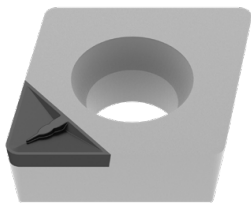

3D-Chip Breaker -CB2				
Corner Radius	a _p in mm		f _z in mm/rev.	
	min.	max.	min.	max.
0,2 mm	0,50	0,80	0,08	0,12
0,4 mm	0,60	1,50	0,08	0,20
0,8 mm	0,70	1,50	0,15	0,30
1,2 mm	0,80	2,00	0,20	0,40

- ▲ Semi-finish and Finish machining
- ▲ Negative edge preparation
- ▲ Cutting Depth a_p: 0,5–2,0 mm
- ▲ High surface quality and tight tolerances
- ▲ Machining of solid workpieces under stable conditions

-CB3

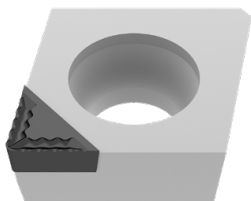

3D-Chip Breaker -CB3				
Corner Radius	a _p in mm		f _z in mm/rev.	
	min.	max.	min.	max.
0,4 mm	1,00	3,00	0,10	0,20
0,8 mm	1,00	3,00	0,15	0,35

- ▲ Medium and rough machining
- ▲ Highly aggressive chip breaker
- ▲ Cutting depth a_p: 1,0–3,0 mm
- ▲ Stable component conditions necessary
- ▲ Cooling must be ensured

Cutting data standard values – VertiClamp system

Index	Parting				Turning				
	WPU7620	Fine	Medium	Rough	WPU7620		Fine	Medium	Rough
	v_c in m/min	f	f	f	v_c in m/min	a_p in mm	f	f	f
P.1.1	80	0,005-0,080	0,02-0,15	0,10-0,25	80	< 3	0,005-0,080	0,02-0,15	0,10-0,25
P.1.2	75	0,005-0,080	0,02-0,15	0,10-0,25	75	< 3	0,005-0,080	0,02-0,15	0,10-0,25
P.1.3	75	0,005-0,080	0,02-0,15	0,10-0,25	75	< 3	0,005-0,080	0,02-0,15	0,10-0,25
P.1.4	75	0,005-0,080	0,02-0,15	0,10-0,25	75	< 3	0,005-0,080	0,02-0,15	0,10-0,25
P.1.5	75	0,005-0,080	0,02-0,15	0,10-0,25	75	< 3	0,005-0,080	0,02-0,15	0,10-0,25
P.2.1	75	0,005-0,080	0,02-0,15	0,10-0,25	75	< 3	0,005-0,080	0,02-0,15	0,10-0,25
P.2.2	75	0,005-0,080	0,02-0,15	0,10-0,25	75	< 3	0,005-0,080	0,02-0,15	0,10-0,25
P.2.3	75	0,005-0,080	0,02-0,15	0,10-0,25	75	< 3	0,005-0,080	0,02-0,15	0,10-0,25
P.2.4	75	0,005-0,080	0,02-0,15	0,10-0,25	75	< 3	0,005-0,080	0,02-0,15	0,10-0,25
P.3.1	75	0,005-0,080	0,02-0,15	0,10-0,25	75	< 3	0,005-0,080	0,02-0,15	0,10-0,25
P.3.2	75	0,005-0,080	0,02-0,15	0,10-0,25	75	< 3	0,005-0,080	0,02-0,15	0,10-0,25
P.3.3	75	0,005-0,080	0,02-0,15	0,10-0,25	75	< 3	0,005-0,080	0,02-0,15	0,10-0,25
P.4.1	75	0,005-0,080	0,01-0,12	0,10-0,20	75	< 2,5	0,005-0,080	0,01-0,12	0,10-0,20
P.4.2	75	0,005-0,080	0,01-0,12	0,10-0,20	75	< 2,5	0,005-0,080	0,01-0,12	0,10-0,20
M.1.1	55	0,005-0,080	0,01-0,12	0,10-0,20	55	< 2,5	0,005-0,080	0,01-0,12	0,10-0,20
M.2.1	55	0,005-0,080	0,01-0,12	0,10-0,20	55	< 2,5	0,005-0,080	0,01-0,12	0,10-0,20
M.3.1	55	0,005-0,080	0,01-0,12	0,10-0,20	55	< 2,5	0,005-0,080	0,01-0,12	0,10-0,20
K.1.1	70	0,005-0,080	0,01-0,12	0,10-0,20	70	< 2,5	0,005-0,080	0,01-0,12	0,10-0,20
K.1.2	70	0,005-0,080	0,01-0,12	0,10-0,20	70	< 2,5	0,005-0,080	0,01-0,12	0,10-0,20
K.2.1	70	0,005-0,080	0,01-0,12	0,10-0,20	70	< 2,5	0,005-0,080	0,01-0,12	0,10-0,20
K.2.2	70	0,005-0,080	0,01-0,12	0,10-0,20	70	< 2,5	0,005-0,080	0,01-0,12	0,10-0,20
K.3.1	70	0,005-0,080	0,01-0,12	0,10-0,20	70	< 2,5	0,005-0,080	0,01-0,12	0,10-0,20
K.3.2	70	0,005-0,080	0,01-0,12	0,10-0,20	70	< 2,5	0,005-0,080	0,01-0,12	0,10-0,20
N.1.1	180	0,050-0,200	0,02-0,25	0,10-0,30	180	< 3	0,050-0,200	0,02-0,25	0,10-0,30
N.1.2	180	0,050-0,200	0,02-0,25	0,10-0,30	180	< 3	0,050-0,200	0,02-0,25	0,10-0,30
N.2.1	180	0,050-0,200	0,02-0,25	0,10-0,30	180	< 3	0,050-0,200	0,02-0,25	0,10-0,30
N.2.2	180	0,050-0,200	0,02-0,25	0,10-0,30	180	< 3	0,050-0,200	0,02-0,25	0,10-0,30
N.2.3	180	0,050-0,200	0,02-0,25	0,10-0,30	180	< 3	0,050-0,200	0,02-0,25	0,10-0,30
N.3.1	180	0,050-0,200	0,02-0,25	0,10-0,40	180	< 3	0,050-0,200	0,02-0,25	0,10-0,30
N.3.2	180	0,050-0,200	0,02-0,25	0,10-0,30	180	< 3	0,050-0,200	0,02-0,25	0,10-0,30
N.3.3	180	0,050-0,200	0,02-0,25	0,10-0,30	180	< 3	0,050-0,200	0,02-0,25	0,10-0,30
N.4.1	180	0,050-0,200	0,02-0,25	0,10-0,30	180	< 3	0,050-0,200	0,02-0,25	0,10-0,30
S.1.1	45	0,005-0,060	0,02-0,08	0,10-0,25	45	< 2,5	0,005-0,060	0,02-0,08	0,10-0,25
S.1.2	45	0,005-0,060	0,02-0,08	0,10-0,25	45	< 2,5	0,005-0,060	0,02-0,08	0,10-0,25
S.2.1	40	0,005-0,060	0,02-0,08	0,10-0,25	40	< 2,5	0,005-0,060	0,02-0,08	0,10-0,25
S.2.2	40	0,005-0,060	0,02-0,08	0,10-0,25	40	< 2,5	0,005-0,060	0,02-0,08	0,10-0,25
S.2.3									
S.3.1									
S.3.2	45	0,005-0,060	0,02-0,08	0,10-0,25	45	< 2,5	0,005-0,060	0,02-0,08	0,10-0,25
S.3.3	45	0,005-0,060	0,02-0,08	0,10-0,25	45	< 2,5	0,005-0,060	0,02-0,08	0,10-0,25
H.1.1									
H.1.2									
H.1.3									
H.1.4									
H.2.1									
H.3.1									
O.1.1	220	0,050-0,200	0,02-0,25	0,10-0,30	220	< 3	0,050-0,200	0,02-0,25	0,10-0,30
O.1.2	220	0,050-0,200	0,02-0,25	0,10-0,30	220	< 3	0,050-0,200	0,02-0,25	0,10-0,30
O.2.1									
O.2.2									
O.3.1									

 The cutting data depends extremely on the external conditions, e.g. stability of the tool and tool clamping, material and machine type. The indicated values are possible cutting data which have to be increased or reduced according to the application conditions.

Cutting data standard values – VertiClamp and TriClamp system

Index	VertiClamp system				TriClamp system					
	Grooving				Turning					
	WPU7620	Fine	Medium	Rough	WUU7610	WPU7610	WPU7620	WUU7620		
v_c in m/min	f	f	f	v_c in m/min				f	$a_{p,max}$ in mm	
P.1.1	80	0,005–0,080	0,02–0,15	0,10–0,25	85	110	115	80	0,005–0,080	1,5
P.1.2	75	0,005–0,080	0,02–0,15	0,10–0,25	50	65	70	40	0,005–0,080	1,5
P.1.3	75	0,005–0,080	0,02–0,15	0,10–0,25	50	65	70	40	0,005–0,080	1,5
P.1.4	75	0,005–0,080	0,02–0,15	0,10–0,25	50	65	70	40	0,005–0,080	1,5
P.1.5	75	0,005–0,080	0,02–0,15	0,10–0,25	50	65	70	40	0,005–0,080	1,5
P.2.1	75	0,005–0,080	0,02–0,15	0,10–0,25	50	65	70	40	0,005–0,080	1,5
P.2.2	75	0,005–0,080	0,02–0,15	0,10–0,25	50	65	70	40	0,005–0,080	1,5
P.2.3	75	0,005–0,080	0,02–0,15	0,10–0,25	50	65	70	40	0,005–0,080	1,5
P.2.4	75	0,005–0,080	0,02–0,15	0,10–0,25	50	65	70	40	0,005–0,080	1,5
P.3.1	75	0,005–0,080	0,02–0,15	0,10–0,25	50	65	70	40	0,005–0,080	1,5
P.3.2	75	0,005–0,080	0,02–0,15	0,10–0,25	50	65	70	40	0,005–0,080	1,5
P.3.3	75	0,005–0,080	0,02–0,15	0,10–0,25	50	65	70	40	0,005–0,080	1,5
P.4.1	75	0,005–0,080	0,01–0,12	0,10–0,20	50	65	70	40	0,005–0,080	1,5
P.4.2	75	0,005–0,080	0,01–0,12	0,10–0,20	50	65	70	40	0,005–0,080	1,5
M.1.1	55	0,005–0,080	0,01–0,12	0,10–0,20		55	65		0,005–0,080	1,5
M.2.1	55	0,005–0,080	0,01–0,12	0,10–0,20		40	45		0,005–0,080	1,5
M.3.1	55	0,005–0,080	0,01–0,12	0,10–0,20		55	65		0,005–0,080	1,5
K.1.1	70	0,005–0,080	0,01–0,12	0,10–0,20		110	115		0,005–0,080	1,5
K.1.2	70	0,005–0,080	0,01–0,12	0,10–0,20		110	115		0,005–0,080	1,5
K.2.1	70	0,005–0,080	0,01–0,12	0,10–0,20		110	115		0,005–0,080	1,5
K.2.2	70	0,005–0,080	0,01–0,12	0,10–0,20		110	115		0,005–0,080	1,5
K.3.1	70	0,005–0,080	0,01–0,12	0,10–0,20		110	115		0,005–0,080	1,5
K.3.2	70	0,005–0,080	0,01–0,12	0,10–0,20		110	115		0,005–0,080	1,5
N.1.1	180	0,050–0,200	0,02–0,25	0,10–0,30	180	200	220	180	0,050–0,200	1,5
N.1.2	180	0,050–0,200	0,02–0,25	0,10–0,30	180	200	220	180	0,050–0,200	1,5
N.2.1	180	0,050–0,200	0,02–0,25	0,10–0,30	180	200	220	180	0,050–0,200	1,5
N.2.2	180	0,050–0,200	0,02–0,25	0,10–0,30	180	200	220	180	0,050–0,200	1,5
N.2.3	180	0,050–0,200	0,02–0,25	0,10–0,30	180	200	220	180	0,050–0,200	1,5
N.3.1	180	0,050–0,200	0,02–0,25	0,10–0,30	180	200	220	180	0,050–0,200	1,5
N.3.2	180	0,050–0,200	0,02–0,25	0,10–0,30	180	200	220	180	0,050–0,200	1,5
N.3.3	180	0,050–0,200	0,02–0,25	0,10–0,30	180	200	220	180	0,050–0,200	1,5
N.4.1	180	0,050–0,200	0,02–0,25	0,10–0,30	180	200	220	180	0,050–0,200	1,5
S.1.1	45	0,005–0,060	0,02–0,08	0,10–0,25	40	45	45	40	0,005–0,060	1,0
S.1.2	45	0,005–0,060	0,02–0,08	0,10–0,25	40	45	45	40	0,005–0,060	1,0
S.2.1	40	0,005–0,060	0,02–0,08	0,10–0,25	35	40	40	35	0,005–0,060	1,0
S.2.2	40	0,005–0,060	0,02–0,08	0,10–0,25	35	40	40	35	0,005–0,060	1,0
S.2.3										
S.3.1										
S.3.2	45	0,005–0,060	0,02–0,08	0,10–0,25	35	45	45	40	0,005–0,060	1,0
S.3.3	45	0,005–0,060	0,02–0,08	0,10–0,25	35	45	45	40	0,005–0,060	1,0
H.1.1										
H.1.2										
H.1.3										
H.1.4										
H.2.1										
H.3.1										
O.1.1	220	0,050–0,200	0,02–0,25	0,10–0,30	180	200	220	180	0,050–0,200	2,0
O.1.2	220	0,050–0,200	0,02–0,25	0,10–0,30	180	200	220	180	0,050–0,200	2,0
O.2.1										
O.2.2										
O.3.1										

 The cutting data depends extremely on the external conditions, e.g. stability of the tool and tool clamping, material and machine type. The indicated values are possible cutting data which have to be increased or reduced according to the application conditions.

Designation	-M70					
	f			a _p		
	min.	Recom- mended	max.	min.	Recom- mended	max.
	mm/rev.			mm		
CN.. 090304						
CN.. 090308						
CN.. 120404						
CN.. 120408	0,20	0,30	0,45	0,8	3,0	6,0
CN.. 120412	0,25	0,40	0,60	1,2	3,0	6,0
CN.. 120416	0,30	0,45	0,70	1,6	3,0	6,0
CN.. 160608	0,20	0,30	0,45	0,8	4,0	8,0
CN.. 160612	0,25	0,40	0,60	1,2	4,0	8,0
CN.. 160616	0,30	0,45	0,70	1,6	4,0	8,0
CN.. 160624	0,40	0,70	1,20	2,4	4,0	8,0
CN.. 190608	0,20	0,30	0,45	0,8	4,5	9,0
CN.. 190612	0,25	0,40	0,60	1,2	4,5	9,0
CN.. 190616	0,30	0,45	0,70	1,6	4,5	9,0
CN.. 190624	0,40	0,70	1,20	2,4	4,5	9,0
CN.. 250924	0,40	0,70	1,20	2,4	6,0	13,0
DN.. 110402						
DN.. 110404						
DN.. 110408	0,20	0,25	0,45	0,8	2,0	5,0
DN.. 110412	0,25	0,35	0,60	1,2	2,0	5,0
DN.. 150404						
DN.. 150408	0,20	0,25	0,45	0,8	2,5	6,0
DN.. 150412	0,25	0,35	0,60	1,2	2,5	6,0
DN.. 150416	0,30	0,40	0,70	1,6	2,5	6,0
DN.. 150604						
DN.. 150608	0,20	0,25	0,45	0,8	2,5	6,0
DN.. 150612	0,25	0,35	0,60	1,2	2,5	6,0
DN.. 150616	0,30	0,40	0,70	1,6	2,5	6,0
SN.. 090308						
SN.. 120404						
SN.. 120408	0,20	0,30	0,50	0,8	3,0	6,0
SN.. 120412	0,25	0,40	0,65	1,2	3,0	6,0
SN.. 120416	0,30	0,45	0,70	1,6	3,0	6,0
SN.. 150608						
SN.. 150612	0,25	0,40	0,65	1,2	4,0	8,0
SN.. 150616	0,30	0,45	0,75	1,6	4,0	8,0
SN.. 190612	0,25	0,40	0,65	1,2	4,5	9,0
SN.. 190616	0,30	0,45	0,75	1,6	4,5	9,0
SN.. 190624	0,40	0,70	1,20	2,4	4,5	9,0
SN.. 250724						
SN.. 250924	0,40	0,70	1,20	2,4	6,0	13,0
TN.. 110304						
TN.. 110308						
TN.. 160404						
TN.. 160408	0,20	0,25	0,45	0,8	2,5	6,0
TN.. 160412	0,25	0,35	0,60	1,2	2,5	6,0
TN.. 220404	0,15	0,20	0,30	0,4	3,0	7,0
TN.. 220408	0,20	0,25	0,45	0,8	3,0	7,0
TN.. 220412	0,25	0,35	0,60	1,2	3,0	7,0
TN.. 220416	0,30	0,40	0,70	1,6	3,0	7,0
VN.. 160404						
VN.. 160408						
VN.. 160412						
WN.. 060404						
WN.. 060408	0,20	0,30	0,45	0,8	2,0	4,0
WN.. 060412	0,25	0,40	0,60	1,2	2,0	4,0
WN.. 080404						
WN.. 080408	0,20	0,30	0,45	0,8	2,5	5,0
WN.. 080412	0,25	0,40	0,60	1,2	2,5	5,0
WN.. 080416	0,30	0,45	0,70	1,6	2,5	5,0



Cutting data standard values for negative inserts

Designation	-F30						-M30					
	f			a _p			f			a _p		
	min.	Recom- mended	max.	min.	Recom- mended	max.	min.	Recom- mended	max.	min.	Recom- mended	max.
mm/rev.			mm			mm/rev.			mm			
CN.. 090304												
CN.. 090308												
CN.. 120404	0,05	0,15	0,25	0,4	1,0	2,0						
CN.. 120408	0,10	0,22	0,35	0,8	1,5	2,5	0,15	0,25	0,40	1,0	2,0	4,5
CN.. 120412							0,20	0,30	0,50	1,2	2,5	5,0
CN.. 120416							0,25	0,35	0,55	1,6	2,5	5,0
CN.. 160608												
CN.. 160612												
CN.. 160616												
CN.. 160624												
CN.. 190608												
CN.. 190612												
CN.. 190616												
CN.. 190624												
CN.. 250924												
DN.. 110402												
DN.. 110404	0,05	0,15	0,25	0,4	1,0	2,0						
DN.. 110408	0,10	0,20	0,35	0,8	1,5	2,5	0,15	0,25	0,40	1,0	2,0	4,5
DN.. 110412							0,20	0,30	0,50	1,2	2,0	4,5
DN.. 150404												
DN.. 150408												
DN.. 150412												
DN.. 150416												
DN.. 150604	0,05	0,15	0,25	0,4	1,0	2,0						
DN.. 150608	0,10	0,20	0,35	0,8	1,5	2,5	0,15	0,25	0,40	1,0	2,0	5,5
DN.. 150612							0,20	0,30	0,50	1,2	2,0	5,5
DN.. 150616												
SN.. 090308												
SN.. 120404	0,10	0,15	0,30	0,4	1,0	2,0						
SN.. 120408	0,15	0,20	0,40	0,8	1,5	2,5	0,20	0,25	0,45	1,0	2,0	4,5
SN.. 120412	0,15	0,20	0,40	1,2	1,8	2,5	0,25	0,30	0,50	1,2	2,0	5,0
SN.. 120416												
SN.. 150608												
SN.. 150612												
SN.. 150616												
SN.. 190612												
SN.. 190616												
SN.. 190624												
SN.. 250724												
SN.. 250924												
TN.. 110304												
TN.. 110308												
TN.. 160404	0,05	0,15	0,25	0,4	1,0	2,0						
TN.. 160408	0,10	0,15	0,35	0,8	1,5	2,5	0,15	0,25	0,40	1,0	2,0	4,5
TN.. 160412							0,20	0,30	0,50	1,2	2,0	4,5
TN.. 220404												
TN.. 220408												
TN.. 220412												
TN.. 220416												
VN.. 160404	0,08	0,10	0,20	0,4	1,0	2,0						
VN.. 160408	0,10	0,15	0,30	0,8	1,5	2,5	0,15	0,25	0,40	1,0	1,5	4,0
VN.. 160412												
WN.. 060404	0,05	0,15	0,25	0,4	1,0	2,0						
WN.. 060408	0,10	0,20	0,30	0,8	1,5	2,5	0,15	0,25	0,40	1,0	1,5	3,5
WN.. 060412							0,20	0,30	0,45	1,2	1,5	4,0
WN.. 080404	0,05	0,15	0,25	0,4	1,0	2,0						
WN.. 080408	0,10	0,20	0,35	0,8	1,5	2,5	0,15	0,25	0,40	1,0	2,0	4,5
WN.. 080412							0,20	0,30	0,50	1,2	2,0	5,0
WN.. 080416												

Sharp ← → stable



The data shows reference values. An adjustment to the actual conditions may be required.

Designation	-M60						-M34					
	f			a _p			f			a _p		
	min.	Recom- mended	max.	min.	Recom- mended	max.	min.	Recom- mended	max.	min.	Recom- mended	max.
mm/rev.			mm			mm/rev.			mm			
CN.. 090304												
CN.. 090308												
CN.. 120404							0,08	0,12	0,18	1,0	1,5	3,0
CN.. 120408	0,25	0,30	0,50	1,5	2,5	6,0	0,10	0,15	0,35	1,0	1,8	3,5
CN.. 120412	0,30	0,35	0,55	2,0	3,0	6,0	0,13	0,20	0,40	1,5	2,0	4,0
CN.. 120416	0,30	0,40	0,60	2,0	3,0	6,0	0,15	0,25	0,45	2,0	3,0	4,5
CN.. 160608												
CN.. 160612	0,30	0,35	0,55	2,0	3,0	8,0						
CN.. 160616												
CN.. 160624												
CN.. 190608												
CN.. 190612												
CN.. 190616												
CN.. 190624												
CN.. 250924												
DN.. 110402												
DN.. 110404												
DN.. 110408												
DN.. 110412												
DN.. 150404							0,08	0,12	0,18	0,8	1,2	2,5
DN.. 150408							0,10	0,15	0,30	1,0	1,8	3,5
DN.. 150412							0,13	0,20	0,38	1,5	2,0	4,0
DN.. 150416												
DN.. 150604												
DN.. 150608	0,25	0,30	0,45	1,5	2,5	6,0	0,10	0,15	0,30	1,0	1,8	3,5
DN.. 150612	0,30	0,40	0,55	1,5	2,5	6,0	0,13	0,20	0,38	1,5	2,0	4,0
DN.. 150616												
SN.. 090308												
SN.. 120404												
SN.. 120408	0,30	0,35	0,50	1,5	2,0	6,0	0,15	0,25	0,40	1,0	2,0	4,0
SN.. 120412	0,30	0,40	0,55	2,0	2,5	6,0	0,15	0,25	0,45	1,5	2,5	4,5
SN.. 120416	0,30	0,40	0,60	2,0	2,5	6,0						
SN.. 150608												
SN.. 150612												
SN.. 150616												
SN.. 190612												
SN.. 190616												
SN.. 190624												
SN.. 250724												
SN.. 250924												
TN.. 110304												
TN.. 110308												
TN.. 160404												
TN.. 160408	0,25	0,25	0,45	1,5	2,5	5,0	0,10	0,15	0,35	1,0	2,0	4,0
TN.. 160412	0,30	0,30	0,55	2,0	2,5	5,5						
TN.. 220404							0,10	0,15	0,35	1,0	2,0	4,0
TN.. 220408							0,13	0,20	0,40	1,5	2,5	4,0
TN.. 220412												
TN.. 220416							0,15	0,25	0,45	2,0	2,5	4,5
VN.. 160404							0,07	0,10	0,18	0,8	1,2	2,0
VN.. 160408							0,10	0,15	0,20	1,0	1,5	2,5
VN.. 160412							0,13	0,18	0,25	1,5	1,8	3,0
WN.. 060404												
WN.. 060408	0,25	0,30	0,45	1,5	2,0	4,0						
WN.. 060412	0,30	0,35	0,50	2,0	2,5	4,5						
WN.. 080404												
WN.. 080408	0,25	0,30	0,50	1,5	2,0	5,0	0,10	0,15	0,35	1,0	2,0	4,0
WN.. 080412	0,30	0,35	0,55	2,0	2,5	5,5	0,13	0,20	0,40	1,5	2,0	4,0
WN.. 080416												

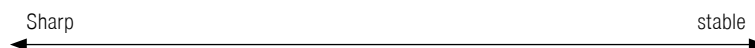

Cutting data values for positive inserts

Designation	-SF						-SMF					
	f			a _p			f			a _p		
	min.	Recommended	max.	min.	Recommended	max.	min.	Recommended	max.	min.	Recommended	max.
mm/rev.			mm			mm/rev.			mm			
CC..060200	0,02	0,035	0,05	0,1	0,4	1,5						
CC..060201	0,02	0,035	0,05	0,2	0,4	1,5						
CC..060202	0,03	0,1	0,15	0,2	0,4	1,5						
CC..060204	0,05	0,1	0,2	0,2	0,6	1,5	0,07	0,15	0,25	0,3	0,7	2
CC..060208	0,05	0,125	0,2	0,2	1	1,5	0,1	0,17	0,27	0,6	1	2
CC..09T300	0,02	0,035	0,05	0,2	0,75	2						
CC..09T301	0,02	0,035	0,05	0,2	0,75	2						
CC..09T302	0,05	0,075	0,1	0,2	0,75	2						
CC..09T304	0,05	0,12	0,2	0,2	0,75	2	0,07	0,15	0,25	0,3	0,8	2,5
CC..09T308	0,05	0,125	0,25	0,4	1	2	0,1	0,17	0,27	0,6	1	2,5
CC..09T312												
CC..120402	0,05	0,075	0,1	0,2	0,8	2,5						
CC..120404	0,05	0,12	0,2	0,2	1	2,5	0,07	0,15	0,25	0,3	1	3
CC..120408	0,08	0,15	0,25	0,4	1	2,5	0,1	0,17	0,27	0,6	1,2	3
CC..120412	0,08	0,15	0,25	0,4	1,5	2,5						
DC..0702005												
DC..070201												
DC..0702015												
DC..070202	0,03	0,1	0,15	0,1	0,4	1,5						
DC..070204	0,05	0,12	0,2	0,2	0,6	1,5	0,07	0,15	0,25	0,3	0,7	2
DC..070208							0,1	0,17	0,27	0,6	1	2
DC..11T3005												
DC..11T301												
DC..11T3015												
DC..11T302												
DC..11T304	0,05	0,12	0,2	0,2	0,7	2	0,07	0,15	0,25	0,3	0,8	2,5
DC..11T308	0,08	0,15	0,25	0,4	1	2	0,1	0,17	0,27	0,6	1,2	2,5
DC..11T312												
RC..0602M0												
RC..0803M0												
RC..1003M0												
RC..1204M0												
RC..1606M0							0,15	0,3	0,6	0,25	2	3,5
RC..2006M0												
RC..2507M0												
SC..09T304	0,05	0,12	0,2	0,2	0,7	2	0,07	0,15	0,25	0,3	0,8	2,5
SC..09T308	0,08	0,15	0,25	0,4	1	2	0,1	0,17	0,27	0,6	1	2,5
SC..120408	0,08	0,15	0,25	0,4	1	2,5	0,1	0,17	0,27	0,6	1,2	3
SC..120412												
TC..090204												
TC..110202												
TC..110204	0,05	0,12	0,2	0,2	0,7	2						
TC..110208	0,08	0,15	0,25	0,4	1	2	0,1	0,17	0,27	0,6	1	2,5
TC..16T302												
TC..16T304	0,05	0,12	0,2	0,2	0,8	2,5	0,07	0,15	0,25	0,3	1	3
TC..16T308	0,08	0,15	0,25	0,4	1	2,5	0,1	0,17	0,27	0,6	1,2	3
TC..16T312												
TC..220408												
VC..1103005												
VC..110301												
VC..1103015												
VC..110302	0,02	0,08	0,15	0,1	0,4	1,5	0,05	0,1	0,18	0,2	0,5	2
VC..110304	0,05	0,1	0,2	0,2	0,6	1,5	0,07	0,15	0,23	0,3	0,7	2
VC..110308	0,08	0,12	0,22	0,4	1	1,5						
VC..160402												
VC..160404	0,05	0,1	0,2	0,2	0,7	2	0,07	0,15	0,23	0,3	0,8	2,5
VC..160408	0,08	0,12	0,22	0,4	1	2	0,1	0,17	0,27	0,6	1	2,5
VC..160412												
VC..220530												
WC..020102	0,02	0,075	0,1	0,1	0,4	1						
WC..020104	0,02	0,1	0,2	0,1	0,6	1,5						

Sharp ← → stable

 The data shows reference values. An adjustment to the actual conditions may be required.

Designation	-SM						-SMQ					
	f			a _p			f			a _p		
	min.	Recom- mended	max.	min.	Recom- mended	max.	min.	Recom- mended	max.	min.	Recom- mended	max.
	mm/rev.			mm			mm/rev.			mm		
CC.. 060200												
CC.. 060201												
CC.. 060202	0,04	0,12	0,2	0,2	0,6	2,5						
CC.. 060204	0,08	0,17	0,3	0,4	0,8	2,5						
CC.. 060208	0,12	0,2	0,35	0,8	1	2,5						
CC.. 09T300												
CC.. 09T301												
CC.. 09T302												
CC.. 09T304	0,08	0,17	0,3	0,4	1	3	0,10	0,25	0,4	0,4	2	4
CC.. 09T308	0,12	0,2	0,35	0,8	1,2	3	0,15	0,30	0,5	0,8	2	4
CC.. 09T312	0,15	0,22	0,4	1,2	1,5	3						
CC.. 120402												
CC.. 120404	0,08	0,17	0,3	0,4	1,2	3,5	0,10	0,25	0,4	0,4	2	4
CC.. 120408	0,12	0,2	0,35	0,8	1,5	3,5	0,15	0,30	0,5	0,8	2	4
CC.. 120412	0,15	0,22	0,4	1,2	2	3,5						
DC.. 0702005												
DC.. 070201												
DC.. 0702015												
DC.. 070202	0,04	0,12	0,2	0,2	0,6	2,5						
DC.. 070204	0,08	0,17	0,3	0,4	0,8	2,5	0,10	0,18	0,25	0,4	1,5	3
DC.. 070208	0,12	0,2	0,3	0,8	1	2,5						
DC.. 11T3005												
DC.. 11T301												
DC.. 11T3015												
DC.. 11T302												
DC.. 11T304	0,8	0,17	0,3	0,4	1	3	0,10	0,25	0,4	0,4	2	4
DC.. 11T308	0,12	0,2	0,35	0,8	1,2	3	0,15	0,30	0,5	0,8	2	4
DC.. 11T312	0,15	0,22	0,4	1,2	1,7	3						
RC.. 0602M0	0,2	0,3	0,5	0,2	0,5	1,5						
RC.. 0803M0	0,2	0,3	0,6	0,2	0,6	2						
RC.. 1003M0	0,25	0,4	0,7	0,2	0,7	2,5						
RC.. 1204M0	0,3	0,5	0,8	0,2	0,8	3						
RC.. 1606M0	0,4	0,6	1	0,3	1	3,5						
RC.. 2006M0	0,5	0,8	1,2	0,4	1,2	4						
RC.. 2507M0	0,6	0,9	1,4	0,6	2	5						
SC.. 09T304	0,08	0,17	0,3	0,4	1	3						
SC.. 09T308	0,12	0,2	0,35	0,8	1,2	3						
SC.. 120408	0,12	0,2	0,35	0,8	1,5	3,5						
SC.. 120412	0,15	0,22	0,4	1,2	2	3,5						
TC.. 090204	0,08	0,12	0,2	0,4	0,8	2						
TC.. 110202	0,08	0,1	0,2	0,4	0,6	3						
TC.. 110204	0,12	0,2	0,35	0,8	1,2	3						
TC.. 110208	0,12	0,2	0,35	0,8	1,2	3						
TC.. 16T302												
TC.. 16T304	0,08	0,17	0,3	0,4	1,2	3,5						
TC.. 16T308	0,12	0,2	0,35	0,8	1,5	3,5						
TC.. 16T312	0,15	0,22	0,4	1,2	1,7	3,5						
TC.. 220408	0,12	0,2	0,35	0,8	2,5	6						
VC.. 1103005												
VC.. 110301												
VC.. 1103015												
VC.. 110302												
VC.. 110304												
VC.. 110308												
VC.. 160402												
VC.. 160404	0,08	0,17	0,25	0,4	1	3						
VC.. 160408	0,12	0,2	0,3	0,8	1,2	3						
VC.. 160412	0,15	0,22	0,32	1,2	1,5	3						
VC.. 220530												
WC.. 020102												
WC.. 020104												

Sharp stable

 Information on the cutting data of chip breakers not included in this overview, can be found on → Page 149–152

Cutting data values for positive inserts

Designation	-M25						-M55					
	f			a _p			f			a _p		
	min.	Recom- mended	max.	min.	Recom- mended	max.	min.	Recom- mended	max.	min.	Recom- mended	max.
mm/rev.			mm			mm/rev.			mm			
CC.. 060200												
CC.. 060201												
CC.. 060202												
CC.. 060204	0,06	0,13	0,20	0,2	1,1	2,0	0,06	0,13	0,20	0,4	1,5	2,6
CC.. 060208												
CC.. 09T300												
CC.. 09T301												
CC.. 09T302												
CC.. 09T304	0,06	0,14	0,22	0,2	1,2	2,2	0,08	0,16	0,24	0,4	1,7	3,0
CC.. 09T308	0,10	0,20	0,30	0,4	1,8	3,2	0,12	0,24	0,35	0,8	2,4	4,0
CC.. 09T312												
CC.. 120402												
CC.. 120404							0,08	0,18	0,28	0,4	2,2	4,0
CC.. 120408							0,12	0,26	0,40	0,8	2,8	4,8
CC.. 120412												
DC.. 0702005												
DC.. 070201												
DC.. 0702015												
DC.. 070202	0,04	0,09	0,13	0,1	0,9	1,6						
DC.. 070204	0,06	0,12	0,18	0,2	1,1	2,0	0,06	0,14	0,22	0,4	1,3	2,2
DC.. 070208							0,08	0,16	0,24	0,8	1,6	2,4
DC.. 11T3005												
DC.. 11T301												
DC.. 11T3015												
DC.. 11T302	0,04	0,10	0,16	0,1	1,1	2,0						
DC.. 11T304	0,06	0,14	0,22	0,2	1,2	2,2	0,08	0,16	0,24	0,4	1,7	3,0
DC.. 11T308	0,10	0,20	0,30	0,4	1,8	3,2	0,12	0,24	0,35	0,8	2,4	4,0
DC.. 11T312												
RC.. 0602M0												
RC.. 0803M0												
RC.. 1003M0												
RC.. 1204M0												
RC.. 1606M0												
RC.. 2006M0												
RC.. 2507M0												
SC.. 09T304							0,12	0,24	0,35	0,8	2,4	4,0
SC.. 09T308							0,12	0,26	0,40	0,8	2,8	4,8
SC.. 120408												
SC.. 120412												
TC.. 090204							0,06	0,12	0,18	0,4	1,3	2,2
TC.. 110202												
TC.. 110204	0,06	0,13	0,20	0,2	1,2	2,2	0,06	0,14	0,22	0,4	1,4	2,4
TC.. 110208												
TC.. 16T302												
TC.. 16T304	0,06	0,14	0,22	0,2	1,6	3,0						
TC.. 16T308	0,10	0,20	0,30	0,4	1,9	3,4	0,12	0,24	0,35	0,8	2,6	4,4
TC.. 16T312												
TC.. 220408												
VC.. 1103005												
VC.. 110301												
VC.. 1103015												
VC.. 110302												
VC.. 110304												
VC.. 110308												
VC.. 160402												
VC.. 160404	0,06	0,13	0,20	0,2	1,2	2,2	0,08	0,14	0,20	0,4	1,7	3,0
VC.. 160408	0,10	0,15	0,25	0,4	1,4	3,0	0,12	0,21	0,30	0,8	2,1	3,4
VC.. 160412												
VC.. 220530												
WC.. 020102												
WC.. 020104												

Sharp ← → stable

 The data shows reference values. An adjustment to the actual conditions may be required.

Designation	-F05					
	f			a _p		
	min.	Recom- mended	max.	min.	Recom- mended	max.
	mm/rev.			mm		
CC.. 060200						
CC.. 060201						
CC.. 060202						
CC.. 060204						
CC.. 060208						
CC.. 09T300						
CC.. 09T301						
CC.. 09T302						
CC.. 09T304						
CC.. 09T308						
CC.. 09T312						
CC.. 120402						
CC.. 120404						
CC.. 120408						
CC.. 120412						
DC.. 0702005	0,02	0,025	0,04	0,1	1	2
DC.. 070201	0,02	0,03	0,05	0,1	1	2
DC.. 0702015	0,02	0,04	0,075	0,1	1	2
DC.. 070202	0,02	0,05	0,1	0,1	1	2
DC.. 070204						
DC.. 070208						
DC.. 11T3005	0,02	0,025	0,04	0,1	1,25	2,5
DC.. 11T301	0,02	0,03	0,05	0,1	1,25	2,5
DC.. 11T3015	0,02	0,04	0,075	0,1	1,25	2,5
DC.. 11T302	0,02	0,075	0,1	0,1	1,25	2,5
DC.. 11T304	0,02	0,1	0,25	0,1	1,25	2,5
DC.. 11T308						
DC.. 11T312						
RC.. 0602M0						
RC.. 0803M0						
RC.. 1003M0						
RC.. 1204M0						
RC.. 1606M0						
RC.. 2006M0						
RC.. 2507M0						
SC.. 09T304						
SC.. 09T308						
SC.. 120408						
SC.. 120412						
TC.. 090204						
TC.. 110202						
TC.. 110204						
TC.. 110208						
TC.. 16T302						
TC.. 16T304						
TC.. 16T308						
TC.. 16T312						
TC.. 220408						
VC.. 1103005	0,02	0,025	0,04	0,1	1,25	2,5
VC.. 110301	0,02	0,03	0,05	0,1	1,25	2,5
VC.. 1103015	0,02	0,04	0,075	0,1	1,25	2,5
VC.. 110302	0,02	0,075	0,1	0,1	1,25	2,5
VC.. 110304	0,02	0,15	0,25	0,1	1,25	2,5
VC.. 110308						
VC.. 160402						
VC.. 160404						
VC.. 160408						
VC.. 160412						
VC.. 220530						
WC.. 020102						
WC.. 020104						

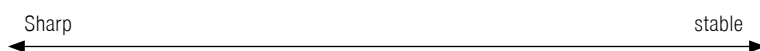

Diamond as a cutting material



Ensures

- ▲ Optimal surface quality
- ▲ burr-free workpieces
- ▲ high service lives
- ▲ lowest cutting forces
- ▲ High Process Security

Complete programme of roughing, finishing and wiper inserts for machining aluminium, non ferrous metals, plastics, ...

The cutting materials

	CTD CD10 (CVD)	CTD PD20 (PKD)	CTD PU20 (PKD)	CTD PS30 (PKD)
	Fine grain Size (N10)	Fine grain grade (N20)	Coarse grain grade (N20)	Coarse grain Size (N30)
Properties	<ul style="list-style-type: none"> ▲ perfect sharp edges ▲ no cutting pressure ▲ very close tolerances ▲ highest abrasion resistance with highest toughness ▲ very high heat conductivity 	<ul style="list-style-type: none"> ▲ high sharpness ▲ lower cutting pressure than PDC-S ▲ close tolerance ▲ lower abrasion resistance with increased toughness 	<ul style="list-style-type: none"> ▲ Very sharp cutting edge ▲ Reduced cutting pressure ▲ Tight tolerances ▲ Very high level of wear resistance and toughness 	<ul style="list-style-type: none"> ▲ high sharpness ▲ lower cutting pressure ▲ close tolerance ▲ lower abrasion resistance than with the PDC, with increased toughness
Material	suitable for superfinishing and semi-finishing of all non ferrous metals and NE-composite materials with small to high levels of abrasiveness	suitable for fine machining of all NE-materials with low abrasiveness	suitable for finishing to roughing non-ferrous metals and non-ferrous materials with highly abrasive alloying element. High chip removal on fibre-reinforced plastics such as CFRP and GFRP.	suitable for fine machining of all NE-materials and non-ferrous metals with low to very high levels of abrasiveness

Cutting Geometries

Neutral rake angle:

- ▲ higher cutting force
- ▲ higher temperature
- ▲ improved surface quality
- ▲ for stable workpieces

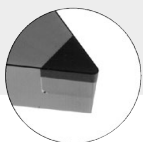

Positive rake angle:

- ▲ Lower cutting force
- ▲ Lower temperature
- ▲ reduction in surface quality
- ▲ for unstable workpieces
- ▲ improved accuracy

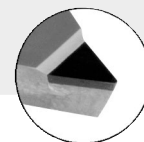

CB chip breaker geometries:

- ▲ Reliable chip control
- ▲ Ideal for low-alloy aluminium
- ▲ For F | M | R applications

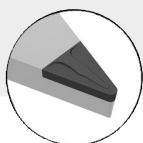

Notes on diamond usage



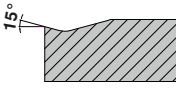
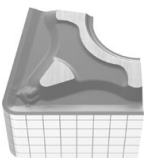
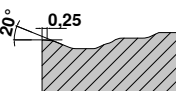
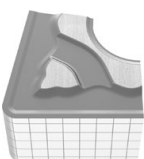
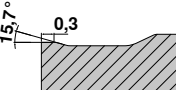

- ▲ Coolant is not generally needed, however it facilitates chip removal
- ▲ Note the chemical reaction to carbide-forming elements (PCD)
- ▲ Note the thermal interaction and critical temperature:
 PCD: 600 °C, CVD: 700 °C
 Depending on the material, use cooling.





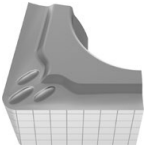
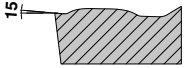
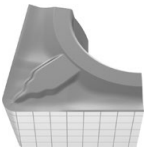
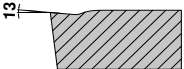

Standard chip breakers / application notes

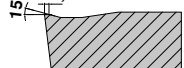
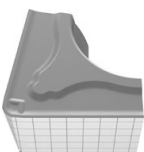
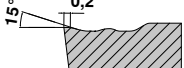
Negative	Model	Smooth cut	Irregular cutting depth	Interrupted cut	Sectional illustration		Geometry	
					a_p mm	f mm		
Main application steel and cast iron, secondary application stainless steels -F50 ▲ Fine turning chip breaker for fine machining ▲ Steel and stainless steels ▲ Excellent chip control ▲ High surface quality	 F	CTCP115 / CTCP125	CTCP115 / CTCP125 / CTCP135	CTCP135	 15°	0,10–2,60	0,06–0,35	CN.. DN.. SN.. TN.. VN.. WN..
		CTCP115	CTCP125	CTCP135				
		CTCP115 / CTCP125 / CTCK110 / CTCK120	CTCP115 / CTCP125 / CTCK110 / CTCK120	CTCP125 / CTCK120				
-M50 ▲ Medium machining ▲ First choice for steel machining ▲ Universal application ▲ Wide range of applications	 M	CTCP115 / CTCP125 / CTCK110 / CTCK120	CTCP115 / CTCP125	CTCP125 / CTCP135	 20° 0,25	0,50–5,00	0,12–0,40	CN.. DN.. SN.. TN.. VN.. WN..
		CTCP115	CTCP125	CTCP135				
		CTCP115 / CTCP125 / CTCK110 / CTCK120	CTCP115 / CTCP125 / CTCK110 / CTCK120	CTCP125 / CTCK120				
-M70 ▲ Light to medium rough machining ▲ Cast crust and forging skin ▲ Stable cutting edge ▲ Interrupted cut ▲ Raw materials and forgings	 M R	CTCK110 / CTCK120 / CTCP115	CTCP115 / CTCP125	CTCP125 / CTCP135	 15,7° 0,3	1,50–4,50	0,20–0,80	CN.. DN.. SN.. TN.. WN..
		CTCP115	CTCP125	CTCP135				
		CTCK110 / CTCK120 / CTCP115 / CTCP125	CTCK120 / CTCP125	CTCP125 / CTCK120				

Negative	Model	Smooth cut	Irregular cutting depth	Interrupted cut	Sectional illustration		Geometry	
Main application stainless steels, secondary application steel and super alloys -F30 ▲ Finishing of stainless steels ▲ Continuous cut ▲ High surface quality ▲ Good swarf control	 F	CTCM120 / CTPM125	CTCM120 / CTPM125 / CTCM130	CTCM130	 15°	0,08–2,5	0,10–0,35	CN.. DN.. SN.. TN.. VN.. WN..
		CTCM120 / CTPM125	CTCM120 / CTPM125 / CTCM130	CTCM130				
		CTCM120 / CTPM125 / CTCM130	CTCM120 / CTPM125 / CTCM130	CTCM130				
-M30 ▲ Option for stainless steel machining ▲ Good swarf control ▲ Little edg build up ▲ Low cutting forces ▲ Little built-up edge ▲ Applicable on unstable machines	 F	CTCM120 / CTPM125	CTCM120 / CTPM125 / CTCM130	CTCM130	 15° 0,25	1,00–4,50	0,15–0,40	CN.. DN.. SN.. TN.. VN.. WN..
		CTCM120 / CTPM125	CTCM120 / CTPM125 / CTCM130	CTCM130				
		CTCM120 / CTPM125 / CTCM130	CTCM120 / CTPM125 / CTCM130	CTCM130				
-M60 ▲ Light to medium roughing ▲ Stable cutting edge ▲ Interrupted cut ▲ Forged skin and cast crust	 F M	CTCM120 / CTPM125	CTCM120 / CTPM125 / CTCM130	CTCM130	 18° 0,3	1,50–6,00	0,25–0,50	CN.. DN.. SN.. TN.. WN..
		CTCM120 / CTPM125	CTCM120 / CTPM125 / CTCM130	CTCM130				
		CTCM120 / CTPM125 / CTCM130	CTCM120 / CTPM125 / CTCM130	CTCM130				

Standard chip breakers / application notes

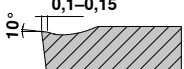
Positive		Model	Smooth cut	Irregular cutting depth	Interrupted cut	Sectional illustration		Geometry	
						a_p mm	f mm		
Main application steel and cast iron, secondary application stainless steels	-SF	 F	CTCP115	CTCP125	CTCP125 / CTCP135		0,05–2,50	0,05–0,25	CC.. DC.. SC.. TC.. VC.. WC..
	<ul style="list-style-type: none"> ▲ Finishing / contour turning ▲ Good swarf control ▲ High surface quality ▲ Low cutting forces 								
	-SMF	 F M	CTEP110 / CTCP115	TCM10 / CTCP125 / CTCP115	CTCP135		0,20–1,30	0,06–0,25	CC.. DC.. SC.. TC.. VC..
<ul style="list-style-type: none"> ▲ Finishing to medium machining ▲ Low cutting forces ▲ Good swarf control ▲ High surface quality 									
	-SM	 M	CTCP115 / CTCP125	CTCP125 / CTCP135 / CTCP115	CTCP125 / CTCP135		0,05–5,00	0,15–0,45	CC.. DC.. RC.. SC.. TC.. VC..
<ul style="list-style-type: none"> ▲ Medium machining ▲ Universal application ▲ Stable cutting edge ▲ Varying depths of cut ▲ Wide range of applications 									
	-SMQ	 M	CTCP115	CTCP125	CTCP125		1,00–4,00	0,15–0,45	CC.. DC..
<ul style="list-style-type: none"> ▲ Positive wiper geometry ▲ Finishing to medium machining ▲ Very high feeds ▲ High surface quality 									

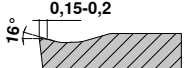
Positive		Model	Smooth cut	Irregular cutting depth	Interrupted cut	Sectional illustration	Geometry		
									
Main application stainless steels, secondary application steel and super alloys	-M25	 F M	CTCM120 / CTPM125	CTCM120 / CTPM125 / CTCM130	CTCM130		0,40–3,20	0,10–0,30	CC.. DC.. TC.. VC..
	<ul style="list-style-type: none"> ▲ First choice for medium machining of stainless steels ▲ High surface quality ▲ Little built-up edge 								
	-M55	 M	CTCM120 / CTPM125	CTCM120 / CTPM125 / CTCM130	CTCM130		0,40–4,80	0,06–0,35	CC.. DC.. SC.. TC.. VC..
<ul style="list-style-type: none"> ▲ First choice for medium machining to roughing of stainless steels ▲ Smooth to lightly interrupted cut ▲ Good swarf control ▲ Stable cutting edge 									



Standard chip breakers / application notes

positive	Model	Smooth cut	Irregular cutting depth	Interrupted cut	Sectional illustration		Geometry	
					a_p mm	f mm		
-23P ▲ Maximum tolerance class ▲ Outstanding chip control, even with the smallest cutting depths ▲ Very low cutting forces	 F	H216T	H216T	H216T	 30°	0,2-4,0	0,05-0,3	CC.. DC..
		H216T	H216T	H216T				
		H216T	H216T	H216T				
		H216T	H216T	H216T				
		H216T	H216T	H216T				
-25P ▲ Low adhesion ▲ Good chip control with soft aluminium alloys	 F M	CTPX710	CTPX710		 20°	0,50-4,50	0,05-0,60	CC.. DC.. SC.. VC..
		CTPX710	CTPX710					
		CTPX710 / H216T	CTPX710 / H216T	CTPX710 / H216T				
		CTPX710	CTPX710					
		CTPX710	CTPX710					
-25Q ▲ Sharp cutting edge ▲ Good swarf control on soft aluminium alloys ▲ Low adhesion	 M	CTPX710	CTPX710		 20°	0,05-6,50	0,05-0,60	CC.. DC.. VC..
		CTPX710	CTPX710					
		H210T	H210T					
		H210T / CTPX710	H210T / CTPX710	H210T / CTPX710				
		H210T / CTPX710	H210T / CTPX710					
-27 ▲ Wiper geometry ▲ High feeds ▲ High surface quality ▲ Good chip control with softer aluminium alloys ▲ Low adhesion	 M R	CTPX715	CTPX715		 19°-25°	1,00-10,00	0,10-0,75	CC.. DC.. RC.. SC.. TC.. VC..
		CTPX715	CTPX715					
		CTPX715 / H216T	CTPX715 / H216T					
		CTPX715 / H216T	CTPX715 / H216T	CTPX715 / H216T				
		CTPX715	CTPX715					
-29 ▲ Direct sintered aluminium geometry ▲ Positive rake angle ▲ Good chip control ▲ For medium to rough machining	 M	CTPX715	CTPX715		 20°	1,00-6,00	0,25-0,60	CC.. DC.. VC..
		CTPX715	CTPX715					
		CTPX715	CTPX715	H216T				
		CTPX715 / H216T	CTPX715 / H216T	H216T				
		CTPX715	CTPX715					
-M81 ▲ Dircetly pressed insert ▲ Positive rake angle ▲ Good swarf control ▲ For medium to rough machining	 M	CWN2120			 20°	1,00-6,00	0,25-0,60	CC.. DC.. VC..
		CWN2120	CWN2120	CWN2120				
		CWN2120	CWN2120	CWN2120				
		CWN2120	CWN2120	CWN2120				
		CWN2120	CWN2120	CWN2120				

Main application non-ferrous metals, secondary application stainless steels, steels, super alloys, cast iron

3

Standard chip breakers / application notes

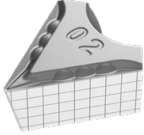
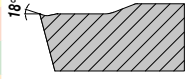
	Positive	Model	Smooth cut	Irregular cutting depth	Interrupted cut	Sectional illustration		Geometry
						a_p mm	f mm	
Main application super alloys and stainless steels, secondary application steels and non-ferrous metals -F05 ▲ The universal Alu geometry ▲ Sharp cutting edge ▲ Extremely positive rake angle ▲ Low adhesion ▲ High feed rates	 F	CTPX710	CTPX710		 DC., VC..	0,10–2,50	0,02–0,25	
		CTPX710	CTPX710					
		CTPX710	CTPX710					
		CTPX710	CTPX710					
		CTPX710	CTPX710					
		CTPX710	CTPX710					
		CTPX710	CTPX710					

Masterfinish – smoothing geometry – information

High-quality surfaces can be produced inexpensively using indexable inserts with smoothing edge (-TFQ; -TMQ; -SMQ; -25Q).

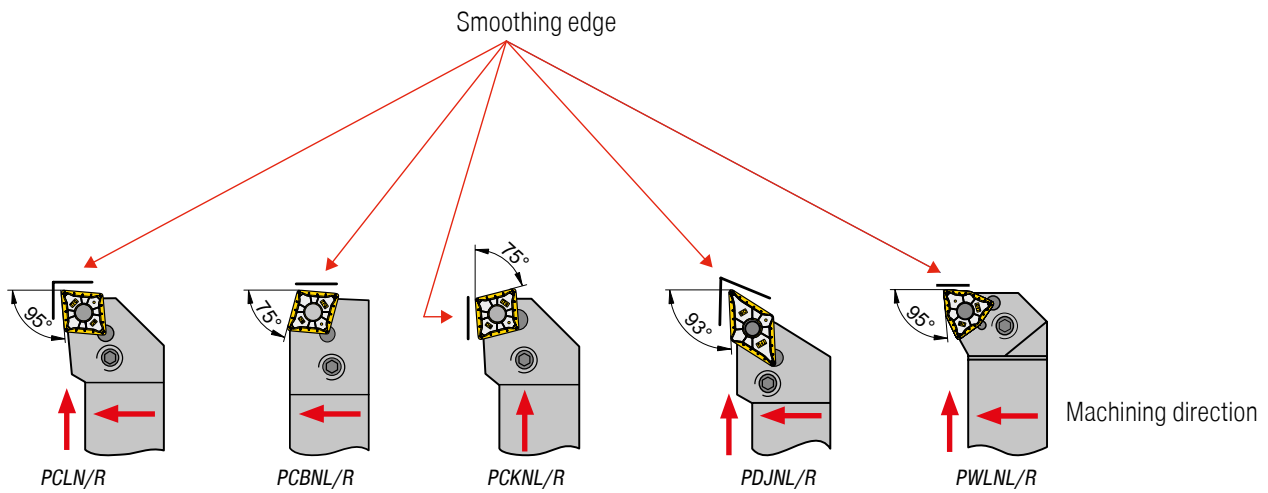

All turning inserts with smoothing cutting edge are clamped in standard ISO tool holders

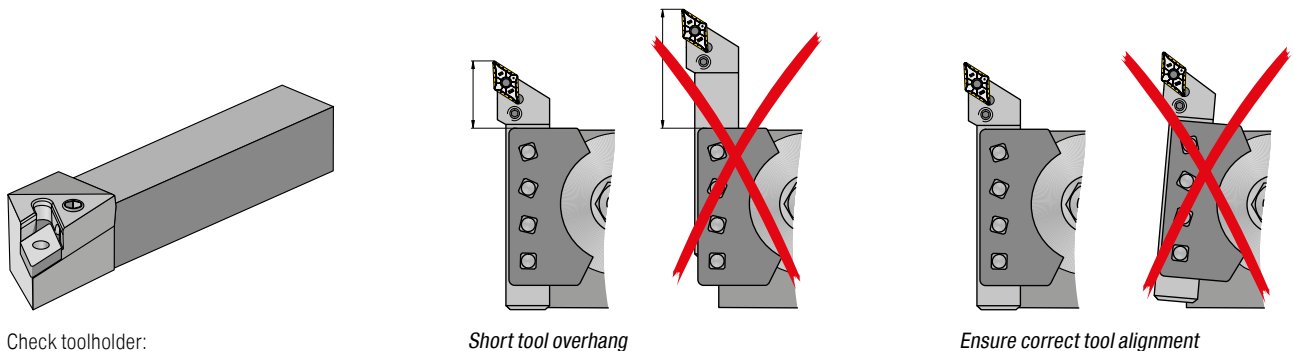

Check toolholder:

- ▲ Insert seat
- ▲ Shim
- ▲ Clamping Lever

Feed rate guide values for surface finish quality

Roughness range R _z in µm	R _t max.	Corresponds to R _a	Roughness index	ISO 1302	Corner radius r _ε in mm and feed rate f in mm/rev.			
					r _ε = 0,4	r _ε = 0,8	r _ε = 1,2	r _ε = 1,6
63-100	√ R _t 100	12,5-25	N11	25/√		0,51	0,69	0,88
40-63	√ R _t 63	6,3-25	N10	12,5/√	0,27	0,43	0,56	0,68
31,5-40	√ R _t 40	4,9-6,3	N9	6,3/√	0,25	0,37	0,49	0,57
25-31,5	√ R _t 31,5	4,0-4,9			0,22	0,32	0,41	0,47
16-25	√ R _t 25	2,5-4,0	N8	3,2/√	0,20	0,28	0,36	0,39
10-16	√ R _t 16	1,6-2,5			0,15	0,22	0,29	0,31
6,3-10	√ R _t 10	1,0-1,6	N7	1,6/√	0,10	0,13	0,18	0,20

Masterfinish – smoothing geometry – operating principle

Relationship of feed rate to surface roughness

Improved Surface Quality

Given identical feed rates, the indexable insert with smoothing geometry attains an R_t value that is many times better than a conventional indexable insert.



Shorter machining time

If the same R_t value is achieved as with a standard indexable insert, the indexable insert with the smoothing geometry can be moved at twice the feed speed (= lower cycle times!)



Theoretical Surface Quality

The maximum theoretical surface roughness with turning $R_{t,theor}$ is the combination of feed rate and corner radius:

or approximately:

$$R_{t,theor} = \left(r_\epsilon - \sqrt{r_\epsilon^2 - \frac{f^2}{4}} \right) \cdot 1000$$

$$R_{t,theor} = \frac{125 \cdot f^2}{r_\epsilon} \text{ [}\mu\text{m]}$$

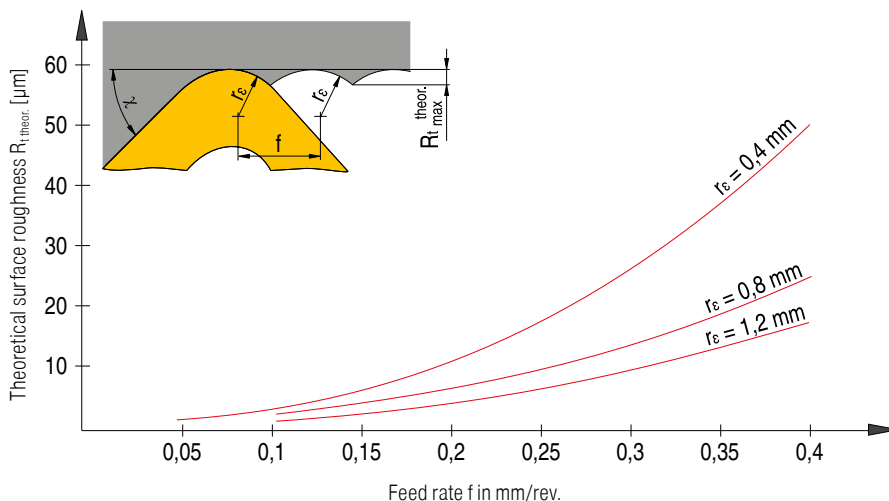

Setting Device

The adjustment device is profitable if the tool system is expanded with several tool holder blocks on several machines. The tool system can be preset so that holders on every machine have a suitable centre height in relation to the turning centre of the machine.

Setting Device

1. Zero the dial gauge on the surface of the measuring stick.

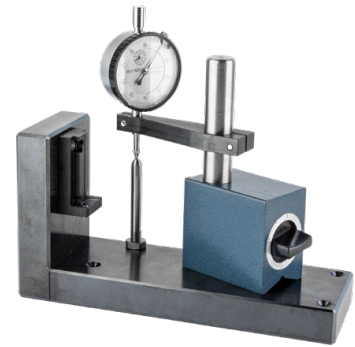

2. Place tool holder block on the device and gently tighten the clamping screw until the holder sits on the device free of play. Ideally, set the centre height slightly below the centre, so that the tool holder block is pushed upward when the height is set.

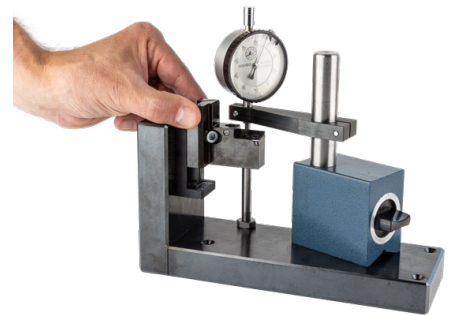

3. Carefully place the dial gauge on the tip of the tool's cutting edge.

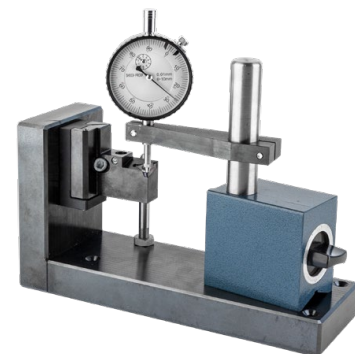

4. Adjust the height adjustment screw until the dial gauge is set to zero.



Procedure when retrofitting on the CT tool system

1. Screw all base holders (1) into the machine.
2. Clamp the height-adjustable screw (4) of the individual base holders (1) and set to the same height using the dial gauge.
3. Clamp a tool holder block (2) onto any base holder (1) and set precisely on the turning centre using the height-adjustable screw (3) of the tool holder block (2).
4. Remove the tool holder block (2) from the machine and clamp it on the height presetting device.
5. Set the dial gauge on the tool to zero and adjust the measuring pin on the presetting device.
6. Each additional tool holder block (2) is set to zero once on the presetting device using the measuring pin and dial gauge.

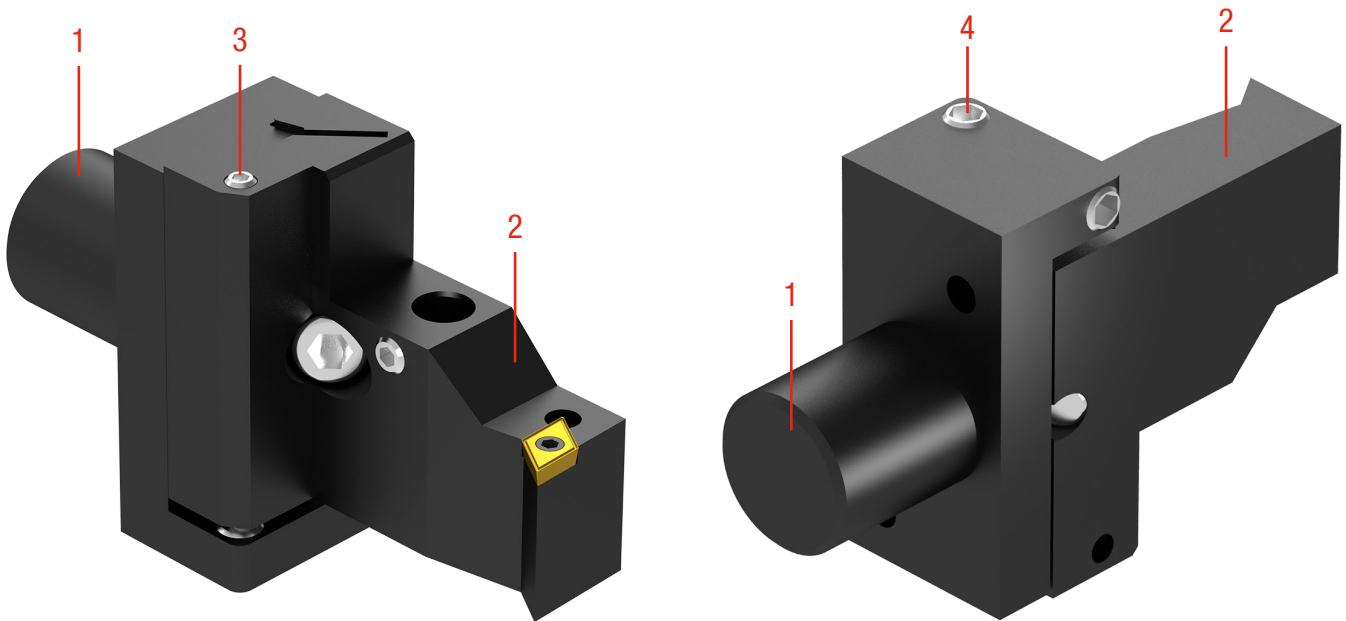

If several tool holders are arranged side-by-side, you can quickly and reliably fix them at the same height using height adjustment screws (3) and (4).

The same tool holders (2) can be used for multiple machines without presetting them again individually. However, the base holders (1) of the other machines must be adjusted to one another.

This is done as follows:

1. Screw all base holders into machine 2.
2. Clamp a preset tool block holder from machine 1 on any base holder in machine 2 and adjust the turning centre precisely using the height-adjustment screw of the base holder.
3. Set all other height-adjustable screws on the rest of the base holders in machine 2 to the same height using the dial gauge. The preset tool block holders can thus be used on each tool station of several machines without readjustment.

VertiClamp

Features

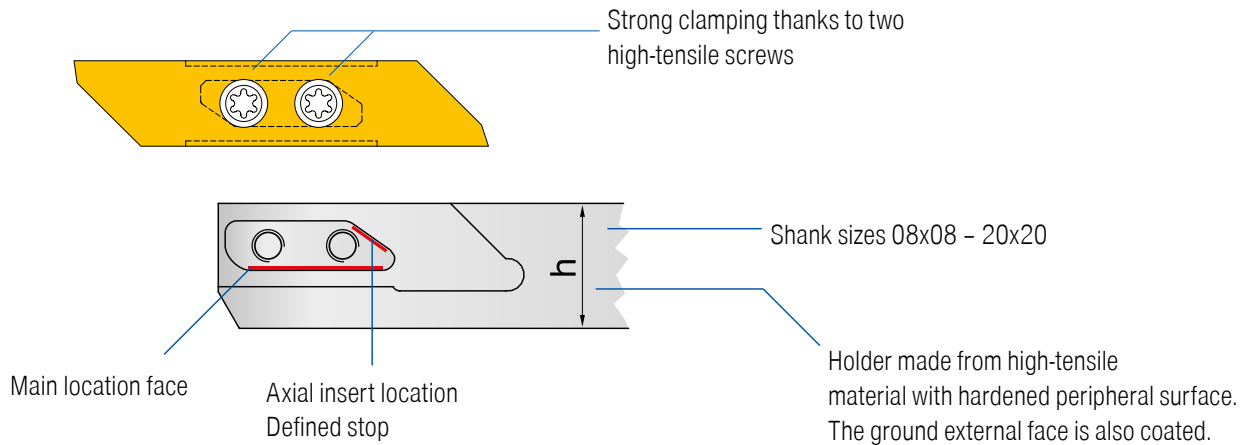

Advantages

- ▲ The connection between the indexable insert and holder guarantees optimum fixation
- ▲ The second cutting edge can always be used, even if the first cutting edge is broken off
- ▲ Shearing forces do not act on the screws
- ▲ For all cutting edge forms, the overhang of the cutting edge from the tool holder is identical
- ▲ Vertical insert orientation maintained thanks to large seating surface
- ▲ The indexable insert seat is completely protected against swarf
- ▲ Inserts are clamped through two high-tensile screws and a tapered axial stop of 30° in all cutting directions

Clamping of cutting edge With combi holders

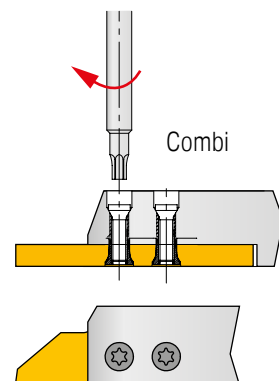

Turning away from the spindle

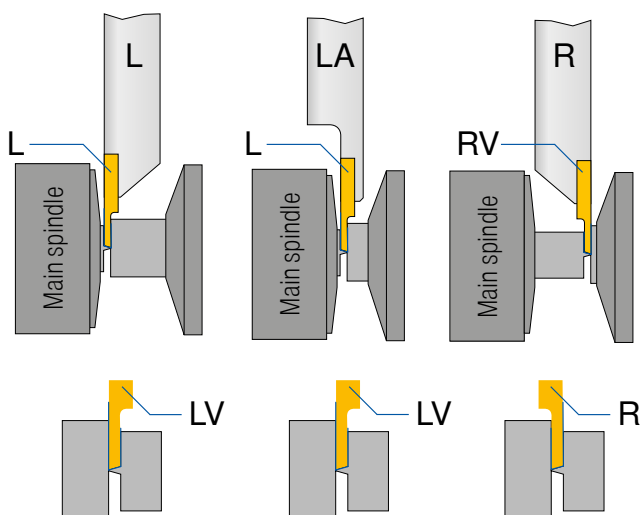

Clamping of cutting edge With standard holders

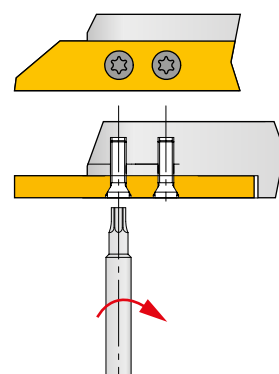

TriClamp

The feed rate can be doubled through the use of the TriClamp system with wiper geometry and 93° holder. This in turn allows machining times to be reduced considerably with no impact on quality, or the surface quality can be improved whilst retaining the same machining time. The ability to machine in a radial direction and in both axial directions makes this system particularly flexible.

Advantages

- ▲ Expansion of the ISO range
- ▲ Turning in three directions
- ▲ All cutting edges can easily be replaced
- ▲ Sharp positive cutting edges with 11° clearance angle
- ▲ Small corner radii 0.08 mm and 0.2 mm
- ▲ Perfect chip control
- ▲ Special holders for sliding head lathes (Cross-sections 8x8 mm to 16x16 mm)

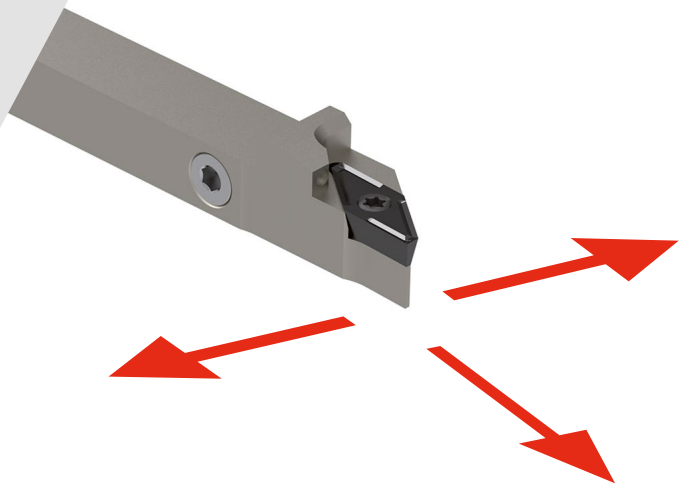

Wiper geometry in detail:

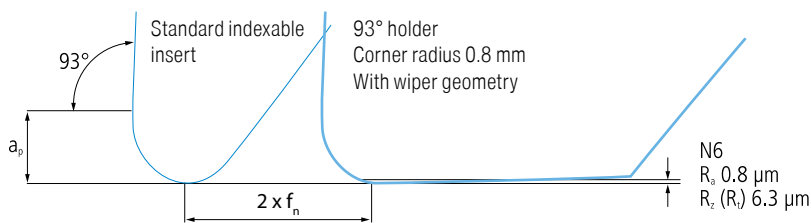

Applications:

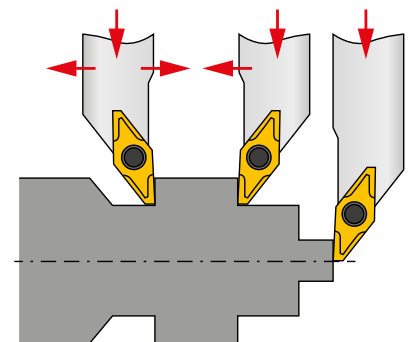

Tool holders with a thro' coolant supply increase the performance of indexable inserts and improve the quality of components, particularly in the case of difficult-to-machine materials such as stainless steels and super alloys.

- ▲ All IC holders have five coolant supply options
- ▲ Made from highly tempered steel
- ▲ Precise coolant jet on the cutting edge
- ▲ Can be used at any coolant pressure

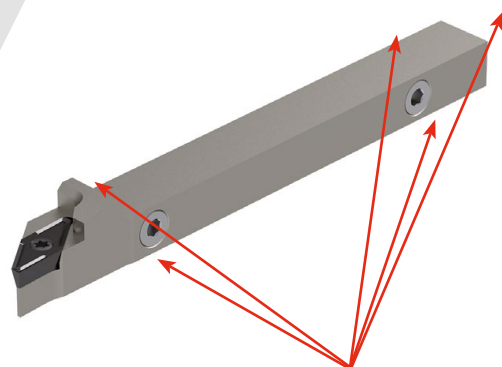

Coolant connection options

XheadClamp

The fast tool change with high repeatability has become a competitive advantage for series that usually have to be manufactured with the maximum chip evacuation possible. Ceratizit has taken this production requirement into account with the newly developed XheadClamp holder system. Time savings and an extremely short setup process are key advantages of the system. The XheadClamp system is also setting standards in terms of flexibility and ease of use.

With the XheadClamp, changing the indexable insert or geometry – e.g. switching from turning to grooving inserts – can be accomplished quickly, easily and with maximum precision.

Clamping method

- ▲ Extremely high clamping forces
- ▲ Release and clamping of an exchangeable head using only one screw
- ▲ Repeatability of less than $\pm 7.5 \mu\text{m}$
- ▲ Maximum stability

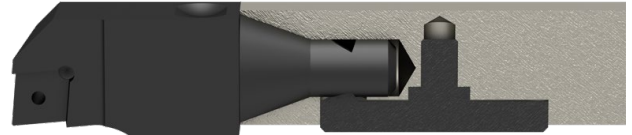

Versatility

- ▲ All heads can be installed regardless of system size
- ▲ Tools can be adapted to the component
- ▲ Fastest indexable insert change thanks to exchangeable head



Accuracy

- ▲ No variable X and Y dimensions when changing the head
- ▲ Repeatability of less than $\pm 7.5 \mu\text{m}$
- ▲ Centre height is retained even when the insert size is changed
- ▲ Two-nose system guarantees the correct position

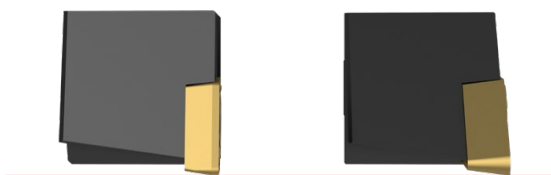

ISO designation system for inserts

Indexable inserts – metric

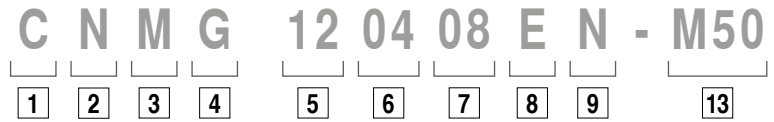

Indexable inserts – inch

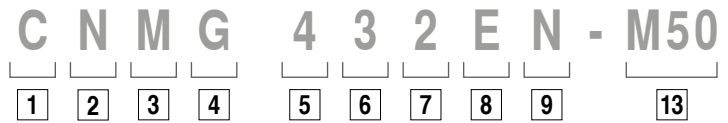

Indexable inserts, CBN, ceramic – metric

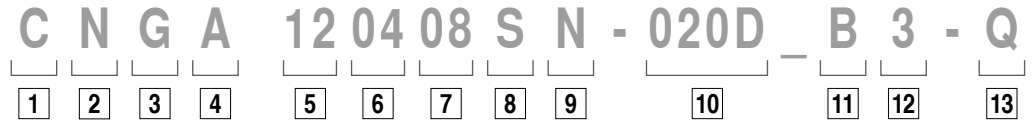

Indexable inserts, CBN, ceramic – inch

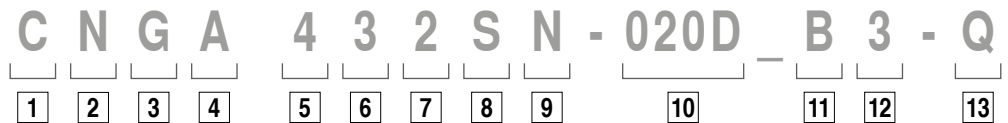

1

Insert shape

V	35°	Included angle
D	55°	
E	75°	
C	80°	Included angle
M	86°	
K	55°	Included angle
B	82°	
A	85°	Other shapes
L	90°	
P	108°	
H	120°	
O	135°	
R	-	
S	90°	
T	60°	
W	80°	

2

Clearance angle

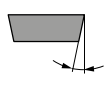

α		α	
A	3°	F	25°
B	5°	G	30°
C	7°	N	0°
D	15°	P	11°
E	20°		

O Clearance angles not included within the standard for which particular information is necessary.

3

Tolerances

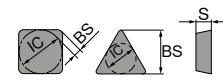

	IC±		BS		S	
	mm	inch	mm	inch	mm	inch
A	0,025	.0010	0,005	.0002	0,025	.001
F	0,013	.0005	0,005	.0002	0,025	.001
C	0,025	.0010	0,013	.0005	0,025	.001
H	0,013	.0005	0,013	.0005	0,025	.001
E	0,025	.0010	0,025	.0010	0,025	.001
G	0,025	.0010	0,025	.0010	0,13	.005
J	0,05-0,15*	.002-.006*	0,005	.0002	0,025	.001
K	0,05-0,15*	.002-.006*	0,013	.0005	0,025	.001
L	0,05-0,15*	.002-.006*	0,025	.0010	0,025	.001
M	0,05-0,15*	.002-.006*	0,05-0,20*	.003-.008*	0,13	.005
N	0,05-0,15*	.002-.006*	0,05-0,20*	.003-.008*	0,025	.001
U	0,08-0,25*	.003-.010*	0,13-0,38*	.005-.015*	0,13	.005

* Depends on insert size

6

Insert thickness



mm		inch		Code	
1,59	1/16	01	1		
2,38	3/32	02			
3,18	1/8	03	2		
3,97	5/32	T3			
4,76	3/16	04	3		
5,56	7/32	05			
6,35	1/4	06	4		
7,94	5/16	07	5		
9,52	3/8	09	6		

7

Corner radius



mm		inch		Code		
≤ 0,05	.0015	00	X0			RN 00 RC MO
0,1	.004	01	0			
0,2	.008	02	.5			
0,4	1/64	04	1			
0,8	1/32	08	2			
1,2	3/64	12	3			
1,6	1/16	16	4			
2,0	5/64	20	5			
2,4	3/32	24	6			
2,8	7/64	28	7			
3,2	1/8	32	8			

8

Cutting edge

F	Sharp
E	rounded
T	chamfered
S	Chamfered and honed
K	Double-chamfered
P	Double-chamfered and honed
R	Round chamfer

9

Direction of cut

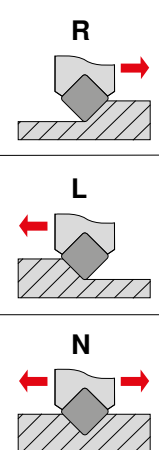

CBN and PCD segment orientation

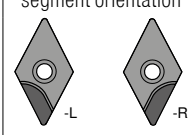

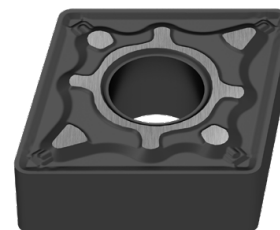

4

Characteristics

N	
R	
F	
A	
M, P	
G, P	
W	
T	
Q	
U	
B	
H	
C	
J	
X	Special version

inch
Change at inscribed circle
IK < 1/4"

IK > 1/4"	IK < 1/4"
N / R / F	E
A / M / G	D
X	X

5

Cutting length

Type	ISO	ANSI	L		IC	
			mm	inch	mm	inch
	06	2	6,4	.250	6,35	.250
	09	3	9,7	.382	9,525	.375
	12	4	12,9	.508	12,70	.500
	16	5	16,1	.634	15,875	.625
	19	6	19,3	.760	19,05	.750
	25	8	25,8	1.016	25,4	1.000
32	12	35,24	1.269	31,75	1.250	
	06	2	6,35	.250	6,35	.250
	09	3	9,525	.375	9,525	.375
	12	4	12,7	.500	12,7	.500
	15	5	15,875	.625	15,875	.625
	19	6	19,05	.750	19,05	.750
	25	8	25,4	1.000	25,4	1.000
31	10	31,75	1.250	31,75	1.250	
	07	2	7,7	.303	6,35	.250
	11	3	11,6	.457	9,525	.375
15	4	15,5	.610	12,70	.500	
	11	2	11,1	.437	6,35	.250
	16	3	16,6	.653	9,525	.375
22	4	22,10	.870	12,70	.500	

Type	ISO	ANSI	L		IC		
			mm	inch	mm	inch	
	06	1.2	6,9	.272	3,97	.156	
	09	1.8	9,6	.378	5,56	.219	
	11	2	11,0	.433	6,35	.250	
	16	3	16,5	.650	9,525	.375	
	22	4	22,	.079	12,70	.039	
	27	5	27,5	1.083	15,875	.625	
	33	6	33,0	1.299	19,05	.750	
		06	3	6,5	.256	9,525	.375
		08	4	8,7	.331	12,70	.039
		10	5	10,9	.429	15,875	.625
	06	2	6,35	.250	6,35	.250	
	08	-	8,0	.315	8,0	.315	
	09	3	9,52	.375	9,52	.375	
	10	-	10,0	.394	10,0	.394	
	12*	-	12,0	.472	12,0	.472	
	12	4	12,7	.488	12,70	.488	
	15	5	15,875	.625	15,875	.625	
	16	-	16,0	.630	16,0	.630	
	19	6	19,05	.750	19,05	.750	
	25	8	25,0	.984	25,0	.984	
	25*	-	25,4	1.000	25,4	1.000	
	31	10	31,75	1.250	31,75	1.250	
	32	-	32,0	1.260	32,0	1.260	

* inch version

3

10

Chamfer type

	mm	inch		
015	0,15	.006	A	05°
020	0,20	.008	B	10°
025	0,25	.010	C	15°
050	0,50	.020	D	20°
075	0,75	.030	E	25°
100	1,00	.040	F	30°
			G	35°

1) Two letters are assigned for double-chamfered cutting edges
e.g. BE =
chamfer angle 1 (y₁) = 10°
chamfer angle 2 (y₂) = 25°

11

Number of cutting edges

Single sided		Complete insert thickness	
A		T	
B		U	
C		V	
D		W	
G		X	
H		Y	
Double sided		Entire clamping flat	
K		S	
L		F	
M		E	
N			
P			
Q			

12

Segment length

Approx. specification in mm

13

Chip breaker designation

You can find a comprehensive chip breaker overview on
→ page 149–152

ISO designation system for tool holders

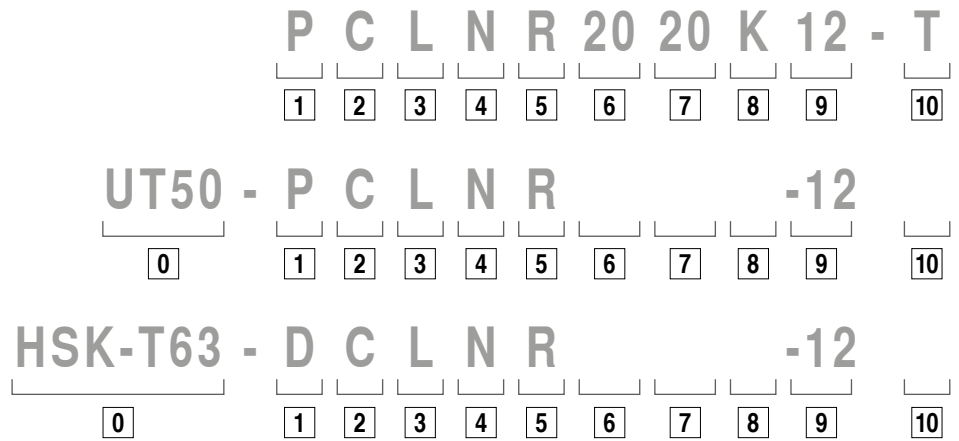

0

System/size

UT = UTS
 according to ISO 26622
 UT40 = UTS 40 mm
 UT50 = UTS 50 mm
 UT63 = UTS 63 mm

HSK-T
 according to ISO 12164
 HSK-T63 = 63 mm
 HSK-T100 = 100 mm

1

Tool holder

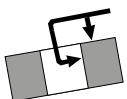
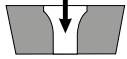
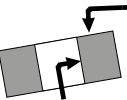
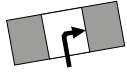
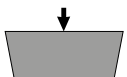
<p>D</p>  <p>Retained from above and via bore</p>	<p>S</p>  <p>Retained via centre screw</p>
<p>M</p>  <p>Retained from above and via bore</p>	<p>P</p>  <p>Retained via the bore</p>
<p>C</p>  <p>Retained from above</p>	<p>X</p> <p>Special version</p>

2

Insert shape

V 35°	Included angle
D 55°	
E 75°	
C 80°	Included angle
M 86°	
K 55°	Included angle
B 82°	
A 85°	Other shapes
L 90°	
P 108°	
H 120°	
O 135°	
R -	
S 90°	
T 60°	
W 80°	

6

Shank height



H

7

Shank width



B

8

Tool length

OAL			OAL		
mm	inch		mm	inch	
32	4.000	A	160	4.500	N
40	4.500	B	170	5.500	P
50	5.000	C	180	-	Q
60	6.000	D	200	6.000	R
70	7.000	E	250	7.000	S
80	8.000	F	300	8.000	T
90	5.500	G	350	5.500	U
100	5.625	H	400	3.500	V
110	5.300	J	450	3.500	W
125	14.000	K	500	3.750	Y
140	6.800	L	Special version		X
150	4.400	M			



OAL



3

Style

A 90° B 75° C 90° D 45° E 60°
 F 90° G 90° H 107,5° J 93° K 75°
 L 95° M 50° N 63° P 117,5° R 75°
 S 45° T 60° U 93° V 72,5° W 60°
 Y 85°

4

Clearance angle

α		α	
A	3°	F	25°
B	5°	G	30°
C	7°	N	0°
D	15°	P	11°
E	20°		

O Clearance angles not included within the standard for which particular information is necessary.

5

Direction of cut

R
L
N

9

Cutting length

L S R
 ABK T VDECM
 O H P W

10

Manufacturer specification

T = Toggle
 Special length (mm)
 Insert thickness (deviating from standard)
 Special version (X..)
 Machine manufacturer (specific)

ISO designation system for boring bars

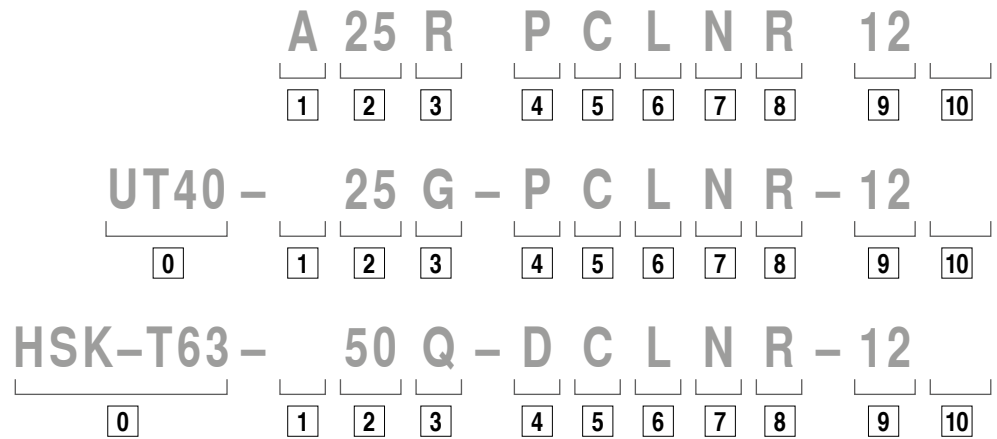

0
<p>System/size</p> <p>UT = UTS according to ISO 26622 UT40 = UTS 40 mm UT50 = UTS 50 mm UT63 = UTS 63 mm</p> <p>HSK-T according to ISO 12164 HSK-T63 = 63 mm HSK-T100 = 100 mm</p>

1										
<p>Shank type</p> <table border="1" style="width: 100%;"> <tr> <td>S Steel shank</td> <td>E As C with coolant hole</td> </tr> <tr> <td>A Steel shank with coolant hole</td> <td>F As C with antivibration system</td> </tr> <tr> <td>B Steel shank with antivibration system</td> <td>G As C with coolant hole and antivibration system</td> </tr> <tr> <td>D Steel shank with coolant hole and antivibration system</td> <td>H Heavy metal</td> </tr> <tr> <td>C Carbide shank with steel head</td> <td>J Heavy metal with coolant hole</td> </tr> </table>	S Steel shank	E As C with coolant hole	A Steel shank with coolant hole	F As C with antivibration system	B Steel shank with antivibration system	G As C with coolant hole and antivibration system	D Steel shank with coolant hole and antivibration system	H Heavy metal	C Carbide shank with steel head	J Heavy metal with coolant hole
S Steel shank	E As C with coolant hole									
A Steel shank with coolant hole	F As C with antivibration system									
B Steel shank with antivibration system	G As C with coolant hole and antivibration system									
D Steel shank with coolant hole and antivibration system	H Heavy metal									
C Carbide shank with steel head	J Heavy metal with coolant hole									

5																												
<p>Insert shape</p> <table border="1" style="width: 100%;"> <tr> <td>V 35°</td> <td rowspan="4">Included angle</td> </tr> <tr> <td>D 55°</td> </tr> <tr> <td>E 75°</td> </tr> <tr> <td>C 80°</td> </tr> <tr> <td>M 86°</td> <td></td> </tr> <tr> <td>K 55°</td> <td rowspan="2">Included angle</td> </tr> <tr> <td>B 82°</td> </tr> <tr> <td>A 85°</td> <td></td> </tr> <tr> <td>L 90°</td> <td></td> </tr> <tr> <td>P 108°</td> <td></td> </tr> <tr> <td>H 120°</td> <td></td> </tr> <tr> <td>O 135°</td> <td></td> </tr> <tr> <td>R -</td> <td></td> </tr> <tr> <td>S 90°</td> <td></td> </tr> <tr> <td>T 60°</td> <td></td> </tr> <tr> <td>W 80°</td> <td></td> </tr> </table> <p style="text-align: right; margin-right: 20px;">Other shapes</p>	V 35°	Included angle	D 55°	E 75°	C 80°	M 86°		K 55°	Included angle	B 82°	A 85°		L 90°		P 108°		H 120°		O 135°		R -		S 90°		T 60°		W 80°	
V 35°	Included angle																											
D 55°																												
E 75°																												
C 80°																												
M 86°																												
K 55°	Included angle																											
B 82°																												
A 85°																												
L 90°																												
P 108°																												
H 120°																												
O 135°																												
R -																												
S 90°																												
T 60°																												
W 80°																												

6
<p>Style</p> <p style="text-align: center;">*) CERATIZIT factory standard</p>

7										
<p>Clearance angle</p> <table border="1" style="width: 100%;"> <tr> <td>A 3°</td> <td>F 25°</td> </tr> <tr> <td>B 5°</td> <td>G 30°</td> </tr> <tr> <td>C 7°</td> <td>N 0°</td> </tr> <tr> <td>D 15°</td> <td>P 11°</td> </tr> <tr> <td>E 20°</td> <td></td> </tr> </table> <p>O Clearance angles not included within the standard for which particular information is necessary.</p>	A 3°	F 25°	B 5°	G 30°	C 7°	N 0°	D 15°	P 11°	E 20°	
A 3°	F 25°									
B 5°	G 30°									
C 7°	N 0°									
D 15°	P 11°									
E 20°										



2

Shank type & size

DCONMS mm	DCONMS inch
08	
10	
12	
16	
20	
25	
32	
40	
50	
60	

A two-digit figure indicating the boring bar diameter in 1/16 of an inch.

3

Tool length

OAL		
mm	inch	
80	3	F
100	3,5	H
110	4	J
125	4,5	K
140	5	L
150	5,5	M
160	6	N
170	6,5	P
180	6,75	Q
200	7	R
250	8	S
300	10	T
350	12	U
400	14	V
450	16	W
500	18	Y
	20	
Special version		X

4

Clamping method

<p>D</p> <p>Retained from above and via bore</p>	<p>S</p> <p>Retained via centre screw</p>
<p>M</p> <p>Retained from above and via bore</p>	<p>P</p> <p>Retained via the bore</p>
<p>C</p> <p>Retained from above</p>	<p>X</p> <p>Special version</p>

8

Direction of cut

R

L

9

Cutting length

10

Manufacturer specification

T = Toggle
 Special length (mm)
 Insert thickness (deviating from standard)
 Special version (X..)
 Machine manufacturer (specific)

Types of wear

Wear on clearance face



Abrasion on flank: normal wear after a certain machining time

Cause

- ▲ Too high cutting speed
- ▲ Carbide grade with too low wear resistance
- ▲ Feed rate not adapted

Remedy

- ▲ Reduce cutting speed
- ▲ Use grade with higher wear resistance
- ▲ Adapt feed rate to cutting speed and cutting depth

Edge chipping

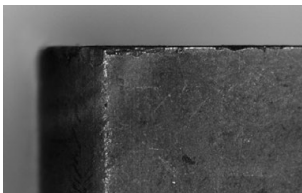

Through excessive mechanical stress at the cutting edge fracture and chipping can occur.

Cause

- ▲ Grade with too high wear resistance
- ▲ Vibration
- ▲ Too high cutting speed and / or feed rate
- ▲ Interrupted cut
- ▲ Swarf damage

Remedy

- ▲ Use tougher grade
- ▲ Use negative cutting edge geometry with chip groove
- ▲ Improve stability (tool, work piece)

Cratering



The hot chip which is being evacuated causes cratering at the rake face of the cutting edge.

Cause

- ▲ Too high cutting speed and / or feed rate
- ▲ Rake angle too shallow
- ▲ Grade with insufficient wear resistance
- ▲ Insufficient coolant supply

Remedy

- ▲ Reduce cutting speed and / or feed rate
- ▲ Use grade with higher wear resistance
- ▲ Increase coolant quantity and / or pressure, optimise coolant supply
- ▲ Use grade which is more resistant to cratering

Plastic deformation

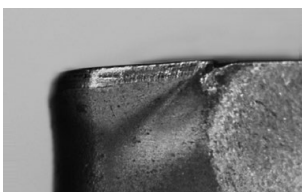

High machining temperature and simultaneous mechanical stress can lead to plastic deformation.

Cause

- ▲ Too high machining temperature resulting in softening of substrate
- ▲ Damage of coating
- ▲ Grade with insufficient wear resistance
- ▲ Insufficient coolant supply

Remedy

- ▲ Reduce cutting speed
- ▲ Use grade with higher wear resistance
- ▲ Provide cooling

Built-up edge

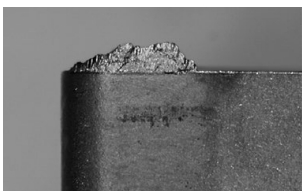

Built-up material / edges occur when the chip is not evacuated properly due to insufficient cutting temperature.

Cause

- ▲ Insufficient cutting speed
- ▲ Rake angle too shallow
- ▲ Wrong cutting material
- ▲ Lack of cooling / lubrication

Remedy

- ▲ Increase cutting speed
- ▲ Increase rake angle
- ▲ Apply TiN coating
- ▲ Use emulsion with higher concentration

Insert breakage

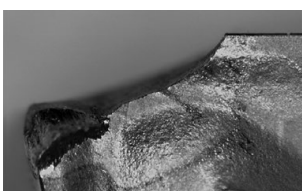

Excessive stress of the insert causes breakage.

Cause

- ▲ Excessive stress of cutting material
- ▲ Lack of stability
- ▲ Clearance angle too small

Remedy

- ▲ Use tougher grade
- ▲ Use protective edge chamfer
- ▲ Increase edge hone
- ▲ Use geometry with higher stability

Recommendation for Optimum Results

Type of problem																		
Type of wear						Work piece problems				Swarf control								
Wear on clearance face	Cratering	Edge chipping	Plastic deformation	Insert breakage	Built-up edge	Vibration	Formation of pits and burrs	Chattered surface	Surface quality	Chip too long (snarl chip)	Chip too short (fragmented chip)							
↓	↓		↓		↓	↓			↑	↓		Cutting speed		Cutting data	Remedy measures			
~		↓	↓	↓		↑		↓	↓	↑	↓	Feed rate						
↓	↓	↓	↓				↓	↓	↓			Feed rate at centre						
		↑	~		↓	~	↓	↓	↓	↓	↑	Chip groove		↑		↓	Insert selection	
↑		↑	↑	↑		↓	↓	↓	↑			Corner radius		↑		larger smaller		↓
↑	↑	↓	↑	↓								Tool Material		↑		Wear resistance toughness		↓
		~		~		~		~	~			Tool clamping		General criteria				
		~		~		~		~	~			Work piece clamping						
		~		~		~			↓			Overhang						
~		~				~	~		~			Tip height						
●	~		●		●		●		●	●		Cooling lubricant						

raise, increase large influence
 raise, increase small influence

avoid, reduce large influence
 avoid, reduce small influence

check, optimise
 use

Grades Overview

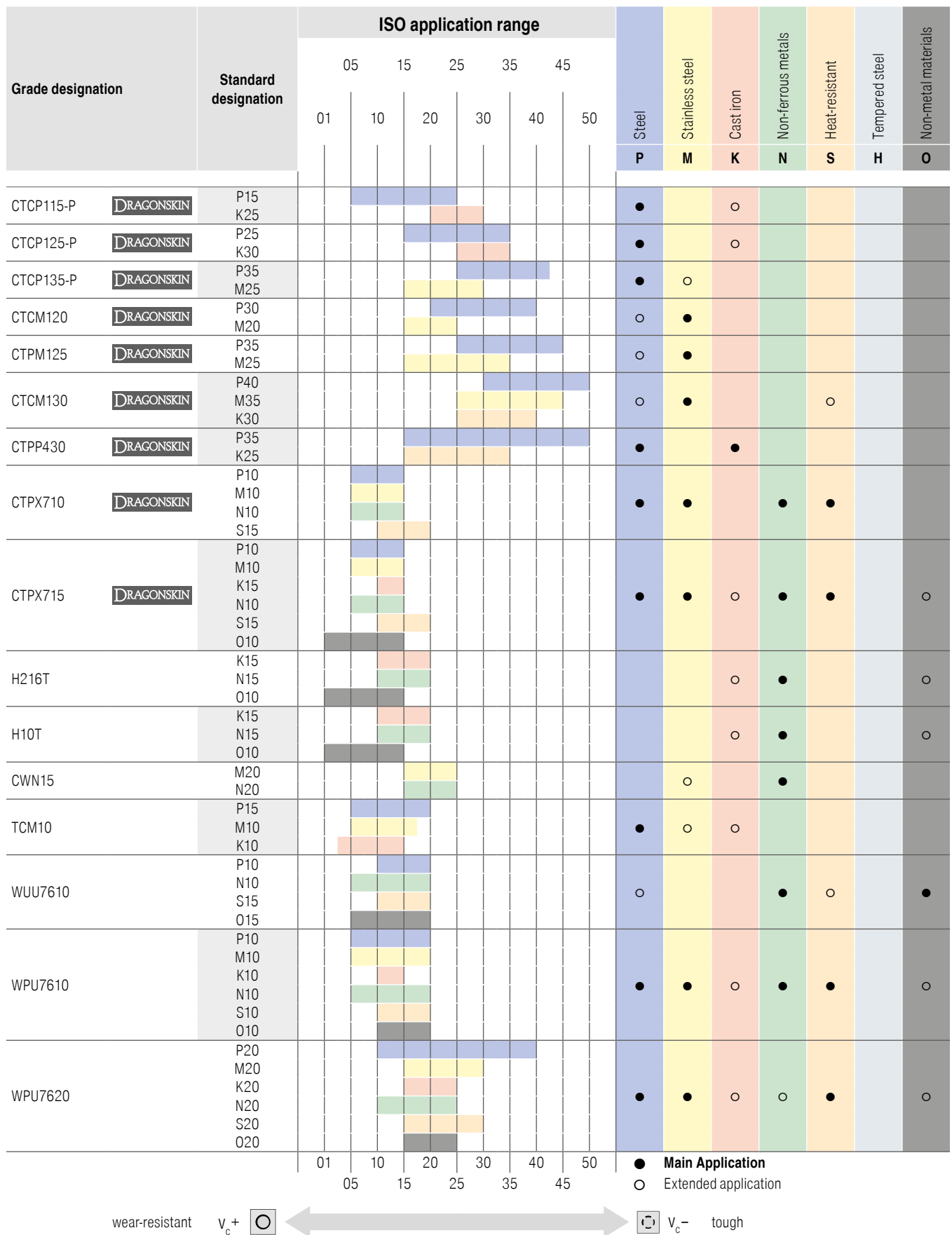

Grades Overview

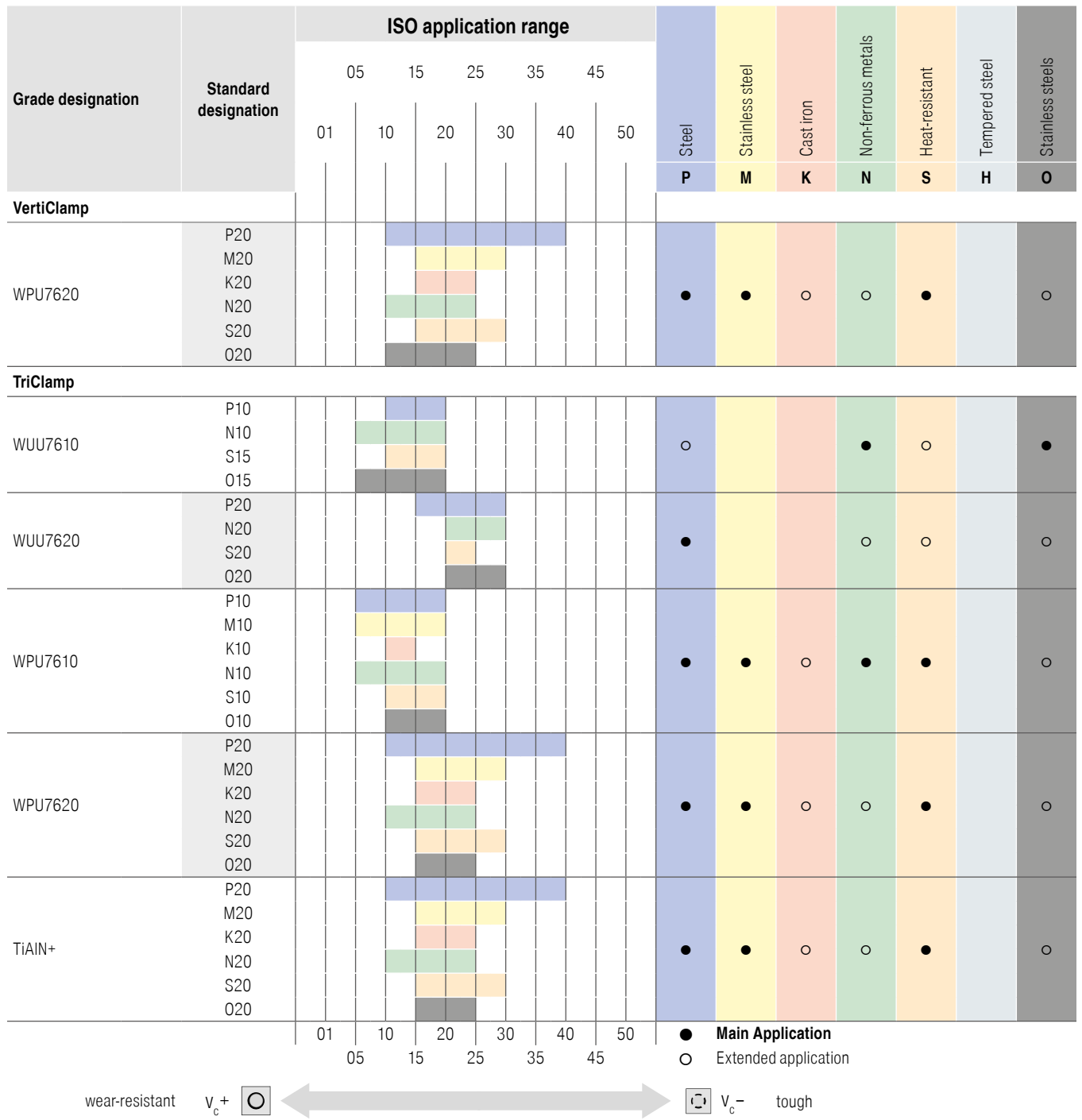

3

Grade description

<p>CTCP115-P DRAGONSKIN</p> <ul style="list-style-type: none"> ▲ Carbide, TiCN-Al₂O₃-coated ▲ with wear detection ▲ ISO P15 K25 ▲ The wear-resistant high-performance grades for stable conditions and continuous long cutting 	<p>H10T</p> <ul style="list-style-type: none"> ▲ Carbide, uncoated ▲ ISO K15 N15 O10 ▲ The uncoated carbide grade for machining aluminium and other non-ferrous metals
<p>CTCP125-P DRAGONSKIN</p> <ul style="list-style-type: none"> ▲ Carbide, TiCN-Al₂O₃-coated ▲ with wear detection ▲ ISO P25 K30 ▲ The first choice for universal machining of steels 	<p>H210T</p> <ul style="list-style-type: none"> ▲ Carbide, uncoated ▲ ISO N10 S10 K10 O10 ▲ The wear-resistant carbide grade for machining aluminium and other non-ferrous metals
<p>CTCP135-P DRAGONSKIN</p> <ul style="list-style-type: none"> ▲ Carbide, TiCN-Al₂O₃-coated ▲ with wear detection ▲ ISO P35 M25 ▲ The robust alternative for heavily interrupted cutting and variable conditions 	<p>H216T</p> <ul style="list-style-type: none"> ▲ Carbide, uncoated ▲ ISO K15 N15 O10 ▲ The uncoated carbide grade for machining aluminium and other non-ferrous metals ▲ Also highly suitable for HSC machining
<p>CTCM120 DRAGONSKIN</p> <ul style="list-style-type: none"> ▲ Carbide, TiCN-Al₂O₃-coated ▲ ISO P15 M20 ▲ Wear-resistant turning grade for austenitic stainless steel; top performance for smooth cuts 	<p>CWN15</p> <ul style="list-style-type: none"> ▲ Carbide, TiN-coated ▲ ISO M15 K15 ▲ Special carbide grade for abrasive aluminium alloys
<p>CTPM125 DRAGONSKIN</p> <ul style="list-style-type: none"> ▲ ISO P35 M25 ▲ The universal carbide grade with maximum toughness, without affecting the necessary hot hardness and wear resistance for stainless machining 	<p>WUU7610</p> <ul style="list-style-type: none"> ▲ Carbide, uncoated ▲ ISO P10 N10 S10 ▲ Uncoated carbide grades tailored for machining non-ferrous metals
<p>CTCM130 DRAGONSKIN</p> <ul style="list-style-type: none"> ▲ Carbide, TiCN-Al₂O₃-coated ▲ ISO P25 M30 ▲ Robust turning grade for austenitic stainless steel with interrupted cuts 	<p>WUU7620</p> <ul style="list-style-type: none"> ▲ Carbide, uncoated ▲ ISO P20 N20 S20 ▲ Uncoated carbide for steel machining
<p>CTPX710 DRAGONSKIN</p> <ul style="list-style-type: none"> ▲ Carbide, AlTiN-coated ▲ ISO P10 M10 K10 N10 S15 ▲ Universal multi-material grade from the X7 line for highest machining requirements 	<p>WPU7610</p> <ul style="list-style-type: none"> ▲ Carbide, PVD-AlTiN ▲ ISO P10 K10 M10 N10 S10 ▲ Wear-resistant carbide grades for machining stainless steels and super alloys
<p>CTPX715 DRAGONSKIN</p> <ul style="list-style-type: none"> ▲ Carbide, AlTiN-coated ▲ ISO P10 M10 K10 N10 S15 O10 ▲ Universal multi-material grade from the X7 line for highest machining requirements 	<p>WPU7620</p> <ul style="list-style-type: none"> ▲ Carbide, PVD-AlTiN ▲ ISO P20 M20 K20 N20 S20 ▲ Universal, PVD-coated carbide grades for a wide range of applications
<p>CTPP430 DRAGONSKIN</p> <ul style="list-style-type: none"> ▲ Carbide, TiAlN-coated ▲ ISO P30 M25 K30 S25 N25 ▲ The universal high-performance grades for steel, austenitic steel and heat-resistant alloys 	<p>TiAlN+</p> <ul style="list-style-type: none"> ▲ Carbide, TiAlN-coated ▲ ISO P20 M20 K20 N20 S20 ▲ Universal, PVD-coated carbide grades for a wide range of applications
	<p>CWN2120</p> <ul style="list-style-type: none"> ▲ Carbide, TiN coating ▲ ISO K20 N10 ▲ The universal carbide grades for stainless steel and super alloys

Grade description

C T C **P** 1 2 5 (Example)

Main application – material

1 P	Steel
2 M	Stainless steel
3 K	Cast iron
4 N	Light and non ferrous metals
5 S	Super alloys, titanium
6 H	Hard materials
7 X	Universal application

Application

1	Turning
2	Milling
3	Grooving
4	Drilling
5	Thread turning
6	Others
7	Several processes

Degree of hardness

05	ISO 05
10	ISO 10
15	ISO 15
	...

Environmentally friendly, sustainable & cost-effective

Certified recycling of valuable carbide

By deliberately conserving limited primary resources, we aim to significantly increase the proportion of recovered materials using carbide recycling. Our certified recycling process allows us to transform our used carbide products into a reusable powder and, using extremely low amounts of energy, to completely convert the finished product back into its original form.

Join our sustainable material cycle

As part of our long-term partnership, we hope that we can together complete the cycle from the secondary raw material to a new finished product. Send us your used carbide. We will then process it in the approved manner. The price we offer for the returned carbide is always based on the current market price. Best of all: We take care of the entire process for you and also provide free, quantity-specific collection containers and transport solutions. Do you want to conserve valuable resources and make an important contribution to protecting the environment together with us? If so, our recycling process is just what you need.



Table of contents

Advantages of EcoCut	172+173
Example applications / explanation of symbols	173
Toolfinder	174+175
Product programme	176–187
Technical Information	
General cutting data	186
EcoCut Mini Cutting Data	188+189
EcoCut Classic Cutting Data	190+191
EcoCut ProfileMaster Cutting Data	192+193
EcoCut chip breaker overview	194
Application information	195–200
Designation System	201
Grade overview and application	202+203

CERATIZIT \ Performance

Premium quality tools for high performance.

The premium quality tools from the **CERATIZIT Performance** product line have been designed for specific applications and are distinguished by their outstanding performance. If you make high demands on the performance of your production and want to achieve the very best results, we recommend the Premium tools in this product line.

Advantages of EcoCut

- ▲ reduced machining time
- ▲ reduced need for tool positions
- ▲ generates flat bottom of hole
- ▲ less programming
- ▲ lower set-up costs / reduced setting time
- ▲ time savings due to fewer tool changes

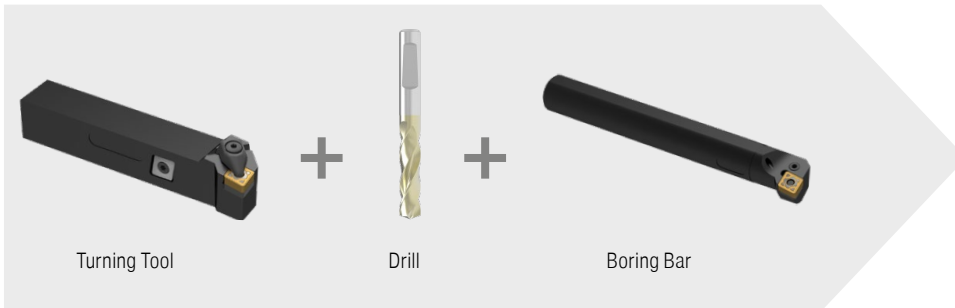

Application examples

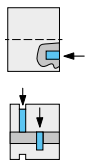
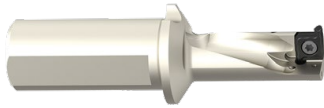

EcoCut ProfileMaster

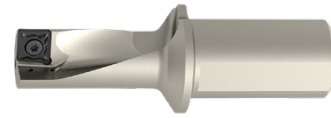

EcoCut Classic

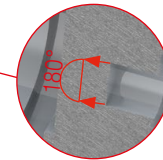
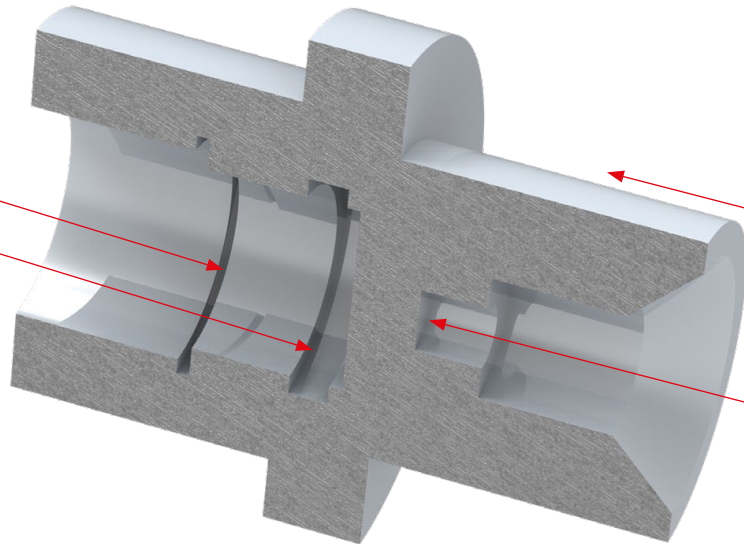

EcoCut Mini

Symbol explanation



Turning outside profiles



Drilling into full material



Turning internal profiles



External / internal radial grooving



Axial grooving













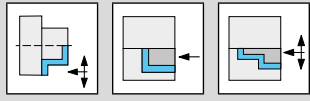
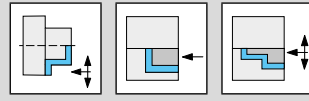
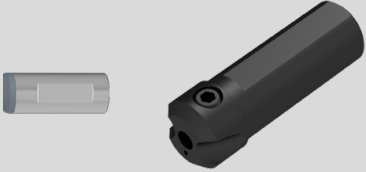





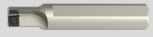
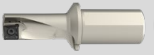



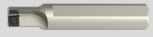
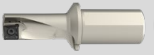





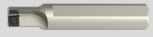
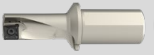

















































Int. coolant supply

-27P — Polished chip breaker
H216T — Carbide Grade

F Fine Machining
M Medium Machining
R Rough Machining

○ ○ ○
○ ○ ○
○ ○ ○
Smooth cut
Irregular cutting depth
Interrupted cut

Toolfinder

Tool system	<h2>EcoCut Mini</h2>	<h2>EcoCut Classic</h2>																																																												
Application																																																														
Machine interface	 <p style="text-align: right;">→ 177-178</p> <p style="text-align: center;">Adapter for EcoCut Mini</p>	 <p style="text-align: right;">HSK-T 63</p> 																																																												
Lengths and diameters Versions	<table style="width: 100%; text-align: center;"> <tr> <td>2,25xD Ø 2-8</td> <td>4,0xD Ø 2-8</td> </tr> <tr> <td></td> <td></td> </tr> <tr> <td>→ 176</td> <td>→ 176</td> </tr> </table>	2,25xD Ø 2-8	4,0xD Ø 2-8			→ 176	→ 176	<table style="width: 100%; text-align: center;"> <tr> <td>1,5xD Ø 8-32</td> <td>2,25xD Ø 8-32</td> <td>3,0xD Ø 8-32</td> <td>2,25xD Ø 25-32</td> </tr> <tr> <td></td> <td></td> <td></td> <td></td> </tr> <tr> <td>→ 180</td> <td>→ 181</td> <td>→ 182</td> <td></td> </tr> </table>	1,5xD Ø 8-32	2,25xD Ø 8-32	3,0xD Ø 8-32	2,25xD Ø 25-32					→ 180	→ 181	→ 182																																											
2,25xD Ø 2-8	4,0xD Ø 2-8																																																													
																																																														
→ 176	→ 176																																																													
1,5xD Ø 8-32	2,25xD Ø 8-32	3,0xD Ø 8-32	2,25xD Ø 25-32																																																											
																																																														
→ 180	→ 181	→ 182																																																												
Cutting material designation	<table style="width: 100%; text-align: center;"> <tr> <td>CTPP435</td> <td>CTPP435</td> <td>CTWN425</td> <td>CTWN425</td> </tr> </table>	CTPP435	CTPP435	CTWN425	CTWN425	<table style="width: 100%; text-align: center;"> <tr> <td>CTCP425</td> <td>-M50Q CTCP425</td> <td>CTCP435</td> <td>CTPP430</td> <td>-27P H216T</td> <td>-27Q H210T</td> </tr> </table>	CTCP425	-M50Q CTCP425	CTCP435	CTPP430	-27P H216T	-27Q H210T																																																		
CTPP435	CTPP435	CTWN425	CTWN425																																																											
CTCP425	-M50Q CTCP425	CTCP435	CTPP430	-27P H216T	-27Q H210T																																																									
Cutting conditions	<table style="width: 100%; text-align: center;"> <tr> <td colspan="2">DRAGONSKIN</td> <td colspan="2">DRAGONSKIN</td> </tr> <tr> <td></td> <td></td> <td></td> <td></td> </tr> <tr> <td></td> <td></td> <td></td> <td></td> </tr> <tr> <td>Solid carbide</td> <td>Solid carbide</td> <td>Solid carbide</td> <td>Solid carbide</td> </tr> <tr> <td>Left-hand</td> <td>Right-hand</td> <td>Left-hand</td> <td>Right-hand</td> </tr> </table>	DRAGONSKIN		DRAGONSKIN										Solid carbide	Solid carbide	Solid carbide	Solid carbide	Left-hand	Right-hand	Left-hand	Right-hand	<table style="width: 100%; text-align: center;"> <tr> <td colspan="2">DRAGONSKIN</td> <td colspan="2">DRAGONSKIN</td> <td colspan="2">DRAGONSKIN</td> </tr> <tr> <td></td> <td></td> <td></td> <td></td> <td></td> <td></td> </tr> <tr> <td></td> <td></td> <td></td> <td></td> <td></td> <td></td> </tr> <tr> <td>M</td> <td>M</td> <td>M</td> <td>M</td> <td>M</td> <td>M</td> </tr> <tr> <td>XCNT</td> <td>XCNT</td> <td>XCNT</td> <td>XCNT</td> <td>XCET</td> <td>XCET</td> </tr> </table>	DRAGONSKIN		DRAGONSKIN		DRAGONSKIN														M	M	M	M	M	M	XCNT	XCNT	XCNT	XCNT	XCET	XCET										
DRAGONSKIN		DRAGONSKIN																																																												
																																																														
																																																														
Solid carbide	Solid carbide	Solid carbide	Solid carbide																																																											
Left-hand	Right-hand	Left-hand	Right-hand																																																											
DRAGONSKIN		DRAGONSKIN		DRAGONSKIN																																																										
																																																														
																																																														
M	M	M	M	M	M																																																									
XCNT	XCNT	XCNT	XCNT	XCET	XCET																																																									
Application range	<table style="width: 100%; text-align: center;"> <tr><td>●</td><td>●</td><td></td><td></td></tr> <tr><td>●</td><td>●</td><td></td><td></td></tr> <tr><td>○</td><td>○</td><td>○</td><td>○</td></tr> <tr><td>○</td><td>○</td><td>●</td><td>●</td></tr> <tr><td>●</td><td>●</td><td>○</td><td>○</td></tr> <tr><td>○</td><td>○</td><td>○</td><td>○</td></tr> </table>	●	●			●	●			○	○	○	○	○	○	●	●	●	●	○	○	○	○	○	○	<table style="width: 100%; text-align: center;"> <tr><td>●</td><td>●</td><td>●</td><td>●</td><td></td><td></td></tr> <tr><td>○</td><td>○</td><td>○</td><td>●</td><td></td><td></td></tr> <tr><td>○</td><td>○</td><td>○</td><td>○</td><td>●</td><td>○</td></tr> <tr><td>○</td><td>○</td><td></td><td>○</td><td>●</td><td>●</td></tr> <tr><td></td><td></td><td>○</td><td>○</td><td>○</td><td>●</td></tr> <tr><td>○</td><td>○</td><td>○</td><td>○</td><td>○</td><td>○</td></tr> </table>	●	●	●	●			○	○	○	●			○	○	○	○	●	○	○	○		○	●	●			○	○	○	●	○	○	○	○	○	○
●	●																																																													
●	●																																																													
○	○	○	○																																																											
○	○	●	●																																																											
●	●	○	○																																																											
○	○	○	○																																																											
●	●	●	●																																																											
○	○	○	●																																																											
○	○	○	○	●	○																																																									
○	○		○	●	●																																																									
		○	○	○	●																																																									
○	○	○	○	○	○																																																									
Page No.	<p style="text-align: center;">→ 176 → 176 → 176 → 176</p> <p style="text-align: right;">→ v. Page 187</p>	<p style="text-align: center;">→ 179 → 179 → 179 → 179 → 179 → 179</p> <p style="text-align: right;">→ v. Page 187</p>																																																												

 EcoCut tools are suitable for off-centre drilling. This permits certain deviations from the nominal tool diameter to be achieved
→ For details, see the technical information.

EcoCut ProfileMaster

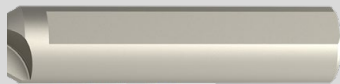
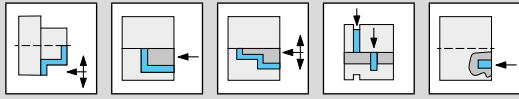

1,5xD
Ø 10-32

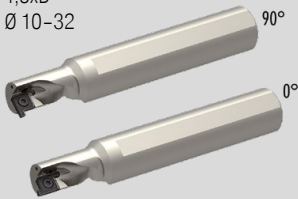

→ 184

2,25xD
Ø 10-32

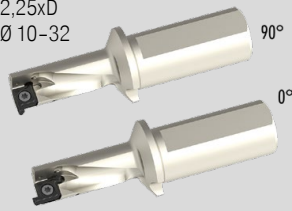

→ 185

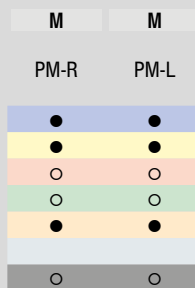
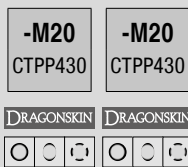

→ 183

→ 183

→ v. Page 187

EcoCut – Mini

▲ Drilling and turning tool for small diameters

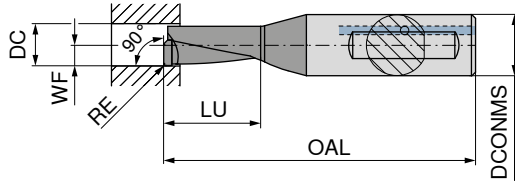
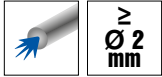

Illustrations show right-hand versions

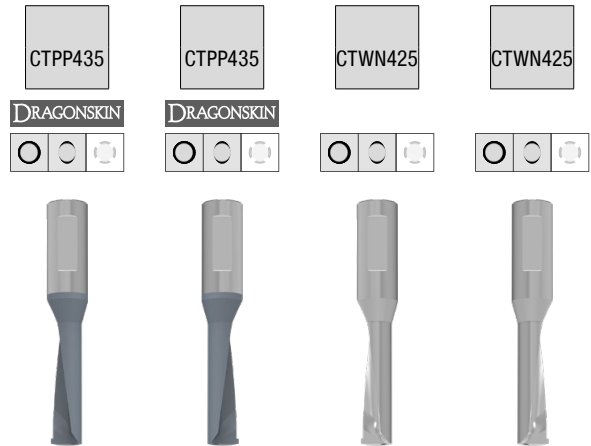

	Solid carbide Left-hand 70 805 ...	Solid carbide Right-hand 70 804 ...	Solid carbide Left-hand 70 805 ...	Solid carbide Right-hand 70 804 ...
ECM 02 R/L 2,25D	320	320		
ECM 02 R/L 2,25D AL			420	420
ECM 02 R/L 4,00D	321	321		
ECM 02 R/L 4,00D AL			421	421
ECM 02,5 R/L 2,25D	325	325		
ECM 02,5 R/L 2,25D AL			425	425
ECM 02,5 R/L 4,00D	326	326		
ECM 02,5 R/L 4,00D AL			426	426
ECM 03 R/L 2,25D	330	330		
ECM 03 R/L 2,25D AL			430	430
ECM 03 R/L 4,00D	331	331		
ECM 03 R/L 4,00D AL			431	431
ECM 03,5 R/L 2,25D	335	335		
ECM 03,5 R/L 2,25D AL			435	435
ECM 03,5 R/L 4,00D	336	336		
ECM 03,5 R/L 4,00D AL			436	436
ECM 04 R/L 2,25D	300	300		
ECM 04 R/L 2,25D AL			450	450
ECM 04 R/L 4,00D	301	301		
ECM 04 R/L 4,00D AL			451	451
ECM 05 R/L 2,25D	302	302		
ECM 05 R/L 2,25D AL			452	452
ECM 05 R/L 4,00D	303	303		
ECM 05 R/L 4,00D AL			453	453
ECM 06 R/L 2,25D	306	306		
ECM 06 R/L 2,25D AL			456	456
ECM 06 R/L 4,00D	312	312		
ECM 06 R/L 4,00D AL			462	462
ECM 07 R/L 2,25D	308	308		
ECM 07 R/L 2,25D AL			458	458
ECM 07 R/L 4,00D	314	314		
ECM 07 R/L 4,00D AL			464	464
ECM 08 R/L 2,25D	310	310		
ECM 08 R/L 2,25D AL			460	460
ECM 08 R/L 4,00D	316	316		
ECM 08 R/L 4,00D AL			466	466

P	●	●		
M	●	●		
K	○	○	○	○
N	○	○	●	●
S	●	●	○	○
H				
O	○	○	○	○

EcoCut – Adapter Mini

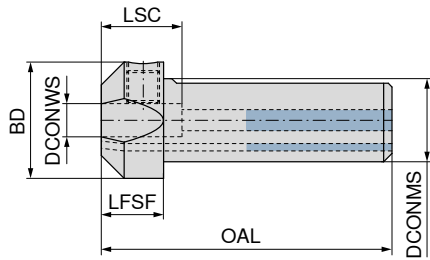

70 800 ...

Designation	DCONWS mm	DCONMS mm	BD mm	OAL mm	LFSF mm	LSC mm	
EC-ADX16-04	4	16.00	22	59.0	14	18	716
EC-ADX12-04-E	4	19.05	25	63.5	14	18	719
EC-ADX20-04	4	20.00	25	64.0	14	18	720
EC-ADX16-06	6	16.00	22	59.0	14	18	976
EC-ADX12-06-E	6	19.05	25	63.5	14	18	986
EC-ADX20-06	6	20.00	25	64.0	14	18	996
EC-ADX16-08	8	16.00	22	59.0	14	18	978
EC-ADX12-08-E	8	19.05	25	63.5	14	18	988
EC-ADX20-08	8	20.00	25	64.0	14	18	998

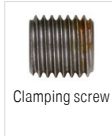

70 950 ...

Spare parts for Article no.		
70 800 716	M5x10 ISO 4026	867
70 800 719	M5x10 ISO 4026	867
70 800 720	M5x10 ISO 4026	867
70 800 976	M8x1x8 – SW4	123
70 800 986	M8x1x8 – SW4	123
70 800 996	M8x1x8 – SW4	123
70 800 978	M8x1x8 – SW4	123
70 800 988	M8x1x8 – SW4	123
70 800 998	M8x1x8 – SW4	123

EcoCut – Mini adapter with coolant connection thread

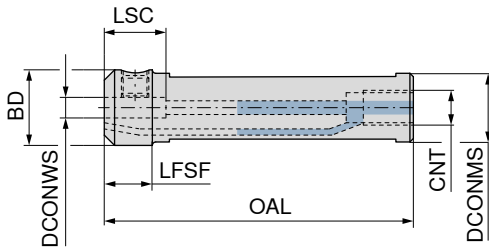

70 801 ...

Designation	DCONWS mm	DCONMS mm	BD mm	OAL mm	LFSF mm	LSC mm	Thread	
ECA 16-04	4	16.00	20.0	75	14	18	G 1/8	716
ECA 0750-04	4	19.05	20.0	100	14	18	G 1/8	719
ECA 20-04	4	20.00	19.6	90	14	18	G 1/8	720
ECA 22-04	4	22.00	21.6	110	14	18	G 1/8	722
ECA 25-04	4	25.00	24.6	110	14	18	G 1/8	725
ECA 1000-04	4	25.40	25.0	110	14	18	G 1/8	726
ECA 16-06	6	16.00	22.0	75	14	18	G 1/8	816
ECA 0750-06	6	19.05	22.0	100	14	18	G 1/8	819
ECA 20-06	6	20.00	22.0	90	14	18	G 1/8	820
ECA 22-06	6	22.00	21.6	110	14	18	G 1/8	822
ECA 25-06	6	25.00	24.6	110	14	18	G 1/8	825
ECA 1000-06	6	25.40	25.0	110	14	18	G 1/8	826
ECA 16-08	8	16.00	22.0	75	14	18	G 1/8	916
ECA 0750-08	8	19.05	22.0	100	14	18	G 1/8	919
ECA 20-08	8	20.00	22.0	90	14	18	G 1/8	920
ECA 22-08	8	22.00	21.6	110	14	18	G 1/8	922
ECA 25-08	8	25.00	24.6	110	14	18	G 1/8	925
ECA 1000-08	8	25.40	25.0	110	14	18	G 1/8	926



70 950 ...

Spare parts for Article no.		
70 801 716	M5X8 – DIN 913	13200
70 801 719	M5X8 – DIN 913	13200
70 801 720	M5X8 – DIN 913	13200
70 801 722	M5X8 – DIN 913	13200
70 801 725	M5x10 ISO 4026	867
70 801 726	M5x10 ISO 4026	867
70 801 816	M8x1x8 – SW4	123
70 801 819	M8x1x8 – SW4	123
70 801 820	M8x1x8 – SW4	123
70 801 822	M8x1x8 – SW4	123
70 801 825	M8x1x8 – SW4	123
70 801 826	M8x1x8 – SW4	123
70 801 916	M8x1x8 – SW4	123
70 801 919	M8x1x8 – SW4	123
70 801 920	M8x1x8 – SW4	123
70 801 922	M8x1x8 – SW4	123
70 801 925	M8x1x8 – SW4	123
70 801 926	M8x1x8 – SW4	123

XCNT / XCET

Designation	S mm	D1 mm	IC mm
XC.T 0401..	1.80	2.10	4.5
XC.T 0502..	2.10	2.25	5.8
XC.T 0602..	2.38	2.50	6.5
XC.T 0703..	3.18	2.80	7.6
XC.T 0803..	3.18	3.40	8.5

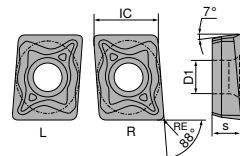

XC. T 04..

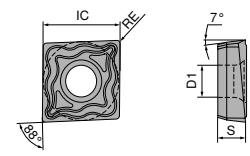

XC. T 05../06../07../08../09../10../13../17..

XCNT / XCET

ISO	RE mm	CTCP425		-M50Q CTCP425		CTCP435		CTPP430		-27P H216T		-27Q H210T	
		DRAGONS KIN	DRAGONS KIN	DRAGONS KIN	DRAGONS KIN	DRAGONS KIN	DRAGONS KIN	DRAGONS KIN	DRAGONS KIN	DRAGONS KIN	DRAGONS KIN	DRAGONS KIN	DRAGONS KIN
		M	M	M	M	M	M	M	M	M	M	M	M
		XCNT	XCNT	XCNT	XCNT	XCET	XCET	XCNT	XCET	XCNT	XCET	XCNT	XCET
		70 386 ...	70 386 ...	70 386 ...	70 386 ...	70 286 ...	70 286 ...	70 386 ...	70 386 ...	70 286 ...	70 286 ...	70 386 ...	70 286 ...
040102EL	0.2	720		820	920								
040102ER	0.2	722		822	922								
040102FL	0.2					620	120			622	122		
040102FR	0.2												
040104EL	0.4	700	750	800	900								
040104ER	0.4	702	752	802	902								
040104FL	0.4					600	100			602	102		
040104FR	0.4												
050202EN	0.2	723		823	923								
050202FN	0.2					623	123						
050204EN	0.4	703	753	803	903					603	103		
050204FN	0.4												
060202EN	0.2	724		824	924								
060202FN	0.2					624	124						
060204EN	0.4	704	754	804	904					604	104		
060204FN	0.4												
070304EN	0.4	705	755	805	905								
070304FN	0.4					605	105						
080304EN	0.4	706	756	806	906								
080304FN	0.4					606	106						
P		●	●	●	●								
M		○	○	○	○								
K		○	○	○	○	●	○						
N						○	●			○	●		
S				○	○	○	○				○		○
H													
O						○	○			○	○		○

→ v_c Page 187

EcoCut – Classic 1.5xD

▲ Drilling and turning tool

Scope of supply:

Toolholder with 1 clamping screw + 2 spare screws and screwdriver

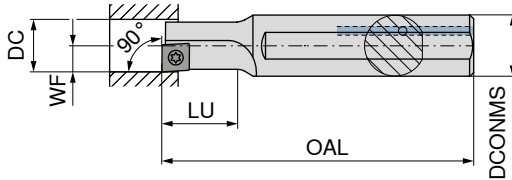

Illustrations show right-hand versions



Left-hand

Right-hand

70 805 ...

70 804 ...

Designation	DC mm	DCONMS mm	OAL mm	LU mm	WF mm	torque moment Nm	Insert		
ECC 08 L 1,5D 04	8	12	80	12	4	0,4	XC.T 0401..EL		008 ²⁾
ECC 08 R 1,5D 04	8	12	80	12	4	0,4	XC.T 0401..ER		008 ¹⁾
ECC 10 R/L 1,5D 05	10	12	90	15	5	0,7	XC.T 0502..	010	010
ECC 12 R/L 1,5D 06	12	16	100	18	6	1,0	XC.T 0602..	012	012
ECC 14 R/L 1,5D 07	14	16	110	21	7	1,2	XC.T 0703..	014	014
ECC 16 R/L 1,5D 08	16	20	125	24	8	2,2	XC.T 0803..	016	016

1) Note! Right-hand insert on right-hand tool

2) Note! Left-hand insert on left-hand tool

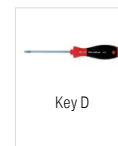

Key D

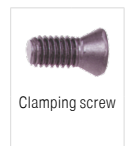

Clamping screw

80 950 ...

70 950 ...

Spare parts for Article no.

70 805 008	T06 - IP	123	M1,8x3,6 - IP	862
70 804 008	T06 - IP	123	M1,8x3,6 - IP	862
70 805 010 / 70 804 010	T06 - IP	123	M2x4,3 - IP	863
70 805 012 / 70 804 012	T07 - IP	124	M2,2x5 - IP	856
70 805 014 / 70 804 014	T08 - IP	125	M2,5x6 - IP	857
70 805 016 / 70 804 016	T09 - IP	126	M3x7 - IP	819

EcoCut – Classic 2.25xD

▲ Drilling and turning tool

Scope of supply:

Toolholder with 1 clamping screw + 2 spare screws and screwdriver

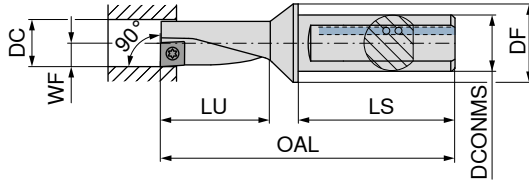
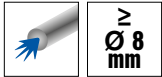

Illustrations show right-hand versions

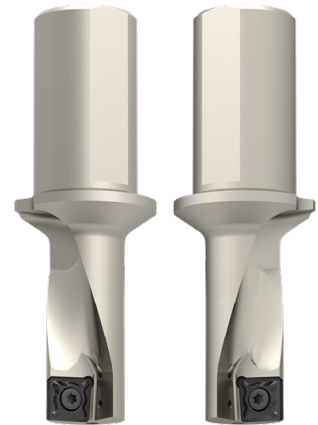

Left-hand **70 805 ...** Right-hand **70 804 ...**

Designation	DC mm	DCONMS mm	DF mm	OAL mm	LU mm	LS mm	WF mm	torque moment Nm	Insert		
ECC 08 L 2,25D 04	8	10	12	60.0	18.0	38	4	0,4	XC.T 0401..EL	108 ²⁾	
ECC 08 R 2,25D 04	8	10	12	60.0	18.0	38	4	0,4	XC.T 0401..ER		108 ¹⁾
ECC 10 R/L 2,25D 05	10	12	16	69.5	22.5	42	5	0,7	XC.T 0502..	110	110
ECC 12 R/L 2,25D 06	12	16	20	78.0	27.0	45	6	1,0	XC.T 0602..	112	112
ECC 14 R/L 2,25D 07	14	16	20	83.5	31.5	45	7	1,2	XC.T 0703..	114	114
ECC 16 R/L 2,25D 08	16	20	25	94.0	36.0	50	8	2,2	XC.T 0803..	116	116

1) Note! Right-hand insert on right-hand tool
2) Note! Left-hand insert on left-hand tool

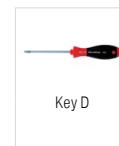

80 950 ...

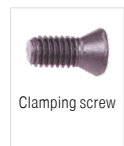

70 950 ...

Spare parts for Article no.

70 805 108	T06 - IP	123	M1,8x3,6 - IP	862
70 804 108	T06 - IP	123	M1,8x3,6 - IP	862
70 805 110 / 70 804 110	T06 - IP	123	M2x4,3 - IP	863
70 805 112 / 70 804 112	T07 - IP	124	M2,2x5 - IP	856
70 805 114 / 70 804 114	T08 - IP	125	M2,5x6 - IP	857
70 805 116 / 70 804 116	T09 - IP	126	M3x7 - IP	819

EcoCut – Classic 3xD – Heavy metal

- ▲ Drilling and turning tool
- ▲ vibration-damped

Scope of supply:

Toolholder with 1 clamping screw + 2 spare screws and screwdriver

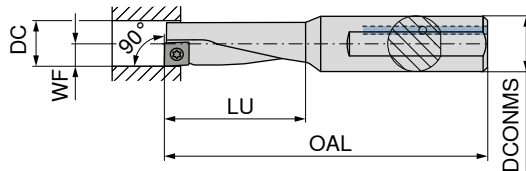
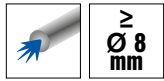

Illustrations show right-hand versions

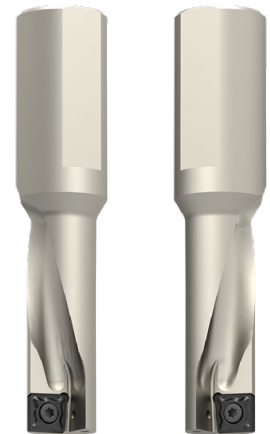

Designation	DC mm	DCONMS mm	OAL mm	LU mm	WF mm	torque moment Nm	Insert		
								70 805 ...	70 804 ...
ECC 08 L 3,00D 04 H	8	12	80	24	4	0,4	XC.T 0401..EL	608 ²⁾	
ECC 08 R 3,00D 04 H	8	12	80	24	4	0,4	XC.T 0401..ER		608 ¹⁾
ECC 10 R/L 3,00D 05 H	10	12	85	30	5	0,7	XC.T 0502..	610	610
ECC 12 R/L 3,00D 06 H	12	16	95	36	6	1,0	XC.T 0602..	612	612
ECC 14 R/L 3,00D 07 H	14	16	100	42	7	1,2	XC.T 0703..	614	614
ECC 16 R/L 3,00D 08 H	16	20	110	48	8	2,2	XC.T 0803..	616	616

- 1) Note! Right-hand insert on right-hand tool
- 2) Note! Left-hand insert on left-hand tool

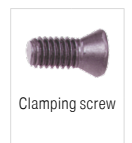
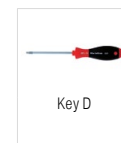

**Spare parts
for Article no.**

		80 950 ...		70 950 ...
70 805 608	T06 - IP	123	M1,8x3,6 - IP	862
70 804 608	T06 - IP	123	M1,8x3,6 - IP	862
70 805 610 / 70 804 610	T06 - IP	123	M2x4,3 - IP	863
70 805 612 / 70 804 612	T07 - IP	124	M2,2x5 - IP	856
70 805 614 / 70 804 614	T08 - IP	125	M2,5x6 - IP	857
70 805 616 / 70 804 616	T09 - IP	126	M3x7 - IP	819

PM-R / PM-L

Designation	CW mm	PDPT mm	L mm	S mm	D1 mm
PM 10 G 201504	2.0	1.5	5	2.10	2.1
PM 12 G 201804	2.0	1.8	6	2.30	2.5
PM 16 G 252004	2.5	2.0	8	2.80	3.4

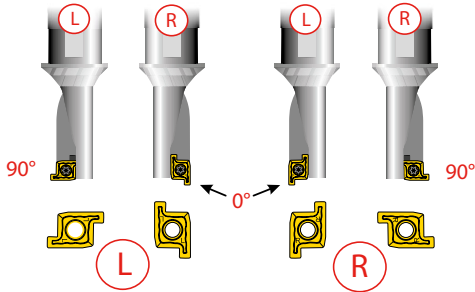
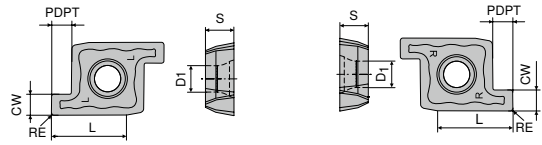

PM-L / PM-R

ISO	RE mm
PM 10 G 201504	0.4
PM 12 G 201804	0.4
PM 16 G 252004	0.4
P	
M	
K	
N	
S	
H	
O	

-M20 CTPP430	-M20 CTPP430
DRAGONSKIN	DRAGONSKIN
M PM-L	M PM-R
70 289 ...	70 289 ...
510	511
515	516
520	521
●	●
●	●
○	○
○	○
●	●
○	○

→ v_c Page 187

EcoCut – ProfileMaster 1.5xD

▲ Drilling, turning and grooving tool

Scope of supply:

Toolholder with one clamping screw and one screwdriver

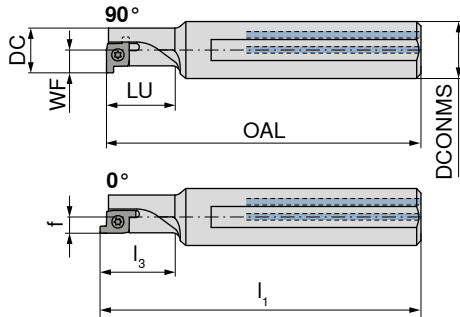
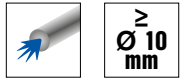

Illustrations show right-hand versions



Designation	DC mm	DCONMS mm	OAL mm	LU mm	WF mm	I ₁ mm	I ₃ mm	f mm	torque moment Nm	Insert	Left-hand	Right-hand
											70 821 ...	70 820 ...
PMC 10 R/L 1,5D	10	12	80	15	5				0,4	PM 10R/L	010 ¹⁾	010 ¹⁾
PMC 12 R/L 1,5D	12	16	90	18	6				1,0	PM 12R/L	012 ¹⁾	012 ¹⁾
PMC 16 R/L 1,5D	16	20	125	24	8	127.3	26.3	5.7	2,2	PM 16R/L	016	016

1) only usable as 90° version

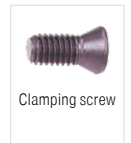
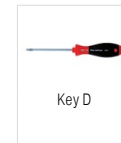

Spare parts

		80 950 ...		70 950 ...
70 820 010 / 70 821 010	T06 - IP	123	M1,8x3,6 - IP	862
70 820 012 / 70 821 012	T07 - IP	124	M2,2x4,2 - IP	137
70 820 016 / 70 821 016	T09 - IP	126	M3x5,7 - IP	008

EcoCut – ProfileMaster 2.25xD

▲ Drilling, turning and grooving tool

Scope of supply:

Toolholder with one clamping screw and one screwdriver

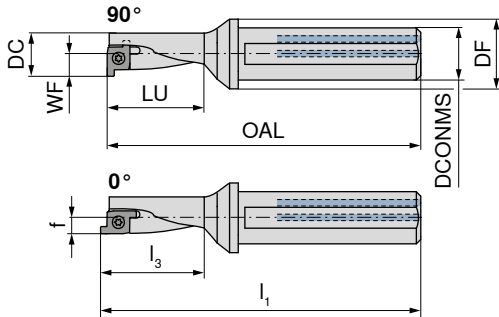
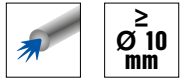

Illustrations show right-hand versions



Designation	DC mm	DCONMS mm	DF mm	OAL mm	LU mm	WF mm	I ₁ mm	I ₃ mm	f mm	torque moment Nm	Insert	Left-hand	Right-hand
												70 821 ...	70 820 ...
PMC 10 R/L 2,25D	10	12	18	72.4	22.5	5				0,4	PM 10R/L	110 ¹⁾	110 ¹⁾
PMC 12 R/L 2,25D	12	16	22	78.0	27.0	6				1,0	PM 12R/L	112 ¹⁾	112 ¹⁾
PMC 16 R/L 2,25D	16	20	28	96.5	36.0	8	98.8	38.3	5.7	2,2	PM 16R/L	116	116

1) only usable as 90° version

Spare parts

		80 950 ...		70 950 ...
70 820 110 / 70 821 110	T06 - IP	123	M1,8x3,6 - IP	862
70 820 112 / 70 821 112	T07 - IP	124	M2,2x4,2 - IP	137
70 820 116 / 70 821 116	T09 - IP	126	M3x5,7 - IP	008

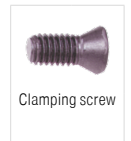
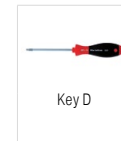

Material examples for cutting data tables

	Material sub-group	Index	Composition / Structure / Heat treatment	Tensile strength N/mm ² / HB / HRC	Material number	Material designation	Material number	Material designation
P	Unalloyed steel	P.1.1	< 0,15 % C Annealed	420 N/mm ² / 125 HB	1.0401	C15	1.1141	Ck15
		P.1.2	< 0,45 % C Annealed	640 N/mm ² / 190 HB	1.1191	C45E	1.0718	9SMnPb28
		P.1.3	< 0,45 % C Tempered	840 N/mm ² / 250 HB	1.1191	C45E	1.0535	C55
		P.1.4	< 0,75 % C Annealed	910 N/mm ² / 270 HB	1.1223	C60R	1.0535	C55
		P.1.5	< 0,75 % C Tempered	1010 N/mm ² / 300 HB	1.1223	C60R	1.0727	45S20
	Low-alloy steel	P.2.1	Annealed	610 N/mm ² / 180 HB	1.7131	16MnCr5	1.6587	17CrNiMo6
		P.2.2	Tempered	930 N/mm ² / 275 HB	1.7131	16MnCr5	1.6587	17CrNiMo6
		P.2.3	Tempered	1010 N/mm ² / 300 HB	1.7225	42CrMo4	1.3505	100Cr6
		P.2.4	Tempered	1200 N/mm ² / 375 HB	1.7225	42CrMo4	1.3505	100Cr6
	High-alloy steel and high-alloy tool steel	P.3.1	Annealed	680 N/mm ² / 200 HB	1.4021	X20Cr13	1.4034	X46Cr13
		P.3.2	Hardened and tempered	1100 N/mm ² / 300 HB	1.2343	X38CrMoV5-1	1.4034	X46Cr13
		P.3.3	Hardened and tempered	1300 N/mm ² / 400 HB	1.2343	X38CrMoV5-1	1.4034	X46Cr13
	Stainless steel	P.4.1	Ferritic / martensitic Annealed	680 N/mm ² / 200 HB	1.4016	X6Cr17	1.2316	X36CrMo16
		P.4.2	Martensitic Tempered	1010 N/mm ² / 300 HB	1.4112	X90CrMoV18	1.2316	X36CrMo16
M	Stainless steel	M.1.1	Austenitic / austenitic-ferritic Quenched	610 N/mm ² / 180 HB	1.4301	X5CrNi18-10	1.4571	X6CrNiMoTi17-12-2
		M.2.1	Austenitic Tempered	300 HB	1.4841	X15CrNiSi25-21	1.4539	X1NiCrMoCu25-20-5
		M.3.1	Austenitic / ferritic (Duplex)	780 N/mm ² / 230 HB	1.4462	X2CrNiMoN22-5-3	1.4501	X2CrNiMoCuWN25-7-4
K	Grey cast iron	K.1.1	Pearlitic / ferritic	350 N/mm ² / 180 HB	0.6010	GG-10	0.6025	GG-25
		K.1.2	Pearlitic (martensitic)	500 N/mm ² / 260 HB	0.6030	GG-30	0.6045	GG-45
	Spherulitic graphite cast iron	K.2.1	Ferritic	540 N/mm ² / 160 HB	0.7040	GGG-40	0.7060	GGG-60
		K.2.2	Pearlitic	845 N/mm ² / 250 HB	0.7070	GGG-70	0.7080	GGG-80
	Malleable iron	K.3.1	Ferritic	440 N/mm ² / 130 HB	0.8035	GTW-35-04	0.8045	GTW-45
		K.3.2	Pearlitic	780 N/mm ² / 230 HB	0.8165	GTS-65-02	0.8170	GTS-70-02
N	Aluminium wrought alloy	N.1.1	Non-hardenable	60 HB	3.0255	Al99,5	3.3315	AlMg1
		N.1.2	Hardenable Age-hardened	340 N/mm ² / 100 HB	3.1355	AlCuMg2	3.2315	AlMgSi1
	Cast aluminium alloy	N.2.1	≤ 12 % Si, non-hardenable	250 N/mm ² / 75 HB	3.2581	G-AlSi12	3.2163	G-AlSi9Cu3
		N.2.2	≤ 12 % Si, hardenable Age-hardened	300 N/mm ² / 90 HB	3.2134	G-AlSi5Cu1Mg	3.2373	G-AlSi9Mg
		N.2.3	> 12 % Si, non-hardenable	440 N/mm ² / 130 HB		G-AlSi17Cu4Mg		G-AlSi18CuNiMg
	Copper and copper alloys (bronze/brass)	N.3.1	Free-machining alloys, PB > 1 %	375 N/mm ² / 110 HB	2.0380	CuZn39Pb2 (Ms58)	2.0410	CuZn44Pb2
		N.3.2	CuZn, CuSnZn	300 N/mm ² / 90 HB	2.0331	CuZn15	2.4070	CuZn28Sn1As
		N.3.3	CuSn, lead-free copper and electrolytic copper	340 N/mm ² / 100 HB	2.0060	E-Cu57	2.0590	CuZn40Fe
	Magnesium alloys	N.4.1	Magnesium and magnesium alloys	70 HB	3.5612	MgAl6Zn	3.5312	MgAl3Zn
	S	Heat-resistant alloys	S.1.1	Fe - basis Annealed	680 N/mm ² / 200 HB	1.4864	X12NiCrSi 36-16	1.4865
S.1.2			Fe - basis Age-hardened	950 N/mm ² / 280 HB	1.4980	X6NiCrTiMoVB25-15-2	1.4876	X10NiCrAlTi32-20
S.2.1			Ni or Co basis Annealed	840 N/mm ² / 250 HB	2.4631	NiCr20TiAl (Nimonic80A)	3.4856	NiCr22Mo9Nb
S.2.2			Ni or Co basis Age-hardened	1180 N/mm ² / 350 HB	2.4668	NiCr19Nb5Mo3 (Inconel 718)	2.4955	NiFe25Cr20NbTi
S.2.3			Ni or Co basis Cast	1080 N/mm ² / 320 HB	2.4765	CoCr20W15Ni	1.3401	G-X120Mn12
Titanium alloys		S.3.1	Pure titanium	400 N/mm ²	3.7025	Ti99,8	3.7034	Ti99,7
		S.3.2	Alpha + beta alloys Age-hardened	1050 N/mm ² / 320 HB	3.7165	TiAl6V4	Ti-6246	Ti-6Al-2Sn-4Zr-6Mo
		S.3.3	Beta alloys	1400 N/mm ² / 410 HB	Ti555.3	Ti-5Al-5V-5Mo-3Cr	R56410	Ti-10V-2Fe-3Al
H	Hardened steel	H.1.1	Hardened and tempered	46-55 HRC				
		H.1.2	Hardened and tempered	56-60 HRC				
		H.1.3	Hardened and tempered	61-65 HRC				
		H.1.4	Hardened and tempered	66-70 HRC				
	Chilled iron	H.2.1	Cast	400 HB				
	Hardened cast iron	H.3.1	Hardened and tempered	55 HRC				
O	Non-metal materials	O.1.1	Plastics, duroplastic	≤ 150 N/mm ²				
		O.1.2	Plastics, thermoplastic	≤ 100 N/mm ²				
		O.2.1	Aramid fibre-reinforced	≤ 1000 N/mm ²				
		O.2.2	Glass/carbon-fibre reinforced	≤ 1000 N/mm ²				
		O.3.1	Graphite					

* Tensile strength

Cutting data standard values for EcoCut

	DRAGONSKIN		DRAGONSKIN		DRAGONSKIN		DRAGONSKIN	
	EcoCut Mini CTWN425	EcoCut Mini CTPP435	EcoCut Classic CTCF425	EcoCut Classic CTCF435	EcoCut Classic CTPP430	EcoCut Classic H210T	EcoCut Classic H216T	EcoCut ProfileMaster CTPP430
Index	v _c in m/min							
P.1.1		146	227	208	182			168
P.1.2		125	197	179	156			141
P.1.3		106	169	151	132			115
P.1.4		100	160	142	124			106
P.1.5		90	146	128	112			94
P.2.1		128	202	183	160			145
P.2.2		98	158	140	122			104
P.2.3		90	146	128	112			94
P.2.4		67	112	94	82			61
P.3.1		104	156	143	116			112
P.3.2		67	113	98	86			76
P.3.3		31	70	53	56			39
P.4.1		104	156	143	116			112
P.4.2		86	134	120	101			94
M.1.1		104	156	143	116			112
M.2.1		67			86			76
M.3.1		93			107			102
K.1.1	140	140	205	185	160	110	170	180
K.1.2	115	120	205	185	140	90	130	260
K.2.1	150	140	200	180	160	120	180	160
K.2.2	110	120	200	180	140	85	130	250
K.3.1	170	150	195	175	125	140	190	130
K.3.2	140	125	195	175	110	110	160	230
N.1.1	300	40			40	40	60	300
N.1.2	50	290			290	290	310	200
N.2.1	300	290			290	290	60	300
N.2.2	300	190			190	190	460	200
N.2.3	450	340			340	340	60	150
N.3.1	350	240			240	240	460	300
N.3.2	350	240			240	240	460	300
N.3.3	250	190			190	190	360	200
N.4.1	200	140			140	140	260	200
S.1.1	38	35		35	55	33	43	35
S.1.2	28	30		30	55	25	33	30
S.2.1	28	18		18	55	25	33	20
S.2.2	24	15		15	55	20	25	15
S.2.3	20	15		15	55	20	20	15
S.3.1	90	85		85	70	65	110	85
S.3.2	55	40		40	60	43	70	40
S.3.3	40	30		30	40	30	50	30
H.1.1								
H.1.2								
H.1.3								
H.1.4								
H.2.1								
H.3.1								
O.1.1	130	110			110	110	155	130
O.1.2								
O.2.1	105	95			95	95	140	105
O.2.2								
O.3.1								

 The cutting data is strongly influenced by external conditions, such as the stability of the tool and workpiece clamping, material and type of machine. The specified values represent guideline cutting data that can be adjusted by approx. ±20% according to the usage conditions.

Depth of Cut and Feedrate for EcoCut Mini

Turning

2.25xD

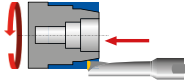

EcoCut Mini Size	Depth of Cut a_p in mm									
	0,25	0,5	0,75	1,0	1,5	2,0	2,5	3,0	3,5	4,0
Feed rate f in mm/rev.										
ECM 02..	0,02-0,07	0,02-0,07								
ECM 02,5..	0,02-0,07	0,02-0,07	0,02-0,05							
ECM 03..	0,02-0,07	0,02-0,07	0,02-0,05	0,02-0,05						
ECM 03,5..	0,02-0,07	0,02-0,07	0,02-0,05	0,02-0,05	0,02-0,05					
ECM 04..	0,04-0,1	0,04-0,1	0,04-0,1	0,04-0,1	0,03-0,07	0,01-0,05				
ECM 05..	0,04-0,1	0,04-0,1	0,04-0,1	0,04-0,1	0,03-0,08	0,02-0,06	0,01-0,04			
ECM 06..	0,04-0,1	0,04-0,1	0,04-0,1	0,04-0,1	0,04-0,1	0,03-0,08	0,02-0,06	0,01-0,04		
ECM 07..	0,04-0,1	0,04-0,1	0,04-0,1	0,04-0,1	0,04-0,1	0,04-0,1	0,03-0,08	0,02-0,06	0,01-0,04	
ECM 08..	0,04-0,1	0,04-0,1	0,04-0,1	0,04-0,1	0,04-0,1	0,04-0,1	0,04-0,1	0,03-0,08	0,02-0,06	0,01-0,04

4xD

EcoCut Mini Size	Depth of Cut a_p in mm									
	0,25	0,5	0,75	1,0	1,5	2,0	2,5	3,0	3,5	4,0
Feed rate f in mm/rev.										
ECM 02..	0,02-0,05	0,01-0,05								
ECM 02,5..	0,02-0,05	0,01-0,05								
ECM 03..	0,02-0,05	0,02-0,05	0,01-0,05							
ECM 03,5..	0,02-0,05	0,02-0,05	0,02-0,05	0,01-0,05						
ECM 04..	0,04-0,1	0,04-0,1	0,04-0,1	0,03-0,08	0,01-0,05					
ECM 05..	0,04-0,1	0,04-0,1	0,04-0,1	0,03-0,085	0,02-0,06	0,01-0,04				
ECM 06..	0,04-0,1	0,04-0,1	0,04-0,1	0,03-0,085	0,02-0,06	0,01-0,04				
ECM 07..	0,04-0,1	0,04-0,1	0,04-0,1	0,04-0,1	0,03-0,08	0,02-0,06	0,01-0,04			
ECM 08..	0,04-0,1	0,04-0,1	0,04-0,1	0,04-0,1	0,04-0,095	0,03-0,08	0,02-0,06	0,01-0,04		

Face turning

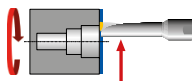

EcoCut Mini Size	2,25xD		4xD	
	$a_{p\ max.}$ in mm	f in mm/rev.	$a_{p\ max.}$ in mm	f in mm/rev.
ECM 02..	0,30	0,01-0,05	0,30	0,01-0,03
ECM 02,5..	0,30	0,01-0,05	0,30	0,01-0,03
ECM 03..	0,50	0,01-0,06	0,50	0,01-0,04
ECM 03,5..	0,50	0,01-0,06	0,50	0,01-0,04
ECM 04..	0,70	0,03-0,07	0,70	0,02-0,05
ECM 05..	0,70	0,03-0,07	0,70	0,02-0,05
ECM 06..	0,70	0,03-0,07	0,70	0,02-0,05
ECM 07..	1,00	0,04-0,08	1,00	0,03-0,06
ECM 08..	1,00	0,04-0,08	1,00	0,03-0,06

Depth of Cut and Feedrate for EcoCut Mini

Drilling
Feed rate

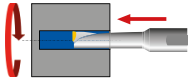

EcoCut Mini Size	2,25xD	4xD
	f in mm/rev.	f in mm/rev.
ECM 02..	0,0025–0,0075	0,0025–0,005
ECM 02,5..	0,0025–0,010	0,0025–0,005
ECM 03..	0,0025–0,0125	0,0025–0,010
ECM 03,5..	0,0025–0,0150	0,0025–0,010
ECM 04..	0,005–0,030	0,005–0,0125
ECM 05..	0,005–0,030	0,005–0,015
ECM 06..	0,005–0,030	0,005–0,020
ECM 07..	0,005–0,035	0,005–0,025
ECM 08..	0,005–0,040	0,005–0,030

max. bore depth

EcoCut Mini Size	2,25xD	4xD
	Max. hole depth in mm	Max. hole depth in mm
ECM 02..	4,50	8,0
ECM 02,5..	5,63	10,0
ECM 03..	6,75	12,0
ECM 03,5..	7,88	14,0
ECM 04..	9,0	16,0
ECM 05..	11,25	20,0
ECM 06..	13,5	24,0
ECM 07..	15,75	28,0
ECM 08..	18,0	32,0

Depth of Cut and Feedrate for EcoCut Classic

Turning

1.5xD

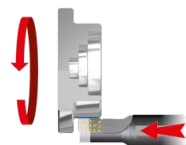

EcoCut Classic Size	Depth of Cut a_p in mm											
	1	2	3	4	5	6	7	8	9	10	12	14
	Feed rate f in mm/rev.											
ECC 08	0,06–0,12	0,06–0,12	0,04–0,10	0,02–0,08								
ECC 10	0,07–0,15	0,07–0,15	0,05–0,13	0,04–0,11	0,02–0,09							
ECC 12	0,08–0,16	0,08–0,16	0,08–0,16	0,06–0,14	0,04–0,12	0,02–0,10						
ECC 14	0,09–0,18	0,09–0,18	0,09–0,18	0,09–0,18	0,07–0,16	0,05–0,14	0,02–0,11					
ECC 16	0,10–0,20	0,10–0,20	0,10–0,20	0,10–0,20	0,08–0,18	0,06–0,16	0,04–0,14	0,02–0,12				
ECC 18	0,11–0,22	0,11–0,22	0,11–0,22	0,11–0,22	0,11–0,22	0,09–0,20	0,07–0,18	0,05–0,16	0,03–0,13			
ECC 20	0,12–0,24	0,12–0,24	0,12–0,24	0,12–0,24	0,12–0,24	0,11–0,23	0,09–0,21	0,07–0,19	0,05–0,17	0,03–0,15		
ECC 25	0,13–0,26	0,13–0,26	0,13–0,26	0,13–0,26	0,13–0,26	0,13–0,26	0,13–0,26	0,11–0,24	0,09–0,22	0,07–0,20	0,03–0,16	
ECC 32	0,15–0,30	0,15–0,30	0,15–0,30	0,15–0,30	0,15–0,30	0,14–0,30	0,15–0,30	0,15–0,30	0,13–0,28	0,11–0,26	0,07–0,22	0,03–0,18

 Feed f may be increased by 50–75 % when using -M50Q and -27Q.

2.25xD

EcoCut Classic Size	Depth of Cut a_p in mm										
	1,0	2,0	2,5	3,0	3,5	4,0	4,5	5,0	5,5	6,0	7,0
	Feed rate f in mm/rev.										
ECC 08	0,06–0,12	0,04–0,10	0,02–0,08								
ECC 10	0,07–0,15	0,05–0,13	0,03–0,11	0,02–0,09							
ECC 12	0,08–0,16	0,08–0,16	0,06–0,14	0,04–0,12	0,02–0,10						
ECC 14	0,09–0,18	0,09–0,18	0,07–0,16	0,05–0,14	0,04–0,13	0,02–0,11					
ECC 16	0,10–0,20	0,10–0,20	0,09–0,19	0,07–0,17	0,05–0,15	0,03–0,13					
ECC 18	0,11–0,22	0,11–0,22	0,11–0,22	0,09–0,20	0,07–0,18	0,05–0,16	0,03–0,14				
ECC 20	0,12–0,24	0,12–0,24	0,12–0,24	0,12–0,24	0,10–0,22	0,08–0,20	0,06–0,18	0,04–0,16			
ECC 25	0,13–0,26	0,13–0,26	0,13–0,26	0,13–0,26	0,13–0,26	0,12–0,25	0,10–0,23	0,08–0,21	0,06–0,19	0,04–0,17	
ECC 32	0,15–0,30	0,15–0,30	0,15–0,30	0,15–0,30	0,15–0,30	0,15–0,30	0,14–0,29	0,12–0,27	0,10–0,25	0,08–0,23	0,05–0,20

 Feed f may be increased by 50–75 % when using -M50Q and -27Q.

3xD

EcoCut Classic Size	Depth of Cut a_p in mm								
	1,0	2,0	2,5	3,0	3,5	4,0	5,0	6,0	7,0
	Feed rate f in mm/rev.								
ECC 08	0,05–0,10	0,02–0,06							
ECC 10	0,06–0,11	0,03–0,07							
ECC 12	0,06–0,12	0,04–0,10	0,02–0,08						
ECC 14	0,07–0,13	0,05–0,11	0,02–0,09						
ECC 16	0,07–0,15	0,06–0,14	0,04–0,12	0,02–0,09					
ECC 18	0,08–0,16	0,08–0,16	0,06–0,14	0,04–0,12					
ECC 20	0,09–0,18	0,09–0,18	0,09–0,18	0,07–0,16	0,05–0,14	0,03–0,12			
ECC 25	0,10–0,19	0,10–0,19	0,10–0,19	0,08–0,17	0,06–0,15	0,03–0,13			
ECC 32	0,11–0,22	0,11–0,22	0,11–0,22	0,11–0,22	0,09–0,20	0,07–0,18	0,03–0,14		

Depth of Cut and Feedrate for EcoCut Classic

Face turning

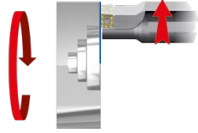

EcoCut Classic Size	1,5xD		2,25xD		3xD	
	a _p in mm	f in mm/rev.	a _p in mm	f in mm/rev.	a _p in mm	f in mm/rev.
ECC 08	2,00	0,05-0,10	1,90	0,04-0,09	1,10	0,04-0,07
ECC 10	2,50	0,06-0,12	2,20	0,05-0,10	1,20	0,04-0,09
ECC 12	3,00	0,07-0,14	2,60	0,06-0,12	1,40	0,05-0,11
ECC 14	3,50	0,08-0,16	3,00	0,07-0,14	1,60	0,06-0,12
ECC 16	4,00	0,09-0,18	3,40	0,08-0,16	1,90	0,06-0,13
ECC 18	4,50	0,10-0,20	3,80	0,09-0,18	2,00	0,07-0,14
ECC 20	5,00	0,11-0,22	4,20	0,10-0,20	2,20	0,08-0,15
ECC 25	6,00	0,12-0,24	5,00	0,11-0,22	2,60	0,09-0,18
ECC 32	8,00	0,13-0,27	6,00	0,12-0,25	3,00	0,10-0,20

Drilling

Feed rate

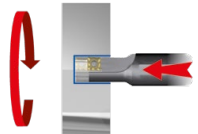

EcoCut Classic Size	1,5xD	2,25xD	3xD
	f in mm/rev.	f in mm/rev.	f in mm/rev.
ECC 08	0,01-0,04	0,01-0,04	0,01-0,02
ECC 10	0,01-0,05	0,01-0,05	0,01-0,03
ECC 12	0,01-0,05	0,01-0,05	0,01-0,04
ECC 14	0,01-0,07	0,01-0,07	0,01-0,05
ECC 16	0,02-0,08	0,02-0,08	0,02-0,06
ECC 18	0,03-0,09	0,03-0,09	0,03-0,07
ECC 20	0,03-0,10	0,03-0,10	0,03-0,08
ECC 25	0,03-0,12	0,03-0,12	0,04-0,09
ECC 32	0,05-0,15	0,05-0,15	0,05-0,11

max. bore depth

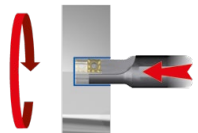

EcoCut Classic Size	1,5xD	2,25xD	3xD
	Max. hole depth in mm	Max. hole depth in mm	Max. hole depth in mm
ECC 08	12,0	18,0	24,0
ECC 10	15,0	22,5	30,0
ECC 12	18,0	27,0	36,0
ECC 14	21,0	31,5	42,0
ECC 16	24,0	36,0	48,0
ECC 18	27,0	40,5	54,0
ECC 20	30,0	45,0	60,0
ECC 25	37,5	56,5	75,0
ECC 32	48,0	72,0	96,0

Depth of Cut and Feedrate for EcoCut ProfileMaster 90°

Turning

1,5xD

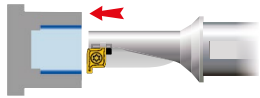

EcoCut ProfileMaster Size	Depth of Cut a_p in mm							
	1	2	3	4	5	6	7	8
	Feed rate f in mm/rev.							
EC PM 10	0,07-0,20	0,05-0,17	0,02-0,12					
EC PM 12	0,07-0,20	0,05-0,17	0,02-0,12					
EC PM 16	0,10-0,25	0,07-0,23	0,05-0,21	0,02-0,17				
EC PM 20	0,12-0,27	0,10-0,26	0,007-0,24	0,05-0,20	0,02-0,14			
EC PM 25	0,15-0,30	0,15-0,30	0,13-0,28	0,10-0,26	0,05-0,22	0,02-0,18		
EC PM 32	0,15-0,30	0,15-0,30	0,15-0,30	0,15-0,30	0,10-0,27	0,07-0,24	0,05-0,21	0,02-0,15

2,25xD

EcoCut ProfileMaster Size	Depth of Cut a_p in mm							
	1	2	3	4	5	6	7	8
	Feed rate f in mm/rev.							
EC PM 10	0,07-0,19	0,02-0,13						
EC PM 12	0,07-0,19	0,02-0,13						
EC PM 16	0,10-0,25	0,07-0,21	0,02-0,13					
EC PM 20	0,12-0,27	0,07-0,24	0,05-0,19					
EC PM 25	0,15-0,30	0,10-0,27	0,07-0,23	0,02-0,15				
EC PM 32	0,15-0,30	0,15-0,30	0,10-0,27	0,07-0,23	0,02-0,15			

Face turning

1.5xD and 2.25xD

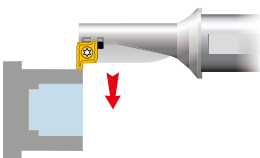

EcoCut ProfileMaster Size	Depth of Cut a_p in mm					
	1,0	1,5	2,0	2,5	3,0	3,5
	Feed rate f in mm/rev.					
EC PM 10	0,02-0,15	0,02-0,15				
EC PM 12	0,02-0,15	0,02-0,15				
EC PM 16	0,05-0,20	0,05-0,20	0,05-0,20			
EC PM 20	0,08-0,22	0,08-0,22	0,08-0,22	0,08-0,22		
EC PM 25	0,10-0,25	0,10-0,25	0,10-0,25	0,10-0,25	0,10-0,25	
EC PM 32	0,10-0,25	0,10-0,25	0,10-0,25	0,10-0,25	0,10-0,25	0,10-0,25

Internal + external – radial grooving

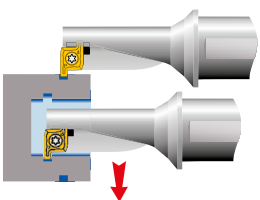

EcoCut ProfileMaster Size	1,5xD	EcoCut ProfileMaster Size	2,25xD
	f in mm/rev.		f in mm/rev.
EC PM 10	0,01-0,08	EC PM 10	0,01-0,08
EC PM 12	0,02-0,10	EC PM 12	0,02-0,10
EC PM 16	0,04-0,15	EC PM 16	0,04-0,15
EC PM 20	0,04-0,16	EC PM 20	0,04-0,16
EC PM 25	0,07-0,20	EC PM 25	0,07-0,20
EC PM 32	0,08-0,22	EC PM 32	0,08-0,22

Drilling

Feed and max. hole depth

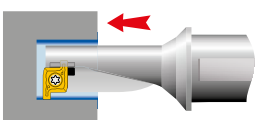

EcoCut ProfileMaster Size	1,5xD		EcoCut ProfileMaster Size	2,25xD	
	f in mm/rev.	Max. hole depth in mm		f in mm/rev.	Max. hole depth in mm
EC PM 10	0,01-0,05	15,0	EC PM 10	0,01-0,05	22,5
EC PM 12	0,01-0,06	18,0	EC PM 12	0,01-0,06	27,0
EC PM 16	0,02-0,09	24,0	EC PM 16	0,02-0,09	36,0
EC PM 20	0,03-0,10	30,0	EC PM 20	0,03-0,10	45,0
EC PM 25	0,04-0,12	37,5	EC PM 25	0,04-0,12	56,3
EC PM 32	0,04-0,14	48,0	EC PM 32	0,04-0,14	72,0

Depth of Cut and Feedrate for EcoCut ProfileMaster 0°

 EcoCut ProfileMaster Sizes 10 and 12 can not be used as 0° version.

Turning

1,5xD

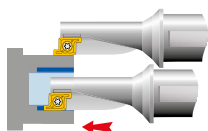

EcoCut ProfileMaster Size	Depth of cut a_p in mm					
	1,0	1,5	2,0	2,5	3,0	3,5
	Feed rate f in mm/rev.					
EC PM 16	0,04–0,20	0,04–0,20	0,04–0,20			
EC PM 20	0,06–0,22	0,06–0,22	0,06–0,22	0,06–0,22		
EC PM 25	0,08–0,25	0,08–0,25	0,08–0,25	0,08–0,25	0,08–0,25	
EC PM 32	0,10–0,28	0,10–0,28	0,10–0,28	0,10–0,28	0,10–0,28	0,10–0,28

2,25xD

EcoCut ProfileMaster Size	Depth of cut a_p in mm					
	1,0	1,5	2,0	2,5	3,0	3,5
	Feed rate f in mm/rev.					
EC PM 16	0,04–0,20	0,04–0,20	0,04–0,20			
EC PM 20	0,06–0,22	0,06–0,22	0,06–0,22	0,06–0,22		
EC PM 25	0,08–0,25	0,08–0,25	0,08–0,25	0,08–0,25	0,08–0,25	
EC PM 32	0,10–0,28	0,10–0,28	0,10–0,28	0,10–0,28	0,10–0,28	0,10–0,28

Face turning

1,5xD

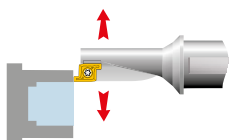

EcoCut ProfileMaster Size	Depth of cut a_p in mm						
	1,0	1,5	2,0	2,5	3,0	3,5	4,0
	Feed rate f in mm/rev.						
EC PM 16	0,05–0,20	0,05–0,20	0,05–0,20				
EC PM 20	0,05–0,20	0,05–0,20	0,05–0,20	0,05–0,20			
EC PM 25	0,10–0,25	0,10–0,25	0,10–0,25	0,10–0,25	0,10–0,25		
EC PM 32	0,10–0,25	0,10–0,25	0,10–0,25	0,10–0,25	0,10–0,25	0,10–0,25	0,10–0,25

2,25xD

EcoCut ProfileMaster Size	Depth of cut a_p in mm						
	1,0	1,5	2,0	2,5	3,0	3,5	4,0
	Feed rate f in mm/rev.						
EC PM 16	0,05–0,20	0,05–0,20	0,05–0,20				
EC PM 20	0,05–0,20	0,05–0,20	0,05–0,20	0,05–0,20			
EC PM 25	0,10–0,25	0,10–0,25	0,10–0,25	0,10–0,25	0,10–0,25		
EC PM 32	0,10–0,25	0,10–0,25	0,10–0,25	0,10–0,25	0,10–0,25	0,10–0,25	0,10–0,25

Axial grooving external + internal

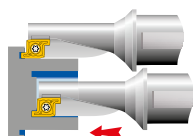

EcoCut ProfileMaster Size	1,5xD
	Feed rate f in mm/rev.
EC PM 16	0,02–0,12
EC PM 20	0,04–0,14
EC PM 25	0,06–0,18
EC PM 32	0,08–0,20

EcoCut ProfileMaster Size	2,25xD
	Feed rate f in mm/rev.
EC PM 16	0,02–0,12
EC PM 20	0,04–0,14
EC PM 25	0,06–0,18
EC PM 32	0,08–0,20

Chip Breakers Overview

EcoCut Classic

	Model	Smooth cut	Irregular cutting depth	Interrupted cut	Sectional illustration
					f mm
-EN ▲ Universal geometry ▲ Excellent chip breakage ▲ Positive cutting edge ▲ Low to medium feeds		CTCP425	CTCP435 / CTPP430	CTPP430 / CTCP435	
		CTCP425 / CTPP430	CTPP430	CTPP430	
		CTCP425	CTCP435 / CTPP430	CTCP435	
		CTPP430	CTPP430	CTPP430	
		CTCP435 / CTPP430	CTCP435 / CTPP430	CTCP435	
		CTCP435 / CTPP430	CTCP435 / CTPP430	CTCP435	
0,05–0,275					
-M50Q ▲ With smoothing geometry ▲ Excellent surface qualities ▲ Good chip formation ▲ Medium to high feeds		CTCP425	CTCP425		
		CTCP425			
		CTCP425	CTCP425		
0,2–0,425					
-27P ▲ Positive cutting edge ▲ Periphery ground ▲ Polished rake face ▲ First choice for non-ferrous metals					
		H216T	H216T	H216T	
		H216T	H216T	H216T	
		H216T	H216T		
		H216T	H216T		
0,1–0,4					
-27Q ▲ With smoothing geometry ▲ Extremely positive geometry ▲ Periphery ground ▲ Low adhesion					
		H210T	H210T		
		H210T	H210T		
		H210T	H210T		
		H210T	H210T		
0,2–0,5					

EcoCut ProfileMaster

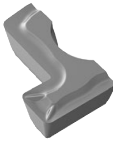
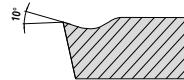
-M20 ▲ Positive geometry ▲ Universal application ▲ Low to medium feeds		CTPP430	CTPP430	CTPP40	
		CTPP430	CTPP430	CTPP430	
		CTPP430	CTPP430	CTPP430	
		CTPP430	CTPP430	CTPP430	
		CTPP430	CTPP430		
		CTPP430	CTPP430	CTPP430	
0,05–0,25					

Application area of -EN and -M50Q chip breakers

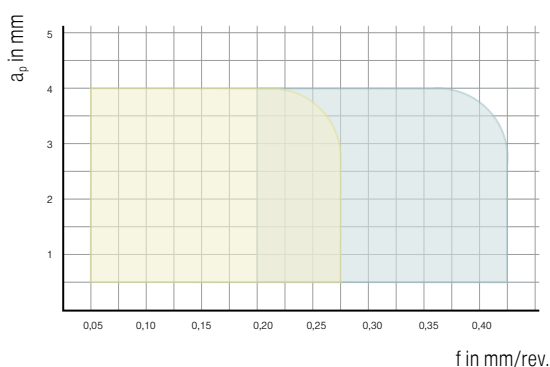

EcoCut Classic 2.25xD – ECC16 – XCNT 080304

- = -M50Q
- = Standard

EcoCut Classic – Application as the most stable boring tool

EcoCut can be used not only as a multifunctional tool. In comparison with a boring bar EcoCut used as a pure boring tool gives the user enormous benefits.

Example: machining bores, 16 mm diameter by 36 mm depth

Differences in the tool

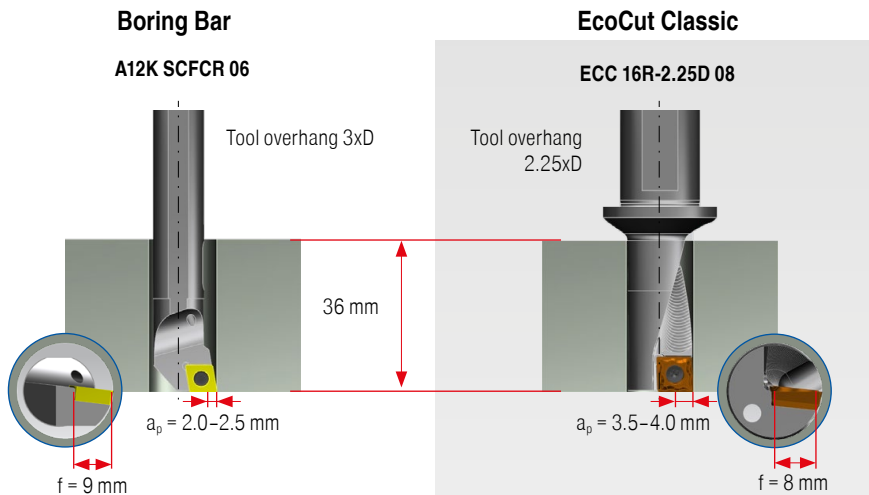

Your Advantages

Large, stable toolholder

- ▲ Absorption of high cutting forces
- ▲ Low vibration
- ▲ Chip Booster for perfect cooling and chip evacuation

Benefits

- ▲ High surface quality
- ▲ Perfect chip control
- ▲ Max. process security

Differences in the insert

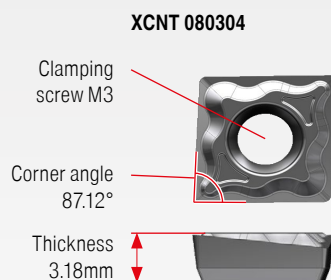
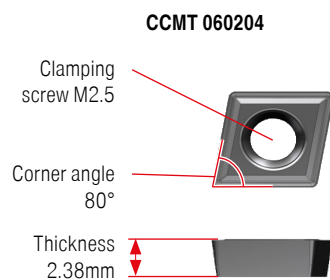

Large and stable insert

- ▲ Increased process security
- ▲ Enables large depths of cut
- ▲ Higher cutting data
- ▲ Higher tool life

Benefits

- ▲ Reduction in machining time
- ▲ Increased productivity
- ▲ Reduced tooling costs

Stability Comparison

Calculation using FEM

A load of 1000 N on the insert seat corresponds to an approx. a_p of 2.0 mm and f of 0.2 mm

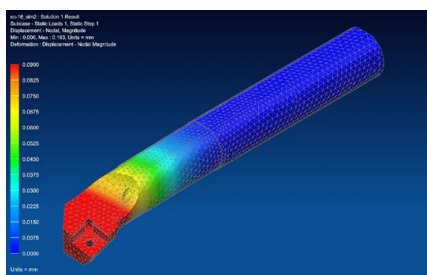

Deflection 0.19mm

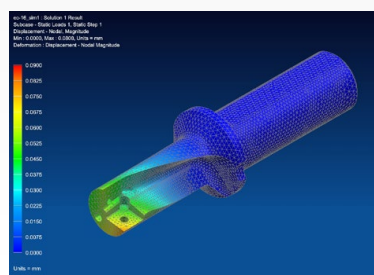

Deflection 0.08mm

Practical experience shows:

- ▲ Reduced machining time by up to **75 %**
- ▲ Increase in tool life by **400 %** possible

Innovative chip removal – Chip-Booster

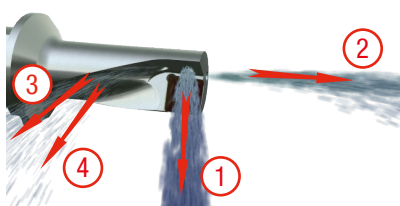

EcoCut tools are equipped with a unique coolant and chip removal system.

- ① Cooling of the indexable insert
- ② General coolant stream

- ③ Chip booster for improved chip transport
- ④ Chip booster prevents chips from getting stuck between tool and workpiece

① For maximum chip transport efficiency when drilling, coolant pressure must be 3–6 bar minimum (optimal 7–10 bar).

Application Tips

Drilling Off centre

Due to the special construction of the EcoCut tool and insert, off-centre drilling is possible.

Deviations from the tool nominal \emptyset , can be achieved (see adjacent table).

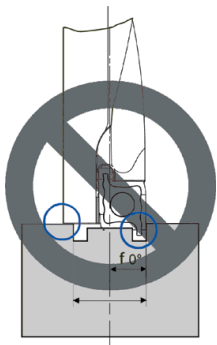
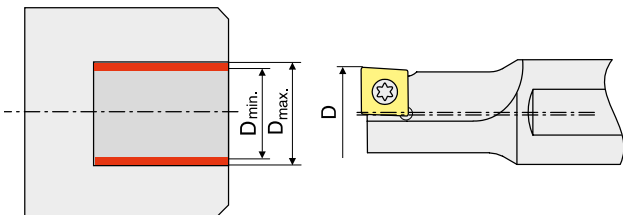

ProfileMaster 0°
Not suitable for drilling!

EcoCut Mini	Tool nominal- \emptyset	Work piece bore \emptyset	
	D in mm	D _{min.} in mm	D _{max.} in mm
ECM 02 L/R - ...D	2	1,95	2,1
ECM 02,5 L/R - ...D	2,5	2,45	2,6
ECM 03 L/R - ...D	3	2,95	3,15
ECM 03,5 L/R - ...D	3,5	3,45	3,65
ECM 04 R/L - ...D	4	3,90	4,20
ECM 05 R/L - ...D	5	4,90	5,20
ECM 06 R/L - ...D	6	5,90	6,20
ECM 07 R/L - ...D	7	6,90	7,20
ECM 08 R/L - ...D	8	7,90	8,20

EcoCut Classic	Tool nominal- \emptyset	Work piece bore \emptyset	
	D in mm	D _{min.} in mm	D _{max.} in mm
ECC 08 R/L - ... 04	8	7,85	8,30
ECC 10 R/L - ... 05	10	9,85	10,50
ECC 12 R/L - ... 06	12	11,85	12,50
ECC 14 R/L - ... 07	14	13,85	14,50
ECC 16 R/L - ... 08	16	15,85	16,50
ECC 18 R/L - ... 09	18	17,85	18,50
ECC 20 R/L - ... 10	20	19,80	20,50
ECC 25 R/L - ... 13	25	24,80	25,80
ECC 32 R/L - ... 17	32	31,80	33,00

EcoCut ProfileMaster	Tool nominal- \emptyset	Work piece bore \emptyset	
	D in mm	D _{min.} in mm	D _{max.} in mm
PM 10R/L ...	10	9,85	12
PM 12R/L ...	12	11,85	15
PM 16R/L ...	16	15,85	19
PM 20R/L ...	20	19,80	24
PM 25R/L ...	25	24,80	29
PM 32R/L ...	32	31,80	38

Machining over centre

Problem

In case of insufficient movement of the machine across the centre line, the external diameter can not be machined with the same tool.

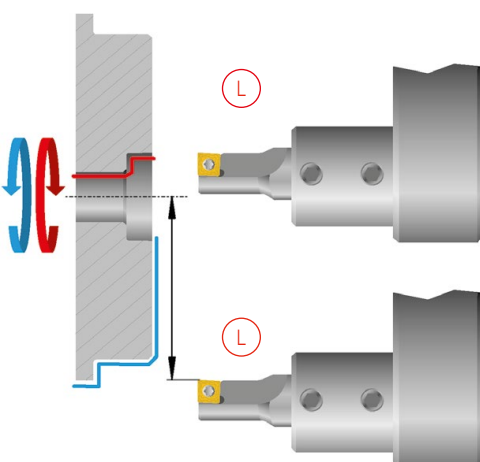

Solution

Use a right hand EcoCut tool.

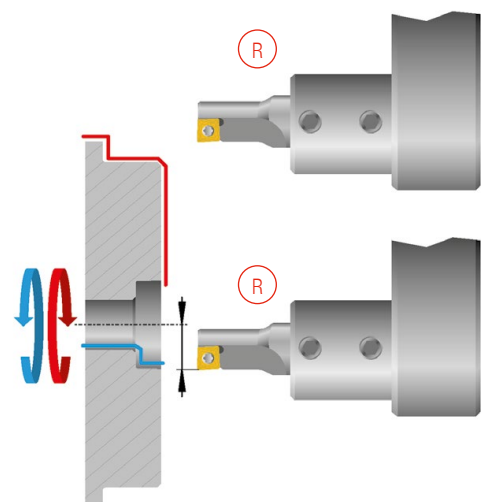

Application Tips

With axial displacement there is the danger of collision!

Problems

Displacement in x-direction:

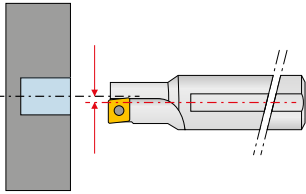

Angular error:

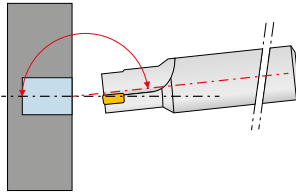

Turret position error:

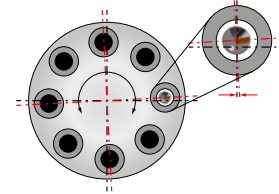

Remedy

When pre-setting the tool:

- ▲ Definition as an internal turning tool for programming

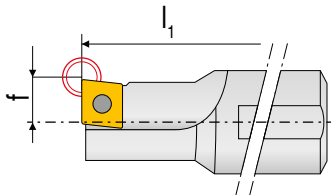

- ▲ Enter the tool nominal \varnothing as bore target \varnothing

At the machine:

- ▲ Make measuring cut, approx. 3 mm deep
- ▲ Measure drilled diameter produced

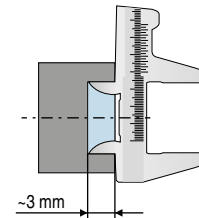

- ▲ If necessary correct drilling \varnothing
- ▲ Start machining

EcoCut Mini adapter – Design

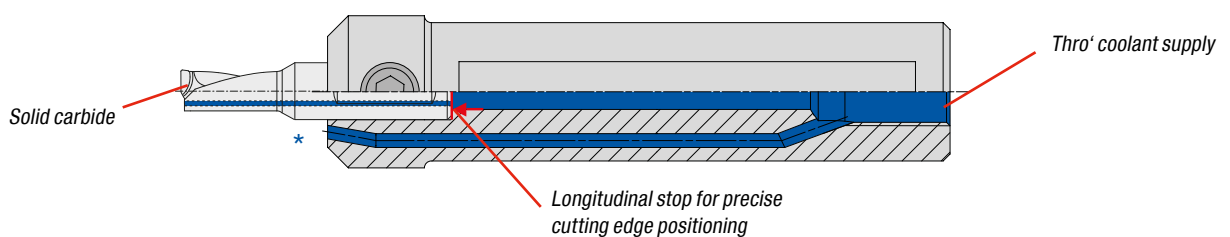

* Cross-section rotated by 90° for clarity

Mounting of the insert for EcoCut Classic

For tools up to \varnothing 8 mm right and left handed inserts are required. From \varnothing 10-32 mm neutral inserts are used.

Note!
Ensure correct installation position.



EcoCut ProfileMaster – the highlight with regard to efficiency

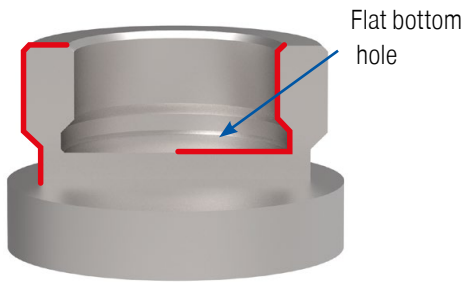

Right hand tool



right hand insert

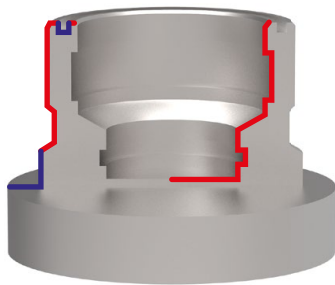

Right hand tool



left hand insert



right hand insert

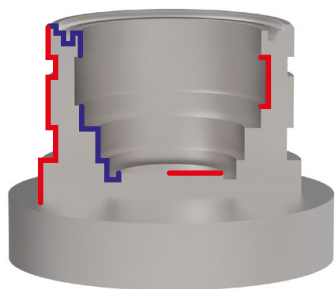

Left hand tool



Right hand tool



right hand insert

Version 90°

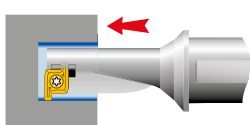

Drilling into solid material with flat bottom hole

Boring

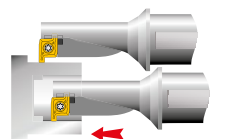

Turning External Diameters

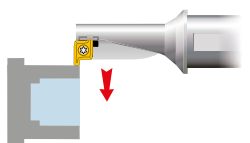

Turning Internal Diameters

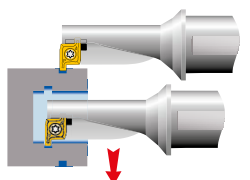

Turning Profiles



External radial grooving

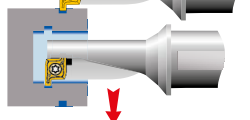

Internal radial grooving

Version 0°

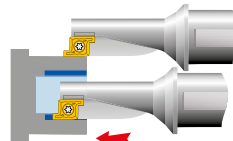

Turning External Diameters

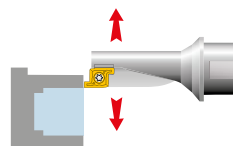

Turning Internal Diameters

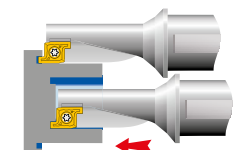

Turning Profiles

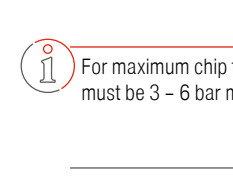

Axial grooving external

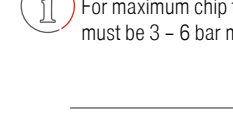

Axial grooving internal



For maximum chip transport efficiency when drilling, coolant pressure must be 3 – 6 bar minimum (optimal 7 – 10 bar).

EcoCut ProfileMaster – Axial Grooving

0° (from Ø 16 mm)

90°

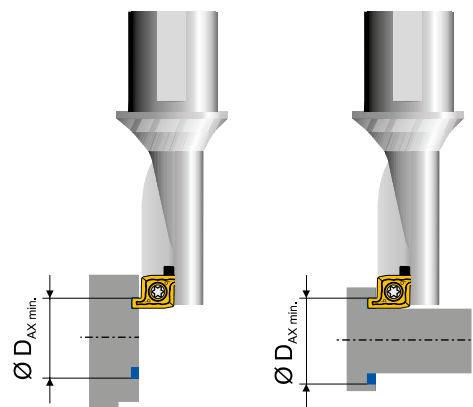
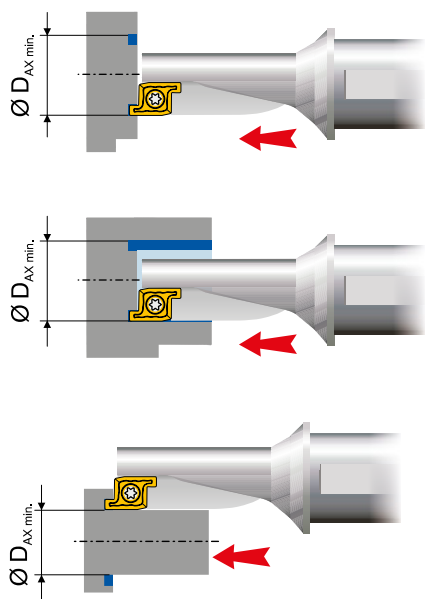

EcoCut ProfileMaster	Ø D _{noml.} mm	Ø D _{AX min.} mm	Ø D _{AX max.} mm
PM 10R/L 1,5D	10	10	> 10
PM 10R/L 2,25D	10	10	> 10
PM 12R/L 1,5D	12	12	> 12
PM 12R/L 2,25D	12	12	> 12
PM 16R/L 1,5D	16	16	> 16
PM 16R/L 2,25D	16	16	> 16
PM 20R/L 1,5D	20	20	> 20
PM 20R/L 2,25D	20	20	> 20
PM 25R/L 1,5D	25	25	> 25
PM 25R/L 2,25D	25	25	> 25
PM 32R/L 1,5D	32	32	> 32
PM 32R/L 2,25D	32	32	> 32

$$\text{Ø } D_{AX \text{ min.}} = \text{Ø } D_{noml.}$$

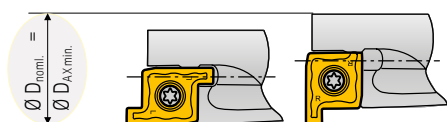

- Ø D_{noml.} = Nominal tool diameter
- Ø D_{AX min.} = smallest diameter for axial grooving
- Ø D_{AX max.} = largest diameter for axial grooving

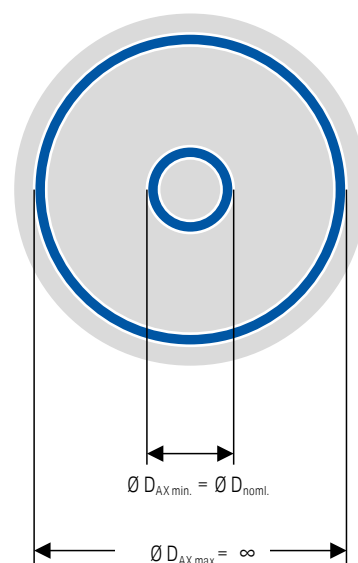

Application Tips

Recommendation for Optimum Results

Type of problem									Remedy measures
Type of wear				Work piece problems		Swarf control			
Edge breakage	Built-up edge	Wear on clearance face	Plastic deformation	Vibration	Surface quality	Chip too long (snarl chip)	Chip too short (fragmented chip)		
	▲	▼	▼	▼	▲	▼		Cutting data	Cutting speed
▼		~	▼	▲	▼	▲	▼		Feed rate
▲		▲	▲	▼	▲			Insert selection	Corner radius ▲ larger ▼ smaller
▼		▲	▲						Tool Material ▲ Wear resistance ▼ toughness
~				~	~			General criteria	Tool clamping
~				~	~				Work piece clamping
~				~	▼				Overhang
~		~		~	~				Tip height
	●	●	●		●	●			Cooling lubricant

▲ raise, increase large influence

↑ raise, increase small influence

▼ avoid, reduce large influence

↓ avoid, reduce small influence

~ control, optimize

● use

Designation System

EcoCut – indexable insert designation

X C E T 17 05 08 F N - 27P

1 2 3 4 5 6 7 8 9 10

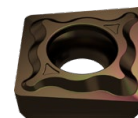

- 1 Insert shape
- 2 Clearance angle
- 3 Tolerances
- 4 Characteristics
- 5 Cutting length
- 6 Insert thickness
- 7 Corner radius
- 8 Cutting edge
- 9 Direction of cut
- 10 Chip groove

EcoCut – holder designation

ECC 32 R - 3.0D 17 H

1 2 3 4 5 6

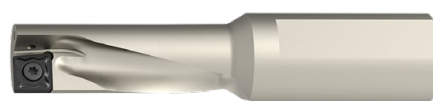

- 1 System
- 2 Nominal diameter in mm
- 3 Direction of cut
- 4 maximum hole depth
- 5 insert size
- 6 Tool holder version in Densimet

EcoCut ProfileMaster – indexable insert designation

PM 25 R G 35 30 04 - M20

1 2 3 4 5 6 7 8

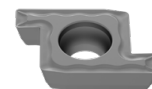

- 1 ProfileMaster
- 2 Nominal diameter in mm
- 3 Direction of cut
- 4 Version
- 5 Groove width in mm/10
- 6 Groove depth in mm/10
- 7 Corner radius
- 8 Chip groove

EcoCut ProfileMaster – holder designation

PMC 25 R - 2.25D

1 2 3 4

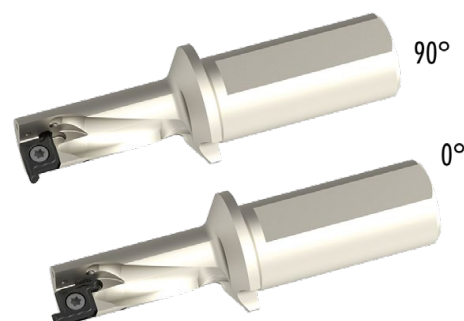

- 1 ProfileMaster
- 2 Nominal diameter in mm
- 3 Direction of cut
- 4 maximum hole depth

Application

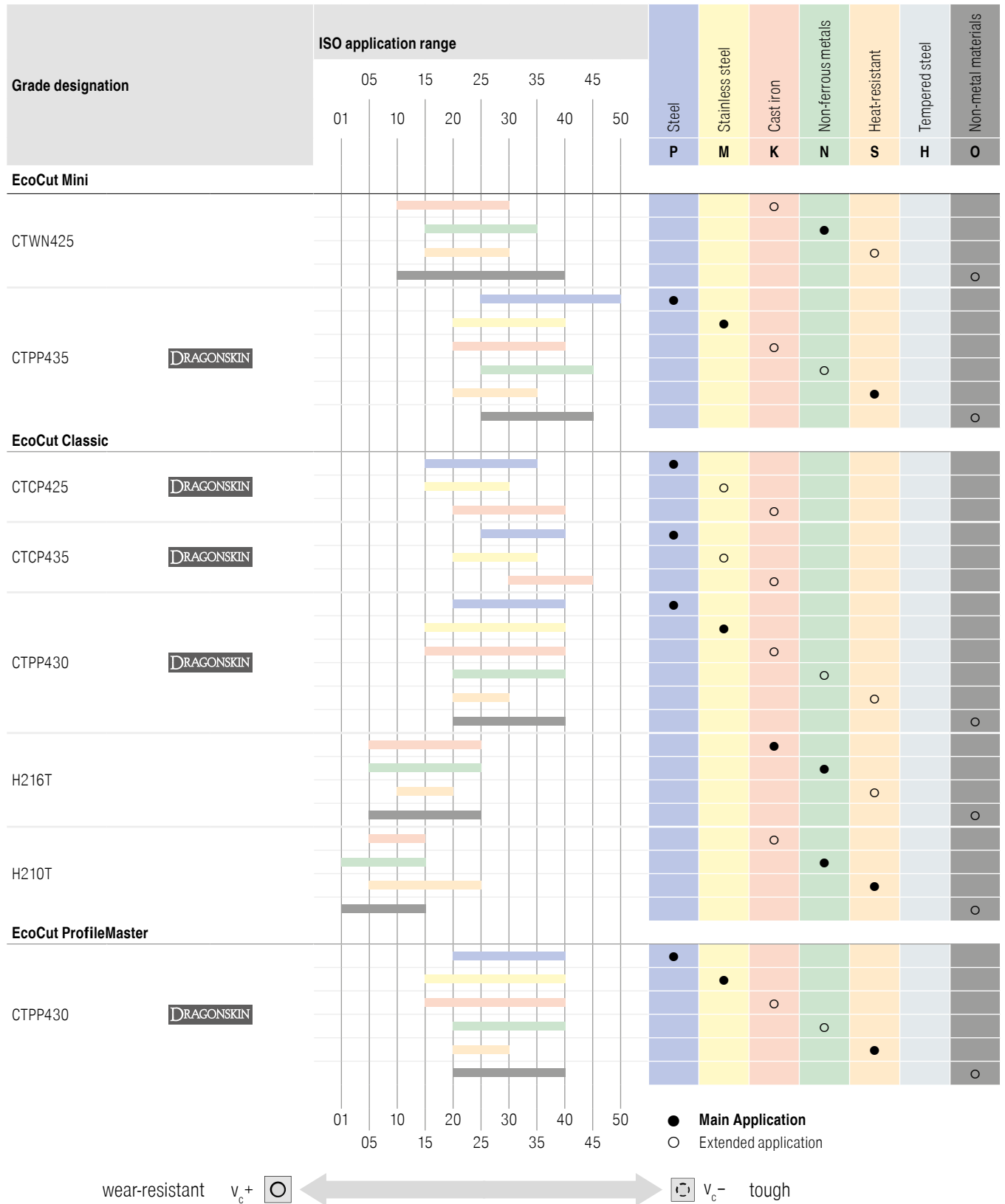

Grades Overview

EcoCut Classic

CTCP425
DRAGONSKIN

- ▲ Carbide, Ti+Al₂O₃-coated
- ▲ ISO | **P25** | K30 | M20
- ▲ The wear-resistant choice for steel and cast iron materials under stable conditions and at high cutting speeds

CTCP435
DRAGONSKIN

- ▲ Carbide, Ti+Al₂O₃-coated
- ▲ ISO | **P35** | M30 | K40
- ▲ The reliable choice for steel and cast iron materials under unstable conditions

CTPP430
DRAGONSKIN

- ▲ Carbide, TiAlN-coated
- ▲ ISO | **P30** | **M25** | K30 | N25 | S25 | O25
- ▲ The universal high-performance grade for steel, austenitic steel and heat-resistant alloys

H210T

- ▲ Carbide, uncoated
- ▲ ISO | K10 | **N10** | **S10** | O10
- ▲ The wear-resistant carbide grade for machining aluminium and other non-ferrous metals

H216T

- ▲ Carbide, uncoated
- ▲ ISO | **K15** | **N15** | S15 | O15
- ▲ The uncoated carbide grade for machining aluminium and other non-ferrous metals
- ▲ Also highly suitable for HSC machining

EcoCut Mini

CTPP435
DRAGONSKIN

- ▲ Carbide, TiAlN-coated
- ▲ ISO | **P35** | **M30** | K30 | N30 | **S30** | O30
- ▲ The universal high-performance grade for steel, austenitic steel and heat-resistant alloys

CTWN425

- ▲ Carbide, uncoated
- ▲ ISO | K20 | **N25** | S25 | O25
- ▲ The uncoated carbide grade for machining aluminium and other non-ferrous metals

EcoCut ProfileMaster

CTPP430
DRAGONSKIN

- ▲ Carbide, TiAlN-coated
- ▲ ISO | **P30** | **M25** | K30 | N25 | **S25** | O25
- ▲ The universal high-performance grade for steel, austenitic steel and heat-resistant alloys

Table of contents

Symbol explanation	204
Toolfinder – System Overview	205
Toolfinder – External Machining	206+207
Toolfinder – Internal Machining	208+209
Product programme	210-260
Technical Information	
Cutting Data	261
Depths of Cut and Feedrates	262-268
TC – Reference values for profile depth and number of passes	269
Comparison threading system with TC and conventional	270
Grooving depth reduction	271+272
Clamping Methods	273+274
Torque Moment ModularClamp Module Screws	275
Advantages due to DirectCooling	276
Advantages of the trochoidal turning strategy	276
General references	277
Measures for problems and causes of wear	278-280
Chip Breakers Overview	281-284
Example of Coding Grooving Tools	285
Grade overview and application	286+287

CERATIZIT \ Performance

Premium quality tools for high performance.

The premium quality tools from the **CERATIZIT Performance** product line have been designed for specific applications and are distinguished by their outstanding performance. If you make high demands on the performance of your production and want to achieve the very best results, we recommend the Premium tools in this product line.

Advantages of the DirectCooling blade

- ▲ The best machining results, even with reduced pump output
Highest flow volume of all thro' coolant blades on the market
- ▲ User friendly
Reinforced blades without sealing screw
- ▲ Process-secure spare part for easy handling and a long service life
Single-piece sealing screw made from steel (for standard blades)

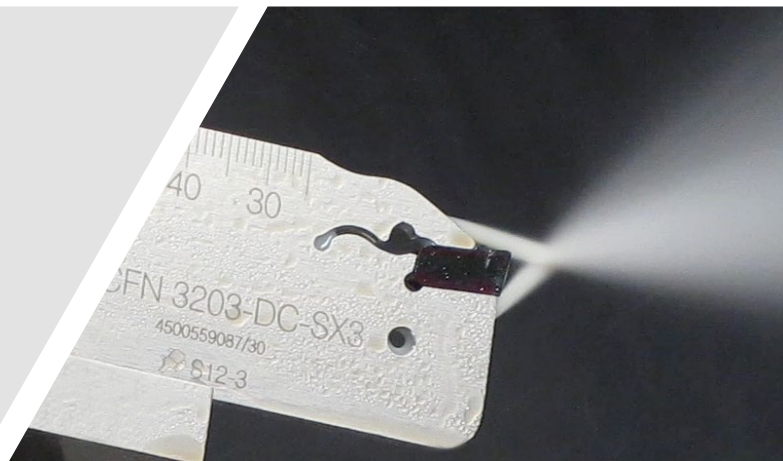

Symbol explanation



Grooving



Main Application



Turning



Extended application



Face turning



Repeatability



Axial grooving



F: Fine Machining
M: Medium Machining
R: Rough Machining

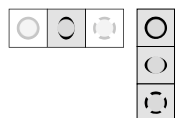

Smooth cut
Irregular cutting depth
Interrupted cut

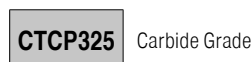

Carbide Grade

Toolfinder – System Overview

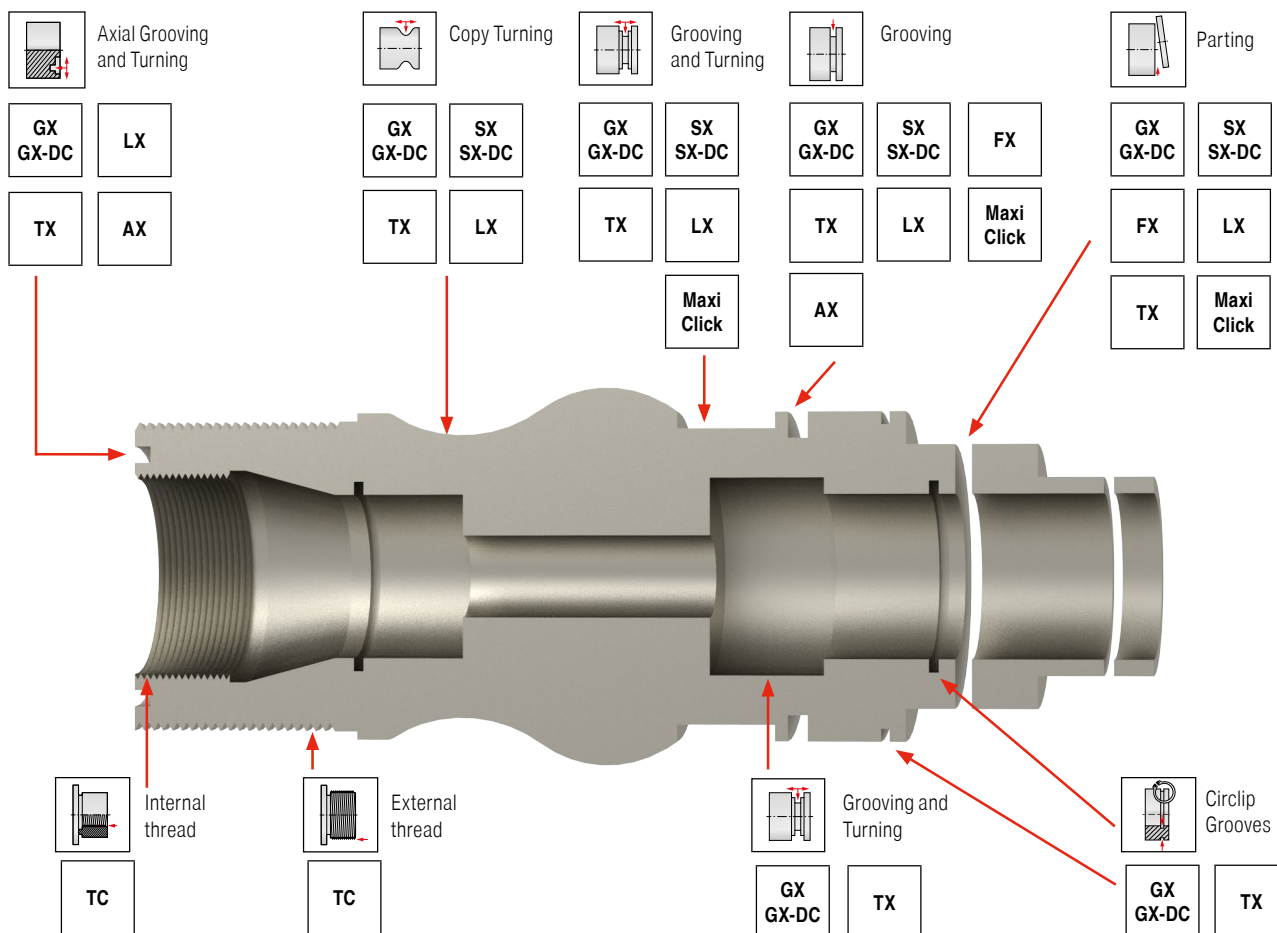

System Description

Page No.

SX	The single edged SX grooving system is even more versatile with the -M3 chip breaker. Besides grooving / parting with the -F2, -M2, or -27P chip breakers, the SX -M3 type also allows copying turning operations with the highest chip control. With this additional option, the SX grooving system can cover all areas of grooving making it a universal grooving tool. Available as a Modular or Mono system.	210-216
SX-DC	Our tried-and-tested single-edged SX grooving system is now available with targeted DirectCooling (DC) thro' coolant supply. The coolant is guided through two coolant holes – one above and one below the grooving insert – straight to the point where it will be most effective: the cutting edge itself.	215
FX	A single-edged grooving system with a variety of specialized chip geometries. From fine machining in unstable parts through to high-performance machining under stable conditions. Available as a Modular or Mono system.	217-222
GX	Double edged grooving system for grooving, parting off, turning and for producing circlip grooves. Available in sizes GX09, GX16 and GX24. Available as a Modular or Mono system.	223-243
GX-DC	Our tried-and-tested two-edged GX grooving system is now available with targeted DirectCooling (DC) thro' coolant supply. The coolant is guided through two coolant holes – one above and one below the grooving insert – straight to the point where it will be most effective: the cutting edge itself.	233+244
TX	Three-edged system for parting, grooving, axial grooving, radial grooving, and fine turning. Positive ground cutting geometries, with a very soft cut with minimum cutting forces. Universally applicable for almost all materials. Available as a Monosystem.	
LX	Single edged system for extreme applications starting from a cutting width of 8.0 mm. The LX system is for use in stable conditions. Available as a Modular or Mono system	
AX	Double-edged Axial grooving system for grooving and groove turning with high precision. Due to the three different depths (5 mm, 10 mm and 15 mm) stable tools are available for each application.	
TC	Double-edged thread turning system for the production of external and internal threads. Advantage is the use without pitch angle correction and in narrow or difficult areas of application. Available as a Modular or Mono system.	246-253
Maxi Click	Five-edged grooving system for grooving and parting	254-258

Toolfinder - External Machining

ModularClamp

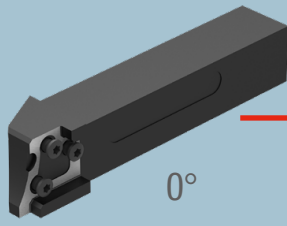

259

0°

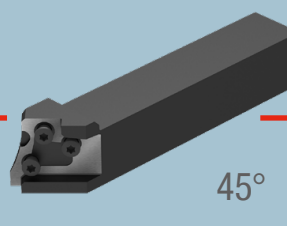

45°

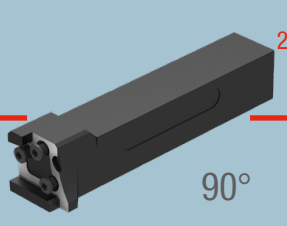

260

90°

GX 09



230

231

GX 16



230

231

GX 24

Deep Radial Grooving,
Parting and Turning

Axial Grooving and Face
Turning

Deep Axial Grooving and
Face Turning

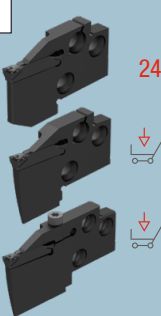

243

GX 09

Circlip grooves



228

Cutting width
CW = 0,5-3,15 mm (H13)

Grooving and
Turning

-F2



223

Standard



224

Radius grooves

Standard



229

CRE = 0,8-1,2 mm

-M40



225

Cutting width
CW = 2,0-3,5 mm

GX 16

Circlip grooves



228

Cutting width
CW = 0,5-5,15 mm (H13)

Grooving and
Turning

-F2



223

Standard



224

Radius grooves

Standard



229

-27P

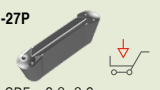

227

CRE = 0,8-3,0 mm

-M1



225

-27P

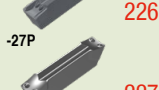

226

Cutting width
CW = 2,0-6,0 mm

GX 24

Radial, axial and deep axial grooving and parting, face turning and turning

-F2



237

-E



238

-M1



239

-M40



240

-M3



241

-27P



242

Cutting width
CW = 2,0-6,0 mm

-27P

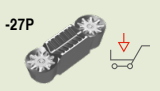

242

CRE = 1,5-4,0 mm

GX 09

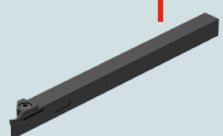

232

GX 16 - **GX-DC**

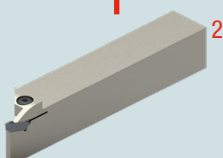

233+234

GX 24 - **GX-DC**

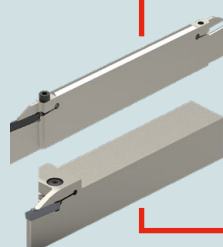

244+245

MonoClamp

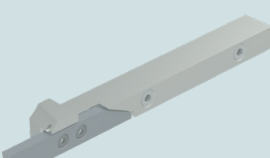

The VertiClamp grooving system can be found in **Chapter 3 Turning using VertiClamp**

03|206

cuttingtools.ceratizit.com

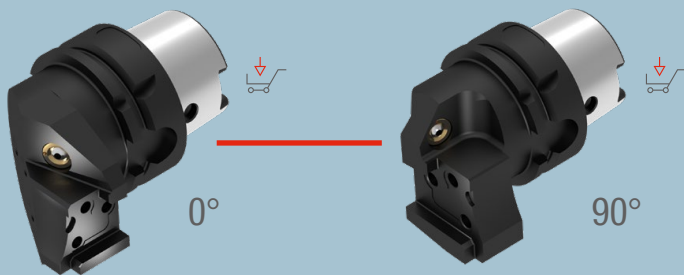

SX

FX

LX

TC

AX

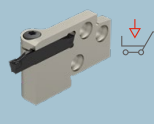
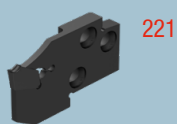
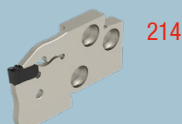

SX

FX

LX







TC

AX

TX

Maxi Click

Parting, Grooving and Turning

 -F2 #H34# 210	 -M2 Cutting width CW = 2,0-6,0 mm 212
 -M1 211	 -27P Grooving and copy turning 213
 -M3 CRE = 1,5-3,0 mm 	

Parting and Grooving

 -F1 217
 -M1 218+219
 -27P 220
 -R2 Cutting width CW = 2,2 - 9,7 mm 



Deep Parting and Grooving

 -M2
 -M3 Cutting width CW = 8,0 - 10,0 mm 











Thread turning

Full profile
60°  246+247
55°  249
Partial profile
60°  248
55°  250

Axial Grooving and Turning

 -F50 Groove width CW = 3,0 mm 
--

Parting

 
Circlip Grooves  
Corner undercut  
Fine and copy turning  
Axial grooving  

-F2 5 mm  254
-F2 10 mm  255
-F3 10 mm  256 Cutting width CW = 1,0 - 2,5 mm

SX - SX-DC 

FX

LX

TC

AX

TX

Maxi Click

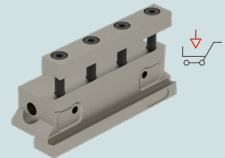
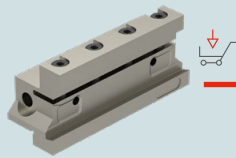
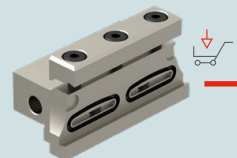
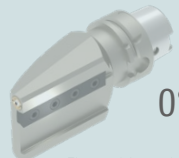
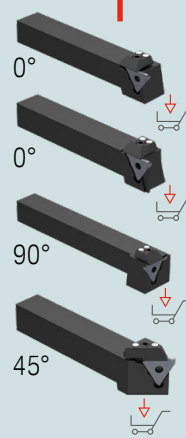
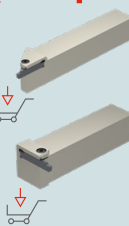
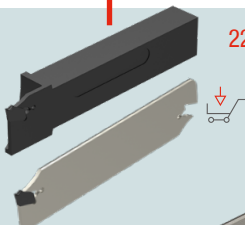
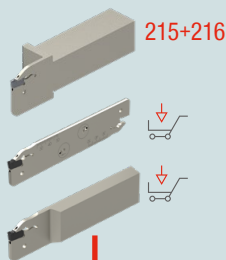

* These articles can be found in → Catalogue - Clamping technology, Chapter 16

Toolfinder - Internal Machining

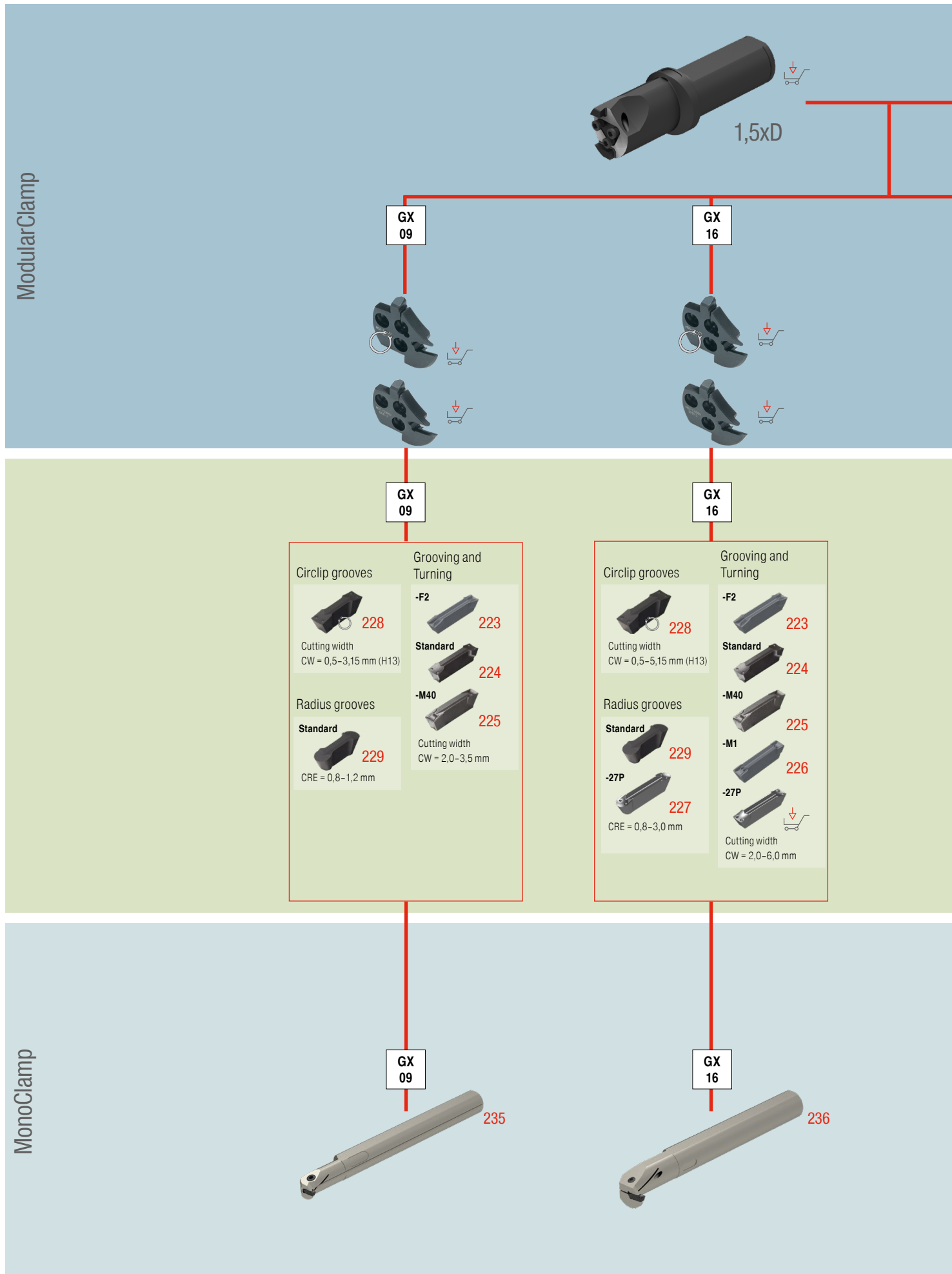

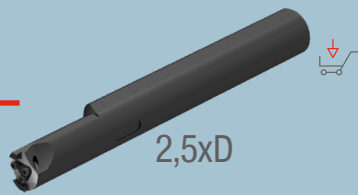

GX
24



TC

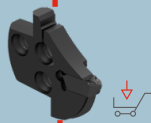





GX
24

Radial, axial and deep axial grooving and parting, face turning and turning

- | | |
|---|--|
| -M1
 239 | -M3
 241 |
| -M40
 240 | -27PF
 241
CRE = 1,5 - 4,0 mm |
| -E
 238 | |
| -F2
 237 | |
| -27P
 227 | |
- Cutting width
CW = 2,0 - 6,0 mm

TC

Thread turning

- | |
|---|
| Partial profile
60°  248 |
| Full profile
60°  247 |
| Full profile
55°  249 |
| Partial profile
55°  250 |

TX

Parting



Circlip Grooving Inserts



For corner relief

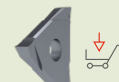

Fine and copy turning

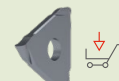

Axial grooving

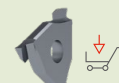

GX
24

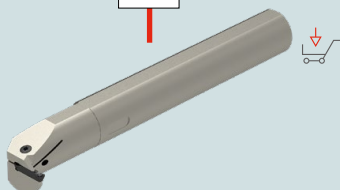

TC

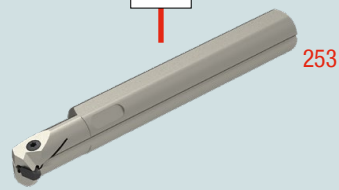

TX

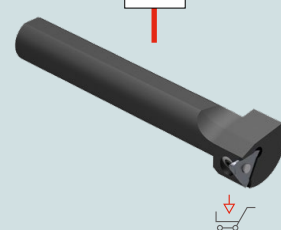

Insert SX

▲ High precision ground geometry

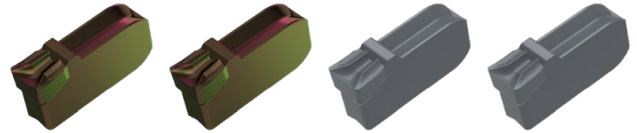
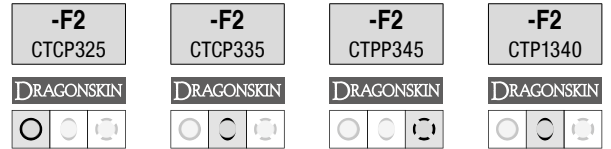
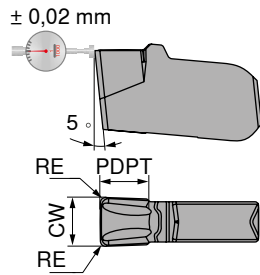
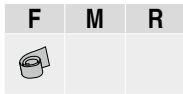
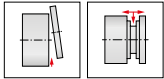

Designation	CW $\pm 0,02$ mm	RE $\pm 0,05$ mm	PDPT mm	for tool holder	70 346 ...	70 346 ...	70 346 ...	70 346 ...
SX E2.00 N 0.20	2	0.2	1.5	-SX2			822	622
SX E3.00 N 0.30	3	0.3	2.0	-SX3	923	523	823	623
P					●	●	●	●
M					○	○	●	●
K					●	●		●
N								○
S					○		○	●
H								
O								○

→ v_c Page 261
→ Application recommendation on page 266

Internal machining

External machining

		→ 214	→ 215+216					

Insert SX

▲ Specially developed geometry with negative edge-chamfers available in right, left and neutral types

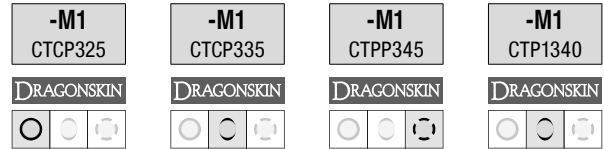

Designation	IH	CW ± 0.05 mm	RE ± 0.05 mm	PSIR	for tool holder	70 342 ...	70 342 ...	70 342 ...	70 342 ...
SX E2.00 L 6	L	2	0.2	6°	-SX2				612
SX E3.00 L 6	L	3	0.2	6°	-SX3	913			613
SX E2.00 N 0.20	N	2	0.2		-SX2	922		822	622
SX E3.00 N 0.20	N	3	0.2		-SX3	923	523	823	623
SX E2.00 R 6	R	2	0.2	6°	-SX2				602
SX E3.00 R 6	R	3	0.2	6°	-SX3	903			603
P						●	●	●	●
M						○	○	●	●
K						●	●		●
N									○
S						○		○	●
H									
O									○

→ v_c Page 261
→ Application recommendation on page 267

Note: reduce feed rate by 20–50 % with R/L version!

Internal machining

External machining

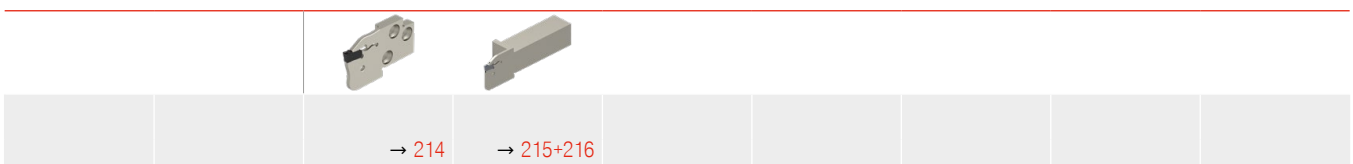

Insert SX

▲ All purpose geometry for parting, grooving & turning.

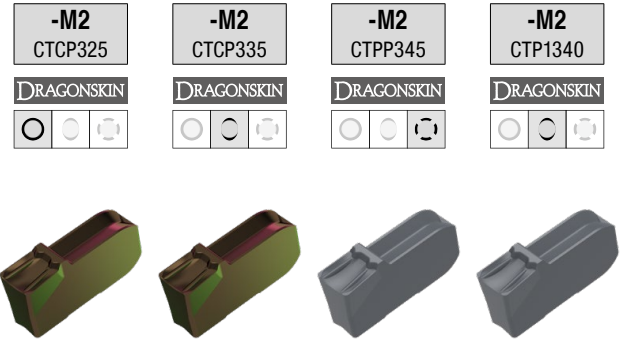
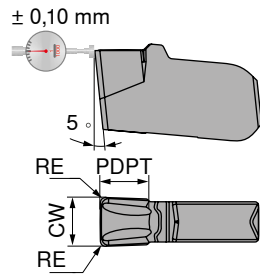
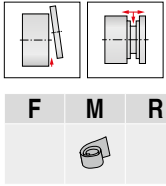

Designation	CW $\pm 0,05$ mm	RE $\pm 0,05$ mm	PDPT mm	for tool holder	70 343 ...		70 343 ...		70 343 ...		70 343 ...	
					922	923	522	523	822	823	622	623
SX E2.00 N 0.20	2	0.2	1.5	-SX2	●	○	●	○	●	○	●	○
SX E3.00 N 0.30	3	0.3	2.0	-SX3	●	○	●	○	●	○	●	○
P					●	○	●	○	●	○	●	○
M					○	○	○	○	○	○	○	○
K					●	○	●	○	●	○	●	○
N					○	○	○	○	○	○	○	○
S					○	○	○	○	○	○	○	○
H												
O												○

→ v_c Page 261
→ Application recommendation on page 266

Internal machining

External machining

		→ 214	→ 215+216								

Insert SX

- ▲ Insert with highly positive cutting edge geometry and sharp cutting edge
- ▲ Specialist for aluminum and other soft long-chipping non-ferrous metals

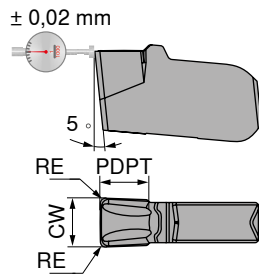
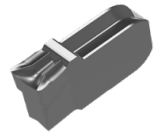
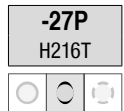
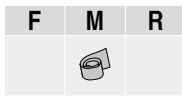
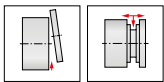

70 349 ...

Designation	CW $\pm 0,02$ mm	RE $\pm 0,05$ mm	PDPT mm	for tool holder	
SX E2.00 N 0.20	2	0.2	2.0	-SX2	122
SX E3.00 N 0.30	3	0.3	2.5	-SX3	123

P	
M	
K	●
N	●
S	○
H	
O	○

→ v_c Page 261
→ Application recommendation on page 266

Internal machining

External machining



			→ 214	→ 215+216					

3

ModularClamp MSS – Radial grooving module SX

▲ for parting, grooving and finish turning

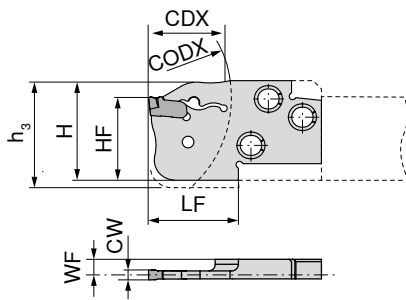

Illustrations show right-hand versions

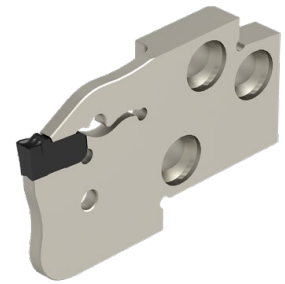

Designation	HF mm	CW mm	WF mm	LF mm	H mm	h ₃ mm	CODX mm	CDX mm	for grooving inserts	Left-hand	Right-hand
										70 897 ...	70 896 ...
E20 R/L 20-SX2	20	2	3.57	22	24	27	60	20	SX .2..	020	020
E20 R/L 20-SX3	20	3	3.20	22	24	27	60	20	SX .3..	120	120

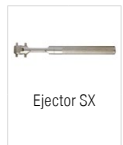

Ejector SX

Spare parts for grooving inserts

SX .2..	SX 2-3	836
SX .3..	SX 2-3	836

70 950 ...

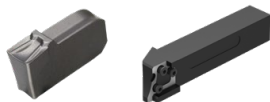

→ 210-213

→ 259

 Please order SX assembly key separately if required.

MonoClamp – Radial Monoholder SX-DC

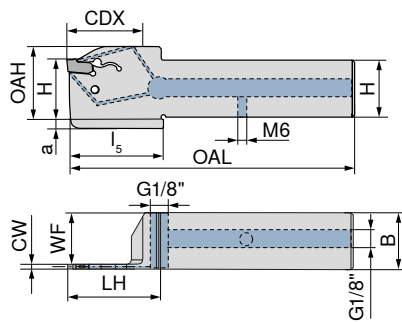

Illustrations show right-hand versions

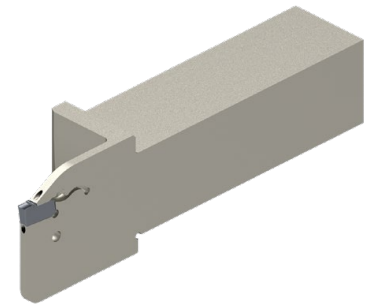

Designation	H mm	B mm	CW mm	WF mm	OAL mm	LH mm	I ₅ mm	OAH mm	CDX mm	a mm	for grooving inserts	Left-hand	Right-hand
												70 847 ...	70 847 ...
E12 R/L 0022-1212X-K-DC-SX2	12	12	2	11.2	71	27	28	22	22	5	SX .2..	21201	21200
E16 R/L 0026-1616X-K-DC-SX2	16	16	2	15.2	87	32	33	26	26	4	SX .2..	21601	21600
E20 R/L 0026-2020X-K-DC-SX2	20	20	2	19.2	102	32	33	31	26	5	SX .2..	22001	22000
E16 R/L 0026-1616X-K-DC-SX3	16	16	3	14.8	87	32	33	26	26	4	SX .3..	31601	31600
E20 R/L 0026-2020X-K-DC-SX3	20	20	3	18.8	102	32	33	31	26	5	SX .3..	32001	32000



**Spare parts
for grooving inserts**

	Left-hand	Right-hand
SX .2..	SX 2-3	836
SX .3..	SX 2-3	836

70 950 ...



→ 210-213

1 Please order SX assembly key separately if required.

MonoClamp – Radial Monoholder SX

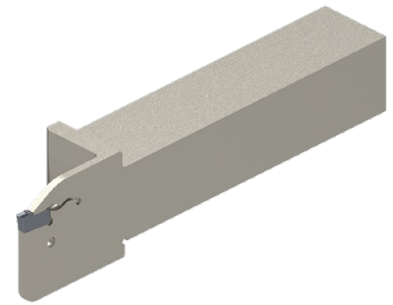
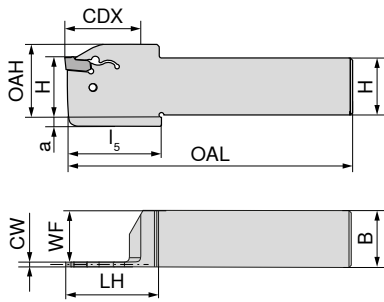

Illustrations show right-hand versions

Designation	H mm	B mm	CW mm	WF mm	OAL mm	LH mm	l ₅ mm	OAH mm	CDX mm	a mm	for grooving inserts	Left-hand	Right-hand
												70 846 ...	70 846 ...
E12 R/L 0022-1212K-K-SX2	12	12	2	11.2	125	27	28	22	22	5	SX .2..	21201	21200
E16 R/L 0026-1616K-K-SX2	16	16	2	15.2	125	33	33	26	26	4	SX .2..	21601	21600
E20 R/L 0026-2020K-K-SX2	20	20	2	19.2	125	33	33	31	26	5	SX .2..	22001	22000
E16 R/L 0026-1616K-K-SX3	16	16	3	14.8	125	33	33	26	26	4	SX .3..	31601	31600
E20 R/L 0026-2020K-K-SX3	20	20	3	18.8	125	31	33	31	26	5	SX .3..	32001	32000



Ejector SX

Spare parts for grooving inserts

	Left-hand	Right-hand
SX .2..	SX 2-3	836
SX .3..	SX 2-3	836

70 950 ...



→ 210-213

Please order SX assembly key separately if required.

Insert FX

- ▲ Excellent cutting geometry with low cutting forces
- ▲ Very good swarf control also with low feed rates
- ▲ Reduced built-up edge

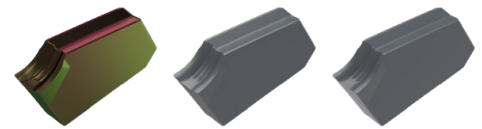
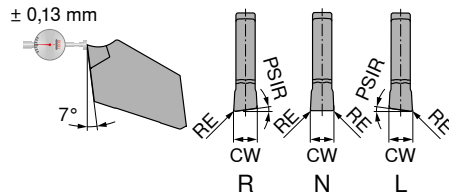
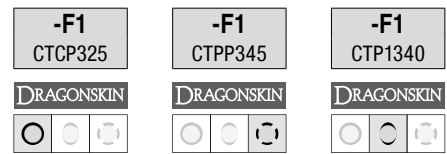
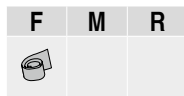
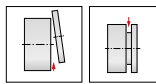

Designation	IH	CW _{-0,1} mm	RE _{+/-0,05} mm	PSIR	for tool holder	70 331 ...		
FX 2.2 L 5-F1	L	2.2	0.15	5°	-FX 2.2		847	647
FX 3.1 L 5-F1	L	3.1	0.20	5°	-FX 3.1		851	651
FX 3.1 L 8-F1	L	3.1	0.20	8°	-FX 3.1		855	
FX 2.2 N 0.15-F1	N	2.2	0.15		-FX 2.2	998	848	648
FX 3.1 N 0.20-F1	N	3.1	0.20		-FX 3.1	902	852	652
FX 3.1 N 0.40-F1	N	3.1	0.40		-FX 3.1	906	856	656
FX 2.2 R 5-F1	R	2.2	0.15	5°	-FX 2.2		849	649
FX 3.1 R 5-F1	R	3.1	0.20	5°	-FX 3.1		853	653
FX 3.1 R 8-F1	R	3.1	0.20	8°	-FX 3.1		857	
P						●	●	●
M						○	●	●
K						●		●
N								○
S						○	○	●
H								
O								○

→ v_c Page 261
→ Application recommendation on page 268

Note: reduce feed rate by 20–50 % with R/L version!

Internal machining

External machining



→ 221

→ 222

Insert FX

▲ narrow version

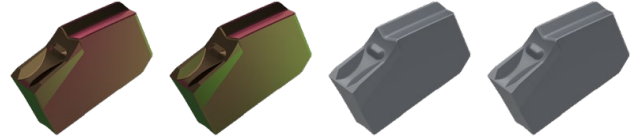
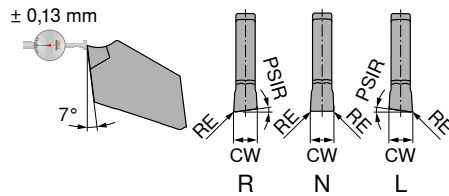
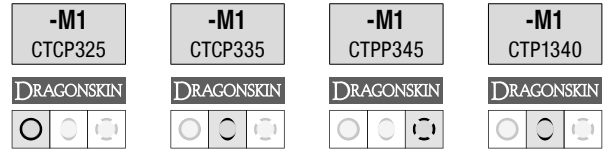
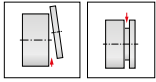

Designation	IH	CW _{-0.1} mm	RE _{±0.05} mm	PSIR	for tool holder	70 330 ...	70 330 ...	70 330 ...	70 330 ...
FX 2.2 L 4-M1	L	2.2	0.1	4°	-FX 2.2		550	800	600
FX 2.2 N 0.10-M1	N	2.2	0.1		-FX 2.2	902	552	802	602
FX 2.2 R 4-M1	R	2.2	0.1	4°	-FX 2.2		554	804	604
P						●	●	●	●
M						○	○	●	●
K						●	●		●
N									○
S						○		○	●
H									
O									○

→ v_c Page 261
→ Application recommendation on page 268

Note: reduce feed rate by 20–50 % with R/L version!

Internal machining

External machining



→ 221

→ 222

Insert FX

▲ wide version

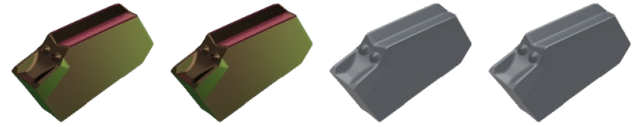
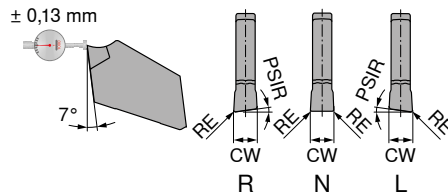
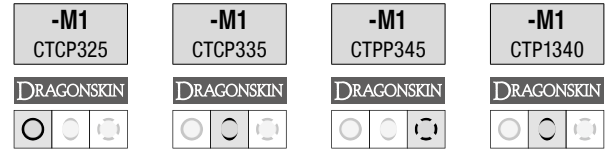
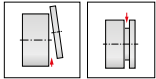

Designation	IH	CW $\pm 0,05$ mm	RE $\pm 0,05$ mm	PSIR	for tool holder	70 332 ...			
						900	550	800	600
FX 3.1 L 6-M1	L	3.1	0.15	6°	-FX 3.1	900	550	800	600
FX 3.1 N 0.15-M1	N	3.1	0.15		-FX 3.1	902	552	802	602
FX 3.1 R 6-M1	R	3.1	0.15	6°	-FX 3.1	904	554	804	604
P						●	●	●	●
M						○	○	●	●
K						●	●		●
N									○
S						○		○	●
H									
O									○

→ v_c Page 261
→ Application recommendation on page 268

Note: reduce feed rate by 20–50 % with R/L version!

Internal machining

External machining



→ 221

→ 222

Insert FX

- ▲ Insert with highly positive cutting edge geometry and sharp cutting edge, polished chip breaker
- ▲ Reduced built-up edge

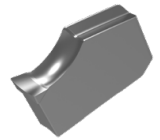
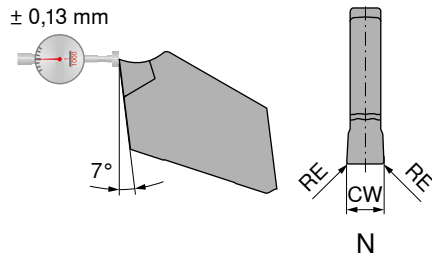
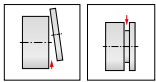

70 334 ...

Designation	IH	CW ^{-0,1} mm	RE ^{-0,05} mm	for tool holder
FX 2.2 N 0.10	N	2.2	0.10	-FX 2.2
FX 3.1 N 0.15	N	3.1	0.15	-FX 3.1

650
652

P	
M	
K	●
N	●
S	○
H	
O	○

→ v_c Page 261
→ Application recommendation on page 268

Internal machining

External machining



→ 221

→ 222

ModularClamp MSS – Radial grooving module FX short/long

▲ For parting and grooving

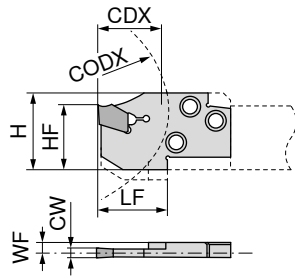

Illustrations show right-hand versions

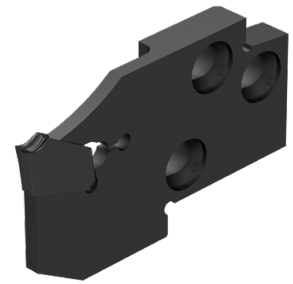

Designation	HF mm	CW mm	WF mm	LF mm	H mm	CODX mm	CDX mm	for grooving inserts	Left-hand	Right-hand
									70 876 ...	70 875 ...
E20 R/L 20-FX 2.2	23	2.2	3.58	22	27	60	20	FX 2.2 ..	020	020
E20 R/L 20-FX 3.1	23	3.1	3.20	22	27	60	20	FX 3.1 ..	120	120

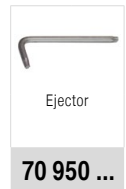

Spare parts for grooving inserts

FX 2.2 ..	375
FX 3.1 ..	376

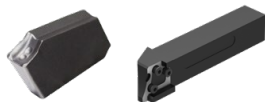

→ 217-220	→ 259+260								
-----------	-----------	--	--	--	--	--	--	--	--

MonoClamp – Radial Monoholder FX

Scope of supply:

Blade and ejector

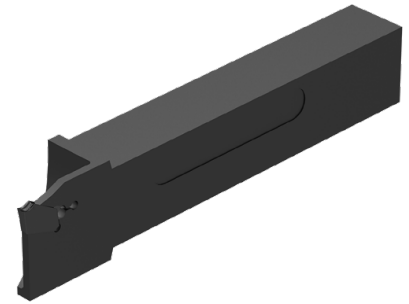
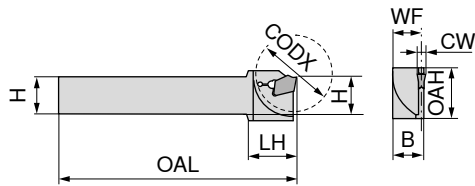

Illustrations show right-hand versions

Designation	H mm	B mm	OAL mm	LH mm	OAH mm	CW mm	WF mm	CODX mm	for grooving inserts	Left-hand	Right-hand
										70 837 ...	70 836 ...
XLCE R/L 1010 M-FX2.2	10	10	150	19.4	21	2.2	9.18	30	FX 2.2 ..	101	101
XLCE R/L 1212 F-FX2.2	12	12	80	21.0	21	2.2	11.18	30	FX 2.2 ..	102	102
XLCE R/L 1212 M-FX2.2	12	12	150	19.4	21	2.2	11.18	30	FX 2.2 ..	103	103
XLCE R/L 1414 M-FX2.2	14	14	150	19.4	21	2.2	13.18	30	FX 2.2 ..	104	104
XLCE R/L 1612 H-FX2.2	16	12	100	21.0	21	2.2	11.18	30	FX 2.2 ..	105	105
XLCE R/L 1612 H-FX3.1	16	12	100	21.4	25	3.1	10.80	35	FX 3.1 ..	106	106
XLCE R/L 2016 K-FX3.1	20	16	125	26.4	26	3.1	14.80	40	FX 3.1 ..	107	107



Spare parts
for grooving inserts

FX 2.2 ..	375
FX 3.1 ..	376



→ 217-220

Insert GX 09/16

- ▲ Insert with ground periphery
- ▲ Suitable also for parting off tubes and thin-walled workpieces

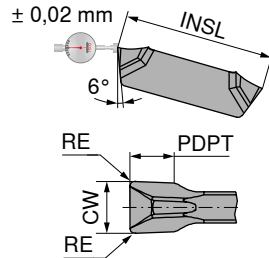
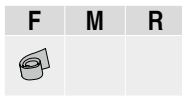
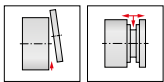

-F2
CTP1340

DRAGONSKIN



70 360 ...

Designation	INSL mm	CW ^{+/-0,02} mm	RE ^{+/-0,05} mm	PDPT mm	for tool holder	
GX 09-1 E2.00 N 0.20	9	2.0	0.2	1.5	GX 09-1	600
GX 09-1 E2.50 N 0.20	9	2.5	0.2	1.5	GX 09-1	602
GX 09-2 E3.00 N 0.30	9	3.0	0.3	2.0	GX 09-2	604
GX 16-1 E2.00 N 0.20	16	2.0	0.2	2.5	GX 16-1	650
GX 16-2 E3.00 N 0.30	16	3.0	0.3	3.0	GX 16-2	652

P	●
M	●
K	●
N	○
S	●
H	
O	○

→ v_c Page 261
→ Application recommendation on page 262

Internal machining

External machining

→ 235+236	→ 230+231	→ 232						

3

Insert GX 09/16 – Standard

▲ Suitable for parting thin-walled workpieces

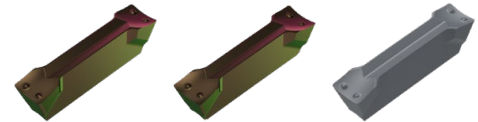
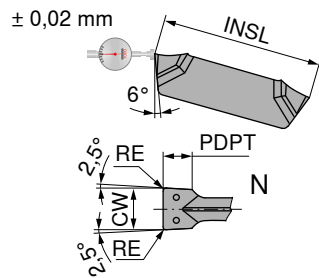
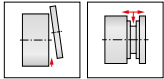

Designation	INSL mm	CW $\pm 0,02$ mm	RE $\pm 0,05$ mm	PDPT mm	for tool holder
GX 09-1 E2.00 N 0.20	9	2.0	0.2	1.5	GX 09-1
GX 09-1 E2.50 N 0.20	9	2.5	0.2	1.5	GX 09-1
GX 09-2 E3.00 N 0.30	9	3.0	0.3	2.0	GX 09-2
GX 16-1 E2.00 N 0.20	16	2.0	0.2	2.5	GX 16-1
GX 16-1 E2.50 N 0.20	16	2.5	0.2	2.5	GX 16-1
GX 16-2 E3.00 N 0.30	16	3.0	0.3	3.0	GX 16-2
GX 16-2 E3.00 N 0.50	16	3.0	0.5	3.0	GX 16-2

70 350 ...	70 350 ...	70 350 ...
984		634
988		638
992		642
900	500	600
904	504	604
908	508	608
910		

P	●	●	●
M	○	○	●
K	●	●	●
N			○
S	○		●
H			
O			○

→ v_c Page 261
→ Application recommendation on page 262

Internal machining

External machining

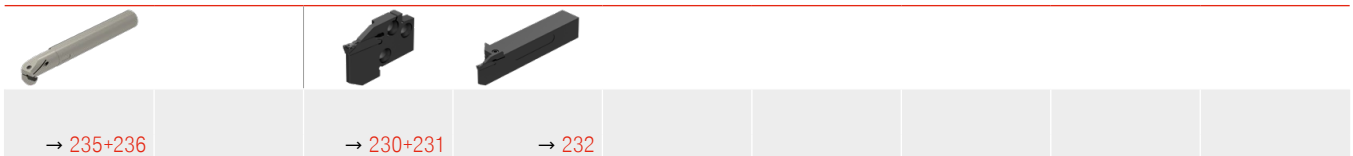

Insert GX 09/16

▲ Very good swarf control

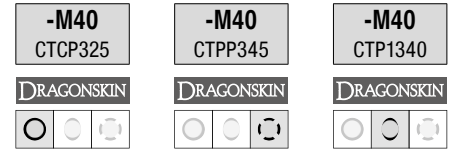
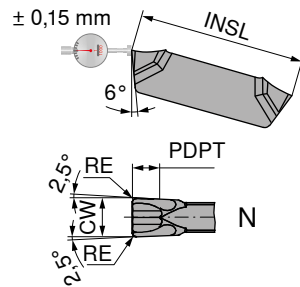
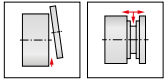

Designation	INSL mm	CW $\pm 0,05$ mm	RE $\pm 0,05$ mm	PDPT mm	for tool holder	70 351 ...	70 351 ...	70 351 ...
						986	886	686
GX 09-1 E2.00 N 0.20	9	2	0.2	1.5	GX 09-1	986	886	686
GX 09-2 E3.00 N 0.30	9	3	0.3	2.0	GX 09-2	994	894	694
GX 16-1 E2.00 N 0.20	16	2	0.2	2.5	GX 16-1	902	802	602
GX 16-2 E3.00 N 0.30	16	3	0.3	3.0	GX 16-2	910	810	610
P						●	●	●
M						○	●	●
K						●	○	○
N								○
S						○	○	●
H								
O								○

→ v_c Page 261
→ Application recommendation on page 262

Internal machining

External machining

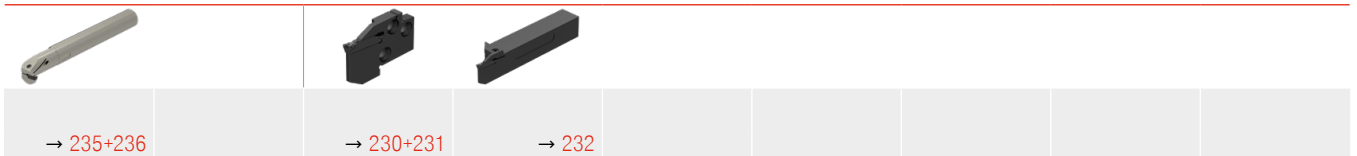

Insert GX 16

▲ Very good swarf control

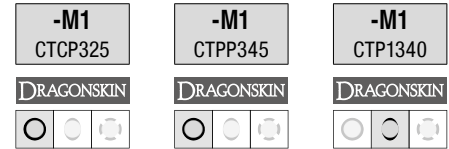
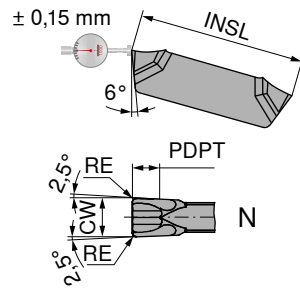

Designation	INSL mm	CW $\pm 0,05$ mm	RE $\pm 0,05$ mm	PDPT mm	for tool holder	70 362 ...	70 362 ...	70 362 ...
GX 16-1 E2.00 N 0.20	16	2	0.2	2.0	GX 16-1		800	600
GX 16-2 E3.00 N 0.20	16	3	0.2	2.5	GX 16-2	902	802	602
P						●	●	●
M						○	●	●
K						●	○	●
N								○
S						○	○	●
H								
O								○

→ v_c Page 261
→ Application recommendation on page 263

Internal machining

External machining

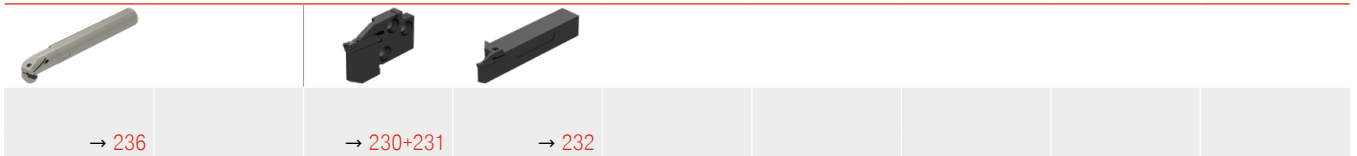

Insert GX 16

- ▲ Insert with highly positive cutting edge geometry and sharp cutting edge
- ▲ ground periphery

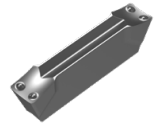
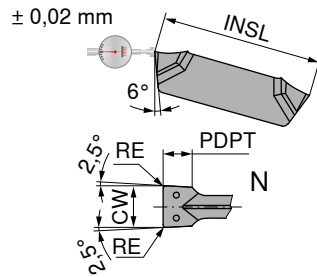
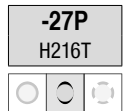
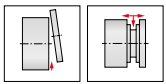

70 350 ...

Designation	INSL mm	CW $\pm 0,02$ mm	RE $\pm 0,05$ mm	PDPT mm	for tool holder	
GX 16-1 E2.00 N 0.20	16	2	0.2	2.5	GX 16-1	650
GX 16-2 E3.00 N 0.30	16	3	0.3	3.0	GX 16-2	658

P	
M	
K	●
N	●
S	○
H	
O	○

→ v_c Page 261
→ Application recommendation on page 262

Internal machining

External machining

→ 236	→ 230+231	→ 232						

Circlip groove insert GX 09/16 – Standard

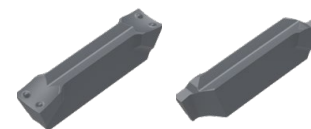
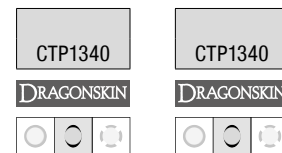
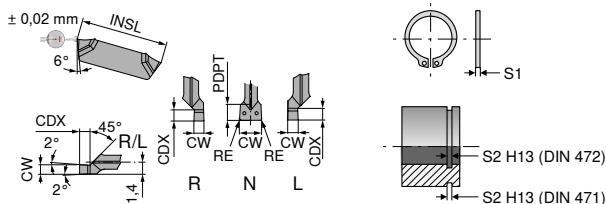
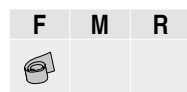

Designation	IH	INSL mm	S ₁ mm	S ₂ mm	CW ± 0.02 mm	RE ± 0.05 mm	CDX mm	PDPT mm	for tool holder	70 352 ...	70 352 ...
GX 09-1 S0.60 L	L	9	0.40	0.50	0.60		0.75		R/L 02-GX 09-1		679
GX 09-1 S0.80 L	L	9	0.60	0.70	0.80		0.94		R/L 02-GX 09-1		681
GX 09-1 S0.90 L	L	9	0.70	0.80	0.90		1.04		R/L 02-GX 09-1		683
GX 09-1 S1.00 L	L	9	0.80	0.90	1.00		1.14		R/L 02-GX 09-1		684
GX 09-1 S1.20 L	L	9	1.00	1.10	1.20		1.34		R/L 02-GX 09-1		686
GX 09-1 S1.40 L	L	9	1.20	1.30	1.40		1.53		R/L 02-GX 09-1		688
GX 09-1 S1.70 L	L	9	1.50	1.60	1.70		1.82		R/L 02-GX 09-1		690
GX 16-2 S0.60 L	L	16	0.40	0.50	0.60		0.75		R/L 03-GX 16-2		607
GX 16-2 S0.80 L	L	16	0.60	0.70	0.80		0.94		R/L 03-GX 16-2		609
GX 16-2 S0.90 L	L	16	0.70	0.80	0.90		1.04		R/L 03-GX 16-2		611
GX 16-2 S1.00 L	L	16	0.80	0.90	1.00		1.14		R/L 03-GX 16-2		612
GX 16-2 S1.20 L	L	16	1.00	1.10	1.20		1.34		R/L 03-GX 16-2		614
GX 16-2 S1.40 L	L	16	1.20	1.30	1.40		1.53		R/L 03-GX 16-2		616
GX 16-2 S1.70 L	L	16	1.50	1.60	1.70		1.82		R/L 03-GX 16-2		618
GX 16-2 S1.95 L	L	16	1.75	1.85	1.95		2.07		R/L 03-GX 16-2		620
GX 16-2 S2.25 L	L	16	2.00	2.15	2.25		2.36		R/L 03-GX 16-2		622
GX 09-1 S1.95 N	N	9	1.75	1.85	1.95	0.1		2	GX 09-1	692	
GX 09-1 S2.25 N	N	9	2.00	2.15	2.25	0.1		2	GX 09-1	694	
GX 09-2 S2.75 N	N	9	2.50	2.65	2.75	0.1		2	GX 09-2	696	
GX 09-2 S3.25 N	N	9	3.00	3.15	3.25	0.1		2	GX 09-2	698	
GX 16-2 S2.75 N	N	16	2.50	2.65	2.75	0.1		3	GX 16-2	624	
GX 16-2 S3.25 N	N	16	3.00	3.15	3.25	0.1		3	GX 16-2	626	
GX 09-1 S0.60 R	R	9	0.40	0.50	0.60		0.75		R/L 02-GX 09-1		670
GX 09-1 S0.80 R	R	9	0.60	0.70	0.80		0.94		R/L 02-GX 09-1		672
GX 09-1 S0.90 R	R	9	0.70	0.80	0.90		1.04		R/L 02-GX 09-1		674
GX 09-1 S1.00 R	R	9	0.80	0.90	1.00		1.14		R/L 02-GX 09-1		676
GX 09-1 S1.20 R	R	9	1.00	1.10	1.20		1.34		R/L 02-GX 09-1		678
GX 09-1 S1.40 R	R	9	1.20	1.30	1.40		1.53		R/L 02-GX 09-1		680
GX 09-1 S1.70 R	R	9	1.50	1.60	1.70		1.82		R/L 02-GX 09-1		682
GX 16-2 S0.60 R	R	16	0.40	0.50	0.60		0.75		R/L 03-GX 16-2		695
GX 16-2 S0.80 R	R	16	0.60	0.70	0.80		0.94		R/L 03-GX 16-2		697
GX 16-2 S0.90 R	R	16	0.70	0.80	0.90		1.04		R/L 03-GX 16-2		699
GX 16-2 S1.00 R	R	16	0.80	0.90	1.00		1.14		R/L 03-GX 16-2		600
GX 16-2 S1.20 R	R	16	1.00	1.10	1.20		1.34		R/L 03-GX 16-2		602
GX 16-2 S1.40 R	R	16	1.20	1.30	1.40		1.53		R/L 03-GX 16-2		604
GX 16-2 S1.70 R	R	16	1.50	1.60	1.70		1.82		R/L 03-GX 16-2		606
GX 16-2 S1.95 R	R	16	1.75	1.85	1.95		2.07		R/L 03-GX 16-2		608
GX 16-2 S2.25 R	R	16	2.00	2.15	2.25		2.36		R/L 03-GX 16-2		610
P										●	●
M										●	●
K										●	●
N										○	○
S										●	●
H											
O										○	○

→ v_c Page 261

→ Application recommendation on page 262



Attention - applies only to internal machining:

Right-hand insert → left-hand module or monobloc boring bar

Left-hand insert → right-hand module or monobloc boring bar

Internal machining

External machining

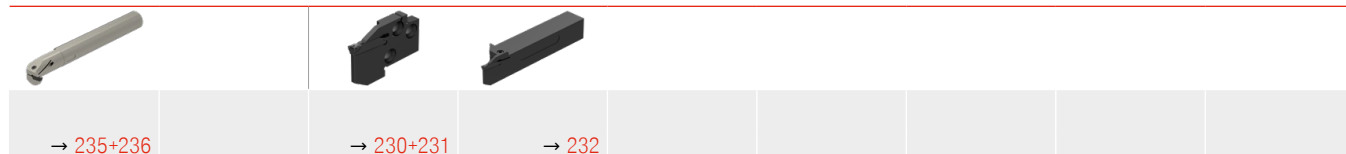

Radius groove insert GX 09/16

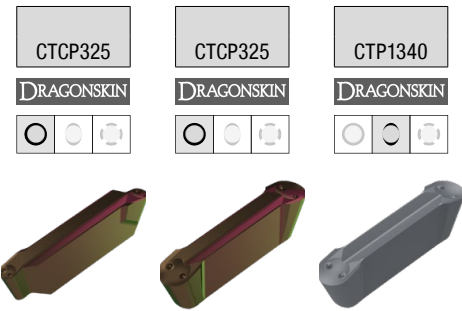
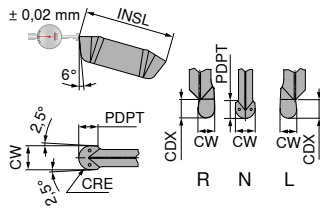

Designation	IH	INSL mm	CW ± 0.02 mm	CRE mm	PDPT mm	CDX mm	for tool holder	70 354 ...	70 354 ...	70 354 ...
GX 09-1 R0.80 L	L	9	1.6	0.8		1.78	R/L 02-GX 09-1	988		
GX 16-2 R0.80 L	L	16	1.6	0.8		1.78	R/L 03-GX 16-2	912		
GX 16-2 R1.00 L	L	16	2.0	1.0		2.18	R/L 03-GX 16-2	916		
GX 16-2 R1.20 L	L	16	2.4	1.2		2.58	R/L 03-GX 16-2	920		
GX 09-1 R1.00 N	N	9	2.0	1.0	1.0		GX 09-1		992	
GX 09-1 R1.20 N	N	9	2.4	1.2	1.2		GX 09-1		996	
GX 16-2 R1.50 N	N	16	3.0	1.5	1.5		GX 16-2		924	624
GX 09-1 R0.80 R	R	9	1.6	0.8		1.78	R/L 02-GX 09-1	984		
GX 16-2 R0.80 R	R	16	1.6	0.8		1.78	R/L 03-GX 16-2	900		
GX 16-2 R1.00 R	R	16	2.0	1.0		2.18	R/L 03-GX 16-2	904		
GX 16-2 R1.20 R	R	16	2.4	1.2		2.58	R/L 03-GX 16-2	908		
P								●	●	●
M								○	○	●
K								●	●	●
N										○
S								○	○	●
H										
O										○

→ v_c Page 261
→ Application recommendation on page 263



Attention - applies only to internal machining:
Right-hand insert → left-hand module or monobloc boring bar
Left-hand insert → right-hand module or monobloc boring bar

Internal machining

External machining

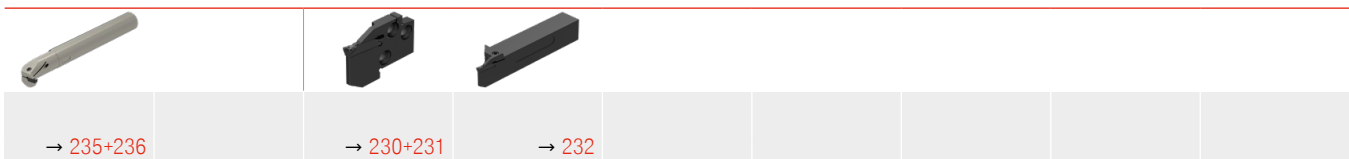

ModularClamp MSS – Radial grooving module GX 09/16

- ▲ For circlip grooves $\leq 2,75$ mm
- ▲ For radius grooves up to $\leq 1,2$ mm
- ▲ For external recessing

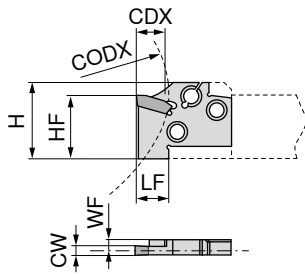

Illustrations show right-hand versions



Designation	CW mm	WF mm	LF mm	HF mm	H mm	CODX mm	CDX mm	for grooving inserts	Left-hand	Right-hand
									70 871 ...	70 870 ...
E12 R/L 02-GX 09-1	<1,95	3.15	8	12	14.5	36	2	GX 09-1 ..R/L	112	112
E16 R/L 02-GX 09-1	<1,95	3.15	8	16	19.5	48	2	GX 09-1 ..R/L	116	116
E20 R/L 03-GX 16-2	<2,75	3.40	13	20	24.0	60	3	GX 16-2 ..R/L	120	120

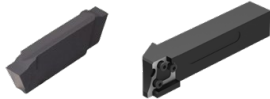

→ 223-229	→ 259+260									
-----------	-----------	--	--	--	--	--	--	--	--	--

ModularClamp MSS – Radial grooving module GX 09/16

- ▲ For grooving and turning
- ▲ For circlip grooves ≤ 5,25 mm
- ▲ For radius grooves up to ≤ 2,5 mm
- ▲ For external recessing

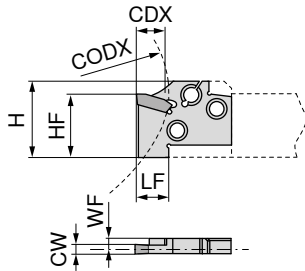

Illustrations show right-hand versions

Designation	CW mm	WF mm	LF mm	HF mm	H mm	CODX mm	CDX mm	for grooving inserts	Left-hand	Right-hand
									70 866 ...	70 865 ...
E12 R/L 07-GX 09-1	2,00 - 2,75	3.15	8	12	14.5	36	7	GX 09-1 ..N	012	012
E12 R/L 07-GX 09-2	2,76 - 3,75	3.15	8	12	14.5	36	7	GX 09-2 ..N	112	112
E16 R/L 07-GX 09-1	2,00 - 2,75	3.15	8	16	19.5	48	7	GX 09-1 ..N	016	016
E16 R/L 07-GX 09-2	2,76 - 3,75	3.15	8	16	19.5	48	7	GX 09-2 ..N	116	116
E20 R/L 12-GX 16-1	2,00 - 2,75	3.75	13	20	24.0	60	12	GX 16-1 ..N	020	020
E20 R/L 12-GX 16-2	2,76 - 3,75	3.40	13	20	24.0	60	12	GX 16-2 ..N	120	120

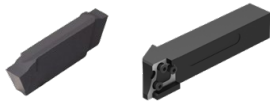

→ 223-229	→ 259+260									
-----------	-----------	--	--	--	--	--	--	--	--	--

MonoClamp – Radial Monoholder GX 09

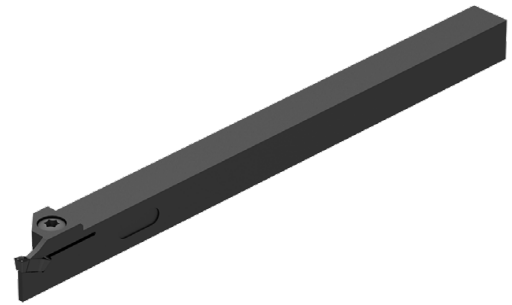
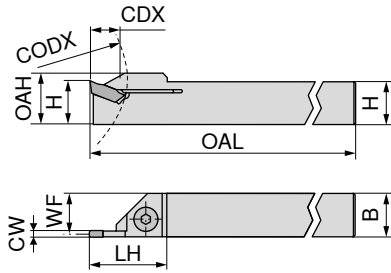

Illustrations show right-hand versions

Designation	H mm	B mm	CW mm	WF mm	OAH mm	OAL mm	LH mm	CODX mm	CDX mm	for grooving inserts GX 09 ..	Left-hand	Right-hand
											70 863 ...	70 862 ...
E10 R/L 00-1010M-GX09	10	10	2,00-3,50	9.35	12	150	18	30	7	GX 09 ..	010	010



When using 'R' or 'L' tools the tool must be modified at the end face to ensure cutting clearance.

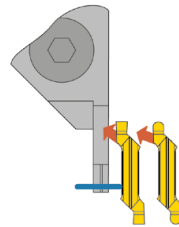

Spare parts
for grooving inserts
GX 09 ..

	80 950 ...	70 950 ...
Key D	T15	442
Clamping screw	113 M4x11	



→ 223-229									
-----------	--	--	--	--	--	--	--	--	--

MonoClamp – Radial Monoholder GX-DC 16

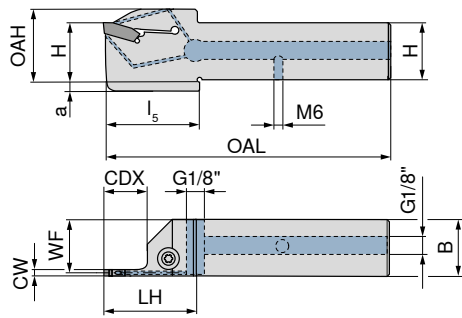

Illustrations show right-hand versions

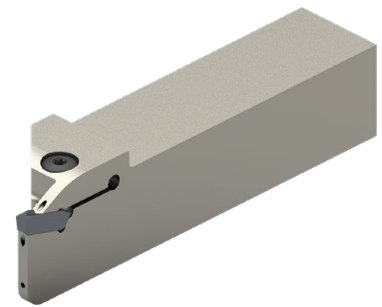

NEW Left-hand **NEW** Right-hand

Designation	H mm	B mm	CW mm	WF mm	OAH mm	OAL mm	LH mm	l _s mm	a mm	CDX mm	for grooving inserts	70 842 ...	
												Left-hand	Right-hand
E16 R/L 0013S2-1616X-S-DC-GX16	16	16	2	15.20	21	90	35	36	4	13	GX 16-1 E2..	21601	21600
E16 R/L 0013S3-1616X-S-DC-GX16	16	16	3	14.85	21	90	35	36	4	13	GX 16-2 E3..	31601	31600
E20 R/L 0013S2-2020X-S-DC-GX16	20	20	2	19.20	25	104	35			13	GX 16-1 E2..	22001	22000
E20 R/L 0013S3-2020X-S-DC-GX16	20	20	3	18.85	25	104	35			13	GX 16-2 E3..	32001	32000

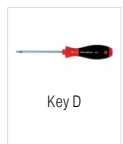

80 950 ...

**Spare parts
for grooving inserts**

GX 16-1 E2..	T15 - IP	128
GX 16-2 E3..	T15 - IP	128

Suitable indexable inserts and cutting data can be found in the catalogue Cutting tools → **Chapter 11 – Grooving tools**

MonoClamp – Radial Monoholder GX 16

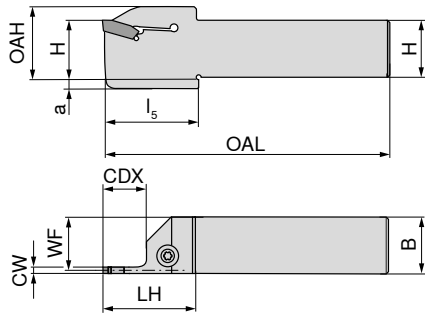

Illustrations show right-hand versions

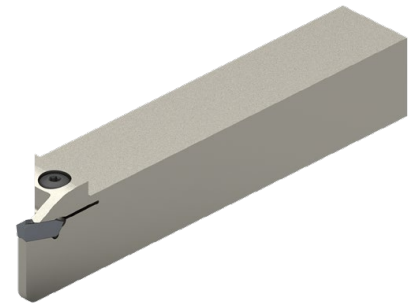

NEW	NEW
Left-hand	Right-hand
70 843 ...	70 843 ...

Designation	H mm	B mm	CW mm	WF mm	OAH mm	OAL mm	LH mm	I _s mm	a mm	CDX mm	for grooving inserts	70 843 ...	70 843 ...
E12 R/L 0013S2-1212K-S-GX16	12	12	2	11.20	17	125	25	26	4	13	GX 16-1 E2..	21201	21200
E12 R/L 0013S3-1212K-S-GX16	12	12	3	10.85	17	125	25	26	4	13	GX 16-2 E3..	31201	31200
E16 R/L 0013S2-1616K-S-GX16	16	16	2	15.20	21	125	25	26	4	13	GX 16-1 E2..	21601	21600
E16 R/L 0013S3-1616K-S-GX16	16	16	3	14.85	21	125	25	26	4	13	GX 16-2 E3..	31601	31600
E20 R/L 0013S2-2020K-S-GX16	20	20	2	19.20	25	125	25			13	GX 16-1 E2..	22001	22000
E20 R/L 0013S3-2020K-S-GX16	20	20	3	18.85	25	125	25			13	GX 16-2 E3..	32001	32000

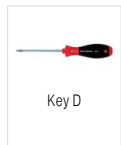

Spare parts for grooving inserts

GX 16-1 E2..	T15 - IP	128
GX 16-2 E3..	T15 - IP	128

Suitable indexable inserts and cutting data can be found in the catalogue Cutting tools → **Chapter 11 – Grooving tools**

MonoClamp – Radial Mono-boring bars GX 09

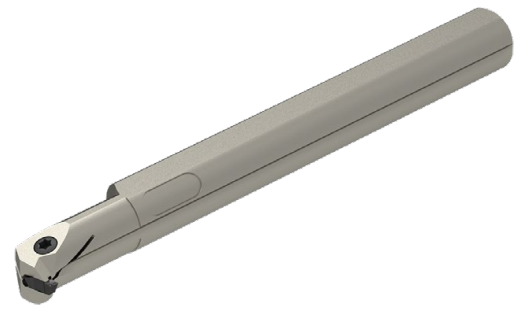
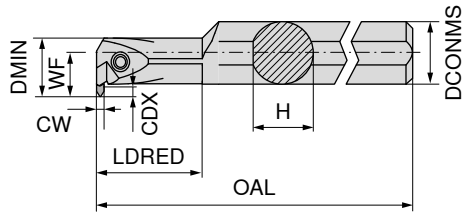

Illustrations show right-hand versions

Designation	H mm	DCONMS mm	DMIN mm	CW mm	CDX mm	WF mm	OAL mm	LDRED mm	for grooving inserts	Left-hand	Right-hand
										70 859 ...	70 858 ...
I12 R/L 90-2,5D-GX09	15.25	16	16	2,00-3,75	3	11	150	30	GX 09 ..	012	012

i Right hand boring bar → left hand insert only
Left hand boring bar → right hand insert only

i When using „R“ or „L“ tools the insert support seat requires modification to prevent the insert fouling.

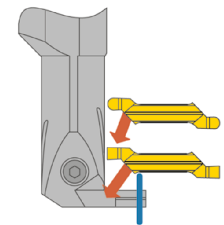

**Spare parts
for grooving inserts**
GX 09 ..

Part	Quantity	Part Number
Key D	113	80 950 ...
Clamping screw	441	70 950 ...



→ 223-229

MonoClamp – Radial Mono-boring bars GX 16

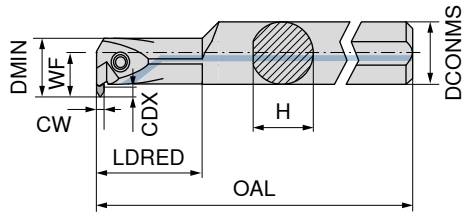

Illustrations show right-hand versions

Designation	H mm	DCONMS mm	DMIN mm	CW mm	CDX mm	WF mm	OAL mm	LDRED mm	for grooving inserts	Left-hand	Right-hand
										70 893 ...	70 892 ...
I16 R/L 90-2.0D-GX16-1	15.25	16	20.5	2,00 - 2,75	5.0	13.5	150	32	GX 16-1	516	516
I16 R/L 90-2.0D-GX16-2	15.25	16	20.5	2,76 - 3,75	5.0	13.5	150	32	GX 16-2	616	616
I20 R/L 90-2.0D-GX16-2	19.00	20	25.0	2,76 - 3,75	5.5	15.5	180	40	GX 16-2	620	620

i Right hand boring bar → left hand insert only
Left hand boring bar → right hand insert only

i When using „R“ or „L“ tools the insert support seat requires modification to prevent the insert fouling.

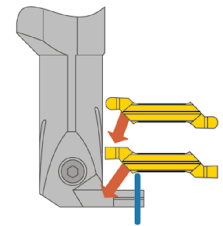

Spare parts for grooving inserts

		80 950 ...	70 950 ...
GX 16-1	T15	113	403
GX 16-2	T15	113	403

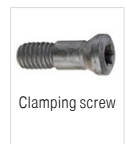
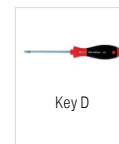

→ 223-229

Insert GX 24

- ▲ Insert with ground periphery
- ▲ Suitable also for parting off tubes and thin-walled workpieces

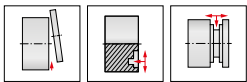

F	M	R

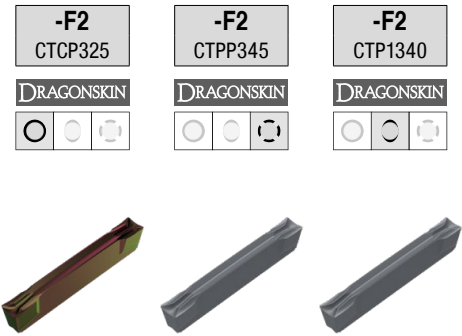
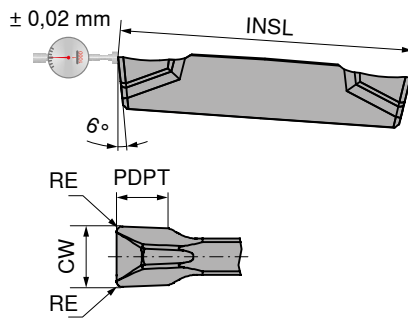

Designation	INSL mm	CW $\pm 0,02$ mm	RE $\pm 0,05$ mm	PDPT mm	for tool holder	70 350 ...		
						962	862	662
GX 24-2 E3.00 N 0.30	24	3.0	0.3	2.5	GX 24-2	●	●	●
GX 24-2 E3.50 N 0.30	24	3.5	0.3	2.5	GX 24-2	○	○	○
P						●	●	●
M						○	○	○
K						●	●	●
N						○	○	○
S						○	○	○
H						○	○	○
O						○	○	○

→ v_c Page 261
→ Application recommendation on page 262

Internal machining

External machining



→ 243

Insert GX 24

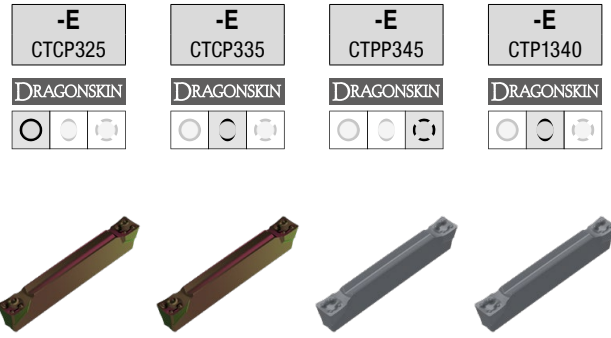
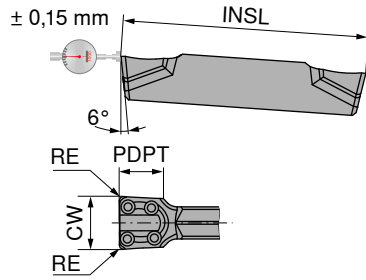
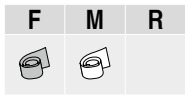
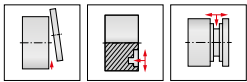

Designation	INSL mm	CW $\pm 0,05$ mm	RE $\pm 0,05$ mm	PDPT mm	for tool holder	70 350 ...			
						932	532	832	632
GX 24-2 E3.00 N 0.30	24	3	0.3	2.5	GX 24-2				
P						●	●	●	●
M						○	○	●	●
K						●	●		●
N									○
S						○		○	●
H									
O									○

→ v_c Page 261
→ Application recommendation on page 262

Internal machining

External machining



→ 243

Insert GX 24

▲ Very good swarf control



F	M	R

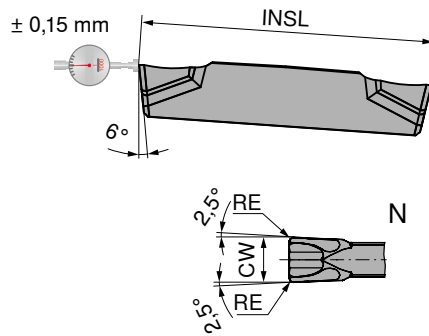

-M1 CTCP325	-M1 CTPP345	-M1 CTP1340
DRAGONSKIN	DRAGONSKIN	DRAGONSKIN



Designation	INSL mm	CW mm	RE mm	for tool holder	70 363 ...		
					900	800	600
GX 24-1 E2.00 N 0.20	24	2	0.2	GX 24-1	900	800	600
GX 24-2 E3.00 N 0.20	24	3	0.2	GX 24-2	902	802	602
P					●	●	●
M					○	●	●
K					●	○	●
N					○	○	○
S					○	○	●
H							
O							○

→ v_c Page 261
→ Application recommendation on page 263

Internal machining

External machining



→ 243

Insert GX 24

▲ Very good swarf control

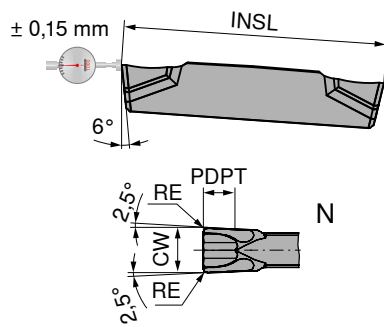
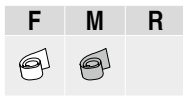
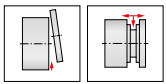

-M40 CTCP325	-M40 CTPP345	-M40 CTP1340
DRAGONSKIN	DRAGONSKIN	DRAGONSKIN



Designation	INSL mm	CW mm	RE mm	PDPT mm	for tool holder	70 364 ...	70 364 ...	70 364 ...
GX 24-2 E3.00 N 0.30	24	3	0.3	3.5	GX 24-2	900	800	600
P						●	●	●
M						○	●	●
K						●	●	●
N								○
S						○	○	●
H								
O								○

→ v_c Page 261
→ Application recommendation on page 262

Internal machining

External machining



→ 243

Radius groove insert GX 24

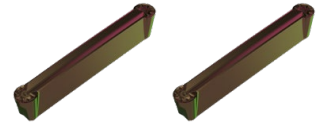
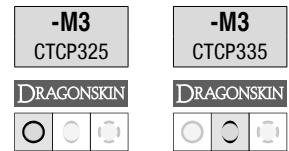
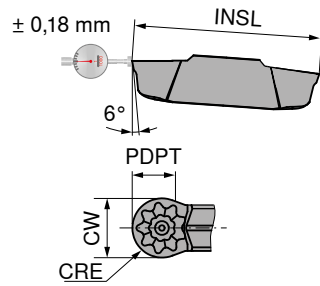
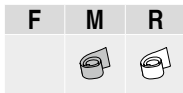
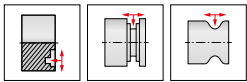

Designation	INSL mm	CW $_{-0,05}$ mm	CRE mm	PDPT mm	for tool holder
GX 24-2 R1.50 N	24.4	3	1.5	1.5	GX 24-2

70 354 ...	70 354 ...
952	552

P	●	●
M	○	○
K	●	●
N		
S	○	
H		
O		

→ v_c Page 261
→ Application recommendation on page 263

Internal machining

External machining



→ 243

Insert GX 24

- ▲ Insert with highly positive cutting edge geometry and sharp cutting edge
- ▲ ground periphery

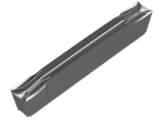
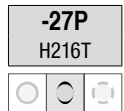
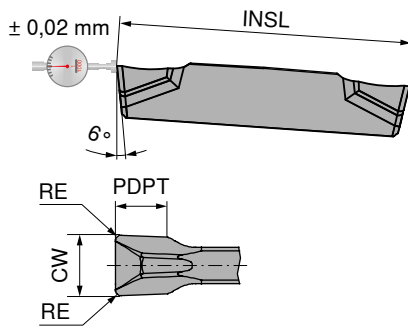
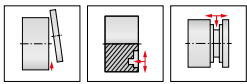

70 350 ...

Designation	INSL mm	CW $\pm 0,02$ mm	RE $\pm 0,05$ mm	PDPT mm	for tool holder
GX 24-2 E3.00 N 0.30	24	3	0.3	2.5	GX 24-2

682

P	
M	
K	●
N	●
S	○
H	
O	○

→ v_c Page 261
→ Application recommendation on page 262

Internal machining

External machining



→ 243

ModularClamp MSS – Radial grooving module GX 24

- ▲ For deep radial parting and grooving
- ▲ For turning

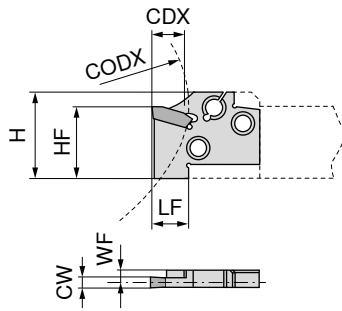

Illustrations show right-hand versions

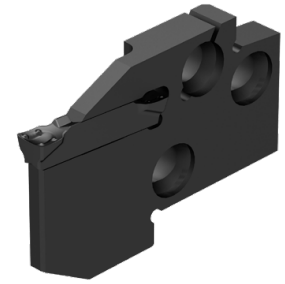

Designation	CW mm	WF mm	LF mm	HF mm	H mm	CODX mm	CDX mm	for grooving inserts	Left-hand	Right-hand
									70 868 ...	70 867 ...
E20 R/L 21-GX 24-1	2,00 - 2,75	3.85	22	20	24	60	21	GX 24-1	020	020
E20 R/L 21-GX 24-2	3	3.40	22	20	24	60	21	GX 24-2	120	120

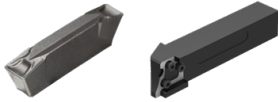

→ 237-242	→ 259+260									
-----------	-----------	--	--	--	--	--	--	--	--	--

MonoClamp – Radial Monoholder GX-DC 24

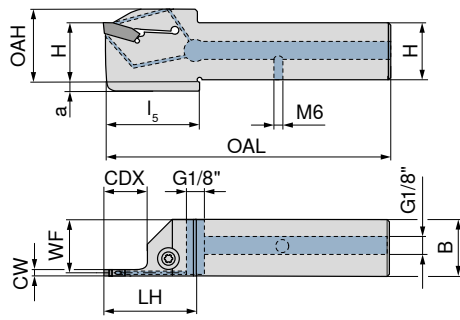

Illustrations show right-hand versions

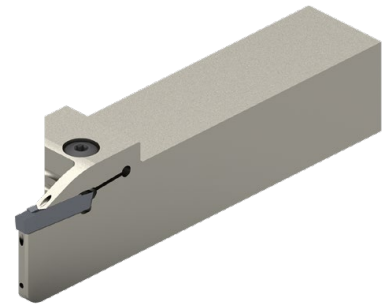

NEW Left-hand **NEW** Right-hand

Designation	H mm	B mm	CW mm	WF mm	OAH mm	OAL mm	LH mm	l _s mm	a mm	CDX mm	for grooving inserts	NEW	
												70 844 ...	70 844 ...
E16 R/L 0021S2-1616X-S-DC-GX24	16	16	2	15.2	22	94	39	40	4	21	GX 24-1 E2..	21601	21600
E16 R/L 0021S3-1616X-S-DC-GX24	16	16	3	14.8	22	94	39	40	4	21	GX 24-2 E3..	31601	31600
E20 R/L 0021S2-2020X-S-DC-GX24	20	20	2	19.2	26	109	40			21	GX 24-1 E2..	22001	22000
E20 R/L 0021S3-2020X-S-DC-GX24	20	20	3	18.8	26	109	40			21	GX 24-2 E3..	32001	32000

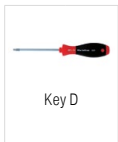

80 950 ...

**Spare parts
for grooving inserts**

GX 24-1 E2..	T15 - IP	128
GX 24-2 E3..	T15 - IP	128

Suitable indexable inserts and cutting data can be found in the catalogue Cutting tools → **Chapter 11 – Grooving tools**

MonoClamp – Radial Monoholder GX 24

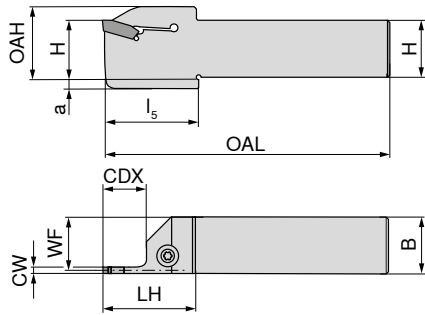

Illustrations show right-hand versions

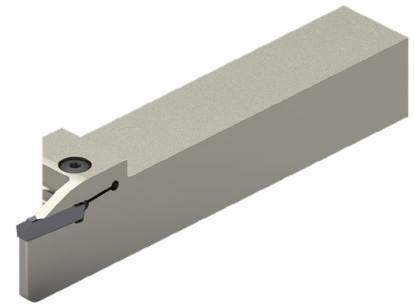

NEW Left-hand **70 845 ...**
NEW Right-hand **70 845 ...**

Designation	H mm	B mm	CW mm	WF mm	OAH mm	OAL mm	LH mm	l _s mm	a mm	CDX mm	for grooving inserts	70 845 ...	70 845 ...
E16 R/L 0021S2-1616K-S-GX24	16	16	2	15.2	22	125	39	40	4	21	GX 24-1 E2..	21601	21600
E16 R/L 0021S3-1616K-S-GX24	16	16	3	14.8	22	125	39	40	4	21	GX 24-2 E3..	31601	31600
E20 R/L 0021S2-2020K-S-GX24	20	20	2	19.2	26	125	40			21	GX 24-1 E2..	22001	22000
E20 R/L 0021S3-2020K-S-GX24	20	20	3	18.8	26	125	40			21	GX 24-2 E3..	32001	32000

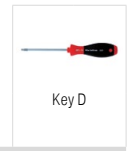

80 950 ...

Spare parts for grooving inserts

GX 24-1 E2..	T15 - IP	128
GX 24-2 E3..	T15 - IP	128

i Suitable indexable inserts and cutting data can be found in the catalogue Cutting tools → **Chapter 11 – Grooving tools**

Threading inserts TC full profile – External thread 60°

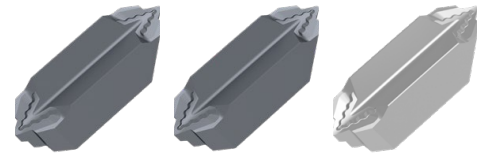
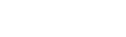
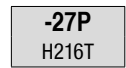
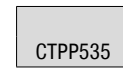
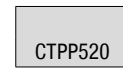
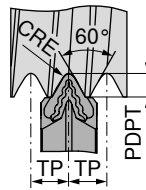
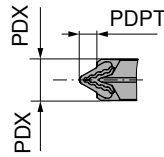
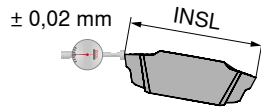

70 357 ...	70 357 ...	70 357 ...
010	110	610
012	112	612
014	114	614
016	116	616
018	118	618
030	130	630
032	132	632
034	134	634
036	136	636



Designation	Size	TP mm	INSL mm	PDPT mm	PDX mm	CRE mm	for tool holder
TC 16-1 E 0.5 ISO	TC 16-1 ...	0.50	16	0.32	1.05	0.06	E.. R/L TC 16-1
TC 16-1 E 0.75 ISO	TC 16-1 ...	0.75	16	0.48	1.05	0.09	E.. R/L TC 16-1
TC 16-1 E 1.0 ISO	TC 16-1 ...	1.00	16	0.64	1.05	0.12	E.. R/L TC 16-1
TC 16-1 E 1.25 ISO	TC 16-1 ...	1.25	16	0.80	1.05	0.15	E.. R/L TC 16-1
TC 16-1 E 1.5 ISO	TC 16-1 ...	1.50	16	0.95	1.05	0.18	E.. R/L TC 16-1
TC 16-2 E 1.75 ISO	TC 16-2 ...	1.75	16	1.10	2.15	0.22	E.. R/L/N TC 16-2
TC 16-2 E 2.0 ISO	TC 16-2 ...	2.00	16	1.26	2.15	0.25	E.. R/L/N TC 16-2
TC 16-2 E 2.5 ISO	TC 16-2 ...	2.50	16	1.58	2.15	0.32	E.. R/L/N TC 16-2
TC 16-2 E 3.0 ISO	TC 16-2 ...	3.00	16	1.89	2.15	0.38	E.. R/L/N TC 16-2

P	●	●	
M	●	●	
K	●	●	●
N			●
S	○	●	
H	○		
O			○

→ v_c Page 261
→ Application recommendation on page 269

Internal machining

External machining

							
		→ 251	→ 252				

Threading inserts TC full profile – Internal thread 60°

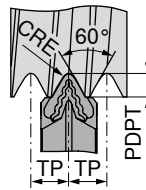
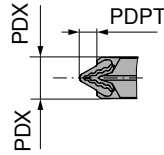
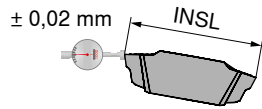

CTPP535

CTPP520

-27P
H216T

DRAGONSKIN

DRAGONSKIN

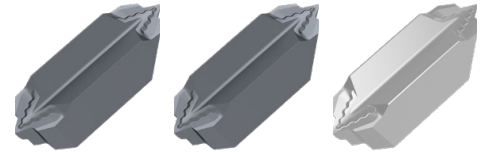

70 358 ...	70 358 ...	70 358 ...
114	014	
118	016	
	018	618
	030	
132	032	
136	036	636

Designation	Size	TP mm	INSL mm	PDPT mm	PDX mm	CRE mm	for tool holder
TC 16-1 1.0 ISO	TC 16-1 ...	1.00	16	0.59	1.05	0.06	I32 R/L TC 16-1
TC 16-1 1.25 ISO	TC 16-1 ...	1.25	16	0.74	1.05	0.07	I32 R/L TC 16-1
TC 16-1 1.5 ISO	TC 16-1 ...	1.50	16	0.89	1.05	0.09	I32 R/L TC 16-1
TC 16-2 1.75 ISO	TC 16-2 ...	1.75	16	1.02	2.15	0.11	I32 R/L TC 16-2
TC 16-2 2.0 ISO	TC 16-2 ...	2.00	16	1.17	2.15	0.13	I32 R/L TC 16-2
TC 16-2 3.0 ISO	TC 16-2 ...	3.00	16	1.76	2.15	0.19	I32 R/L TC 16-2

P	•	•	
M	•	•	
K	•	•	•
N			•
S	•	○	
H		○	
O			○

→ v_c Page 261

→ Application recommendation on page 269

Internal machining

External machining



→ 253

Threading inserts TC partial profile 60°

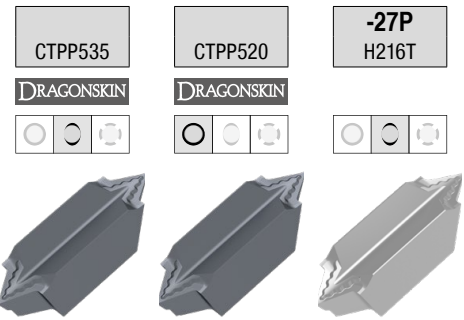
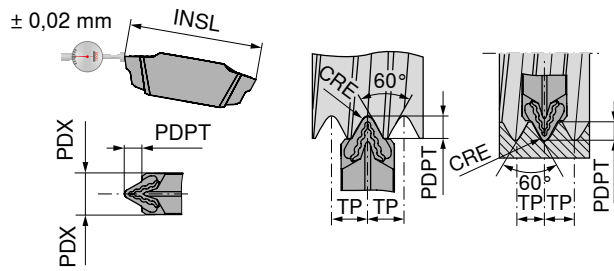
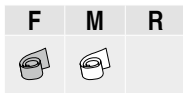

Designation	Size	TP mm	INSL mm	PDPT mm	PDX mm	CRE mm	for tool holder	70 355 ...	70 355 ...	70 355 ...
TC 16-1 EI A 60	TC 16-1 ...	0,5 - 1,5	16	1.27	1.05	0.03	E/l.. R/L TC 16-1	110	010	610
TC 16-2 EI AG 60	TC 16-2 ...	0,5 - 3,0	16	2.57	2.15	0.03	E/l.. R/L/N TC 16-2	132	032	632
TC 16-2 EI G 60	TC 16-2 ...	1,75 - 3,0	16	2.49	2.15	0.11	E/l.. R/L/N TC 16-2	130	030	630
P								●	●	
M								●	●	
K								●	●	●
N										●
S								●	○	
H									○	
O										○

→ v_c Page 261
→ Application recommendation on page 269

Internal machining

External machining

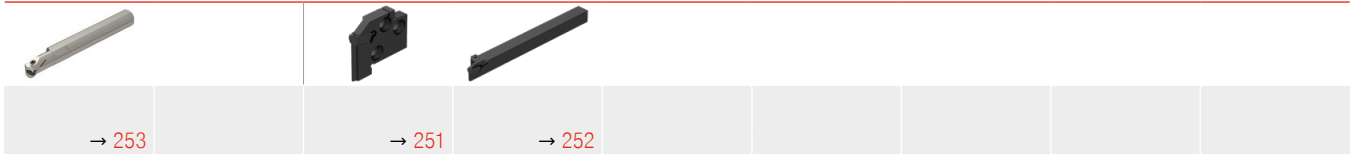

Threading inserts TC full profile 55°

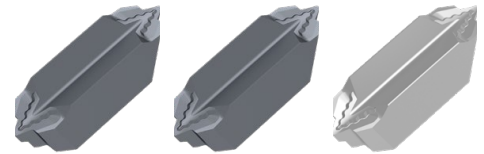
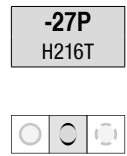
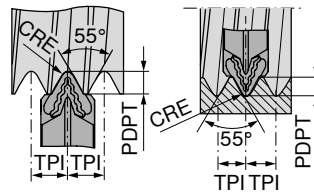
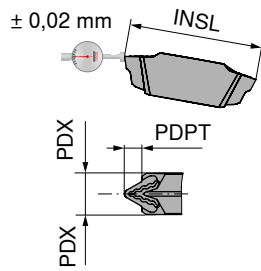

Designation	Size	TPI 1/"	INSL mm	PDPT mm	PDX mm	CRE mm	for tool holder	70 359 ...	70 359 ...	70 359 ...
TC 16-1 EI 28 W	TC 16-1 ...	28	16	0.60	1.05	0.12	E/l.. R/L TC 16-1	010	110	
TC 16-1 EI 20 W	TC 16-1 ...	20	16	0.84	1.05	0.17	E/l.. R/L TC 16-1	016		
TC 16-1 EI 19 W	TC 16-1 ...	19	16	0.88	1.05	0.17	E/l.. R/L TC 16-1	018	118	618
TC 16-1 EI 16 W	TC 16-1 ...	16	16	1.05	1.05	0.21	E/l.. R/L TC 16-1	022		
TC 16-2 EI 14 W	TC 16-2 ...	14	16	1.20	2.15	0.23	E/l.. R/L/N TC 16-2	030	130	630
TC 16-2 EI 12 W	TC 16-2 ...	12	16	1.40	2.15	0.27	E/l.. R/L/N TC 16-2		132	
TC 16-2 EI 11 W	TC 16-2 ...	11	16	1.53	2.15	0.30	E/l.. R/L/N TC 16-2	034	134	634
P								●	●	
M								●	●	
K								●	●	●
N										●
S								○	●	
H								○		
O										○

→ v_c Page 261
→ Application recommendation on page 269

Internal machining

External machining

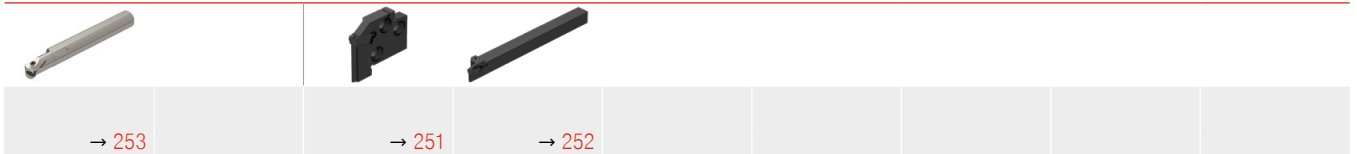

Threading inserts TC partial profile 55°

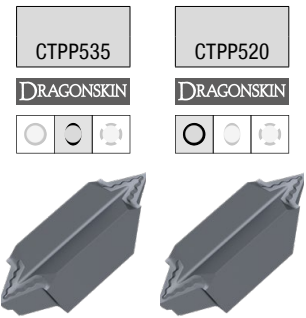
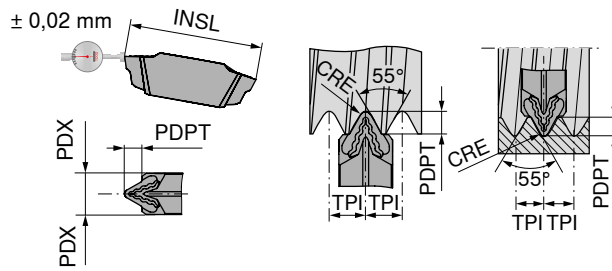

Designation	Size	TPI 1/"	INSL mm	PDPT mm	PDX mm	CRE mm	for tool holder
TC 16-1 EI A 55	TC 16-1 ...	28 - 16	16	1.39	1.05	0.12	E/l.. R/L TC 16-1
TC 16-2 EI AG 55	TC 16-2 ...	28 - 8	16	2.91	2.15	0.12	E/l.. R/L/N TC 16-2
TC 16-2 EI G 55	TC 16-2 ...	14 - 8	16	2.78	2.15	0.23	E/l.. R/L/N TC 16-2

70 356 ...	70 356 ...
110	010
132	032
130	030

P	●	●
M	●	●
K	●	●
N		
S	●	○
H		○
O		

→ v_c Page 261
→ Application recommendation on page 269

Internal machining

External machining

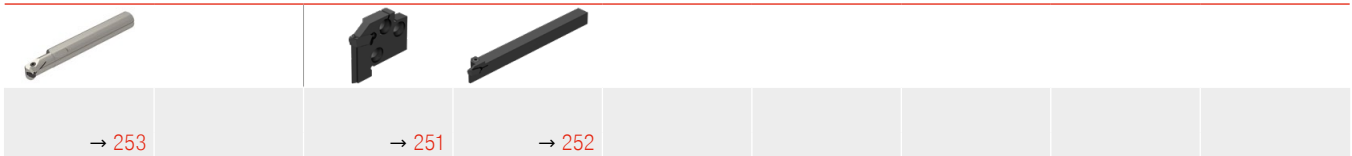

ModularClamp MSS – Threading module TC for external threads

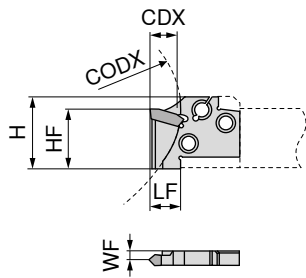

Illustrations show right-hand versions

Designation	TP mm	TPI 1/"	WF mm	HF mm	LF mm	H mm	CODX mm	CDX mm	for grooving inserts	Left-hand	Neutral	Right-hand
										70 872 ...	70 872 ...	70 872 ...
E20 R/L TC 16-1	0,5 - 1,5	28 - 16	3.45	13	20	24	60	8	TC 16-1 ...	120		020
E20 N TC 16-2	1,75 - 3,0	14 - 8	2.20	13	20	24		12	TC 16-2 ...		220	

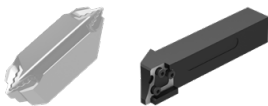

→ 246-250	→ 259+260											
-----------	-----------	--	--	--	--	--	--	--	--	--	--	--

MonoClamp – Monoholder TC – external thread

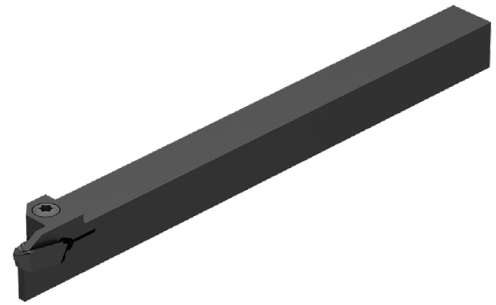
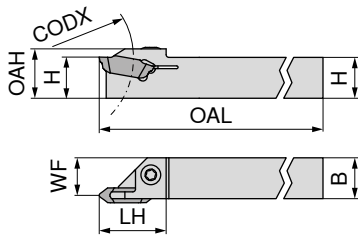

Illustrations show right-hand versions

Designation	TP mm	TPI 1/''	H mm	B mm	OAL mm	LH mm	OAH mm	WF mm	CODX mm	for grooving inserts	Left-hand	Right-hand
											70 883 ...	70 882 ...
E12 R/L 00-1212 TC16	0,5 - 3	28 - 8	12	12	150	20	14.5	11	30	TC16-1/2..	012	012

Spare parts
for grooving inserts
TC16-1/2..

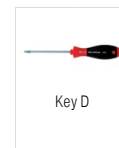

80 950 ...

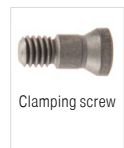

70 950 ...

T15

113

M4x11

442



→ 246-250

MonoClamp – Monobloc boring bar TC – internal thread

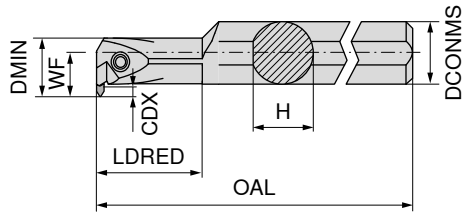

Illustrations show right-hand versions

Designation	WF mm	DCONMS mm	H mm	OAL mm	LDRED mm	CDX mm	DMIN mm	for grooving inserts	Left-hand	Right-hand
									70 857 ...	70 856 ...
I16 L 90-2D TC16	14.0	20	18	180	32	4	20	TC16-1/2..	016	
I20 R/L 90-2D TC16	17.5	25	23	200	40	5	25	TC16-..	020	020

**Spare parts
for Article no.**

Article no.	80 950 ...	70 950 ...
70 857 016	T15	113
70 857 020 / 70 856 020		M4x14 M5x18



Key D



Clamping screw



→ 246-250

MaxiClick - Insert - cutting depth 5 mm

▲ 5 cutting edges

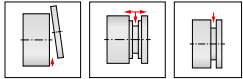

-F2
GTP1340

DRAGONSKIN

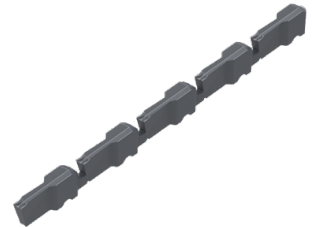
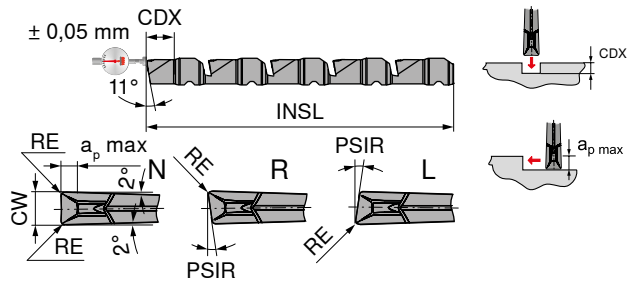

70 338 ...

Designation	IH	CW mm	RE mm	PSIR	INSL mm	a _{p max} mm	CDX mm	for tool holder	
MC 05-5-1.00 L 07-F2	L	1.0	0.1	7°	59.2		5	MC 05 R/L	250
MC 05-5-1.50 L 07-F2	L	1.5	0.1	7°	59.2		5	MC 05 R/L	260
MC 05-5-1.00 N 0.10-F2	N	1.0	0.1		59.2	0.5	5	MC 05 R/L	210
MC 05-5-1.50 N 0.10-F2	N	1.5	0.1		59.2	1.0	5	MC 05 R/L	220
MC 05-5-1.00 R 07-F2	R	1.0	0.1	7°	59.2		5	MC 05 R/L	230
MC 05-5-1.50 R 07-F2	R	1.5	0.1	7°	59.2		5	MC 05 R/L	240

P	●
M	●
K	●
N	○
S	●
H	
O	○

→ v_c Page 261
→ Application recommendation on page 265

Internal machining

External machining

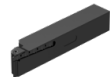

→ 257

MaxiClick - Insert - cutting depth 10 mm

▲ 4 cutting edges

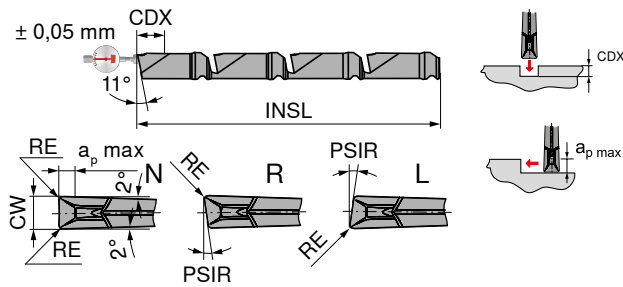
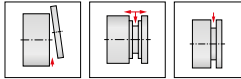

-F2
GTP1340

DRAGONSKIN



70 339 ...

Designation	IH	CW mm	RE mm	PSIR	INSL mm	a _{p max} mm	CDX mm	for tool holder	
MC 10-4-1.50 L 07-F2	L	1.5	0.1	7°	59.2		10	MC 10 R/L	270
MC 10-4-2.00 L 07-F2	L	2.0	0.1	7°	59.2		10	MC 10 R/L	280
MC 10-4-2.50 L 07-F2	L	2.5	0.1	7°	59.2		10	MC 10 R/L	290
MC 10-4-1.50 N 0.10-F2	N	1.5	0.1		59.2	1.0	10	MC 10 R/L	210
MC 10-4-2.00 N 0.10-F2	N	2.0	0.1		59.2	1.5	10	MC 10 R/L	220
MC 10-4-2.50 N 0.10-F2	N	2.5	0.1		59.2	2.0	10	MC 10 R/L	230
MC 10-4-1.50 R 07-F2	R	1.5	0.1	7°	59.2		10	MC 10 R/L	240
MC 10-4-2.00 R 07-F2	R	2.0	0.1	7°	59.2		10	MC 10 R/L	250
MC 10-4-2.50 R 07-F2	R	2.5	0.1	7°	59.2		10	MC 10 R/L	260

P	●
M	●
K	●
N	○
S	●
H	
O	○

→ v_c Page 261
→ Application recommendation on page 265

Internal machining

External machining



→ 258

MaxiClick - Insert - cutting depth 10 mm

▲ 4 cutting edges

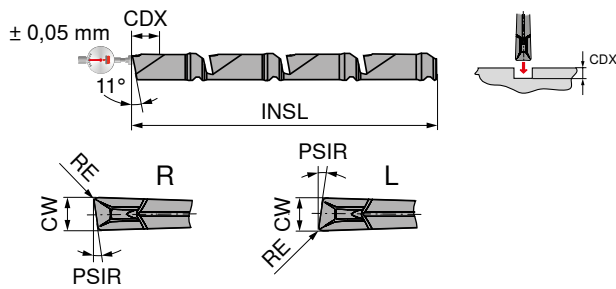
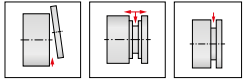

70 340 ...

Designation	IH	CW mm	RE mm	PSIR	INSL mm	CDX mm	for tool holder	
MC 10-4-1.50 L 12-F3	L	1.5	0.1	12°	59.2	10	MC 10 R/L	270
MC 10-4-2.00 L 12-F3	L	2.0	0.1	12°	59.2	10	MC 10 R/L	280
MC 10-4-2.50 L 12-F3	L	2.5	0.1	12°	59.2	10	MC 10 R/L	290
MC 10-4-1.50 R 12-F3	R	1.5	0.1	12°	59.2	10	MC 10 R/L	240
MC 10-4-2.00 R 12-F3	R	2.0	0.1	12°	59.2	10	MC 10 R/L	250
MC 10-4-2.50 R 12-F3	R	2.5	0.1	12°	59.2	10	MC 10 R/L	260

P	●
M	●
K	●
N	○
S	●
H	
O	○

→ v_c Page 261
→ Application recommendation on page 265

Internal machining

External machining



→ 258

MaxiClick - Toolholder - cutting depth 5 mm

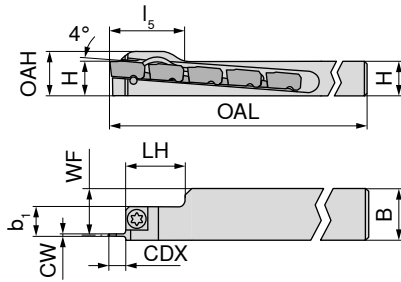

Illustrations show right-hand versions

Designation	H mm	OAH mm	B mm	CW mm	CDX mm	WF mm	OAL mm	LH mm	l ₅ mm	for grooving inserts	Left-hand	Right-hand
											70 873 ...	70 873 ...
MC 05 R/L -1010K	10	13	10	1,00 - 1,50	5	8.5	125	23	27	MC 05	210	110
MC 05 R/L -1212K	12	15	12	1,00 - 1,50	5	10.5	125	23	27	MC 05	212	112
MC 05 R/L -1616K	16	19	16	1,00 - 1,50	5	14.5	125	23	20	MC 05	216	116
MC 05 R/L -2020K	20	23	20	1,00 - 1,50	5	18.8	125	23	20	MC 05	220	120

Spare parts
for grooving inserts
MC 05

	Key-T	Clamping screw
	70 950 ...	70 950 ...
MC 05	T15 738	M4x11 174



→ 254

MaxiClick - Toolholder - cutting depth 10 mm

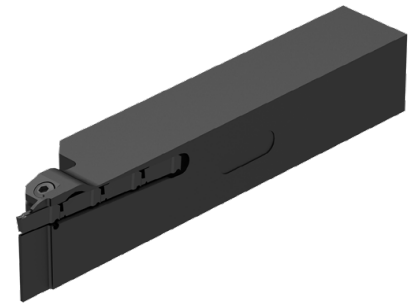
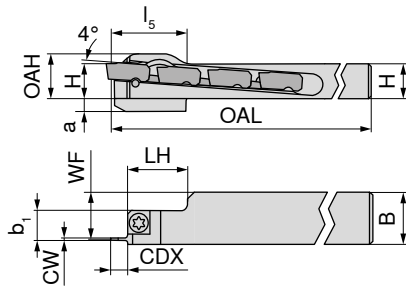

Illustrations show right-hand versions

Designation	H mm	OAH mm	B mm	a mm	CW mm	CDX mm	WF mm	OAL mm	LH mm	l ₅ mm	for grooving inserts	Left-hand	Right-hand
												70 874 ...	70 874 ...
MC 10 R/L -1010K	10	13	10		1,50 - 2,50	10	8.5	125	28		MC 10	210	110
MC 10 R/L -1010K-S	10	13	10	6	1,50 - 2,50	10	8.5	125	28	27	MC 10	410 ¹⁾	310 ¹⁾
MC 10 R/L -1212K	12	15	12		1,50 - 2,50	10	10.5	125	28		MC 10	212	112
MC 10 R/L -1212K-S	12	15	12	4	1,50 - 2,50	10	10.5	125	28	27	MC 10	412 ¹⁾	312 ¹⁾
MC 10 R -1616K	16	19	16		1,50 - 2,50	10	14.5	125	28	20	MC 10		116
MC 10 R/L -2020K	20	23	20		1,50 - 2,50	10	18.8	125	28	20	MC 10	220	120

1) -S = strengthened variant

Spare parts for grooving inserts

MC 10

	Key-T	Clamping screw
	70 950 ...	70 950 ...
	738	174
	M4x11	



→ 255+256									
-----------	--	--	--	--	--	--	--	--	--

ModularClamp MSS - Tool holder 0°

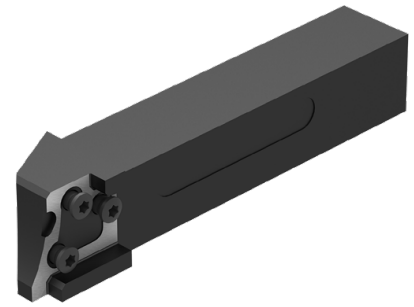
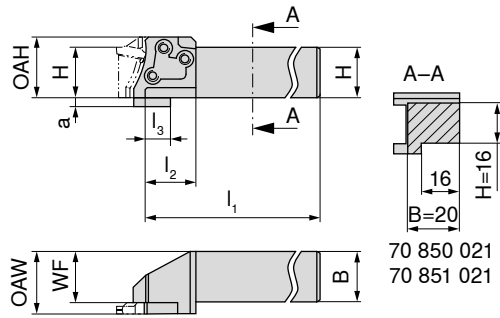

Illustrations show right-hand versions

Designation	H mm	B mm	OAW mm	OAH mm	WF mm	l ₁ mm	l ₂ mm	for modules	Left-hand	Right-hand
									70 851 ...	70 850 ...
E12 R/L 00-1212E	12	12	15.25	14.5	11.75	70	12	E12 R/L ...	012	012
E16 R/L 00-1616G	16	16	19.25	19.5	15.75	90	16	E16 R/L ...	016	016
E20 R/L 00-1620G	16	20	24.25	24.0	20.15	90	20	E20 R/L ...	021 ¹⁾	021 ¹⁾
E20 R/L 00-2020J	20	20	24.25	24.0	20.15	110	20	E20 R/L ...	020	020

1) see view A-A

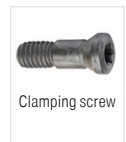
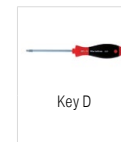

Spare parts for Article no.

Article no.	Key D	Clamping screw
70 851 012 / 70 850 012	T08	M2,5x10
70 851 016 / 70 850 016	T15	M3,5x12,5
70 851 021 / 70 850 021	T15	M4x14
70 851 020 / 70 850 020	T15	M4x14

Module Overview



→ 206+207									
-----------	--	--	--	--	--	--	--	--	--

ModularClamp MSS - Tool holder 90°

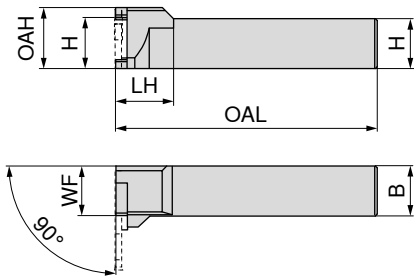

Illustrations show right-hand versions

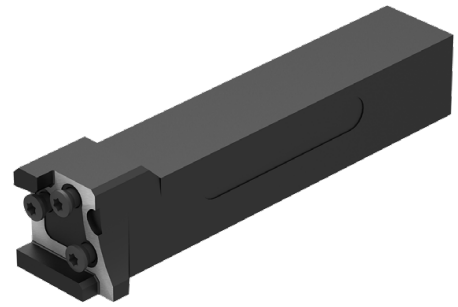

Designation	H mm	B mm	OAH mm	WF mm	OAL mm	LH mm	for modules	Left-hand		Right-hand	
								70 855 ...	020	70 854 ...	020
E20 R/L 90-2020J	20	20	24	20	110	20	E20 R/L ...				



For right hand holder → left hand module only
For left hand holder → right hand module only

Spare parts for Article no.

70 855 020 / 70 854 020

	Key D	Clamping screw
	80 950 ...	70 950 ...
T15	113	M4x14
		403

Module Overview



→ 206+207									
-----------	--	--	--	--	--	--	--	--	--

Cutting data values for grooving inserts GX/LX/FX/SX/AX/TC/MaxiClick

	DRAGONSKIN CTCP325	DRAGONSKIN CTCP335	DRAGONSKIN CTPP345	DRAGONSKIN CTPP520	DRAGONSKIN CTPP535	DRAGONSKIN CTP1340	H216T (SX/FX/GX)	H216T (TC)	
Index	v _c in m/min.								
P.1.1	220	184	135	236	180	177			
P.1.2	194	160	119	204	152	149			
P.1.3	171	138	105	174	126	123			
P.1.4	163	131	100	165	118	115			
P.1.5	151	120	93	150	105	102			
P.2.1	198	164	122	209	157	153			
P.2.2	161	129	99	162	116	112			
P.2.3	151	120	93	150	105	102			
P.2.4	121	92	74	113	73	70			
P.3.1	149	127	101	185	119	112			
P.3.2	96	89	80	131	88	76			
P.3.3	44	51	59	76	58	39			
P.4.1	149	127	101	185	119	112			
P.4.2	123	108	90	158	103	94			
M.1.1	149	127	101	185	119	112			
M.2.1	96	89	80	131	88	76			
M.3.1	133	116	94	169	109	102			
K.1.1	170	135		140	165	150	140	140	
K.1.2	150	115		115	150	125	115	115	
K.2.1	160	130		180	145	140	150	150	
K.2.2	145	105		115	155	120	110	110	
K.3.1	210	150		130	190	170	170	170	
K.3.2	140	115		110	145	120	140	140	
N.1.1						300	400	450	
N.1.2						200	100	450	
N.2.1						300	450	300	
N.2.2						200	450	300	
N.2.3						150	500	225	
N.3.1						300	425	190	
N.3.2						300	400	290	
N.3.3						200	275	290	
N.4.1						200	225	290	
S.1.1	35			40	30	35	38		
S.1.2	30		30	30	25	30	28		
S.2.1	20		25	20	15	20	28		
S.2.2	15			15	15	15	24		
S.2.3	15			18	15	15	20		
S.3.1				125	85	85	90		
S.3.2				50	35	40	55		
S.3.3				35	25	30	40		
H.1.1				30					
H.1.2				25					
H.1.3									
H.1.4									
H.2.1				25					
H.3.1				40					
O.1.1						130	130	290	
O.1.2									
O.2.1						105	105	290	
O.2.2									
O.3.1									

 The cutting data is strongly influenced by external conditions, such as the stability of the tool and workpiece clamping, material and type of machine. The specified values represent guideline cutting data that can be adjusted by approx. ±20% according to the usage conditions.

GX – Depths of cut and feed rates

GX Standard / GX-E

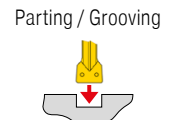
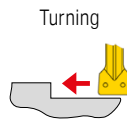

GX Standard / GX-E	Depth of Cut a_p , in mm						
	0,5	1,0	1,5	2,0	2,5	3,0	3,5
Cutting width in mm	Feed rate f in mm/rev.						
2	0,10-0,15	0,05-0,15	0,05-0,12	0,05-0,10			
3	0,10-0,17	0,05-0,17	0,05-0,17	0,05-0,15	0,05-0,12		
4	0,10-0,20	0,07-0,20	0,07-0,20	0,07-0,20	0,07-0,17	0,07-0,15	
5	0,10-0,25	0,10-0,25	0,07-0,25	0,07-0,25	0,07-0,22	0,07-0,20	
6	0,15-0,30	0,15-0,30	0,15-0,30	0,15-0,30	0,15-0,30	0,15-0,25	0,15-0,22

GX Standard / GX-E
Feed rate f in mm/rev.
0,05-0,20
0,10-0,25
0,10-0,25
0,10-0,30
0,15-0,35

When axial grooving reduce feed by 40%.

GX-F2

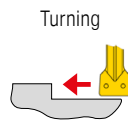

GX-F2	Depth of Cut a_p , in mm								
	0,50	0,75	1,00	1,25	1,50	1,75	2,00	2,25	2,50
Cutting width in mm	Feed rate f in mm/rev.								
2	0,03-0,15	0,03-0,15	0,03-0,15	0,03-0,10					
3	0,04-0,17	0,04-0,17	0,04-0,17	0,04-0,15	0,04-0,13	0,04-0,12			
4	0,05-0,20	0,05-0,20	0,05-0,20	0,05-0,20	0,05-0,20	0,05-0,17	0,05-0,15		
5	0,07-0,20	0,07-0,20	0,07-0,20	0,07-0,20	0,07-0,20	0,07-0,20	0,07-0,17	0,07-0,15	
6	0,10-0,23	0,10-0,23	0,10-0,23	0,10-0,23	0,10-0,23	0,10-0,23	0,10-0,23	0,10-0,19	0,10-0,15

GX-F2
Feed rate f in mm/rev.
0,05-0,15
0,075-0,20
0,10-0,25
0,10-0,30
0,15-0,325

When axial grooving reduce feed by 40%.

GX-M40

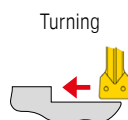

GX-M40	Depth of Cut a_p , in mm							
	0,5	1,0	1,5	2,0	2,5	3,0	3,5	4,0
Cutting width in mm	Feed rate f in mm/rev.							
2	0,10-0,20	0,05-0,20	0,05-0,17	0,05-0,15				
3	0,10-0,22	0,10-0,22	0,10-0,21	0,10-0,20	0,10-0,17			
4	0,10-0,25	0,10-0,25	0,10-0,25	0,10-0,25	0,10-0,22	0,10-0,17		
5	0,10-0,30	0,10-0,30	0,10-0,30	0,10-0,30	0,10-0,27	0,10-0,23	0,10-0,20	
6	0,10-0,35	0,10-0,35	0,10-0,35	0,10-0,35	0,10-0,32	0,10-0,27	0,10-0,23	0,10-0,20

GX-M40
Feed rate f in mm/rev.
0,05-0,15
0,075-0,20
0,10-0,25
0,10-0,30
0,15-0,325

When axial grooving reduce feed by 40%.

GX-27P

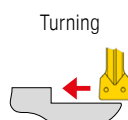

GX-27P	Depth of Cut a_p , in mm							
	0,5	1,0	1,5	2,0	2,5	3,0	3,5	4,0
Cutting width in mm	Feed rate f in mm/rev.							
2	0,05-0,23	0,05-0,23	0,05-0,23	0,05-0,20				
3	0,05-0,25	0,05-0,25	0,05-0,25	0,05-0,25	0,05-0,20			
4	0,10-0,30	0,10-0,30	0,10-0,30	0,10-0,30	0,10-0,30	0,10-0,25		
5	0,10-0,35	0,10-0,35	0,10-0,35	0,10-0,35	0,10-0,35	0,10-0,32	0,10-0,30	
6	0,10-0,40	0,10-0,40	0,10-0,40	0,10-0,40	0,10-0,40	0,10-0,36	0,10-0,33	0,10-0,30

GX-27P
Feed rate f in mm/rev.
0,05-0,20
0,05-0,25
0,05-0,30
0,10-0,35
0,10-0,40

When axial grooving reduce feed by 40%.

GX – Depths of cut and feed rates

GX-M3

Turning

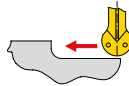

Parting / Grooving

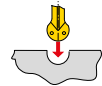

GX-M3	Depth of Cut a_p in mm							
	0,5	1,0	1,5	2,0	2,5	3,0	3,5	4,0
Radius RE in mm	Feed rate f in mm/rev.							
1,5	0,15-0,35	0,15-0,35	0,15-0,30					
2	0,15-0,40	0,15-0,40	0,15-0,40	0,15-0,30				
2,5	0,15-0,50	0,15-0,50	0,15-0,50	0,15-0,40	0,15-0,35			
3	0,20-0,70	0,20-0,70	0,20-0,70	0,20-0,60	0,20-0,50	0,20-0,40		

GX-M3	Feed rate f in mm/rev.
	0,05-0,20
	0,10-0,25
	0,10-0,25
	0,10-0,35

GX-27P Full Radius

Turning



Parting / Grooving

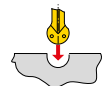

GX-27P Full Radius	Depth of Cut a_p in mm							
	0,5	1,0	1,5	2,0	2,5	3,0	3,5	4,0
Radius RE in mm	Feed rate f in mm/rev.							
1,5	0,10-0,45	0,05-0,45	0,05-0,40					
2	0,15-0,50	0,10-0,50	0,10-0,50	0,10-0,40				
2,5	0,15-0,60	0,10-0,60	0,10-0,60	0,10-0,50	0,10-0,45			
3	0,25-0,70	0,20-0,70	0,15-0,70	0,15-0,70	0,15-0,65	0,15-0,60	0,15-0,55	
4	0,25-0,80	0,20-0,80	0,15-0,80	0,15-0,80	0,15-0,80	0,15-0,80	0,15-0,75	0,15-0,70

GX-27P Full Radius	Feed rate f in mm/rev.
	0,05-0,15
	0,075-0,20
	0,10-0,25
	0,10-0,30
	0,15-0,35

GX-M1

Parting / Grooving



GX-M1	Feed rate f in mm/rev.
Cutting width in mm	
2	0,05-0,15
3	0,10-0,20
4	0,10-0,25

GX Radius grooving inserts

Parting / Grooving



GX Radius grooving insert	Feed rate f in mm/rev.
Radius RE in mm	
0,80	0,05-0,10
1,00	0,05-0,15
1,20	0,05-0,15

GX circlip grooving

Grooving



GX circlip grooves	Feed rate f in mm/rev.
Cutting width in mm	
0,60-1,70	0,02-0,09
1,95-2,25	0,05-0,10
2,75-3,25	0,05-0,12

Feed guide and machining instructions for axial grooving and face turning with GX 24 axial

Approximate feed rates

GX

Designation	f in mm/rev.		a _{v,max} mm
	Diagram 1	Diagram 2	
GX 24-2 E 3.00 ..	0,05-0,15	0,05-0,20	2,5
GX 24-3 E 4.00 ..	0,05-0,15	0,05-0,25	3,0
GX 24-3 E 5.00 ..	0,05-0,15	0,10-0,25	3,0
GX 24-4 E 6.00 ..	0,05-0,20	0,10-0,30	3,5

Axial grooving

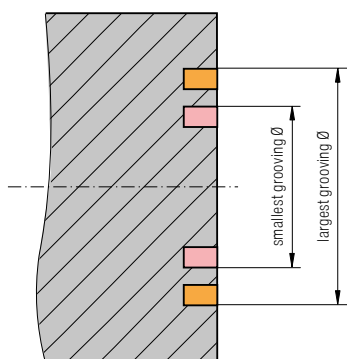

It is only possible to plunge within the fixed diameter range of the axial grooving module or monoholder (e.g. 50 – 70 mm).

Important: The indicated diameter range is always valid for the external diameter of the groove!

Axial grooving – Groove widening

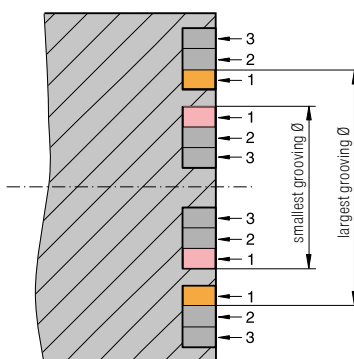

In case of face turning it is possible to widen the groove above and below the diameter range indicated on the Axial grooving module or monoholder.

Important: Only the first groove must lie within the diameter range of the axial grooving module or axial monoholder. The depth of the widening groove must not be larger than the depth of the original groove.

Axial grooving and face turning

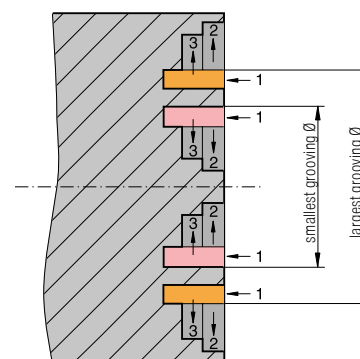

Groove widening by face turning in the diameter range above and below the values specified for the Axial grooving module and Axial monoholder are possible.

Important: Only the first groove must lie within the diameter range of the module.



Attention: The diameter of face grooves must lie within the diameter range indicated on the axial grooving module and axial monoholder. Not following this range will result in the tool being damaged or destroyed.

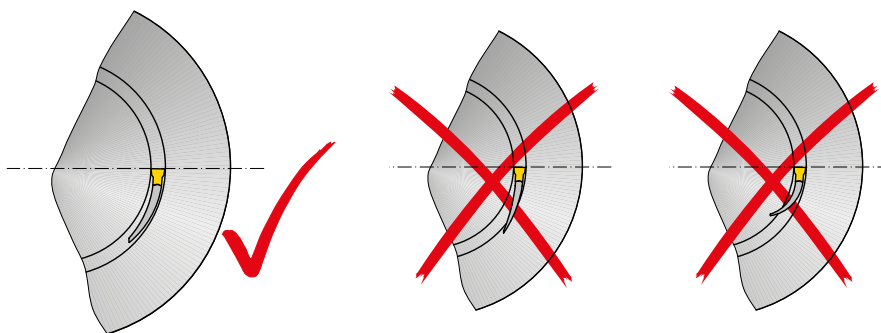

Correct Axial mono holder

Incorrect Axial mono holder

MaxiClick – Depths of cut and feed rates

MaxiClick 05

Turning

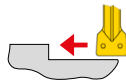

Depth of Cut a_p in mm

MaxiClick 05	0,25	0,50	0,75
Cutting width in mm	Feed rate f in mm/rev.		
1	0,02–0,15	0,02–0,10	
1,5	0,02–0,20	0,02–0,20	0,02–0,14

Parting / Grooving



MaxiClick 05

Feed rate f in mm/rev.
0,03–0,10
0,03–0,11

MaxiClick 10

Turning



Depth of Cut a_p in mm

MaxiClick 10	0,50	0,75	1,00	1,25	1,50
Cutting width in mm	Feed rate f in mm/rev.				
1,5	0,02–0,20	0,02–0,15	0,02–0,10		
2	0,02–0,20	0,02–0,20	0,02–0,14	0,02–0,10	
2,5	0,02–0,20	0,02–0,20	0,02–0,17	0,02–0,13	0,02–0,10

Parting / Grooving



MaxiClick 10

Feed rate f in mm/rev.
0,03–0,11
0,03–0,12
0,03–0,15

MaxiClick – System function

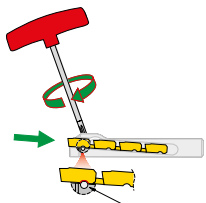

correct insert location in the seat

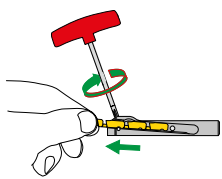

Withdraw cutting insert

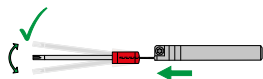

Worn-out cutting edge is broken off towards the left or right side

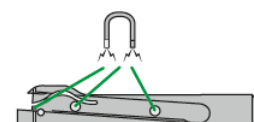
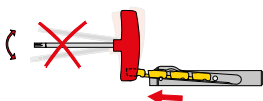

Magnets prevent the cutting insert from falling out of the tool holder during positioning

SX – Depths of cut and feed rates

SX-F2

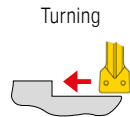

SX-F2	Depth of Cut a_p in mm									SX-F2
	0,50	0,75	1,00	1,25	1,50	1,75	2,00	2,25	2,50	
Cutting width in mm	Feed rate f in mm/rev.									Feed rate f in mm/rev.
2	0,03-0,15	0,03-0,15	0,03-0,15	0,03-0,10						0,05-0,15
3	0,04-0,17	0,04-0,17	0,04-0,17	0,04-0,15	0,04-0,13	0,04-0,12				0,075-0,20
4	0,05-0,20	0,05-0,20	0,05-0,20	0,05-0,20	0,05-0,20	0,05-0,17	0,05-0,15			0,10-0,25

SX-M2

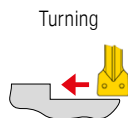

SX-M2	Depth of Cut a_p in mm								SX-M2
	0,5	1,0	1,5	2,0	2,5	3,0	3,5	4,0	
Cutting width in mm	Feed rate f in mm/rev.								Feed rate f in mm/rev.
2	0,05-0,17	0,05-0,13	0,05-0,10						0,05-0,15
3	0,07-0,20	0,07-0,20	0,07-0,18	0,07-0,15					0,075-0,20
4	0,10-0,25	0,10-0,25	0,10-0,25	0,10-0,22	0,10-0,18				0,10-0,25
5	0,12-0,27	0,12-0,27	0,12-0,27	0,12-0,25	0,12-0,22				0,10-0,30
6	0,15-0,30	0,15-0,30	0,15-0,30	0,15-0,30	0,15-0,25	0,15-0,20			0,15-0,35

SX-27P

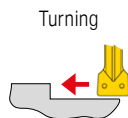

SX-27P	Depth of Cut a_p in mm								SX-27P
	0,5	1,0	1,5	2,0	2,5	3,0	3,5	4,0	
Cutting width in mm	Feed rate f in mm/rev.								Feed rate f in mm/rev.
2	0,05-0,23	0,05-0,23	0,05-0,23	0,05-0,20					0,05-0,20
3	0,05-0,25	0,05-0,25	0,05-0,25	0,05-0,25	0,05-0,20				0,05-0,25
4	0,10-0,30	0,10-0,30	0,10-0,30	0,10-0,30	0,10-0,30	0,10-0,25			0,05-0,30

SX/LX – Depths of cut and feed rates

SX-M1

Parting / Grooving



SX-M1	
Cutting width in mm	Feed rate f in mm/rev.
2	0,05–0,15
3	0,10–0,20
4	0,10–0,25
5	0,15–0,30
6	0,15–0,35

SX-M3

Turning

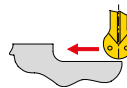

SX-M3	Depth of Cut a_p in mm							
	0,5	1,0	1,5	2,0	2,5	3,0	3,5	4,0
Radius in mm	Feed rate f in mm/rev.							
1,5	0,15–0,35	0,15–0,35	0,15–0,30					
2	0,15–0,40	0,15–0,40	0,15–0,40	0,15–0,30				
2,5	0,15–0,50	0,15–0,50	0,15–0,50	0,15–0,40	0,15–0,35			
3	0,20–0,70	0,20–0,70	0,20–0,70	0,20–0,60	0,20–0,50	0,20–0,40		

Parting / Grooving

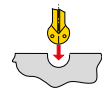

SX-M3	
Feed rate f in mm/rev.	
	0,05–0,20
	0,10–0,25
	0,10–0,25
	0,10–0,35

LX-M2

Turning

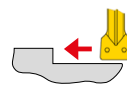

LX-M2	Depth of Cut a_p in mm							
	0,5	1,0	1,5	2,0	2,5	3,0	3,5	4,0
Cutting width in mm	Feed rate f in mm/rev.							
8	0,17–0,45	0,17–0,45	0,17–0,45	0,17–0,45	0,17–0,40	0,17–0,37	0,17–0,35	
10	0,20–0,50	0,20–0,50	0,20–0,50	0,20–0,50	0,20–0,46	0,20–0,42	0,20–0,38	0,20–0,35

Parting / Grooving

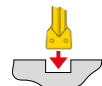

LX-M2	
Feed rate f in mm/rev.	
	0,20–0,50
	0,20–0,50

LX-M3

Turning

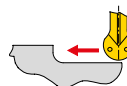

LX-M3	Depth of Cut a_p in mm							
	0,5	1,0	1,5	2,0	2,5	3,0	3,5	4,0
Radius in mm	Feed rate f in mm/rev.							
4	0,25–0,80	0,25–0,80	0,25–0,80	0,25–0,80	0,25–0,80	0,25–0,70	0,25–0,60	0,25–0,50

Parting / Grooving

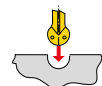

LX-M3	
Feed rate f in mm/rev.	
	0,15–0,35

AX/FX – Depths of cut and feed rates

AX-F50

Face turning

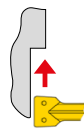

AX-F50	Depth of Cut a_p in mm			
	0,5	1,0	1,5	2,3
Size	Feed rate f in mm/rev.			
AX 05	0,03–0,10	0,03–0,10		
AX 10	0,03–0,13	0,03–0,13	0,03–0,135	
AX 15	0,03–0,15	0,03–0,15	0,03–0,15	0,03–0,15

Axial grooving



1. Plunging	
Feed rate f in mm/rev.	Feed rate f in mm/rev.
0,025–0,080	0,025–0,20
0,025–0,065	0,05–0,25
0,025–0,050	0,05–0,30

FX-F1

Parting / Grooving



FX-F1	Feed rate f in mm/rev.
Cutting width in mm	
2,2	0,025–0,10
3,1	0,05–0,15
4,1	0,05–0,20

FX-M1

Parting / Grooving



FX-M1	Feed rate f in mm/rev.
Cutting width in mm	
2,20	0,05–0,15
3,10	0,08–0,18
4,10	0,10–0,20
5,10	0,15–0,28
6,50	0,15–0,33
8,20	0,20–0,40
9,70	0,20–0,40

FX-27P

Parting / Grooving



FX-27P	Feed rate f in mm/rev.
Cutting width in mm	
2,20	0,01–0,10
3,10	0,015–0,125
4,10	0,05–0,15

FX-R2

Grooving



FX-R2	Feed rate f in mm/rev.
Cutting width in mm	
3,10	0,10–0,275
4,10	0,15–0,35

TC – Reference values for profile depth and number of passes



All listed values are guide values for steel machining

Metric ISO 60° external thread

Pitch in mm	0,5	0,75	1,0	1,25	1,5	1,75	2,0	2,5	3,0	3,5	4,0	4,5	5,0
Number/cuts	4-6	4-7	4-8	5-9	6-10	7-11	8-12	9-14	10-18	10-18	12-20	12-20	12-20
Thread profile depth in mm	0,32	0,48	0,64	0,8	0,95	1,10	1,26	1,58	1,89	2,21	2,53	2,84	3,16

Metric ISO 60° internal thread

Pitch in mm	0,5	0,75	1,0	1,25	1,5	1,75	2,0	2,5	3,0	3,5	4,0	4,5	5,0
Number/cuts	4-6	4-7	4-8	5-9	6-10	7-11	8-12	9-14	10-18	10-18	12-20	12-20	12-20
Thread profile depth in mm	0,30	0,45	0,59	0,74	0,89	1,02	1,17	1,46	1,76	2,02	2,35	2,64	2,93

Whitworth 55° external and internal thread

TPI	28	26	24	20	19	18	16	14	12	11	10	9	8	7	6	5
Number/cuts	5-8	5-8	5-9	5-9	6-10	6-10	7-11	8-12	9-14	9-14	10-17	10-18	10-18	12-20	12-20	12-20
Thread profile depth in mm	0,60	0,65	0,70	0,84	0,88	0,93	1,05	1,20	1,40	1,53	1,68	1,87	2,11	2,41	2,81	3,37

Partial profile 60° external and internal thread

External	TC 16-2EI-AG60																
	TC 16-1EI-A60								TC 16-2EI-G60				TC 16-3EI-N60				
Pitch in mm	0,5	0,75	1,0	1,25	1,5	1,75	2,0	2,5	3,0	1,75	2,0	2,5	3,0	3,5	4,0	4,5	5,0
Number/cuts	4-6	4-7	5-9	6-10	7-11	8-12	9-14	10-15	12-19	8-12	9-14	10-15	12-20	12-20	13-21	14-22	14-22
Thread profile depth in mm	0,33	0,52	0,71	0,90	1,09	1,28	1,47	1,84	2,22	1,23	1,42	1,79	2,17	2,45	2,83	3,21	3,59

Internal	TC 16-2EI-AG60																
	TC 16-1EI-A60								TC 16-2EI-G60				TC 16-3EI-N60				
Pitch in mm	0,5	0,75	1,0	1,25	1,5	1,75	2,0	2,5	3,0	1,75	2,0	2,5	3,0	3,5	4,0	4,5	5,0
Number/cuts	4-6	4-7	5-9	6-10	7-11	8-12	9-14	10-15	12-19	8-12	9-14	10-15	12-20	12-20	13-21	14-22	14-22
Thread profile depth in mm	0,27	0,44	0,60	0,76	0,92	1,09	1,25	1,57	1,90	1,04	1,20	1,52	1,85	2,07	2,40	2,72	3,05

Partial profile 55° external and internal thread

External	TC 16-2EI-AG55													
	TC 16-1EI-A55													
TPI	28	26	24	20	19	18	16	14	12	11	10	9	8	
Number/cuts	5-8	5-8	6-9	6-9	7-12	7-12	8-14	9-14	10-16	10-16	11-18	12-20	12-20	
Thread profile depth in mm	0,66	0,72	0,79	0,95	1,01	1,07	1,21	1,39	1,63	1,79	1,97	2,20	2,48	

Internal	TC 16-2EI-G55							TC 16-3EI-N55		
	TPI	14	12	11	10	9	8	7	6	5
Number/cuts	8-12	9-14	10-15	11-18	12-20	12-20	12-20	12-20	14-22	
Thread profile depth in mm	1,22	1,46	1,56	1,80	2,03	2,31	2,40	2,89	3,56	

Comparison threading system with TC and conventional

TC

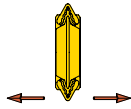

- ▲ Neutral configuration of insert makes operation in both directions possible
- ▲ Only one threading insert per pitch for partial profile and Whitworth thread; only two threading inserts (internal – external) per pitch for ISO threads
- ▲ Reduced stock holding
- ▲ good chip formation due to chip breaker with rake angle + 10 °

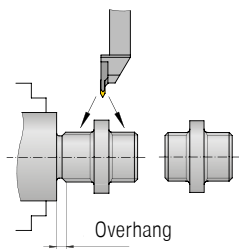

Greater efficiency through:

- ▲ shorter operating time
- ▲ Less tool changing
- ▲ High stability with small overhang
- ▲ Material saving
- ▲ Thread turning between shoulders
- ▲ Fewer tools and indexable inserts

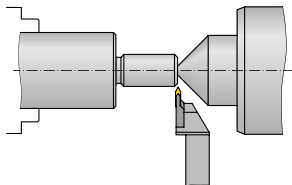

- ▲ Very good access to workpiece, therefore use of tailstock also possible with small thread diameters

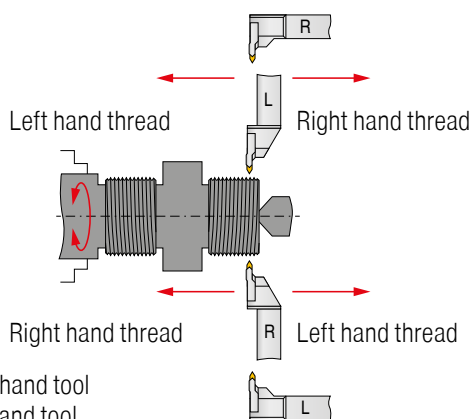

R = Right hand tool
L = Left hand tool

- ▲ ease of use, as the tools have no pitch angle correction they can be used in both directions

Conventional

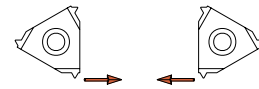

- ▲ Right-hand and left-hand version of indexable insert, therefore operation only in one direction
- ▲ For every pitch 4 threading inserts are necessary (right – left, internal – external)

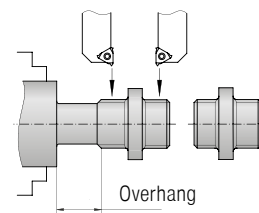

- ▲ For this machining method 2 tools are required
- ▲ additional material and stability loss with large overhang

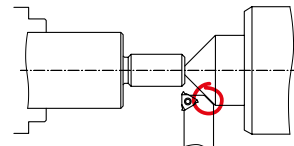

- ▲ poor accessibility
- ▲ Collision danger

Right hand thread

Left hand thread

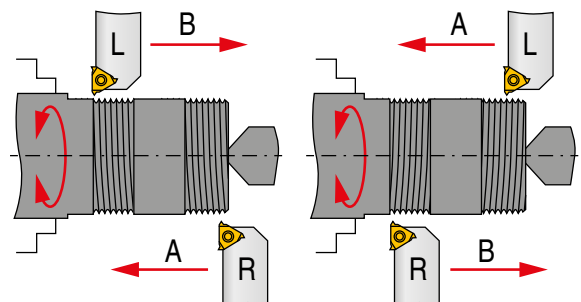

- ▲ With conventional thread turning the correction of the helix angle is necessary, therefore a high degree of application know-how is required
- ▲ Can only be operated in one direction

ModularClamp



The ModularClamp grooving modules are matched according to size on a particular workpiece diameter CODX. If the diameter of the workpiece is greater than CODX of the grooving Modules, this reduces the achievable penetration depth by the dimension „a“. The extent of reduction can be determined with the following table.

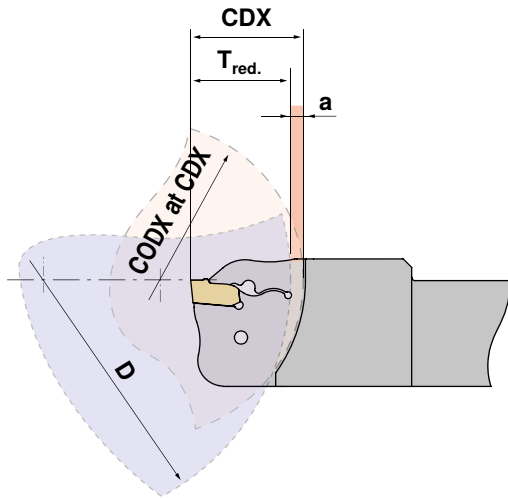

- CDX** maximum plunge depth in mm
- CODX** maximum workpiece Ø with full penetration depth in mm
- a** Reduction amount in mm

$$T_{red.} = CDX - a$$

Grooving depth reduction

Size	Reduction a (mm) of the maximum grooving depth (CDX)																
	0,5	1,0	1,5	2,0	2,5	3,0	3,5	4,0	4,5	5,0	5,5	6,0	6,5	7,0	7,5	8,0	
E12	35	40	45	60	75	115	>250										
E16	50	55	60	70	80	100	130	200	>420								
E20	60	65	70	75	85	95	110	130	165	220	>330						
E25	75	80	85	90	100	110	125	140	160	190	240	320	>500				
E32	95	100	105	110	120	125	135	145	160	180	200	225	270	320	400	530	>800

Workpiece diameter D (mm)

Maximum workpiece diameter (CODX) with full penetration depth (CDX) in mm

Calculation example:

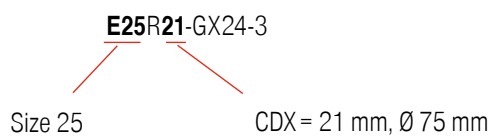

$$D = \text{Ø } 100 \text{ mm} \qquad CDX - a = T_{red.}$$

$$\qquad \qquad \qquad 21 - 2 = 19 \text{ mm}$$

MonoClamp

SX

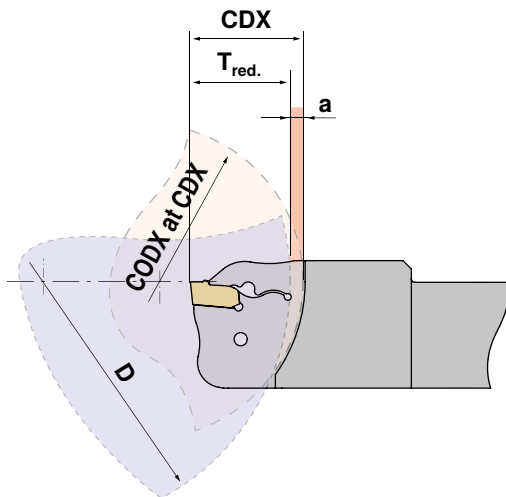

Depending on the groove width and shank size, the MonoClamp tools are designed for use with a specific workpiece diameter CODX. If the workpiece diameter is larger than the CODX of the grooving module, the achievable groove depth is reduced by the dimension „a“. The extent of the reduction is determined using the following table.

- CDX** maximum plunge depth in mm
- CODX** maximum workpiece Ø with full penetration depth in mm
- a** Reduction amount in mm

$$T_{red.} = CDX - a$$

Grooving depth reduction

Shank	Reduction a (mm) of the maximum grooving depth (CDX)																	
	0	0,5	1	1,5	2	2,5	3	3,5	4	4,5	5	5,5	6	6,5	7	7,5	8	
E12R/L0022...	44	70	80	95	115	150	225	>450										
E16R/L0026...	52	90	105	125	155	210	305	>600										
E20R/L0026...	52	110	125	140	160	195	240	320	475	>950								
E20R/L0033...	66	110	125	140	160	195	240	320	475	>950								
E25R/L0026...	52	140	160	190	235	310	465	>930										
E25R/L0033...	66	155	175	200	230	275	340	450	675	>1350								
E25R/L0040...	80	155	175	200	230	275	340	450	675	>1350								

Workpiece diameter D (mm)

Maximum workpiece diameter (CODX) with full penetration depth (CDX) in mm

Calculation example:

E25R0033...

CDX = 33 mm, Ø 66 mm

$$D = \text{Ø } 200 \text{ mm} \qquad CDX - a = T_{red.} \\ 33 - 1,5 = 31,5 \text{ mm}$$

Clamping Method – SX-System

System function – inserting and removing the cutting inserts

Precision system for internal and external grooving.

The key has been designed in such a way that it will not stress the material beyond its 'elastic limit'.

With this alternate system the material always remains in its flexible range and provides a substantial increase in tool life.

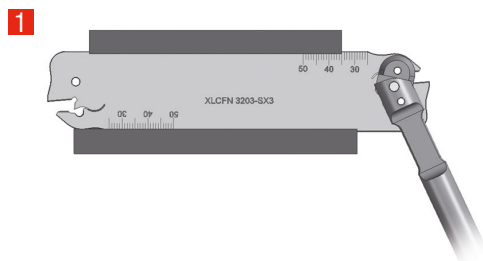

1 Locate wrench into blade with pins located in two holes

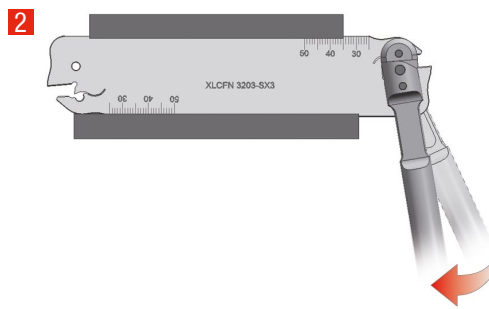

2 Movement of the fitting key in the direction of the insert seat opens the tool.

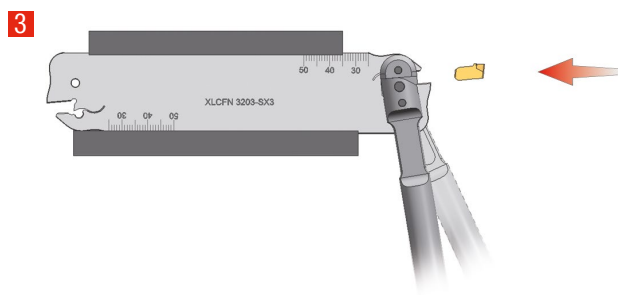

3 Load the grooving insert into position and press against the seat.

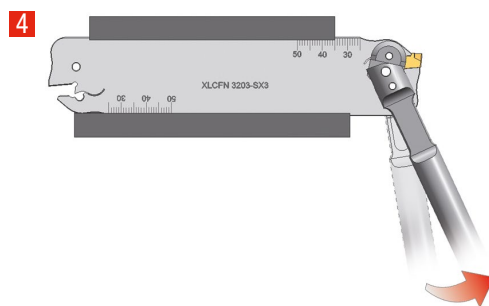

4 Moving the key forward causes the insert seat to close and clamp the insert.

i When changing the inserts, always maintain tension on the key!

The clamp is designed so that the wrench can be inserted from both sides of the blade according to the accessibility.

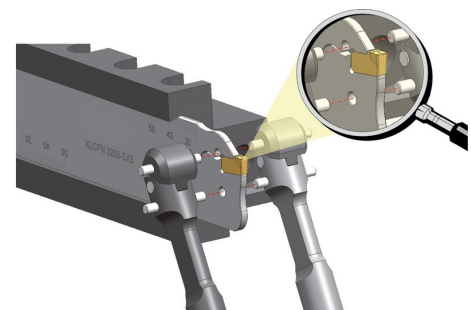

Maximum blade projection when turning

Blade	max. overhang
SX 2 – SX 3	25 mm
SX 4 – SX 5	30 mm
SX 6	35 mm

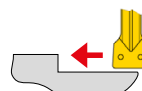

3

Clamping function – ModularClamp-Module

Module unclamped

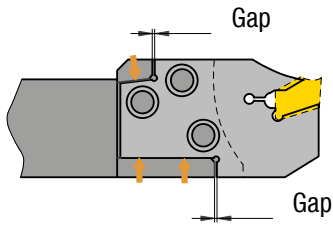

▲ Gap between module and support face for axial clamping

Module clamped

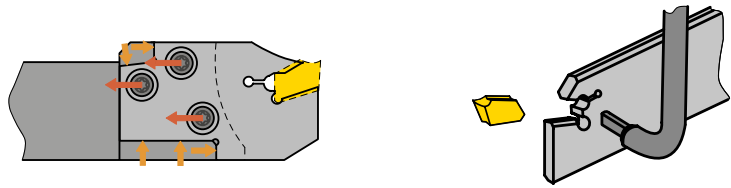

▲ Axial clamping with support face
▲ Connection free from play, therefore maximum stability

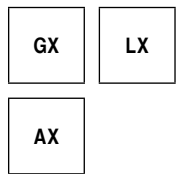

Active insert clamping

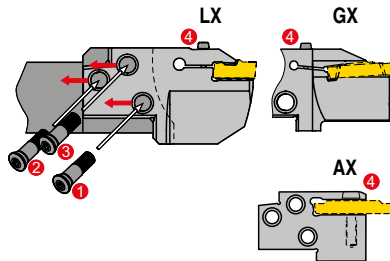

Clamping screws 1, 2 and 3 are used to clamp the modules.
The insert is clamped in the module via the additional screw 4.

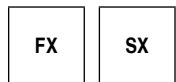

Self clamping of the insert

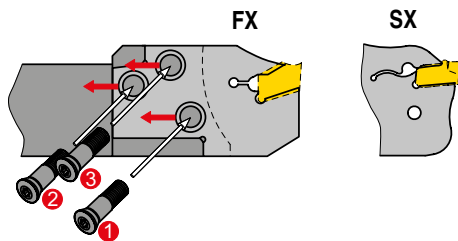

Clamping screws 1, 2 and 3 are used for clamping the module.
The insert is self-clamping.

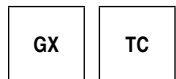

Active insert clamping

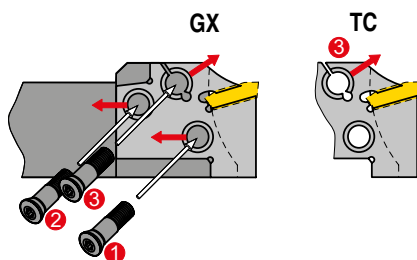

Clamping screws 1 and 2 are used for clamping the module.
Important: first tighten clamp screws 1 and 2.
Then clamp the insert with screw 3.

Torque Moment ModularClamp Module Screws

ModularClamp – Tool holder

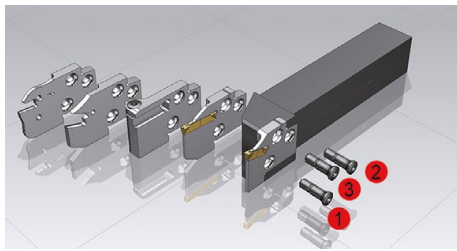

1 Tighten screws to the correct Torque moment in this order.

ModularClamp – Tool holder	Screw	Torx	Torque moment	
			Nm	in.lbs
E12..	M2,5x10	T08	1,2	10,6
E16..	M3,5x12,5	T15	3,2	28,3
E20..	M4x14	T15	4,0	35,4
E25..	M5x18	T20	5,0	44,3
E32..	M6x20	T25	6,0	53,1

ModularClamp – Boring bar

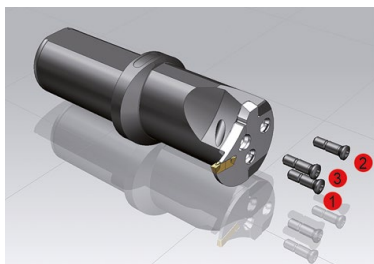

1 Tighten screws to the correct Torque moment in this order.

ModularClamp – Boring bar	Screw	Torx	Torque moment	
			Nm	in.lbs
I16..	M2,5x10	T08	1,2	10,6
I20..	M3x11	T10	2,0	17,7
I25..	M3,5x12,5	T15	3,2	28,3
I32..	M4,5x17	T20	4,0	35,4
I40..	M5x18	T20	5,0	44,3

Tightening torque for the insert clamping

Recommended tightening torque

Grooving systems	Screw	Torx	Torque moment	
			Nm	in.lbs
GX / AX / LX	M3,5	T15	3,2	28,3
	M4,0	T15/T20	4,0	35,4
	M5,0	T20	5,0	44,3

Advantages due to DirectCooling

Internal coolant supply with groove machining has a decisively positive effect on your turning process. In our CERATIZIT grooving range, the following grooving systems have an internal coolant supply:

- ▲ **SX** Grooving holder (single tool)
- ▲ **GX** Grooving holder (single tool)

Advantages due to DirectCooling

- ▲ Improved chip control
- ▲ Longer service life of the indexable insert
- ▲ Greater process security
- ▲ Application of higher cutting data

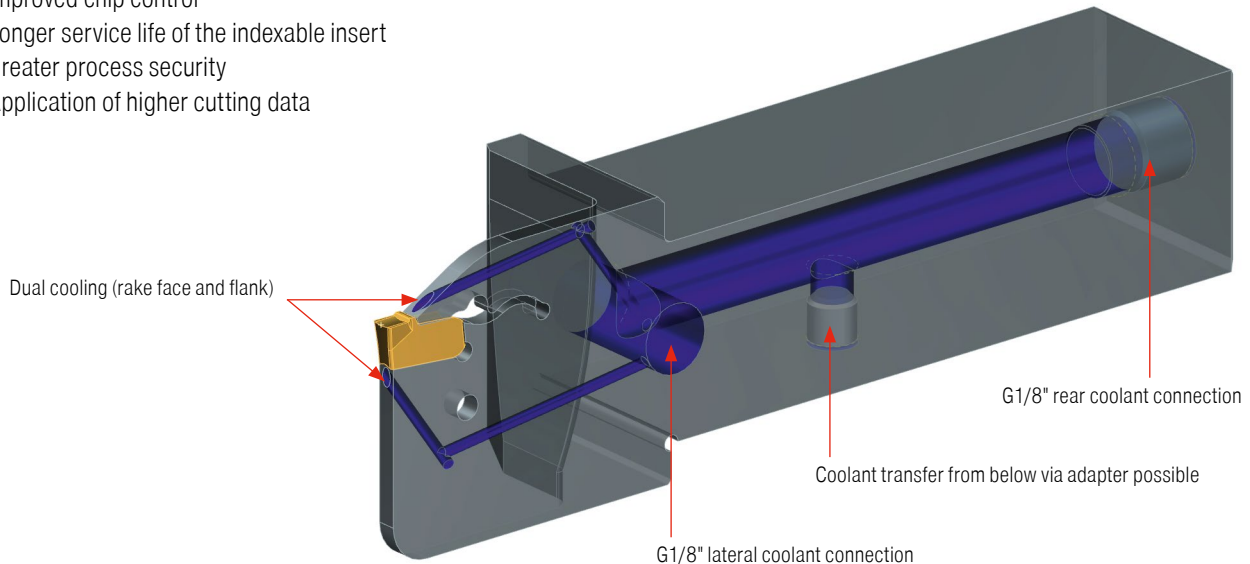

Advantages of the trochoidal turning strategy

- ▲ Less wear and longer tool life due to softer entry and exit
- ▲ Smaller angle of engagement = less vibration
- ▲ Up to 40% higher feed rate values possible
- ▲ Broad field of application in austenitic steels, heat-resistant steels, Inconel and nickel-base alloys as well as long-chipping ductile materials
- ▲ Savings on tools

Trochoidal turning with support of the following CAM systems:

- ▲ hyperMill – High-performance turning
- ▲ Esprit CAM – ProfitTurning
- ▲ SolidCAM – Turning
- ▲ EdgeCAM – Waveform turning
- ▲ MasterCAM – Dynamic turning

Possible applications

- ▲ Radial and axial recesses and grooves
- ▲ Rough machining – high-speed turning with button insert

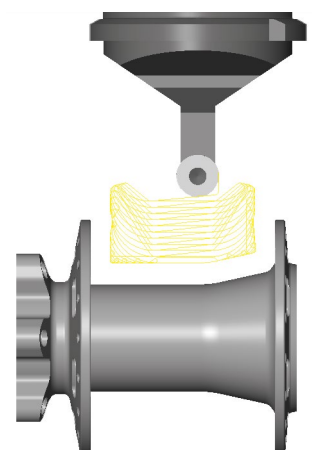
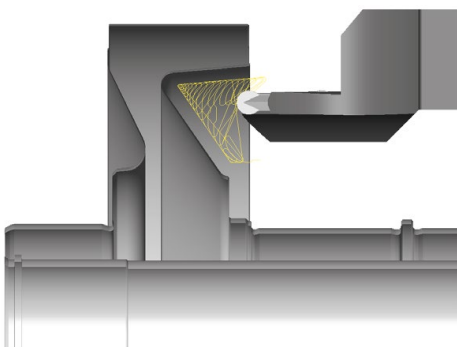

General references

Tool position

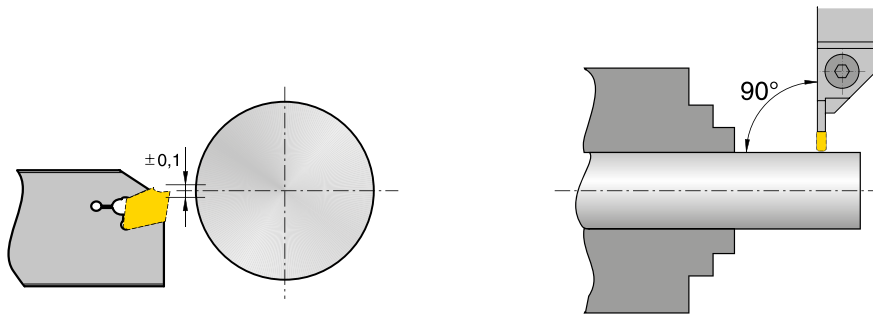

Tool overhang

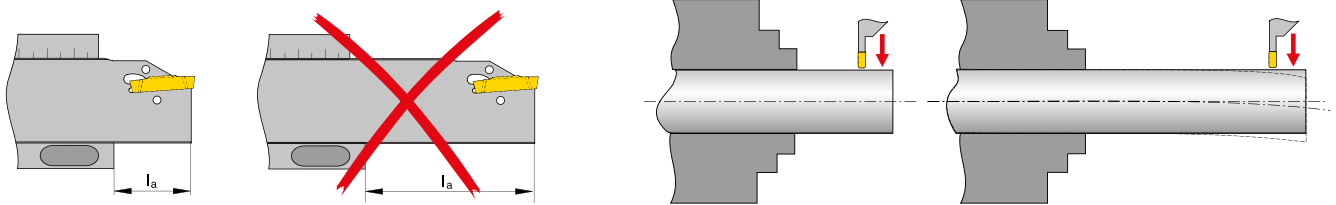

i As a rule of thumb: Overhang l_a should not be greater than 8 x s (Groove width).

References for Parting off

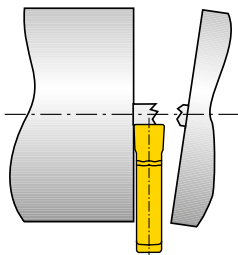

From \varnothing 5 mm on, reduce feed "f" by approx. 50%. No parting across centre (risk of breakage).

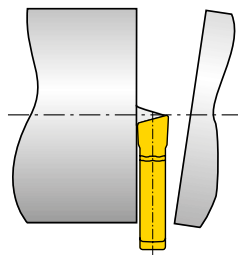

For parting pip-free, use R or L inserts. In order to minimize lateral deflection reduce feed by approx. 20–50 %.

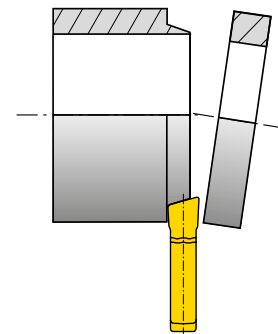

In order to prevent ring formation, use R or L inserts. Reduce feed "f" because of lateral deflection by approx. 20 % - 50%.

References for grooving

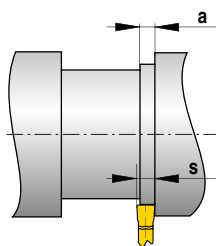

When grooving with an axial displacement the width „a“ should amount to at least 70 % of the grooving width „s“.

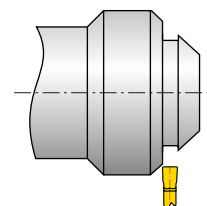

When grooving oblique surfaces the feed should be reduced by approx. 20 % - 50 % until fully engaged.

Trouble shooting guide for grooving FX/SX/GX/LX

Type of problem															
Type of wear				Work piece problems				Swarf control							
Edge breakage	Built-up edge	Wear on clearance face	Plastic deformation	Vibration	Formation of pits and burrs	Chattered surface	Surface quality	Chip too long (snarl chip)	Chip too short (fragmented chip)						
	↑	↓	↓	↓			↑	↓		Cutting speed	Cutting data	Remedy measures			
↓			↓	↑		↓	↓	↑	↓	Feed rate					
↓		↓	↓		↓	↓	↓			Feed rate at centre	-R -F -M ↑ ↓				
↑	↓		⤿	⤿	↓	↓	↓	↓	↑	Chip groove	Insert selection				
					●					R/L execution					
↑		↑	↑	↓	↓	↓	↑			Corner radius	larger ↑ smaller ↓				
↓		↑	↑							Tool Material	Wear resistance ↑ toughness ↓				
				↓		↑	↑			Groove width	General criteria				
⤿				⤿		⤿	⤿			Tool clamping					
⤿				⤿		⤿	⤿			Work piece clamping					
⤿				⤿			↓			Overhang					
⤿		⤿		⤿	⤿		⤿			Tip height					
	●	●	●		●		●	●		Cooling lubricant					

↑ raise, increase large influence
↑ raise, increase small influence

↓ avoid, reduce large influence
↓ avoid, reduce small influence

⤿ check, optimise
● use

Trouble shooting guide for TC threading

Type of problem														
Type of wear			Workpiece				Swarf control							
Wear on clearance face	Break out cut	Plastic deformation	Built-up edge	Formation of a shoulder at the external thread Ø	Profile	Surface quality	Chatter marks, vibrations	Chip too thick	Chip too thin	Chip shape (snarl chip)				
↓		↓	↑			↑	↓				Cutting speed	Cutting data	Remedy measures	
a, b	a, b		a, b	a, b		a, b	a, b	a, b		a, b	Feed			a – over the flanks b – Alternating flanks
↑	↓	↓		↓	↓	↓	↓	↓	↑	↔	Feed (Cutting depth)			
↓	↑	↑		↔	↔	↑	↔	↑	↓	↓	Number of passes	Indexable insert selection	Remedy measures	
				●	●	●					Spring cut (Air cut)			
			●			●	●			●	Chip groove			
↑	↓	↑									Tool Material	Various criteria	Remedy measures	
				●	●	●					Full profile			Wear resistance ↑ toughness ↓
											Partial profile			
	↔					↔	↔				Stable tool holder / insert	Various criteria	Remedy measures	
	↔					↔	↔				Stable workpiece			
	↓					↓	↓				Overhang			
↔	↔	↔			↔	↔	↔				Tip height	Various criteria	Remedy measures	
●	●	●	●	●		●					Cooling lubricant			

↑ raise, increase large influence
↑ raise, increase small influence

↓ avoid, reduce large influence
↓ avoid, reduce small influence

↔ check, optimise
● use

Wear causes

Wear on clearance face

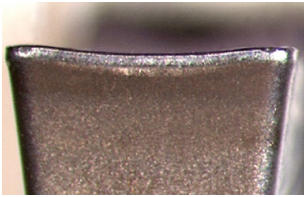

Abrasion on the flank, normal wear after a given operation time

Cause

- ▲ cutting speed too high
- ▲ grade with too low wear resistance
- ▲ insufficient coolant

Remedy

- ▲ Reduce the cutting speed
- ▲ select a more wear resistant grade
- ▲ Improve/check coolant feed

Edge chipping



Excessive mechanical stress on the cutting edge causing carbide particles to break out.

Cause

- ▲ too hard grade
- ▲ vibration
- ▲ too high feed and depth of cut
- ▲ chip impact

Remedy

- ▲ use tougher grade
- ▲ use negative geometry with chip breaker
- ▲ reduce overhang, check center height
- ▲ stabilize the cutting edge

Cratering

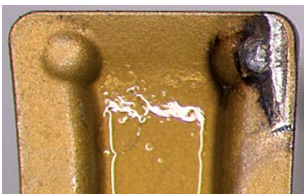

The outgoing hot chip causes cratering of the insert on the clamping surface.

Cause

- ▲ too high cutting speed, feed, or both
- ▲ too low rake angle
- ▲ grade with too low wear resistance
- ▲ incorrectly supplied cooling

Remedy

- ▲ Reduce cutting speed and / or feed
- ▲ Check coolant flow and / or increase pressure
- ▲ Use harder grade

Plastic deformation



Large mechanical load produces high temperature machining, this can lead to plastic deformation.

Cause

- ▲ too high operating temperature, thus softening the base material
- ▲ unsuitable grade
- ▲ inadequate coolant supply

Remedy

- ▲ Reduce the cutting speed
- ▲ select a more wear resistant grade
- ▲ use coolant

Built-up edge



Weld deposits of material on the cutting edge occurs when the chip does not flow caused by low average temperature.

Cause

- ▲ too low cutting speed
- ▲ too low rake angle
- ▲ Incorrect grade
- ▲ lack of cooling / lubrication

Remedy

- ▲ Increase the cutting speed
- ▲ Increase rake angle
- ▲ Use TiN coating
- ▲ increase coolant strength

Notch wear

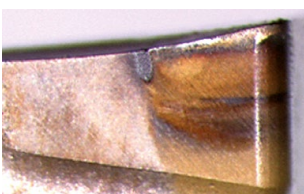

Contraction at maximum cutting depth.

Cause





- ▲ Oxidation at the cutting edge
- ▲ Too high a temperature at the edge

Remedy

- ▲ Use different cutting depths
- ▲ Reduce cutting speed
- ▲ Improve/check coolant feed

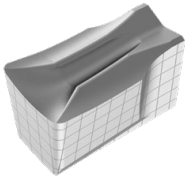
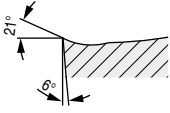
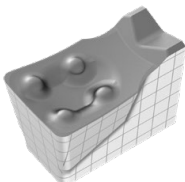
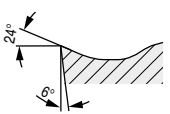

Chip breakers / Applications

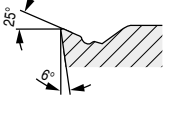
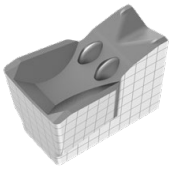
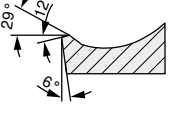
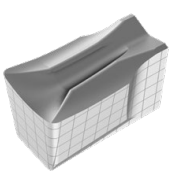
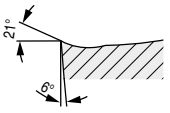
System GX

		Smooth cut	irregular cut	interrupted cut	Model	f in mm/rev.
						
-F2 ▲ very positive geometry ▲ honed cutting edge ▲ low feed rates ▲ low cutting forces ▲ first choice for stainless materials		CTCP325	CTP1340	CTPP345		0,05–0,15
		CTP1340	CTP1340/CTPP345	CTPP345		
		CTCP325	CTP1340			
		CTP1340	CTP1340	CTPP345		
		CTCP325				
		CTP1340	CTP1340			
		CTP1340	CTP1340			
-Standard / -E ▲ positive geometry ▲ low-medium feed rates ▲ low cutting forces ▲ universal application ▲ first choice for axial grooving		CTCP325	CTCP335/CTP1340	CTPP345		0,05–0,17
		CTP1340	CTP1340/CTPP345	CTPP345		
		CTCP325	CTCP335/CTP1340	CTP1340		
		CTP1340	CTP1340	CTPP345		
		CTCP325				
		CTP1340	CTP1340			
		CTP1340	CTP1340			
-M40 ▲ stable geometry ▲ medium feed rates ▲ universal application ▲ good chip control		CTCP325	CTP1340	CTPP345		0,075–0,20
		CTP1340	CTP1340/CTPP345	CTPP345		
		CTCP325	CTCP325/CTP1340	CTP1340		
		CTP1340	CTP1340	CTPP345		
		CTCP325				
		CTP1340	CTP1340			
		CTP1340	CTP1340			
-M1 ▲ very stable cutting edge ▲ medium-high feed rates ▲ for interrupted cut ▲ for high tensile materials ▲ first choice for parting off		CTCP325	CTP1340	CTPP345		0,1–0,20
		CTP1340	CTP1340/CTPP345	CTPP345		
		CTCP325	CTCP325/CTP1340	CTP1340		
		CTP1340	CTP1340	CTPP345		
		CTCP325				
		CTP1340	CTP1340			
		CTP1340	CTP1340			
-27P ▲ very positive geometry ▲ ground periphery ▲ sharp cutting edge ▲ polished chip breaker ▲ first choice for non-ferrous metals						0,05–0,25
		H216T	H216T	H216T		
		H216T	H216T	H216T		
		H216T	H216T			
		H216T				
		H216T				
		H216T				

Chip breakers / Applications



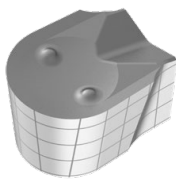
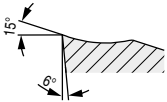
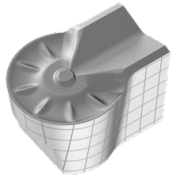
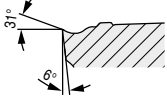



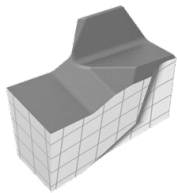
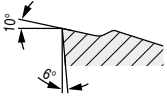

System GX

		Smooth cut	irregular cut	interrupted cut	Model	f in mm/rev.
						
Standard – Radius ▲ positive geometry ▲ honed cutting edge ▲ low-medium feed rates ▲ low cutting forces ▲ Radius grooving/copy turning		CTCP325	CTCP325/CTP1340	CTP1340		0,05–0,20
		CTP1340	CTP1340	CTP1340		
		CTCP325	CTCP325/CTP1340	CTP1340		
		CTP1340	CTP1340			
		CTCP325				
		CTP1340	CTP1340			
-M3 – Radius ▲ stable geometry ▲ medium-high feed rates ▲ high surface quality ▲ Radius grooving/copy turning		CTCP325	CTCP325/CTCP335	CTCP335		0,07–0,20
		CTCP335	CTCP335			
		CTCP325	CTCP325/CTCP335	CTCP335		
		CTCP325				
		CTCP325				

Circlip grooving

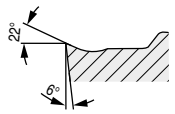

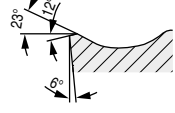
Standard ▲ positive geometry ▲ honed cutting edge ▲ low feed rates ▲ small corner radius ▲ Circlip grooves		CTP1340	CTP1340	CTP1340		0,05–0,30
		CTP1340	CTP1340	CTP1340		
		CTP1340	CTP1340	CTP1340		
		CTP1340	CTP1340	CTP1340		
		CTP1340	CTP1340	CTP1340		
		CTP1340	CTP1340			

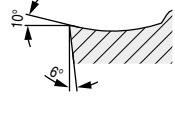
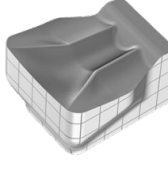
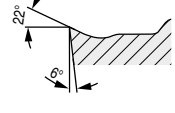
Chip breakers / Applications

System SX		Smooth cut	irregular cut	interrupted cut	Model	f in mm/rev.
						
<p>-F2</p> <ul style="list-style-type: none"> ▲ very positive geometry ▲ honed cutting edge ▲ low feed rates ▲ low cutting forces ▲ first choice for stainless materials 		CTCP325	CTCP325/CTP1340	CTPP345		0,05-0,15
		CTP1340	CTP1340/CTPP345	CTPP345		
		CTCP325	CTCP325/CTP1340	CTP1340		
		CTP1340	CTP1340	CTPP345		
		CTCP325				
		CTP1340	CTP1340			
<p>-M1</p> <ul style="list-style-type: none"> ▲ very stable cutting edge ▲ medium-high feed rates ▲ for interrupted cut ▲ for high tensile materials ▲ first choice for parting off 		CTCP325	CTCP335/CTP1340	CTPP345		0,10-0,20
		CTP1340	CTP1340	CTPP345		
		CTCP325	CTCP325/CTP1340	CTP1340		
		CTP1340	CTP1340	CTPP345		
		CTCP325				
		CTP1340	CTP1340			
<p>-M2</p> <ul style="list-style-type: none"> ▲ stable geometry ▲ medium feed rates ▲ universal application ▲ good chip control 		CTCP325	CTCP335/CTP1340	CTPP345		0,075-0,20
		CTP1340	CTP1340	CTPP345		
		CTCP325	CTCP325/CTP1340	CTP1340		
		CTP1340	CTP1340	CTPP345		
		CTCP325				
		CTP1340	CTP1340			
<p>-27P</p> <ul style="list-style-type: none"> ▲ very positive geometry ▲ ground periphery ▲ sharp cutting edge ▲ polished chip breaker ▲ first choice for non-ferrous metals 						0,05-0,25
		H216T	H216T	H216T		
		H216T	H216T	H216T		
		H216T	H216T	H216T		
		H216T				

3

Chip breakers / Applications

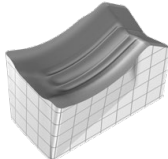
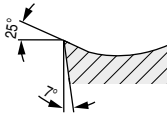
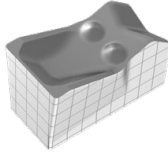
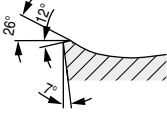
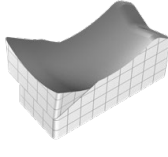
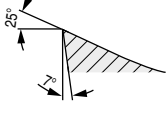
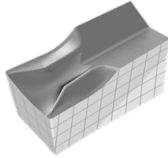
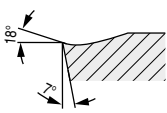
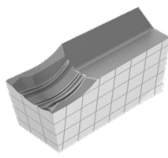
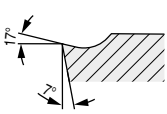
System FX		Smooth cut	irregular cut	interrupted cut	Model	f in mm/rev.
						
-F1 ▲ very positive geometry ▲ low-medium feed rates ▲ low cutting forces ▲ good chip control ▲ low cutting edge build up		CTCP325	CTCP325/CTP1340	CTPP345		0,05–0,15
		CTP1340	CTP1340/CTPP345	CTPP345		
		CTCP325	CTCP325/CTP1340	CTP1340		
		CTP1340	CTP1340	CTPP345		
		CTCP325				
		CTP1340	CTP1340			
		CTP1340	CTP1340			
-M1 ▲ very stable cutting edge ▲ medium-high feed rates ▲ for interrupted cut ▲ for high tensile materials ▲ first choice for parting off		CTCP325	CTCP335/CTP1340	CTPP345		0,08–0,20
		CTP1340	CTP1340/CTPP345	CTPP345		
		CTCP325	CTCP325/CTP1340	CTP1340		
		CTP1340	CTP1340	CTPP345		
		CTCP325				
		CTP1340	CTP1340			
		CTP1340	CTP1340			
-27P ▲ very positive geometry ▲ ground periphery ▲ sharp cutting edge ▲ polished chip breaker ▲ first choice for non-ferrous metals						0,03–0,13
		H216T	H216T	H216T		
		H216T	H216T	H216T		
		H216T	H216T			
		H216T				
-F2 ▲ very positive geometry ▲ honed cutting edge ▲ low feed rates ▲ low cutting forces ▲ first choice for stainless materials		CTP1340	CTP1340	CTP1340		0,05–0,10
		CTP1340	CTP1340	CTP1340		
		CTP1340	CTP1340	CTP1340		
		CTP1340	CTP1340	CTP1340		
		CTP1340	CTP1340	CTP1340		
		CTP1340	CTP1340			
-F3 ▲ very positive geometry ▲ honed cutting edge ▲ low feed rates ▲ low cutting forces ▲ reduced burrs / edge build up		CTP1340	CTP1340	CTP1340		0,02–0,06
		CTP1340	CTP1340	CTP1340		
		CTP1340	CTP1340	CTP1340		
		CTP1340	CTP1340	CTP1340		
		CTP1340	CTP1340	CTP1340		
		CTP1340	CTP1340			

Example of Coding Grooving Tools

Grooving insert

GX	16	E	2	3.00	N	0.50
Grooving system (GX)	Insert length (16 mm)	Type of insert, application	Width class of the holder / module or support surface (2 mm)	Groove width (3.0 mm)	Insert seat N=Neutral L=Left Handed R=Right Handed	Corner radius size (0.5 mm)

Module

E	25	12	R	GX	16	2
Application E = external I = internal	Size (25 mm)	Maximum groove depth (12 mm)	Module version R=Right Handed L=Left Handed	Grooving system (GX)	Insert size (16 mm)	Width class 2

Basic holder

E	25	00	R	2525	L
Application E = external I = internal	Size (25 mm)	Approach angle 0°	Holder version R=Right Handed L=Left Handed	Shank type 25x25mm	Shank length L = (sh. ISO)

GX mono holder (old)

E	25	R	00	2525	M	GX24-3
----------	-----------	----------	-----------	-------------	----------	---------------

GX mono holder (new)

E	25	R	00	2525	M	GX24
----------	-----------	----------	-----------	-------------	----------	-------------

GX mono holder (new with DC)

E	25	R	00	2525	M	GX24
----------	-----------	----------	-----------	-------------	----------	-------------



Compilation

Basic holder

Module

Grooving insert

E25 R 00 – 2525L

E25 R 12 – GX 16-2

GX 16-2 E3.00 N 0.50

NEW

S

Insert clamping screw

NEW

S

Insert clamping screw

DirectCooling

Grades Overview

CTCP325
DRAGONSKIN

- ▲ Carbide, TiCN-Al₂O₃-coated
- ▲ ISO | **P25** | M20 | **K30** | S25
- ▲ The wear-resistant solution for steel and cast iron materials at high cutting speeds

CTCP335
DRAGONSKIN

- ▲ Carbide, TiCN-Al₂O₃-coated
- ▲ ISO | **P35** | M30 | **K35**
- ▲ The reliable choice for machining steel and cast iron materials

CTPP345
DRAGONSKIN

- ▲ Carbide, TiAlTaN-coated
- ▲ ISO | **P45** | **M40** | S40
- ▲ The reliable solution for steel materials and austenitic steels under unstable conditions

CTP1340
DRAGONSKIN

- ▲ Carbide, TiAlTaN-coated
- ▲ ISO | **P30** | **M25** | **K30** | N30 | **S30** | O30
- ▲ The universal high-performance grade for steel materials, austenitic steel, cast iron materials and heat-resistant alloys

CTPP520
DRAGONSKIN

- ▲ Carbide, TiAlTaN-coated
- ▲ ISO | **P20** | **M15** | **K25** | S25 | H5
- ▲ The wear-resistant grade for wet machining of steels

CTPP535
DRAGONSKIN

- ▲ Carbide, AlTiN-coated
- ▲ ISO | **P35** | **M30** | **K25** | **S30**
- ▲ The tough thread turning grade for universal application

H216T

- ▲ Carbide, uncoated
- ▲ ISO | **K15** | **N15** | S15 | O5
- ▲ The uncoated carbide grade for machining aluminium and other non-ferrous metals
- ▲ Also highly suitable for HSC machining

Application

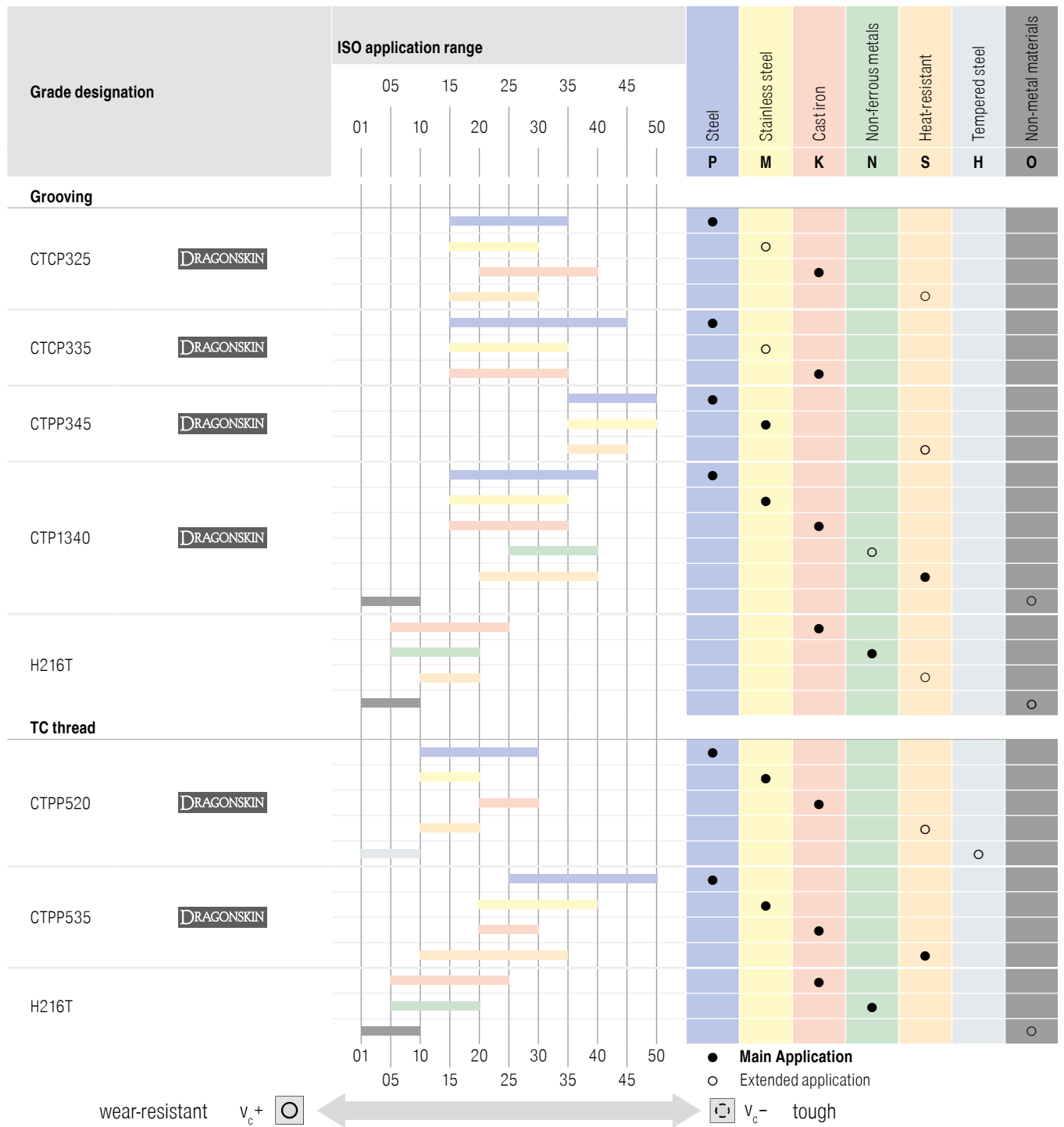

3

Table of contents

System overview	289
Toolfinder	288+289
Product programme	
UltraMini	290-320
MiniCut	321-337
Technical Information	
Cutting Data	338-341
Symbol explanation, coatings and thread types	342

WNT \ Performance

Premium quality tools for high performance.

The premium quality tools from the **WNT Performance** product line have been designed for specific applications and are distinguished by their outstanding performance. If you make high demands on the performance of your production and want to achieve the very best results, we recommend the Premium tools in this product line.

Toolfinder

EcoCut Mini

From \varnothing 2 mm

Inserts and tool holders can be found in → **Chapter 10 – EcoCut**

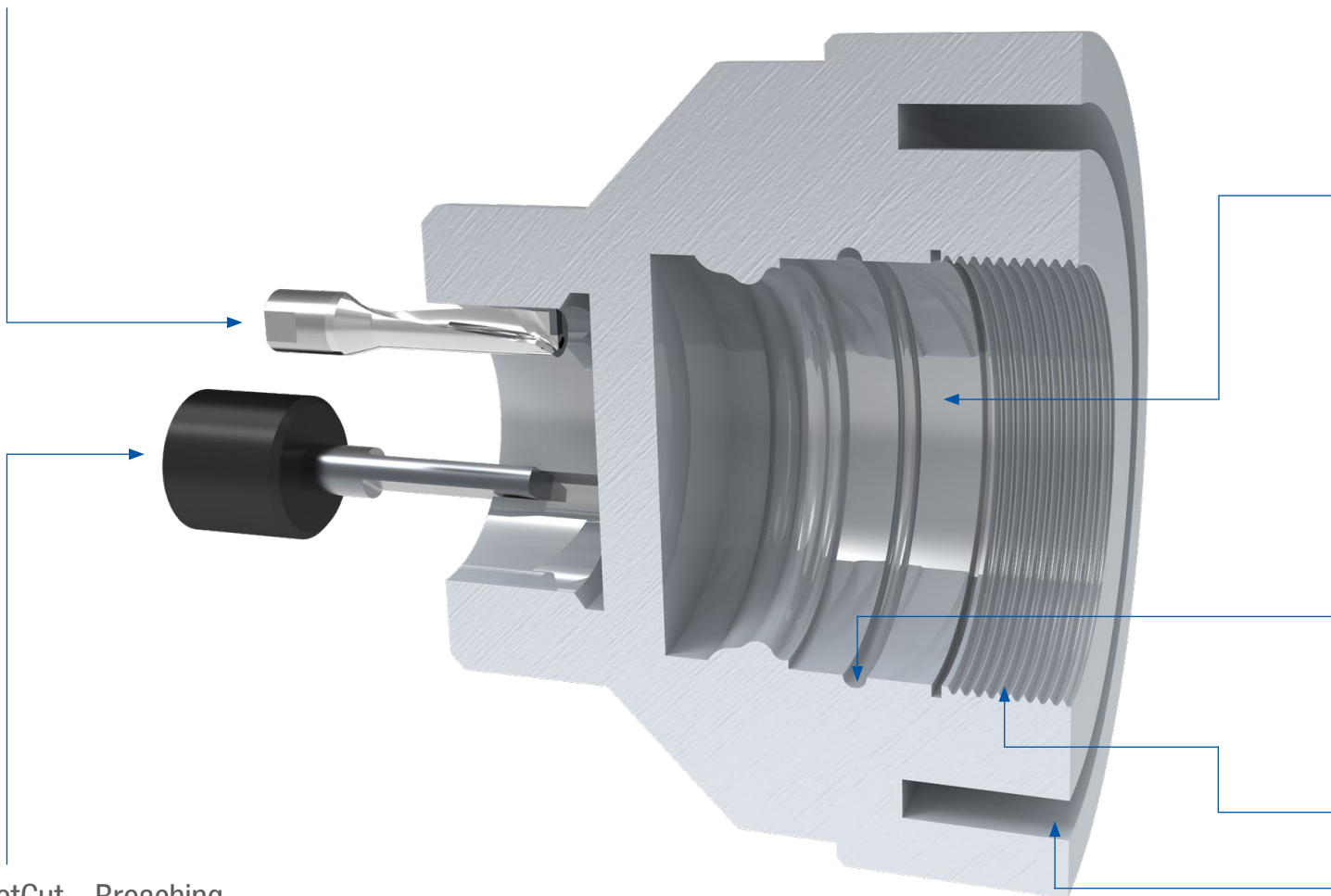

SlotCut – Broaching

Inserts + Holder DIN138



Products and product information can be found in our main catalogue and online shop.

System overview

UltraMini



- ▲ from Ø 0.5 mm
- ▲ flexible system
- ▲ ground inserts
- ▲ high repeatability
- ▲ coolant supply to the cutting edge

MiniCut

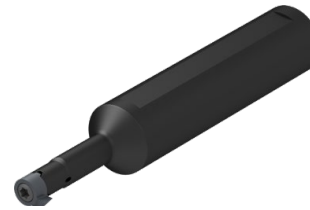

- ▲ from Ø 7.8 mm
- ▲ stable three-rib interface
- ▲ easy handling
- ▲ coolant supply to the cutting edge
- ▲ precise cutting edge position

Hole diameter in mm	UltraMini										MiniCut						
	≥ 0,5	≥ 2	≥ 2,4	≥ 2,8	≥ 3	≥ 4	≥ 5	≥ 6	≥ 8	≥ 16	≥ 8	≥ 9	≥ 11	≥ 14	≥ 16		
Internal turning and profiling		290-293	290-293	290-293	290-293		290-293	290-293	290-293				321	321	321	321	
Internal turning and profiling – hard turning																	
High-feed turning		295			295	295	295	295									
Turning and profile turning – super alloys		294		294		294	294	294									
Internal turning					296	296	296						322	322	322	322	
Back boring						297	297	297	297				323	323	323	323	
Turning and chamfering							298	298					323	323	323	323	
Pre-parting and chamfering						298	298	298					324	324	324	324	
Groove turning		299-301			299-301	299-301	299-301	299-301					325+326	325+326	325+326	325+326	
Internal Undercuts		302		302		302	302	302					327	327	327	327	
Groove and profile turning						303	303	303					328	328	328	328	
Internal thread turning			304-306			304-306	304-306	304-306					329-331	329-331	329-331	329-331	
Axial grooving							309-314	309-314	309-314	309-314			332+333	332+333	332+333	332+333	
suitable holder						315-320							334-337				
Sets																	

UltraMini – Inserts for internal turning and profiling

▲ CDX = Maximum depth of cut when turning outwards

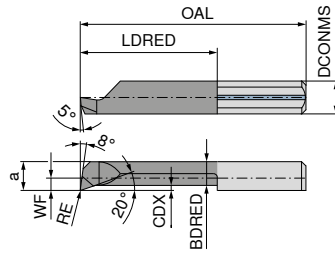
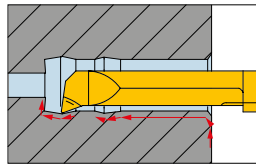

Illustrations show right-hand versions

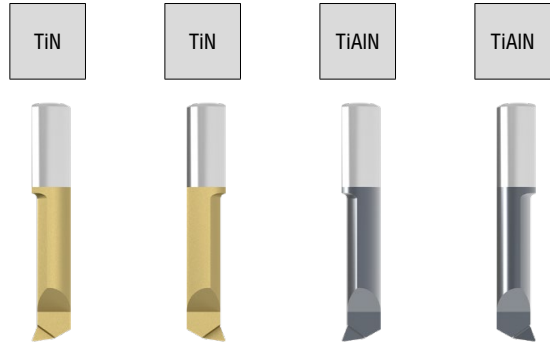

Designation	DCONMS _{h6} mm	WF mm	DMIN mm	a mm	OAL mm	LDRED mm	CDX mm	BDRD mm	RE mm	Standard tool holder	Left-hand		Right-hand	
											73 005 ...	73 004 ...	73 005 ...	73 004 ...
R/L 050.05-2	4		0.5	0.4	20	2	0.03	0.32	0.02	645.00...D	500		500	
R/L 050.06-2	4		0.6	0.5	20	2	0.05	0.40	0.04	645.00...D	510		510	
R/L 050.06-3	4		0.6	0.5	20	3	0.05	0.40	0.04	645.00...D	511		511	
R/L 050.08-4	4		0.8	0.7	20	4	0.05	0.60	0.04	645.00...D			812	812
R/L 050.1-8	4		1.0	0.9	22	8	0.10	0.75	0.05	645.00...D			813	813
R/L 050.15-5	4		1.5	1.3	19	5	0.10	1.15	0.05	645.00...D	515		515	
R/L 050.15-10	4		1.5	1.3	24	10	0.10	1.15	0.05	645.00...D	516		516	
R/L 050.15-12	4		1.5	1.3	26	12	0.10	1.15	0.05	645.00...D			818	818
R/L 050.2-5	4		2.0	1.7	19	5	0.10	1.50	0.05	645.00...D	520		520	
R/L 050.2-10	4		2.0	1.7	24	10	0.10	1.50	0.05	645.00...D	521		521	
R/L 050.2-15	4		2.0	1.7	29	15	0.10	1.50	0.05	645.00...D	522		522	
R/L 050.3-10	4	0.6	2.8	2.6	24	10	0.20	2.30	0.10	645.00...D	531		531	
R/L 050.3-16	4	0.6	2.8	2.6	30	16	0.20	2.30	0.10	645.00...D	530		530	
R/L 050.3-20	4	0.6	2.8	2.6	34	20	0.20	2.30	0.10	645.00...D	532		532	
R/L 050.35-10	4	1.1	3.5	3.1	24	10	0.25	2.80	0.10	645.00...D			835	835
R/L 050.35-16	4	1.1	3.5	3.1	30	16	0.25	2.80	0.10	645.00...D			836	836
R/L 050.35-20	4	1.1	3.5	3.1	34	20	0.25	2.80	0.10	645.00...D			837	837
R/L 050.35-24	4	1.1	3.5	3.1	38	24	0.25	2.80	0.10	645.00...D			838	838
R/L 050.4-10	4	1.5	4.0	3.5	24	10	0.30	3.00	0.10	645.00...D	541		541	
R/L 050.4-16	4	1.5	4.0	3.5	30	16	0.30	3.00	0.10	645.00...D	540		540	
R/L 050.4-20	4	1.5	4.0	3.5	34	20	0.30	3.00	0.10	645.00...D	542		542	
R/L 050.4-24	4	1.5	4.0	3.5	38	24	0.30	3.00	0.10	645.00...D	545		545	
R/L 050.4-28	4	1.5	4.0	3.5	42	28	0.30	3.00	0.10	645.00...D	546		546	
R/L 050.5-10	5	1.9	5.0	4.4	25	10	0.50	3.80	0.15	645.00...D	551		551	
R/L 050.5-15	5	1.9	5.0	4.4	30	15	0.50	3.80	0.15	645.00...D	552		552	
R/L 050.5-20	5	1.9	5.0	4.4	35	20	0.50	3.80	0.15	645.00...D	550		550	
R/L 050.5-25	5	1.9	5.0	4.4	40	25	0.50	3.80	0.15	645.00...D	553		553	
R/L 050.5-30	5	1.9	5.0	4.4	45	30	0.50	3.80	0.15	645.00...D	554		554	
R/L 050.5-35	5	1.9	5.0	4.4	50	35	0.50	3.80	0.15	645.00...D	556		556	
R/L 050.5-40	5	1.9	5.0	4.4	55	40	0.50	3.80	0.15	645.00...D			857	857
R/L 050.6-15	6	2.3	6.0	5.3	30	15	0.50	4.50	0.15	676.00...D	561		561	
R/L 050.6-22	6	2.3	6.0	5.3	37	22	0.50	4.50	0.15	676.00...D	560		560	
R/L 050.6-25	6	2.3	6.0	5.3	40	25	0.50	4.50	0.15	676.00...D	562		562	
R/L 050.6-30	6	2.3	6.0	5.3	45	30	0.50	4.50	0.15	676.00...D	563		563	
R/L 050.6-35	6	2.3	6.0	5.3	50	35	0.50	4.50	0.15	676.00...D	564		564	
R/L 050.6-42	6	2.3	6.0	5.3	57	42	0.50	4.50	0.15	676.00...D	565		565	
R/L 050.7-20	7	2.8	6.8	6.3	35	20	0.60	5.50	0.15	676.00...D	572		572	
R/L 050.7-25	7	2.8	6.8	6.3	40	25	0.60	5.50	0.15	676.00...D	573		573	
R/L 050.7-30	7	2.8	6.8	6.3	45	30	0.60	5.50	0.15	676.00...D	574		574	
R/L 050.7-35	7	2.8	7.0	6.3	50	35	0.60	5.50	0.15	676.00...D	575		575	
R/L 050.7-40	7	2.8	7.0	6.3	55	40	0.60	5.50	0.15	676.00...D	576		576	
R/L 050.7-45	7	2.8	7.0	6.3	60	45	0.60	5.50	0.15	676.00...D	577		577	
R/L 050.7-50	7	2.8	7.0	6.3	65	50	0.60	5.50	0.15	676.00...D	578		578	
P											●	●	●	●
M											●	●	●	●
K											●	●	●	●
N											●	●	●	●
S											○	○	●	●
H											○	○	●	●
O											●	●	●	●

UltraMini – Inserts for internal turning and profiling

▲ CDX = Maximum depth of cut when turning outwards

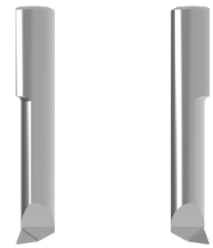
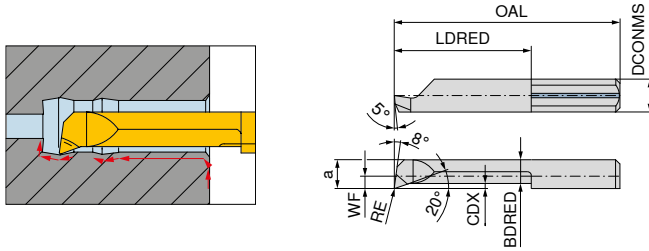

Designation	DCONMS _{h6} mm	WF mm	DMIN mm	a mm	OAL mm	LDRED mm	CDX mm	BDRED mm	RE mm	Standard tool holder	Left-hand		Right-hand	
											73 005 ...	73 004 ...	73 005 ...	73 004 ...
R/L 050.2-5	4		2.0	1.7	19	5	0.1	1.5	0.05	645.00...D	020		020	
R/L 050.2-10	4		2.0	1.7	24	10	0.1	1.5	0.05	645.00...D	021		021	
R/L 050.2-15	4		2.0	1.7	29	15	0.1	1.5	0.05	645.00...D	022		022	
R/L 050.3-10	4	0.6	2.8	2.6	24	10	0.2	2.3	0.10	645.00...D	031		031	
R/L 050.3-16	4	0.6	2.8	2.6	30	16	0.2	2.3	0.10	645.00...D	030		030	
R/L 050.3-20	4	0.6	2.8	2.6	34	20	0.2	2.3	0.10	645.00...D	032		032	
R/L 050.4-10	4	1.5	4.0	3.5	24	10	0.3	3.0	0.10	645.00...D	041		041	
R/L 050.4-16	4	1.5	4.0	3.5	30	16	0.3	3.0	0.10	645.00...D	040		040	
R/L 050.4-20	4	1.5	4.0	3.5	34	20	0.3	3.0	0.10	645.00...D	042		042	
R/L 050.5-10	5	1.9	5.0	4.4	25	10	0.5	3.8	0.15	645.00...D	051		051	
R/L 050.5-15	5	1.9	5.0	4.4	30	15	0.5	3.8	0.15	645.00...D	052		052	
R/L 050.5-20	5	1.9	5.0	4.4	35	20	0.5	3.8	0.15	645.00...D	050		050	
R/L 050.5-25	5	1.9	5.0	4.4	40	25	0.5	3.8	0.15	645.00...D	053		053	
R 050.5-30	5	1.9	5.0	4.4	45	30	0.5	3.8	0.05	645.00...D			054	
L 050.5-30	5	1.9	5.0	4.4	45	30	0.5	3.8	0.15	645.00...D	054			
R/L 050.6-15	6	2.3	6.0	5.3	30	15	0.5	4.5	0.15	676.00...D	061		061	
R/L 050.6-22	6	2.3	6.0	5.3	37	22	0.5	4.5	0.15	676.00...D	060		060	
R/L 050.6-25	6	2.3	6.0	5.3	40	25	0.5	4.5	0.15	676.00...D	062		062	
R/L 050.6-30	6	2.3	6.0	5.3	45	30	0.5	4.5	0.15	676.00...D	063		063	
R/L 050.7-20	7	2.8	6.8	6.3	35	20	0.6	5.5	0.15	676.00...D	072		072	
R/L 050.7-25	7	2.8	6.8	6.3	40	25	0.6	5.5	0.15	676.00...D	073		073	
R/L 050.7-30	7	2.8	6.8	6.3	45	30	0.6	5.5	0.15	676.00...D	074		074	

P														
M														
K														
N											○		○	
S														
H														
O											●		●	

→ v_c Page 339

UltraMini – Inserts for internal turning and profiling

▲ with corner radius ≤ 0.05 mm

▲ CDX = Maximum depth of cut when turning outwards

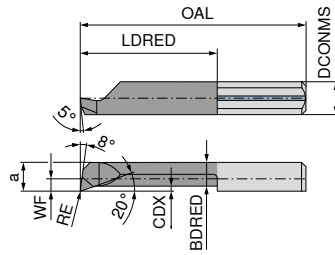
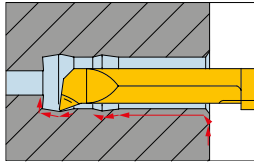

Illustrations show right-hand versions

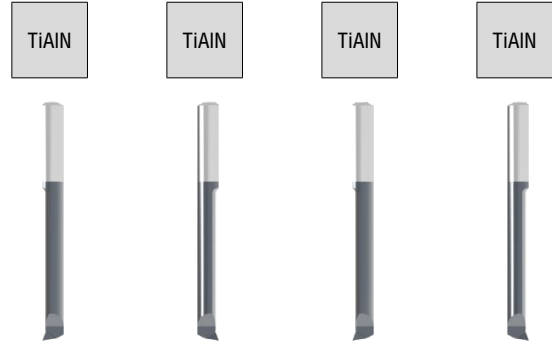

Designation	DCONMS _{h6} mm	WF mm	DMIN mm	a mm	OAL mm	LDRED mm	CDX mm	BDRED mm	RE mm	Standard tool holder	Left-hand		Right-hand	
											73 021 ...	73 020 ...	73 023 ...	73 022 ...
R/L 053.3-10	4	0.6	2.8	2.6	24	10	0.2	2.3	0.03	645.00...D	310		310	
R/L 053.3-16	4	0.6	2.8	2.6	30	16	0.2	2.3	0.03	645.00...D	316		316	
R/L 053.3-20	4	0.6	2.8	2.6	34	20	0.2	2.3	0.03	645.00...D	320		320	
R/L 053.4-10	4	1.5	4.0	3.5	24	10	0.3	3.0	0.03	645.00...D	410		410	
R/L 053.4-16	4	1.5	4.0	3.5	30	16	0.3	3.0	0.03	645.00...D	416		416	
R/L 053.4-20	4	1.5	4.0	3.5	34	20	0.3	3.0	0.03	645.00...D	420		420	
R/L 053.4-24	4	1.5	4.0	3.5	38	24	0.3	3.0	0.03	645.00...D	424		424	
R/L 053.4-28	4	1.5	4.0	3.5	42	28	0.3	3.0	0.03	645.00...D	428		428	
R/L 055.2-10	4		2.0	1.7	24	10	0.1	1.5	0.05	645.00...D			210	210
R/L 055.2-15	4		2.0	1.7	29	15	0.1	1.5	0.05	645.00...D			215	215
R/L 055.2-5	4		2.0	1.7	19	5	0.1	1.5	0.05	645.00...D			205	205
R/L 055.3-10	4	0.6	2.8	2.6	24	10	0.2	2.3	0.05	645.00...D			310	310
R/L 055.3-16	4	0.6	2.8	2.6	30	16	0.2	2.3	0.05	645.00...D			316	316
R/L 055.3-20	4	0.6	2.8	2.6	34	20	0.2	2.3	0.05	645.00...D			320	320
R/L 055.4-10	4	1.5	4.0	3.5	24	10	0.3	3.0	0.05	645.00...D			410	410
R/L 055.4-16	4	1.5	4.0	3.5	30	16	0.3	3.0	0.05	645.00...D			416	416
R/L 055.4-20	4	1.5	4.0	3.5	34	20	0.3	3.0	0.05	645.00...D			420	420
R/L 055.4-24	4	1.5	4.0	3.5	38	24	0.3	3.0	0.05	645.00...D			424	424
R/L 055.4-28	4	1.5	4.0	3.5	42	28	0.3	3.0	0.05	645.00...D			428	428
R/L 055.5-10	5	1.9	5.0	4.4	25	10	0.5	3.8	0.05	645.00...D			510	510
R/L 055.5-15	5	1.9	5.0	4.4	30	15	0.5	3.8	0.05	645.00...D			515	515
R/L 055.5-20	5	1.9	5.0	4.4	35	20	0.5	3.8	0.05	645.00...D			520	520
R/L 055.5-25	5	1.9	5.0	4.4	40	25	0.5	3.8	0.05	645.00...D			525	525
R/L 055.5-30	5	1.9	5.0	4.4	45	30	0.5	3.8	0.05	645.00...D			530	530
R/L 055.5-35	5	1.9	5.0	4.4	50	35	0.5	3.8	0.05	645.00...D			535	535
R/L 055.6-15	6	2.3	6.0	5.3	30	15	0.5	4.5	0.05	676.00...D			615	615
R/L 055.6-22	6	2.3	6.0	5.3	37	22	0.5	4.5	0.05	676.00...D			622	622
R/L 055.6-25	6	2.3	6.0	5.3	40	25	0.5	4.5	0.05	676.00...D			625	625
R/L 055.6-30	6	2.3	6.0	5.3	45	30	0.5	4.5	0.05	676.00...D			630	630
R/L 055.6-35	6	2.3	6.0	5.3	50	35	0.5	4.5	0.05	676.00...D			635	635
R/L 055.6-42	6	2.3	6.0	5.3	57	42	0.5	4.5	0.05	676.00...D			642	642
P											●	●	●	●
M											●	●	●	●
K											●	●	●	●
N											●	●	●	●
S											●	●	●	●
H											●	●	●	●
O											●	●	●	●

→ v_c Page 339

UltraMini – Inserts for internal turning and profiling

▲ with chip former

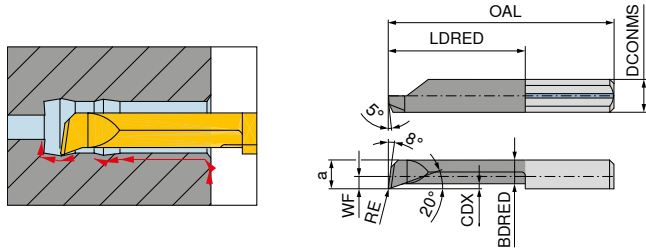

Illustrations show right-hand versions

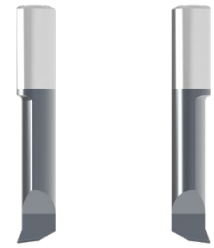

Left-hand Right-hand

Designation	DCONMS _{h6} mm	WF mm	DMIN mm	a mm	OAL mm	LDRED mm	CDX mm	BDRED mm	RE mm	Standard tool holder	TiAlN	
											73 017 ...	73 016 ...
R/L 050.4-10C	4	1.5	4	3.5	24	10	0.3	3.0	0.2	645.00...-D	410	410
R/L 050.4-16C	4	1.5	4	3.5	30	16	0.3	3.0	0.2	645.00...-D	416	416
R/L 050.4-20C	4	1.5	4	3.5	34	20	0.3	3.0	0.2	645.00...-D	420	420
R/L 050.4-24C	4	1.5	4	3.5	38	24	0.3	3.0	0.2	645.00...-D	424	424
R/L 050.4-28C	4	1.5	4	3.5	42	28	0.3	3.0	0.2	645.00...-D	428	428
R/L 050.5-10C	5	1.9	5	4.4	25	10	0.5	3.8	0.2	645.00...-D	510	510
R/L 050.5-15C	5	1.9	5	4.4	30	15	0.5	3.8	0.2	645.00...-D	515	515
R/L 050.5-20C	5	1.9	5	4.4	35	20	0.5	3.8	0.2	645.00...-D	520	520
R/L 050.5-25C	5	1.9	5	4.4	40	25	0.5	3.8	0.2	645.00...-D	525	525
R/L 050.5-30C	5	1.9	5	4.4	45	30	0.5	3.8	0.2	645.00...-D	530	530
R/L 050.5-35C	5	1.9	5	4.4	50	35	0.5	3.8	0.2	645.00...-D	535	535
R/L 050.6-15C	6	2.3	6	5.3	30	15	0.5	4.5	0.2	676.00...-D	615	615
R/L 050.6-22C	6	2.3	6	5.3	37	22	0.5	4.5	0.2	676.00...-D	622	622
R/L 050.6-25C	6	2.3	6	5.3	40	25	0.5	4.5	0.2	676.00...-D	625	625
R/L 050.6-30C	6	2.3	6	5.3	45	30	0.5	4.5	0.2	676.00...-D	630	630
R/L 050.6-35C	6	2.3	6	5.3	50	35	0.5	4.5	0.2	676.00...-D	635	635
R/L 050.6-42C	6	2.3	6	5.3	57	42	0.5	4.5	0.2	676.00...-D	642	642
R/L 050.7-20C	7	2.8	7	6.3	35	20	0.6	5.5	0.2	676.00...-D	720	720
R/L 050.7-25C	7	2.8	7	6.3	40	25	0.6	5.5	0.2	676.00...-D	725	725
R/L 050.7-30C	7	2.8	7	6.3	45	30	0.6	5.5	0.2	676.00...-D	730	730
R/L 050.7-35C	7	2.8	7	6.3	50	35	0.6	5.5	0.2	676.00...-D	735	735
R/L 050.7-40C	7	2.8	7	6.3	55	40	0.6	5.5	0.2	676.00...-D	740	740
R/L 050.7-45C	7	2.8	7	6.3	60	45	0.6	5.5	0.2	676.00...-D	745	745
R/L 050.7-50C	7	2.8	7	6.3	65	50	0.6	5.5	0.2	676.00...-D	750	750
P											●	●
M											●	●
K											●	●
N											●	●
S											●	●
H											●	●
O											●	●

→ v_c Page 339

UltraMini – Inserts for internal turning and profiling

- ▲ Specially designed for super alloys
- ▲ CDX = Maximum depth of cut when turning outwards

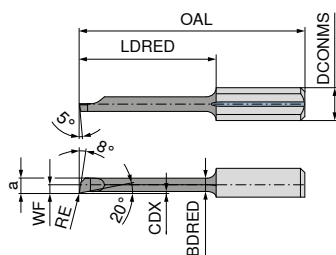
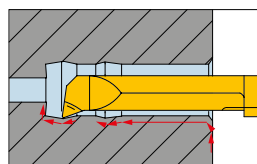

Illustrations show right-hand versions



Left-hand **73 027 ...** Right-hand **73 026 ...**

Designation	DCONMS _{HS} mm	WF mm	DMIN mm	a mm	OAL mm	LDRED mm	CDX mm	BDRED mm	RE mm	Standard tool holder	Left-hand 73 027 ...	Right-hand 73 026 ...
R/L M050.05-2	4	0.20	0.5	0.40	20	2	0.02	0.02	0.02	645.00..-D	052	052
R/L M050.08-4	4	0.35	0.8	0.70	20	4	0.08	0.03	0.02	645.00..-D	082	082
R/L M050.1-5	4	0.40	1.0	0.90	20	5	0.05	0.05	0.02	645.00..-D	102	102
R/L M050.1-7	4	0.40	1.0	0.90	22	7	0.05	0.05	0.02	645.00..-D	103	103
R/L M050.15-5	4	0.60	1.5	1.15	19	5	0.08	0.08	0.02	645.00..-D	151	151
R/L M050.15-10	4	0.60	1.5	1.15	24	10	0.08	0.08	0.02	645.00..-D	154	154
R/L M050.2-5	4	0.80	2.0	1.70	19	5	0.08	0.08	0.02	645.00..-D	201	201
R/L M050.2-10	4	0.80	2.0	1.70	24	10	0.08	0.08	0.02	645.00..-D	204	204
R/L M050.25-5	4	0.20	2.5	2.20	19	5	0.10	0.10	0.02	645.00..-D	251	251
R/L M050.25-10	4	0.20	2.5	2.20	24	10	0.10	0.10	0.02	645.00..-D	254	254
R/L M050.3-10	4	0.60	3.0	2.60	24	10	0.15	0.15	0.02	645.00..-D	304	304
R/L M050.3-16	4	0.60	3.0	2.60	30	16	0.15	0.15	0.02	645.00..-D	307	307
R/L M050.35-10	4	1.10	3.5	3.10	24	10	0.17	0.17	0.02	645.00..-D	350	350
R/L M050.35-16	4	1.10	3.5	3.10	30	16	0.17	0.17	0.02	645.00..-D	353	353
R/L M050.35-20	4	1.10	3.5	3.10	34	20	0.17	0.17	0.02	645.00..-D	354	354
R/L M050.4-10	4	1.50	4.0	3.50	24	10	0.20	0.20	0.02	645.00..-D	400	400
R/L M050.4-16	4	1.50	4.0	3.50	30	16	0.20	0.20	0.02	645.00..-D	403	403
R/L M050.4-20	4	1.50	4.0	3.50	34	20	0.20	0.20	0.02	645.00..-D	404	404
R/L M050.4-24	4	1.50	4.0	3.50	38	24	0.20	0.20	0.02	645.00..-D	406	406
P											●	●
M											●	●
K											○	○
N											○	○
S											●	●
H											○	○
O											○	○

→ v_c Page 339

UltraMini – Inserts for internal turning

- ▲ with chip former
- ▲ High-feed internal turning

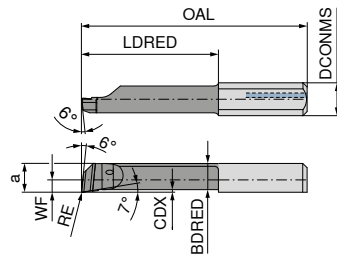
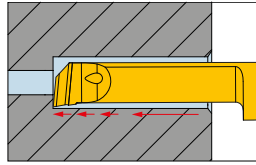

Illustrations show right-hand versions



Designation	DCONMS _{h6} mm	WF mm	DMIN mm	a mm	OAL mm	LDRED mm	CDX mm	BDRED mm	RE mm	Standard tool holder	Left-hand 73 001 ...	Right-hand 73 000 ...
R/L X050.1-5	4		1.0	0.90	20	5	0.03	0.85	0.05	645.00..-D	121	121
R/L X050.15-7	4		1.5	1.35	22	7	0.05	1.25	0.10	645.00..-D	233	233
R/L X050.2-5	4		2.0	1.80	19	5	0.10	1.60	0.15	645.00..-D	245	245
R/L X050.2-10	4		2.0	1.80	24	10	0.10	1.60	0.05	645.00..-D	215	215
R/L X050.2-10	4		2.0	1.80	24	10	0.10	1.60	0.15	645.00..-D	241	241
R/L X050.3-10	4	0.7	3.0	2.70	24	10	0.15	2.55	0.05	645.00..-D	341	341
R/L X050.3-10	4	0.7	3.0	2.70	24	10	0.15	2.55	0.20	645.00..-D	347	347
R/L X050.3-16	4	0.7	3.0	2.70	30	16	0.15	2.55	0.05	645.00..-D	371	371
R/L X050.3-16	4	0.7	3.0	2.70	30	16	0.15	2.55	0.10	645.00..-D	373	373
R/L X050.3-16	4	0.7	3.0	2.70	30	16	0.15	2.55	0.20	645.00..-D	377	377
R/L X050.4-10	4	1.6	4.0	3.60	24	10	0.20	3.20	0.10	645.00..-D	403	403
R/L X050.4-10	4	1.6	4.0	3.60	24	10	0.20	3.20	0.20	645.00..-D	407	407
R/L X050.4-16	4	1.6	4.0	3.60	30	16	0.20	3.20	0.05	645.00..-D	431	431
R/L X050.4-16	4	1.6	4.0	3.60	30	16	0.20	3.20	0.10	645.00..-D	433	433
R/L X050.4-16	4	1.6	4.0	3.60	30	16	0.20	3.20	0.20	645.00..-D	437	437
R/L X050.4-24	4	1.6	4.0	3.60	38	24	0.20	3.20	0.10	645.00..-D	463	463
R/L X050.4-24	4	1.6	4.0	3.60	38	24	0.20	3.20	0.20	645.00..-D	467	467
R/L X050.5-15	5	2.1	5.0	4.60	30	15	0.30	4.05	0.05	645.00..-D	511	511
R/L X050.5-15	5	2.1	5.0	4.60	30	15	0.30	4.05	0.10	645.00..-D	513	513
R/L X050.5-15	5	2.1	5.0	4.60	30	15	0.30	4.05	0.20	645.00..-D	517	517
R/L X050.5-25	5	2.1	5.0	4.60	40	25	0.30	4.05	0.10	645.00..-D	543	543
R/L X050.5-25	5	2.1	5.0	4.60	40	25	0.30	4.05	0.20	645.00..-D	547	547
R/L X050.5-30	5	2.1	5.0	4.60	45	30	0.30	4.05	0.10	645.00..-D	553	553
R/L X050.5-30	5	2.1	5.0	4.60	45	30	0.30	4.05	0.20	645.00..-D	557	557
R/L X050.6-15	6	2.5	6.0	5.50	30	15	0.40	4.90	0.05	676.00..-D	611	611
R/L X050.6-15	6	2.5	6.0	5.50	30	15	0.40	4.90	0.10	676.00..-D	613	613
R/L X050.6-15	6	2.5	6.0	5.50	30	15	0.40	4.90	0.20	676.00..-D	617	617
R/L X050.6-22	6	2.5	6.0	5.50	37	22	0.40	4.90	0.20	676.00..-D	637	637
R/L X050.6-30	6	2.5	6.0	5.50	45	30	0.40	4.90	0.20	676.00..-D	657	657
R/L X050.6-35	6	2.5	6.0	5.50	50	35	0.40	4.90	0.20	676.00..-D	667	667
R/L X050.6-50	6	2.5	6.0	5.50	65	50	0.40	4.90	0.20	676.00..-D	697	697
R/L X050.7-25	7	3.0	7.0	6.50	40	25	0.50	5.90	0.20	676.00..-D	747	747
R/L X050.7-30	7	3.0	7.0	6.50	45	30	0.50	5.90	0.20	676.00..-D	757	757

P	●	●
M	●	●
K	●	●
N	○	○
S	○	○
H	○	○
O	○	○

→ v_c Page 340+341

UltraMini – Inserts for internal turning

▲ CDX = Maximum depth of cut when turning outwards

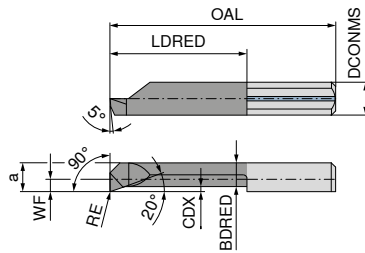
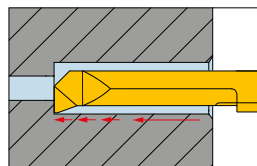

Illustrations show right-hand versions

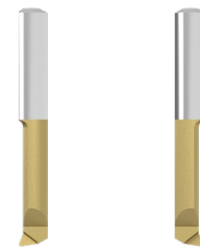

Designation	DCONMS _{h6} mm	WF mm	DMIN mm	a mm	OAL mm	LDRED mm	CDX mm	BDRED mm	RE mm	Standard tool holder	Left-hand		Right-hand	
											73 015 ...		73 014 ...	
R/L 090.3-10	4	0.6	2.8	2.6	24	10	0.2	2.3	0.2	645.00..-D	541		541	
R/L 090.3-16	4	0.6	2.8	2.6	30	16	0.2	2.3	0.2	645.00..-D	542		542	
R/L 090.4-10	4	1.5	4.0	3.5	24	10	0.3	3.0	0.2	645.00..-D	545		545	
R/L 090.4-16	4	1.5	4.0	3.5	30	16	0.3	3.0	0.2	645.00..-D	546		546	
R/L 090.5-10	5	1.9	5.0	4.4	25	10	0.5	3.8	0.2	645.00..-D	550		550	
R/L 090.5-15	5	1.9	5.0	4.4	30	15	0.5	3.8	0.2	645.00..-D	551		551	
R/L 090.5-20	5	1.9	5.0	4.4	35	20	0.5	3.8	0.2	645.00..-D	552		552	

P		●		●
M		●		●
K		●		●
N		●		●
S		○		○
H		○		○
O		●		●

→ v_c Page 339

UltraMini – Inserts for back boring

▲ CDX = Maximum depth of cut when turning outwards

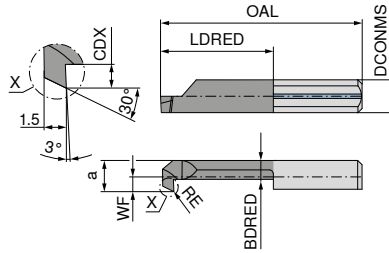
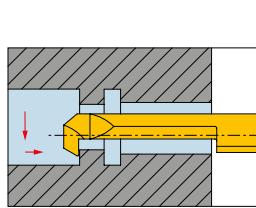

Illustrations show right-hand versions

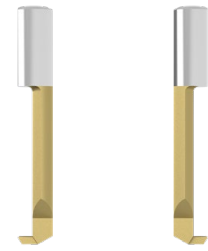

Left-hand Right-hand

Designation	DCONMS _{ns} mm	WF mm	DMIN mm	a mm	OAL mm	LDRED mm	CDX mm	BDRED mm	RE mm	Standard tool holder	TiN	
											73 013 ...	73 012 ...
R/L 080.0003-15	4	0.6	3	2.6	29	15	0.5	2.0	0.10	645.00..-D	542	542
R/L 080.0003-20	4	0.6	3	2.6	34	20	0.5	2.0	0.10	645.00..-D	544	544
R/L 080.0004-15	4	1.5	4	3.5	29	15	0.8	2.4	0.15	645.00..-D	546	546
R/L 080.0004-25	4	1.5	4	3.5	39	25	0.8	2.4	0.15	645.00..-D	548	548
R/L 080.0005-20	5	1.9	5	4.4	35	20	1.0	3.3	0.20	645.00..-D	554	554
R/L 080.0005-30	5	1.9	5	4.4	45	30	1.0	3.3	0.20	645.00..-D	558	558
R/L 080.0006-20	6	2.3	6	5.3	35	20	1.8	3.4	0.20	676.00..-D	564	564
R/L 080.0006-30	6	2.3	6	5.3	45	30	1.8	3.4	0.20	676.00..-D	568	568
R/L 080.0007-20	7	2.7	7	6.3	35	20	2.5	3.8	0.20	676.00..-D	574	574
R/L 080.0007-30	7	2.7	7	6.3	45	30	2.5	3.8	0.20	676.00..-D	578	578
P											●	●
M											●	●
K											●	●
N											●	●
S											○	○
H											○	○
O											●	●

→ v_c Page 339

UltraMini – Inserts for internal turning and chamfering

▲ CDX = Maximum depth of cut when turning outwards

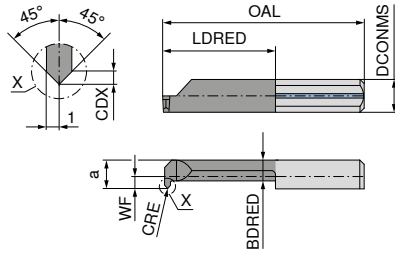
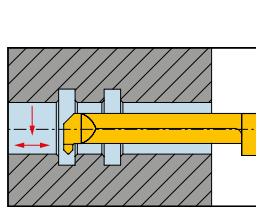

Illustrations show right-hand versions

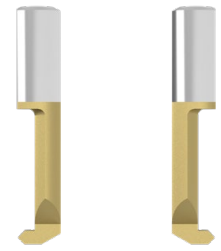

Left-hand Right-hand

Designation	DCONMS _{h6} mm	WF mm	DMIN mm	a mm	OAL mm	LDRED mm	CDX mm	BDRED mm	CRE mm	Standard tool holder	73 007 ...		73 006 ...	
											551	551	550	550
R/L 060.5-15	5	1.9	5.0	4.4	30	15	0.7	3.3	0.2	645.00...D	551	551	550	550
R/L 060.5-20	5	1.9	5.0	4.4	35	20	0.7	3.3	0.2	645.00...D	551	551	550	550
R/L 060.7-20	7	2.7	6.8	6.3	35	20	0.7	3.8	0.2	676.00...D	570	570	570	570
P											●	●	●	●
M											●	●	●	●
K											●	●	●	●
N											●	●	●	●
S											○	○	○	○
H											○	○	○	○
O											●	●	●	●

→ v_c Page 339

UltraMini – Inserts for internal chamfering for subsequent parting off

▲ CDX = Maximum depth of cut when turning outwards

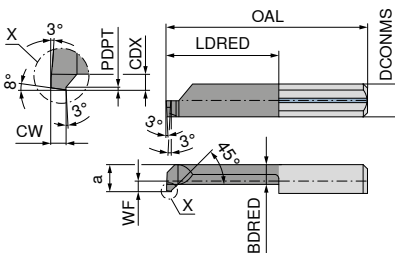
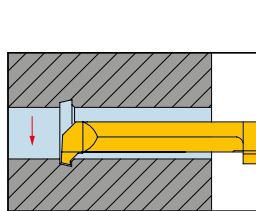

Illustrations show right-hand versions

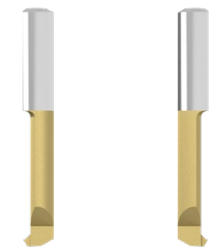

Left-hand Right-hand

Designation	DCONMS _{h6} mm	WF mm	DMIN mm	a mm	OAL mm	LDRED mm	CDX mm	BDRED mm	CW mm	PDPT mm	Standard tool holder	73 009 ...		73 008 ...	
												410	410	416	416
R/L 070.4-10	4	1.5	4	3.5	25	10	0.8	2.4	1	0.2	645.00...D	410	410	416	416
R/L 070.4-16	4	1.5	4	3.5	30	16	0.8	2.4	1	0.2	645.00...D	410	410	416	416
R/L 070.5-15	5	1.9	5	4.4	30	15	1.0	3.3	1	0.2	645.00...D	551	551	551	551
R/L 070.5-20	5	1.9	5	4.4	35	20	1.0	3.3	1	0.2	645.00...D	551	551	550	550
R/L 070.5-30	5	1.9	5	4.4	45	30	1.0	3.3	1	0.2	645.00...D	551	551	530	530
R/L 070.6-30	6	2.3	6	5.3	45	30	1.0	4.2	1	0.2	676.00...D	630	630	630	630
R/L 070.6-42	6	2.3	6	5.3	57	42	1.0	4.2	1	0.2	676.00...D	630	630	642	642
P												●	●	●	●
M												●	●	●	●
K												●	●	●	●
N												●	●	●	●
S												○	○	○	○
H												○	○	○	○
O												●	●	●	●

→ v_c Page 339

UltraMini – Inserts for Internal Grooving

▲ CDX = Maximum depth of cut when turning outwards

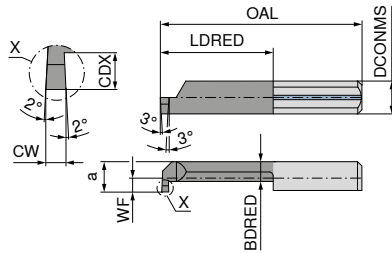
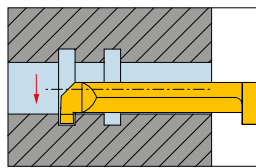

Illustrations show right-hand versions



Designation	DCONMS _{h6} mm	WF mm	DMIN mm	a mm	OAL mm	LDRED mm	CDX mm	BDRED mm	CW mm	Standard tool holder	Left-hand		Right-hand	
											73 003 ...	73 002 ...	73 003 ...	73 002 ...
R/L 004.0100-10	4	1.5	4.0	3.5	24	10	0.8	2.4	1.0	645.00..-D	040	040	540	540
R/L 004.0100-16	4	1.5	4.0	3.5	30	16	0.8	2.4	1.0	645.00..-D	041	041	541	541
R/L 004.0100-20	4	1.5	4.0	3.5	34	20	0.8	2.4	1.0	645.00..-D	042	042	542	542
R/L 005.0100-10	5	1.9	5.0	4.4	25	10	1.0	3.3	1.0	645.00..-D	150	150	650	650
R/L 005.0150-10	5	1.9	5.0	4.4	25	10	1.0	3.3	1.5	645.00..-D	154	154	654	654
R/L 005.0200-10	5	1.9	5.0	4.4	25	10	1.0	3.3	2.0	645.00..-D	158	158	658	658
R/L 005.0100-15	5	1.9	5.0	4.4	30	15	1.0	3.3	1.0	645.00..-D	151	151	651	651
R/L 005.0150-15	5	1.9	5.0	4.4	30	15	1.0	3.3	1.5	645.00..-D	155	155	655	655
R/L 005.0200-15	5	1.9	5.0	4.4	30	15	1.0	3.3	2.0	645.00..-D	159	159	659	659
R/L 005.0100-20	5	1.9	5.0	4.4	35	20	1.0	3.3	1.0	645.00..-D	051	051	551	551
R/L 005.0150-20	5	1.9	5.0	4.4	35	20	1.0	3.3	1.5	645.00..-D	052	052	552	552
R/L 005.0200-20	5	1.9	5.0	4.4	35	20	1.0	3.3	2.0	645.00..-D	053	053	553	553
R/L 005.0100-25	5	1.9	5.0	4.4	40	25	1.0	3.3	1.0	645.00..-D	152	152	652	652
R/L 005.0150-25	5	1.9	5.0	4.4	40	25	1.0	3.3	1.5	645.00..-D	156	156	656	656
R/L 005.0200-25	5	1.9	5.0	4.4	40	25	1.0	3.3	2.0	645.00..-D	250	250	750	750
R/L 005.0100-30	5	1.9	5.0	4.4	45	30	1.0	3.3	1.0	645.00..-D	153	153	653	653
R/L 005.0150-30	5	1.9	5.0	4.4	45	30	1.0	3.3	1.5	645.00..-D	157	157	657	657
R/L 005.0200-30	5	1.9	5.0	4.4	45	30	1.0	3.3	2.0	645.00..-D	251	251	751	751
R/L 005.0100-35	5	1.9	5.0	4.4	50	35	1.0	3.3	1.0	645.00..-D			680	680
R/L 006.0100-10	6	2.3	6.0	5.3	25	10	1.8	3.4	1.0	676.00..-D	160	160	660	660
R/L 006.0150-10	6	2.3	6.0	5.3	25	10	1.8	3.4	1.5	676.00..-D	164	164	664	664
R/L 006.0200-10	6	2.3	6.0	5.3	25	10	1.8	3.4	2.0	676.00..-D	168	168	668	668
R/L 006.0100-15	6	2.3	6.0	5.3	30	15	1.8	3.4	1.0	676.00..-D	161	161	661	661
R/L 006.0150-15	6	2.3	6.0	5.3	30	15	1.8	3.4	1.5	676.00..-D	165	165	665	665
R/L 006.0200-15	6	2.3	6.0	5.3	30	15	1.8	3.4	2.0	676.00..-D	169	169	669	669
R/L 006.0100-22	6	2.3	6.0	5.3	37	22	1.8	3.4	1.0	676.00..-D	061	061	561	561
R/L 006.0150-22	6	2.3	6.0	5.3	37	22	1.8	3.4	1.5	676.00..-D	062	062	562	562
R/L 006.0200-22	6	2.3	6.0	5.3	37	22	1.8	3.4	2.0	676.00..-D	063	063	563	563
R/L 006.0100-25	6	2.3	6.0	5.3	40	25	1.8	3.4	1.0	676.00..-D	162	162	662	662
R/L 006.0150-25	6	2.3	6.0	5.3	40	25	1.8	3.4	1.5	676.00..-D	166	166	666	666
R/L 006.0200-25	6	2.3	6.0	5.3	40	25	1.8	3.4	2.0	676.00..-D	260	260	760	760
R/L 006.0100-30	6	2.3	6.0	5.3	45	30	1.8	3.4	1.0	676.00..-D	163	163	663	663
R/L 006.0150-30	6	2.3	6.0	5.3	45	30	1.8	3.4	1.5	676.00..-D	167	167	667	667
R/L 006.0200-30	6	2.3	6.0	5.3	45	30	1.8	3.4	2.0	676.00..-D	261	261	761	761
R/L 006.0100-35	6	2.3	6.0	5.3	50	35	1.8	3.4	1.0	676.00..-D			682	682
R/L 006.0150-35	6	2.3	6.0	5.3	50	35	1.8	3.4	1.5	676.00..-D			684	684
R/L 006.0100-42	6	2.3	6.0	5.3	57	42	1.8	3.4	1.0	676.00..-D			685	685
R/L 007.0100-10	7	2.7	6.8	6.3	25	10	2.5	3.8	1.0	676.00..-D	070	070	570	570
R/L 007.0150-10	7	2.7	6.8	6.3	25	10	2.5	3.8	1.5	676.00..-D	075	075	575	575
R/L 007.0200-10	7	2.7	6.8	6.3	25	10	2.5	3.8	2.0	676.00..-D	170	170	670	670
R/L 007.0100-15	7	2.7	6.8	6.3	30	15	2.5	3.8	1.0	676.00..-D	071	071	571	571
R/L 007.0150-15	7	2.7	6.8	6.3	30	15	2.5	3.8	1.5	676.00..-D	076	076	576	576
R/L 007.0200-15	7	2.7	6.8	6.3	30	15	2.5	3.8	2.0	676.00..-D	171	171	671	671
R/L 007.0100-22	7	2.7	6.8	6.3	37	22	2.5	3.8	1.0	676.00..-D	072	072	572	572
R/L 007.0150-22	7	2.7	6.8	6.3	37	22	2.5	3.8	1.5	676.00..-D	077	077	577	577
R/L 007.0200-22	7	2.7	6.8	6.3	37	22	2.5	3.8	2.0	676.00..-D	172	172	672	672
R/L 007.0100-25	7	2.7	6.8	6.3	40	25	2.5	3.8	1.0	676.00..-D	073	073	573	573
R/L 007.0150-25	7	2.7	6.8	6.3	40	25	2.5	3.8	1.5	676.00..-D	078	078	578	578
R/L 007.0200-25	7	2.7	6.8	6.3	40	25	2.5	3.8	2.0	676.00..-D	173	173	673	673
R/L 007.0100-30	7	2.7	6.8	6.3	45	30	2.5	3.8	1.0	676.00..-D	074	074	574	574
R/L 007.0150-30	7	2.7	6.8	6.3	45	30	2.5	3.8	1.5	676.00..-D	079	079	579	579
R/L 007.0200-30	7	2.7	6.8	6.3	45	30	2.5	3.8	2.0	676.00..-D	174	174	674	674
R/L 007.0100-35	7	2.7	7.0	6.3	50	35	2.5	3.8	1.0	676.00..-D			688	688
R/L 007.0150-35	7	2.7	7.0	6.3	50	35	2.5	3.8	1.5	676.00..-D			690	690
R/L 007.0200-35	7	2.7	7.0	6.3	50	35	2.5	3.8	2.0	676.00..-D			692	692
R/L 007.0100-40	7	2.7	7.0	6.3	55	40	2.5	3.8	1.0	676.00..-D			700	700
R/L 007.0150-40	7	2.7	7.0	6.3	55	40	2.5	3.8	1.5	676.00..-D			702	702
R/L 007.0100-45	7	2.7	7.0	6.3	60	45	2.5	3.8	1.0	676.00..-D			712	712
R/L 007.0100-50	7	2.7	7.0	6.3	65	50	2.5	3.8	1.0	676.00..-D			714	714

P												●	●
M												●	●
K												●	●
N											○	○	○
S												○	○
H												○	○
O												●	●

3

UltraMini – Inserts for Internal Grooving

▲ CDX = Maximum depth of cut when turning outwards

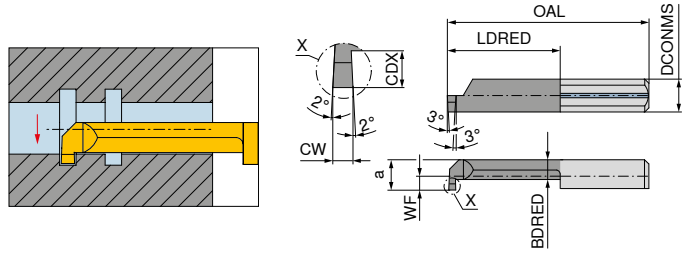

Illustrations show right-hand versions

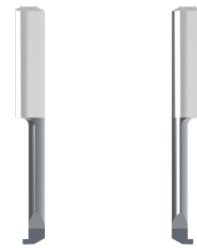

Left-hand Right-hand

Designation	DCONMS _{h6} mm	WF mm	DMIN mm	a mm	OAL mm	LDRED mm	CDX mm	BDRED mm	CW mm	Standard tool holder	73 003 ...		73 002 ...	
											Left-hand	Right-hand	Left-hand	Right-hand
R/L 002.0050-5	4		2	1.8	19	5	0.4	1.2	0.5	645.00..-D	820		820	
R/L 002.0050-10	4		2	1.8	24	10	0.4	1.2	0.5	645.00..-D	821		821	
R/L 002.0050-15	4		2	1.8	29	15	0.4	1.2	0.5	645.00..-D	822		822	
R/L 003.0070-5	4	0.7	3	2.7	19	5	0.6	1.9	0.7	645.00..-D	830		830	
R/L 003.0070-10	4	0.7	3	2.7	24	10	0.6	1.9	0.7	645.00..-D	831		831	
R/L 003.0070-16	4	0.7	3	2.7	30	16	0.6	1.9	0.7	645.00..-D	832		832	
P											●		●	
M											●		●	
K											●		●	
N											●		●	
S											●		●	
H											●		●	
O											●		●	

→ v_c Page 339

UltraMini – Inserts for Internal Grooving

▲ CDX = Maximum depth of cut when turning outwards

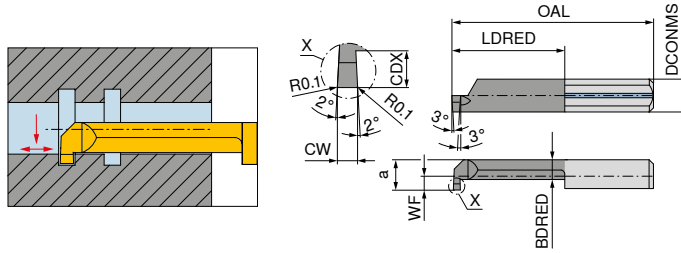

Illustrations show right-hand versions

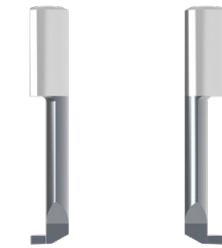

Left-hand Right-hand

Designation	DCONMS _{ns} mm	WF mm	DMIN mm	a mm	OAL mm	LDRED mm	CDX mm	BDRED mm	CW mm	Standard tool holder	73 203 ...		73 202 ...	
R/L 004M0100-10	4	1.5	4.0	3.5	24	10	0.8	2.4	1.0	645.00..-D	800		800	
R/L 004M0100-16	4	1.5	4.0	3.5	30	16	0.8	2.4	1.0	645.00..-D	802		802	
R/L 004M0100-20	4	1.5	4.0	3.5	34	20	0.8	2.4	1.0	645.00..-D	804		804	
R/L 005M0100-10	5	1.9	5.0	4.4	25	10	1.0	3.3	1.0	645.00..-D	806		806	
R/L 005M0150-10	5	1.9	5.0	4.4	25	10	1.0	3.3	1.5	645.00..-D	816		816	
R/L 005M0200-10	5	1.9	5.0	4.4	25	10	1.0	3.3	2.0	645.00..-D	826		826	
R/L 005M0100-15	5	1.9	5.0	4.4	30	15	1.0	3.3	1.0	645.00..-D	808		808	
R/L 005M0150-15	5	1.9	5.0	4.4	30	15	1.0	3.3	1.5	645.00..-D	818		818	
R/L 005M0200-15	5	1.9	5.0	4.4	30	15	1.0	3.3	2.0	645.00..-D	828		828	
R/L 005M0100-20	5	1.9	5.0	4.4	35	20	1.0	3.3	1.0	645.00..-D	810		810	
R/L 005M0150-20	5	1.9	5.0	4.4	35	20	1.0	3.3	1.5	645.00..-D	820		820	
R/L 005M0200-20	5	1.9	5.0	4.4	35	20	1.0	3.3	2.0	645.00..-D	830		830	
R/L 005M0100-25	5	1.9	5.0	4.4	40	25	1.0	3.3	1.0	645.00..-D	812		812	
R/L 005M0150-25	5	1.9	5.0	4.4	40	25	1.0	3.3	1.5	645.00..-D	822		822	
R/L 005M0200-25	5	1.9	5.0	4.4	40	25	1.0	3.3	2.0	645.00..-D	832		832	
R/L 005M0100-30	5	1.9	5.0	4.4	45	30	1.0	3.3	1.0	645.00..-D	814		814	
R/L 005M0150-30	5	1.9	5.0	4.4	45	30	1.0	3.3	1.5	645.00..-D	824		824	
R/L 005M0200-30	5	1.9	5.0	4.4	45	30	1.0	3.3	2.0	645.00..-D	834		834	
R/L 006M0100-10	6	2.3	6.0	5.3	25	10	1.8	3.4	1.0	676.00..-D	836		836	
R/L 006M0150-10	6	2.3	6.0	5.3	25	10	1.8	3.4	1.5	676.00..-D	846		846	
R/L 006M0200-10	6	2.3	6.0	5.3	25	10	1.8	3.4	2.0	676.00..-D	856		856	
R/L 006M0100-15	6	2.3	6.0	5.3	30	15	1.8	3.4	1.0	676.00..-D	838		838	
R/L 006M0150-15	6	2.3	6.0	5.3	30	15	1.8	3.4	1.5	676.00..-D	848		848	
R/L 006M0200-15	6	2.3	6.0	5.3	30	15	1.8	3.4	2.0	676.00..-D	858		858	
R/L 006M0100-20	6	2.3	6.0	5.3	35	22	1.8	3.4	1.0	676.00..-D	840		840	
R/L 006M0150-20	6	2.3	6.0	5.3	37	22	1.8	3.4	1.5	676.00..-D	850		850	
R/L 006M0200-20	6	2.3	6.0	5.3	37	22	1.8	3.4	2.0	676.00..-D	860		860	
R/L 006M0100-25	6	2.3	6.0	5.3	40	25	1.8	3.4	1.0	676.00..-D	842		842	
R/L 006M0150-25	6	2.3	6.0	5.3	40	25	1.8	3.4	1.5	676.00..-D	852		852	
R/L 006M0200-25	6	2.3	6.0	5.3	40	25	1.8	3.4	2.0	676.00..-D	862		862	
R/L 006M0100-30	6	2.3	6.0	5.3	45	30	1.8	3.4	1.0	676.00..-D	844		844	
R/L 006M0150-30	6	2.3	6.0	5.3	45	30	1.8	3.4	1.5	676.00..-D	854		854	
R/L 006M0200-30	6	2.3	6.0	5.3	45	30	1.8	3.4	2.0	676.00..-D	864		864	
R/L 007M0100-10	7	2.7	6.8	6.3	25	10	2.5	3.7	1.0	676.00..-D	866		866	
R/L 007M0150-10	7	2.7	6.8	6.3	25	10	2.5	3.7	1.5	676.00..-D	876		876	
R/L 007M0200-10	7	2.7	6.8	6.3	25	10	2.5	3.7	2.0	676.00..-D	886		886	
R/L 007M0100-15	7	2.7	6.8	6.3	30	15	2.5	3.7	1.0	676.00..-D	868		868	
R/L 007M0150-15	7	2.7	6.8	6.3	30	15	2.5	3.7	1.5	676.00..-D	878		878	
R/L 007M0200-15	7	2.7	6.8	6.3	30	15	2.5	3.7	2.0	676.00..-D	888		888	
R/L 007M0100-22	7	2.7	6.8	6.3	37	22	2.5	3.7	1.0	676.00..-D	870		870	
R/L 007M0150-22	7	2.7	6.8	6.3	37	22	2.5	3.7	1.5	676.00..-D	880		880	
R/L 007M0200-22	7	2.7	6.8	6.3	37	22	2.5	3.7	2.0	676.00..-D	890		890	
R/L 007M0100-25	7	2.7	6.8	6.3	40	25	2.5	3.7	1.0	676.00..-D	872		872	
R/L 007M0150-25	7	2.7	6.8	6.3	40	25	2.5	3.7	1.5	676.00..-D	882		882	
R/L 007M0200-25	7	2.7	6.8	6.3	40	25	2.5	3.7	2.0	676.00..-D	892		892	
R/L 007M0100-30	7	2.7	6.8	6.3	45	30	2.5	3.7	1.0	676.00..-D	874		874	
R/L 007M0150-30	7	2.7	6.8	6.3	45	30	2.5	3.7	1.5	676.00..-D	884		884	
R/L 007M0200-30	7	2.7	6.8	6.3	45	30	2.5	3.7	2.0	676.00..-D	894		894	

P	•	•
M	•	•
K	•	•
N	•	•
S	•	•
H	•	•
O	•	•

UltraMini – Inserts for internal undercuts

▲ CDX = Maximum depth of cut when turning outwards

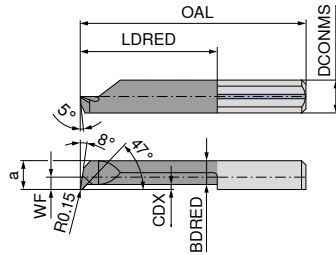
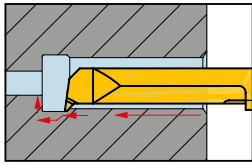

Illustrations show right-hand versions



Designation	DCONMS _{h6}	WF	DMIN	a	OAL	LDRED	CDX	BDRED	Standard tool holder
	mm	mm	mm	mm	mm	mm	mm	mm	
R/L 047.2-10	4		2.0	1.7	24	10	0.4	1.2	645.00..-D
R/L 047.3-15	4	0.6	2.8	2.6	29	15	0.6	1.9	645.00..-D
R/L 047.4-10	4	1.5	4.0	3.5	24	10	0.6	2.8	645.00..-D
R/L 047.T4-20	4	1.5	4.0	3.5	34	20	0.6	2.8	645.00..-D
R/L 047.4-20	4	1.5	4.0	3.5	34	20	0.3	3.0	645.00..-D
R/L 047.5-15	5	1.9	5.0	4.4	30	15	0.8	3.5	645.00..-D
R/L 047.T5-25	5	1.9	5.0	4.4	40	25	0.8	3.5	645.00..-D
R/L 047.5-25	5	1.9	5.0	4.4	40	25	0.5	3.8	645.00..-D
R/L 047.T6-22	6	2.3	6.0	5.3	37	22	1.8	3.4	676.00..-D
R/L 047.T6-30	6	2.3	6.0	5.3	45	30	1.8	3.4	676.00..-D
R/L 047.6-30	6	2.3	6.0	5.3	45	30	0.5	4.5	676.00..-D

Left-hand	Right-hand	Left-hand	Right-hand
73 011 ...	73 010 ...	73 011 ...	73 010 ...
		221	221
		231	231
		241	241
		242	242
542	542		
		251	251
		252	252
552	552		
		262	262
		263	263
562	562		

P	●	●	●	●
M	●	●	●	●
K	●	●	●	●
N	●	●	●	●
S	○	○	●	●
H	○	○	●	●
O	●	●	●	●

→ v_c Page 339

UltraMini – Inserts for internal grooving and turning

▲ CDX = Maximum depth of cut when turning outwards

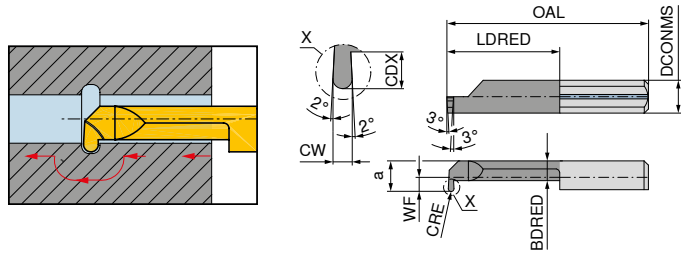

Illustrations show right-hand versions

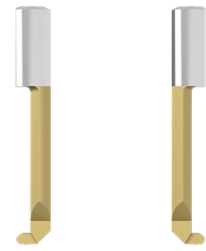

Left-hand Right-hand

Designation	DCONMS _{h6} mm	WF mm	DMIN mm	a mm	OAL mm	LDRED mm	CDX mm	BDRED mm	CW mm	CRE mm	Standard tool holder	TiN	
												Left-hand 73 019 ...	Right-hand 73 018 ...
R/L 006-0.75-25	6	2.3	6.0	5.3	40	25	1.8	3.4	1.5	0.75	676.00..-D	564	564
R/L 004-0.50-16	4	1.5	4.0	3.5	30	16	0.8	2.4	1.0	0.50	645.00..-D	541	541
R/L 005-0.50-20	5	1.9	5.0	4.4	35	20	1.0	3.3	1.0	0.50	645.00..-D	552	552
R/L 005-0.75-20	5	1.9	5.0	4.4	35	20	1.0	3.3	1.5	0.75	645.00..-D	554	554
R/L 005-1.00-20	5	1.9	5.0	4.4	35	20	1.0	3.3	2.0	1.00	645.00..-D	556	556
R/L 006-0.50-25	6	2.3	6.0	5.3	40	25	1.8	3.4	1.0	0.50	676.00..-D	562	562
R/L 006-1.00-25	6	2.3	6.0	5.3	40	25	1.8	3.4	2.0	1.00	676.00..-D	566	566
R/L 007-0.50-30	7	2.7	6.8	6.3	45	30	2.5	3.8	1.0	0.50	676.00..-D	572	572
R/L 007-0.75-30	7	2.7	6.8	6.3	45	30	2.5	3.8	1.5	0.75	676.00..-D	574	574
R/L 007-1.00-30	7	2.7	6.8	6.3	45	30	2.5	3.8	2.0	1.00	676.00..-D	576	576
P												●	●
M												●	●
K												●	●
N												●	●
S												○	○
H												○	○
O												●	●

→ v: Page 339

UltraMini – Inserts for internal threading (Partial profile)

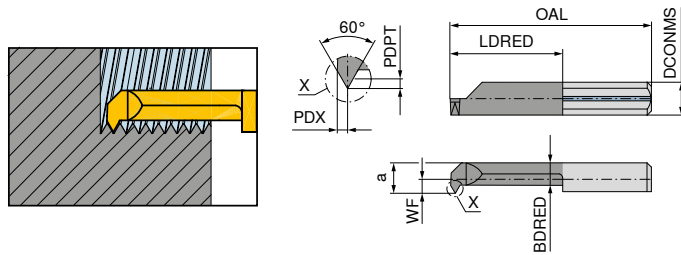

Illustrations show right-hand versions

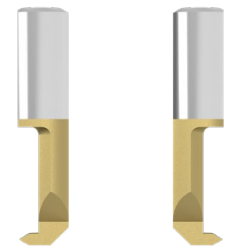

Left-hand Right-hand

Designation	DCONMS _{h6} mm	TP mm	WF mm	DMIN mm	a mm	OAL mm	LDRED mm	BDRED mm	PDPT mm	PDX mm	Standard tool holder	73 101 ...		73 100 ...	
												545	544	547	546
R/L 005.0510-15	5	1 - 1,25	1.9	4.8	4.4	30	15	3.3	0.55	0.55	645.00..-D	545	544	545	544
R/L 005.0510-20	5	1 - 1,25	1.9	4.8	4.4	35	20	3.3	0.55	0.55	645.00..-D	544	544	544	544
R/L 006.0612-15	6	1,25 - 1,5	2.3	6.0	5.3	30	15	3.4	0.68	0.65	676.00..-D	547	546	547	546
R/L 006.0612-22	6	1,25 - 1,5	2.3	6.0	5.3	37	22	3.4	0.68	0.65	676.00..-D	546	546	546	546
R/L 006.0815-15	6	1,5 - 1,75	2.3	6.0	5.3	30	15	3.4	0.81	0.75	676.00..-D	549	548	549	548
R/L 006.0815-22	6	1,5 - 1,75	2.3	6.0	5.3	37	22	3.4	0.81	0.75	676.00..-D	548	548	548	548
R/L 007.0815-15	7	1,5 - 1,75	2.7	7.0	6.3	30	15	3.8	0.81	0.75	676.00..-D	550	550	550	550
P												●	●	●	●
M												●	●	●	●
K												●	●	●	●
N												●	●	●	●
S												○	○	○	○
H												○	○	○	○
O												●	●	●	●

→ v_c Page 339

UltraMini – Inserts for internal threading (Partial profile)

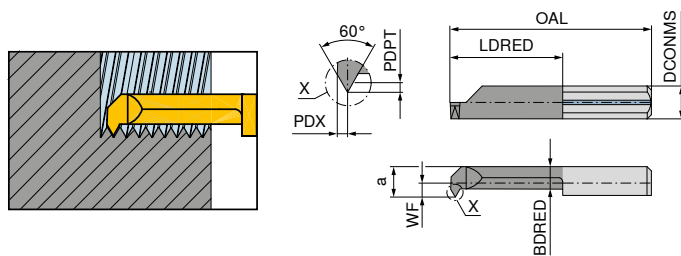

Illustrations show right-hand versions



Left-hand Right-hand

Designation	DCONMS _{h6} mm	TP mm	WF mm	DMIN mm	a mm	OAL mm	LDRED mm	BDRED mm	PDPT mm	PDX mm	Standard tool holder	73 101 ...		73 100 ...	
												551	552	551	552
R/L 003.0105-8	4	0,5 - 0,7	0.30	2.4	2.3	22	8	1.8	0.27	0.33	645.00..-D	551	552	551	552
R/L 004.0408-15	4	0,8 - 1	1.75	4.0	3.5	30	15	2.4	0.43	0.45	645.00..-D	552	552	552	552
P												●	●	●	●
M												●	●	●	●
K												●	●	●	●
N												●	●	●	●
S												○	○	○	○
H												○	○	○	○
O												●	●	●	●

→ v_c Page 339

UltraMini – Inserts for Internal thread turning (Full profile)

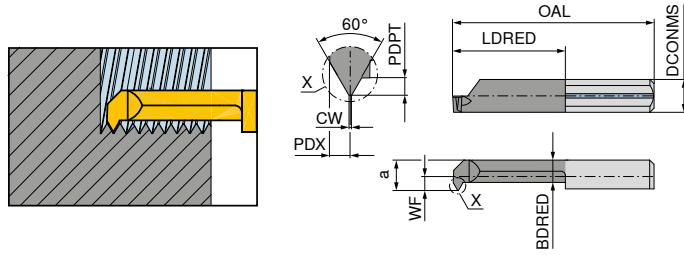

Illustrations show right-hand versions

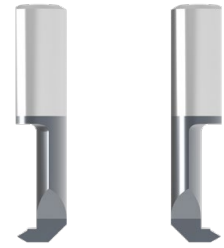

Left-hand Right-hand

Designation	DCONMS _{ns} mm	TP mm	WF mm	DMIN mm	a mm	OAL mm	LDRED mm	BDRED mm	PDPT mm	PDX mm	CW mm	Standard tool holder	73 209 ...		73 208 ...	
													Left-hand	Right-hand	Left-hand	Right-hand
R/L 105.0408-15	5	0.80	1.9	4.8	4.4	30	15	3.3	0.43	0.50	0.10	645.00..-D	799		799	
R/L 105.510-15	5	1.00	1.9	4.8	4.4	30	15	3.3	0.54	0.55	0.12	645.00..-D	800		800	
R/L 106.612-15	6	1.25	2.3	6.0	5.3	30	15	3.4	0.67	0.65	0.15	676.00..-D	802		802	
R/L 106.815-15	6	1.50	2.3	6.0	5.3	30	15	3.4	0.81	0.75	0.18	676.00..-D	804		804	
R/L 106.815-15	7	1.50	2.7	7.0	6.3	30	15	3.8	0.81	0.75	0.18	676.00..-D	806		806	
P													•		•	
M													•		•	
K													•		•	
N													•		•	
S													•		•	
H													•		•	
O													•		•	

→ v. Page 339

UltraMini – Inserts for internal thread turning (Partial profile)

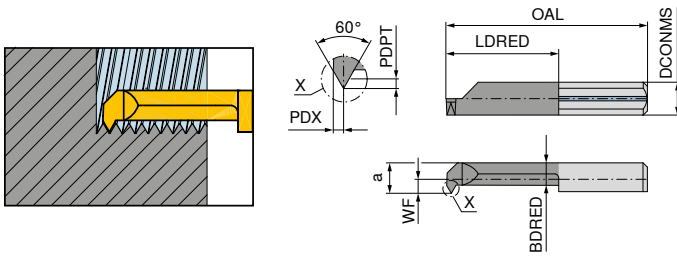

Illustrations show right-hand versions

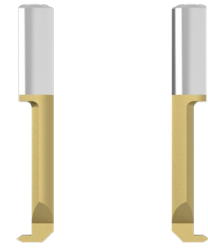

Left-hand Right-hand

Designation	DCONMS ₁₆ mm	TP mm	WF mm	DMIN mm	a mm	OAL mm	LDRED mm	BDRED mm	PDPT mm	PDX mm	Standard tool holder	TiN	
												73 103 ...	73 102 ...
R/L 004.0205-15	4	0,5 - 0,75	1.5	4	3.5	30	15	2.4	0.27	0.35	645.00..-D	510	510
R/L 005.0205-20	5	0,5 - 0,75	1.9	5	4.4	35	20	3.3	0.27	0.35	645.00..-D	540	540
R/L 005.0205-15	5	0,5 - 0,75	1.9	5	4.4	30	15	3.3	0.27	0.35	645.00..-D	539	539
L 005.0407-15	5	0,75 - 1	1.9	5	4.4	30	15	3.3	0.40	0.45	645.00..-D	541	541
R/L 005.0407-20	5	0,75 - 1	1.9	5	4.4	35	20	3.3	0.40	0.45	645.00..-D	542	542
R 005.0407-15	5	0,75 - 1	1.9	5	4.4	30	15	3.3	0.40	0.45	645.00..-D	541	541
R/L 006.0510-22	6	1 - 1,25	2.3	6	5.3	37	22	3.4	0.55	0.55	676.00..-D	544	544
R/L 006.0510-15	6	1 - 1,25	2.3	6	5.3	30	15	3.4	0.55	0.55	676.00..-D	543	543
P												●	●
M												●	●
K												●	●
N												●	●
S												○	○
H												○	○
O												●	●

→ v_c Page 339

UltraMini – Inserts for internal thread turning (Partial profile)

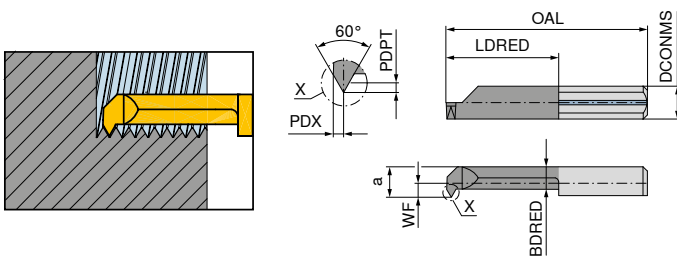

Illustrations show right-hand versions



Left-hand Right-hand

Designation	DCONMS ₁₆ mm	TP mm	WF mm	DMIN mm	a mm	OAL mm	LDRED mm	BDRED mm	PDPT mm	PDX mm	Standard tool holder	TiAlN	
												73 103 ...	73 102 ...
R/L 004.0105-10	4	0,5 - 0,75	1	3.2	3	24	10	2.3	0.27	0.44	645.00..-D	509	509
P												●	●
M												●	●
K												●	●
N												●	●
S												○	○
H												○	○
O												●	●

→ v_c Page 339

UltraMini – Inserts for Internal thread turning (Full profile)

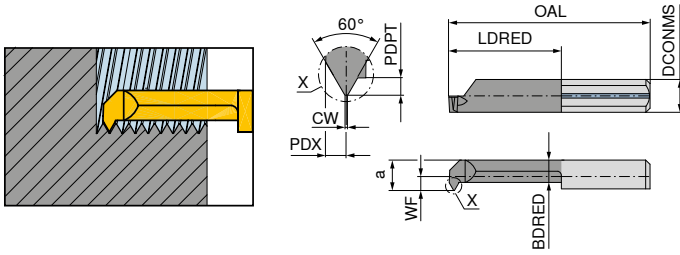

Illustrations show right-hand versions

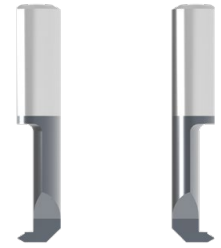

Left-hand Right-hand

Designation	DCONMS _{h6} mm	TP mm	WF mm	DMIN mm	a mm	OAL mm	LDRED mm	BDRD mm	PDPT mm	PDX mm	CW mm	Standard tool holder	73 207 ...		73 206 ...	
													Left-hand	Right-hand	Left-hand	Right-hand
R/L 104.0205-15	5	0.50	1.5	4	3.5	30	15	2.4	0.27	0.35	0.06	645.00..-D	800		800	
R/L 105.0205-15	5	0.50	1.9	5	4.4	30	15	3.3	0.27	0.35	0.06	645.00..-D	802		802	
R/L 105.0407-15	5	0.75	1.9	5	4.4	30	15	3.3	0.40	0.45	0.09	645.00..-D	804		804	
R/L 106.0510-15	6	1.00	2.3	6	5.3	30	15	3.4	0.54	0.55	0.12	676.00..-D	806		806	
P													●		●	
M													●		●	
K													●		●	
N													●		●	
S													●		●	
H													●		●	
O													●		●	

→ v_c Page 339

UltraMini – Inserts for internal thread turning (Partial profile)

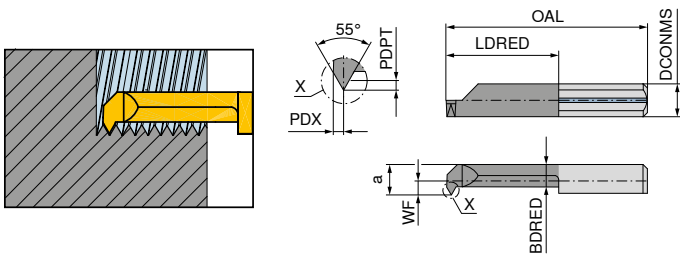

Illustrations show right-hand versions

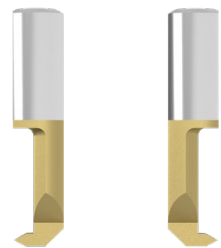

Left-hand Right-hand

Designation	DCONMS _{h6} mm	TPI 1/''	WF mm	DMIN mm	a mm	OAL mm	LDRED mm	BDRD mm	PDPT mm	PDX mm	CW mm	Standard tool holder	73 105 ...		73 104 ...	
													Left-hand	Right-hand	Left-hand	Right-hand
R/L 005.5548-15	5	48 - 24	1.9	4.8	4.4	30	15	3.3	0.40	0.45		645.00..-D	552		552	
R/L 006.5548-15	6	48 - 24	2.3	6.0	5.3	30	15	3.4	0.40	0.45		676.00..-D	562		562	
R/L 006.5524-15	6	24 - 16	2.3	6.0	5.3	30	15	3.4	0.81	0.75		676.00..-D	563		563	
R/L 007.5524-15	7	24 - 16	2.7	7.0	6.3	30	15	3.8	0.81	0.75		676.00..-D	572		572	
P													●		●	
M													●		●	
K													●		●	
N													●		●	
S													○		○	
H													○		○	
O													●		●	

→ v_c Page 339

UltraMini – Inserts for internal thread turning (Partial profile)

▲ Trapezoidal thread DIN 103

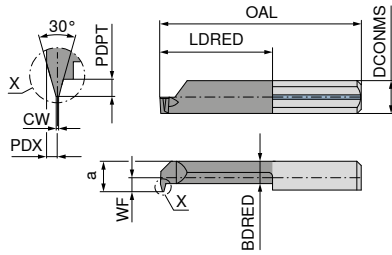
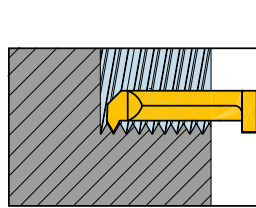

Illustrations show right-hand versions



Left-hand Right-hand

Designation	DCONMS _{h6} mm	TP mm	WF mm	DMIN mm	a mm	OAL mm	LDRED mm	BDRED mm	PDPT mm	PDX mm	CW mm	Standard tool holder	73 211 ...	
													Left-hand	Right-hand
R/L 007.1220-22	7	2	2.8	7	6.3	37	22	3.8	1.25	0.75	0.6	676.00..-D	222	222
R/L 007.1220-30	7	2	2.8	7	6.3	45	30	3.8	1.25	0.75	0.6	676.00..-D	230	230
R/L 007.1730-22	7	3	2.8	7	6.3	37	22	3.8	1.75	1.10	1.0	676.00..-D	322	322
R/L 007.1730-30	7	3	2.8	7	6.3	45	30	3.8	1.75	1.10	1.0	676.00..-D	330	330
P													●	●
M													●	●
K													●	●
N													●	●
S													●	●
H													●	●
O													●	●

→ v_c Page 339

UltraMini – Inserts for axial grooving

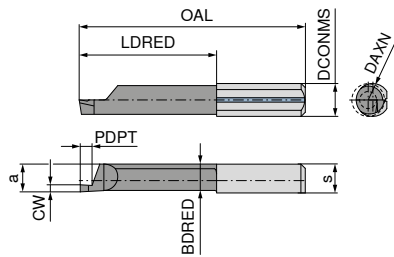
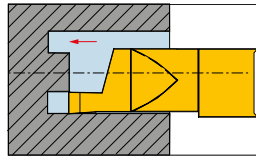

Illustrations show right-hand versions

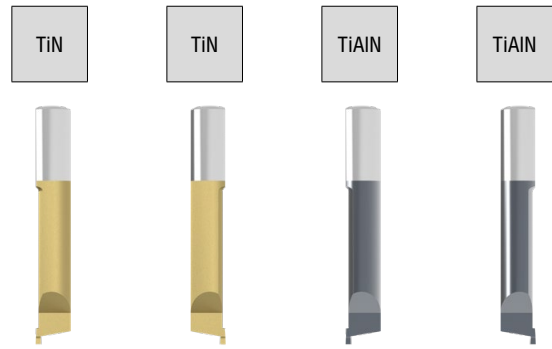

Designation	DCONMS _{ns} mm	a mm	DAXN mm	s mm	OAL mm	LDRED mm	PDPT mm	BDRED mm	CW mm	Standard tool holder	Left-hand	Right-hand	Left-hand	Right-hand
											73 051 ...	73 050 ...	73 053 ...	73 052 ...
R/L 010.1006-10	6	5.2	6	5.3	26	11	1.5	4.9	1.0	676.00..-D	561	561	561	561
R/L 010.1506-10	6	5.2	6	5.3	26	11	2.0	4.9	1.5	676.00..-D	563	563	563	563
R/L 010.1008-10	7	5.9	8	6.3	26	11	1.5	5.6	1.0	676.00..-D	571	571	571	571
R/L 010.1008-20	7	5.9	8	6.3	35	20	1.5	5.6	1.0	676.00..-D	671	671	671	671
R/L 010.1008-30	7	5.9	8	6.3	45	30	1.5	5.6	1.0	676.00..-D	771	771	771	771
R/L 010.1508-10	7	5.9	8	6.3	26	11	2.5	5.6	1.5	676.00..-D	573	573	573	573
R/L 010.1508-20	7	5.9	8	6.3	35	20	2.5	5.6	1.5	676.00..-D	673	673	673	673
R/L 010.1508-30	7	5.9	8	6.3	45	30	2.5	5.6	1.5	676.00..-D	773	773	773	773
R/L 010.2008-10	7	5.9	8	6.3	26	11	3.0	5.6	2.0	676.00..-D	575	575	575	575
R/L 010.2008-20	7	5.9	8	6.3	35	20	3.0	5.6	2.0	676.00..-D	675	675	675	675
R/L 010.2008-30	7	5.9	8	6.3	45	30	3.0	5.6	2.0	676.00..-D	775	775	775	775
R/L 010.2508-10	7	5.9	8	6.3	26	11	3.5	5.6	2.5	676.00..-D	577	577	577	577
R/L 010.2508-20	7	5.9	8	6.3	35	20	3.5	5.6	2.5	676.00..-D	677	677	677	677
R/L 010.2508-30	7	5.9	8	6.3	45	30	3.5	5.6	2.5	676.00..-D	777	777	777	777
R/L 010.3008-10	7	5.9	8	6.3	26	11	3.5	5.6	3.0	676.00..-D	579	579	579	579
R/L 010.3008-20	7	5.9	8	6.3	35	20	3.5	5.6	3.0	676.00..-D	679	679	679	679
R/L 010.3008-30	7	5.9	8	6.3	45	30	3.5	5.6	3.0	676.00..-D	779	779	779	779
P											●	●	●	●
M											●	●	●	●
K											●	●	●	●
N											●	●	●	●
S											○	○	○	○
H											○	○	●	●
O											●	●	●	●

→ v_c Page 339

3

UltraMini – Inserts for axial grooving

▲ with corner radius

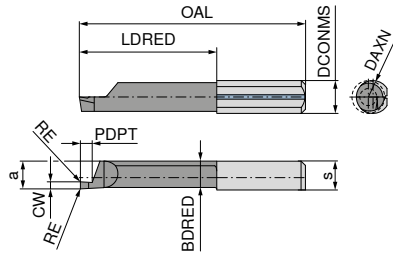
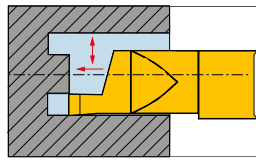

Illustrations show right-hand versions

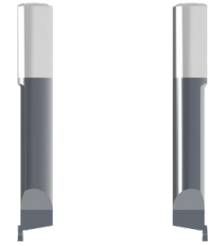

Left-hand Right-hand

Designation	DCONMS ₁₆ mm	a mm	DAXN mm	s mm	OAL mm	LDRED mm	PDPT mm	BDRED mm	CW mm	RE mm	Standard tool holder	73 253 ...		73 252 ...	
												Left-hand	Right-hand	Left-hand	Right-hand
R/L 510M1008-10	5	4.3	5	6.3	26	11	2	4.0	1.0	0.05	645.00..-D	510		510	
R/L 510M1008-20	5	4.3	5	6.3	35	20	2	4.0	1.0	0.05	645.00..-D	610		610	
R/L 510M1508-10	5	4.3	5	6.3	26	11	3	4.0	1.5	0.05	645.00..-D	515		515	
R/L 510M1508-20	5	4.3	5	6.3	35	20	3	4.0	1.5	0.05	645.00..-D	615		615	
R/L 510M2008-10	5	4.3	5	6.3	26	11	4	4.0	2.0	0.05	645.00..-D	520		520	
R/L 510M2008-20	5	4.3	5	6.3	35	20	4	4.0	2.0	0.05	645.00..-D	620		620	
R/L 010M1008-10	7	5.9	8	6.3	26	11	2	5.6	1.0	0.10	676.00..-D	800		800	
R/L 010M1008-20	7	5.9	8	6.3	35	20	2	5.6	1.0	0.10	676.00..-D	810		810	
R/L 010M1008-30	7	5.9	8	6.3	45	30	2	5.6	1.0	0.10	676.00..-D	820		820	
R/L 010M1508-10	7	5.9	8	6.3	26	11	3	5.6	1.5	0.10	676.00..-D	802		802	
R/L 010M1508-20	7	5.9	8	6.3	35	20	3	5.6	1.5	0.10	676.00..-D	812		812	
R/L 010M1508-30	7	5.9	8	6.3	45	30	3	5.6	1.5	0.10	676.00..-D	822		822	
R/L 010M2008-10	7	5.9	8	6.3	26	11	4	5.6	2.0	0.10	676.00..-D	804		804	
R/L 010M2008-20	7	5.9	8	6.3	35	20	4	5.6	2.0	0.10	676.00..-D	814		814	
R/L 010M2008-30	7	5.9	8	6.3	45	30	4	5.6	2.0	0.10	676.00..-D	824		824	
R/L 010M2508-10	7	5.9	8	6.3	26	11	5	5.6	2.5	0.10	676.00..-D	806		806	
R/L 010M2508-20	7	5.9	8	6.3	35	20	5	5.6	2.5	0.10	676.00..-D	816		816	
R/L 010M2508-30	7	5.9	8	6.3	45	30	5	5.6	2.5	0.10	676.00..-D	826		826	
R/L 010M3008-10	7	5.9	8	6.3	26	11	6	5.6	3.0	0.10	676.00..-D	808		808	
R/L 010M3008-20	7	5.9	8	6.3	35	20	6	5.6	3.0	0.10	676.00..-D	818		818	
R/L 010M3008-30	7	5.9	8	6.3	45	30	6	5.6	3.0	0.10	676.00..-D	828		828	
P												●		●	
M												●		●	
K												●		●	
N												●		●	
S												●		●	
H												●		●	
O												●		●	

→ v. Page 339

UltraMini – Inserts for axial grooving (Full radius)

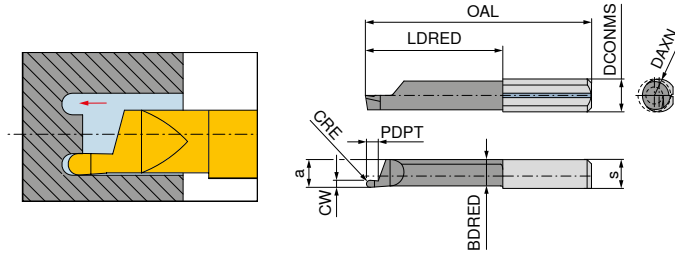

Illustrations show right-hand versions

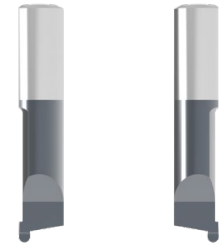

Left-hand Right-hand

Designation	DCONMS _{h6} mm	a mm	DAXN mm	s mm	OAL mm	LDRED mm	PDPT mm	BDRED mm	CW mm	CRE mm	Standard tool holder	TiAlN	
												73 059 ...	73 058 ...
R/L 610.1005-10	6	5.2	6	5.3	26	11	2	4.9	1.0	0.50	676.00.-D	071	071
R/L 610.1005-20	6	5.2	6	5.3	35	20	2	4.9	1.0	0.50	676.00.-D	171	171
R/L 610.1608-10	6	5.2	6	5.3	26	11	3	4.9	1.6	0.80	676.00.-D	073	073
R/L 610.1608-20	6	5.2	6	5.3	35	20	3	4.9	1.6	0.80	676.00.-D	173	173
R/L 610.2010-10	6	5.2	6	5.3	26	11	4	4.9	2.0	1.00	676.00.-D	075	075
R/L 610.2010-20	6	5.2	6	5.3	35	20	4	4.9	2.0	1.00	676.00.-D	175	175
R/L 610.2512-10	6	5.2	6	5.3	26	11	5	4.9	2.5	1.25	676.00.-D	077	077
R/L 610.2512-20	6	5.2	6	5.3	35	20	5	4.9	2.5	1.25	676.00.-D	177	177
R/L 610.3015-10	6	5.2	6	5.3	26	11	6	4.9	3.0	1.50	676.00.-D	079	079
R/L 610.3015-20	6	5.2	6	5.3	35	20	6	4.9	3.0	1.50	676.00.-D	179	179
R/L 010.1005-10	7	5.9	8	6.3	26	11	2	5.6	1.0	0.50	676.00.-D	571	571
R/L 010.1005-20	7	5.9	8	6.3	35	20	2	5.6	1.0	0.50	676.00.-D	671	671
R/L 010.1608-10	7	5.9	8	6.3	26	11	3	5.6	1.6	0.80	676.00.-D	573	573
R/L 010.1608-20	7	5.9	8	6.3	35	20	3	5.6	1.6	0.80	676.00.-D	673	673
R/L 010.2010-10	7	5.9	8	6.3	26	11	4	5.6	2.0	1.00	676.00.-D	575	575
R/L 010.2010-20	7	5.9	8	6.3	35	20	4	5.6	2.0	1.00	676.00.-D	675	675
R/L 010.2512-10	7	5.9	8	6.3	26	11	5	5.6	2.5	1.25	676.00.-D	577	577
R/L 010.2512-20	7	5.9	8	6.3	35	20	5	5.6	2.5	1.25	676.00.-D	677	677
R/L 010.3015-10	7	5.9	8	6.3	26	11	6	5.6	3.0	1.50	676.00.-D	579	579
R/L 010.3015-20	7	5.9	8	6.3	35	20	6	5.6	3.0	1.50	676.00.-D	679	679
P												•	•
M												•	•
K												•	•
N												•	•
S												•	•
H												•	•
O												•	•

→ v_c Page 339



UltraMini – Inserts for axial grooving over a spigot

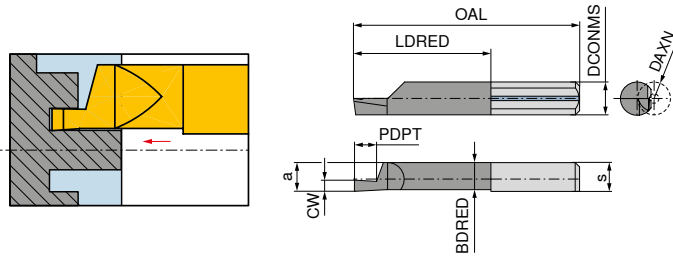

Illustrations show right-hand versions

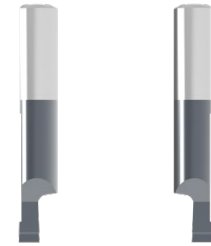

Left-hand Right-hand

Designation	DCONMS _{h6} mm	a mm	DAXN mm	s mm	OAL mm	LDRED mm	PDPT mm	BDRED mm	CW mm	Standard tool holder	73 061 ...		73 060 ...	
											561	561	563	563
R/L 620.1006-20	6	5.2	6	5.3	35	20	2	4.9	1.0	676.00..-D				
R/L 620.1506-20	6	5.2	6	5.3	35	20	3	4.9	1.5	676.00..-D				
R/L 620.2006-20	6	5.2	6	5.3	35	20	4	4.9	2.0	676.00..-D				
R/L 620.2506-20	6	5.2	6	5.3	35	20	5	4.9	2.5	676.00..-D				
R/L 620.3006-20	6	5.2	6	5.3	35	20	6	4.9	3.0	676.00..-D				
P												●	●	
M												●	●	
K												●	●	
N												●	●	
S												●	●	
H												●	●	
O												●	●	

→ v_c Page 339

UltraMini – Inserts for axial grooving over a spigot

▲ with corner radius

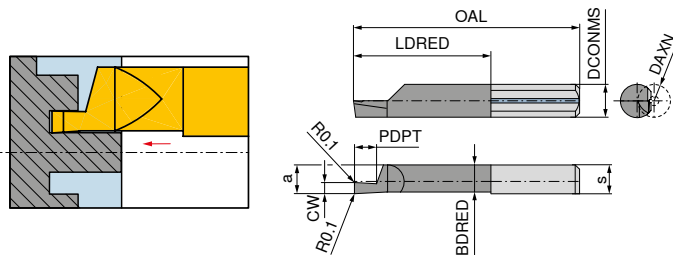

Illustrations show right-hand versions

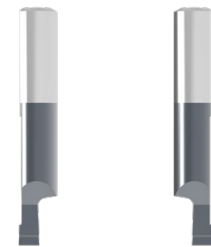

Left-hand Right-hand

Designation	DCONMS _{h6} mm	a mm	DAXN mm	s mm	OAL mm	LDRED mm	PDPT mm	BDRED mm	CW mm	Standard tool holder	73 261 ...		73 260 ...	
											800	800	802	802
R/L 620M1006-20	6	5.2	6	5.3	35	20	2	4.9	1.0	676.00..-D				
R/L 620M1506-20	6	5.2	6	5.3	35	20	3	4.9	1.5	676.00..-D				
R/L 620M2006-20	6	5.2	6	5.3	35	20	4	4.9	2.0	676.00..-D				
R/L 620M2506-20	6	5.2	6	5.3	35	20	5	4.9	2.5	676.00..-D				
R/L 620M3006-20	6	5.2	6	5.3	35	20	6	4.9	3.0	676.00..-D				
P												●	●	
M												●	●	
K												●	●	
N												●	●	
S												●	●	
H												●	●	
O												●	●	

→ v_c Page 339

UltraMini – Inserts for axial grooving

- ▲ up to 70 bar
- ▲ dual cooling channel

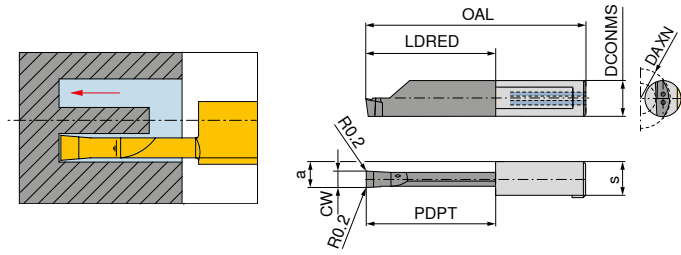

Illustrations show right-hand versions



Left-hand Right-hand

Designation	DCONMS _{hg} mm	a mm	DAXN mm	s mm	OAL mm	LDRED mm	PDPT mm	CW mm	Standard tool holder	73 263 ...		73 262 ...	
R/L 012.0200-10	8	5.00	12	7.3	30	10	10	2.0	687.00..-D	700		700	
R/L 012.0200-15	8	5.00	12	7.3	35	15	15	2.0	687.00..-D	702		702	
R/L 012.0250-10	8	5.25	12	7.3	30	10	10	2.5	687.00..-D	704		704	
R/L 012.0250-20	8	5.25	12	7.3	40	20	20	2.5	687.00..-D	706		706	
R/L 016.0300-10	8	5.50	16	7.3	30	10	10	3.0	687.00..-D	800		800	
R/L 016.0300-20	8	5.50	16	7.3	40	20	20	3.0	687.00..-D	802		802	
R/L 020.0300-25	8	5.50	20	7.3	45	25	25	3.0	687.00..-D	804		804	
R/L 020.0300-30	8	5.50	20	7.3	50	30	30	3.0	687.00..-D	806		806	
R/L 020.0300-35	8	5.50	20	7.3	55	35	35	3.0	687.00..-D	808		808	
R/L 020.0300-40	8	5.50	20	7.3	60	40	40	3.0	687.00..-D	810		810	
R/L 016.0400-10	8	6.00	16	7.3	30	10	10	4.0	687.00..-D	812		812	
R/L 016.0400-20	8	6.00	16	7.3	40	20	20	4.0	687.00..-D	814		814	
R/L 020.0400-25	8	6.00	20	7.3	45	25	25	4.0	687.00..-D	816		816	
R/L 020.0400-30	8	6.00	20	7.3	50	30	30	4.0	687.00..-D	818		818	
R/L 020.0400-35	8	6.00	20	7.3	55	35	35	4.0	687.00..-D	820		820	
R/L 020.0400-40	8	6.00	20	7.3	60	40	40	4.0	687.00..-D	822		822	
R/L 020.0500.20	8	6.50	20	7.3	40	20	20	5.0	687.00..-D	824		824	
R/L 020.0500.25	8	6.50	20	7.3	45	25	25	5.0	687.00..-D	826		826	
R/L 020.0500.30	8	6.50	20	7.3	50	30	30	5.0	687.00..-D	828		828	
R/L 020.0500.35	8	6.50	20	7.3	55	35	35	5.0	687.00..-D	830		830	
R/L 020.0500.40	8	6.50	20	7.3	60	40	40	5.0	687.00..-D	832		832	
P										•		•	
M										•		•	
K										•		•	
N										•		•	
S										•		•	
H										•		•	
O										•		•	

→ v_c Page 339

UltraMini – Inserts for axial grooving

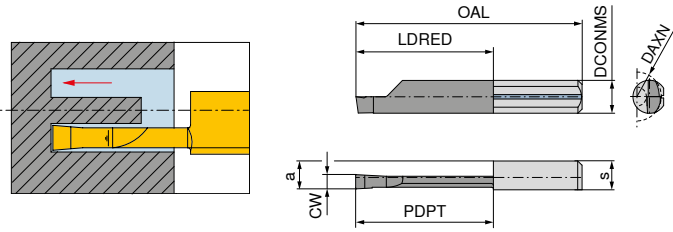

Illustrations show right-hand versions



Left-hand **73 055 ...** Right-hand **73 054 ...** Left-hand **73 057 ...** Right-hand **73 056 ...**

Designation	DCONMS _{HS} mm	a mm	DAXN mm	s mm	OAL mm	LDRED mm	PDPT mm	CW mm	Standard tool holder				
R/L 015.2515-20	7	5.9	15	6.3	35	20	20	2.5	676.00..-D		572		572
R/L 015.3015-20	7	5.9	15	6.3	35	20	20	3.0	676.00..-D		574		574
R/L 015.3015-30	7	5.9	15	6.3	45	30	30	3.0	676.00..-D		674		674
P											●		●
M											●		●
K											●		●
N											●		●
S											○		○
H											○		○
O											●		●

→ v_c Page 339

UltraMini – Inserts for axial grooving

▲ with corner radius

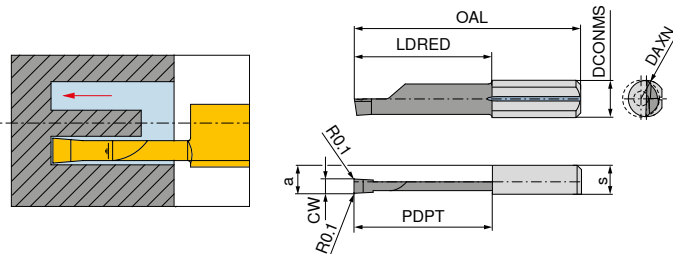

Illustrations show right-hand versions

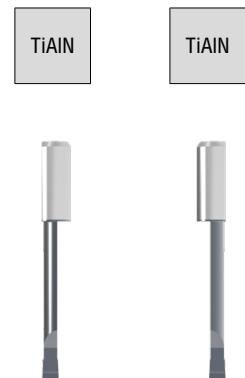

Left-hand **73 257 ...** Right-hand **73 256 ...**

Designation	DCONMS _{HS} mm	a mm	DAXN mm	s mm	OAL mm	LDRED mm	PDPT mm	CW mm	Standard tool holder				
R/L 015M2515-20	7	5.9	8	6.3	35	20	20	2.5	676.00..-D		800		800
R/L 015M3015-20	7	5.9	8	6.3	35	20	20	3.0	676.00..-D		802		802
R/L 015M3015-30	7	5.9	8	6.3	45	30	30	3.0	676.00..-D		804		804
P											●		●
M											●		●
K											●		●
N											●		●
S											●		●
H											●		●
O											●		●

→ v_c Page 339

UltraMini – Standard tool holder for cutting inserts

- ▲ double ended
- ▲ Machining diameter from $\varnothing 0.5$ mm

Scope of supply:

Tool holder with allen key

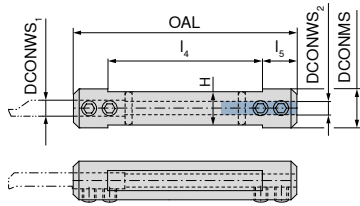

Designation	DCONWS ₁ mm	DCONWS ₂ mm	DCONMS mm	OAL mm	l ₄ mm	l ₅ mm	H mm
645.0012-D	4	5	12.00	75	55	10	10.3
645.0016-D	4	5	16.00	75	55	10	14.0
645.001905-D	4	5	19.05	90	70	10	17.2
645.0020-D	4	5	20.00	90	70	10	18.0
645.0022-D	4	5	22.00	90	70	10	20.0
645.00254-D	4	5	25.40	95	75	10	23.4
676.0016-D	6	7	16.00	75	55	10	14.0
676.001905-D	6	7	19.05	90	70	10	17.2
676.0020-D	6	7	20.00	90	70	10	18.0
676.0022-D	6	7	22.00	90	70	10	20.0
676.00254-D	6	7	25.40	95	75	10	23.4
687.0016-D	7	8	16.00	75	55	10	14.0
687.0020-D	7	8	20.00	90	70	10	18.0

73 080 ...

163
164
170
165
171
172

166
173
167
174
175

168
169

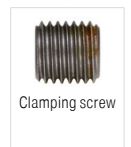

70 950 ...

73 082 ...

Spare parts for Article no.

73 080 169	SW2,5	175	M6x6	014
73 080 163	SW2,5	175	M5x4	013
73 080 164	SW2,5	175	M5x6	001
73 080 165	SW2,5	175	M5x8	008
73 080 166	SW2,5	175	M5x6	001
73 080 167	SW2,5	175	M5x8	008
73 080 168	SW2,5	175	M6x6	014
73 080 170	SW2,5	175	M5x6	001
73 080 171	SW2,5	175	M5x8	008
73 080 172	SW2,5	175	M5x8	008
73 080 173	SW2,5	175	M5x6	001
73 080 174	SW2,5	175	M5x8	008
73 080 175	SW2,5	175	M5x8	008

UltraMini – Quick change tool holder for cutting inserts

Scope of supply:

Tool holder, lock nut and clamping wedge

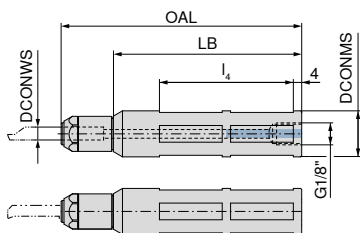

73 089 ...

Designation	DCONWS mm	DCONMS _{g6} mm	OAL mm	LB mm	l _s mm	
UM600H.0012.4	4	12.00	115	90	64	124
UM600H.0016.4	4	16.00	115	90	64	164
UM600H.001905.4	4	19.05	115	90	64	194
UM600H.0020.4	4	20.00	115	90	64	204
UM600H.0022.4	4	22.00	115	90	64	224
UM600H.0025.4	4	25.00	115	90	64	254
UM600H.00254.4	4	25.40	115	90	64	264
UM600H.0028.4	4	28.00	115	90	64	284
UM600H.0012.5	5	12.00	115	90	64	125
UM600H.0016.5	5	16.00	115	90	64	165
UM600H.001905.5	5	19.05	115	90	64	195
UM600H.0020.5	5	20.00	115	90	64	205
UM600H.0022.5	5	22.00	115	90	64	225
UM600H.0025.5	5	25.00	115	90	64	255
UM600H.00254.5	5	25.40	115	90	64	265
UM600H.0028.5	5	28.00	115	90	64	285
UM600H.0012.6	6	12.00	115	90	64	126
UM600H.0016.6	6	16.00	115	90	64	166
UM600H.001905.6	6	19.05	115	90	64	196
UM600H.0020.6	6	20.00	115	90	64	206
UM600H.0022.6	6	22.00	115	90	64	226
UM600H.0025.6	6	25.00	115	90	64	256
UM600H.00254.6	6	25.40	115	90	64	266
UM600H.0028.6	6	28.00	115	90	64	286
UM600H.0012.7	7	12.00	115	90	64	127
UM600H.0016.7	7	16.00	115	90	64	167
UM600H.001905.7	7	19.05	115	90	64	197
UM600H.0020.7	7	20.00	115	90	64	207
UM600H.0022.7	7	22.00	115	90	64	227
UM600H.0025.7	7	25.00	115	90	64	257
UM600H.00254.7	7	25.40	115	90	64	267
UM600H.0028.7	7	28.00	115	90	64	287

Avoid pulling cuts. Ensure a suitable clamping force is used when using thro' coolant supply. Can be tightened using a key.

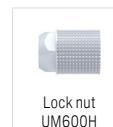

73 950 ...

73 950 ...

Spare parts

DCONWS			
4	M4	104	111
5	M5	105	111
6	M6	106	111
7	M7	107	111

UltraMini – Toolholder for inserts

▲ Tool holder suitable for high coolant pressures

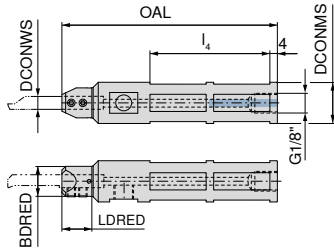

73 088 ...

Designation	DCONWS	BDRED	DCONMS ₉₀	OAL	LDRED	l ₄	
	mm	mm	mm	mm	mm	mm	
UMST.0016.4	4	16	16.00	115	24	42	164
UMST.001905.4	4	16	19.05	115	24	42	194
UMST.0020.4	4	16	20.00	115	24	42	204
UMST.0022.4	4	16	22.00	115	24	42	224
UMST.00254.4	4	16	25.40	115	24	42	264
UMST.0028.4	4	16	28.00	115	24	42	284
UMST.0016.5	5	16	16.00	115	24	42	165
UMST.001905.5	5	16	19.05	115	24	42	195
UMST.0020.5	5	16	20.00	115	24	42	205
UMST.0022.5	5	16	22.00	115	24	42	225
UMST.00254.5	5	16	25.40	115	24	42	265
UMST.0028.5	5	16	28.00	115	24	42	285
UMST.0016.6	6	16	16.00	115	24	42	166
UMST.001905.6	6	16	19.05	115	24	42	196
UMST.0020.6	6	16	20.00	115	24	42	206
UMST.0022.6	6	16	22.00	115	24	42	226
UMST.00254.6	6	16	25.40	115	24	42	266
UMST.0028.6	6	16	28.00	115	24	42	286
UMST.0016.7	7	16	16.00	115	24	42	167
UMST.001905.7	7	16	19.05	115	24	42	197
UMST.0020.7	7	16	20.00	115	24	42	207
UMST.0022.7	7	16	22.00	115	24	42	227
UMST.00254.7	7	16	25.40	115	24	42	267
UMST.0028.7	7	16	28.00	115	24	42	287
UMST.0016.8	8	16	16.00	115	24	42	168
UMST.001905.8	8	16	19.05	115	24	42	198
UMST.0020.8	8	16	20.00	115	24	42	208
UMST.0022.8	8	16	22.00	115	24	42	228
UMST.00254.8	8	16	25.40	115	24	42	268
UMST.0028.8	8	16	28.00	115	24	42	288

3

up to 150 bar

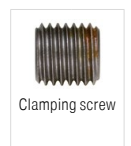
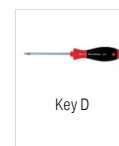

80 950 ...

73 950 ...

Spare parts

DCONWS		80 950 ...	73 950 ...
4	T10	104	M5x0,5x6T10 050
5	T10	104	M5x0,5x6T10 050
6	T10	104	M5x0,5x6T10 050
7	T10	104	M5x0,5x6T10 050
8	T10	104	M5x0,5x6T10 050

UltraMini – Toolholder for inserts

▲ single ended

Scope of supply:

Tool holder with allen key

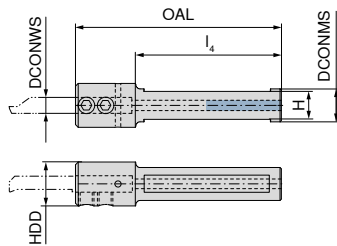

Designation	DCONWS mm	HDD mm	DCONMS mm	OAL mm	l ₄ mm	H mm
640.0012-D	4	16	12	75	53	10.2
650.0012-D	5	16	12	75	53	10.2
660.0012-D	6	16	12	75	53	10.2
670.0012-D	7	16	12	75	53	10.2
680.0012-D	8	16	12	75	53	10.2

73 081 ...

264
265
266
267
268

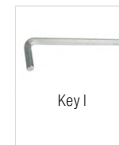

70 950 ...

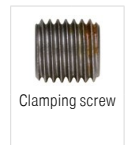

73 082 ...

Spare parts

DCONWS				
4	SW2,5	175	M5x0,5x6	010
5	SW2,5	175	M5x0,5x6	010
6	SW2,5	175	M5x0,5x6	010
7	SW2,5	175	M5x0,5x6	010
8	SW2,5	175	M5x0,5x6	010

UltraMini – Toolholder for inserts

Scope of supply:

Tool holder with allen key

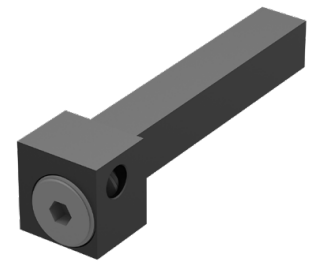
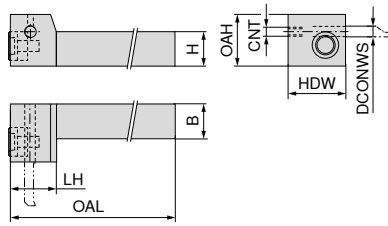

Designation	DCONWS mm	OAL mm	LH mm	B mm	HDW mm	H mm	OAH mm	CNT	Left-hand 73 083 ...		Right-hand 73 084 ...	
R/L .IK.UHCM.1212.4	4	90	17	12	20	12	18	M5	124		124	
R/L .IK.UHCM.1212.5	5	90	17	12	20	12	18	M5	125		125	
R/L .IK.UHCM.1212.6	6	90	17	12	20	12	21	M5	126		126	
R/L .IK.UHCM.1212.7	7	90	17	12	20	12	21	M5	127		127	

Suitable coolant connections can be found on → page 131+132

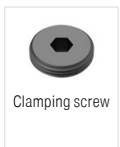

Spare parts

DCONWS		73 082 ...
4	UM 12	011
5	UM 12	011
6	UM 16	012
7	UM 16	012

UltraMini – Toolholder for inserts

Scope of supply:

Tool holder with allen key

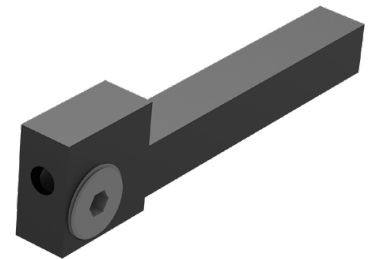
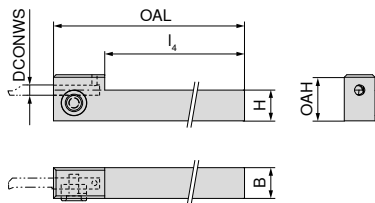

Designation	DCONWS mm	OAL mm	l ₄ mm	B mm	H mm	OAH mm	73 086 ...	
UM.1010.4	4	100	75	10	10	20	104	
UM.1212.4	4	100	75	12	12	22	124	
UM.1010.5	5	100	75	10	10	20	105	
UM.1212.5	5	100	75	12	12	22	125	
UM.1212.6	6	100	75	12	12	22	126	

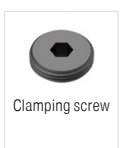

Spare parts

DCONWS		73 082 ...
4	UM 12	011
5	UM 12	011
6	UM 16	012

UltraMini – Toolholder for inserts

Scope of supply:

Tool holder with allen key

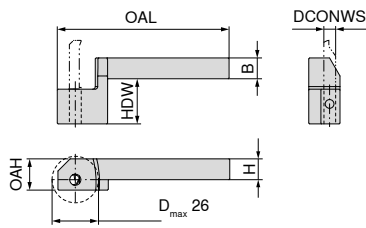

Illustrations show right-hand versions

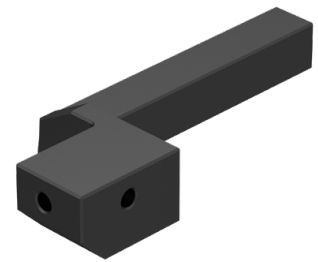

Designation	DCONWS mm	OAL mm	B mm	HDW mm	H mm	OAH mm
R/L UM.18.1010.4	4	99	10	38	10	16
R/L UM.28.1010.4	4	99	10	48	10	16
R/L UM.18.1212.4	4	99	12	38	12	18
R/L UM.28.1212.4	4	99	12	48	12	18
R/L UM.18.1010.5	5	99	10	38	10	16
R/L UM.28.1010.5	5	99	10	48	10	16
R/L UM.18.1212.5	5	99	12	38	12	18
R/L UM.28.1212.5	5	99	12	48	12	18
R/L UM.18.1010.6	6	99	10	38	10	16
R/L UM.28.1010.6	6	99	10	48	10	16
R/L UM.18.1212.6	6	99	12	38	12	18
R/L UM.28.1212.6	6	99	12	48	12	18
R/L UM.18.1010.7	7	99	10	38	10	16
R/L UM.28.1010.7	7	99	10	48	10	16
R/L UM.18.1212.7	7	99	12	38	12	18
R/L UM.28.1212.7	7	99	12	48	12	18

Left-hand 73 091 ...	Right-hand 73 090 ...
104	104
204	204
124	124
224	224
105	105
205	205
125	125
225	225
106	106
206	206
126	126
226	226
107	107
207	207
127	127
227	227

Spare parts

DCONWS

DCONWS	70 950 ...	73 082 ...
4	SW2,5	M5x8
5	SW2,5	M5x8
6	SW2,5	M5x8
7	SW2,5	M5x8



Key I

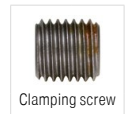

Clamping screw

MiniCut – Insert for turning and profiling

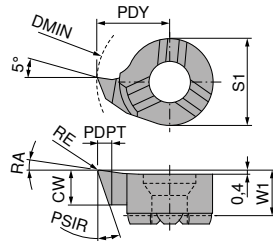
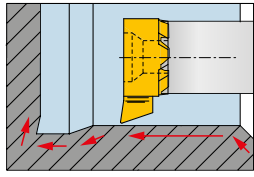

Illustrations show right-hand versions

Size	Designation	DMIN mm	CW mm	W1 mm	PDY mm	S1 mm	RE mm	PDPT mm	PSIR °	RA °
08	8,00. R/L .3,30.18°	7.8	3.3	3.5	4.65	6.0	0.20	0.6	18	8
	8,00. R/L .3,50.18°	7.8	3.5	3.5	4.65	6.0	0.05	0.6	18	8
	8,00. R/L .3,50.20°	7.8	3.5	3.5	4.65	6.0	0.20	0.6	20	20
09	9,00. R/L .3,60.18°	9.0	3.6	3.6	5.50	6.2	0.20	0.8	18	8
	9,00. R/L .3,60.20°	9.0	3.6	3.6	5.50	6.2	0.20	0.8	20	20
11	9,80. R/L .3,90.18°	9.8	3.9	4.2	5.50	8.0	0.20	1.0	18	8
	11,00. R/L .3,90.18°	11.0	3.9	4.2	6.70	8.0	0.20	1.0	18	8
	11,00. R/L .4,20.20°	11.0	4.2	4.2	6.70	8.0	0.20	1.0	20	20
14	14,00. R/L .5,00.18°	13.8	5.0	5.1	8.70	9.0	0.20	1.5	18	8
	14,00. R/L .5,30.20°	14.0	5.3	5.3	8.70	9.0	0.20	1.5	20	20

	Left-hand 73 324 ...	Right-hand 73 322 ...
P	●	●
M	●	●
K	●	●
N	●	●
S	●	●
H	●	●
O	●	●

→ v_c Page 339

MiniCut – Insert for copy turning

▲ with chip breaker

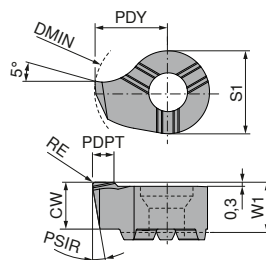
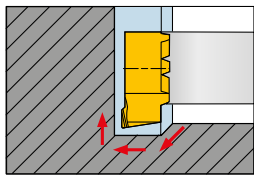

Illustrations show right-hand versions

Size	Designation	DMIN mm	CW mm	W1 mm	PDY mm	S1 mm	RE mm	PDPT mm	PSIR °
08	8,00. R/L .3,40.10°	8	3.4	3.5	4.65	6.0	0.2	0.5	10
09	9,00. R/L .3,50.10°	9	3.5	3.6	5.50	6.2	0.2	0.5	10
11	11,00. R .4,10.10°	11	4.1	4.2	6.70	8.0	0.2	0.5	10

	Left-hand 73 388 ...	Right-hand 73 386 ...
P	●	●
M	●	●
K	●	●
N	●	●
S	●	●
H	●	●
O	●	●

→ v_c Page 339

MiniCut – Internal turning insert

▲ CDX = a_{pmax} (material dependant)

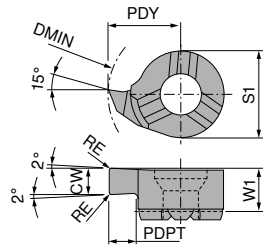
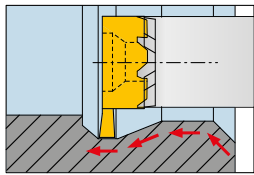

Illustrations show right-hand versions

Size	Designation	DMIN mm	CW ^{+0.05} mm	PDPT mm	W1 mm	PDY mm	S1 mm	RE mm	CDX mm	Left-hand		Right-hand	
										73 316 ...	73 314 ...	73 316 ...	73 314 ...
08	8,00. R/L .1,50.1,0	8	1.5	1.0	3.3	4.8	6.0	0.2	0.2	015		015	
	8,00. R/L .2,00.1,0	8	2.0	1.0	3.3	4.8	6.0	0.2	0.2	020		020	
09	9,00. R/L .1,50.2,0	9	1.5	2.0	3.6	5.5	6.2	0.2	0.2	115		115	
	9,00. R/L .1,50.3,0	10	1.5	3.0	3.6	6.5	6.2	0.2	0.2	121		121	
	9,00. R/L .2,00.2,0	9	2.0	2.0	3.6	5.5	6.2	0.2	0.2	120		120	
	9,00. R/L .2,00.3,0	10	2.0	3.0	3.6	6.5	6.2	0.2	0.2	122		122	
11	11,00. R/L .1,50.2,3	11	1.5	2.3	4.2	6.7	8.0	0.2	0.2	315		315	
	11,00. R/L .2,00.2,3	11	2.0	2.3	4.2	6.7	8.0	0.2	0.2	320		320	
14	14,00. R/L .1,50.4,0	14	1.5	4.0	5.3	9.0	9.0	0.2	0.2	515		515	
	14,00. R/L .1,50.5,5	16	1.5	5.5	5.2	10.5	9.0	0.2	0.2	516		516	
	14,00. R/L .1,50.6,5	17	1.5	6.5	5.2	11.5	9.0	0.2	0.2	517		517	
	14,00. R/L .2,00.4,0	14	2.0	4.0	5.3	9.0	9.0	0.2	0.2	520		520	
	14,00. R/L .2,00.5,5	16	2.0	5.5	5.2	10.5	9.0	0.2	0.2	521		521	
	14,00. R/L .2,00.6,5	17	2.0	6.5	5.2	11.5	9.0	0.2	0.2	522		522	
	14,00. R/L .2,50.5,5	16	2.5	5.5	5.2	10.5	9.0	0.2	0.2	525		525	
	14,00. R/L .2,50.6,5	17	2.5	6.5	5.2	11.5	9.0	0.2	0.2	526		526	
	14,00. R/L .3,00.5,5	16	3.0	5.5	5.2	10.5	9.0	0.2	0.2	530		530	
	14,00. R/L .3,00.6,5	17	3.0	6.5	5.2	11.5	9.0	0.2	0.2	531		531	
P										●		●	
M										●		●	
K										●		●	
N										●		●	
S										●		●	
H										●		●	
O										●		●	

→ v_c Page 339

MiniCut – Back boring insert

▲ CDX = $a_{p_{max}}$ (material dependant)

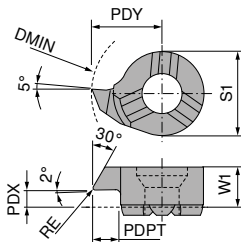
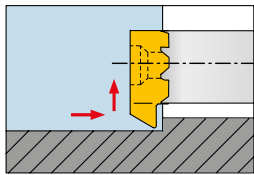

CWX500

CWX500



Illustrations show right-hand versions

Size	Designation	DMIN mm	PDPT mm	W1 mm	PDX mm	PDY mm	S1 mm	RE mm	CDX mm	Left-hand	Right-hand
										73 332 ...	73 330 ...
08	8,00. R/L .30°1,3	7.8	1.3	3.50	1.0	4.65	6.0	0.2	0.6	013	013
09	9,00. R/L .30°1,7	9.0	1.7	3.55	1.2	5.50	6.2	0.2	0.8	117	117
	9,00. R/L .30°2,3	10.0	2.3	3.55	1.2	6.50	6.2	0.2	0.8	123	123
11	11,00. R/L .30°2,3	11.0	2.3	4.30	1.6	6.70	8.0	0.2	1.0	323	323
14	14,00. R/L .30°3,5	13.8	3.5	5.40	2.4	8.70	9.0	0.2	1.5	535	535
P										●	●
M										●	●
K										●	●
N										●	●
S										●	●
H										●	●
O										●	●

→ v_c Page 339

MiniCut – Internal turning and chamfering insert

▲ CDX = $a_{p_{max}}$ (material dependant)

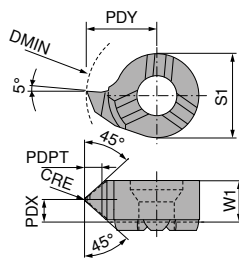
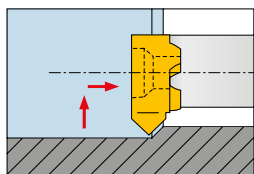

CWX500

CWX500



Illustrations show right-hand versions

Size	Designation	DMIN mm	PDPT mm	W1 mm	PDX mm	PDY mm	S1 mm	CRE mm	CDX mm	Left-hand	Right-hand
										73 336 ...	73 334 ...
08	8,00. R/L .45°1,4	8	1.4	3.50	1.8	4.8	6.0	0.2	0.6	010	010
09	9,00. R/L .45°1,3	9	1.3	3.55	1.8	5.5	6.2	0.2	0.8	110	110
	11,00. R/L .45°1,5	11	1.5	4.30	2.2	6.7	8.0	0.2	1.0	310	310
14	14,00. R/L .45°1,5	14	1.5	5.40	2.8	9.0	9.0	0.2	1.2	510	510
P										●	●
M										●	●
K										●	●
N										●	●
S										●	●
H										●	●
O										●	●

→ v_c Page 339

MiniCut – Insert for pregrooving and chamfering

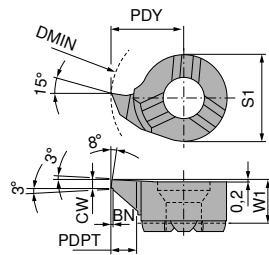
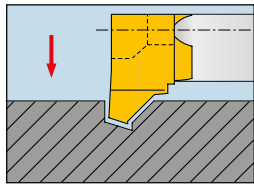

Illustrations show right-hand versions

Size	Designation	DMIN mm	CW mm	PDPT mm	W1 mm	PDY mm	S1 mm	BN mm	Left-hand		Right-hand	
									73 340 ...	73 338 ...	73 340 ...	73 338 ...
08	8,00. R/L .1,00.45°	8	1	1.0	3.3	4.8	6.0	0.2	100		100	
09	9,00. R/L .1,00.45°	9	1	1.5	3.6	5.5	6.2	0.2	215		215	
11	11,00. R/L .1,00.45°	11	1	1.5	4.2	6.7	8.0	0.2	315		315	
14	14,00. R/L .1,00.45°	14	1	1.5	5.3	9.0	9.0	0.2	515		515	
P									●		●	
M									●		●	
K									●		●	
N									●		●	
S									●		●	
H									●		●	
O									●		●	

→ v_c Page 339

MiniCut – Grooving insert

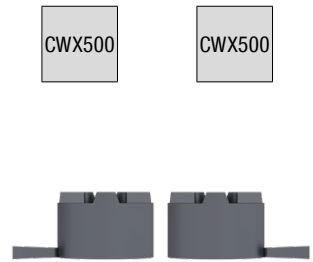
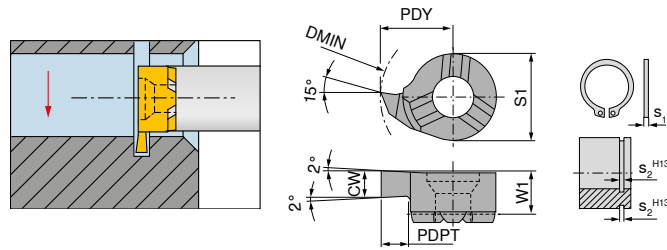

Illustrations show right-hand versions

Size	Designation	DMIN mm	CW mm	PDPT mm	W1 mm	S1 mm	S2 H13 mm	PDY mm	S1 mm	Left-hand	Right-hand
										73 312 ...	73 310 ...
08	8,00. R/L .073.1,0	8	0.73	1.0	3.3	0.6	0.7	4.8	6.0	073	073
	8,00. R/L .083.1,0	8	0.83	1.0	3.3	0.7	0.8	4.8	6.0	083	083
	8,00. R/L .093.1,0	8	0.93	1.0	3.3	0.8	0.9	4.8	6.0	093	093
	8,00. R/L .100.1,0	8	1.00	1.0	3.3			4.8	6.0	110	110
	8,00. R/L .120.1,0	8	1.20	1.0	3.3	1.0	1.1	4.8	6.0	112	112
	8,00. R/L .140.1,0	8	1.40	1.0	3.3	1.2	1.3	4.8	6.0	114	114
	8,00. R/L .150.1,0	8	1.50	1.0	3.3			4.8	6.0	115	115
	8,00. R/L .170.1,0	8	1.70	1.0	3.3	1.5	1.6	4.8	6.0	117	117
	8,00. R/L .200.1,0	8	2.00	1.0	3.3			4.8	6.0	120	120
09	9,00. R/L .073.1,2	9	0.73	1.2	3.6	0.6	0.7	5.5	6.2	173	173
	9,00. R/L .083.1,3	9	0.83	1.3	3.6	0.7	0.8	5.5	6.2	183	183
	9,00. R/L .093.1,5	9	0.93	1.5	3.6	0.8	0.9	5.5	6.2	193	193
	9,00. R/L .100.1,8	9	1.00	1.8	3.6			5.5	6.2	210	210
	9,00. R/L .120.1,8	9	1.20	1.8	3.6	1.0	1.1	5.5	6.2	212	212
	9,00. R/L .140.1,8	9	1.40	1.8	3.6	1.2	1.3	5.5	6.2	214	214
	9,00. R/L .150.1,8	9	1.50	1.8	3.6			5.5	6.2	215	215
	9,00. R/L .170.1,8	9	1.70	1.8	3.6	1.5	1.6	5.5	6.2	217	217
	9,00. R/L .200.1,8	9	2.00	1.8	3.6			5.5	6.2	220	220
	9,00. R/L .250.1,8	9	2.50	1.8	3.6			5.5	6.2	225	225
9,00. R/L .300.1,8	9	3.00	1.8	3.6			5.5	6.2	230	230	
11	11,00. R/L .073.1,2	11	0.73	1.2	4.2	0.6	0.7	6.7	8.0	373	373
	11,00. R/L .083.1,3	11	0.83	1.3	4.2	0.7	0.8	6.7	8.0	383	383
	11,00. R .093.1,5	11	0.93	1.5	4.2	0.9	0.9	6.7	8.0	393	393
	11,00. L .093.1,5	11	0.93	1.5	4.2	0.8	0.9	6.7	8.0	393	393
	11,00. R/L .100.2,3	11	1.00	2.3	4.2			6.7	8.0	310	310
	11,00. R/L .120.2,3	11	1.20	2.3	4.2	1.0	1.1	6.7	8.0	312	312
	11,00. R/L .140.2,3	11	1.40	2.3	4.2	1.2	1.3	6.7	8.0	314	314
	11,00. R/L .150.2,3	11	1.50	2.3	4.2			6.7	8.0	315	315
	11,00. R/L .170.2,3	11	1.70	2.3	4.2	1.5	1.6	6.7	8.0	317	317
	11,00. R/L .200.2,3	11	2.00	2.3	4.2			6.7	8.0	320	320
11,00. R/L .250.2,3	11	2.50	2.3	4.2			6.7	8.0	325	325	
11,00. R/L .300.2,3	11	3.00	2.3	4.2			6.7	8.0	330	330	
14	14,00. R/L .073.1,2	14	0.73	1.2	5.3	0.6	0.7	9.0	9.0	573	573
	14,00. R/L .083.1,3	14	0.83	1.3	5.3	0.7	0.8	9.0	9.0	583	583
	14,00. R/L .093.1,5	14	0.93	1.5	5.3	0.8	0.9	9.0	9.0	593	593
	14,00. R/L .120.4,0	14	1.20	4.0	5.3	1.0	1.1	9.0	9.0	512	512
	14,00. R/L .140.4,0	14	1.40	4.0	5.3	1.2	1.3	9.0	9.0	514	514
	14,00. R/L .150.4,0	14	1.50	4.0	5.3			9.0	9.0	515	515
	14,00. R/L .170.4,0	14	1.70	4.0	5.3	1.5	1.6	9.0	9.0	517	517
	14,00. R/L .200.4,0	14	2.00	4.0	5.3			9.0	9.0	520	520
	14,00. R/L .250.4,0	14	2.50	4.0	5.3			9.0	9.0	525	525
	14,00. R/L .300.4,0	14	3.00	4.0	5.3			9.0	9.0	530	530
P										●	●
M										●	●
K										●	●
N										●	●
S										●	●
H										●	●
O										●	●

→ v_c Page 339

MiniCut – Grooving insert

▲ large groove depth (T_{max} 5.5 mm)

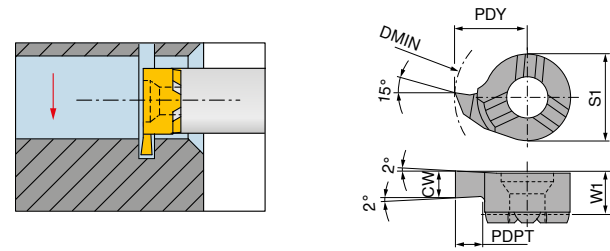

Illustrations show right-hand versions

Size	Designation	DMIN mm	CW ^{-0.03} mm	PDPT mm	W1 mm	PDY mm	S1 mm
14	14,00. R/L .1,50.5,5	16	1.5	5.5	5.2	10.5	9
	14,00. R/L .2,00.5,5	16	2.0	5.5	5.2	10.5	9
	14,00. R/L .2,50.5,5	16	2.5	5.5	5.2	10.5	9
	14,00. R/L .3,00.5,5	16	3.0	5.5	5.2	10.5	9

	Left-hand 73 372 ...	Right-hand 73 370 ...
P	●	●
M	●	●
K	●	●
N	●	●
S	●	●
H	●	●
O	●	●

→ v_c Page 339

MiniCut – Grooving insert

▲ large groove depth (T_{max} 6.5 mm)

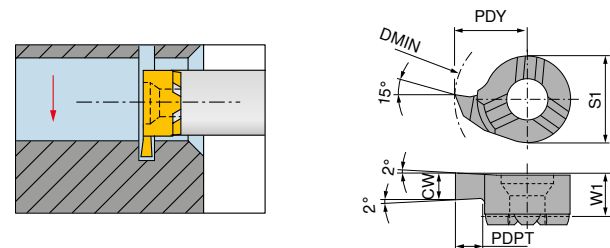

Illustrations show right-hand versions

Size	Designation	DMIN mm	CW ^{-0.03} mm	PDPT mm	W1 mm	PDY mm	S1 mm
14	14,00. R/L .1,50.6,5	17	1.5	6.5	5.2	11.5	9
	14,00. R/L .2,00.6,5	17	2.0	6.5	5.2	11.5	9
	14,00. R/L .2,50.6,5	17	2.5	6.5	5.2	11.5	9
	14,00. R/L .3,00.6,5	17	3.0	6.5	5.2	11.5	9

	Left-hand 73 384 ...	Right-hand 73 382 ...
P	●	●
M	●	●
K	●	●
N	●	●
S	●	●
H	●	●
O	●	●

→ v_c Page 339

MiniCut – Internal undercut insert

▲ CDX = $a_{p_{max}}$ (material dependant)

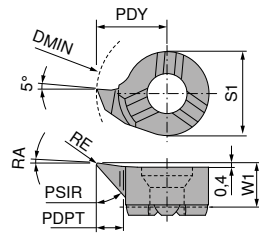
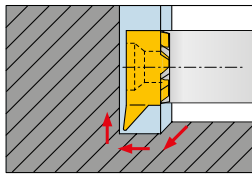

Illustrations show right-hand versions

Size	Designation	DMIN mm	PDPT mm	W1 mm	PDY mm	S1 mm	RE mm	CDX mm	PSIR °	RA °	Left-hand	Right-hand
											73 328 ...	73 326 ...
08	8,00. R/L .30°:1,0	7.8	1.0	3.5	4.65	6.0	0.2	0.4	30	3	010	010
	8,00. R/L .47°:1,2	7.8	1.2	3.5	4.65	6.0	0.2	0.4	47	3	012	012
09	9,00. R/L .47°:1,5	9.0	1.5	3.6	5.50	6.2	0.2	0.5	47	3	115	115
11	11,00. R/L .30°:2,3	11.0	2.3	4.2	6.70	8.0	0.2	0.6	30	3	423	423
	11,00. R/L .47°:2,3	11.0	2.3	4.2	6.70	8.0	0.2	0.6	47	3	323	323
14	13,70. R/L .47°:3,0	13.7	3.0	5.3	8.70	9.0	0.2	0.8	47	3	530	530
	13,70. R/L .30°:4,0	13.7	4.0	5.3	8.70	9.0	0.2	0.8	30	3	540	540
P											•	•
M											•	•
K											•	•
N											•	•
S											•	•
H											•	•
O											•	•

→ v_c Page 339

MiniCut – Full radius grooving and turning insert

CWX500

CWX500

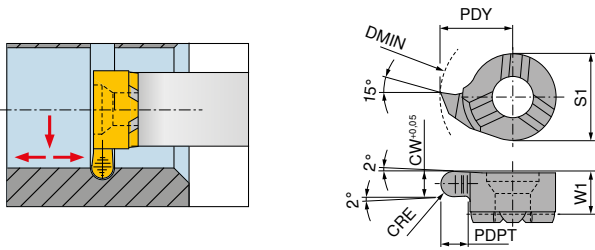

Illustrations show right-hand versions

Size	Designation	DMIN mm	CW mm	PDPT mm	W1 mm	PDY mm	S1 mm	CRE mm	Left-hand		Right-hand	
									73 320 ...	73 318 ...		
08	8,00. R/L .0,80.1,0	8	0.8	1.0	3.3	4.8	6.0	0.4	008		008	
	8,00. R/L .1,20.1,0	8	1.2	1.0	3.3	4.8	6.0	0.6	012		012	
	8,00. R/L .1,80.1,0	8	1.8	1.0	3.3	4.8	6.0	0.9	018		018	
	8,00. R/L .2,00.1,0	8	2.0	1.0	3.3	4.8	6.0	1.0	020		020	
09	9,00. R/L .0,80.1,6	9	0.8	1.6	3.6	5.5	6.2	0.4	108		108	
	9,00. R/L .1,20.1,6	9	1.2	1.6	3.6	5.5	6.2	0.6	112		112	
	9,00. R/L .1,80.1,6	9	1.8	1.6	3.6	5.5	6.2	0.9	118		118	
	9,00. R/L .2,00.1,6	9	2.0	1.6	3.6	5.5	6.2	1.0	120		120	
11	11,00. R/L .0,80.2,3	11	0.8	2.3	4.2	6.7	8.0	0.4	308		308	
	11,00. R/L .1,20.2,3	11	1.2	2.3	4.2	6.7	8.0	0.6	312		312	
	11,00. R/L .1,60.2,3	11	1.6	2.3	4.2	6.7	8.0	0.8	316		316	
	11,00. R/L .1,80.2,3	11	1.8	2.3	4.2	6.7	8.0	0.9	318		318	
	11,00. R/L .2,00.2,3	11	2.0	2.3	4.2	6.7	8.0	1.0	320		320	
	11,00. R/L .2,40.2,3	11	2.4	2.3	4.2	6.7	8.0	1.2	324		324	
14	14,00. R/L .0,80.4,0	14	0.8	4.0	5.3	9.0	9.0	0.4	508		508	
	14,00. R/L .1,20.4,0	14	1.2	4.0	5.3	9.0	9.0	0.6	512		512	
	14,00. R/L .1,80.4,0	14	1.8	4.0	5.3	9.0	9.0	0.9	518		518	
	14,00. R/L .2,00.4,0	14	2.0	4.0	5.3	9.0	9.0	1.0	520		520	
	14,00. R/L .2,20.4,0	14	2.2	4.0	5.3	9.0	9.0	1.1	522		522	
	14,00. R/L .3,00.4,0	14	3.0	4.0	5.3	9.0	9.0	1.5	530		530	
P									●		●	
M									●		●	
K									●		●	
N									●		●	
S									●		●	
H									●		●	
O									●		●	

→ v_c Page 339

MiniCut - Threading insert (Partial profile)

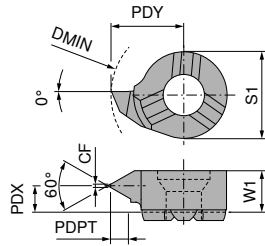
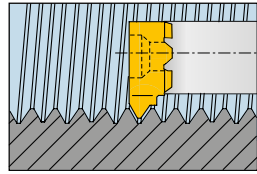
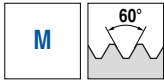

Illustrations show right-hand versions

Size	Designation	DMIN mm	TP mm	CF mm	PDPT mm	W1 mm	PDX mm	PDY mm	S1 mm	Left-hand	Right-hand
										73 344 ...	73 342 ...
08	8,00. R/L .0,5/0,75.60°	8	0,5 - 0,75	0,06	0,43	3,50	2,7	4,8	6,0	012	012
	8,00. R/L .1,0/1,25.60°	8	1,0 - 1,25	0,12	0,70	3,50	2,7	4,8	6,0	014	014
	8,00. R/L .1,5/1,75.60°	8	1,5 - 1,75	0,18	0,95	3,50	2,5	4,8	6,0	010	010
09	9,00. R/L .0,5/0,75.60°	9	0,5 - 0,75	0,06	0,27	3,55	3,2	5,5	6,2	112	112
	9,00. R/L .1,0/1,25.60°	9	1,0 - 1,25	0,12	0,54	3,55	3,0	5,5	6,2	114	114
	9,00. R/L .1,5/1,75.60°	9	1,5 - 1,75	0,18	0,81	3,55	2,8	5,5	6,2	116	116
	9,00. R/L .1,75/2,0.60°	9	1,75 - 2,0	0,20	0,95	3,55	2,6	5,5	6,2	118	118
	9,00. R/L .2,0/2,5.60°	9	2,0 - 2,5	0,25	1,08	3,55	2,5	5,5	6,2	120	120
	9,00. R/L .2,5/3,0.60°	9	2,5 - 3,0	0,31	1,35	3,55	2,1	5,5	6,2	122	122
	9,00. R/L .3,0/3,5.60°	9	3,0 - 3,5	0,37	1,62	3,55	1,9	5,5	6,2	124	124
11	11,00. R/L .0,5/0,75.60°	11	0,5 - 0,75	0,06	0,75	4,30	3,5	6,7	8,0	312	312
	11,00. R/L .1,0/1,25.60°	11	1,0 - 1,25	0,12	0,55	4,30	3,5	6,7	8,0	314	314
	11,00. R/L .1,5/1,75.60°	11	1,5 - 1,75	0,18	0,81	4,30	3,5	6,7	8,0	316	316
	11,00. R/L .2,0/2,5.60°	11	2,0 - 2,5	0,25	1,08	4,30	3,0	6,7	8,0	310	310
	11,00. R/L .2,5/3,0.60°	11	2,5 - 3,0	0,31	1,35	4,30	3,0	6,7	8,0	320	320
14	14,00. R/L .1,0/1,25.60°	14	1,0 - 1,25	0,12	0,55	5,40	4,7	9,0	9,0	512	512
	14,00. R/L .1,5/1,75.60°	14	1,5 - 1,75	0,18	0,81	5,40	4,5	9,0	9,0	514	514
	14,00. R/L .2,0/2,5.60°	14	2,0 - 2,5	0,25	1,08	5,40	4,2	9,0	9,0	510	510
	14,00. R/L .2,5/3,0.60°	14	2,5 - 3,0	0,31	1,35	5,40	4,7	9,0	9,0	520	520
P										•	•
M										•	•
K										•	•
N										•	•
S										•	•
H										•	•
O										•	•

→ v_c Page 339

3

MiniCut – Threading insert (Full profile)

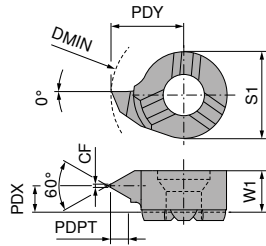
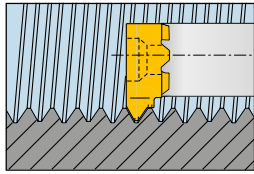
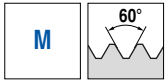

Illustrations show right-hand versions

Size	Designation	DMIN mm	TP mm	CF mm	PDPT mm	W1 mm	PDX mm	PDY mm	S1 mm	Left-hand		Right-hand	
										73 348 ...		73 346 ...	
09	9,00. R/L .0,5.60°	9	0.50	0.06	0.27	3.55	3.25	5.5	6.2		405		405
	9,00. R/L .1,0.60°	9	1.00	0.12	0.54	3.55	3.00	5.5	6.2		410		410
	9,00. R/L .1,5.60°	9	1.50	0.18	0.81	3.55	2.80	5.5	6.2		415		415
	9,00. R/L .1,75.60°	9	1.75	0.20	0.95	3.55	2.70	5.5	6.2		418		418
	9,00. R/L .2,0.60°	9	2.00	0.25	1.08	3.55	2.60	5.5	6.2		420		420
	9,00. R/L .2,5.60°	9	2.50	0.31	1.35	3.55	2.50	5.5	6.2		425		425
	9,00. R/L .3,0.60°	9	3.00	0.37	1.62	3.55	2.20	5.5	6.2		430		430
11	11,00. R/L .1,0.60°	11	1.00	0.12	0.54	4.30	3.50	6.7	8.0		314		314
	11,00. R/L .1,5.60°	11	1.50	0.18	0.81	4.30	3.50	6.7	8.0		316		316
	11,00. R/L .2,0.60°	11	2.00	0.25	1.08	4.30	3.20	6.7	8.0		310		310
	11,00. R/L .2,5.60°	11	2.50	0.31	1.35	4.30	3.00	6.7	8.0		320		320
	11,00. R/L .3,0.60°	11	3.00	0.37	1.62	4.30	2.90	6.7	8.0		330		330
14	14,00. R/L .0,5.60°	14	0.50	0.06	0.27	5.40	3.50	9.0	9.0		510		510
	14,00. R/L .1,0.60°	14	1.00	0.12	0.54	5.40	3.50	9.0	9.0		512		512
	14,00. R/L .1,5.60°	14	1.50	0.18	0.81	5.40	3.30	9.0	9.0		514		514
	14,00. R/L .2,0.60°	14	2.00	0.25	1.08	5.40	4.20	9.0	9.0		610		610
	14,00. R/L .2,5.60°	14	2.50	0.31	1.35	5.40	4.70	9.0	9.0		520		520
P										•		•	
M										•		•	
K										•		•	
N										•		•	
S										•		•	
H										•		•	
O										•		•	

→ v_c Page 339

MiniCut – Threading insert (Full profile)

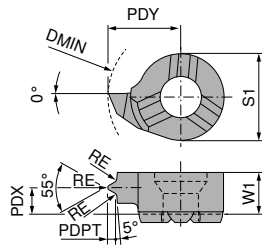
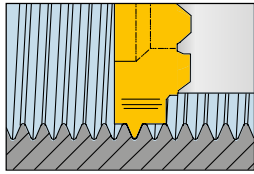

Illustrations show right-hand versions

Size	Designation	DMIN mm	TP mm	TPI 1/"	PDPT mm	W1 mm	PDX mm	PDY mm	S1 mm	RE mm	Left-hand		Right-hand	
											73 352 ...	73 350 ...	73 352 ...	73 350 ...
11	11,00. R/L .1,814.55°	11	1.814	14	1.16	4.30	3.0	6.7	8	0.24	306		306	
	11,00. R/L .1,337.55°	11	1.337	19	0.85	4.30	2.7	6.7	8	0.18	304		304	
14	14,00. R/L .1,814.55°	14	1.814	14	1.16	5.35	3.6	9.0	9	0.24	506		506	
	14,00. R/L .1,337.55°	14	1.337	19	0.85	5.35	3.8	9.0	9	0.18	504		504	
P											•		•	
M											•		•	
K											•		•	
N											•		•	
S											•		•	
H											•		•	
O											•		•	

→ v_c Page 339

MiniCut – Axial grooving insert

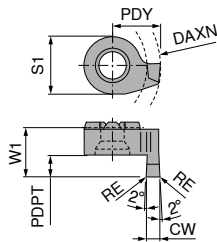
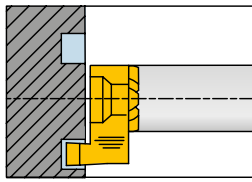

Illustrations show right-hand versions

Size	Designation	DAXN mm	CW mm	PDPT mm	W1 mm	PDY mm	RE mm	S1 mm
14	14,00. R/L .1,0,1,5	14	1.0	1.5	8.3	9		9
	14,00. R/L .1,5,2,5	14	1.5	2.5	8.3	9	0.2	9
	14,00. R/L .2,0,3,0	14	2.0	3.0	8.3	9	0.2	9
	14,00. R/L .2,0,5,0	14	2.0	5.0	10.3	9	0.2	9
	14,00. R/L .2,5,3,0	14	2.5	3.0	8.3	9	0.2	9
	14,00. R/L .2,5,5,0	14	2.5	5.0	10.3	9	0.2	9
	14,00. R/L .3,0,3,0	14	3.0	3.0	8.3	9	0.2	9
	14,00. R/L .3,0,5,0	14	3.0	5.0	10.3	9	0.2	9

Left-hand	Right-hand
73 364 ...	73 362 ...
510	510
515	515
520	520
620	620
525	525
625	625
530	530
630	630

P	•	•
M	•	•
K	•	•
N	•	•
S	•	•
H	•	•
O	•	•

→ v_c Page 339

MiniCut – Full radius axial grooving insert

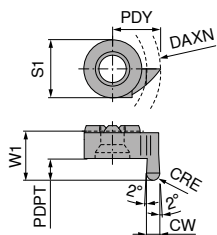
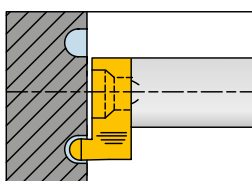

Illustrations show right-hand versions

Size	Designation	DAXN mm	CW mm	PDPT mm	W1 mm	PDY mm	CRE mm	S1 mm
14	14,00. R/L . 1,0,1,5	14	1.0	1.5	8.3	9	0.5	9
	14,00. R/L . 1,6,2,5	14	1.6	2.5	8.3	9	0.8	9
	14,00. R/L . 2,0,3,0	14	2.0	3.0	8.3	9	1.0	9
	14,00. R/L . 2,5,3,0	14	2.5	3.0	8.3	9	1.2	9
	14,00. R/L . 3,0,3,0	14	3.0	3.0	8.3	9	1.5	9

Left-hand	Right-hand
73 376 ...	73 374 ...
510	510
516	516
520	520
525	525
530	530

P	•	•
M	•	•
K	•	•
N	•	•
S	•	•
H	•	•
O	•	•

→ v_c Page 339

MiniCut – Axial grooving insert over a spigot

CWX500 CWX500

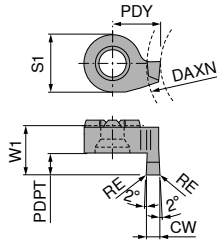
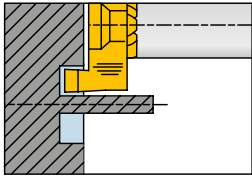

Illustrations show right-hand versions

Size	Designation	DAXN mm	CW mm	PDPT mm	W1 mm	PDY mm	RE mm	S1 mm	Left-hand	Right-hand
									73 360 ...	73 358 ...
14	14/12. R/L .1,0,1,5	12	1.0	1.5	8.3	7.0		9	310	310
	14/12. R/L .1,5,2,5	12	1.5	2.5	8.3	7.5	0.2	9	315	315
	14/12. R/L .2,0,3,0	12	2.0	3.0	8.3	8.0	0.2	9	320	320
	14/12. R/L .2,0,5,0	12	2.0	5.0	10.3	8.0	0.2	9	420	420
	14/12. R/L .2,5,3,0	12	2.5	3.0	8.3	8.5	0.2	9	325	325
	14/12. R/L .2,5,5,0	12	2.5	5.0	10.3	8.5	0.2	9	425	425
	14/12. R/L .3,0,3,0	12	3.0	3.0	8.3	9.0	0.2	9	330	330
	14/12. R/L .3,0,5,0	12	3.0	5.0	10.3	9.0	0.2	9	430	430
P									•	•
M									•	•
K									•	•
N									•	•
S									•	•
H									•	•
O									•	•

→ v_c Page 339

3

MiniCut – Steel Tool holder

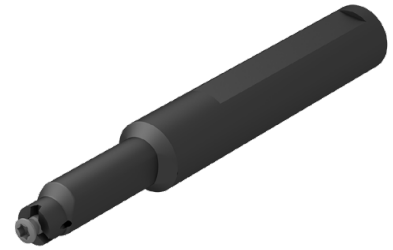
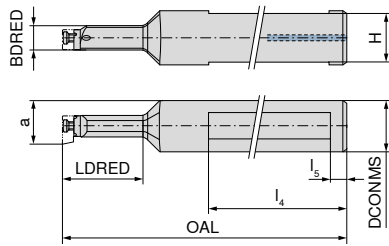

73 522 ...

Size	Designation	a mm	DCONMS ₁₇ mm	OAL mm	l ₄ mm	LDRED mm	BDRED mm	H mm	l ₅ mm
08	8,00/16.N.12.1,0	7.8	16	80	60	12	6.0	15.0	5
	8,00/16.N.22.1,0	7.8	16	90	60	22	6.0	15.0	5
09	9,00/16.N.14.1,8	8.6	16	95	60	14	7.4	15.0	5
	9,00/16.N.25.1,8	8.6	16	105	60	25	7.4	15.0	5
11	11,00/16.N.16.2,3	10.7	16	97	60	16	8.0	14.5	5
	11,00/16.N.29.2,3	10.7	16	110	60	29	8.0	14.5	5
14	14,00/16.N.18.4,0	13.8	16	100	60	18	11.0	14.5	5
	14,00/16.N.38.4,0	13.8	16	120	60	38	11.0	14.5	5

012

122

014

125

016

129

018

138

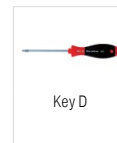

Key D



Clamping screw

80 950 ...

73 082 ...

Spare parts
Size

08	T08	110	M2,6	002
09	T08	110	M2,6	002
11	T10	112	M3,5	003
14	T15	113	M4	004

MiniCut – Solid Carbide Tool holder – vibration damped

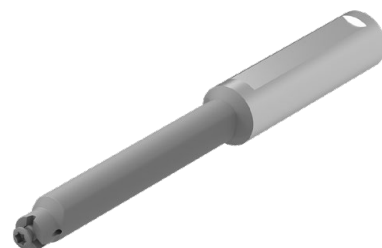
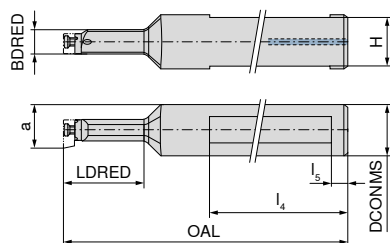

73 520 ...

Size	Designation	a mm	DCONMS _{r7} mm	OAL mm	l ₄ mm	LDRED mm	BDRED mm	H mm	l ₅ mm	
08	8,00/12.N.21.1,0 HM	7.8	12	80	48	21	6.0	11.0	5	021
	8,00/12.N.30.1,0 HM	7.8	12	90	48	30	6.0	11.0	5	030
	8,00/12.N.42.1,0 HM	7.8	12	100	48	42	6.0	11.0	5	042
	8,00/12.N.50.1,0 HM	7.8	12	115	48	50	6.0	11.0	5	050
09	9,00/12.N.22.1,0 HM	8.6	12	90	60	22	7.4	11.0	5	222
	9,00/12.N.30.2,0 HM	8.6	12	98	60	30	7.4	11.0	5	230
	9,00/12.N.42.3,0 HM	8.6	12	110	60	42	7.4	11.0	5	242
	9,00/12.N.56.4,0 HM	8.6	12	122	60	56	7.4	11.0	5	256
11	11,00/12.N.29.2,3 HM	10.7	12	95	60	29	8.0	10.5	5	129
	11,00/12.N.42.2,3 HM	10.7	12	110	60	42	8.0	10.5	5	142
	11,00/12.N.56.2,3 HM	10.7	12	120	60	56	8.0	10.5	5	156
	11,00/12.N.64.2,3 HM	10.7	12	130	60	64	8.0	10.5	5	164
14	14,00/12.N.34.4,0 HM	13.8	12	100	60	34	11.0	10.5	5	234
	14,00/12.N.45.4,0 HM	13.8	12	110	60	45	11.0	10.5	5	245
	14,00/12.N.64.4,0 HM	13.8	12	130	60	64	11.0	10.5	5	264
	14,00/16.N.34.4,0 HM	13.8	16	100	60	34	11.0	14.5	5	334
	14,00/16.N.45.4,0 HM	13.8	16	110	60	45	11.0	14.5	5	345
	14,00/16.N.64.4,0 HM	13.8	16	130	60	64	11.0	14.5	5	364
	14,00/16.N.75.4,0 HM	13.8	16	145	60	75	11.0	14.5	5	375

3

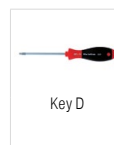

Key D



Clamping screw

80 950 ...

73 082 ...

Spare parts

Size				
08	T08	110	M2,6	002
09	T08	110	M2,6	002
11	T10	112	M3,5	003
14	T15	113	M4	004

MiniCut – HM – Flexoholder

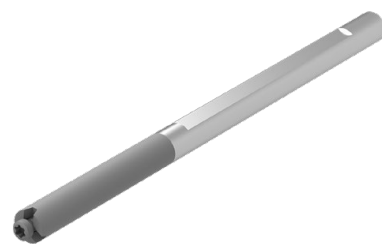
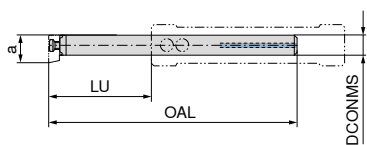

Size	Designation	DCONMS mm	OAL mm	LU mm	a mm
08	8,0/6.N16/2	6	65	18	8
	8,0/6.N40/4	6	103	40	8
11	11,0/8.N20/2	8	79	20	11
	11,0/8.N50/4	8	129	50	11

73 525 ...

818

840

120 ¹⁾

150 ¹⁾

1) with thro' coolant

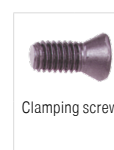
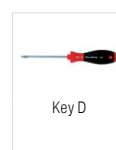

80 950 ...

73 082 ...

Spare parts

Size				
08	T08	110	M2,6	002
11	T10	112	M3,5	003

MiniCut – Base holder for solid carbide Flexoholder

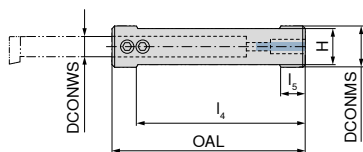

Size	Designation	DCONWS mm	DCONMS mm	H mm	OAL mm	l ₄ mm	l ₅ mm
08	8/16.75	6	16	14	75	55	10
	8/20.75	6	20	18	75	70	10
11	11/16.75	8	16	14	75	55	10
	11/20.75	8	20	18	75	70	10

73 526 ...

816

820

116

120

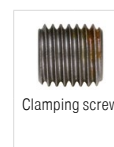
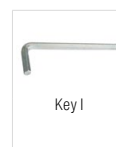

70 950 ...

73 082 ...

Spare parts for Article no.

73 526 816	SW2,5	175	M5x0,5x6	010
73 526 820	SW2,5	175	M5x0,5x6	010
73 526 116	SW2,5	175	M5x0,5x4	009
73 526 120	SW2,5	175	M5x0,5x6	010

MiniCut – Steel holder

▲ for axial machining

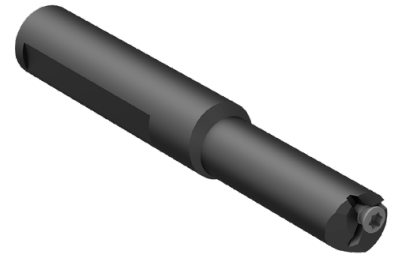
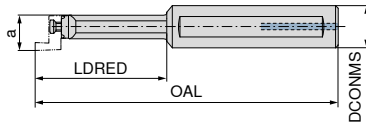

Size	Designation	a mm	DCONMS mm	OAL mm	LDRED mm	Left-hand		Right-hand	
						73 523 ...	025	73 524 ...	025
14	14,0/16. R/L .25.1,0	13.5	16	90	25	025		025	
	14,0/16. R/L .45.1,0	13.5	16	110	45	145		145	

Spare parts

Size

14	T15	80 950 ...	113	M4	73 082 ...	004
----	-----	------------	-----	----	------------	-----

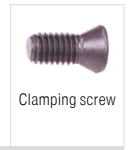
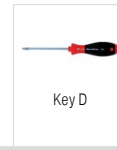

Material examples for cutting data tables

	Material sub-group	Index	Composition / Structure / Heat treatment	Tensile strength N/mm ² / HB / HRC	Material number	Material designation	Material number	Material designation
P	Unalloyed steel	P.1.1	< 0,15 % C Annealed	420 N/mm ² / 125 HB	1.0401	C15	1.1141	Ck15
		P.1.2	< 0,45 % C Annealed	640 N/mm ² / 190 HB	1.1191	C45E	1.0718	9SMnPb28
		P.1.3	< 0,45 % C Tempered	840 N/mm ² / 250 HB	1.1191	C45E	1.0535	C55
		P.1.4	< 0,75 % C Annealed	910 N/mm ² / 270 HB	1.1223	C60R	1.0535	C55
		P.1.5	< 0,75 % C Tempered	1010 N/mm ² / 300 HB	1.1223	C60R	1.0727	45S20
	Low-alloy steel	P.2.1	Annealed	610 N/mm ² / 180 HB	1.7131	16MnCr5	1.6587	17CrNiMo6
		P.2.2	Tempered	930 N/mm ² / 275 HB	1.7131	16MnCr5	1.6587	17CrNiMo6
		P.2.3	Tempered	1010 N/mm ² / 300 HB	1.7225	42CrMo4	1.3505	100Cr6
		P.2.4	Tempered	1200 N/mm ² / 375 HB	1.7225	42CrMo4	1.3505	100Cr6
	High-alloy steel and high-alloy tool steel	P.3.1	Annealed	680 N/mm ² / 200 HB	1.4021	X20Cr13	1.4034	X46Cr13
		P.3.2	Hardened and tempered	1100 N/mm ² / 300 HB	1.2343	X38CrMoV5-1	1.4034	X46Cr13
		P.3.3	Hardened and tempered	1300 N/mm ² / 400 HB	1.2343	X38CrMoV5-1	1.4034	X46Cr13
	Stainless steel	P.4.1	Ferritic / martensitic Annealed	680 N/mm ² / 200 HB	1.4016	X6Cr17	1.2316	X36CrMo16
		P.4.2	Martensitic Tempered	1010 N/mm ² / 300 HB	1.4112	X90CrMoV18	1.2316	X36CrMo16
M	Stainless steel	M.1.1	Austenitic / austenitic-ferritic Quenched	610 N/mm ² / 180 HB	1.4301	X5CrNi18-10	1.4571	X6CrNiMoTi17-12-2
		M.2.1	Austenitic Tempered	300 HB	1.4841	X15CrNiSi25-21	1.4539	X1NiCrMoCu25-20-5
		M.3.1	Austenitic / ferritic (Duplex)	780 N/mm ² / 230 HB	1.4462	X2CrNiMoN22-5-3	1.4501	X2CrNiMoCuWN25-7-4
K	Grey cast iron	K.1.1	Pearlitic / ferritic	350 N/mm ² / 180 HB	0.6010	GG-10	0.6025	GG-25
		K.1.2	Pearlitic (martensitic)	500 N/mm ² / 260 HB	0.6030	GG-30	0.6045	GG-45
	Spherulitic graphite cast iron	K.2.1	Ferritic	540 N/mm ² / 160 HB	0.7040	GGG-40	0.7060	GGG-60
		K.2.2	Pearlitic	845 N/mm ² / 250 HB	0.7070	GGG-70	0.7080	GGG-80
	Malleable iron	K.3.1	Ferritic	440 N/mm ² / 130 HB	0.8035	GTW-35-04	0.8045	GTW-45
		K.3.2	Pearlitic	780 N/mm ² / 230 HB	0.8165	GTS-65-02	0.8170	GTS-70-02
N	Aluminium wrought alloy	N.1.1	Non-hardenable	60 HB	3.0255	Al99,5	3.3315	AlMg1
		N.1.2	Hardenable Age-hardened	340 N/mm ² / 100 HB	3.1355	AlCuMg2	3.2315	AlMgSi1
	Cast aluminium alloy	N.2.1	≤ 12 % Si, non-hardenable	250 N/mm ² / 75 HB	3.2581	G-AlSi12	3.2163	G-AlSi9Cu3
		N.2.2	≤ 12 % Si, hardenable Age-hardened	300 N/mm ² / 90 HB	3.2134	G-AlSi5Cu1Mg	3.2373	G-AlSi9Mg
		N.2.3	> 12 % Si, non-hardenable	440 N/mm ² / 130 HB		G-AlSi17Cu4Mg		G-AlSi18CuNiMg
	Copper and copper alloys (bronze/brass)	N.3.1	Free-machining alloys, PB > 1 %	375 N/mm ² / 110 HB	2.0380	CuZn39Pb2 (Ms58)	2.0410	CuZn44Pb2
		N.3.2	CuZn, CuSnZn	300 N/mm ² / 90 HB	2.0331	CuZn15	2.4070	CuZn28Sn1As
		N.3.3	CuSn, lead-free copper and electrolytic copper	340 N/mm ² / 100 HB	2.0060	E-Cu57	2.0590	CuZn40Fe
	Magnesium alloys	N.4.1	Magnesium and magnesium alloys	70 HB	3.5612	MgAl6Zn	3.5312	MgAl3Zn
S	Heat-resistant alloys	S.1.1	Fe - basis Annealed	680 N/mm ² / 200 HB	1.4864	X12NiCrSi 36-16	1.4865	G-X40NiCrSi38-18
		S.1.2	Fe - basis Age-hardened	950 N/mm ² / 280 HB	1.4980	X6NiCrTiMoVB25-15-2	1.4876	X10NiCrAlTi32-20
		S.2.1	Ni or Co basis Annealed	840 N/mm ² / 250 HB	2.4631	NiCr20TiAl (Nimonic80A)	3.4856	NiCr22Mo9Nb
		S.2.2	Ni or Co basis Age-hardened	1180 N/mm ² / 350 HB	2.4668	NiCr19Nb5Mo3 (Inconel 718)	2.4955	NiFe25Cr20NbTi
		S.2.3	Ni or Co basis Cast	1080 N/mm ² / 320 HB	2.4765	CoCr20W15Ni	1.3401	G-X120Mn12
	Titanium alloys	S.3.1	Pure titanium	400 N/mm ²	3.7025	Ti99,8	3.7034	Ti99,7
		S.3.2	Alpha + beta alloys Age-hardened	1050 N/mm ² / 320 HB	3.7165	TiAl6V4	Ti-6246	Ti-6Al-2Sn-4Zr-6Mo
		S.3.3	Beta alloys	1400 N/mm ² / 410 HB	Ti555.3	Ti-5Al-5V-5Mo-3Cr	R56410	Ti-10V-2Fe-3Al
H	Hardened steel	H.1.1	Hardened and tempered	46-55 HRC				
		H.1.2	Hardened and tempered	56-60 HRC				
		H.1.3	Hardened and tempered	61-65 HRC				
		H.1.4	Hardened and tempered	66-70 HRC				
	Chilled iron	H.2.1	Cast	400 HB				
	Hardened cast iron	H.3.1	Hardened and tempered	55 HRC				
O	Non-metal materials	O.1.1	Plastics, duroplastic	≤ 150 N/mm ²				
		O.1.2	Plastics, thermoplastic	≤ 100 N/mm ²				
		O.2.1	Aramid fibre-reinforced	≤ 1000 N/mm ²				
		O.2.2	Glass/carbon-fibre reinforced	≤ 1000 N/mm ²				
		O.3.1	Graphite					

* Tensile strength

Cutting data standard values

Index	UltraMini K10F uncoated	UltraMini K10F-TiN	UltraMini K10-TiAlN	UltraMini DPX 57S	MiniCut CWX500	UltraMini TiAlN+	MiniCut CBN	UltraMini	MiniCut
	v _c in m/min							f in mm/rev.	
P.1.1		90	110	110	160	110			
P.1.2		80	100	100	140	100			
P.1.3		60	80	80	140	80			
P.1.4		60	80	80	110	80			
P.1.5		60	60	60	100	60			
P.2.1		60	80	80	110	80			
P.2.2		60	60	60	100	60			
P.2.3		50	60	60	90	60			
P.2.4		50	60	60	80	60			
P.3.1		50	60	60	80	60			
P.3.2		30	50	50	70	50			
P.3.3		30	30	30	50	30			
P.4.1		60	70	70	100	70			
P.4.2		50	60	60	90	60			
M.1.1		60	80	80	80	80			
M.2.1		50	60	60	70	60			
M.3.1		40	50	50	60	50			
K.1.1		80	100	100	90	100			
K.1.2		60	70	70	100	70			
K.2.1		60	60	60	80	60			
K.2.2		50	60	60	70	60			
K.3.1		80	100	100	120	100			
K.3.2		70	80	80	100	80			
N.1.1	100	200	230	230	290	230			
N.1.2	100	180	220	220	280	220			
N.2.1	90	160	190	190	240	190			
N.2.2	70	140	170	170	200	170			
N.2.3	50	80	100	100	120	100			
N.3.1	80	140	170	170	210	170			
N.3.2	70	120	140	140	180	140			
N.3.3	50	100	120	120	130	120			
N.4.1	50	100	120	120	100	120			
S.1.1		30	50	50	50	50			
S.1.2		30	30	30	30	30	30		
S.2.1		30	50	50	50	50	50		
S.2.2		30	30	30	40	30	30		
S.2.3			30	30	30	30	30		
S.3.1		30	50	50	50	50			
S.3.2		20	30	30	40	30			
S.3.3			20	20	30	20	20		
H.1.1		30	40	40	50	40	40		
H.1.2			30	30	40	30	30		
H.1.3				20		30	30		
H.1.4									
H.2.1									
H.3.1		20	30	30	40	30	30		
O.1.1	50	90	110	110	150	110			
O.1.2	50	100	120	120	150	120			
O.2.1		90	110	110	130	110			
O.2.2		60	80	80	100	80			
O.3.1	50	100	120	120	150	120			

Internal turning and profiling 0,02–0,05 0,03–0,10

Internal turning and profiling –
hard turning 0,02–0,06 0,03–0,10Turning and profile turning –
super alloys 0,02–0,08

Internal turning 0,02–0,05 0,01–0,03

Back boring 0,02–0,04 0,03–0,10

Turning and chamfering 0,01–0,03 0,03–0,10

Pre-parting and chamfering 0,01–0,02 0,01–0,03

Groove turning 0,01–0,02 0,01–0,03

Internal Undercuts 0,01–0,03 0,03–0,08

Groove and profile turning 0,01–0,02 0,01–0,03

Axial grooving 0,02–0,05 0,02–0,05



The cutting data is strongly influenced by external conditions, such as the stability of the tool and workpiece clamping, material and type of machine. The specified values represent guideline cutting data that can be adjusted by approx. ±20% according to the usage conditions.

Cutting data standard values – 73 000 .../ 73 001 ...

Index	UltraMini DPX77S v _c in m/min	Roughing										
		Ø ≤ 2 mm Corner radius in mm			Ø 2,5–4 mm Corner radius in mm				Ø ≥ 5 mm Corner radius in mm			
		0,05	0,1	0,15	0,05	0,1	0,15	0,2 / 0,4	0,05	0,1	0,15	0,2 / 0,4
		f in mm/rev.			f in mm/rev.				f in mm/rev.			
P.1.1	110	0,026–0,076	0,029–0,082	0,031–0,088	0,053–0,151	0,058–0,165	0,062–0,176	0,064–0,184	0,099–0,284	0,108–0,309	0,116–0,33	0,121–0,345
P.1.2	100	0,026–0,076	0,029–0,082	0,031–0,088	0,053–0,151	0,058–0,165	0,062–0,176	0,064–0,184	0,099–0,284	0,108–0,309	0,116–0,33	0,121–0,345
P.1.3	80	0,026–0,076	0,029–0,082	0,031–0,088	0,053–0,151	0,058–0,165	0,062–0,176	0,064–0,184	0,099–0,284	0,108–0,309	0,116–0,33	0,121–0,345
P.1.4	80	0,023–0,065	0,025–0,071	0,026–0,076	0,046–0,13	0,05–0,142	0,053–0,151	0,055–0,158	0,085–0,244	0,093–0,266	0,099–0,284	0,104–0,297
P.1.5	60	0,024–0,068	0,026–0,074	0,028–0,079	0,048–0,136	0,052–0,148	0,055–0,158	0,058–0,166	0,089–0,255	0,097–0,278	0,104–0,297	0,109–0,311
P.2.1	80	0,024–0,068	0,026–0,074	0,028–0,079	0,048–0,136	0,052–0,148	0,055–0,158	0,058–0,166	0,089–0,255	0,097–0,278	0,104–0,297	0,109–0,311
P.2.2	60	0,021–0,06	0,023–0,066	0,025–0,07	0,042–0,121	0,046–0,132	0,049–0,141	0,052–0,147	0,079–0,227	0,087–0,247	0,092–0,264	0,097–0,276
P.2.3	60	0,019–0,054	0,021–0,059	0,022–0,063	0,038–0,109	0,042–0,119	0,044–0,127	0,046–0,132	0,071–0,204	0,078–0,222	0,083–0,238	0,087–0,248
P.2.4	60	0,018–0,051	0,02–0,056	0,021–0,06	0,036–0,103	0,039–0,112	0,042–0,12	0,044–0,125	0,067–0,193	0,074–0,21	0,079–0,224	0,082–0,235
P.3.1	60	0,021–0,06	0,023–0,066	0,025–0,07	0,042–0,121	0,046–0,132	0,049–0,141	0,052–0,147	0,079–0,227	0,087–0,247	0,092–0,264	0,097–0,276
P.3.2	50	0,02–0,057	0,022–0,063	0,023–0,067	0,04–0,115	0,044–0,125	0,047–0,134	0,049–0,14	0,075–0,215	0,082–0,235	0,088–0,251	0,092–0,262
P.3.3	30	0,016–0,045	0,017–0,049	0,018–0,053	0,032–0,091	0,035–0,099	0,037–0,106	0,039–0,11	0,06–0,17	0,065–0,185	0,069–0,198	0,072–0,207
P.4.1	70	0,022–0,064	0,024–0,069	0,026–0,074	0,044–0,127	0,048–0,138	0,052–0,148	0,054–0,155	0,083–0,238	0,091–0,26	0,097–0,277	0,101–0,29
P.4.2	60	0,021–0,06	0,023–0,066	0,025–0,07	0,042–0,121	0,046–0,132	0,049–0,141	0,052–0,147	0,079–0,227	0,087–0,247	0,092–0,264	0,097–0,276
M.1.1	80	0,015–0,042	0,016–0,046	0,017–0,049	0,03–0,085	0,032–0,092	0,034–0,099	0,036–0,103	0,056–0,159	0,061–0,173	0,065–0,185	0,068–0,193
M.2.1	60	0,013–0,038	0,014–0,041	0,015–0,044	0,026–0,076	0,029–0,082	0,031–0,088	0,032–0,092	0,05–0,142	0,054–0,155	0,058–0,165	0,06–0,173
M.3.1	50	0,014–0,039	0,015–0,043	0,016–0,046	0,028–0,079	0,03–0,086	0,032–0,092	0,033–0,096	0,052–0,147	0,056–0,161	0,06–0,172	0,063–0,179
K.1.1	100	0,026–0,076	0,029–0,082	0,031–0,088	0,053–0,151	0,058–0,165	0,062–0,176	0,064–0,184	0,099–0,284	0,108–0,309	0,116–0,33	0,121–0,345
K.1.2	70	0,024–0,068	0,026–0,074	0,028–0,079	0,048–0,136	0,052–0,148	0,055–0,158	0,058–0,166	0,089–0,255	0,097–0,278	0,104–0,297	0,109–0,311
K.2.1	60	0,024–0,068	0,026–0,074	0,028–0,079	0,048–0,136	0,052–0,148	0,055–0,158	0,058–0,166	0,089–0,255	0,097–0,278	0,104–0,297	0,109–0,311
K.2.2	60	0,021–0,059	0,022–0,064	0,024–0,069	0,041–0,118	0,045–0,129	0,048–0,137	0,05–0,144	0,077–0,221	0,084–0,241	0,09–0,257	0,094–0,269
K.3.1	100	0,025–0,073	0,028–0,079	0,03–0,084	0,051–0,145	0,055–0,158	0,059–0,169	0,062–0,177	0,095–0,272	0,104–0,297	0,111–0,317	0,116–0,331
K.3.2	80	0,021–0,06	0,023–0,066	0,025–0,07	0,042–0,121	0,046–0,132	0,049–0,141	0,052–0,147	0,079–0,227	0,087–0,247	0,092–0,264	0,097–0,276
N.1.1	230	0,032–0,091	0,035–0,099	0,037–0,106	0,064–0,181	0,069–0,198	0,074–0,211	0,077–0,221	0,119–0,34	0,13–0,371	0,139–0,396	0,145–0,414
N.1.2	220	0,031–0,089	0,034–0,097	0,036–0,104	0,062–0,178	0,068–0,194	0,073–0,208	0,076–0,217	0,117–0,335	0,128–0,365	0,136–0,389	0,142–0,407
N.2.1	190	0,03–0,085	0,032–0,092	0,034–0,099	0,059–0,169	0,065–0,185	0,069–0,197	0,072–0,206	0,111–0,318	0,121–0,346	0,129–0,37	0,135–0,386
N.2.2	170	0,029–0,083	0,032–0,091	0,034–0,097	0,058–0,166	0,063–0,181	0,068–0,194	0,071–0,202	0,109–0,312	0,119–0,34	0,127–0,363	0,133–0,38
N.2.3	100	0,029–0,082	0,031–0,089	0,033–0,095	0,057–0,163	0,062–0,178	0,067–0,19	0,07–0,199	0,107–0,306	0,117–0,334	0,125–0,356	0,13–0,373
N.3.1	170	0,03–0,085	0,032–0,092	0,034–0,099	0,059–0,169	0,065–0,185	0,069–0,197	0,072–0,206	0,111–0,318	0,121–0,346	0,129–0,37	0,135–0,386
N.3.2	140	0,028–0,08	0,031–0,087	0,033–0,093	0,056–0,16	0,061–0,175	0,065–0,187	0,068–0,195	0,105–0,301	0,115–0,328	0,122–0,35	0,128–0,366
N.3.3	120	0,027–0,077	0,029–0,084	0,031–0,09	0,054–0,154	0,059–0,168	0,063–0,18	0,066–0,188	0,101–0,289	0,11–0,315	0,118–0,337	0,123–0,352
N.4.1	120	0,027–0,077	0,029–0,084	0,031–0,09	0,054–0,154	0,059–0,168	0,063–0,18	0,066–0,188	0,101–0,289	0,11–0,315	0,118–0,337	0,123–0,352
S.1.1	50	0,024–0,068	0,026–0,074	0,028–0,079	0,048–0,136	0,052–0,148	0,055–0,158	0,058–0,166	0,089–0,255	0,097–0,278	0,104–0,297	0,109–0,311
S.1.2	30	0,019–0,053	0,02–0,058	0,022–0,062	0,037–0,106	0,04–0,115	0,043–0,123	0,045–0,129	0,069–0,198	0,076–0,216	0,081–0,231	0,085–0,242
S.2.1	50	0,018–0,051	0,02–0,056	0,021–0,06	0,036–0,103	0,039–0,112	0,042–0,12	0,044–0,125	0,067–0,193	0,074–0,21	0,079–0,224	0,082–0,235
S.2.2	30	0,014–0,039	0,015–0,043	0,016–0,046	0,028–0,079	0,03–0,086	0,032–0,092	0,033–0,096	0,052–0,147	0,056–0,161	0,06–0,172	0,063–0,179
S.2.3	30	0,015–0,042	0,016–0,046	0,017–0,049	0,03–0,085	0,032–0,092	0,034–0,099	0,036–0,103	0,056–0,159	0,061–0,173	0,065–0,185	0,068–0,193
S.3.1	50	0,024–0,068	0,026–0,074	0,028–0,079	0,048–0,136	0,052–0,148	0,055–0,158	0,058–0,166	0,089–0,255	0,097–0,278	0,104–0,297	0,109–0,311
S.3.2	30	0,019–0,054	0,021–0,059	0,022–0,063	0,038–0,109	0,042–0,119	0,044–0,127	0,046–0,132	0,071–0,204	0,078–0,222	0,083–0,238	0,087–0,248
S.3.3	20	0,013–0,038	0,014–0,041	0,015–0,044	0,026–0,076	0,029–0,082	0,031–0,088	0,032–0,092	0,05–0,142	0,054–0,155	0,058–0,165	0,06–0,173
H.1.1	40	0,013–0,038	0,014–0,041	0,015–0,044	0,026–0,076	0,029–0,082	0,031–0,088	0,032–0,092	0,05–0,142	0,054–0,155	0,058–0,165	0,06–0,173
H.1.2	30	0,011–0,03	0,012–0,033	0,012–0,035	0,021–0,06	0,023–0,066	0,025–0,07	0,026–0,074	0,036–0,102	0,039–0,111	0,042–0,119	0,043–0,124
H.1.3												
H.1.4												
H.2.1	30	0,014–0,041	0,016–0,044	0,017–0,048	0,029–0,082	0,031–0,089	0,033–0,095	0,035–0,099	0,054–0,153	0,058–0,167	0,062–0,178	0,065–0,186
H.3.1	30	0,013–0,036	0,014–0,04	0,015–0,042	0,025–0,073	0,028–0,079	0,03–0,084	0,031–0,088	0,048–0,136	0,052–0,148	0,055–0,158	0,058–0,166
O.1.1	110	0,031–0,089	0,034–0,097	0,036–0,104	0,062–0,178	0,068–0,194	0,073–0,208	0,076–0,217	0,117–0,335	0,128–0,365	0,136–0,389	0,142–0,407
O.1.2	120	0,028–0,079	0,03–0,086	0,032–0,092	0,055–0,157	0,06–0,171	0,064–0,183	0,067–0,191	0,103–0,295	0,112–0,321	0,12–0,343	0,126–0,359
O.2.1	110	0,017–0,05	0,019–0,054	0,02–0,058	0,035–0,1	0,038–0,109	0,041–0,116	0,043–0,121	0,065–0,187	0,071–0,204	0,076–0,218	0,08–0,228
O.2.2	80	0,017–0,048	0,018–0,053	0,02–0,056	0,034–0,097	0,037–0,105	0,039–0,113	0,041–0,118	0,064–0,181	0,069–0,198	0,074–0,211	0,077–0,221
O.3.1	120											



The cutting data is strongly influenced by external conditions, such as the stability of the tool and workpiece clamping, material and type of machine. The specified values represent guideline cutting data that can be adjusted by approx. ±20% according to the usage conditions.

Finishing														
Index	Ø ≤ 2 mm Corner radius in mm			Ø 2,5–4 mm Corner radius in mm					Ø ≥ 5 mm Corner radius in mm					
	0,05	0,1	0,15	0,05	0,1	0,15	0,2	0,4	0,05	0,1	0,15	0,2	0,4	
	f in mm/rev.			f in mm/rev.					f in mm/rev.					
P.1.1	0.007-0.019	0.008-0.022	0.009-0.025	0.017-0.049	0.02-0.058	0.023-0.065	0.025-0.072	0.032-0.092	0.027-0.076	0.031-0.089	0.035-0.1	0.039-0.11	0.05-0.142	
P.1.2	0.007-0.019	0.008-0.022	0.009-0.025	0.017-0.049	0.02-0.058	0.023-0.065	0.025-0.072	0.032-0.092	0.027-0.076	0.031-0.089	0.035-0.1	0.039-0.11	0.05-0.142	
P.1.3	0.007-0.019	0.008-0.022	0.009-0.025	0.017-0.049	0.02-0.058	0.023-0.065	0.025-0.072	0.032-0.092	0.027-0.076	0.031-0.089	0.035-0.1	0.039-0.11	0.05-0.142	
P.1.4	0.006-0.016	0.007-0.019	0.008-0.022	0.015-0.042	0.017-0.05	0.02-0.056	0.022-0.061	0.028-0.079	0.023-0.065	0.027-0.077	0.03-0.086	0.033-0.095	0.043-0.122	
P.1.5	0.006-0.017	0.007-0.02	0.008-0.023	0.016-0.044	0.018-0.052	0.02-0.059	0.023-0.064	0.029-0.083	0.024-0.068	0.028-0.08	0.032-0.09	0.035-0.099	0.045-0.128	
P.2.1	0.006-0.017	0.007-0.02	0.008-0.023	0.016-0.044	0.018-0.052	0.02-0.059	0.023-0.064	0.029-0.083	0.024-0.068	0.028-0.08	0.032-0.09	0.035-0.099	0.045-0.128	
P.2.2	0.005-0.015	0.006-0.018	0.007-0.02	0.014-0.04	0.016-0.046	0.018-0.052	0.02-0.057	0.026-0.074	0.021-0.061	0.025-0.071	0.028-0.08	0.031-0.088	0.04-0.114	
P.2.3	0.005-0.014	0.006-0.016	0.006-0.018	0.012-0.036	0.015-0.042	0.016-0.047	0.018-0.051	0.023-0.066	0.019-0.055	0.022-0.064	0.025-0.072	0.028-0.079	0.036-0.102	
P.2.4	0.005-0.013	0.005-0.015	0.006-0.017	0.012-0.034	0.014-0.039	0.015-0.044	0.017-0.049	0.022-0.063	0.018-0.052	0.021-0.061	0.024-0.068	0.026-0.075	0.034-0.097	
P.3.1	0.005-0.015	0.006-0.018	0.007-0.02	0.014-0.04	0.016-0.046	0.018-0.052	0.02-0.057	0.026-0.074	0.021-0.061	0.025-0.071	0.028-0.08	0.031-0.088	0.04-0.114	
P.3.2	0.005-0.014	0.006-0.017	0.007-0.019	0.013-0.038	0.015-0.044	0.017-0.049	0.019-0.054	0.025-0.07	0.02-0.058	0.024-0.068	0.027-0.076	0.029-0.084	0.038-0.108	
P.3.3	0.004-0.011	0.005-0.013	0.005-0.015	0.01-0.03	0.012-0.035	0.014-0.039	0.015-0.043	0.019-0.055	0.016-0.046	0.019-0.053	0.021-0.06	0.023-0.066	0.03-0.085	
P.4.1	0.006-0.016	0.007-0.019	0.007-0.021	0.015-0.041	0.017-0.049	0.019-0.055	0.021-0.06	0.027-0.078	0.022-0.064	0.026-0.075	0.029-0.084	0.032-0.092	0.042-0.119	
P.4.2	0.005-0.015	0.006-0.018	0.007-0.02	0.014-0.04	0.016-0.046	0.018-0.052	0.02-0.057	0.026-0.074	0.021-0.061	0.025-0.071	0.028-0.08	0.031-0.088	0.04-0.114	
M.1.1	0.004-0.011	0.004-0.012	0.005-0.014	0.01-0.028	0.011-0.032	0.013-0.036	0.014-0.04	0.018-0.052	0.015-0.043	0.017-0.05	0.02-0.056	0.022-0.062	0.028-0.08	
M.2.1	0.003-0.01	0.004-0.011	0.004-0.013	0.009-0.025	0.01-0.029	0.011-0.033	0.013-0.036	0.016-0.046	0.013-0.038	0.016-0.045	0.018-0.05	0.019-0.055	0.025-0.071	
M.3.1	0.003-0.01	0.004-0.012	0.005-0.013	0.009-0.026	0.011-0.03	0.012-0.034	0.013-0.037	0.017-0.048	0.014-0.04	0.016-0.046	0.018-0.052	0.02-0.057	0.026-0.074	
K.1.1	0.007-0.019	0.008-0.022	0.009-0.025	0.017-0.049	0.02-0.058	0.023-0.065	0.025-0.072	0.032-0.092	0.027-0.076	0.031-0.089	0.035-0.1	0.039-0.11	0.05-0.142	
K.1.2	0.006-0.017	0.007-0.02	0.008-0.023	0.016-0.044	0.018-0.052	0.02-0.059	0.023-0.064	0.029-0.083	0.024-0.068	0.028-0.08	0.032-0.09	0.035-0.099	0.045-0.128	
K.2.1	0.006-0.017	0.007-0.02	0.008-0.023	0.016-0.044	0.018-0.052	0.02-0.059	0.023-0.064	0.029-0.083	0.024-0.068	0.028-0.08	0.032-0.09	0.035-0.099	0.045-0.128	
K.2.2	0.005-0.015	0.006-0.017	0.007-0.02	0.013-0.039	0.016-0.045	0.018-0.051	0.02-0.056	0.025-0.072	0.021-0.059	0.024-0.069	0.027-0.078	0.03-0.086	0.039-0.111	
K.3.1	0.006-0.018	0.007-0.021	0.008-0.024	0.017-0.047	0.019-0.056	0.022-0.062	0.024-0.069	0.031-0.089	0.026-0.073	0.03-0.085	0.034-0.096	0.037-0.106	0.048-0.136	
K.3.2	0.005-0.015	0.006-0.018	0.007-0.02	0.014-0.04	0.016-0.046	0.018-0.052	0.02-0.057	0.026-0.074	0.021-0.061	0.025-0.071	0.028-0.08	0.031-0.088	0.04-0.114	
N.1.1	0.008-0.023	0.009-0.027	0.011-0.03	0.02-0.058	0.024-0.068	0.027-0.077	0.03-0.084	0.038-0.109	0.027-0.076	0.031-0.089	0.035-0.1	0.039-0.11	0.05-0.142	
N.1.2	0.008-0.022	0.009-0.026	0.01-0.03	0.02-0.058	0.024-0.068	0.027-0.077	0.03-0.084	0.038-0.109	0.027-0.076	0.031-0.089	0.035-0.1	0.039-0.11	0.05-0.142	
N.2.1	0.007-0.021	0.009-0.025	0.01-0.028	0.019-0.055	0.023-0.065	0.025-0.073	0.028-0.08	0.036-0.103	0.027-0.076	0.031-0.089	0.035-0.1	0.039-0.11	0.05-0.142	
N.2.2	0.007-0.021	0.009-0.024	0.01-0.028	0.019-0.054	0.022-0.064	0.025-0.072	0.028-0.079	0.036-0.102	0.027-0.076	0.031-0.089	0.035-0.1	0.039-0.11	0.05-0.142	
N.2.3	0.007-0.021	0.008-0.024	0.009-0.027	0.019-0.053	0.022-0.062	0.025-0.07	0.027-0.077	0.035-0.1	0.027-0.076	0.031-0.089	0.035-0.1	0.039-0.11	0.05-0.142	
N.3.1	0.007-0.021	0.009-0.025	0.01-0.028	0.019-0.055	0.023-0.065	0.025-0.073	0.028-0.08	0.036-0.103	0.027-0.076	0.031-0.089	0.035-0.1	0.039-0.11	0.05-0.142	
N.3.2	0.007-0.02	0.008-0.024	0.009-0.027	0.018-0.052	0.021-0.061	0.024-0.069	0.027-0.076	0.034-0.098	0.027-0.076	0.031-0.089	0.035-0.1	0.039-0.11	0.05-0.142	
N.3.3	0.007-0.019	0.008-0.023	0.009-0.026	0.018-0.05	0.021-0.059	0.023-0.066	0.026-0.073	0.033-0.094	0.027-0.076	0.031-0.089	0.035-0.1	0.039-0.11	0.05-0.142	
N.4.1	0.007-0.019	0.008-0.023	0.009-0.026	0.018-0.05	0.021-0.059	0.023-0.066	0.026-0.073	0.033-0.094	0.027-0.078	0.032-0.091	0.036-0.102	0.039-0.112	0.051-0.145	
S.1.1	0.006-0.017	0.007-0.02	0.008-0.023	0.016-0.044	0.018-0.052	0.02-0.059	0.023-0.064	0.029-0.083	0.024-0.068	0.028-0.08	0.032-0.09	0.035-0.099	0.045-0.128	
S.1.2	0.005-0.013	0.005-0.016	0.006-0.018	0.012-0.035	0.014-0.04	0.016-0.046	0.018-0.05	0.023-0.065	0.019-0.053	0.022-0.062	0.025-0.07	0.027-0.077	0.035-0.099	
S.2.1	0.005-0.013	0.005-0.015	0.006-0.017	0.012-0.034	0.014-0.039	0.015-0.044	0.017-0.049	0.022-0.063	0.018-0.052	0.021-0.061	0.024-0.068	0.026-0.075	0.034-0.097	
S.2.2	0.003-0.01	0.004-0.012	0.005-0.013	0.009-0.026	0.011-0.03	0.012-0.034	0.013-0.037	0.017-0.048	0.014-0.04	0.016-0.046	0.018-0.052	0.02-0.057	0.026-0.074	
S.2.3	0.004-0.011	0.004-0.012	0.005-0.014	0.01-0.028	0.011-0.032	0.013-0.036	0.014-0.04	0.018-0.052	0.015-0.043	0.017-0.05	0.02-0.056	0.022-0.062	0.028-0.08	
S.3.1	0.006-0.017	0.007-0.02	0.008-0.023	0.016-0.044	0.018-0.052	0.02-0.059	0.023-0.064	0.029-0.083	0.024-0.068	0.028-0.08	0.032-0.09	0.035-0.099	0.045-0.128	
S.3.2	0.005-0.014	0.006-0.016	0.006-0.018	0.012-0.036	0.015-0.042	0.016-0.047	0.018-0.051	0.023-0.066	0.019-0.055	0.022-0.064	0.025-0.072	0.028-0.079	0.036-0.102	
S.3.3	0.003-0.01	0.004-0.011	0.004-0.013	0.009-0.025	0.01-0.029	0.011-0.033	0.013-0.036	0.016-0.046	0.013-0.038	0.016-0.045	0.018-0.05	0.019-0.055	0.025-0.071	
H.1.1	0.003-0.01	0.004-0.011	0.004-0.013	0.009-0.025	0.01-0.029	0.011-0.033	0.013-0.036	0.016-0.046	0.013-0.038	0.016-0.045	0.018-0.05	0.019-0.055	0.025-0.071	
H.1.2	0.003-0.008	0.003-0.009	0.004-0.01	0.007-0.02	0.008-0.023	0.009-0.026	0.01-0.029	0.013-0.037	0.011-0.03	0.012-0.036	0.014-0.04	0.015-0.044	0.02-0.057	
H.1.3														
H.1.4														
H.2.1	0.004-0.01	0.004-0.012	0.005-0.014	0.009-0.027	0.011-0.031	0.012-0.035	0.014-0.039	0.017-0.05	0.014-0.041	0.017-0.048	0.019-0.054	0.021-0.059	0.027-0.077	
H.3.1	0.003-0.009	0.004-0.011	0.004-0.012	0.008-0.024	0.01-0.028	0.011-0.031	0.012-0.034	0.016-0.044	0.013-0.036	0.015-0.043	0.017-0.048	0.018-0.053	0.024-0.068	
O.1.1	0.008-0.022	0.009-0.026	0.01-0.03	0.02-0.058	0.024-0.068	0.027-0.077	0.03-0.084	0.038-0.109	0.027-0.076	0.031-0.089	0.035-0.1	0.039-0.11	0.05-0.142	
O.1.2	0.007-0.02	0.008-0.023	0.009-0.026	0.018-0.051	0.021-0.06	0.024-0.068	0.026-0.074	0.034-0.096	0.028-0.079	0.032-0.093	0.036-0.104	0.04-0.114	0.052-0.148	
O.2.1	0.004-0.013	0.005-0.015	0.006-0.017	0.011-0.033	0.013-0.038	0.015-0.043	0.017-0.047	0.021-0.061	0.018-0.05	0.021-0.059	0.023-0.066	0.025-0.073	0.033-0.094	
O.2.2	0.004-0.012	0.005-0.014	0.006-0.016	0.011-0.032	0.013-0.037	0.015-0.042	0.016-0.046	0.021-0.059	0.017-0.049	0.02-0.057	0.022-0.064	0.025-0.07	0.032-0.091	
O.3.1														

Symbol explanation

UltraMini

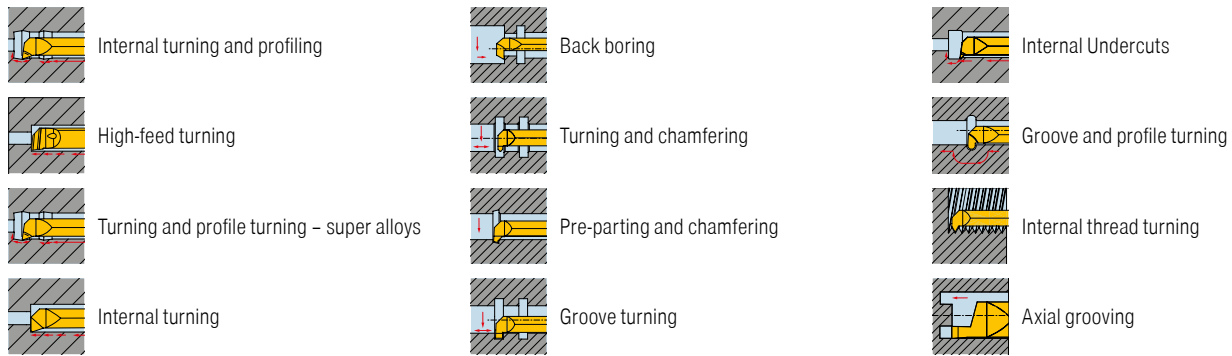

MiniCut

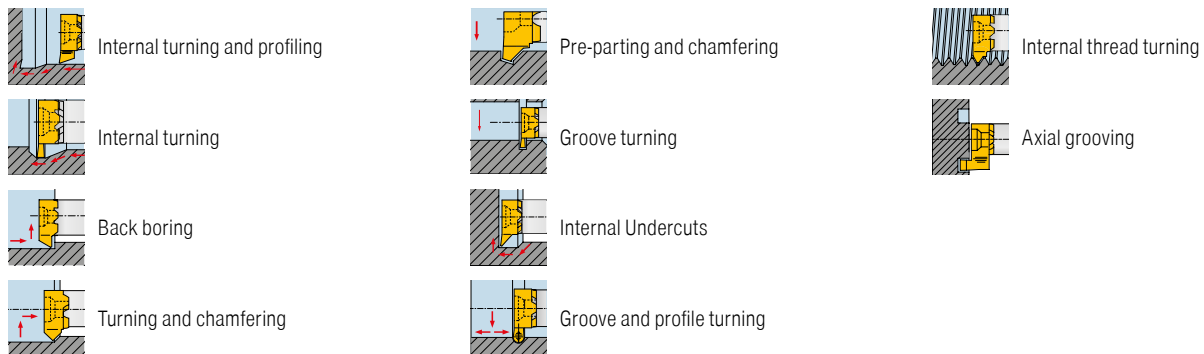

Coatings

TiN

- ▲ TiN coating
- ▲ Maximum application temperature: 450°C

DPX57S

- ▲ TiCrN coating
- ▲ Maximum application temperature: 900°C

DRAGONSKIN

TiAlN

- ▲ TiAlN multilayer coating
- ▲ Maximum application temperature: 900°C

DPX77S

- ▲ TiAlN+X-coating
- ▲ Maximum application temperature: 900°C

DRAGONSKIN

CWX500

- ▲ Carbide, TiAlN-coated
- ▲ The universal carbide grade for almost all materials

Thread types

M Metric ISO standard thread

MF Metric ISO fine thread

G Whitworth thread

Tr Metric ISO trapezoidal fine thread

Thread flank angle

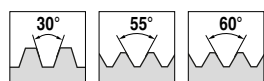

Cooling



DRAGONSKIN



Machining without compromise

The product category Dragonskin is intended to help make tools easily recognizable and quick to find using CERATIZIT's high-performance coating technology. All products that are marked with the Dragonskin icon represent unmatched performance, maximum tool life and maximum process reliability.

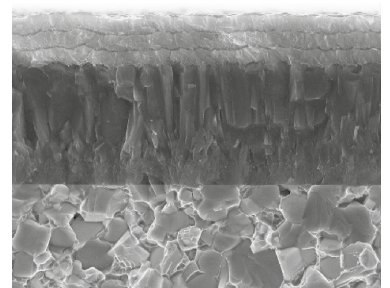

Dragonskin Coating





Solid drilling and bore machining

HSS drilling

Solid carbide drilling

Reamers

1

Threading

HSS taps

Circular and Thread Milling

Thread turning

2

Turning

Turning Tools

Multi-function tool - EcoCut

Grooving Tools

Miniature turning tools

3

Milling

Solid Carbide milling cutters

4

Workholding

Collets and reduction sleeves

5

Material examples and
article no. index

6

Table of contents

Overview	2
Toolfinder	3
Symbol explanation	3
Highlights	4
List of contents	5
Product programme	
Solid carbide end mills	6–14
Circular saw blades	15+16
Adapters for circular saw blades	17+18
Cutting Data	
Solid carbide end mills	19–37
Circular saw blades	38
Technical Information	
Solid carbide end mills	39–41
Coatings	42

WNT \ Performance

Premium quality tools for high performance.

The premium quality tools from the **WNT Performance** product line have been designed for specific applications and are distinguished by their outstanding performance. If you make high demands on the performance of your production and want to achieve the very best results, we recommend the Premium tools in this product line.

WNT \ Standard

Quality tools for standard applications.

The quality tools of the **WNT Standard** product line are high quality, powerful and reliable and enjoy the highest trust of our customers worldwide. Tools from this product line are the first choice for many standard applications and guarantee optimal results.

Overview

Solid carbide end mills

- ▲ Selection of high-performance solid carbide milling cutters from the Performance and Standard product lines.



Circular saw blades

- ▲ Diameters ranging from 15 mm–63 mm with widths of 0.2 mm–6.0 mm
- ▲ Conforms to DIN 1837-A (fine-toothed)

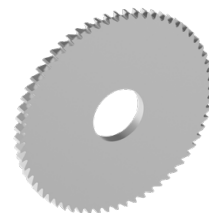

Adapters for circular saw blades

- ▲ Interfaces perfectly tailored to circular saw blades

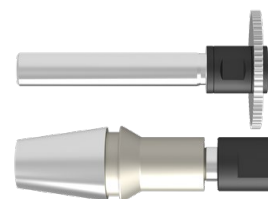

Toolfinder

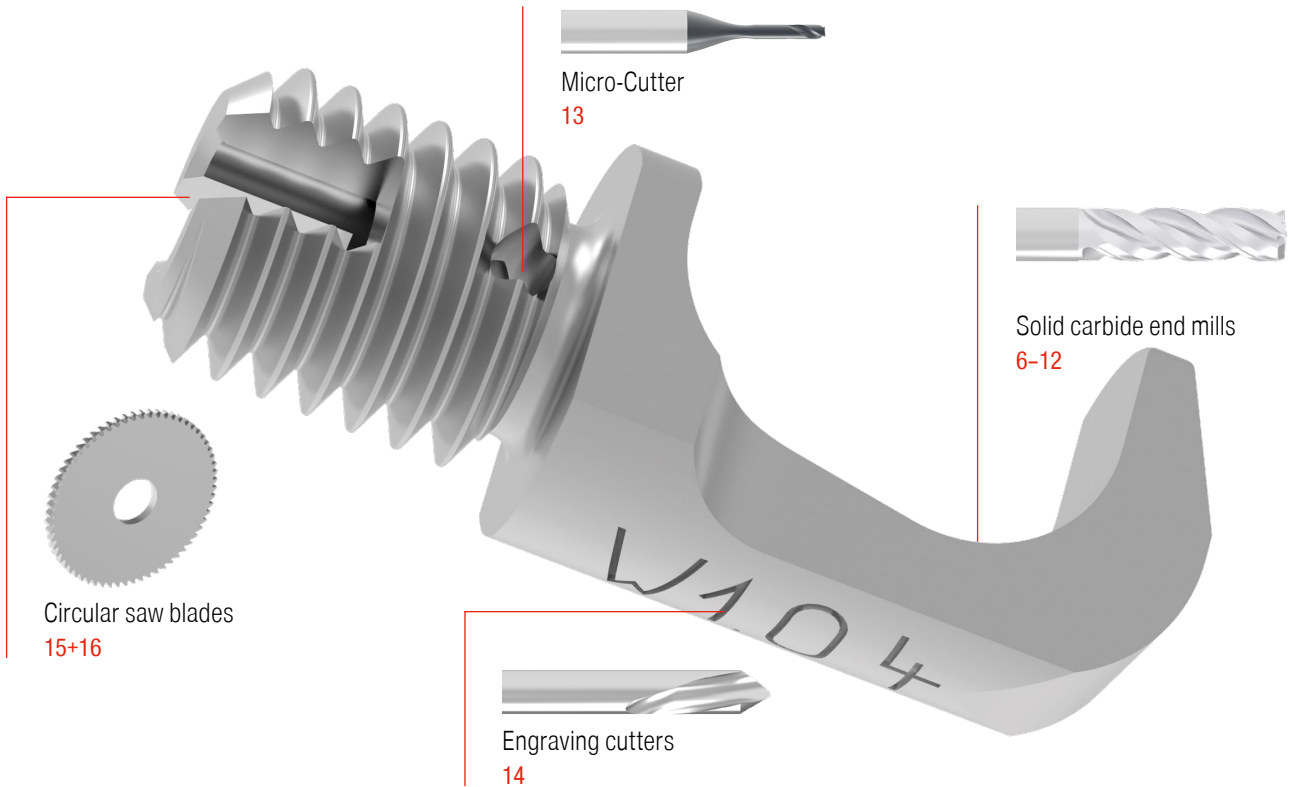

Symbol explanation

Shank

- Shank type
- Length:** extra short / short / medium / long / extra long
- Axial thro' coolant
- Radial thro' coolant

Application

- High volume machining
- Hard materials
- The red arrows describe the possible feed directions
- Number of flutes
- Cutting geometry
 $\lambda_s = 48^\circ$
 $\lambda_s =$ Helix Angle
 $\gamma_s = 10^\circ$
 $\gamma_s =$ Rake Angle

Cutting edge preparation

- Sharp
- Corner chamfer (CHW = chamfer width in mm)
- Corner radius

- = Main Application
- = Extended application

Type of machining

- Peripheral milling
- Engraving
- Helical plunging
- Circular saw blades
- Ramping
- Multipurpose milling
- Full slot
- Plunge milling



Highlights

SilverLine

Latest Dragonskin coating DPB72S – high temperature resistance and ideally suited for dry machining

Optimised core geometry – significantly reduced vibrations

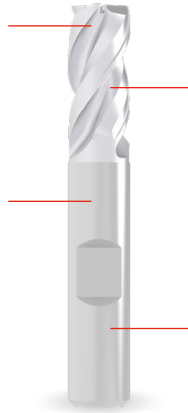

Redesigned cutting edge geometry – optimised chip flow and chip removal

Reinforced core diameter – optimal tool stability

AluLine

Extremely long tool service life possible thanks to the wear-resistant DLC coating.

Optimal/versatile tool selection for almost all applications in the machining of non-ferrous metals.

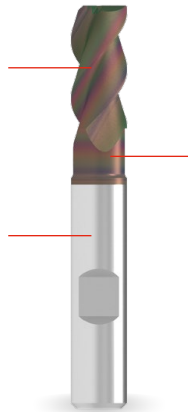

Economical and process-secure machining of aluminium and non-ferrous metals. Optimal performance thanks to the perfectly coordinated combination of geometry, substrate and coating.

Micro-End Mill

Robust and resilient Dragonskin DPA72S coating – can be used in material hardnesses up to 55 HRC.

Optimised neck geometry – for maximum tool stability

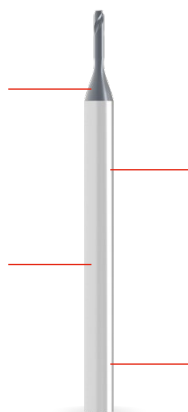

Latest generation of adapted carbide – guarantees high flexural strength

Shank tolerance h5 – for optimal radial run-out accuracy

Overview of solid carbide milling cutters

Tool type	Number of flutes	Diameter in mm	Material	Sharp	Corner chamfer	Corner radius	Length	Tool design	Cooling	Performance	Standard
		Ø DC	Steel Stainless steel Cast iron Non-ferrous metals Heat-resistant Tempered steel Non metal materials	<input type="checkbox"/>	<input type="checkbox"/>	<input type="checkbox"/>			<input checked="" type="checkbox"/> coated <input type="checkbox"/> uncoated	<input checked="" type="checkbox"/> Performance	<input checked="" type="checkbox"/> Standard

SilverLine - End Mills

	N	3	3-12	<input checked="" type="checkbox"/> Steel <input checked="" type="checkbox"/> Stainless steel <input checked="" type="checkbox"/> Cast iron <input type="checkbox"/> Non-ferrous metals <input type="checkbox"/> Heat-resistant <input type="checkbox"/> Tempered steel <input type="checkbox"/> Non metal materials	<input type="checkbox"/>	<input type="checkbox"/>		HPC	<input checked="" type="checkbox"/>	6
	N	4	3-12	<input checked="" type="checkbox"/> Steel <input checked="" type="checkbox"/> Stainless steel <input checked="" type="checkbox"/> Cast iron <input type="checkbox"/> Non-ferrous metals <input type="checkbox"/> Heat-resistant <input type="checkbox"/> Tempered steel <input type="checkbox"/> Non metal materials	<input type="checkbox"/>	<input type="checkbox"/>		HPC	<input checked="" type="checkbox"/>	7

AluLine

	W	2	2-12	<input type="checkbox"/> Steel <input type="checkbox"/> Stainless steel <input type="checkbox"/> Cast iron <input checked="" type="checkbox"/> Non-ferrous metals <input type="checkbox"/> Heat-resistant <input type="checkbox"/> Tempered steel <input type="checkbox"/> Non metal materials	<input type="checkbox"/>	<input type="checkbox"/>			<input checked="" type="checkbox"/>	8
	W	3	2-12	<input type="checkbox"/> Steel <input type="checkbox"/> Stainless steel <input type="checkbox"/> Cast iron <input checked="" type="checkbox"/> Non-ferrous metals <input type="checkbox"/> Heat-resistant <input type="checkbox"/> Tempered steel <input type="checkbox"/> Non metal materials	<input type="checkbox"/>	<input type="checkbox"/>			<input checked="" type="checkbox"/>	9+10

End Mills with Finishing Geometry

	N	4	3-12	<input checked="" type="checkbox"/> Steel <input checked="" type="checkbox"/> Stainless steel <input type="checkbox"/> Cast iron <input type="checkbox"/> Non-ferrous metals <input type="checkbox"/> Heat-resistant <input type="checkbox"/> Tempered steel <input type="checkbox"/> Non metal materials	<input type="checkbox"/>	<input type="checkbox"/>		HPC	<input checked="" type="checkbox"/>	11
	N	4	3-12	<input checked="" type="checkbox"/> Steel <input type="checkbox"/> Stainless steel <input type="checkbox"/> Cast iron <input checked="" type="checkbox"/> Non-ferrous metals <input type="checkbox"/> Heat-resistant <input type="checkbox"/> Tempered steel <input type="checkbox"/> Non metal materials	<input type="checkbox"/>	<input type="checkbox"/>		HPC	<input checked="" type="checkbox"/>	12

Micro-Cutter

	N	2	0,2-2	<input checked="" type="checkbox"/> Steel <input checked="" type="checkbox"/> Stainless steel <input checked="" type="checkbox"/> Cast iron <input checked="" type="checkbox"/> Non-ferrous metals <input type="checkbox"/> Heat-resistant <input type="checkbox"/> Tempered steel <input type="checkbox"/> Non metal materials	<input type="checkbox"/>	<input type="checkbox"/>			<input checked="" type="checkbox"/>	13
--	---	---	-------	---	--------------------------	--------------------------	--	--	-------------------------------------	----

Engraving cutter 60°

	W	1	3-6	<input type="checkbox"/> Steel <input type="checkbox"/> Stainless steel <input type="checkbox"/> Cast iron <input type="checkbox"/> Non-ferrous metals <input type="checkbox"/> Heat-resistant <input type="checkbox"/> Tempered steel <input checked="" type="checkbox"/> Non metal materials	<input type="checkbox"/>	<input type="checkbox"/>			<input type="checkbox"/>	14
--	---	---	-----	--	--------------------------	--------------------------	--	--	--------------------------	----

Circular saw blades

		24-160	15-63	<input checked="" type="checkbox"/> Steel <input checked="" type="checkbox"/> Stainless steel <input checked="" type="checkbox"/> Cast iron <input checked="" type="checkbox"/> Non-ferrous metals <input type="checkbox"/> Heat-resistant <input type="checkbox"/> Tempered steel <input type="checkbox"/> Non metal materials	<input type="checkbox"/>	<input type="checkbox"/>			<input type="checkbox"/>	15+16
--	--	--------	-------	---	--------------------------	--------------------------	--	--	--------------------------	-------

Adapters for circular saw blades

					<input type="checkbox"/>	<input type="checkbox"/>					17
					<input type="checkbox"/>	<input type="checkbox"/>					18

More milling tools can be found in our → **main catalogue in chapters 13-15**

SilverLine – End milling cutter

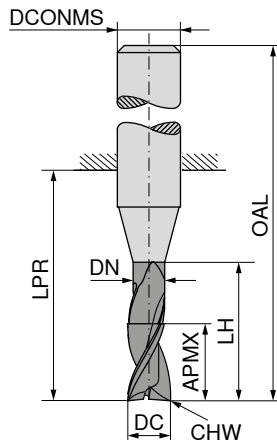
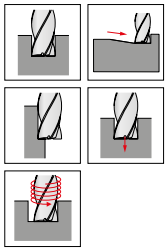

DC ₁₈ mm	APMX mm	DN mm	LH mm	LPR mm	OAL mm	DCONMS _{h6} mm	CHW mm	ZEFP
3.0	8	2.9	15	21	57	6	0.1	3
3.5	11	3.4	16	21	57	6	0.1	3
4.0	8	3.9	15	18	54	6	0.1	3
4.0	11	3.9	16	21	57	6	0.1	3
4.5	13	4.4	19	21	57	6	0.1	3
5.0	9	4.9	16	18	54	6	0.1	3
5.0	13	4.9	19	21	57	6	0.1	3
5.5	13	5.4	19	21	57	6	0.1	3
6.0	10	5.9	17	18	54	6	0.2	3
6.0	13	5.9	19	21	57	6	0.2	3
6.5	19	6.3	25	27	63	8	0.2	3
7.0	19	6.8	25	27	63	8	0.2	3
7.5	19	7.3	25	27	63	8	0.2	3
8.0	12	7.8	20	22	58	8	0.2	3
8.0	19	7.8	25	27	63	8	0.2	3
8.5	22	8.2	30	32	72	10	0.2	3
9.0	22	8.7	30	32	72	10	0.2	3
9.5	22	9.2	30	32	72	10	0.2	3
10.0	14	9.7	24	26	66	10	0.2	3
10.0	22	9.7	30	32	72	10	0.2	3
12.0	16	11.7	26	28	73	12	0.2	3
12.0	26	11.7	36	38	83	12	0.2	3

	50 966 ...	50 966 ...
P	●	●
M	●	●
K	●	●
N	○	○
S	●	●
H		
O		

→ v_c/f_z Page 20+21

SilverLine – End milling cutter

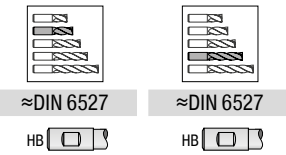
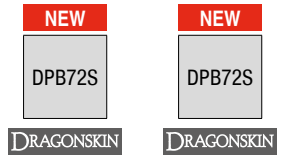
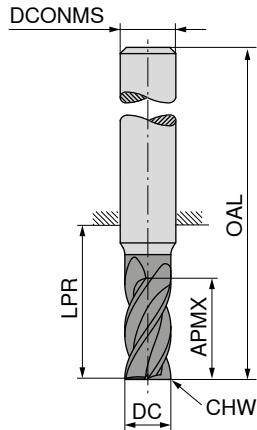
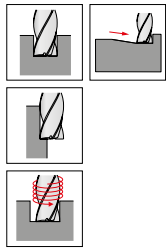

50 973 ... 50 973 ...

DC ₁₈ mm	APMX mm	LPR mm	OAL mm	DCONMS _{h6} mm	CHW mm	ZEFP
3.0	5	14	50	6	0.1	4
3.0	8	21	57	6	0.1	4
3.5	8	18	54	6	0.1	4
3.5	11	21	57	6	0.1	4
4.0	8	18	54	6	0.1	4
4.0	11	21	57	6	0.1	4
4.5	9	18	54	6	0.1	4
4.5	13	21	57	6	0.1	4
5.0	9	18	54	6	0.1	4
5.0	13	21	57	6	0.1	4
5.5	10	18	54	6	0.1	4
5.5	13	21	57	6	0.1	4
6.0	10	18	54	6	0.1	4
6.0	13	21	57	6	0.1	4
7.0	12	22	58	8	0.2	4
7.0	21	27	63	8	0.2	4
8.0	12	22	58	8	0.2	4
8.0	21	27	63	8	0.2	4
9.0	14	26	66	10	0.2	4
9.0	22	32	72	10	0.2	4
10.0	14	26	66	10	0.2	4
10.0	22	32	72	10	0.2	4
11.0	16	28	73	12	0.3	4
11.0	26	38	83	12	0.3	4
12.0	16	28	73	12	0.3	4

P	●	●
M	●	●
K	●	●
N	○	○
S	●	●
H		
O		

→ v_c/f_z Page 22+23

4

AluLine – End milling cutter

▲ With polished chip flutes

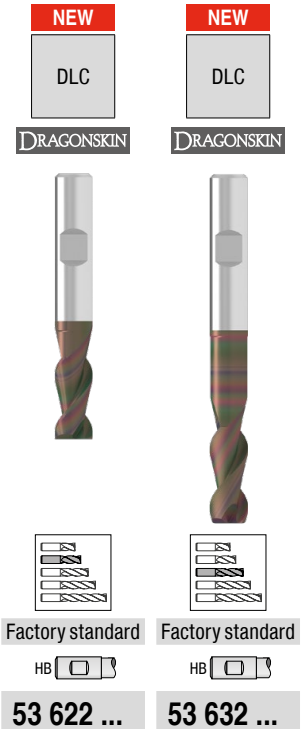
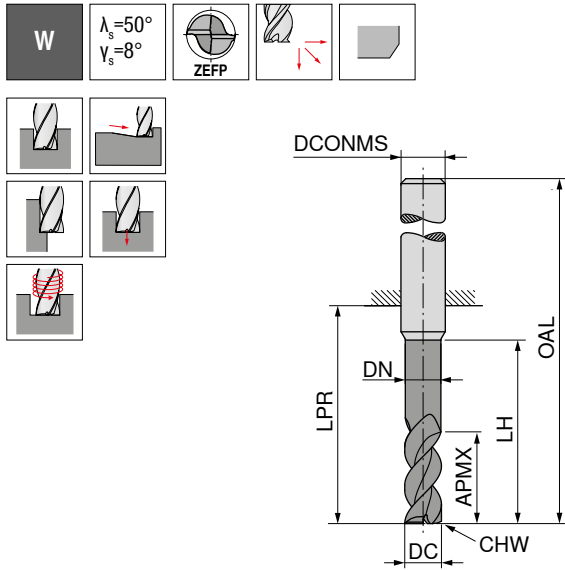

DC _{h6}	APMX	DN	LH	LPR	OAL	DCONMS _{h6}	CHW	ZEFP	53 622 ...	53 632 ...
mm	mm	mm	mm	mm	mm	mm	mm			
2.0	5.5	1.8	10.0	19	55	6	0.05	2		02300
2.5	6.5	2.3	12.5	22	58	6	0.05	2		02800
3.0	8.0	2.8	15.0	22	58	6	0.10	2		03300
3.5	10.5	3.3	20.0	26	62	6	0.10	2		03800
4.0	10.5	3.8	20.0	26	62	6	0.10	2		04300
4.5	13.0	4.3	25.0	34	70	6	0.10	2		04800
5.0	10.5	4.8	15.0	22	58	6	0.10	2	05100	
5.0	13.0	4.8	25.0	34	70	6	0.10	2		05300
5.5	13.0	5.3	18.0	22	58	6	0.10	2	05600	
5.5	16.0	5.3	30.0	34	70	6	0.10	2		05800
6.0	13.0	5.8	18.0	22	58	6	0.10	2	06100	
6.0	16.0	5.8	30.0	34	70	6	0.10	2		06300
6.5	17.0	6.2	24.0	28	64	8	0.10	2	06600	
6.5	21.0	6.2	40.0	44	80	8	0.10	2		06800
7.0	17.0	6.7	24.0	28	64	8	0.10	2	07100	
7.0	21.0	6.7	40.0	44	80	8	0.10	2		07300
7.5	17.0	7.2	24.0	28	64	8	0.10	2	07600	
7.5	21.0	7.2	40.0	44	80	8	0.10	2		07800
8.0	17.0	7.7	24.0	28	64	8	0.10	2	08100	
8.0	21.0	7.7	40.0	44	80	8	0.10	2		08300
8.5	21.0	8.2	30.0	34	74	10	0.10	2	08600	
8.5	26.0	8.2	50.0	54	94	10	0.10	2		08800
9.0	21.0	8.7	30.0	34	74	10	0.10	2	09100	
9.0	26.0	8.7	50.0	54	94	10	0.10	2		09300
9.5	21.0	9.2	30.0	34	74	10	0.10	2	09600	
9.5	26.0	9.2	50.0	54	94	10	0.10	2		09800
10.0	21.0	9.7	30.0	34	74	10	0.10	2	10100	
10.0	26.0	9.7	50.0	54	94	10	0.10	2		10300
10.5	25.0	10.1	36.0	40	85	12	0.10	2	10600	
10.5	31.0	10.1	60.0	64	109	12	0.10	2		10800
11.0	25.0	10.6	36.0	40	85	12	0.10	2	11100	
11.0	31.0	10.6	60.0	64	109	12	0.10	2		11300
11.5	25.0	11.1	36.0	40	85	12	0.10	2	11600	
11.5	31.0	11.1	60.0	64	109	12	0.10	2		11800
12.0	25.0	11.6	36.0	40	85	12	0.10	2	12100	
12.0	31.0	11.6	60.0	64	109	12	0.10	2		12300

P	
M	
K	
N	•
S	•
H	
O	

→ v_c/f_z Page 24+25

AluLine – End milling cutter

▲ With polished chip flutes

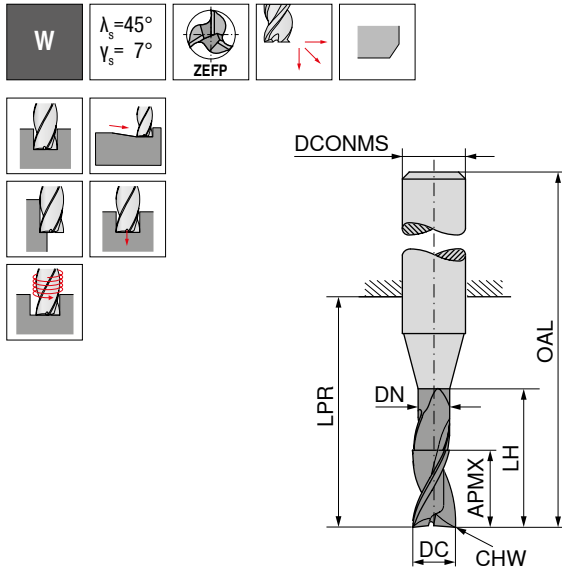

DC _{h6} mm	APMX mm	DN mm	LH mm	LPR mm	OAL mm	DCONMS _{h6} mm	CHW mm	ZEFP
2.0	4.5	1.8	6.0	14	50	6	0.05	3
2.0	5.5	1.8	10.0	19	55	6	0.05	3
2.5	5.5	2.3	7.5	19	55	6	0.05	3
2.5	6.5	2.3	12.5	22	58	6	0.05	3
3.0	6.5	2.8	9.0	19	55	6	0.10	3
3.0	8.0	2.8	15.0	22	58	6	0.10	3
3.5	8.5	3.3	12.0	19	55	6	0.10	3
3.5	10.5	3.3	20.0	26	62	6	0.10	3
4.0	8.5	3.8	12.0	19	55	6	0.10	3
4.0	10.5	3.8	20.0	26	62	6	0.10	3
4.5	10.5	4.3	15.0	22	58	6	0.10	3
4.5	13.0	4.3	25.0	34	70	6	0.10	3
5.0	10.5	4.8	15.0	22	58	6	0.10	3
5.0	13.0	4.8	25.0	34	70	6	0.10	3
5.5	13.0	5.3	18.0	22	58	6	0.10	3
5.5	16.0	5.3	30.0	34	70	6	0.10	3
6.0	13.0	5.8	18.0	22	58	6	0.20	3
6.0	16.0	5.8	30.0	34	70	6	0.20	3
6.5	17.0	6.2	24.0	28	64	8	0.20	3
6.5	21.0	6.2	40.0	44	80	8	0.20	3
7.0	17.0	6.7	24.0	28	64	8	0.20	3
7.0	21.0	6.7	40.0	44	80	8	0.20	3
7.5	17.0	7.2	24.0	28	64	8	0.20	3
7.5	21.0	7.2	40.0	44	80	8	0.20	3
8.0	17.0	7.7	24.0	28	64	8	0.20	3
8.0	21.0	7.7	40.0	44	80	8	0.20	3
8.5	21.0	8.2	30.0	34	74	10	0.20	3
8.5	26.0	8.2	50.0	54	94	10	0.20	3
9.0	21.0	8.7	30.0	34	74	10	0.20	3
9.0	26.0	8.7	50.0	54	94	10	0.20	3
9.5	21.0	9.2	30.0	34	74	10	0.20	3
9.5	26.0	9.2	50.0	54	94	10	0.20	3
10.0	21.0	9.7	30.0	34	74	10	0.20	3
10.0	26.0	9.7	50.0	54	94	10	0.20	3
10.5	25.0	10.1	36.0	40	85	12	0.20	3
10.5	31.0	10.1	60.0	64	109	12	0.20	3

53 614 ...	53 614 ...
02100	02200
02600	02700
03100	03200
03600	03700
04100	04200
04600	04700
05100	05200
05600	05700
06100	06200
06600	06700
07100	07200
07600	07700
08100	08200
08600	08700
09100	09200
09600	09700
10100	10200
10600	10700

P
M
K
N
S
H
O

AluLine – End milling cutter

▲ With polished chip flutes

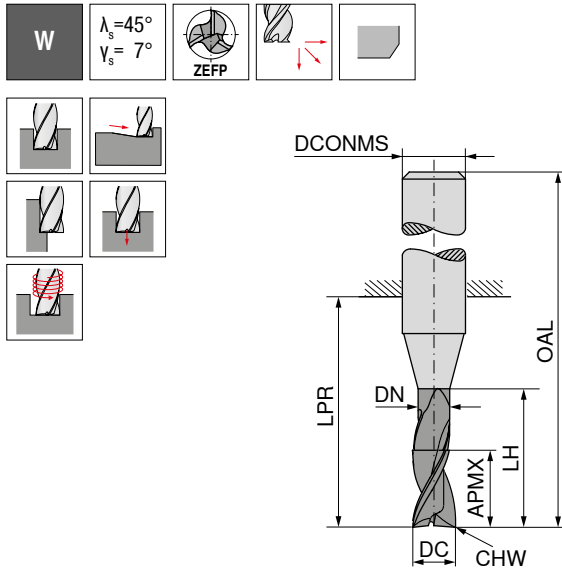

DC _{h6} mm	APMX mm	DN mm	LH mm	LPR mm	OAL mm	DCONMS _{h6} mm	CHW mm	ZEFP
11.0	25.0	10.6	36.0	40	85	12	0.20	3
11.0	31.0	10.6	60.0	64	109	12	0.20	3
11.5	25.0	11.1	36.0	40	85	12	0.20	3
11.5	31.0	11.1	60.0	64	109	12	0.20	3
12.0	25.0	11.6	36.0	40	85	12	0.20	3
12.0	31.0	11.6	60.0	64	109	12	0.20	3

Material	53 614 ...	53 614 ...
P		
M		
K		
N	•	•
S		
H		
O		

HB	53 614 ...	53 614 ...
11100		
11600		11200
12100		11700
		12200

→ v_d/f_z Page 24+25

End milling cutter

- ▲ irregular helix angle
- ▲ special cutting edge preparation for the machining of steel

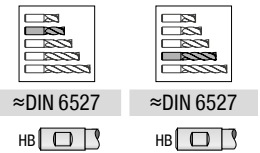
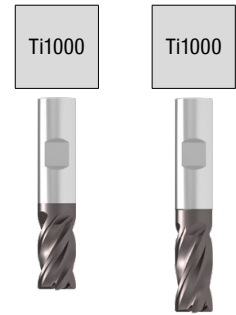
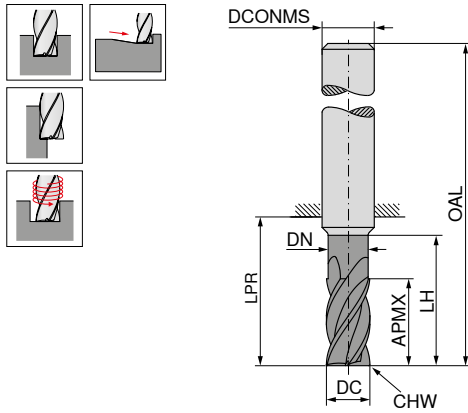

DC mm	APMX mm	DN mm	LH mm	LPR mm	OAL mm	DCONMS _{h6} mm	CHW mm	ZEPF
3.0	5			14	50	6	0.15	4
3.0	8	2.8	12.0	21	57	6	0.15	4
4.0	8			18	54	6	0.15	4
4.0	11	3.8	15.0	21	57	6	0.15	4
5.0	9			18	54	6	0.15	4
5.0	13	4.8	17.0	21	57	6	0.15	4
6.0	10			18	54	6	0.15	4
6.0	13	5.8	21.0	21	57	6	0.15	4
8.0	12			22	58	8	0.25	4
8.0	19	7.7	27.0	27	63	8	0.25	4
10.0	14			26	66	10	0.25	4
10.0	22	9.7	32.0	32	72	10	0.25	4
12.0	16			28	73	12	0.35	4
12.0	26	11.6	38.0	38	83	12	0.35	4

	54 001 ...	54 002 ...
P	•	•
M		
K	•	•
N		
S		
H		
O		

→ v_c/f_z Page 26+27

End milling cutter

- ▲ irregular helix angle
- ▲ special cutting edge preparation for the machining of stainless steel

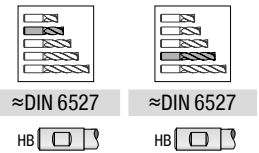
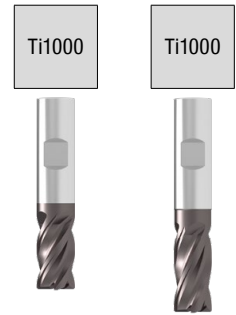
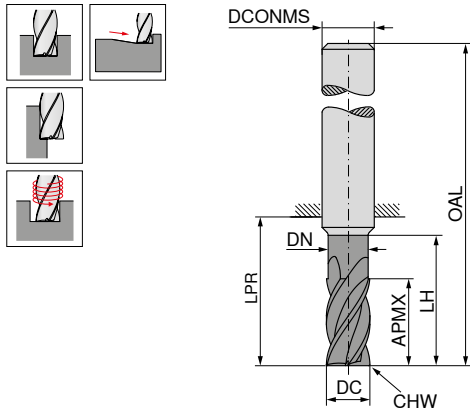

DC	APMX	DN	LH	LPR	OAL	DCONMS _{h6}	CHW	ZEPF
mm	mm	mm	mm	mm	mm	mm	mm	
3.0	5			14	50	6	0.15	4
3.0	8	2.8	12.0	21	57	6	0.15	4
4.0	8			18	54	6	0.15	4
4.0	11	3.8	15.0	21	57	6	0.15	4
5.0	9			18	54	6	0.15	4
5.0	13	4.8	17.0	21	57	6	0.15	4
6.0	10			18	54	6	0.15	4
6.0	13	5.8	21.0	21	57	6	0.15	4
8.0	12			22	58	8	0.25	4
8.0	19	7.7	27.0	27	63	8	0.25	4
10.0	14			26	66	10	0.25	4
10.0	22	9.7	32.0	32	72	10	0.25	4
12.0	16			28	73	12	0.35	4
12.0	26	11.6	38.0	38	83	12	0.35	4

	54 005 ...	54 006 ...
P	●	●
M	●	●
K	○	○
N	○	○
S	●	●
H		
O		

→ v_c/f_z Page 28+29

Micro-end milling cutter

▲ T_x = maximum engagement depth

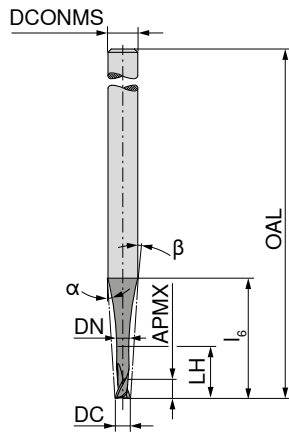
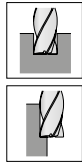
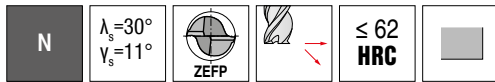

DC mm	APMX mm	DN mm	LH mm	l ₆ mm	OAL mm	α°	β°	DCONMS mm ^{ns}	T _x	ZEFP	52 802 ...	52 802 ...
0.2	0.12	0.16	0.44	5.7	38	15	14	3	2,2 x DC	2	021	
0.2	0.20	0.16	1.00	6.4	38	15	13	3	5 x DC	2	023	
0.2	0.20	0.16	2.00	9.2	38	15	9	3	10 x DC	2	025	
0.2	0.20	0.16	0.44	5.7	43	15	14	3	2,2 x DC	2		022
0.2	0.20	0.16	1.00	6.4	43	15	13	3	5 x DC	2		024
0.2	0.20	0.16	2.00	9.2	43	15	9	3	10 x DC	2		026
0.5	0.30	0.40	1.10	5.8	38	15	13	3	2,2 x DC	2	051	
0.5	0.50	0.40	2.50	7.8	38	15	10	3	5 x DC	2	053	
0.5	0.50	0.40	5.00	10.7	38	13	7	3	10 x DC	2	055	
0.5	0.50	0.40	1.10	5.8	43	15	13	3	2,2 x DC	2		052
0.5	0.50	0.40	2.50	7.8	43	15	10	3	5 x DC	2		054
0.5	0.50	0.40	5.00	14.5	43	13	5	3	10 x DC	2		056
0.8	0.48	0.64	1.76	5.9	38	15	11	3	2,2 x DC	2	081	
0.8	0.80	0.64	4.00	9.0	38	15	7	3	5 x DC	2	083	
0.8	0.80	0.64	8.00	13.5	38	12	5	3	10 x DC	2	085	
0.8	0.80	0.64	1.76	5.9	43	15	11	3	2,2 x DC	2		082
0.8	0.80	0.64	4.00	9.0	43	15	7	3	5 x DC	2		084
0.8	0.80	0.64	8.00	15.5	43	9,8	5	3	10 x DC	2		086
1.0	0.60	0.80	2.20	5.9	38	15	10	3	2,2 x DC	2	101	
1.0	1.00	0.80	2.20	5.9	43	15	10	3	2,2 x DC	2		102
1.0	1.00	0.80	5.00	9.7	43	15	6	3	5 x DC	2	103	
1.0	1.00	0.80	10.00	15.3	43	11	4	3	10 x DC	2	105	
1.0	1.00	0.80	5.00	9.7	50	15	6	3	5 x DC	2		104
1.0	1.00	0.80	10.00	20.6	50	8,5	3	3	10 x DC	2		106
1.5	0.90	1.20	3.30	6.1	38	15	8	3	2,2 x DC	2	151	
1.5	1.50	1.20	3.30	6.1	43	15	8	3	2,2 x DC	2		152
1.5	1.50	1.20	7.50	11.8	43	14	4	3	5 x DC	2	153	
1.5	1.50	1.20	15.00	18.1	43	14,6	3	3	10 x DC	2	155	
1.5	1.50	1.20	7.50	11.8	50	14	4	3	5 x DC	2		154
1.5	1.50	1.20	15.00	22.0	50	6,2	2	3	10 x DC	2		156
1.8	1.08	1.44	3.96	6.2	38	15	6	3	2,2 x DC	2	181	
1.8	1.80	1.44	3.96	6.2	43	15	6	3	2,2 x DC	2		182
1.8	1.80	1.44	9.00	12.9	43	12	3	3	5 x DC	2	183	
1.8	1.80	1.44	18.00	20.0	43	19,8	2	3	10 x DC	2	185	
1.8	1.80	1.44	9.00	12.9	50	12	3	3	5 x DC	2		184
1.8	1.80	1.44	18.00	22.0	50	5,3	2	3	10 x DC	2		186
2.0	1.20	1.60	4.40	11.9	50	15	10	6	2,2 x DC	2	201	
2.0	2.00	1.60	10.00	19.7	50	15	6	6	5 x DC	2	203	
2.0	2.00	1.60	20.00	25.0	50	22,1	5	6	10 x DC	2	205	
2.0	2.00	1.60	4.40	11.9	57	15	10	6	2,2 x DC	2		202
2.0	2.00	1.60	10.00	19.7	57	15	6	6	5 x DC	2		204
2.0	2.00	1.60	20.00	29.0	57	7,8	4	6	10 x DC	2		206

P	●	●
M	●	●
K	●	●
N	●	●
S	●	●
H	○	○
O	○	○

→ v_c/f_z Page 30-37



Engraving cutter 60°

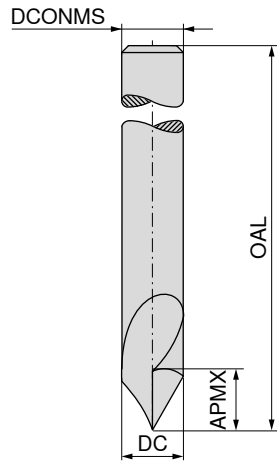
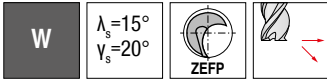

Factory standard



52 195 ...

DC _{h6} mm	APMX mm	OAL mm	DCONMS _{h6} mm	ZEFP
3	15	50	3	1
4	18	50	4	1
6	20	54	6	1

030

040

060

P	○
M	○
K	○
N	●
S	○
H	
O	●

Solid carbide circular saw blades

▲ fine-straight-cut

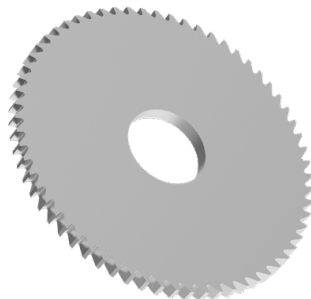
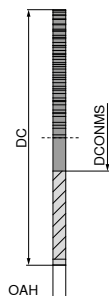

DIN 1837 A

54 700 ...

DC _{js15} mm	OAH _{±0.01} mm	DCONMS _{H6} mm	ZEFP	
15	0.20	5	64	102
15	0.25	5	64	103
15	0.30	5	64	104
15	0.35	5	64	105
15	0.40	5	64	106
15	0.50	5	48	107
15	0.60	5	48	108
15	0.70	5	48	109
15	0.80	5	40	110
15	0.90	5	40	111
15	1.00	5	40	112
15	1.10	5	40	113
15	1.20	5	40	114
15	1.30	5	40	115
15	1.40	5	40	116
15	1.50	5	40	117
15	1.60	5	40	118
15	1.70	5	40	119
15	1.80	5	40	120
15	1.90	5	40	121
15	2.00	5	40	122
15	2.50	5	40	123
15	3.00	5	40	124
15	3.50	5	40	125
15	4.00	5	40	126
15	4.50	5	40	127
15	5.00	5	40	128
15	5.50	5	40	129
15	6.00	5	40	130
20	0.20	5	80	152
20	0.25	5	64	153
20	0.30	5	64	154
20	0.35	5	64	155
20	0.40	5	64	156
20	0.50	5	48	157
20	0.60	5	48	158
20	0.70	5	48	159
20	0.80	5	48	160
20	0.90	5	40	161
20	1.00	5	40	162
20	1.10	5	40	163
20	1.20	5	40	164
20	1.30	5	40	165
20	1.40	5	40	166
20	1.50	5	40	167
20	1.60	5	40	168
20	1.70	5	40	169
20	1.80	5	32	170
20	1.90	5	32	171
20	2.00	5	32	172
20	2.50	5	32	173
20	3.00	5	32	174
20	3.50	5	24	175
20	4.00	5	24	176
20	4.50	5	24	177
20	5.00	5	24	178
20	5.50	5	24	179
20	6.00	5	24	180
25	0.20	8	80	202

54 700 ...

DC _{js15} mm	OAH _{±0.01} mm	DCONMS _{H6} mm	ZEFP	
25	0.25	8	80	203
25	0.30	8	80	204
25	0.35	8	64	205
25	0.40	8	64	206
25	0.50	8	64	207
25	0.60	8	64	208
25	0.70	8	48	209
25	0.80	8	48	210
25	0.90	8	48	211
25	1.00	8	48	212
25	1.10	8	48	213
25	1.20	8	48	214
25	1.30	8	40	215
25	1.40	8	40	216
25	1.50	8	40	217
25	1.60	8	40	218
25	1.70	8	40	219
25	1.80	8	40	220
25	1.90	8	40	221
25	2.00	8	40	222
25	2.50	8	40	223
25	3.00	8	32	224
25	3.50	8	32	225
25	4.00	8	32	226
25	4.50	8	32	227
25	5.00	8	32	228
25	5.50	8	24	229
25	6.00	8	24	230
30	0.20	8	100	252
30	0.25	8	100	253
30	0.30	8	80	254
30	0.35	8	80	255
30	0.40	8	80	256
30	0.50	8	80	257
30	0.60	8	64	258
30	0.70	8	64	259
30	0.80	8	64	260
30	0.90	8	64	261
30	1.00	8	64	262
30	1.10	8	64	263
30	1.20	8	48	264
30	1.30	8	48	265
30	1.40	8	48	266
30	1.50	8	48	267
30	1.60	8	48	268
30	1.70	8	48	269
30	1.80	8	48	270
30	1.90	8	48	271
30	2.00	8	48	272
30	2.50	8	40	273
30	3.00	8	40	274
30	3.50	8	40	275
30	4.00	8	40	276
30	4.50	8	32	277
30	5.00	8	32	278
30	5.50	8	32	279
30	6.00	8	32	280

P	●
M	●
K	●
N	●
S	●
H	
O	●

→ v_c/fz Page 38

 Diameters 80–200 mm, and the coarse toothed variant according to DIN 1838 B can be found in our online shop.



Solid carbide circular saw blades

▲ fine-straight-cut

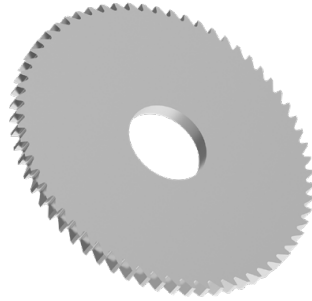
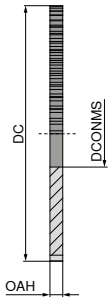
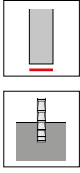

DIN 1837 A

54 700 ...

DC _{js15} mm	OAH _{±0.01} mm	DCONMS _{H6} mm	ZEFP	
40	0.20	10	128	302
40	0.25	10	100	303
40	0.30	10	100	304
40	0.35	10	100	305
40	0.40	10	100	306
40	0.50	10	80	307
40	0.60	10	80	308
40	0.70	10	80	309
40	0.80	10	80	310
40	0.90	10	64	311
40	1.00	10	64	312
40	1.10	10	64	313
40	1.20	10	64	314
40	1.30	10	64	315
40	1.40	10	64	316
40	1.50	10	64	317
40	1.60	10	64	318
40	1.70	10	48	319
40	1.80	10	48	320
40	1.90	10	48	321
40	2.00	10	48	322
40	2.50	10	48	323
40	3.00	10	48	324
40	3.50	10	48	325
40	4.00	10	40	326
40	4.50	10	40	327
40	5.00	10	40	328
40	5.50	10	40	329
40	6.00	10	40	330
50	0.20	13	128	352
50	0.25	13	128	353
50	0.30	13	128	354
50	0.35	13	100	355
50	0.40	13	100	356
50	0.50	13	100	357
50	0.60	13	100	358
50	0.70	13	80	359
50	0.80	13	80	360
50	0.90	13	80	361
50	1.00	13	80	362
50	1.10	13	80	363
50	1.20	13	80	364
50	1.30	13	64	365
50	1.40	13	64	366
50	1.50	13	64	367
50	1.60	13	64	368
50	1.70	13	64	369
50	1.80	13	64	370
50	1.90	13	64	371
50	2.00	13	64	372
50	2.50	13	64	373
50	3.00	13	48	374
50	3.50	13	48	375
50	4.00	13	48	376
50	4.50	13	48	377
50	5.00	13	48	378
50	5.50	13	40	379
50	6.00	13	40	380
63	0.20	16	160	402

54 700 ...

DC _{js15} mm	OAH _{±0.01} mm	DCONMS _{H6} mm	ZEFP	
63	0.25	16	160	403
63	0.30	16	128	404
63	0.35	16	128	405
63	0.40	16	128	406
63	0.50	16	128	407
63	0.60	16	100	408
63	0.70	16	100	409
63	0.80	16	100	410
63	0.90	16	100	411
63	1.00	16	100	412
63	1.10	16	80	413
63	1.20	16	80	414
63	1.30	16	80	415
63	1.40	16	80	416
63	1.50	16	80	417
63	1.60	16	80	418
63	1.70	16	80	419
63	1.80	16	80	420
63	1.90	16	80	421
63	2.00	16	80	422
63	2.50	16	64	423
63	3.00	16	64	424
63	3.50	16	64	425
63	4.00	16	64	426
63	4.50	16	64	427
63	5.00	16	48	428
63	5.50	16	48	429
63	6.00	16	48	430

P	●
M	●
K	●
N	●
S	●
H	●
O	●

→ v_c/fz Page 38

Diameters 80–200 mm, and the coarse toothed variant according to DIN 1838 B can be found in our online shop.



Cylindrical shank adapter for circular saw blades

▲ DCONWS = circular saw blade bore diameter

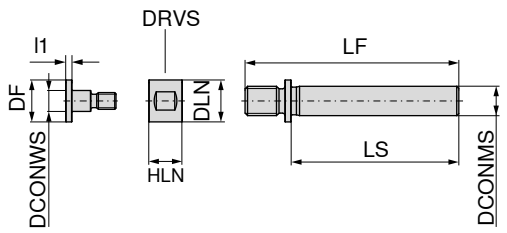

DCONWS _{H7} mm	DCONMS _{H7} mm	DLN mm	DF mm	LF mm	LS mm	HLN mm	i ₁ mm	DRVS mm	72 900 ...
5	7	10	10	51	40	8	3	9	005
5	10	10	10	61	50	8	3	9	105
8	7	15	15	51	40	8	3	14	008
8	10	15	15	61	50	8	3	14	108
10	7	17	17	53	40	10	3	16	010
10	10	17	17	63	50	10	3	16	110
10	16	17	17	74	55	10	3	16	210
13	10	20	20	66	50	10	3	18	113
13	16	20	20	77	55	10	3	18	213
16	10	24	24	66	50	14	3	22	116
16	16	24	24	79	55	14	3	22	216



Screw - SR

72 945 ...



Lock nut - KM

72 945 ...

**Spare parts
for Article no.**

72 900 005	000	005
72 900 105	000	005
72 900 008	001	006
72 900 108	001	006
72 900 010	002	007
72 900 110	002	007
72 900 210	010	012
72 900 113	003	008
72 900 213	003	008
72 900 116	004	009
72 900 216	011	013

ER mono clamping – Circular saw blades

▲ DCONWS = circular saw blade bore diameter

Scope of supply:

Adapter incl. Lock nut

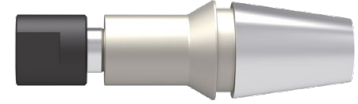
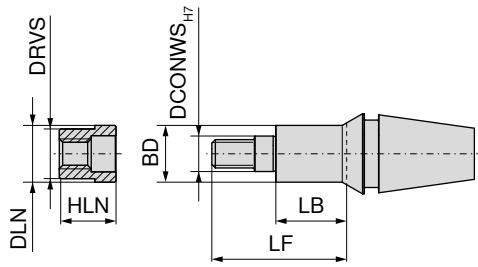

DCONWS _{H7} mm	Adapter	DLN mm	LB mm	HLN mm	BD mm	LF mm	DRVS mm	72 930 ...
5	ER 11	8	10	8	8	21	7	51100
5	ER 16	10	18	8	10	29	9	51600
5	ER 20	10	18	8	10	29	9	52000
8	ER 20	15	18	8	15	29	13	82000
10	ER 20	16	30	8	15	41	14	12000

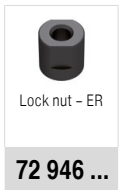

Spare parts for Article no.

72 930 51100	51100
72 930 51600	51600
72 930 52000	52000
72 930 82000	82000
72 930 12000	12000

Material examples for cutting data tables

	Material sub-group	Index	Composition / Structure / Heat treatment	Tensile strength N/mm ² / HB / HRC	Material number	Material designation	Material number	Material designation
P	Unalloyed steel	P.1.1	< 0,15 % C Annealed	420 N/mm ² / 125 HB	1.0401	C15	1.1141	Ck15
		P.1.2	< 0,45 % C Annealed	640 N/mm ² / 190 HB	1.1191	C45E	1.0718	9SMnPb28
		P.1.3	< 0,45 % C Tempered	840 N/mm ² / 250 HB	1.1191	C45E	1.0535	C55
		P.1.4	< 0,75 % C Annealed	910 N/mm ² / 270 HB	1.1223	C60R	1.0535	C55
		P.1.5	< 0,75 % C Tempered	1010 N/mm ² / 300 HB	1.1223	C60R	1.0727	45S20
	Low-alloy steel	P.2.1	Annealed	610 N/mm ² / 180 HB	1.7131	16MnCr5	1.6587	17CrNiMo6
		P.2.2	Tempered	930 N/mm ² / 275 HB	1.7131	16MnCr5	1.6587	17CrNiMo6
		P.2.3	Tempered	1010 N/mm ² / 300 HB	1.7225	42CrMo4	1.3505	100Cr6
		P.2.4	Tempered	1200 N/mm ² / 375 HB	1.7225	42CrMo4	1.3505	100Cr6
	High-alloy steel and high-alloy tool steel	P.3.1	Annealed	680 N/mm ² / 200 HB	1.4021	X20Cr13	1.4034	X46Cr13
		P.3.2	Hardened and tempered	1100 N/mm ² / 300 HB	1.2343	X38CrMoV5-1	1.4034	X46Cr13
		P.3.3	Hardened and tempered	1300 N/mm ² / 400 HB	1.2343	X38CrMoV5-1	1.4034	X46Cr13
	Stainless steel	P.4.1	Ferritic / martensitic Annealed	680 N/mm ² / 200 HB	1.4016	X6Cr17	1.2316	X36CrMo16
		P.4.2	Martensitic Tempered	1010 N/mm ² / 300 HB	1.4112	X90CrMoV18	1.2316	X36CrMo16
M	Stainless steel	M.1.1	Austenitic / austenitic-ferritic Quenched	610 N/mm ² / 180 HB	1.4301	X5CrNi18-10	1.4571	X6CrNiMoTi17-12-2
		M.2.1	Austenitic Tempered	300 HB	1.4841	X15CrNiSi25-21	1.4539	X1NiCrMoCu25-20-5
		M.3.1	Austenitic / ferritic (Duplex)	780 N/mm ² / 230 HB	1.4462	X2CrNiMoN22-5-3	1.4501	X2CrNiMoCuWN25-7-4
K	Grey cast iron	K.1.1	Pearlitic / ferritic	350 N/mm ² / 180 HB	0.6010	GG-10	0.6025	GG-25
		K.1.2	Pearlitic (martensitic)	500 N/mm ² / 260 HB	0.6030	GG-30	0.6045	GG-45
	Spherulitic graphite cast iron	K.2.1	Ferritic	540 N/mm ² / 160 HB	0.7040	GGG-40	0.7060	GGG-60
		K.2.2	Pearlitic	845 N/mm ² / 250 HB	0.7070	GGG-70	0.7080	GGG-80
	Malleable iron	K.3.1	Ferritic	440 N/mm ² / 130 HB	0.8035	GTW-35-04	0.8045	GTW-45
		K.3.2	Pearlitic	780 N/mm ² / 230 HB	0.8165	GTS-65-02	0.8170	GTS-70-02
N	Aluminium wrought alloy	N.1.1	Non-hardenable	60 HB	3.0255	Al99,5	3.3315	AlMg1
		N.1.2	Hardenable Age-hardened	340 N/mm ² / 100 HB	3.1355	AlCuMg2	3.2315	AlMgSi1
	Cast aluminium alloy	N.2.1	≤ 12 % Si, non-hardenable	250 N/mm ² / 75 HB	3.2581	G-AlSi12	3.2163	G-AlSi9Cu3
		N.2.2	≤ 12 % Si, hardenable Age-hardened	300 N/mm ² / 90 HB	3.2134	G-AlSi5Cu1Mg	3.2373	G-AlSi9Mg
		N.2.3	> 12 % Si, non-hardenable	440 N/mm ² / 130 HB		G-AlSi17Cu4Mg		G-AlSi18CuNiMg
	Copper and copper alloys (bronze/brass)	N.3.1	Free-machining alloys, PB > 1 %	375 N/mm ² / 110 HB	2.0380	CuZn39Pb2 (Ms58)	2.0410	CuZn44Pb2
		N.3.2	CuZn, CuSnZn	300 N/mm ² / 90 HB	2.0331	CuZn15	2.4070	CuZn28Sn1As
		N.3.3	CuSn, lead-free copper and electrolytic copper	340 N/mm ² / 100 HB	2.0060	E-Cu57	2.0590	CuZn40Fe
	Magnesium alloys	N.4.1	Magnesium and magnesium alloys	70 HB	3.5612	MgAl6Zn	3.5312	MgAl3Zn
S	Heat-resistant alloys	S.1.1	Fe - basis Annealed	680 N/mm ² / 200 HB	1.4864	X12NiCrSi 36-16	1.4865	G-X40NiCrSi38-18
		S.1.2	Fe - basis Age-hardened	950 N/mm ² / 280 HB	1.4980	X6NiCrTiMoVB25-15-2	1.4876	X10NiCrAlTi32-20
		S.2.1	Ni or Co basis Annealed	840 N/mm ² / 250 HB	2.4631	NiCr20TiAl (Nimonic80A)	3.4856	NiCr22Mo9Nb
		S.2.2	Ni or Co basis Age-hardened	1180 N/mm ² / 350 HB	2.4668	NiCr19Nb5Mo3 (Inconel 718)	2.4955	NiFe25Cr20NbTi
		S.2.3	Ni or Co basis Cast	1080 N/mm ² / 320 HB	2.4765	CoCr20W15Ni	1.3401	G-X120Mn12
	Titanium alloys	S.3.1	Pure titanium	400 N/mm ²	3.7025	Ti99,8	3.7034	Ti99,7
		S.3.2	Alpha + beta alloys Age-hardened	1050 N/mm ² / 320 HB	3.7165	TiAl6V4	Ti-6246	Ti-6Al-2Sn-4Zr-6Mo
S.3.3	Beta alloys	1400 N/mm ² / 410 HB	Ti555.3	Ti-5Al-5V-5Mo-3Cr	R56410	Ti-10V-2Fe-3Al		
H	Hardened steel	H.1.1	Hardened and tempered	46–55 HRC				
		H.1.2	Hardened and tempered	56–60 HRC				
		H.1.3	Hardened and tempered	61–65 HRC				
		H.1.4	Hardened and tempered	66–70 HRC				
	Chilled iron	H.2.1	Cast	400 HB				
	Hardened cast iron	H.3.1	Hardened and tempered	55 HRC				
O	Non-metal materials	O.1.1	Plastics, duroplastic	≤ 150 N/mm ²				
		O.1.2	Plastics, thermoplastic	≤ 100 N/mm ²				
		O.2.1	Aramid fibre-reinforced	≤ 1000 N/mm ²				
		O.2.2	Glass/carbon-fibre reinforced	≤ 1000 N/mm ²				
		O.3.1	Graphite					

* Tensile strength

Cutting data standard values – SilverLine – End mill

							50 966 ...												
		Type short		Type long		Type extra long		Ø DC = 3,0 mm			Ø DC = 3,5–4,0 mm			Ø DC = 4,5–5,0 mm			Ø DC = 5,5–6,0 mm		
		a_p		a_p		a_p		a_p	a_p	a_p	a_p	a_p	a_p	a_p	a_p	a_p	a_p		
		x DC		x DC		x DC		x DC	x DC	x DC	x DC	x DC	x DC	x DC	x DC	x DC	x DC		
Index	V_c m/min	$a_{p,max}$ x DC	V_c m/min	$a_{p,max}$ x DC	V_c m/min	$a_{p,max}$ x DC	f_z mm			f_z mm			f_z mm			f_z mm			
P.1.1	252	1,0	210	1,0*	105	0,8	0,028	0,022	0,014	0,038	0,030	0,019	0,049	0,039	0,025	0,060	0,048	0,030	
P.1.2	240	1,0	200	1,0*	100	0,8	0,028	0,022	0,014	0,038	0,030	0,019	0,049	0,039	0,025	0,060	0,048	0,030	
P.1.3	240	1,0	200	1,0*	100	0,8	0,028	0,022	0,014	0,038	0,030	0,019	0,049	0,039	0,025	0,060	0,048	0,030	
P.1.4	228	1,0	190	1,0*	95	0,8	0,028	0,022	0,014	0,038	0,030	0,019	0,049	0,039	0,025	0,060	0,048	0,030	
P.1.5	228	1,0	190	1,0*	95	0,8	0,028	0,022	0,014	0,038	0,030	0,019	0,049	0,039	0,025	0,060	0,048	0,030	
P.2.1	240	1,0	200	1,0*	100	0,8	0,028	0,022	0,014	0,038	0,030	0,019	0,049	0,039	0,025	0,060	0,048	0,030	
P.2.2	228	1,0	190	1,0*	95	0,8	0,028	0,022	0,014	0,038	0,030	0,019	0,049	0,039	0,025	0,060	0,048	0,030	
P.2.3	216	1,0	180	1,0*	90	0,8	0,028	0,022	0,014	0,038	0,030	0,019	0,049	0,039	0,025	0,060	0,048	0,030	
P.2.4	204	1,0	170	1,0*	85	0,8	0,028	0,022	0,014	0,038	0,030	0,019	0,049	0,039	0,025	0,060	0,048	0,030	
P.3.1																			
P.3.2																			
P.3.3																			
P.4.1	120	1,0	100	1,0*	60	0,8	0,017	0,014	0,009	0,024	0,019	0,012	0,031	0,025	0,016	0,038	0,030	0,019	
P.4.2	96	1,0	80	1,0*	50	0,8	0,017	0,014	0,009	0,024	0,019	0,012	0,031	0,025	0,016	0,038	0,030	0,019	
M.1.1	120	1,0	100	1,0*	60	0,8	0,017	0,014	0,009	0,024	0,019	0,012	0,031	0,025	0,016	0,038	0,030	0,019	
M.2.1	120	1,0	100	1,0*	60	0,8	0,017	0,014	0,009	0,024	0,019	0,012	0,031	0,025	0,016	0,038	0,030	0,019	
M.3.1	120	1,0	100	1,0*	60	0,8	0,017	0,014	0,009	0,024	0,019	0,012	0,031	0,025	0,016	0,038	0,030	0,019	
K.1.1	240	1,0	200	1,0*	100	0,8	0,037	0,030	0,019	0,048	0,038	0,024	0,060	0,048	0,030	0,070	0,056	0,035	
K.1.2	216	1,0	180	1,0*	90	0,8	0,037	0,030	0,019	0,048	0,038	0,024	0,060	0,048	0,030	0,070	0,056	0,035	
K.2.1	228	1,0	190	1,0*	60	0,8	0,028	0,022	0,014	0,038	0,030	0,019	0,049	0,039	0,025	0,060	0,048	0,030	
K.2.2	204	1,0	170	1,0*	85	0,8	0,028	0,022	0,014	0,038	0,030	0,019	0,049	0,039	0,025	0,060	0,048	0,030	
K.3.1	216	1,0	180	1,0*	90	0,8	0,028	0,022	0,014	0,038	0,030	0,019	0,049	0,039	0,025	0,060	0,048	0,030	
K.3.2	192	1,0	160	1,0*	80	0,8	0,028	0,022	0,014	0,038	0,030	0,019	0,049	0,039	0,025	0,060	0,048	0,030	
N.1.1																			
N.1.2																			
N.2.1																			
N.2.2																			
N.2.3																			
N.3.1	420	1,0	350	1,0*	175	0,8	0,037	0,030	0,019	0,048	0,038	0,024	0,060	0,048	0,030	0,070	0,056	0,035	
N.3.2	420	1,0	350	1,0*	175	0,8	0,037	0,030	0,019	0,048	0,038	0,024	0,060	0,048	0,030	0,070	0,056	0,035	
N.3.3	336	1,0	280	1,0*	140	0,8	0,037	0,030	0,019	0,048	0,038	0,024	0,060	0,048	0,030	0,070	0,056	0,035	
N.4.1																			
S.1.1	30	0,5	25	0,5	15	0,4	0,015	0,012	0,008	0,020	0,016	0,010	0,025	0,020	0,013	0,030	0,024	0,015	
S.1.2	30	0,5	25	0,5	15	0,4	0,015	0,012	0,008	0,020	0,016	0,010	0,025	0,020	0,013	0,030	0,024	0,015	
S.2.1	30	0,5	25	0,5	15	0,4	0,015	0,012	0,008	0,020	0,016	0,010	0,025	0,020	0,013	0,030	0,024	0,015	
S.2.2	30	0,5	25	0,5	15	0,4	0,015	0,012	0,008	0,020	0,016	0,010	0,025	0,020	0,013	0,030	0,024	0,015	
S.2.3	30	0,5	25	0,5	15	0,4	0,015	0,012	0,008	0,020	0,016	0,010	0,025	0,020	0,013	0,030	0,024	0,015	
S.3.1	108	1,0	90	1,0*	45	0,8	0,028	0,022	0,014	0,038	0,030	0,019	0,049	0,039	0,025	0,060	0,048	0,030	
S.3.2	60	1,0	50	1,0*	25	0,8	0,017	0,014	0,009	0,024	0,019	0,012	0,031	0,025	0,016	0,038	0,030	0,019	
S.3.3																			
H.1.1																			
H.1.2																			
H.1.3																			
H.1.4																			
H.2.1																			
H.3.1																			
O.1.1																			
O.1.2																			
O.2.1																			
O.2.2																			
O.3.1																			

* = long version: $a_{p,max} = 1.5 \times DC$ at $f_z \times 0.75$



"Extra-long" version: when profiling with an a_e of 0.1–0.4 x DC an a_p of 1.0 x DC should be used.

50 966 ...												
Index	Ø DC = 6,5–8,0 mm			Ø DC = 8,5–10,0mm			Ø DC = 12,0 mm			● 1st choice ○ suitable		
	a_p 0,1–0,2 x DC	a_p 0,3–0,4 x DC	a_p 0,6–1,0 x DC	a_p 0,1–0,2 x DC	a_p 0,3–0,4 x DC	a_p 0,6–1,0 x DC	a_p 0,1–0,2 x DC	a_p 0,3–0,4 x DC	a_p 0,6–1,0 x DC	Emulsion	Compressed air	MMS
	f_z mm			f_z mm			f_z mm					
P.1.1	0,080	0,064	0,040	0,100	0,080	0,050	0,120	0,096	0,060	●	○	○
P.1.2	0,080	0,064	0,040	0,100	0,080	0,050	0,120	0,096	0,060	●	○	○
P.1.3	0,080	0,064	0,040	0,100	0,080	0,050	0,120	0,096	0,060	●	○	○
P.1.4	0,080	0,064	0,040	0,100	0,080	0,050	0,120	0,096	0,060	●	○	○
P.1.5	0,080	0,064	0,040	0,100	0,080	0,050	0,120	0,096	0,060	●	○	○
P.2.1	0,080	0,064	0,040	0,100	0,080	0,050	0,120	0,096	0,060	●	○	○
P.2.2	0,080	0,064	0,040	0,100	0,080	0,050	0,120	0,096	0,060	●	○	○
P.2.3	0,080	0,064	0,040	0,100	0,080	0,050	0,120	0,096	0,060	●	○	○
P.2.4	0,080	0,064	0,040	0,100	0,080	0,050	0,120	0,096	0,060	●	○	○
P.3.1										●	○	○
P.3.2												
P.3.3												
P.4.1	0,052	0,042	0,026	0,066	0,053	0,033	0,080	0,064	0,040	●		
P.4.2	0,052	0,042	0,026	0,066	0,053	0,033	0,080	0,064	0,040	●		
M.1.1	0,052	0,042	0,026	0,066	0,053	0,033	0,080	0,064	0,040	●		
M.2.1	0,052	0,042	0,026	0,066	0,053	0,033	0,080	0,064	0,040	●		
M.3.1	0,052	0,042	0,026	0,066	0,053	0,033	0,080	0,064	0,040	●		
K.1.1	0,094	0,075	0,047	0,116	0,093	0,058	0,140	0,112	0,070	●	●	●
K.1.2	0,094	0,075	0,047	0,116	0,093	0,058	0,140	0,112	0,070	●	●	●
K.2.1	0,080	0,064	0,040	0,100	0,080	0,050	0,120	0,096	0,060	●	●	●
K.2.2	0,080	0,064	0,040	0,100	0,080	0,050	0,120	0,096	0,060	●	●	●
K.3.1	0,080	0,064	0,040	0,100	0,080	0,050	0,120	0,096	0,060	●	●	●
K.3.2	0,080	0,064	0,040	0,100	0,080	0,050	0,120	0,096	0,060	●	●	●
N.1.1												
N.1.2												
N.2.1												
N.2.2												
N.2.3												
N.3.1	0,094	0,075	0,047	0,116	0,093	0,058	0,140	0,112	0,070	●		
N.3.2	0,094	0,075	0,047	0,116	0,093	0,058	0,140	0,112	0,070	●		
N.3.3	0,094	0,075	0,047	0,116	0,093	0,058	0,140	0,112	0,070	●		
N.4.1												
S.1.1	0,040	0,032	0,020	0,050	0,040	0,025	0,060	0,048	0,030	●		
S.1.2	0,040	0,032	0,020	0,050	0,040	0,025	0,060	0,048	0,030	●		
S.2.1	0,040	0,032	0,020	0,050	0,040	0,025	0,060	0,048	0,030	●		
S.2.2	0,040	0,032	0,020	0,050	0,040	0,025	0,060	0,048	0,030	●		
S.2.3	0,040	0,032	0,020	0,050	0,040	0,025	0,060	0,048	0,030	●		
S.3.1	0,080	0,064	0,040	0,100	0,080	0,050	0,120	0,096	0,060	●		
S.3.2	0,052	0,042	0,026	0,066	0,053	0,033	0,080	0,064	0,040	●		
S.3.3												
H.1.1												
H.1.2												
H.1.3												
H.1.4												
H.2.1												
H.3.1												
O.1.1												
O.1.2												
O.2.1												
O.2.2												
O.3.1												

 Plunging angle for ramping and helical milling: 3°

Cutting data standard values – SilverLine – End mill

		50 973 ...													
		Ø DC = 3,0 mm			Ø DC = 3,5–4,0 mm			Ø DC = 4,5–5,0 mm			Ø DC = 5,5–6,0 mm				
		a_p 0,1–0,2 x DC	a_p 0,3–0,4 x DC	a_p 0,6–1,0 x DC	a_p 0,1–0,2 x DC	a_p 0,3–0,4 x DC	a_p 0,6–1,0 x DC	a_p 0,1–0,2 x DC	a_p 0,3–0,4 x DC	a_p 0,6–1,0 x DC	a_p 0,1–0,2 x DC	a_p 0,3–0,4 x DC	a_p 0,6–1,0 x DC		
Index	V_c m/min	$a_{p,max}$ x DC	f_z mm	f_z mm	f_z mm	f_z mm	f_z mm	f_z mm	f_z mm	f_z mm	f_z mm	f_z mm	f_z mm		
P.1.1	253	230	1,0*	0,037	0,030	0,019	0,048	0,038	0,024	0,060	0,048	0,030	0,070	0,056	0,035
P.1.2	242	220	1,0*	0,037	0,030	0,019	0,048	0,038	0,024	0,060	0,048	0,030	0,070	0,056	0,035
P.1.3	242	220	1,0*	0,037	0,030	0,019	0,048	0,038	0,024	0,060	0,048	0,030	0,070	0,056	0,035
P.1.4	230	210	1,0*	0,037	0,030	0,019	0,048	0,038	0,024	0,060	0,048	0,030	0,070	0,056	0,035
P.1.5	230	210	1,0*	0,037	0,030	0,019	0,048	0,038	0,024	0,060	0,048	0,030	0,070	0,056	0,035
P.2.1	242	220	1,0*	0,037	0,030	0,019	0,048	0,038	0,024	0,060	0,048	0,030	0,070	0,056	0,035
P.2.2	230	210	1,0*	0,028	0,022	0,014	0,038	0,030	0,019	0,049	0,039	0,025	0,060	0,048	0,030
P.2.3	220	200	1,0*	0,037	0,030	0,019	0,048	0,038	0,024	0,060	0,048	0,030	0,070	0,056	0,035
P.2.4	210	190	1,0*	0,028	0,022	0,014	0,038	0,030	0,019	0,049	0,039	0,025	0,060	0,048	0,030
P.3.1	220	200	1,0*	0,037	0,030	0,019	0,048	0,038	0,024	0,060	0,048	0,030	0,070	0,056	0,035
P.3.2	210	190	1,0*	0,037	0,030	0,019	0,048	0,038	0,024	0,060	0,048	0,030	0,070	0,056	0,035
P.3.3	176	160	1,0*	0,037	0,030	0,019	0,048	0,038	0,024	0,060	0,048	0,030	0,070	0,056	0,035
P.4.1	120	110	1,0*	0,017	0,014	0,009	0,024	0,019	0,012	0,031	0,025	0,016	0,038	0,030	0,019
P.4.2	100	90	1,0*	0,017	0,014	0,009	0,024	0,019	0,012	0,031	0,025	0,016	0,038	0,030	0,019
M.1.1	120	110	1,0*	0,017	0,014	0,009	0,024	0,019	0,012	0,031	0,025	0,016	0,038	0,030	0,019
M.2.1	120	110	1,0*	0,017	0,014	0,009	0,024	0,019	0,012	0,031	0,025	0,016	0,038	0,030	0,019
M.3.1	120	110	1,0*	0,017	0,014	0,009	0,024	0,019	0,012	0,031	0,025	0,016	0,038	0,030	0,019
K.1.1	242	220	1,0*	0,046	0,037	0,023	0,062	0,050	0,031	0,078	0,062	0,039	0,094	0,075	0,047
K.1.2	220	200	1,0*	0,046	0,037	0,023	0,062	0,050	0,031	0,078	0,062	0,039	0,094	0,075	0,047
K.2.1	230	210	1,0*	0,037	0,030	0,019	0,048	0,038	0,024	0,060	0,048	0,030	0,070	0,056	0,035
K.2.2	210	190	1,0*	0,037	0,030	0,019	0,048	0,038	0,024	0,060	0,048	0,030	0,070	0,056	0,035
K.3.1	220	200	1,0*	0,037	0,030	0,019	0,048	0,038	0,024	0,060	0,048	0,030	0,070	0,056	0,035
K.3.2	200	180	1,0*	0,037	0,030	0,019	0,048	0,038	0,024	0,060	0,048	0,030	0,070	0,056	0,035
N.1.1															
N.1.2															
N.2.1															
N.2.2															
N.2.3															
N.3.1	385	350	1,0*	0,046	0,037	0,023	0,062	0,050	0,031	0,078	0,062	0,039	0,094	0,075	0,047
N.3.2	308	350	1,0*	0,046	0,037	0,023	0,062	0,050	0,031	0,078	0,062	0,039	0,094	0,075	0,047
N.3.3	308	280	1,0*	0,046	0,037	0,023	0,062	0,050	0,031	0,078	0,062	0,039	0,094	0,075	0,047
N.4.1															
S.1.1	35	30	0,5	0,015	0,012	0,008	0,020	0,016	0,010	0,025	0,020	0,013	0,030	0,024	0,015
S.1.2	35	30	0,5	0,015	0,012	0,008	0,020	0,016	0,010	0,025	0,020	0,013	0,030	0,024	0,015
S.2.1	35	30	0,5	0,015	0,012	0,008	0,020	0,016	0,010	0,025	0,020	0,013	0,030	0,024	0,015
S.2.2	35	30	0,5	0,015	0,012	0,008	0,020	0,016	0,010	0,025	0,020	0,013	0,030	0,024	0,015
S.2.3	35	30	0,5	0,015	0,012	0,008	0,020	0,016	0,010	0,025	0,020	0,013	0,030	0,024	0,015
S.3.1	110	90	0,5	0,028	0,022	0,014	0,038	0,030	0,019	0,049	0,039	0,025	0,060	0,048	0,030
S.3.2	70	50	0,5	0,017	0,014	0,009	0,024	0,019	0,012	0,031	0,025	0,016	0,038	0,030	0,019
S.3.3															
H.1.1															
H.1.2															
H.1.3															
H.1.4															
H.2.1															
H.3.1															
O.1.1															
O.1.2															
O.2.1															
O.2.2															
O.3.1															

* = long version: $a_{p,max} = 1.5 \times DC$ at $f_z \times 0.75$



50 973 ...												
Index	Ø DC = 7,0–8,0 mm			Ø DC = 9,0–10,0 mm			Ø DC = 11,0–12,0 mm			● 1st choice ○ suitable		
	a_p 0,1–0,2 x DC	a_p 0,3–0,4 x DC	a_p 0,6–1,0 x DC	a_p 0,1–0,2 x DC	a_p 0,3–0,4 x DC	a_p 0,6–1,0 x DC	a_p 0,1–0,2 x DC	a_p 0,3–0,4 x DC	a_p 0,6–1,0 x DC	Emulsion	Compressed air	MMS
	f_z mm			f_z mm			f_z mm					
P.1.1	0,094	0,075	0,047	0,116	0,093	0,058	0,140	0,112	0,070	●	○	○
P.1.2	0,094	0,075	0,047	0,116	0,093	0,058	0,140	0,112	0,070	●	○	○
P.1.3	0,094	0,075	0,047	0,116	0,093	0,058	0,140	0,112	0,070	●	○	○
P.1.4	0,094	0,075	0,047	0,116	0,093	0,058	0,140	0,112	0,070	●	○	○
P.1.5	0,094	0,075	0,047	0,116	0,093	0,058	0,140	0,112	0,070	●	○	○
P.2.1	0,094	0,075	0,047	0,116	0,093	0,058	0,140	0,112	0,070	●	○	○
P.2.2	0,080	0,064	0,040	0,100	0,080	0,050	0,120	0,096	0,060	●	○	○
P.2.3	0,094	0,075	0,047	0,116	0,093	0,058	0,140	0,112	0,070	●	○	○
P.2.4	0,080	0,064	0,040	0,100	0,080	0,050	0,120	0,096	0,060	●	○	○
P.3.1	0,094	0,075	0,047	0,116	0,093	0,058	0,140	0,112	0,070	●	○	○
P.3.2	0,094	0,075	0,047	0,116	0,093	0,058	0,140	0,112	0,070	●	○	○
P.3.3	0,094	0,075	0,047	0,116	0,093	0,058	0,140	0,112	0,070	●	○	○
P.4.1	0,052	0,042	0,026	0,066	0,053	0,033	0,080	0,064	0,040	●		
P.4.2	0,052	0,042	0,026	0,066	0,053	0,033	0,080	0,064	0,040	●		
M.1.1	0,052	0,042	0,026	0,066	0,053	0,033	0,080	0,064	0,040	●		
M.2.1	0,052	0,042	0,026	0,066	0,053	0,033	0,080	0,064	0,040	●		
M.3.1	0,052	0,042	0,026	0,066	0,053	0,033	0,080	0,064	0,040	●		
K.1.1	0,126	0,101	0,063	0,160	0,128	0,080	0,192	0,154	0,096	●	●	●
K.1.2	0,126	0,101	0,063	0,160	0,128	0,080	0,192	0,154	0,096	●	●	●
K.2.1	0,094	0,075	0,047	0,116	0,093	0,058	0,140	0,112	0,070	●	●	●
K.2.2	0,094	0,075	0,047	0,116	0,093	0,058	0,140	0,112	0,070	●	●	●
K.3.1	0,094	0,075	0,047	0,116	0,093	0,058	0,140	0,112	0,070	●	●	●
K.3.2	0,094	0,075	0,047	0,116	0,093	0,058	0,140	0,112	0,070	●	●	●
N.1.1												
N.1.2												
N.2.1												
N.2.2												
N.2.3												
N.3.1	0,126	0,101	0,063	0,160	0,128	0,080	0,192	0,154	0,096	●		
N.3.2	0,126	0,101	0,063	0,160	0,128	0,080	0,192	0,154	0,096	●		
N.3.3	0,126	0,101	0,063	0,160	0,128	0,080	0,192	0,154	0,096	●		
N.4.1												
S.1.1	0,040	0,032	0,020	0,050	0,040	0,025	0,060	0,048	0,030	●		
S.1.2	0,040	0,032	0,020	0,050	0,040	0,025	0,060	0,048	0,030	●		
S.2.1	0,040	0,032	0,020	0,050	0,040	0,025	0,060	0,048	0,030	●		
S.2.2	0,040	0,032	0,020	0,050	0,040	0,025	0,060	0,048	0,030	●		
S.2.3	0,040	0,032	0,020	0,050	0,040	0,025	0,060	0,048	0,030	●		
S.3.1	0,080	0,064	0,040	0,100	0,080	0,050	0,120	0,096	0,060	●		
S.3.2	0,052	0,042	0,026	0,066	0,053	0,033	0,080	0,064	0,040	●		
S.3.3												
H.1.1												
H.1.2												
H.1.3												
H.1.4												
H.2.1												
H.3.1												
O.1.1												
O.1.2												
O.2.1												
O.2.2												
O.3.1												

Cutting data standard values – AluLine – End mills – ZEFP = 2

53 622 ... / 53 632 ...																
Type short		Medium-length version		Ø DC = 2 mm			Ø DC = 2,5–3,0 mm			Ø DC = 3,5–4,0 mm			Ø DC = 4,5–5,0 mm			
				a_e 0,1–0,2 x DC	a_e 0,3–0,4 x DC	a_e 0,6–1,0 x DC	a_e 0,1–0,2 x DC	a_e 0,3–0,4 x DC	a_e 0,6–1,0 x DC	a_e 0,1–0,2 x DC	a_e 0,3–0,4 x DC	a_e 0,6–1,0 x DC	a_e 0,1–0,2 x DC	a_e 0,3–0,4 x DC	a_e 0,6–1,0 x DC	
Index	v_c m/min	$a_{p,max}$ x DC	v_c m/min	$a_{p,max}$ x DC	f_z mm			f_z mm			f_z mm			f_z mm		
N.1.1	600	1,0	360	0,7	0,032	0,027	0,021	0,045	0,039	0,030	0,057	0,049	0,038	0,071	0,061	0,047
N.1.2	600	1,0	360	0,7	0,032	0,027	0,021	0,045	0,039	0,030	0,057	0,049	0,038	0,071	0,061	0,047
N.2.1	360	1,0	215	0,7	0,023	0,020	0,015	0,035	0,030	0,023	0,047	0,040	0,031	0,059	0,051	0,039
N.2.2	360	1,0	215	0,7	0,023	0,020	0,015	0,035	0,030	0,023	0,047	0,040	0,031	0,059	0,051	0,039
N.2.3	240	1,0	145	0,7	0,023	0,020	0,015	0,035	0,030	0,023	0,047	0,040	0,031	0,059	0,051	0,039
N.3.1	240	1,0	145	0,7	0,018	0,016	0,012	0,029	0,025	0,019	0,038	0,033	0,025	0,048	0,042	0,032
N.3.2	240	1,0	145	0,7	0,018	0,016	0,012	0,029	0,025	0,019	0,038	0,033	0,025	0,048	0,042	0,032
N.3.3	170	1,0	100	0,7	0,018	0,016	0,012	0,029	0,025	0,019	0,038	0,033	0,025	0,048	0,042	0,032
N.4.1	220	1,0	130	0,7	0,023	0,020	0,015	0,035	0,030	0,023	0,047	0,040	0,031	0,059	0,051	0,039

Cutting data standard values – AluLine – End mill – ZEFP = 3

53 614 ...																
Type short		Type long		Ø DC = 2,0 mm			Ø DC = 2,5–3,0 mm			Ø DC = 3,5–4,0 mm			Ø DC = 4,5–5,0 mm			
				a_e 0,1–0,2 x DC	a_e 0,3–0,4 x DC	a_e 0,6–1,0 x DC	a_e 0,1–0,2 x DC	a_e 0,3–0,4 x DC	a_e 0,6–1,0 x DC	a_e 0,1–0,2 x DC	a_e 0,3–0,4 x DC	a_e 0,6–1,0 x DC	a_e 0,1–0,2 x DC	a_e 0,3–0,4 x DC	a_e 0,6–1,0 x DC	
Index	v_c m/min	$a_{p,max}$ x DC	v_c m/min	$a_{p,max}$ x DC	f_z mm			f_z mm			f_z mm			f_z mm		
N.1.1	600	1,0	480	0,8	0,023	0,020	0,015	0,035	0,030	0,023	0,047	0,040	0,031	0,059	0,051	0,039
N.1.2	600	1,0	480	0,8	0,023	0,020	0,015	0,035	0,030	0,023	0,047	0,040	0,031	0,059	0,051	0,039
N.2.1	360	1,0	290	0,8	0,023	0,020	0,015	0,033	0,029	0,022	0,044	0,038	0,029	0,054	0,047	0,036
N.2.2	360	1,0	290	0,8	0,023	0,020	0,015	0,033	0,029	0,022	0,044	0,038	0,029	0,054	0,047	0,036
N.2.3	240	1,0	190	0,8	0,023	0,020	0,015	0,033	0,029	0,022	0,044	0,038	0,029	0,054	0,047	0,036
N.3.1	240	1,0	190	0,8	0,015	0,013	0,010	0,024	0,021	0,016	0,032	0,028	0,022	0,041	0,035	0,027
N.3.2	240	1,0	190	0,8	0,015	0,013	0,010	0,024	0,021	0,016	0,032	0,028	0,022	0,041	0,035	0,027
N.3.3	170	1,0	135	0,8	0,015	0,013	0,010	0,024	0,021	0,016	0,032	0,028	0,022	0,041	0,035	0,027
N.4.1	220	1,0	175	0,8	0,023	0,020	0,015	0,033	0,029	0,022	0,044	0,038	0,029	0,054	0,047	0,036

53 622 ... / 53 632 ...															
Index	Ø DC = 5,5–6,0 mm			Ø DC = 6,5–8,0 mm			Ø DC = 8,5–10,0 mm			Ø DC = 10,5–12 mm			● 1st choice ○ suitable		
	a_e 0,1–0,2 x DC	a_e 0,3–0,4 x DC	a_e 0,6–1,0 x DC	a_e 0,1–0,2 x DC	a_e 0,3–0,4 x DC	a_e 0,6–1,0 x DC	a_e 0,1–0,2 x DC	a_e 0,3–0,4 x DC	a_e 0,6–1,0 x DC	a_e 0,1–0,2 x DC	a_e 0,3–0,4 x DC	a_e 0,6–1,0 x DC	Emulsion	Compressed air	MMS
	f_z mm	f_z mm	f_z mm	f_z mm	f_z mm	f_z mm	f_z mm	f_z mm	f_z mm	f_z mm	f_z mm				
N.1.1	0,084	0,073	0,056	0,110	0,095	0,073	0,137	0,118	0,091	0,162	0,140	0,108	●	○*	○
N.1.2	0,084	0,073	0,056	0,110	0,095	0,073	0,137	0,118	0,091	0,162	0,140	0,108	●	○*	○
N.2.1	0,071	0,061	0,047	0,095	0,082	0,063	0,120	0,104	0,080	0,144	0,125	0,096	●	○*	○
N.2.2	0,071	0,061	0,047	0,095	0,082	0,063	0,120	0,104	0,080	0,144	0,125	0,096	●	○*	○
N.2.3	0,071	0,061	0,047	0,095	0,082	0,063	0,120	0,104	0,080	0,144	0,125	0,096	●	○*	○
N.3.1	0,058	0,050	0,039	0,078	0,068	0,052	0,098	0,085	0,065	0,119	0,103	0,079	●	○*	○
N.3.2	0,058	0,050	0,039	0,078	0,068	0,052	0,098	0,085	0,065	0,119	0,103	0,079	●	○*	○
N.3.3	0,058	0,050	0,039	0,078	0,068	0,052	0,098	0,085	0,065	0,119	0,103	0,079	●	○*	○
N.4.1	0,071	0,061	0,047	0,095	0,082	0,063	0,120	0,104	0,080	0,144	0,125	0,096	●	○*	○

53 614 ...															
Index	Ø DC = 5,5–6,0 mm			Ø DC = 6,5–8,0 mm			Ø DC = 8,5–10,0 mm			Ø DC = 10,5–12,0 mm			● 1st choice ○ suitable		
	a_e 0,1–0,2 x DC	a_e 0,3–0,4 x DC	a_e 0,6–1,0 x DC	a_e 0,1–0,2 x DC	a_e 0,3–0,4 x DC	a_e 0,6–1,0 x DC	a_e 0,1–0,2 x DC	a_e 0,3–0,4 x DC	a_e 0,6–1,0 x DC	a_e 0,1–0,2 x DC	a_e 0,3–0,4 x DC	a_e 0,6–1,0 x DC	Emulsion	Compressed air	MMS
	f_z mm	f_z mm	f_z mm	f_z mm	f_z mm	f_z mm	f_z mm	f_z mm	f_z mm	f_z mm	f_z mm	f_z mm			
N.1.1	0,071	0,061	0,047	0,095	0,082	0,063	0,120	0,104	0,080	0,144	0,125	0,096	●	○*	○
N.1.2	0,071	0,061	0,047	0,095	0,082	0,063	0,120	0,104	0,080	0,144	0,125	0,096	●	○*	○
N.2.1	0,066	0,057	0,044	0,087	0,075	0,058	0,110	0,095	0,073	0,132	0,114	0,088	●	○*	○
N.2.2	0,066	0,057	0,044	0,087	0,075	0,058	0,110	0,095	0,073	0,132	0,114	0,088	●	○*	○
N.2.3	0,066	0,057	0,044	0,087	0,075	0,058	0,110	0,095	0,073	0,132	0,114	0,088	●	○*	○
N.3.1	0,050	0,043	0,033	0,066	0,057	0,044	0,083	0,072	0,055	0,099	0,086	0,066	●	○*	○
N.3.2	0,050	0,043	0,033	0,066	0,057	0,044	0,083	0,072	0,055	0,099	0,086	0,066	●	○*	○
N.3.3	0,050	0,043	0,033	0,066	0,057	0,044	0,083	0,072	0,055	0,099	0,086	0,066	●	○*	○
N.4.1	0,066	0,057	0,044	0,087	0,075	0,058	0,110	0,095	0,073	0,132	0,114	0,088	●	○*	○

* = only suitable for DLC-coated cutters

Cutting data standard values – End mill

54 001 ... / 54 002 ...																
Index	Type short / long	Type extra long	Type short / long	Type extra long	Ø DC = 3 mm			Ø DC = 4 mm			Ø DC = 5 mm			Ø DC = 6 mm		
	V _c m/min	a _{p,max.} x DC	a _{p,max.} x DC	f _z mm	a _s 0,1-0,2 x DC	a _s 0,3-0,4 x DC	a _s 0,6-1,0 x DC	a _s 0,1-0,2 x DC	a _s 0,3-0,4 x DC	a _s 0,6-1,0 x DC	a _s 0,1-0,2 x DC	a _s 0,3-0,4 x DC	a _s 0,6-1,0 x DC	a _s 0,1-0,2 x DC	a _s 0,3-0,4 x DC	a _s 0,6-1,0 x DC
					f _z mm	f _z mm	f _z mm	f _z mm								
P.1.1	190	150	1,0	0,5	0,019	0,015	0,011	0,032	0,025	0,018	0,049	0,036	0,024	0,059	0,044	0,030
P.1.2	180	145	1,0	0,5	0,019	0,015	0,011	0,032	0,025	0,018	0,049	0,036	0,024	0,059	0,044	0,030
P.1.3	180	145	1,0	0,5	0,019	0,015	0,011	0,032	0,025	0,018	0,049	0,036	0,024	0,059	0,044	0,030
P.1.4	170	140	1,0	0,5	0,021	0,016	0,011	0,032	0,025	0,018	0,049	0,036	0,024	0,059	0,044	0,030
P.1.5	170	140	1,0	0,5	0,021	0,016	0,011	0,032	0,025	0,018	0,049	0,036	0,024	0,059	0,044	0,030
P.2.1	170	140	1,0	0,5	0,021	0,016	0,011	0,032	0,025	0,018	0,049	0,036	0,024	0,059	0,044	0,030
P.2.2	170	140	1,0	0,5	0,014	0,011	0,008	0,032	0,025	0,018	0,049	0,036	0,024	0,059	0,044	0,030
P.2.3	150	125	1,0	0,5	0,014	0,011	0,008	0,032	0,025	0,018	0,049	0,036	0,024	0,059	0,044	0,030
P.2.4	150	125	1,0	0,5	0,014	0,011	0,008	0,032	0,025	0,018	0,049	0,036	0,024	0,059	0,044	0,030
P.3.1	170	140	1,0	0,5	0,021	0,016	0,011	0,032	0,025	0,018	0,049	0,036	0,024	0,059	0,044	0,030
P.3.2	160	130	1,0	0,5	0,019	0,015	0,011	0,032	0,025	0,018	0,049	0,036	0,024	0,059	0,044	0,030
P.3.3	140	110	1,0	0,5	0,019	0,015	0,011	0,032	0,025	0,018	0,049	0,036	0,024	0,059	0,044	0,030
P.4.1																
P.4.2																
M.1.1																
M.2.1																
M.3.1																
K.1.1	180	145	1,0	0,5	0,027	0,021	0,015	0,040	0,031	0,023	0,058	0,043	0,029	0,068	0,051	0,034
K.1.2	160	130	1,0	0,5	0,021	0,016	0,011	0,040	0,031	0,023	0,058	0,043	0,029	0,068	0,051	0,034
K.2.1	170	140	1,0	0,5	0,021	0,016	0,011	0,032	0,025	0,018	0,049	0,036	0,024	0,059	0,044	0,030
K.2.2	155	125	1,0	0,5	0,021	0,016	0,011	0,032	0,025	0,018	0,049	0,036	0,024	0,059	0,044	0,030
K.3.1	150	120	1,0	0,5	0,021	0,016	0,011	0,032	0,025	0,018	0,049	0,036	0,024	0,059	0,044	0,030
K.3.2	145	120	1,0	0,5	0,021	0,016	0,011	0,032	0,025	0,018	0,049	0,036	0,024	0,059	0,044	0,030
N.1.1																
N.1.2																
N.2.1																
N.2.2																
N.2.3																
N.3.1																
N.3.2																
N.3.3																
N.4.1																
S.1.1																
S.1.2																
S.2.1																
S.2.2																
S.2.3																
S.3.1																
S.3.2																
S.3.3																
H.1.1																
H.1.2																
H.1.3																
H.1.4																
H.2.1																
H.3.1																
O.1.1																
O.1.2																
O.2.1																
O.2.2																
O.3.1																

 "Extra-long" version: when profiling with an a_s of 0.1-0.4 x DC an a_p of 1.0 x DC should be used.

 Plunging angle for ramping and helical milling: 3°

54 001 ... / 54 002 ...												
Index	Ø DC = 8 mm			Ø DC = 10 mm			Ø DC = 12 mm			● 1st choice		○ suitable
	a_p 0,1-0,2 x DC	a_p 0,3-0,4 x DC	a_p 0,6-1,0 x DC	a_p 0,1-0,2 x DC	a_p 0,3-0,4 x DC	a_p 0,6-1,0 x DC	a_p 0,1-0,2 x DC	a_p 0,3-0,4 x DC	a_p 0,6-1,0 x DC	Emulsion	Compressed air	MMS
	f_z mm			f_z mm			f_z mm					
P.1.1	0,070	0,050	0,040	0,090	0,070	0,050	0,110	0,080	0,050	●	○	○
P.1.2	0,070	0,050	0,040	0,090	0,070	0,050	0,110	0,080	0,050	●	○	○
P.1.3	0,070	0,050	0,040	0,090	0,070	0,050	0,110	0,080	0,050	●	○	○
P.1.4	0,070	0,050	0,040	0,090	0,070	0,050	0,110	0,080	0,050	●	○	○
P.1.5	0,070	0,050	0,040	0,090	0,070	0,050	0,110	0,080	0,050	●	○	○
P.2.1	0,070	0,050	0,040	0,090	0,070	0,050	0,110	0,080	0,050	●	○	○
P.2.2	0,070	0,050	0,040	0,090	0,070	0,050	0,110	0,080	0,050	●	○	○
P.2.3	0,070	0,050	0,040	0,090	0,070	0,050	0,110	0,080	0,050	●	○	○
P.2.4	0,070	0,050	0,040	0,090	0,070	0,050	0,110	0,080	0,050	●	○	○
P.3.1	0,070	0,050	0,040	0,090	0,070	0,050	0,110	0,080	0,050	●	○	○
P.3.2	0,070	0,050	0,040	0,090	0,070	0,050	0,110	0,080	0,050	●	●	○
P.3.3	0,070	0,050	0,040	0,090	0,070	0,050	0,110	0,080	0,050	●	●	○
P.4.1												
P.4.2												
M.1.1												
M.2.1												
M.3.1												
K.1.1	0,080	0,060	0,040	0,100	0,080	0,050	0,130	0,090	0,060	●	●	●
K.1.2	0,080	0,060	0,040	0,100	0,080	0,050	0,130	0,090	0,060	●	●	●
K.2.1	0,070	0,050	0,040	0,090	0,070	0,050	0,110	0,080	0,050	●	●	●
K.2.2	0,070	0,050	0,040	0,090	0,070	0,050	0,110	0,080	0,050	●	●	●
K.3.1	0,070	0,050	0,040	0,090	0,070	0,050	0,110	0,080	0,050	●	●	●
K.3.2	0,070	0,050	0,040	0,090	0,070	0,050	0,110	0,080	0,050	●	●	●
N.1.1												
N.1.2												
N.2.1												
N.2.2												
N.2.3												
N.3.1												
N.3.2												
N.3.3												
N.4.1												
S.1.1												
S.1.2												
S.2.1												
S.2.2												
S.2.3												
S.3.1												
S.3.2												
S.3.3												
H.1.1												
H.1.2												
H.1.3												
H.1.4												
H.2.1												
H.3.1												
O.1.1												
O.1.2												
O.2.1												
O.2.2												
O.3.1												

Cutting data standard values – End mill

54 005 ... / 54 006 ...																
Index	Type short / long	Type extra long	Type short / long	Type extra long	Ø DC = 3 mm			Ø DC = 4 mm			Ø DC = 5 mm			Ø DC = 6 mm		
	V _c m/min	a _{p,max.} x DC	a _{p,max.} x DC	f _z mm	a _s 0,1-0,2 x DC	a _s 0,3-0,4 x DC	a _s 0,6-1,0 x DC	a _s 0,1-0,2 x DC	a _s 0,3-0,4 x DC	a _s 0,6-1,0 x DC	a _s 0,1-0,2 x DC	a _s 0,3-0,4 x DC	a _s 0,6-1,0 x DC	a _s 0,1-0,2 x DC	a _s 0,3-0,4 x DC	a _s 0,6-1,0 x DC
					f _z mm			f _z mm			f _z mm			f _z mm		
P.1.1	180	140	1,0	0,5	0,017	0,013	0,010	0,029	0,022	0,016	0,043	0,032	0,022	0,053	0,039	0,026
P.1.2	170	135	1,0	0,5	0,017	0,013	0,010	0,029	0,022	0,016	0,043	0,032	0,022	0,053	0,039	0,026
P.1.3	170	135	1,0	0,5	0,017	0,013	0,010	0,029	0,022	0,016	0,043	0,032	0,022	0,053	0,039	0,026
P.1.4	160	130	1,0	0,5	0,018	0,014	0,010	0,029	0,022	0,016	0,043	0,032	0,022	0,053	0,039	0,026
P.1.5	160	130	1,0	0,5	0,018	0,014	0,010	0,029	0,022	0,016	0,043	0,032	0,022	0,053	0,039	0,026
P.2.1	160	130	1,0	0,5	0,018	0,014	0,010	0,029	0,022	0,016	0,043	0,032	0,022	0,053	0,039	0,026
P.2.2	160	130	1,0	0,5	0,012	0,009	0,007	0,029	0,022	0,016	0,043	0,032	0,022	0,053	0,039	0,026
P.2.3	140	115	1,0	0,5	0,012	0,009	0,007	0,029	0,022	0,016	0,043	0,032	0,022	0,053	0,039	0,026
P.2.4	140	115	1,0	0,5	0,012	0,009	0,007	0,029	0,022	0,016	0,043	0,032	0,022	0,053	0,039	0,026
P.3.1	160	130	1,0	0,5	0,018	0,014	0,010	0,029	0,022	0,016	0,043	0,032	0,022	0,053	0,039	0,026
P.3.2	150	120	1,0	0,5	0,017	0,013	0,010	0,029	0,022	0,016	0,043	0,032	0,022	0,053	0,039	0,026
P.3.3	130	100	1,0	0,5	0,017	0,013	0,010	0,029	0,022	0,016	0,043	0,032	0,022	0,053	0,039	0,026
P.4.1	100	80	1,0	0,5	0,012	0,009	0,007	0,018	0,014	0,010	0,027	0,020	0,014	0,036	0,027	0,018
P.4.2	100	80	1,0	0,5	0,012	0,009	0,007	0,018	0,014	0,010	0,027	0,020	0,014	0,036	0,027	0,018
M.1.1	100	80	1,0	0,5	0,012	0,009	0,007	0,018	0,014	0,010	0,027	0,020	0,014	0,036	0,027	0,018
M.2.1	85	70	1,0	0,5	0,012	0,009	0,007	0,018	0,014	0,010	0,027	0,020	0,014	0,036	0,027	0,018
M.3.1	100	80	1,0	0,5	0,012	0,009	0,007	0,018	0,014	0,010	0,027	0,020	0,014	0,036	0,027	0,018
K.1.1	170	135	1,0	0,5	0,024	0,019	0,014	0,036	0,028	0,020	0,051	0,038	0,026	0,061	0,045	0,030
K.1.2	140	110	1,0	0,5	0,018	0,014	0,010	0,036	0,028	0,020	0,051	0,038	0,026	0,061	0,045	0,030
K.2.1	160	130	1,0	0,5	0,018	0,014	0,010	0,029	0,022	0,016	0,043	0,032	0,022	0,053	0,039	0,026
K.2.2	130	100	1,0	0,5	0,018	0,014	0,010	0,029	0,022	0,016	0,043	0,032	0,022	0,053	0,039	0,026
K.3.1	140	110	1,0	0,5	0,018	0,014	0,010	0,029	0,022	0,016	0,043	0,032	0,022	0,053	0,039	0,026
K.3.2	135	110	1,0	0,5	0,018	0,014	0,010	0,029	0,022	0,016	0,043	0,032	0,022	0,053	0,039	0,026
N.1.1																
N.1.2																
N.2.1																
N.2.2																
N.2.3																
N.3.1	300	240	1,0	0,5	0,029	0,022	0,016	0,038	0,029	0,021	0,054	0,041	0,027	0,065	0,048	0,032
N.3.2	240	190	1,0	0,5	0,029	0,022	0,016	0,038	0,029	0,021	0,054	0,041	0,027	0,065	0,048	0,032
N.3.3	240	190	1,0	0,5	0,029	0,022	0,016	0,038	0,029	0,021	0,054	0,041	0,027	0,065	0,048	0,032
N.4.1																
S.1.1	25	20	0,5	0,3	0,011	0,008	0,006	0,015	0,012	0,009	0,022	0,016	0,011	0,029	0,022	0,014
S.1.2	25	20	0,5	0,3	0,011	0,008	0,006	0,015	0,012	0,009	0,022	0,016	0,011	0,029	0,022	0,014
S.2.1	25	20	0,5	0,3	0,011	0,008	0,006	0,015	0,012	0,009	0,022	0,016	0,011	0,029	0,022	0,014
S.2.2	25	20	0,5	0,3	0,011	0,008	0,006	0,015	0,012	0,009	0,022	0,016	0,011	0,029	0,022	0,014
S.2.3	25	20	0,5	0,3	0,011	0,008	0,006	0,015	0,012	0,009	0,022	0,016	0,011	0,029	0,022	0,014
S.3.1	100	70	0,5	0,3	0,021	0,017	0,012	0,031	0,024	0,017	0,046	0,034	0,023	0,056	0,042	0,028
S.3.2	80	60	0,5	0,3	0,015	0,012	0,009	0,023	0,018	0,013	0,034	0,025	0,017	0,043	0,032	0,021
S.3.3																
H.1.1																
H.1.2																
H.1.3																
H.1.4																
H.2.1																
H.3.1																
O.1.1																
O.1.2																
O.2.1																
O.2.2																
O.3.1																

 "Extra-long" version: when profiling with an a_s of 0.1-0.4 x DC an a_p of 1.0 x DC should be used.

 Plunging angle for ramping and helical milling: 3°

54 005 ... / 54 006 ...												
Index	Ø DC = 8 mm			Ø DC = 10 mm			Ø DC = 12 mm			● 1st choice		○ suitable
	a_p 0,1-0,2 x DC	a_p 0,3-0,4 x DC	a_p 0,6-1,0 x DC	a_p 0,1-0,2 x DC	a_p 0,3-0,4 x DC	a_p 0,6-1,0 x DC	a_p 0,1-0,2 x DC	a_p 0,3-0,4 x DC	a_p 0,6-1,0 x DC	Emulsion	Compressed air	MMS
	f_z mm			f_z mm			f_z mm					
P.1.1	0,060	0,050	0,030	0,080	0,060	0,040	0,100	0,070	0,050	●	○	○
P.1.2	0,060	0,050	0,030	0,080	0,060	0,040	0,100	0,070	0,050	●	○	○
P.1.3	0,060	0,050	0,030	0,080	0,060	0,040	0,100	0,070	0,050	●	○	○
P.1.4	0,060	0,050	0,030	0,080	0,060	0,040	0,100	0,070	0,050	●	○	○
P.1.5	0,060	0,050	0,030	0,080	0,060	0,040	0,100	0,070	0,050	●	○	○
P.2.1	0,060	0,050	0,030	0,080	0,060	0,040	0,100	0,070	0,050	●	○	○
P.2.2	0,060	0,050	0,030	0,080	0,060	0,040	0,100	0,070	0,050	●	○	○
P.2.3	0,060	0,050	0,030	0,080	0,060	0,040	0,100	0,070	0,050	●	○	○
P.2.4	0,060	0,050	0,030	0,080	0,060	0,040	0,100	0,070	0,050	●	○	○
P.3.1	0,060	0,050	0,030	0,080	0,060	0,040	0,100	0,070	0,050	●	○	○
P.3.2	0,060	0,050	0,030	0,080	0,060	0,040	0,100	0,070	0,050	●	○	○
P.3.3	0,060	0,050	0,030	0,080	0,060	0,040	0,100	0,070	0,050	●	○	○
P.4.1	0,040	0,030	0,020	0,050	0,040	0,030	0,070	0,050	0,030	●		
P.4.2	0,040	0,030	0,020	0,050	0,040	0,030	0,070	0,050	0,030	●		
M.1.1	0,040	0,030	0,020	0,050	0,040	0,030	0,070	0,050	0,030	●		
M.2.1	0,040	0,030	0,020	0,050	0,040	0,030	0,070	0,050	0,030	●		
M.3.1	0,040	0,030	0,020	0,050	0,040	0,030	0,070	0,050	0,030	●		
K.1.1	0,070	0,050	0,040	0,090	0,070	0,050	0,110	0,080	0,060	●	●	●
K.1.2	0,070	0,050	0,040	0,090	0,070	0,050	0,110	0,080	0,060	●	●	●
K.2.1	0,060	0,050	0,030	0,080	0,060	0,040	0,100	0,070	0,050	●	●	●
K.2.2	0,060	0,050	0,030	0,080	0,060	0,040	0,100	0,070	0,050	●	●	●
K.3.1	0,060	0,050	0,030	0,080	0,060	0,040	0,100	0,070	0,050	●	●	●
K.3.2	0,060	0,050	0,030	0,080	0,060	0,040	0,100	0,070	0,050	●	●	●
N.1.1												
N.1.2												
N.2.1												
N.2.2												
N.2.3												
N.3.1	0,080	0,060	0,040	0,100	0,070	0,050	0,140	0,110	0,070	●		
N.3.2	0,080	0,060	0,040	0,100	0,070	0,050	0,140	0,110	0,070	●		
N.3.3	0,080	0,060	0,040	0,100	0,070	0,050	0,140	0,110	0,070	●		
N.4.1												
S.1.1	0,030	0,030	0,020	0,040	0,030	0,020	0,060	0,040	0,030	●		
S.1.2	0,030	0,030	0,020	0,040	0,030	0,020	0,060	0,040	0,030	●		
S.2.1	0,030	0,030	0,020	0,040	0,030	0,020	0,060	0,040	0,030	●		
S.2.2	0,030	0,030	0,020	0,040	0,030	0,020	0,060	0,040	0,030	●		
S.2.3	0,030	0,030	0,020	0,040	0,030	0,020	0,060	0,020	0,030	●		
S.3.1	0,070	0,050	0,030	0,090	0,060	0,040	0,120	0,090	0,060	●		
S.3.2	0,050	0,040	0,030	0,070	0,050	0,030	0,090	0,070	0,050	●		
S.3.3												
H.1.1												
H.1.2												
H.1.3												
H.1.4												
H.2.1												
H.3.1												
O.1.1												
O.1.2												
O.2.1												
O.2.2												
O.3.1												

Cutting data standard values – Micro cutter – 2.2xDC

		52 802 ...																	
		Ø DC = 0,2–0,4 mm					Ø DC = 0,5–0,7 mm					Ø DC = 0,8–0,9 mm							
		a _e	0,1 x DC	0,2 x DC	0,3 x DC	0,4 x DC	0,6–1,0 x DC	a _e	0,1 x DC	0,2 x DC	0,3 x DC	0,4 x DC	0,6–1,0 x DC	a _e	0,1 x DC	0,2 x DC	0,3 x DC	0,4 x DC	0,6–1,0 x DC
		a _{p,max.}	0,02	0,02	0,02	0,01	0,01	a _{p,max.}	0,1	0,1	0,1	0,1	0,05	a _{p,max.}	0,2	0,2	0,2	0,2	0,12
		n _{min.}	30.000					n _{min.}	12.000					n _{min.}	8.000				
Index	n	v _f mm/min.					n	v _f mm/min.					n	v _f mm/min.					
P.1.1	50.000	232	202	174	144	116	50.000	274	238	205	170	137	50.000	485	422	364	301	242	
P.1.2	50.000	232	202	174	144	116	50.000	274	238	205	170	137	50.000	485	422	364	301	242	
P.1.3	50.000	232	202	174	144	116	50.000	274	238	205	170	137	50.000	485	422	364	301	242	
P.1.4	50.000	201	175	151	125	101	50.000	237	206	178	147	119	50.000	420	365	315	260	210	
P.1.5	50.000	201	175	151	125	101	50.000	237	206	178	147	119	50.000	420	365	315	260	210	
P.2.1	50.000	232	202	174	144	116	50.000	274	238	205	170	137	50.000	485	422	364	301	242	
P.2.2	50.000	232	202	174	144	116	50.000	274	238	205	170	137	50.000	485	422	364	301	242	
P.2.3	50.000	201	175	151	125	101	50.000	237	206	178	147	119	50.000	420	365	315	260	210	
P.2.4	50.000	201	175	151	125	101	50.000	237	206	178	147	119	50.000	420	365	315	260	210	
P.3.1	50.000	201	175	151	125	101	50.000	237	206	178	147	119	50.000	420	365	315	260	210	
P.3.2	50.000	232	202	174	144	116	50.000	274	238	205	170	137	50.000	485	422	364	301	242	
P.3.3	50.000	201	175	151	125	101	50.000	237	206	178	147	119	50.000	420	365	315	260	210	
P.4.1	50.000	232	202	174	144	116	50.000	274	238	205	170	137	50.000	485	422	364	301	242	
P.4.2	50.000	232	202	174	144	116	50.000	274	238	205	170	137	50.000	485	422	364	301	242	
M.1.1	50.000	232	202	174	144	116	50.000	274	238	205	170	137	50.000	485	422	364	301	242	
M.2.1	50.000	232	202	174	144	116	50.000	274	238	205	170	137	50.000	485	422	364	301	242	
M.3.1	50.000	232	202	174	144	116	50.000	274	238	205	170	137	50.000	485	422	364	301	242	
K.1.1	50.000	232	202	174	144	116	50.000	274	238	205	170	137	50.000	485	422	364	301	242	
K.1.2	50.000	232	202	174	144	116	50.000	274	238	205	170	137	50.000	485	422	364	301	242	
K.2.1	50.000	232	202	174	144	116	50.000	274	238	205	170	137	50.000	485	422	364	301	242	
K.2.2	50.000	232	202	174	144	116	50.000	274	238	205	170	137	50.000	485	422	364	301	242	
K.3.1	50.000	141	123	106	88	71	50.000	175	152	131	109	88	32.000	285	248	213	176	142	
K.3.2	50.000	141	123	106	88	71	50.000	175	152	131	109	88	32.000	285	248	213	176	142	
N.1.1	50.000	232	202	174	144	116	50.000	274	238	205	170	137	50.000	582	506	436	361	291	
N.1.2	50.000	232	202	174	144	116	50.000	274	238	205	170	137	50.000	582	506	436	361	291	
N.2.1																			
N.2.2																			
N.2.3																			
N.3.1	50.000	232	202	174	144	116	50.000	274	238	205	170	137	44.000	485	422	364	301	242	
N.3.2	50.000	232	202	174	144	116	50.000	274	238	205	170	137	50.000	582	506	436	361	291	
N.3.3	50.000	232	202	174	144	116	50.000	274	238	205	170	137	50.000	582	506	436	361	291	
N.4.1	50.000	212	185	159	132	106	50.000	250	218	188	155	125	50.000	531	462	398	329	266	
S.1.1	50.000	46	40	35	29	23	30.000	55	48	41	34	27	19.000	69	60	51	43	34	
S.1.2	50.000	46	40	35	29	23	30.000	55	48	41	34	27	19.000	69	60	51	43	34	
S.2.1	50.000	72	62	54	44	36	50.000	89	77	66	55	44	25.000	91	79	68	56	45	
S.2.2	50.000	46	40	35	29	23	30.000	55	48	41	34	27	19.000	69	60	51	43	34	
S.2.3	50.000	54	47	41	34	27	30.000	66	57	49	41	33	12.000	78	68	59	49	39	
S.3.1	50.000	114	99	85	71	57	50.000	164	143	123	102	82	44.000	114	99	85	71	57	
S.3.2	50.000	114	99	85	71	57	50.000	164	143	123	102	82	44.000	164	143	123	102	82	
S.3.3	50.000	70	61	53	43	35	50.000	85	74	64	53	42	38.000	101	88	76	63	51	
H.1.1	50.000	219	191	164	136	110	50.000	232	202	174	144	116	50.000	388	338	291	241	194	
H.1.2	50.000	201	175	151	125	101	50.000	285	248	213	176	142	38.000	336	292	252	208	168	
H.1.3	50.000	114	99	85	71	57	50.000	134	117	101	83	67	25.000	156	136	117	97	78	
H.1.4	50.000	107	93	80	67	54	50.000	126	110	95	78	63	25.000	141	123	106	88	71	
H.2.1	50.000	219	191	164	136	110	50.000	232	202	174	144	116	50.000	388	338	291	241	194	
H.3.1	50.000	201	175	151	125	101	50.000	285	248	213	176	142	38.000	336	292	252	208	168	
O.1.1	50.000	232	202	174	144	116	50.000	274	238	205	170	137	50.000	582	506	436	361	291	
O.1.2	50.000	232	202	174	144	116	50.000	274	238	205	170	137	50.000	582	506	436	361	291	
O.2.1	50.000	212	185	159	132	106	50.000	200	174	150	124	100	38.000	316	275	237	196	158	
O.2.2	50.000	212	185	159	132	106	50.000	200	174	150	124	100	38.000	316	275	237	196	158	
O.3.1																			

52 802 ...																	
Ø DC = 1,0–1,4 mm											Ø DC = 1,5–1,7 mm					● 1st choice	
Ø DC = 1,0–1,4 mm											Ø DC = 1,5–1,7 mm					○ suitable	
Index	n	v _f mm/min.					n	v _f mm/min.					Emulsion	Compressed air	MMS		
		a _e	0,1 x DC	0,2 x DC	0,3 x DC	0,4 x DC		0,6–1,0 x DC	a _e	0,1 x DC	0,2 x DC	0,3 x DC				0,4 x DC	0,6–1,0 x DC
		a _{p,max.}	0,3	0,3	0,3	0,3		0,2	a _{p,max.}	0,45	0,45	0,45				0,45	0,3
		n _{min.}							n _{min.}								
		6.500							6.500								
P.1.1	50.000	775	674	581	480	387	33.000	1200	1044	900	744	600	●	○	○		
P.1.2	50.000	775	674	581	480	387	33.000	1200	1044	900	744	600	●	○	○		
P.1.3	50.000	775	674	581	480	387	33.000	1200	1044	900	744	600	●	○	○		
P.1.4	50.000	671	584	503	416	335	33.000	1039	904	779	644	520	●	○	○		
P.1.5	50.000	671	584	503	416	335	33.000	1039	904	779	644	520	●	○	○		
P.2.1	50.000	775	674	581	480	387	33.000	1200	1044	900	744	600		●	○		
P.2.2	50.000	775	674	581	480	387	33.000	1200	1044	900	744	600		●	○		
P.2.3	50.000	671	584	503	416	335	33.000	1039	904	779	644	520		●	○		
P.2.4	50.000	671	584	503	416	335	33.000	1039	904	779	644	520		●	○		
P.3.1	50.000	671	584	503	416	335	33.000	1039	904	779	644	520		●	○		
P.3.2	50.000	775	674	581	480	387	33.000	1200	1044	900	744	600		●	○		
P.3.3	50.000	671	584	503	416	335	33.000	1039	904	779	644	520		●	○		
P.4.1	50.000	775	674	581	480	387	33.000	1200	1044	900	744	600		●	○		
P.4.2	50.000	775	674	581	480	387	33.000	1200	1044	900	744	600		●	○		
M.1.1	50.000	775	674	581	480	387	33.000	1200	1044	900	744	600	●		○		
M.2.1	50.000	775	674	581	480	387	33.000	1200	1044	900	744	600	●		○		
M.3.1	50.000	775	674	581	480	387	33.000	1200	1044	900	744	600	●		○		
K.1.1	50.000	775	674	581	480	387	33.000	1200	1044	900	744	600	○	●			
K.1.2	50.000	775	674	581	480	387	33.000	1200	1044	900	744	600	○	●			
K.2.1	50.000	775	674	581	480	387	33.000	1200	1044	900	744	600	○	●			
K.2.2	50.000	775	674	581	480	387	33.000	1200	1044	900	744	600	○	●			
K.3.1	50.000	389	338	292	241	194	21.000	548	477	411	340	274		●			
K.3.2	25.000	389	338	292	241	194	21.000	548	477	411	340	274		●			
N.1.1	50.000	930	809	697	576	465	50.000	1500	1305	1125	930	750	●		○		
N.1.2	50.000	930	809	697	576	465	50.000	1500	1305	1125	930	750	●		○		
N.2.1																	
N.2.2																	
N.2.3																	
N.3.1	44.000	775	674	581	480	387	29.000	1160	1009	870	719	580	●		○		
N.3.2	50.000	930	809	697	576	465	38.000	1400	1218	1050	868	700	●		○		
N.3.3	50.000	930	809	697	576	465	38.000	1400	1218	1050	868	700	●		○		
N.4.1	50.000	849	738	636	526	424	38.000	1388	1207	1041	860	694	●		○		
S.1.1	15.000	99	86	74	61	49	12.000	170	148	127	105	85	●		○		
S.1.2	15.000	99	86	74	61	49	12.000	170	148	127	105	85	●		○		
S.2.1	25.000	152	132	114	94	76	16.000	294	256	220	182	147	●		○		
S.2.2	15.000	99	86	74	61	49	12.000	170	148	127	105	85	●		○		
S.2.3	12.000	131	114	99	82	66	8.000	255	221	191	158	127	●		○		
S.3.1	44.000	170	148	127	105	85	29.000	329	286	246	204	164	●		○		
S.3.2	44.000	247	215	186	153	124	29.000	365	318	274	226	183	●		○		
S.3.3	38.000	170	148	127	105	85	25.000	329	286	246	204	164	●		○		
H.1.1	50.000	620	539	465	384	310	33.000	850	740	638	527	425		●			
H.1.2	38.000	537	467	402	333	268	25.000	779	678	585	483	390		●			
H.1.3	25.000	235	204	176	146	117	16.000	346	301	260	215	173		●			
H.1.4	25.000	221	193	166	137	111	16.000	327	284	245	202	163		●			
H.2.1	50.000	620	539	465	384	310	33.000	850	740	638	527	425		●			
H.3.1	38.000	537	467	402	333	268	25.000	779	678	585	483	390		●			
O.1.1	50.000	930	809	697	576	465	38.000	1520	1322	1140	942	760	●	○	○		
O.1.2	50.000	930	809	697	576	465	33.000	1320	1148	990	818	660	●	○	○		
O.2.1	38.000	495	431	371	307	247	25.000	685	596	513	424	342	●	○	○		
O.2.2	38.000	495	431	371	307	247	25.000	685	596	513	424	342	●	○	○		
O.3.1																	

Cutting data standard values – Micro cutter – 2.2xDC

		52 802 ...														
		Ø DC = 1,8–1,9 mm					Ø DC = 2,0 mm					●	1st choice			
		Ø DC = 1,8–1,9 mm					Ø DC = 2,0 mm					○	suitable			
		a _e	0,1 x DC	0,2 x DC	0,3 x DC	0,4 x DC	0,6–1,0 x DC	a _e	0,1 x DC	0,2 x DC	0,3 x DC	0,4 x DC	0,6–1,0 x DC	Emulsion	Compressed air	MMS
		a _{p,max.}	0,54	0,54	0,54	0,54	0,36	a _{p,max.}	0,6	0,6	0,6	0,6	0,4			
		n _{min.}	5.500					n _{min.}	5.000							
Index	n	v _f mm/min.					n	v _f mm/min.								
P.1.1	29.000	1300	1131	975	806	650	25.000	1500	1300	1125	930	750	●	○	○	
P.1.2	29.000	1300	1131	975	806	650	25.000	1500	1300	1125	930	750	●	○	○	
P.1.3	29.000	1300	1131	975	806	650	25.000	1500	1300	1125	930	750	●	○	○	
P.1.4	29.000	1300	1131	975	806	650	25.000	1500	1300	1125	930	750	●	○	○	
P.1.5	29.000	1300	1131	975	806	650	25.000	1500	1300	1125	930	750	●	○	○	
P.2.1	29.000	1300	1131	975	806	650	25.000	1500	1300	1125	930	750		●	○	
P.2.2	29.000	1300	1131	975	806	650	25.000	1500	1300	1125	930	750		●	○	
P.2.3	29.000	1300	1131	975	806	650	25.000	1500	1300	1125	930	750		●	○	
P.2.4	29.000	1300	1131	975	806	650	25.000	1500	1300	1125	930	750		●	○	
P.3.1	29.000	1300	1131	975	806	650	25.000	1500	1300	1125	930	750		●	○	
P.3.2	29.000	1300	1131	975	806	650	25.000	1500	1300	1125	930	750		●	○	
P.3.3	29.000	1300	1131	975	806	650	25.000	1500	1300	1125	930	750		●	○	
P.4.1	29.000	1300	1131	975	806	650	25.000	1500	1300	1125	930	750		●	○	
P.4.2	29.000	1300	1131	975	806	650	25.000	1500	1300	1125	930	750		●	○	
M.1.1	29.000	1300	1131	975	806	650	25.000	1500	1300	1125	930	750	●		○	
M.2.1	29.000	1300	1131	975	806	650	25.000	1500	1300	1125	930	750	●		○	
M.3.1	29.000	1300	1131	975	806	650	25.000	1500	1300	1125	930	750	●		○	
K.1.1	29.000	1300	1131	975	806	650	25.000	1500	1300	1125	930	750	○	●		
K.1.2	29.000	1300	1131	975	806	650	25.000	1500	1300	1125	930	750	○	●		
K.2.1	29.000	1300	1131	975	806	650	25.000	1500	1300	1125	930	750	○	●		
K.2.2	29.000	1300	1131	975	806	650	25.000	1500	1300	1125	930	750	○	●		
K.3.1	18.000	630	548	473	391	315	12.000	750	650	550	450	350		●		
K.3.2	18.000	630	548	473	391	315	12.000	750	650	550	450	350		●		
N.1.1	44.000	1800	1566	1350	1116	900	25.000	1500	1300	1125	930	750	●		○	
N.1.2	44.000	1800	1566	1350	1116	900	25.000	1500	1300	1125	930	750	●		○	
N.2.1																
N.2.2																
N.2.3																
N.3.1	25.000	1250	1088	938	775	625	19.000	1140	990	855	700	570	●		○	
N.3.2	32.000	1520	1322	1140	942	760	25.000	1500	1300	1125	930	750	●		○	
N.3.3	32.000	1520	1322	1140	942	760	25.000	1500	1300	1125	930	750	●		○	
N.4.1	33.000	1560	1357	1170	967	780	25.000	1500	1300	1125	930	750	●		○	
S.1.1	10.000	280	244	210	174	140	7.500	300	260	230	200	160	●		○	
S.1.2	10.000	280	244	210	174	140	7.500	300	260	230	200	160	●		○	
S.2.1	14.000	420	365	315	260	210	12.500	500	400	350	300	250	●		○	
S.2.2	10.000	280	244	210	174	140	7.500	300	260	230	200	160	●		○	
S.2.3	7.000	370	322	278	229	185	6.000	300	260	230	200	160	●		○	
S.3.1	25.000	400	348	300	248	200	25.000	1500	1300	1125	930	750	●		○	
S.3.2	25.000	480	418	360	298	240	25.000	1500	1300	1125	930	750	●		○	
S.3.3	22.000	380	331	285	236	190	25.000	1500	1300	1125	930	750	●		○	
H.1.1	29.000	1200	1044	900	744	600	25.000	1500	1300	1125	930	750		●		
H.1.2	22.000	1000	870	750	620	500	19.000	1140	990	855	700	570		●		
H.1.3	14.000	420	365	315	260	210	19.000	1140	990	855	700	570		●		
H.1.4	14.000	420	365	315	260	210	19.000	1140	990	855	700	570		●		
H.2.1	29.000	1200	1044	900	744	600	25.000	1500	1300	1125	930	750		●		
H.3.1	22.000	1000	870	750	620	500	19.000	1140	990	855	700	570		●		
O.1.1	33.000	1560	1357	1170	967	780	19.000	1140	990	855	700	570	●	○	○	
O.1.2	28.000	1400	1218	1050	868	700	19.000	1140	990	855	700	570	●	○	○	
O.2.1	22.000	800	696	600	496	400	12.000	720	630	540	450	360	●	○	○	
O.2.2	22.000	800	696	600	496	400	12.000	720	630	540	450	360	●	○	○	
O.3.1																

Cutting data standard values – Micro cutter – 5xDC

		52 802 ...																			
		Ø DC = 0,2–0,4 mm				Ø DC = 0,5–0,7 mm					Ø DC = 0,8–0,9 mm						●	1st choice			
																	○	suitable			
		a_e	0,1 x DC	0,2 x DC	0,3 x DC	0,4 x DC	a_e	0,1 x DC	0,2 x DC	0,3 x DC	0,4 x DC	a_e	0,1 x DC	0,2 x DC	0,3 x DC	0,4 x DC	0,6–1,0 x DC	Emulsion	Compressed air	MMS	
		$a_{p,max.}$	0,012	0,012	0,012	0,012	$a_{p,max.}$	0,06	0,06	0,06	0,06	$a_{p,max.}$	0,12	0,12	0,12	0,12	0,064				
		$n_{min.}$	30.000				$n_{min.}$	12.000					$n_{min.}$	8.000							
Index	n	V_f mm/min.				n	V_f mm/min.					n	V_f mm/min.								
P.1.1	50.000	232	202	174	144	50.000	274	238	205	170	44.000	485	422	364	301	242	●	○	○		
P.1.2	50.000	232	202	174	144	50.000	274	238	205	170	44.000	485	422	364	301	242	●	○	○		
P.1.3	50.000	232	202	174	144	50.000	274	238	205	170	44.000	485	422	364	301	242	●	○	○		
P.1.4	50.000	201	175	151	125	50.000	237	206	178	147	31.000	330	287	248	205	165	●	○	○		
P.1.5	50.000	201	175	151	125	50.000	237	206	178	147	31.000	330	287	248	205	165	●	○	○		
P.2.1	50.000	232	202	174	144	50.000	274	238	205	170	44.000	485	422	364	301	242		●	○		
P.2.2	50.000	232	202	174	144	50.000	274	238	205	170	44.000	485	422	364	301	242		●	○		
P.2.3	50.000	201	175	151	125	50.000	237	206	178	147	31.000	330	287	248	205	165		●	○		
P.2.4	50.000	201	175	151	125	50.000	237	206	178	147	31.000	330	287	248	205	165		●	○		
P.3.1	50.000	201	175	151	125	50.000	237	206	178	147	31.000	330	287	248	205	165		●	○		
P.3.2	50.000	232	202	174	144	50.000	274	238	205	170	44.000	485	422	364	301	242		●	○		
P.3.3	50.000	201	175	151	125	50.000	237	206	178	147	31.000	330	287	248	205	165		●	○		
P.4.1	50.000	232	202	174	144	50.000	274	238	205	170	44.000	485	422	364	301	242		●	○		
P.4.2	50.000	232	202	174	144	50.000	274	238	205	170	44.000	485	422	364	301	242		●	○		
M.1.1	50.000	232	202	174	144	50.000	219	191	164	136	31.000	346	301	260	215	173	●		○		
M.2.1	50.000	232	202	174	144	50.000	219	191	164	136	31.000	346	301	260	215	173	●		○		
M.3.1	50.000	232	202	174	144	50.000	219	191	164	136	31.000	346	301	260	215	173	●		○		
K.1.1	50.000	232	202	174	144	50.000	219	191	164	136	50.000	416	362	312	258	208	○	●			
K.1.2	50.000	232	202	174	144	50.000	219	191	164	136	50.000	416	362	312	258	208	○	●			
K.2.1	50.000	232	202	174	144	50.000	219	191	164	136	50.000	416	362	312	258	208	○	●			
K.2.2	50.000	232	202	174	144	50.000	219	191	164	136	50.000	416	362	312	258	208	○	●			
K.3.1	50.000	141	123	106	88	50.000	175	152	131	109	25.000	240	209	180	149	120		●			
K.3.2	50.000	141	123	106	88	50.000	175	152	131	109	25.000	240	209	180	149	120		●			
N.1.1	50.000	232	202	174	144	50.000	274	238	205	170	50.000	554	482	416	344	277	●		○		
N.1.2	50.000	232	202	174	144	50.000	274	238	205	170	50.000	554	482	416	344	277	●		○		
N.2.1																					
N.2.2																					
N.2.3																					
N.3.1	50.000	232	202	174	144	50.000	274	238	205	170	38.000	485	422	364	301	242	●		○		
N.3.2	50.000	232	202	174	144	50.000	274	238	205	170	50.000	554	482	416	344	277	●		○		
N.3.3	50.000	232	202	174	144	50.000	274	238	205	170	50.000	554	482	416	344	277	●		○		
N.4.1	50.000	212	185	159	132	50.000	250	218	188	155	50.000	506	440	379	314	253	●		○		
S.1.1	50.000	55	48	41	32	31.000	58	51	44	36	15.000	98	85	73	61	49	●		○		
S.1.2	50.000	55	48	41	32	31.000	58	51	44	36	15.000	98	85	73	61	49	●		○		
S.2.1	50.000	63	54	47	39	44.000	76	66	57	47	22.000	91	79	68	56	45	●		○		
S.2.2	50.000	55	47	40	32	31.000	58	51	44	36	15.000	98	85	73	61	49	●		○		
S.2.3	50.000	46	40	35	29	25.000	55	48	41	34	12.000	78	68	59	49	39	●		○		
S.3.1	50.000	60	61	48	41	50.000	71	62	53	44	38.000	114	99	85	71	57	●		○		
S.3.2	50.000	60	61	48	41	50.000	71	62	53	44	38.000	126	110	95	78	63	●		○		
S.3.3	50.000	60	52	45	37	50.000	71	62	49	39	31.000	89	77	66	55	44	●		○		
H.1.1	50.000	95	83	71	59	50.000	134	117	101	83	31.000	180	157	135	112	90		●			
H.1.2	50.000	95	83	71	59	44.000	134	117	101	83	22.000	180	157	135	112	90		●			
H.1.3	50.000	89	78	67	55	44.000	126	110	95	78	22.000	170	148	127	105	85		●			
H.1.4																					
H.2.1	50.000	155	135	116	96	50.000	164	143	123	102	44.000	346	301	260	215	173		●			
H.3.1	50.000	95	83	71	59	50.000	134	117	101	83	31.000	180	157	135	112	90		●			
O.1.1	50.000	232	202	174	144	50.000	274	238	205	170	50.000	554	482	416	344	277	●	○	○		
O.1.2	50.000	232	202	174	144	50.000	274	238	205	170	44.000	554	482	416	344	277	●	○	○		
O.2.1	50.000	141	123	106	88	50.000	200	174	150	124	31.000	316	275	237	196	158	●	○	○		
O.2.2	50.000	141	123	106	88	50.000	200	174	150	124	31.000	316	275	237	196	158	●	○	○		
O.3.1																					



 $a_e = 0,6 - 1,0 \times DC$: If values are missing, only trochoidal slot milling and profiling are permitted. Otherwise, there is the risk of tool breakage.

Cutting data standard values – Micro cutter – 5xDC

		52 802 ...																	
		Ø DC = 1,0–1,4 mm					Ø DC = 1,5–1,7 mm					Ø DC = 1,8–1,9 mm							
		a _e	0,1 x DC	0,2 x DC	0,3 x DC	0,4 x DC	0,6–1,0 x DC	a _e	0,1 x DC	0,2 x DC	0,3 x DC	0,4 x DC	0,6–1,0 x DC	a _e	0,1 x DC	0,2 x DC	0,3 x DC	0,4 x DC	0,6–1,0 x DC
		a _{p max.}	0,3	0,3	0,3	0,3	0,2	a _{p max.}	0,3	0,3	0,3	0,3	0,2	a _{p max.}	0,54	0,54	0,54	0,54	0,36
		n _{min.}	6.500					n _{min.}	6.500					n _{min.}	5.500				
Index	n	V _f mm/min.					n	V _f mm/min.					n	V _f mm/min.					
P.1.1	44.000	682	593	511	423	341	29.000	1160	1009	870	719	580	25.000	1250	1088	938	775	625	
P.1.2	44.000	682	593	511	423	341	29.000	1160	1009	870	719	580	25.000	1250	1088	938	775	625	
P.1.3	44.000	682	593	511	423	341	29.000	1160	1009	870	719	580	25.000	1250	1088	938	775	625	
P.1.4	31.000	416	362	312	258	208	21.000	693	603	520	430	346	18.000	850	740	638	527	425	
P.1.5	31.000	416	362	312	258	208	21.000	693	603	520	430	346	18.000	850	740	638	527	425	
P.2.1	44.000	682	593	511	423	341	29.000	1160	1009	870	719	580	25.000	1250	1088	938	775	625	
P.2.2	44.000	682	593	511	423	341	29.000	1160	1009	870	719	580	25.000	1250	1088	938	775	625	
P.2.3	31.000	416	362	312	258	208	21.000	693	603	520	430	346	18.000	850	740	638	527	425	
P.2.4	31.000	416	362	312	258	208	21.000	693	603	520	430	346	18.000	850	740	638	527	425	
P.3.1	31.000	416	362	312	258	208	21.000	693	603	520	430	346	18.000	850	740	638	527	425	
P.3.2	44.000	682	593	511	423	341	29.000	1160	1009	870	719	580	25.000	1250	1088	938	775	625	
P.3.3	31.000	416	362	312	258	208	21.000	693	603	520	430	346	18.000	850	740	638	527	425	
P.4.1	44.000	682	593	511	423	341	29.000	1160	1009	870	719	580	25.000	1250	1088	938	775	625	
P.4.2	44.000	682	593	511	423	341	29.000	1160	1009	870	719	580	25.000	1250	1088	938	775	625	
M.1.1	31.000	480	418	360	298	240	21.000	800	696	600	496	400	18.000	850	740	638	527	425	
M.2.1	31.000	480	418	360	298	240	21.000	800	696	600	496	400	18.000	850	740	638	527	425	
M.3.1	31.000	480	418	360	298	240	21.000	800	696	600	496	400	18.000	850	740	638	527	425	
K.1.1	50.000	620	539	465	384	310	33.000	1000	870	750	620	500	28.000	1320	1148	990	818	660	
K.1.2	50.000	620	539	465	384	310	33.000	1000	870	750	620	500	28.000	1320	1148	990	818	660	
K.2.1	50.000	620	539	465	384	310	33.000	1000	870	750	620	500	28.000	1320	1148	990	818	660	
K.2.2	50.000	620	539	465	384	310	33.000	1000	870	750	620	500	28.000	1320	1148	990	818	660	
K.3.1	25.000	297	258	223	184	148	16.000	411	357	308	255	205	14.000	480	418	360	298	240	
K.3.2	25.000	297	258	223	184	148	16.000	411	357	308	255	205	14.000	480	418	360	298	240	
N.1.1	50.000	775	674	581	480	387	42.000	1200	1044	900	744	600	36.000	1500	1305	1125	930	750	
N.1.2	50.000	775	674	581	480	387	42.000	1200	1044	900	744	600	36.000	1500	1305	1125	930	750	
N.2.1																			
N.2.2																			
N.2.3																			
N.3.1	38.000	697	607	523	432	349	25.000	1000	870	750	620	500	22.000	1100	957	825	682	550	
N.3.2	50.000	930	809	697	576	465	33.000	1320	1148	990	818	660	28.000	1400	1218	1050	868	700	
N.3.3	50.000	930	809	697	576	465	33.000	1320	1148	990	818	660	28.000	1400	1218	1050	868	700	
N.4.1	50.000	849	738	636	526	424	33.000	1205	1048	904	747	602	28.000	1400	1218	1050	868	700	
S.1.1	15.000	120	105	90	75	60	10.000	184	160	138	114	92	8.000	280	244	210	174	140	
S.1.2	15.000	120	105	90	75	60	10.000	184	160	138	114	92	8.000	280	244	210	174	140	
S.2.1	22.000	114	99	85	71	57	14.000	196	170	147	121	98	12.000	300	261	225	186	150	
S.2.2	15.000	120	105	90	75	60	10.000	184	160	138	114	92	8.000	280	244	210	174	140	
S.2.3	12.000	131	114	99	82	66	8.000	170	148	127	105	85	7.000	240	209	180	149	120	
S.3.1	38.000	156	135	117	96	78	25.000	274	238	205	170	137	22.000	380	331	285	236	190	
S.3.2	38.000	212	185	159	132	106	25.000	365	318	274	226	183	22.000	450	392	338	279	225	
S.3.3	31.000	127	111	95	79	64	21.000	201	175	151	125	100	18.000	300	261	225	186	150	
H.1.1	31.000	201	175	151	125	101	21.000	346	301	260	215	173	16.000	500	435	375	310	250	
H.1.2	22.000	235	204	176	146	117	14.000	346	301	260	215	173	12.000	450	392	338	279	225	
H.1.3	22.000	221	193	166	137	111	14.000	327	284	245	202	163	12.000	450	392	338	279	225	
H.1.4																			
H.2.1	44.000	426	371	320	264	213	29.000	600	522	450	372	300	25.000	800	696	600	496	400	
H.3.1	31.000	201	175	151	125	101	21.000	346	301	260	215	173	16.000	500	435	375	310	250	
O.1.1	50.000	930	809	697	576	465	33.000	1320	1148	990	818	660	28.000	1400	1218	1050	868	700	
O.1.2	44.000	813	708	610	504	407	29.000	1160	1009	870	719	580	25.000	1200	1044	900	744	600	
O.2.1	31.000	438	381	329	272	219	21.000	575	500	431	357	288	18.000	650	566	488	403	325	
O.2.2	31.000	438	381	329	272	219	21.000	575	500	431	357	288	18.000	650	566	488	403	325	
O.3.1																			

		52 802 ...							
		Ø DC = 2,0 mm					●	1st choice	
							○	suitable	
		a _e	0,1 x DC	0,2 x DC	0,3 x DC	0,4 x DC	0,6-1,0 x DC		
		a _{p max.}	0,6	0,6	0,6	0,6	0,4		
		n _{min.}	5.000						
Index	n	V _f mm/min.					Emulsion	Compressed air	MMS
P.1.1	22.000	1320	1148	990	818	660	●	○	○
P.1.2	22.000	1320	1148	990	818	660	●	○	○
P.1.3	22.000	1320	1148	990	818	660	●	○	○
P.1.4	15.000	900	783	675	558	450	●	○	○
P.1.5	15.000	900	783	675	558	450	●	○	○
P.2.1	22.000	1320	1148	990	818	660		●	○
P.2.2	22.000	1320	1148	990	818	660		●	○
P.2.3	15.000	900	783	675	558	450		●	○
P.2.4	15.000	900	783	675	558	450		●	○
P.3.1	15.000	900	783	675	558	450		●	○
P.3.2	22.000	1320	1148	990	818	660		●	○
P.3.3	15.000	900	783	675	558	450		●	○
P.4.1	22.000	1320	1148	990	818	660		●	○
P.4.2	22.000	1320	1148	990	818	660		●	○
M.1.1	15.000	900	783	675	558	450	●		○
M.2.1	15.000	900	783	675	558	450	●		○
M.3.1	15.000	900	783	675	558	450	●		○
K.1.1	25.000	1500	1305	1125	930	750	○	●	
K.1.2	25.000	1500	1305	1125	930	750	○	●	
K.2.1	25.000	1500	1305	1125	930	750	○	●	
K.2.2	25.000	1500	1305	1125	930	750	○	●	
K.3.1	12.000	520	452	390	322	260		●	
K.3.2	12.000	520	452	390	322	260		●	
N.1.1	31.000	1860	1618	1395	1153	930	●		○
N.1.2	31.000	1860	1618	1395	1153	930	●		○
N.2.1									
N.2.2									
N.2.3									
N.3.1	19.000	1140	992	855	707	570	●		○
N.3.2	25.000	1500	1305	1125	930	750	●		○
N.3.3	25.000	1500	1305	1125	930	750	●		○
N.4.1	25.000	1500	1305	1125	930	750	●		○
S.1.1	7.000	300	261	225	186	150	●		○
S.1.2	7.000	300	261	225	186	150	●		○
S.2.1	11.000	400	348	300	248	200	●		○
S.2.2	7.000	300	261	225	186	150	●		○
S.2.3	6.000	260	226	195	161	130	●		○
S.3.1	19.000	420	365	315	260	210	●		○
S.3.2	19.000	500	435	375	310	250	●		○
S.3.3	15.000	400	348	300	248	200	●		○
H.1.1	15.000	500	435	375	310	250		●	
H.1.2	11.000	480	418	360	298	240		●	
H.1.3	11.000	480	418	360	298	240		●	
H.1.4									
H.2.1	22.000	1000	870	750	620	500		●	
H.3.1	15.000	500	435	375	310	250		●	
O.1.1	25.000	1500	1305	1125	930	750	●	○	○
O.1.2	22.000	1320	1148	990	818	660	●	○	○
O.2.1	15.000	660	574	495	409	330	●	○	○
O.2.2	15.000	660	574	495	409	330	●	○	○
O.3.1									

Cutting data standard values – Micro cutter – 10xDC

		52 802 ...																
		Ø DC = 0,2–0,4 mm				Ø DC = 0,5–0,7 mm				Ø DC = 0,8–0,9 mm				Ø DC = 1,0–1,4 mm				
		0,1 x DC	0,2 x DC	0,3 x DC	0,4 x DC	0,1 x DC	0,2 x DC	0,3 x DC	0,4 x DC	0,1 x DC	0,2 x DC	0,3 x DC	0,4 x DC	0,1 x DC	0,2 x DC	0,3 x DC	0,4 x DC	
		a_e	$a_{p,max}$	n_{min}	v_f	a_e	$a_{p,max}$	n_{min}	v_f	a_e	$a_{p,max}$	n_{min}	v_f	a_e	$a_{p,max}$	n_{min}	v_f	
		30.000				12.000				8.000				6.500				
Index	n	mm/min.				mm/min.				mm/min.				mm/min.				
P.1.1	50.000	232	202	174	144	274	238	205	170	38.000	450	392	338	279	589	512	442	365
P.1.2	50.000	232	202	174	144	274	238	205	170	38.000	450	392	338	279	589	512	442	365
P.1.3	50.000	232	202	174	144	274	238	205	170	38.000	450	392	338	279	589	512	442	365
P.1.4	50.000	201	175	151	125	190	165	142	118	25.000	300	261	225	186	335	292	252	208
P.1.5	50.000	201	175	151	125	190	165	142	118	25.000	300	261	225	186	335	292	252	208
P.2.1	50.000	232	202	174	144	274	238	205	170	38.000	450	392	338	279	589	512	442	365
P.2.2	50.000	232	202	174	144	274	238	205	170	38.000	450	392	338	279	589	512	442	365
P.2.3	50.000	201	175	151	125	190	165	142	118	25.000	300	261	225	186	335	292	252	208
P.2.4	50.000	201	175	151	125	190	165	142	118	25.000	300	261	225	186	335	292	252	208
P.3.1	50.000	201	175	151	125	190	165	142	118	25.000	300	261	225	186	335	292	252	208
P.3.2	50.000	232	202	174	144	274	238	205	170	38.000	450	392	338	279	589	512	442	365
P.3.3	50.000	201	175	151	125	190	165	142	118	25.000	300	261	225	186	335	292	252	208
P.4.1	50.000	232	202	174	144	274	238	205	170	38.000	450	392	338	279	589	512	442	365
P.4.2	50.000	232	202	174	144	274	238	205	170	38.000	450	392	338	279	589	512	442	365
M.1.1	50.000	155	135	116	96	219	191	164	136	25.000	312	271	234	193	387	337	290	240
M.2.1	50.000	155	135	116	96	219	191	164	136	25.000	312	271	234	193	387	337	290	240
M.3.1	50.000	155	135	116	96	219	191	164	136	25.000	312	271	234	193	387	337	290	240
K.1.1	50.000	232	202	174	144	274	238	205	170	44.000	485	422	364	301	682	593	511	423
K.1.2	50.000	232	202	174	144	274	238	205	170	44.000	485	422	364	301	682	593	511	423
K.2.1	50.000	232	202	174	144	274	238	205	170	44.000	485	422	364	301	682	593	511	423
K.2.2	50.000	232	202	174	144	274	238	205	170	44.000	485	422	364	301	682	593	511	423
K.3.1	50.000	141	123	106	88	150	131	113	93	19.000	215	187	161	133	269	234	202	167
K.3.2	50.000	141	123	106	88	150	131	113	93	19.000	215	187	161	133	269	234	202	167
N.1.1	50.000	232	202	174	144	438	381	329	272	50.000	693	603	520	430	930	809	697	576
N.1.2	50.000	232	202	174	144	438	381	329	272	50.000	693	603	520	430	930	809	697	576
N.2.1																		
N.2.2																		
N.2.3																		
N.3.1	50.000	232	202	174	144	274	238	205	170	31.000	402	350	301	249	480	418	360	298
N.3.2	50.000	232	202	174	144	274	238	205	170	44.000	416	362	312	258	542	472	407	336
N.3.3	50.000	232	202	174	144	274	238	205	170	44.000	416	362	312	258	542	472	407	336
N.4.1	50.000	212	185	159	132	300	261	225	186	44.000	506	440	379	314	742	646	557	460
S.1.1	50.000	46	40	35	29	55	48	41	34	12.000	69	60	51	43	88	76	66	54
S.1.2	50.000	46	40	35	29	55	48	41	34	12.000	69	60	51	43	88	76	66	54
S.2.1	50.000	54	47	40	33	63	55	47	39	19.000	102	89	76	63	126	110	95	78
S.2.2	50.000	46	40	35	29	55	48	41	34	12.000	69	60	51	43	88	76	66	54
S.2.3	50.000	46	40	35	29	55	48	41	34	12.000	59	51	44	36	82	71	62	51
S.3.1	50.000	60	52	45	37	71	62	53	44	31.000	101	88	76	63	141	123	106	88
S.3.2	50.000	60	52	45	37	71	62	53	44	31.000	101	88	76	63	177	154	133	110
S.3.3	50.000	60	52	45	37	71	62	53	44	25.000	89	77	66	55	141	123	106	88
H.1.1	50.000	47	41	36	29	67	58	50	42	25.000	90	78	68	56	101	88	75	62
H.1.2	50.000	47	41	36	29	67	58	50	42	19.000	90	78	68	56	101	88	75	62
H.1.3	50.000	45	39	34	28	63	55	47	39	19.000	85	74	64	53	95	83	71	59
H.1.4																		
H.2.1	50.000	77	67	58	48	82	71	62	51	38.000	173	151	130	107	194	168	145	120
H.3.1	50.000	47	41	36	29	67	58	50	42	25.000	90	78	68	56	101	88	75	62
O.1.1	50.000	232	202	174	144	329	286	246	204	44.000	554	482	416	344	813	708	610	504
O.1.2	50.000	232	202	174	144	329	286	246	204	38.000	554	482	416	344	705	613	529	437
O.2.1	50.000	141	123	106	88	200	174	150	124	25.000	285	248	213	176	339	295	255	210
O.2.2	50.000	141	123	106	88	200	174	150	124	25.000	285	248	213	176	339	295	255	210
O.3.1																		



$a_e = 0,6-1,0 \times DC$: Missing values only trochoidal slotting and milling is recommended. Otherwise there is the risk of tool breakage.

Index		52 802 ...															● 1st choice ○ suitable		
		Ø DC = 1,5–1,7 mm					Ø DC = 1,8–1,9 mm					Ø DC = 2,0 mm							
		a_e	0,1 x DC	0,2 x DC	0,3 x DC	0,4 x DC	a_e	0,1 x DC	0,2 x DC	0,3 x DC	0,4 x DC	a_e	0,1 x DC	0,2 x DC	0,3 x DC	0,4 x DC	Emulsion	Compressed air	MMS
		$a_{p,max}$	0,06	0,06	0,06	0,06	$a_{p,max}$	0,072	0,072	0,072	0,072	$a_{p,max}$	0,08	0,08	0,08	0,08			
		n_{min}	6.500				n_{min}	5.500				n_{min}	5.000						
		v_f	mm/min.				v_f	mm/min.				v_f	mm/min.						
P.1.1		25.000	1000	870	750	620	22.000	1080	940	810	670	19.000	1140	992	855	707	●	○	○
P.1.2		25.000	1000	870	750	620	22.000	1080	940	810	670	19.000	1140	992	855	707	●	○	○
P.1.3		25.000	1000	870	750	620	22.000	1080	940	810	670	19.000	1140	992	855	707	●	○	○
P.1.4		16.000	554	482	416	344	14.000	680	592	510	422	12.000	720	626	540	446	●	○	○
P.1.5		16.000	554	482	416	344	14.000	680	592	510	422	12.000	720	626	540	446	●	○	○
P.2.1		25.000	1000	870	750	620	22.000	1080	940	810	670	19.000	1140	992	855	707		●	○
P.2.2		25.000	1000	870	750	620	22.000	1080	940	810	670	19.000	1140	992	855	707		●	○
P.2.3		16.000	554	482	416	344	14.000	680	592	510	422	12.000	720	626	540	446		●	○
P.2.4		16.000	554	482	416	344	14.000	680	592	510	422	12.000	720	626	540	446		●	○
P.3.1		16.000	554	482	416	344	14.000	680	592	510	422	12.000	720	626	540	446		●	○
P.3.2		25.000	1000	870	750	620	22.000	1080	940	810	670	19.000	1140	992	855	707		●	○
P.3.3		16.000	554	482	416	344	14.000	680	592	510	422	12.000	720	626	540	446		●	○
P.4.1		25.000	1000	870	750	620	22.000	1080	940	810	670	19.000	1140	992	855	707		●	○
P.4.2		25.000	1000	870	750	620	22.000	1080	940	810	670	19.000	1140	992	855	707		●	○
M.1.1		16.000	600	522	450	372	14.000	650	566	488	403	12.000	720	626	540	446	●		○
M.2.1		16.000	600	522	450	372	14.000	650	566	488	403	12.000	720	626	540	446	●		○
M.3.1		16.000	600	522	450	372	14.000	650	566	488	403	12.000	720	626	540	446	●		○
K.1.1		29.000	1160	1009	870	719	25.000	1240	1079	930	769	22.000	1320	1148	990	818	○	●	
K.1.2		29.000	1160	1009	870	719	25.000	1240	1079	930	769	22.000	1320	1148	990	818	○	●	
K.2.1		29.000	1160	1009	870	719	25.000	1240	1079	930	769	22.000	1320	1148	990	818	○	●	
K.2.2		29.000	1160	1009	870	719	25.000	1240	1079	930	769	22.000	1320	1148	990	818	○	●	
K.3.1		12.000	329	286	246	204	10.000	380	331	285	236	9.000	390	339	293	242		●	
K.3.2		12.000	329	286	246	204	10.000	380	331	285	236	9.000	390	339	293	242		●	
N.1.1		38.000	1520	1322	1140	942	33.000	1600	1392	1200	992	28.000	1680	1462	1260	1042	●		○
N.1.2		38.000	1520	1322	1140	942	33.000	1600	1392	1200	992	28.000	1680	1462	1260	1042	●		○
N.2.1																			
N.2.2																			
N.2.3																			
N.3.1		21.000	800	696	600	496	18.000	850	740	638	527	15.000	900	783	675	558	●		○
N.3.2		29.000	900	783	675	558	25.000	1000	870	750	620	22.000	1140	992	855	707	●		○
N.3.3		29.000	900	783	675	558	25.000	1000	870	750	620	22.000	1140	992	855	707	●		○
N.4.1		29.000	1059	921	794	657	25.000	1200	1044	900	744	22.000	1320	1148	990	818	●		○
S.1.1		8.000	127	111	95	79	7.000	220	191	165	136	6.000	250	218	188	155	●		○
S.1.2		8.000	127	111	95	79	7.000	220	191	165	136	6.000	250	218	188	155	●		○
S.2.1		12.000	204	178	153	127	10.000	300	261	225	186	9.000	350	305	263	217	●		○
S.2.2		8.000	127	111	95	79	7.000	220	191	165	136	6.000	250	218	188	155	●		○
S.2.3		8.000	106	92	80	66	7.000	200	174	150	124	6.000	220	191	165	136	●		○
S.3.1		21.000	228	199	171	141	18.000	300	261	225	186	15.000	380	331	285	236	●		○
S.3.2		21.000	274	238	205	170	18.000	400	348	300	248	15.000	450	392	338	279	●		○
S.3.3		16.000	237	206	178	147	14.000	300	261	225	186	12.000	380	331	285	236	●		○
H.1.1		16.000	173	151	130	107	14.000	200	174	150	124	12.000	240	209	180	149		●	
H.1.2		12.000	173	151	130	107	10.000	200	174	150	124	9.000	240	209	180	149		●	
H.1.3		12.000	163	142	122	101	10.000	200	174	150	124	9.000	240	209	180	149		●	
H.1.4																			
H.2.1		25.000	300	261	225	186	21.000	400	348	300	248	19.000	500	435	375	310		●	
H.3.1		16.000	173	151	130	107	14.000	200	174	150	124	12.000	240	209	180	149		●	
O.1.1		29.000	1160	1009	870	719	25.000	1200	1044	900	744	22.000	1320	1148	990	818	●	○	○
O.1.2		25.000	1000	870	750	620	18.000	1000	870	750	620	19.000	1140	992	855	707	●	○	○
O.2.1		16.000	438	381	329	272	14.000	500	435	375	310	12.000	520	452	390	322	●	○	○
O.2.2		16.000	438	381	329	272	14.000	500	435	375	310	12.000	520	452	390	322	●	○	○
O.3.1																			

Cutting data standard values – Circular saw blades

54 700 ...		
Circular saws Solid carbide Fine		
Index	v_c m/min	f_z mm
P.1.1	80 – 140	0,002 – 0,012
P.1.2	50 – 80	0,001 – 0,012
P.1.3	50 – 80	0,001 – 0,012
P.1.4	50 – 80	0,001 – 0,012
P.1.5	50 – 80	0,001 – 0,012
P.2.1	50 – 80	0,001 – 0,012
P.2.2	50 – 80	0,001 – 0,012
P.2.3	50 – 80	0,001 – 0,012
P.2.4	50 – 80	0,001 – 0,012
P.3.1	50 – 80	0,001 – 0,012
P.3.2	50 – 80	0,001 – 0,012
P.3.3	50 – 80	0,001 – 0,012
P.4.1	80 – 120	0,001 – 0,012
P.4.2	50 – 80	0,001 – 0,012
M.1.1	50 – 80	0,001 – 0,012
M.2.1	50 – 80	0,001 – 0,012
M.3.1	50 – 80	0,001 – 0,012
K.1.1	80 – 140	0,002 – 0,012
K.1.2	50 – 80	0,001 – 0,01
K.2.1	50 – 80	0,001 – 0,01
K.2.2	50 – 80	0,001 – 0,01
K.3.1	50 – 80	0,001 – 0,01
K.3.2	50 – 80	0,001 – 0,01
N.1.1	200 – 500	0,003 – 0,012
N.1.2	200 – 500	0,003 – 0,012
N.2.1	200 – 450	0,003 – 0,012
N.2.2	200 – 450	0,003 – 0,012
N.2.3	200 – 450	0,003 – 0,012
N.3.1	200 – 450	0,003 – 0,012
N.3.2	200 – 450	0,003 – 0,012
N.3.3	200 – 450	0,003 – 0,012
N.4.1		
S.1.1	20 – 30	0,001 – 0,012
S.1.2	20 – 30	0,001 – 0,012
S.2.1	20 – 30	0,001 – 0,012
S.2.2	20 – 30	0,001 – 0,012
S.2.3	20 – 30	0,001 – 0,012
S.3.1	30 – 70	0,001 – 0,012
S.3.2	30 – 70	0,001 – 0,012
S.3.3	30 – 70	0,001 – 0,012
H.1.1		
H.1.2		
H.1.3		
H.1.4		
H.2.1		
H.3.1		
O.1.1	130 – 200	0,003 – 0,015
O.1.2	130 – 200	0,003 – 0,015
O.2.1		
O.2.2		
O.3.1		



The cutting data depends extremely on the external conditions, e.g. stability of the tool and tool clamping, material and machine type. The indicated values are possible cutting data which have to be increased or reduced according to the application conditions.

Technical references

Feedrate Adjustment

If the rpm indicated in the tables cannot be obtained by the machine spindle, the feed rate is to be reduced proportionally to the max rpm.

Example:

according to table = n 50000 1/min. and v_f 1000 mm/min.,
maximum machine rpm = 40000 1/min.

Calculation of feed rate which can be applied:

$40000 = 80\%$ of 50000 1/min. accordingly 80% of 1000 = 800 mm/min.

Feed rate which can be applied = **800 mm/min.**

Tool Holding

You should always use a clamping device with a high-precision radial run-out.

Collets are ideally suited for this, for example.

You can find suitable clamping devices in → **Chapter 16 Adapters and accessories in the clamping technology catalogue.**

Machine

Use the Micro mills on machines with the highest accuracy and good stability.

Cutting Data Information

The indicated cutting data is dependant upon the machine, workpiece, stability, etc. and may need to be adjusted up or downward to suit.

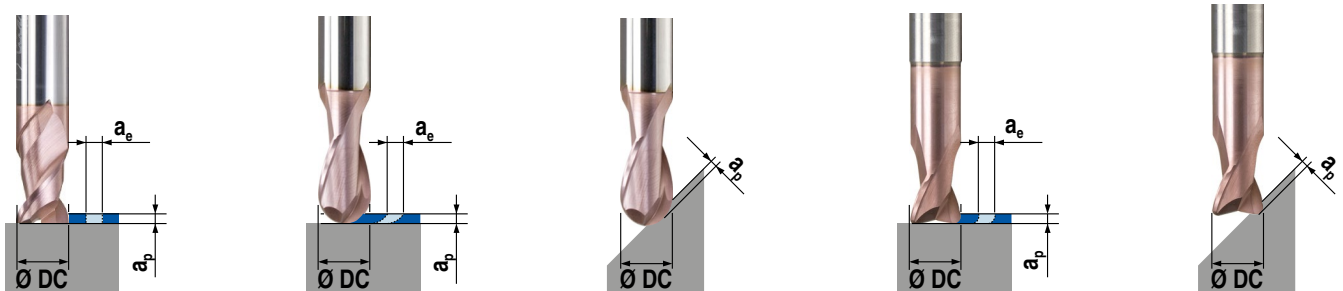

General formula for calculating the cutting parameters

Designation	Abbreviation	Unit	Formula	Example	
Number of revolutions	n	min ⁻¹	$n = \frac{v_c \times 1000}{DC \times \pi}$	$v_c = 25 \text{ m/min}$ $DC = 20 \text{ mm}$	$n = \frac{25 \times 1000}{20 \times \pi} = 398 \text{ min}^{-1}$
Cutting speed	v_c	m/min	$v_c = \frac{DC \times \pi \times n}{1000}$	$n = 400 \text{ min}^{-1}$ $DC = 20 \text{ mm}$	$v_c = \frac{20 \times \pi \times 400}{1000} = 25 \text{ m/min}$
Feed per tooth	f_z	mm	$f_z = \frac{v_f}{Z\text{EFP} \times n}$	$v_f = 320 \text{ mm/min.}$ $n = 400 \text{ min}^{-1}$ $Z\text{EFP} = 4$	$f_z = \frac{320}{4 \times 400} = 0,2 \text{ mm}$
Feed per revolution	f	mm	$f = f_z \times Z\text{EFP}$	$f_z = 0,2 \text{ mm}$ $Z\text{EFP} = 4$	$f = 0,2 \times 4 = 0,8 \text{ mm}$
Feed rate	v_f	mm/min.	$v_f = f_z \times Z\text{EFP} \times n$	$f_z = 0,2 \text{ mm}$ $Z\text{EFP} = 4$ $n = 400 \text{ min}^{-1}$	$v_f = 0,2 \times 4 \times 400 = 320 \text{ mm/min}$
Average chip thickness	h_m	mm	$h_m = f_z \times \sqrt{\frac{a_e}{DC}}$	$f_z = 0,2 \text{ mm}$ $a_e = 0,3 \text{ mm}$ $DC = 20 \text{ mm}$	$h_m = 0,2 \times \sqrt{\frac{0,3}{20}} = 0,024 \text{ mm}$

ZEFP = Number of flutes
 a_e = cutting width

Calculation of the feed rate on the midpoint path of the milling cutter (v_{fM})

Designation	Abbreviation	Unit	Formula	Example
Internal contour	v_{fM}	mm/min.	$v_{fM} = \frac{v_f \times (D - DC)}{D}$	
Outside profile	v_{fM}	mm/min.	$v_{fM} = \frac{v_f \times (D + DC)}{D}$	
Helical ramping	v_{fM}	mm/min.	$v_{fM} = \frac{n \times f_z \times Z\text{EFP} \times (D - D_c)}{D}$	

Tips for Tool Selection

Rake and helix angles combined with the coating are decisive factors for the operational area.

Characteristics	Benefits
Helix angle with slow spiral	
<ul style="list-style-type: none"> ▲ For materials with high tensile strength ▲ For high material removal rates ▲ For slot milling, pocket milling, rough milling 	<ul style="list-style-type: none"> ▲ High edge stability ▲ Low tendency to edge chipping
Helix angle with quick spiral	
<ul style="list-style-type: none"> ▲ For soft steels, non ferrous metals, etc. ▲ For low material removal rates ▲ Typical for finishing processes 	<ul style="list-style-type: none"> ▲ Soft cut ▲ Low cutting forces
Small rake angles are applied	
<ul style="list-style-type: none"> ▲ For hard, brittle materials ▲ For high material removal rates ▲ For rough machining 	<ul style="list-style-type: none"> ▲ High edge stability ▲ Low tendency to edge chipping
Large rake angles are applied	
<ul style="list-style-type: none"> ▲ For soft materials ▲ For low material removal rates ▲ For finishing 	<ul style="list-style-type: none"> ▲ Soft cut ▲ Low cutting forces ▲ Favorable chip flow ▲ Low tendency to stick

Correction factor for solid carbide milling cutters

Factors for cutting speed (v_c) and feed rate (f_z) in relation to the overhang length (LPR)

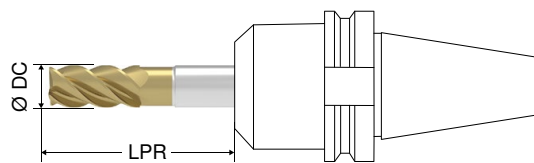

Length					
Overhang length (LPR)	1,5 x DC	4 x DC	8 x DC	12 x DC	> 12 x DC
Factor for v_c ($K_f v_c$)	1,0	1,0	0,9	0,85	0,7
Factor for f_z ($K_f f_z$)	1,2	1,0	0,8	0,7	0,5

Factors for cutting speed (v_c) and feed rate (f_z) in relation to the cutting depth (a_p) and cutting width (a_e)

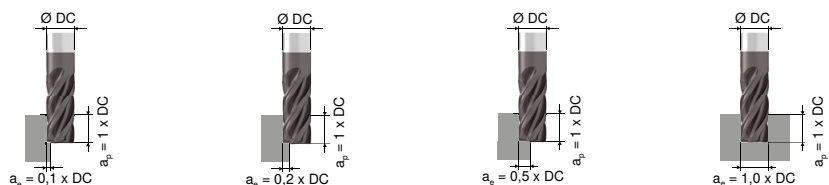

Factor for v_c ($K_f v_c$)	1,3	1,1	1,0	0,85
Factor for f_z ($K_f f_z$)	1,5	1,3	1,0	0,8

Coatings

DPB72S

DRAGONSKIN

- ▲ TiAlCrN multilayer coating
- ▲ $HV_{0.05} = 3200$
- ▲ Coefficient of friction (against steel) = 0.35
- ▲ Maximum application temperature: 1000 °C

DPA72S

DRAGONSKIN

- ▲ Special nanolayer coating
- ▲ $HV_{0.05} = 3200$
- ▲ Coefficient of friction (against steel) = 0.5
- ▲ Maximum application temperature: 1000 °C

Ti 1000

- ▲ Ti monolayer coating
- ▲ $HV_{0.05} = 3500$
- ▲ Coefficient of friction (against steel) = 0.3
- ▲ Maximum application temperature: 800 °C

DLC

DRAGONSKIN

- ▲ Diamond-like carbon coating
- ▲ Specially for machining non-ferrous metals
- ▲ Maximum application temperature: 400 °C



Fast and efficient availability

The new portfolio: simple ways to new tools and service

With the most modern logistics center in Europe we ensure the shortest delivery times, with our Tool Supply 24/7 service for digitally simplified orders. The Tool-O-Mat, which can hold up to 840 different products, ensures that tools are ready when they are needed as a removal system on site. Payment is only made when withdrawn.

Logistics at the highest level

A logistic center that can meet all requirements, 99% delivery capacity with next day delivery, no minimum order quantity, custom logistic solutions for major customers.

Fast ordering

- ▲ Online processes save time and money during the ordering process
- ▲ Add items to your basket quickly and easily
- ▲ High availability including a check in the basket
- ▲ Order 24 hours a day
- ▲ Quick delivery with tracking





Solid drilling and bore machining	HSS drilling	1
	Solid carbide drilling	
	Reamers	
Threading	HSS taps	2
	Circular and Thread Milling	
	Thread turning	
Turning	Turning Tools	3
	Multi-function tool - EcoCut	
	Grooving Tools	
	Miniature turning tools	
Milling	Solid Carbide milling cutters	4
Workholding	Collets and reduction sleeves	5
	Material examples and article no. index	6

Table of contents

Overview	2
Product programme	
Collets	3-13
Stem collets	14-19
Guide bushes	20-30
Clamping sleeves	31-39
Reduction sleeves	40
Technical Information	41

WNT \ Performance

Premium quality tools for high performance.

The premium quality tools from the **WNT Performance** product line have been designed for specific applications and are distinguished by their outstanding performance. If you make high demands on the performance of your production and want to achieve the very best results, we recommend the Premium tools in this product line.

Overview

Collets

Collets for clamping the bar in the main spindle and for the sub-spindle



3-13

Stem collets

With an adapted stem for improved pick-up of the workpieces and for better secondary operation machinability

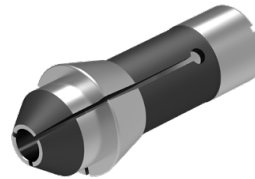

14-19

Guide bushes

Ensures bar guidance in the main spindle



20-30

Clamping sleeves

Mounting for bar feeder magazines

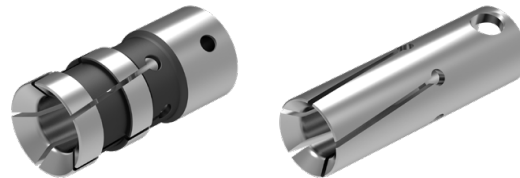

31-39

Reduction sleeves















With a reduction sleeve, small tools can be used directly on tool clamping points with larger mounting diameters.



40

 Other profile shapes and sizes and extended options available on request.

Collets overview

Norm	Clamping diameter range in mm	Profile	Version	Page No.
116 E / F 13	Ø 6,0 - 10,0		Grooved	4
	Ø 1,0 - 10,0		Smooth	4
120 E / F 15	Ø 6,0 - 12,0		Grooved	5
	Ø 1,0 - 12,0		Smooth	5
	SW 2,0 - 11,0		Grooved*	5
F 16 / 1212 E	Ø 1,0 - 13,0		Grooved	6
	Ø 6,0 - 13,0		Smooth	6
136 E / F 20-201	Ø 6,0 - 16,0		Grooved	7
	Ø 1,0 - 16,0		Smooth	7
138 E / F 20-87	Ø 6,0 - 16,0		Grooved	8
	Ø 1,0 - 16,0		Smooth	8
	SW 2,0 - 14,0		Grooved*	8
145 E / F 25	Ø 6,0 - 20,0		Grooved	9+10
	Ø 1,5 - 20,0		Smooth	9+10
	SW 2,0 - 19,0		Grooved*	9+10
	SW 2,0 - 15,0		Grooved*	9+10
F 37 / 1536 E	Ø 6,0 - 32,0		Grooved	11-13
	Ø 1,0 - 32,0		Smooth	11-13
	SW 3,0 - 27,0		Grooved*	11-13
	SW 3,0 - 23,0		Grooved*	11-13

* Grooved from SW 8



Other profile shapes and sizes and extended options available on request.

Should you wish to send us a request for specially adjusted solutions, you will find a detailed form in the download area on our homepage. Please fill it out carefully and send it via email or print it out and send via fax. → cuttingtools.ceratizit.com/gb/en/download.htmlPlease email the completed form to techsupport.uk@ceratizit.com.

Collets

Designation	DGUI mm	DFC mm	DCLC mm	LCLC mm	OAL mm	BHTA °
116 E / F 13	13	19	13	6	64	16

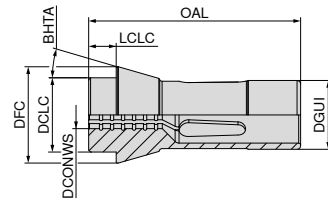

Pressure collet 116 E / F 13



DCONWS mm	Grooved 116 E / F 13	Smooth 116 E / F 13
	81 000 ...	81 002 ...
1.0		01000
1.5		01500
2.0		02000
2.5		02500
3.0		03000
3.5		03500
4.0		04000
4.5		04500
5.0		05000
5.5		05500
6.0	06000	06000
6.5	06500	06500
7.0	07000	07000
7.5	07500	07500
8.0	08000	08000
8.5	08500	08500
9.0	09000	09000
9.5	09500	09500
10.0	10000	10000

Collets

Designation	DGUI mm	DFC mm	DCLC mm	LCLC mm	OAL mm	BHTA °
120 E / F 15	15	21	15	6	64	16

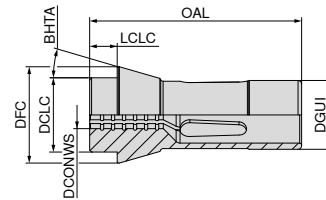

Pressure collet 120 E / F 15



DCONWS mm	DCONWS inch	Grooved 120 E / F 15	Smooth 120 E / F 15	Grooved 120 E / F 15
		81 003 ...	81 005 ...	81 031 ...
1.000			01000	
1.500			01500	
2.000			02000	02000 ¹⁾
2.500			02500	
3.000			03000	03000 ¹⁾
3.175	1/8			03175 ¹⁾
3.500			03500	
4.000			04000	04000 ¹⁾
4.500			04500	
5.000			05000	05000 ¹⁾
5.500			05500	
6.000		06000	06000	06000 ¹⁾
6.350	1/4			06350 ¹⁾
6.500		06500	06500	
7.000		07000	07000	07000 ¹⁾
7.500		07500	07500	
8.000		08000	08000	08000
8.500		08500	08500	
9.000		09000	09000	09000
9.500			09500	
10.000		10000	10000	10000
10.500		10500	10500	
11.000		11000	11000	11000
11.500		11500	11500	
12.000		12000	12000	

1) Without transverse grooves

Collets

Designation	DGUI mm	DFC mm	DCLC mm	LCLC mm	OAL mm	BHTA °
F 16 / 1212 E	16	21	16	6	64	16

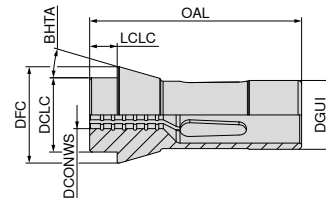

Pressure collet F 16 / 1212 E



Grooved
F 16 / 1212 E
 Smooth
F 16 / 1212 E

DCONWS mm	Grooved F 16 / 1212 E	Smooth F 16 / 1212 E
	81 019 ...	81 021 ...
1.0		01000
1.5		01500
2.0		02000
2.5		02500
3.0		03000
3.5		03500
4.0		04000
4.5		04500
5.0		05000
5.5		05500
6.0	06000	06000
6.5	06500	06500
7.0	07000	07000
7.5	07500	07500
8.0	08000	08000
8.5	08500	08500
9.0	09000	09000
9.5	09500	09500
10.0	10000	10000
10.5	10500	10500
11.0	11000	11000
11.5	11500	11500
12.0	12000	12000
12.5	12500	12500
13.0	13000	13000

Collets

Designation	DGUI mm	DFC mm	DCLC mm	LCLC mm	OAL mm	BHTA °
136 E / F 20-201	20	26	19	5	54	15

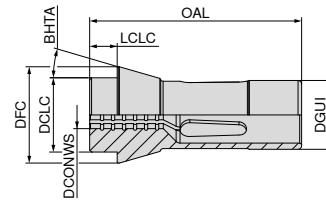

Pressure collet 136 E / F 20-201



DCONWS mm	Grooved 136 E / F 20-201	Smooth 136 E / F 20-201
	81 007 ...	81 009 ...
1.0		01000
1.5		01500
2.0		02000
2.5		02500
3.0		03000
3.5		03500
4.0		04000
4.5		04500
5.0		05000
5.5		05500
6.0	06000	06000
6.5	06500	06500
7.0	07000	07000
7.5	07500	07500
8.0	08000	08000
8.5	08500	08500
9.0	09000	09000
9.5	09500	09500
10.0	10000	10000
10.5	10500	10500
11.0	11000	11000
11.5	11500	11500
12.0	12000	12000
12.5	12500	12500
13.0	13000	13000
13.5	13500	13500
14.0	14000	14000
14.5	14500	14500
15.0	15000	15000
15.5	15500	15500
16.0	16000	16000

Collets

Designation	DGUI mm	DFC mm	DCLC mm	LCLC mm	OAL mm	BHTA °
138 E / F20-87	20	28	21	7	67	16

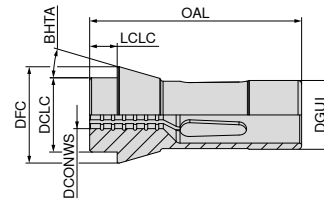

Pressure collet 138 E / F 20-87



DCONWS mm	DCONWS inch	Grooved 138 E / F20-87	Smooth 138 E / F20-87	Grooved 138 E / F20-87
		81 011 ...	81 013 ...	81 026 ...
1.00			01000	
1.50			01500	
2.00			02000	02000 ¹⁾
2.50			02500	
3.00			03000	03000 ¹⁾
3.50			03500	
4.00			04000	04000 ¹⁾
4.50			04500	
5.00			05000	05000 ¹⁾
5.50			05500	
6.00		06000	06000	06000 ¹⁾
6.35	1/4			06350 ¹⁾
6.50		06500	06500	
7.00		07000	07000	07000 ¹⁾
7.50		07500	07500	
8.00		08000	08000	08000
8.50		08500	08500	
9.00		09000	09000	09000
9.50		09500	09500	
10.00		10000	10000	10000
10.50		10500	10500	
11.00		11000	11000	11000
11.50		11500	11500	
12.00		12000	12000	12000
12.50		12500	12500	
13.00		13000	13000	13000
13.50		13500	13500	
14.00		14000	14000	14000
14.50		14500	14500	
15.00		15000	15000	
15.50		15500	15500	
16.00		16000	16000	

1) Without transverse grooves

Collets

Designation	DGUI mm	DFC mm	DCLC mm	LCLC mm	OAL mm	BHTA °
145 E / F 25	25	35	27	10	77	16

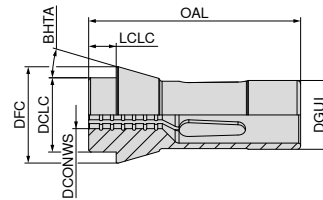

Pressure collet 145 E / F 25

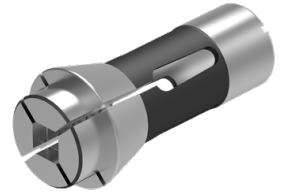

DCONWS mm	DCONWS inch	Grooved 145 E / F 25	Smooth 145 E / F 25	Grooved 145 E / F 25	Grooved 145 E / F 25
		81 015 ...	81 017 ...	81 027 ...	81 029 ...
1,500			01500		
1,501 - 1,999			xxxxx ²⁾		
2,000			02000	02000 ¹⁾	02000 ¹⁾
2,001 - 2,499			xxxxx ²⁾		
2,500			02500		
2,501 - 2,999			xxxxx ²⁾		
3,000			03000	03000 ¹⁾	03000 ¹⁾
3,001 - 3,499			xxxxx ²⁾		
3,500			03500		
3,501 - 3,999			xxxxx ²⁾		
4,000			04000	04000 ¹⁾	04000 ¹⁾
4,001 - 4,499			xxxxx ²⁾		
4,500			04500		
4,501 - 4,999			xxxxx ²⁾		
5,000			05000	05000 ¹⁾	05000 ¹⁾
5,001 - 5,499			xxxxx ²⁾		
5,500			05500		
5,501 - 5,999			xxxxx ²⁾		
6,000		06000	06000	06000 ¹⁾	06000 ¹⁾
6,001 - 6,349		xxxxx ²⁾			
6,350	1/4	06350	06350	06350 ¹⁾	
6,351 - 6,499		xxxxx ²⁾			
6,500		06500	06500		
6,501 - 6,999		xxxxx ²⁾			
7,000		07000	07000	07000 ¹⁾	07000 ¹⁾
7,001 - 7,499		xxxxx ²⁾			
7,500		07500	07500		
7,501 - 7,937		xxxxx ²⁾			
7,938	5/16	07938	07938		
7,939 - 7,999		xxxxx ²⁾			
8,000		08000	08000	08000	08000
8,001 - 8,499		xxxxx ²⁾			
8,500		08500	08500		
8,501 - 8,999		xxxxx ²⁾			
9,000		09000	09000	09000	09000
9,001 - 9,499		xxxxx ²⁾			
9,500		09500	09500		
9,501 - 9,999		xxxxx ²⁾			
10,000		10000	10000	10000	10000
10,001 - 10,499		xxxxx ²⁾			
10,500		10500	10500		
10,501 - 10,999		xxxxx ²⁾			
11,000		11000	11000	11000	11000
11,001 - 11,112		xxxxx ²⁾			

1) Without transverse grooves

2) Not available ex stock, articles are non-returnable and cannot be exchanged / Delivery time 7 working days



For xxxxx please specify the required diameter when ordering (e.g. Ø 6.789 - article number 81 015 06789).

Pressure collet 145 E / F 25



DCONWS mm	DCONWS inch	Grooved 145 E / F 25	Smooth 145 E / F 25	Grooved 145 E / F 25	Grooved 145 E / F 25
		81 015 ...	81 017 ...	81 027 ...	81 029 ...
11,113	7/16	11113	11113		
11,114 - 11,499		xxxxx ²⁾			
11,500		11500	11500		
11,501 - 11,999		xxxxx ²⁾			
12,000		12000	12000	12000	12000
12,001 - 12,499		xxxxx ²⁾			
12,500		12500	12500		
12,501 - 12,699		xxxxx ²⁾			
12,700	1/2	12700	12700	12700	
12,701 - 12,999		xxxxx ²⁾			
13,000		13000	13000	13000	13000
13,001 - 13,499		xxxxx ²⁾			
13,500		13500	13500		
13,501 - 13,999		xxxxx ²⁾			
14,000		14000	14000	14000	14000
14,001 - 14,499		xxxxx ²⁾			
14,500		14500	14500		
14,501 - 14,999		xxxxx ²⁾			
15,000		15000	15000	15000	15000
15,001 - 15,499		xxxxx ²⁾			
15,500		15500	15500		
15,501 - 15,999		xxxxx ²⁾			
16,000		16000	16000	16000	
16,001 - 16,499		xxxxx ²⁾			
16,500		16500	16500		
16,501 - 16,999		xxxxx ²⁾			
17,000		17000	17000	17000	
17,001 - 17,499		xxxxx ²⁾			
17,500		17500	17500		
17,501 - 17,999		xxxxx ²⁾			
18,000		18000	18000	18000	
18,001 - 18,499		xxxxx ²⁾			
18,500		18500	18500		
18,501 - 18,999		xxxxx ²⁾			
19,000		19000	19000	19000	
19,001 - 19,049		xxxxx ²⁾			
19,050	3/4	19050			
19,051 - 19,499		xxxxx ²⁾			
19,500		19500	19500		
19,501 - 19,999		xxxxx ²⁾			
20,000		20000	20000		

- 1) Without transverse grooves
- 2) Not available ex stock, articles are non-returnable and cannot be exchanged / Delivery time 7 working days

 For xxxxx please specify the required diameter when ordering (e.g. Ø 6.789 – article number 81 015 06789).

Collets

Designation	DGUI mm	DFC mm	DCLC mm	LCLC mm	OAL mm	BHTA °
F 37 / 1536 E	37	47	40	10	92	16

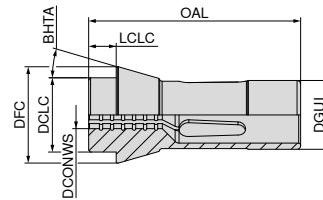

Pressure collet F 37 / 1536 E

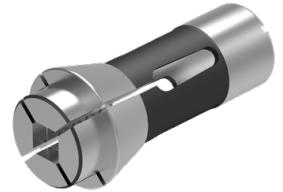

DCONWS mm	DCONWS inch	Grooved	Smooth	Grooved	Grooved
		F 37 / 1536 E	F 37 / 1536 E	F 37 / 1536 E	F 37 / 1536 E
		81 023 ...	81 025 ...	81 028 ...	81 030 ...
1,000			01000		
1,001 - 1,499			xxxxx ²⁾		
1,500			01500		
1,501 - 1,999			xxxxx ²⁾		
2,000			02000		
2,001 - 2,499			xxxxx ²⁾		
2,500			02500		
2,501 - 2,999			xxxxx ²⁾		
3,000			03000	03000 ¹⁾	03000 ¹⁾
3,001 - 3,499			xxxxx ²⁾		
3,500			03500		
3,501 - 3,999			xxxxx ²⁾		
4,000			04000	04000 ¹⁾	04000 ¹⁾
4,001 - 4,499			xxxxx ²⁾		
4,500			04500		
4,501 - 4,999			xxxxx ²⁾		
5,000			05000	05000 ¹⁾	05000 ¹⁾
5,001 - 5,499			xxxxx ²⁾		
5,500			05500		
5,501 - 5,999			xxxxx ²⁾		
6,000		06000	06000	06000 ¹⁾	06000 ¹⁾
6,001 - 6,349		xxxxx ²⁾			
6,350	1/4	06350	06350	06350 ¹⁾	06350 ¹⁾
6,351 - 6,499		xxxxx ²⁾			
6,500		06500	06500		
6,501 - 6,999		xxxxx ²⁾			
7,000		07000	07000	07000 ¹⁾	07000 ¹⁾
7,001 - 7,499		xxxxx ²⁾			
7,500		07500	07500		
7,501 - 7,999		xxxxx ²⁾			
8,000		08000	08000	08000	08000
8,001 - 8,499		xxxxx ²⁾			
8,500		08500	08500		
8,501 - 8,999		xxxxx ²⁾			
9,000		09000	09000	09000	09000
9,001 - 9,499		xxxxx ²⁾			
9,500		09500	09500		
9,501 - 9,524		xxxxx ²⁾			
9,525	3/8	09525			
9,526 - 9,999		xxxxx ²⁾			
10,000		10000	10000	10000	10000
10,001 - 10,499		xxxxx ²⁾			
10,500		10500	10500		
10,501 - 10,999		xxxxx ²⁾			

1) Without transverse grooves

2) Not available ex stock, articles are non-returnable and cannot be exchanged / Delivery time 7 working days



For xxxxx please specify the required diameter when ordering (e.g. Ø 6.789 - article number 81 023 06789).

Pressure collet F 37 / 1536 E

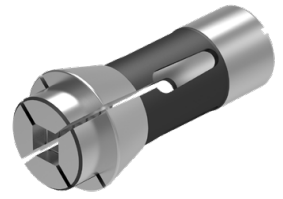

DCONWS mm	DCONWS inch	Grooved F 37 / 1536 E	Smooth F 37 / 1536 E	Grooved F 37 / 1536 E	Grooved F 37 / 1536 E
		81 023 ...	81 025 ...	81 028 ...	81 030 ...
11,000		11000	11000	11000	11000
11,001 - 11,499		xxxxx ²⁾			
11,500		11500	11500		
11,501 - 11,999		xxxxx ²⁾			
12,000		12000	12000	12000	12000
12,001 - 12,499		xxxxx ²⁾			
12,500		12500	12500		
12,501 - 12,699		xxxxx ²⁾			
12,700	1/2	12700	12700	12700	12700
12,701 - 12,999		xxxxx ²⁾			
13,000		13000	13000	13000	13000
13,001 - 13,499		xxxxx ²⁾			
13,500		13500	13500		
13,501 - 13,999		xxxxx ²⁾			
14,000		14000	14000	14000	14000
14,001 - 14,499		xxxxx ²⁾			
14,500		14500	14500		
14,501 - 14,999		xxxxx ²⁾			
15,000		15000	15000	15000	15000
15,001 - 15,499		xxxxx ²⁾			
15,500		15500	15500		
15,501 - 15,999		xxxxx ²⁾			
16,000		16000	16000	16000	16000
16,001 - 16,499		xxxxx ²⁾			
16,500		16500	16500		
16,501 - 16,999		xxxxx ²⁾			
17,000		17000	17000	17000	17000
17,001 - 17,499		xxxxx ²⁾			
17,500		17500	17500		
17,501 - 17,999		xxxxx ²⁾			
18,000		18000	18000	18000	18000
18,001 - 18,499		xxxxx ²⁾			
18,500		18500	18500		
18,501 - 18,999		xxxxx ²⁾			
19,000		19000	19000	19000	19000
19,001 - 19,049		xxxxx ²⁾			
19,050	3/4	19050	19050		
19,051 - 19,499		xxxxx ²⁾			
19,500		19500	19500		
19,501 - 19,999		xxxxx ²⁾			
20,000		20000	20000	20000	20000
20,001 - 20,499		xxxxx ²⁾			
20,500		20500	20500		
20,501 - 20,999		xxxxx ²⁾			
21,000		21000	21000	21000	21000
21,001 - 21,499		xxxxx ²⁾			
21,500		21500	21500		
21,501 - 21,999		xxxxx ²⁾			
22,000		22000	22000	22000	22000
22,001 - 22,224		xxxxx ²⁾			
22,225	7/8	22225			
22,226 - 22,499		xxxxx ²⁾			
22,500		22500	22500		
22,501 - 22,999		xxxxx ²⁾			
23,000		23000	23000	23000	23000

1) Without transverse grooves

2) Not available ex stock, articles are non-returnable and cannot be exchanged / Delivery time 7 working days



For xxxxx please specify the required diameter when ordering (e.g. Ø 6.789 – article number 81 023 06789).

Pressure collet F 37 / 1536 E

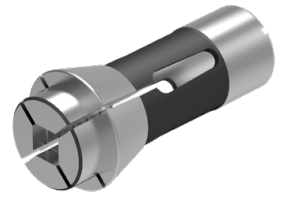

DCONWS mm	DCONWS inch	Grooved F 37 / 1536 E	Smooth F 37 / 1536 E	Grooved F 37 / 1536 E	Grooved F 37 / 1536 E
		81 023 ...	81 025 ...	81 028 ...	81 030 ...
23,001 - 23,499		xxxxx ²⁾			
23,500		23500	23500		
23,501 - 23,999		xxxxx ²⁾			
24,000		24000	24000	24000	
24,001 - 24,499		xxxxx ²⁾			
24,500		24500	24500		
24,501 - 24,999		xxxxx ²⁾			
25,000		25000	25000	25000	
25,001 - 25,499		xxxxx ²⁾			
25,400	1/1			25400	
25,500		25500	25500		
25,501 - 25,999		xxxxx ²⁾			
26,000		26000	26000	26000	
26,001 - 26,499		xxxxx ²⁾			
26,500		26500	26500		
26,501 - 26,999		xxxxx ²⁾			
27,000		27000	27000	27000	
27,001 - 27,499		xxxxx ²⁾			
27,500		27500	27500		
27,501 - 27,999		xxxxx ²⁾			
28,000		28000	28000		
28,001 - 28,499		xxxxx ²⁾			
28,500		28500	28500		
28,501 - 28,999		xxxxx ²⁾			
29,000		29000	29000		
29,001 - 29,499		xxxxx ²⁾			
29,500		29500	29500		
29,501 - 29,999		xxxxx ²⁾			
30,000		30000	30000		
30,001 - 30,499		xxxxx ²⁾			
30,500		30500	30500		
30,501 - 30,999		xxxxx ²⁾			
31,000		31000	31000		
31,001 - 31,499		xxxxx ²⁾			
31,500		31500	31500		
31,501 - 31,999		xxxxx ²⁾			
32,000		32000	32000		







1) Without transverse grooves

2) Not available ex stock, articles are non-returnable and cannot be exchanged / Delivery time 7 working days



For xxxxx please specify the required diameter when ordering (e.g. Ø 6.789 - article number 81 023 06789).

Stem collets overview

Norm	Clamping diameter range in mm	Profile	Version	Page No.
116 E / F 13	Ø 1,0 – 8,0		Smooth	15
120 E / F 15	Ø 1,0 – 8,0		Smooth	15
F 16 / 1212 E	Ø 1,0 – 9,0		Smooth	16
138 E / F 20-87	Ø 1,0 – 12,0		Smooth	16
136 E / F 20-201	Ø 1,0 – 14,0		Smooth	17
145 E / F 25	Ø 1,0 – 20,0		Smooth	18
F 37 / 1536 E	Ø 1,0 – 28,0		Smooth	19



Other profile shapes and sizes and extended options available on request.



Should you wish to send us a request for specially adjusted solutions, you will find a detailed form in the download area on our homepage. Please fill it out carefully and send it via email or print it out and send via fax. → cuttingtools.ceratizit.com/gb/en/download.html

Please email the completed form to techsupport.uk@ceratizit.com.

Stem collets

Designation	DGUI mm	DFC mm	DCLC mm	LCLC mm	OAL mm	BHTA °	LFSF mm
116 E / F 13	13	19	13	12	70	16	6
120 E / F 15	15	21	15	13	71	16	7
120 E / F 15	15	21	15	15	73	16	9

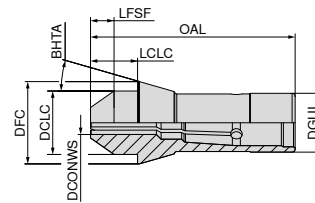

Stem collet 116 E / F 13

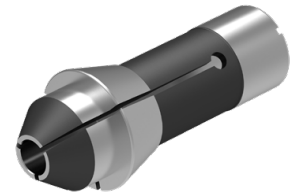

Smooth
116 E / F 13

81 001 ...

DCONWS mm	
1	01000
2	02000
3	03000
4	04000
5	05000
6	06000
7	07000

Stem collet 120 E / F 15

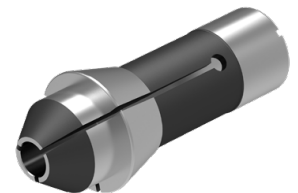

Smooth
120 E / F 15
LFSF = 7 mm

Smooth
120 E / F 15
LFSF = 9 mm

81 004 ...

81 006 ...

DCONWS mm		
1	01000	01000
2	02000	02000
3	03000	03000
4	04000	04000
5	05000	05000
6	06000	06000
7	07000	07000
8	08000	08000

Stem collets

Designation	DGUI mm	DFC mm	DCLC mm	LCLC mm	OAL mm	BHTA °	LFSF mm
F 16 / 1212 E	16	21	16	13	71	16	7
F 16 / 1212 E	16	21	16	15	73	16	9
138 E / F20-87	20	28	21	15	78	16	8
138 E / F20-87	20	28	21	20	80	16	13

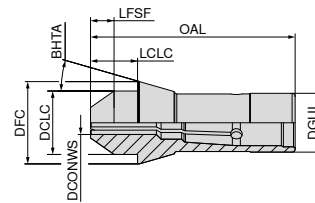

Stem collet F 16 / 1212 E

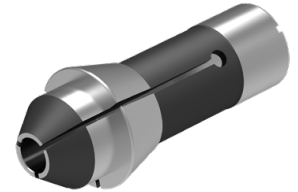

DCONWS mm	Smooth F 16 / 1212 E LFSF = 7 mm	Smooth F 16 / 1212 E LFSF = 9 mm
	81 020 ...	81 022 ...
1	01000	01000
2	02000	02000
3	03000	03000
4	04000	04000
5	05000	05000
6	06000	06000
7	07000	07000
8	08000	08000
9	09000	09000

Stem collet 138 E / F 20-87

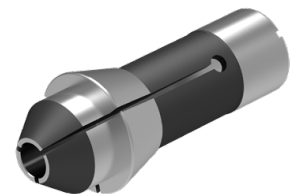

DCONWS mm	Smooth 138 E / F20-87 LFSF = 8 mm	Smooth 138 E / F20-87 LFSF = 13 mm
	81 012 ...	81 014 ...
1	01000	01000
2	02000	02000
3	03000	03000
4	04000	04000
5	05000	05000
6	06000	06000
7	07000	07000
8	08000	08000
9	09000	09000
10	10000	10000
11	11000	11000
12	12000	12000

Stem collets

Designation	DGUI mm	DFC mm	DCLC mm	LCLC mm	OAL mm	BHTA °	LFSF mm
136 E / F 20-201	20	26	19	13	62	15	8
136 E / F 20-201	20	26	19	15	64	15	10

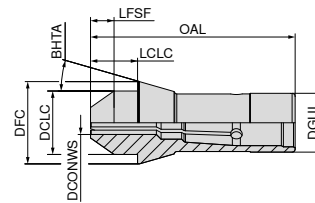

Stem collet 136 E / F 20-201

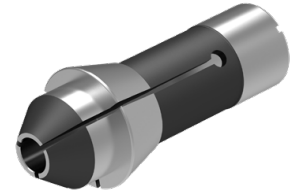

Smooth 136 E / F 20-201 LFSF = 8 mm	Smooth 136 E / F 20-201 LFSF = 10 mm
---	--

DCONWS mm	81 008 ...	81 010 ...
1	01000	01000
2	02000	02000
3	03000	03000
4	04000	04000
5	05000	05000
6	06000	06000
7	07000	07000
8	08000	08000
9	09000	09000
10	10000	10000
11	11000	11000
12	12000	12000
13		13000
14		14000

Stem collets

Designation	DGUI mm	DFC mm	DCLC mm	LCLC mm	OAL mm	BHTA °	LFSF mm
145 E / F 25	25	35	27	20	87	16	10
145 E / F 25	25	35	27	25	92	16	15

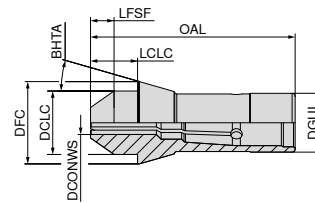

Stem collet 145 E / F 25

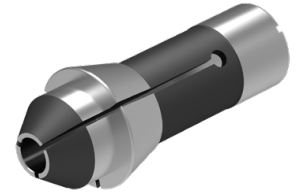

Smooth 145 E / F 25 LFSF = 10 mm	Smooth 145 E / F 25 LFSF = 15 mm
--	--

DCONWS mm	81 016 ...	81 018 ...
1	01000	01000
2	02000	02000
3	03000	03000
4	04000	04000
5	05000	05000
6	06000	06000
7	07000	07000
8	08000	08000
9	09000	09000
10	10000	10000
11	11000	11000
12	12000	12000
13	13000	13000
14	14000	14000
15	15000	15000
16	16000	16000
17	17000	17000
18	18000	18000
19	19000	19000
20	20000	20000

Stem collets

Designation	DGUI mm	DFC mm	DCLC mm	LCLC mm	OAL mm	BHTA °	LFSF mm
F 37 / 1536 E	37	47	40	25	107	16	15

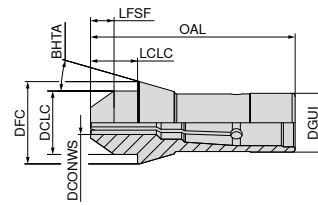

Stem collet F 37 / 1536 E

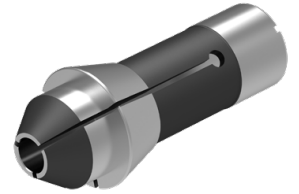











●
Smooth
F 37 / 1536 E

81 024 ...

DCONWS mm	
1	01000
2	02000
3	03000
4	04000
5	05000
6	06000
7	07000
8	08000
9	09000
10	10000
11	11000
12	12000
13	13000
14	14000
15	15000
16	16000
17	17000
18	18000
19	19000
20	20000
21	21000
22	22000
23	23000
24	24000
25	25000
26	26000
27	27000
28	28000

Adjustable guide bushes overview

Norm	Guide diameter range in mm	Profile	Version	Page No.
I353	Ø 1,0 - 10,5		Carbide insert	21
F853	Ø 1,0 - 13,0		Carbide insert	22
F391	Ø 1,0 - 18,0		Carbide insert	23
F605	Ø 1,0 - 17,0		Carbide insert	24
T223	Ø 1,0 - 22,0		Carbide insert	25
	SW 2,0 - 11,0		Carbide insert	25
	SW 2,0 - 15,0		Carbide insert	25
I357	Ø 2,0 - 22,0		Carbide insert	26
T227	Ø 1,0 - 25,0		Carbide insert	27
T229	Ø 2,0 - 32,0		Carbide insert	28
	SW 2,0 - 14,0		Carbide insert	28

Flexible GBE guide bushes overview

GBE 28	Ø 2,0 - 15,0		29
GBE 42	Ø 2,0 - 15,0		30



Other profile shapes and sizes and extended options available on request.

Adjustable guide bushes

Designation	DGUI mm	DFC mm	OAL mm	BHTA °	THOD
I 353	16	19.5	56.79	16	M14 x 1

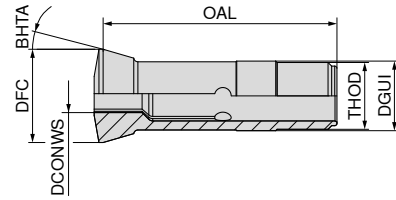

Adjustable guide bush I 353

- ▲ For Star* CNC sliding head lathes
- ▲ With carbide insert



I 353

81 035 ...

DCONWS mm	
1.0	01000
1.5	01500
2.0	02000
2.5	02500
3.0	03000
3.5	03500
4.0	04000
4.5	04500
5.0	05000
5.5	05500
6.0	06000
6.5	06500
7.0	07000
7.5	07500
8.0	08000
8.5	08500
9.0	09000
9.5	09500
10.0	10000
10.5	10500

Adjustable guide bushes

Designation	DGUI mm	DFC mm	OAL mm	BHTA °	THOD
F 853	18	22	60	30	M16 x 1

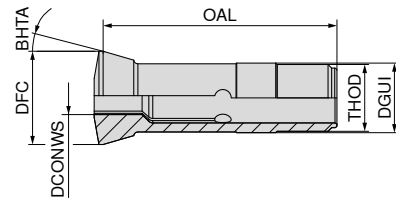

Adjustable guide bush F 853

▲ With carbide insert



F 853

81 034 ...

DCONWS mm	
1.0	01000
1.5	01500
2.0	02000
2.5	02500
3.0	03000
3.5	03500
4.0	04000
4.5	04500
5.0	05000
5.5	05500
6.0	06000
6.5	06500
7.0	07000
7.5	07500
8.0	08000
8.5	08500
9.0	09000
9.5	09500
10.0	10000
10.5	10500
11.0	11000
11.5	11500
12.0	12000
12.5	12500
13.0	13000

Adjustable guide bushes

Designation	DGUI mm	DFC mm	OAL mm	BHTA °	THOD
F 391	22	29	68	16	M22 x 1

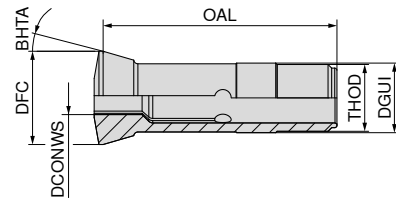

Adjustable guide bush F 391

▲ With carbide insert



F 391

81 032 ...

DCONWS mm	DCONWS inch	81 032 ...
1,000		01000
1,001 - 1,499		xxxxx ¹⁾
1,500		01500
1,501 - 1,999		xxxxx ¹⁾
2,000		xxxxx ¹⁾
2,001 - 2,499		xxxxx ¹⁾
2,500		02500
2,501 - 2,999		xxxxx ¹⁾
3,000		03000
3,001 - 3,499		xxxxx ¹⁾
3,500		03500
3,501 - 3,999		xxxxx ¹⁾
4,000		04000
4,001 - 4,499		xxxxx ¹⁾
4,500		04500
4,501 - 4,999		xxxxx ¹⁾
5,000		05000
5,001 - 5,499		xxxxx ¹⁾
5,500		05500
5,501 - 5,999		xxxxx ¹⁾
6,000		06000
6,001 - 6,349		xxxxx ¹⁾
6,350	1/4	06350
6,351 - 6,499		xxxxx ¹⁾
6,500		06500
6,501 - 6,999		xxxxx ¹⁾
7,000		07000
7,001 - 7,499		xxxxx ¹⁾
7,500		07500
7,501 - 7,999		xxxxx ¹⁾
8,000		08000
8,001 - 8,499		xxxxx ¹⁾
8,500		08500
8,501 - 8,999		xxxxx ¹⁾
9,000		09000
9,001 - 9,499		xxxxx ¹⁾
9,500		09500
9,501 - 9,999		xxxxx ¹⁾
10,000		10000
10,001 - 10,499		xxxxx ¹⁾
10,500		10500
10,501 - 10,999		xxxxx ¹⁾
11,000		11000
11,001 - 11,499		xxxxx ¹⁾
11,500		11500
11,501 - 11,999		xxxxx ¹⁾
12,000		12000
12,001 - 12,499		xxxxx ¹⁾
12,500		12500
12,501 - 12,699		xxxxx ¹⁾

81 032 ...

DCONWS mm	DCONWS inch	81 032 ...
12,700	1/2	12700
12,701 - 12,999		xxxxx ¹⁾
13,000		13000
13,001 - 13,499		xxxxx ¹⁾
13,500		13500
13,501 - 13,999		xxxxx ¹⁾
14,000		14000
14,001 - 14,499		xxxxx ¹⁾
14,500		14500
14,501 - 14,999		xxxxx ¹⁾
15,000		15000
15,001 - 15,499		xxxxx ¹⁾
15,500		15500
15,501 - 15,999		xxxxx ¹⁾
16,000		16000
16,001 - 16,499		xxxxx ¹⁾
16,500		16500
16,501 - 16,999		xxxxx ¹⁾
17,000		17000
17,001 - 17,499		xxxxx ¹⁾
17,500		17500
17,501 - 17,999		xxxxx ¹⁾
18,000		18000

1) Not available ex stock, articles are non-returnable and cannot be exchanged / Delivery time 7 working days



For xxxxx please specify the required diameter when ordering (e.g. Ø 6.789 – article number 81 032 06789).

Adjustable guide bushes

Designation	DGUI mm	DFC mm	OAL mm	BHTA °	THOD M24 x 1
F 605	24	29.5	61	30	M24 x 1

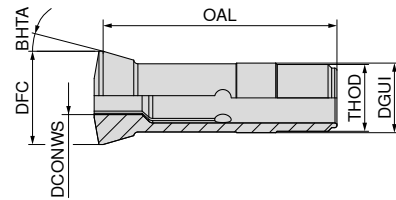

Adjustable guide bush F 605

▲ With carbide insert



F 605

81 033 ...

DCONWS mm	DCONWS inch	81 033 ...
1,000		01000
1,001 - 1,499		xxxxx ¹⁾
1,500		01500
1,501 - 1,999		xxxxx ¹⁾
2,000		02000
2,001 - 2,499		xxxxx ¹⁾
2,500		02500
2,501 - 2,999		xxxxx ¹⁾
3,000		03000
3,001 - 3,174		xxxxx ¹⁾
3,175	1/8	03175
3,176 - 3,499		xxxxx ¹⁾
3,500		03500
3,501 - 3,999		xxxxx ¹⁾
4,000		04000
4,001 - 4,499		xxxxx ¹⁾
4,500		04500
4,501 - 4,762		xxxxx ¹⁾
4,763	3/16	04763
4,764 - 4,999		xxxxx ¹⁾
5,000		05000
5,001 - 5,499		xxxxx ¹⁾
5,500		05500
5,501 - 5,999		xxxxx ¹⁾
6,000		06000
6,001 - 6,349		xxxxx ¹⁾
6,350	1/4	06350
6,351 - 6,499		xxxxx ¹⁾
6,500		06500
6,501 - 6,999		xxxxx ¹⁾
7,000		07000
7,001 - 7,499		xxxxx ¹⁾
7,500		07500
7,501 - 7,999		xxxxx ¹⁾
8,000		08000
8,001 - 8,499		xxxxx ¹⁾
8,500		08500
8,501 - 8,999		xxxxx ¹⁾
9,000		09000
9,001 - 9,499		xxxxx ¹⁾
9,500		09500
9,501 - 9,999		xxxxx ¹⁾
10,000		10000
10,001 - 10,499		xxxxx ¹⁾
10,500		10500
10,501 - 10,999		xxxxx ¹⁾
11,000		11000
11,001 - 11,499		xxxxx ¹⁾
11,500		11500
11,501 - 11,999		xxxxx ¹⁾

DCONWS mm	DCONWS inch	81 033 ...
12,000		12000
12,001 - 12,499		xxxxx ¹⁾
12,500		12500
12,501 - 12,699		xxxxx ¹⁾
12,700	1/2	12700
12,701 - 12,999		xxxxx ¹⁾
13,000		13000
13,001 - 13,499		xxxxx ¹⁾
13,500		13500
13,501 - 13,999		xxxxx ¹⁾
14,000		14000
14,001 - 14,499		xxxxx ¹⁾
14,500		14500
14,501 - 14,999		xxxxx ¹⁾
15,000		15000
15,001 - 15,499		xxxxx ¹⁾
15,500		15500
15,501 - 15,999		xxxxx ¹⁾
16,000		16000
16,001 - 16,499		xxxxx ¹⁾
16,500		16500
16,501 - 16,999		xxxxx ¹⁾
17,000		17000

1) Not available ex stock, articles are non-returnable and cannot be exchanged / Delivery time 7 working days



For xxxxx please specify the required diameter when ordering (e.g. Ø 6.789 – article number 81 033 06789).

Adjustable guide bushes

Designation	DGUI mm	DFC mm	OAL mm	BHTA °	THOD
T 223	28	34	82	16	M25 x 1

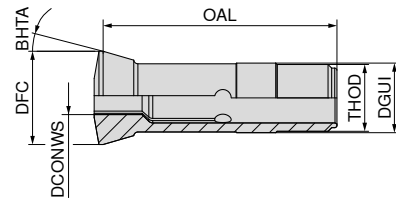

Adjustable guide bush T 223

▲ With carbide insert

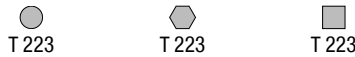

DCONWS mm		DCONWS inch	81 037 ...	81 038 ...	81 039 ...
1,000			01000		
1,001 - 1,499			xxxxx ¹⁾		
1,500			01500		
1,501 - 1,999			xxxxx ¹⁾		
2,000			02000		
2,001 - 2,499			xxxxx ¹⁾		
2,500			02500		
2,501 - 2,999			xxxxx ¹⁾		
3,000			03000	03000	03000
3,001 - 3,499			xxxxx ¹⁾		
3,500			03500		
3,501 - 3,999			xxxxx ¹⁾		
4,000			04000	04000	04000
4,001 - 4,499			xxxxx ¹⁾		
4,500			04500		
4,501 - 4,999			xxxxx ¹⁾		
5,000			05000	05000	05000
5,001 - 5,499			xxxxx ¹⁾		
5,500			05500		
5,501 - 5,999			xxxxx ¹⁾		
6,000			06000	06000	06000
6,001 - 6,349			xxxxx ¹⁾		
6,350	1/4		06350	06350	06350
6,351 - 6,499			xxxxx ¹⁾		
6,500			06500		
6,501 - 6,999			xxxxx ¹⁾		
7,000			07000	07000	07000
7,001 - 7,499			xxxxx ¹⁾		
7,500			07500		
7,501 - 7,999			xxxxx ¹⁾		
7,938	5/16		07938	07938	
8,000			08000	08000	08000
8,001 - 8,499			xxxxx ¹⁾		
8,500			08500		
8,501 - 8,999			xxxxx ¹⁾		
9,000			09000	09000	09000
9,001 - 9,499			xxxxx ¹⁾		
9,500			09500		
9,501 - 9,999			xxxxx ¹⁾		
9,525	3/8		09525	09525	
10,000			10000	10000	10000
10,001 - 10,499			xxxxx ¹⁾		
10,500			10500		
10,501 - 10,999			xxxxx ¹⁾		
11,000			11000	11000	11000
11,001 - 11,499			xxxxx ¹⁾		
11,500			11500		
11,501 - 11,999			xxxxx ¹⁾		
12,000			12000	12000	12000
12,001 - 12,499			xxxxx ¹⁾		

DCONWS mm		DCONWS inch	81 037 ...	81 038 ...	81 039 ...
12,500			12500		
12,501 - 12,699			xxxxx ¹⁾		
12,700	1/2		12700	12700	
12,701 - 12,999			xxxxx ¹⁾		
13,000			13000	13000	13000
13,001 - 13,499			xxxxx ¹⁾		
13,500			13500		
13,501 - 13,999			xxxxx ¹⁾		
14,000			14000	14000	14000
14,001 - 14,499			xxxxx ¹⁾		
14,500			14500		
14,501 - 14,999			xxxxx ¹⁾		
15,000			15000	15000	
15,001 - 15,499			xxxxx ¹⁾		
15,500			15500		
15,501 - 15,999			xxxxx ¹⁾		
16,000			16000	16000	
16,001 - 16,499			xxxxx ¹⁾		
16,500			16500		
16,501 - 16,999			xxxxx ¹⁾		
17,000			17000	17000	
17,001 - 17,499			xxxxx ¹⁾		
17,500			17500		
17,501 - 17,999			xxxxx ¹⁾		
18,000			18000		
18,001 - 18,499			xxxxx ¹⁾		
18,500			18500		
18,501 - 18,999			xxxxx ¹⁾		
19,000			19000		
19,001 - 19,499			xxxxx ¹⁾		
19,500			19500		
19,501 - 19,999			xxxxx ¹⁾		
20,000			20000		
20,001 - 20,499			xxxxx ¹⁾		
20,500			20500		
20,501 - 20,999			xxxxx ¹⁾		
21,000			21000		
21,001 - 21,499			xxxxx ¹⁾		
21,500			21500		
21,501 - 21,999			xxxxx ¹⁾		
22,000			22000		

1) Not available ex stock, articles are non-returnable and cannot be exchanged / Delivery time 7 working days

For xxxxx please specify the required diameter when ordering (e.g. Ø 6.789 – article number 81 037 06789).

Adjustable guide bushes

Designation	DGUI mm	DFC mm	OAL mm	BHTA °	THOD
I 357	28	38	81	30	M25 x 1

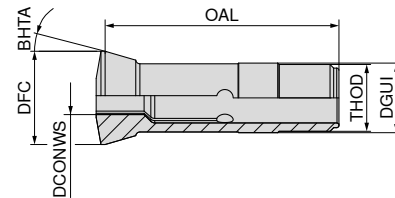

Adjustable guide bush I 357

▲ With carbide insert



I 357

81 036 ...

DCONWS mm	DCONWS inch	81 036 ...
2,000		02000
2,001 - 2,499		xxxxx ¹⁾
2,500		02500
2,501 - 2,999		xxxxx ¹⁾
3,000		03000
3,001 - 3,174		xxxxx ¹⁾
3,175	1/8	03175
3,176 - 3,499		xxxxx ¹⁾
3,500		03500
3,501 - 3,999		xxxxx ¹⁾
4,000		04000
4,001 - 4,499		xxxxx ¹⁾
4,500		04500
4,501 - 4,999		xxxxx ¹⁾
5,000		05000
5,001 - 5,499		xxxxx ¹⁾
5,500		05500
5,501 - 5,999		xxxxx ¹⁾
6,000		06000
6,001 - 6,499		xxxxx ¹⁾
6,500		06500
6,501 - 6,999		xxxxx ¹⁾
7,000		07000
7,001 - 7,143		xxxxx ¹⁾
7,144	9/32	07144
7,145 - 7,499		xxxxx ¹⁾
7,500		07500
7,501 - 7,999		xxxxx ¹⁾
8,000		08000
8,001 - 8,499		xxxxx ¹⁾
8,500		08500
8,501 - 8,999		xxxxx ¹⁾
9,000		09000
9,001 - 9,499		xxxxx ¹⁾
9,500		09500
9,501 - 9,999		xxxxx ¹⁾
10,000		10000
10,001 - 10,499		xxxxx ¹⁾
10,500		10500
10,501 - 10,999		xxxxx ¹⁾
11,000		11000
11,001 - 11,499		xxxxx ¹⁾
11,500		11500
11,501 - 11,999		xxxxx ¹⁾
12,000		12000
12,001 - 12,499		xxxxx ¹⁾
12,500		12500
12,501 - 12,699		xxxxx ¹⁾
12,700	1/2	12700
12,701 - 12,999		xxxxx ¹⁾

81 036 ...

DCONWS mm	DCONWS inch	81 036 ...
13,000		13000
13,001 - 13,499		xxxxx ¹⁾
13,500		13500
13,501 - 13,999		xxxxx ¹⁾
14,000		14000
14,001 - 14,499		xxxxx ¹⁾
14,500		14500
14,501 - 14,999		xxxxx ¹⁾
15,000		15000
15,001 - 15,499		xxxxx ¹⁾
15,500		15500
15,501 - 15,999		xxxxx ¹⁾
16,000		16000
16,001 - 16,499		xxxxx ¹⁾
16,500		16500
16,501 - 16,999		xxxxx ¹⁾
17,000		17000
17,001 - 17,499		xxxxx ¹⁾
17,500		17500
17,501 - 17,999		xxxxx ¹⁾
18,000		18000
18,001 - 18,499		xxxxx ¹⁾
18,500		18500
18,501 - 18,999		xxxxx ¹⁾
19,000		19000
19,001 - 19,499		xxxxx ¹⁾
19,500		19500
19,501 - 19,999		xxxxx ¹⁾
20,000		20000
20,001 - 20,499		xxxxx ¹⁾
20,500		20500
20,501 - 20,999		xxxxx ¹⁾
21,000		21000
21,001 - 21,499		xxxxx ¹⁾
21,500		21500
21,501 - 21,999		xxxxx ¹⁾
22,000		22000

1) Not available ex stock, articles are non-returnable and cannot be exchanged /
Delivery time 7 working days



For xxxxx please specify the required diameter when ordering
(e.g. Ø 6.789 – article number 81 036 06789).

Adjustable guide bushes

Designation	DGUI mm	DFC mm	OAL mm	BHTA °	THOD
T 227	34	41	87.5	10	M34 x 1

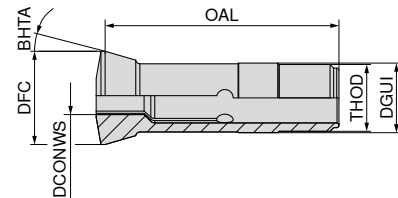

Adjustable guide bush T 227

▲ With carbide insert



T 227

81 040 ...

DCONWS mm	DCONWS inch	81 040 ...
1,000		01000
1,001 - 1,499		xxxxx ¹⁾
1,500		01500
1,501 - 1,999		xxxxx ¹⁾
2,000		02000
2,001 - 2,499		xxxxx ¹⁾
2,500		02500
2,501 - 2,999		xxxxx ¹⁾
3,000		03000
3,001 - 3,499		xxxxx ¹⁾
3,500		03500
3,501 - 3,999		xxxxx ¹⁾
4,000		04000
4,001 - 4,499		xxxxx ¹⁾
4,500		04500
4,501 - 4,999		xxxxx ¹⁾
5,000		05000
5,001 - 5,499		xxxxx ¹⁾
5,500		05500
5,501 - 5,999		xxxxx ¹⁾
6,000		06000
6,001 - 6,349		xxxxx ¹⁾
6,350	1/4	06350
6,351 - 6,499		xxxxx ¹⁾
6,500		06500
6,501 - 6,999		xxxxx ¹⁾
7,000		07000
7,001 - 7,499		xxxxx ¹⁾
7,500		07500
7,501 - 7,999		xxxxx ¹⁾
8,000		08000
8,001 - 8,499		xxxxx ¹⁾
8,500		08500
8,501 - 8,999		xxxxx ¹⁾
9,000		09000
9,001 - 9,499		xxxxx ¹⁾
9,500		09500
9,501 - 9,999		xxxxx ¹⁾
10,000		10000
10,001 - 10,499		xxxxx ¹⁾
10,500		10500
10,501 - 10,999		xxxxx ¹⁾
11,000		11000
11,001 - 11,499		xxxxx ¹⁾
11,500		11500
11,501 - 11,999		xxxxx ¹⁾
12,000		12000
12,001 - 12,499		xxxxx ¹⁾
12,500		12500
12,501 - 12,699		xxxxx ¹⁾
12,700	1/2	12700
12,701 - 12,999		xxxxx ¹⁾

DCONWS mm	DCONWS inch	81 040 ...
13,000		13000
13,001 - 13,499		xxxxx ¹⁾
13,500		13500
13,501 - 13,999		xxxxx ¹⁾
14,000		14000
14,001 - 14,499		xxxxx ¹⁾
14,500		14500
14,501 - 14,999		xxxxx ¹⁾
15,000		15000
15,001 - 15,499		xxxxx ¹⁾
15,500		15500
15,501 - 15,999		xxxxx ¹⁾
16,000		16000
16,001 - 16,499		xxxxx ¹⁾
16,500		16500
16,501 - 16,999		xxxxx ¹⁾
17,000		17000
17,001 - 17,499		xxxxx ¹⁾
17,500		17500
17,501 - 17,999		xxxxx ¹⁾
18,000		18000
18,001 - 18,499		xxxxx ¹⁾
18,500		18500
18,501 - 18,999		xxxxx ¹⁾
19,000		19000
19,001 - 19,499		xxxxx ¹⁾
19,500		19500
19,501 - 19,999		xxxxx ¹⁾
20,000		20000
20,001 - 20,499		xxxxx ¹⁾
20,500		20500
20,501 - 20,999		xxxxx ¹⁾
21,000		21000
21,001 - 21,499		xxxxx ¹⁾
21,500		21500
21,501 - 21,999		xxxxx ¹⁾
22,000		22000
22,001 - 22,499		xxxxx ¹⁾
22,500		22500
22,501 - 22,999		xxxxx ¹⁾
23,000		23000
23,001 - 23,499		xxxxx ¹⁾
23,500		23500
23,501 - 23,999		xxxxx ¹⁾
24,000		24000
24,001 - 24,499		xxxxx ¹⁾
24,500		24500
24,501 - 24,999		xxxxx ¹⁾
25,000		25000

1) Not available ex stock, articles are non-returnable and cannot be exchanged / Delivery time 7 working days



For xxxx please specify the required diameter when ordering (e.g. Ø 6.789 – article number 81 040 06789).

Adjustable guide bushes

Designation	DGUI mm	DFC mm	OAL mm	BHTA °	THOD
T 229	42	49	82	16	M40 x 1

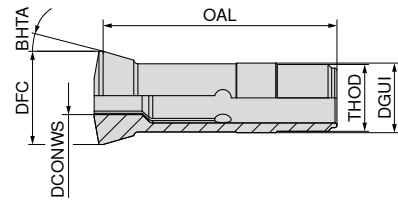

Adjustable guide bush T 229

▲ With carbide insert



T 229 (circle icon) T 229 (hexagon icon)

81 041 ...		81 042 ...	
DCONWS mm	DCONWS inch		
2,000		02000	
2,001 - 2,499		xxxxx ¹⁾	
2,500		02500	
2,501 - 2,999		xxxxx ¹⁾	
3,000		03000	
3,001 - 3,499		xxxxx ¹⁾	
3,500		03500	
3,501 - 3,999		xxxxx ¹⁾	
4,000		04000	
4,001 - 4,499		xxxxx ¹⁾	
4,500		04500	
4,501 - 4,999		xxxxx ¹⁾	
5,000		05000	
5,001 - 5,499		xxxxx ¹⁾	
5,500		05500	
5,501 - 5,999		xxxxx ¹⁾	
6,000		06000	
6,001 - 6,349		xxxxx ¹⁾	
6,350	1/4	06350	
6,351 - 6,499		xxxxx ¹⁾	
6,500		06500	
6,501 - 6,999		xxxxx ¹⁾	
7,000		07000	
7,001 - 7,499		xxxxx ¹⁾	
7,500		07500	
7,501 - 7,999		xxxxx ¹⁾	
8,000		08000	
8,001 - 8,499		xxxxx ¹⁾	
8,500		08500	
8,501 - 8,999		xxxxx ¹⁾	
9,000		09000	
9,001 - 9,499		xxxxx ¹⁾	
9,500		09500	
9,501 - 9,524		xxxxx ¹⁾	
9,525	3/8	09525	
9,526 - 9,999		xxxxx ¹⁾	
10,000		10000	
10,001 - 10,499		xxxxx ¹⁾	
10,500		10500	
10,501 - 10,999		xxxxx ¹⁾	
11,000		11000	
11,001 - 11,499		xxxxx ¹⁾	
11,500		11500	
11,501 - 11,999		xxxxx ¹⁾	
12,000		12000	
12,001 - 12,499		xxxxx ¹⁾	
12,500		12500	
12,501 - 12,699		xxxxx ¹⁾	
12,700	1/2	12700	
12,701 - 12,999		xxxxx ¹⁾	
13,000		13000	
13,001 - 13,499		xxxxx ¹⁾	
13,500		13500	
13,501 - 13,999		xxxxx ¹⁾	
14,000		14000	
14,001 - 14,499		xxxxx ¹⁾	
14,500		14500	
14,501 - 14,999		xxxxx ¹⁾	
15,000		15000	
15,001 - 15,499		xxxxx ¹⁾	
15,500		15500	
15,501 - 15,999		xxxxx ¹⁾	
16,000		16000	
16,001 - 16,499		xxxxx ¹⁾	

81 041 ...		81 042 ...	
DCONWS mm	DCONWS inch		
16,500		16500	
16,501 - 16,999		xxxxx ¹⁾	
17,000		17000	17000
17,001 - 17,499		xxxxx ¹⁾	
17,500		17500	
17,501 - 17,999		xxxxx ¹⁾	
18,000		18000	18000
18,001 - 18,499		xxxxx ¹⁾	
18,500		18500	
18,501 - 18,999		xxxxx ¹⁾	
19,000		19000	19000
19,001 - 19,049		xxxxx ¹⁾	
19,050	3/4	19050	
19,051 - 19,499		xxxxx ¹⁾	
19,500		19500	
19,501 - 19,999		xxxxx ¹⁾	
20,000		20000	20000
20,001 - 20,499		xxxxx ¹⁾	
20,500		20500	
20,501 - 20,999		xxxxx ¹⁾	
21,000		21000	21000
21,001 - 21,499		xxxxx ¹⁾	
21,500		21500	
21,501 - 21,999		xxxxx ¹⁾	
22,000		22000	22000
22,001 - 22,224		xxxxx ¹⁾	
22,225	7/8	22225	
22,226 - 22,499		xxxxx ¹⁾	
22,500		22500	
22,501 - 22,999		xxxxx ¹⁾	
23,000		23000	23000
23,001 - 23,499		xxxxx ¹⁾	
23,500		23500	
23,501 - 23,999		xxxxx ¹⁾	
24,000		24000	24000
24,001 - 24,499		xxxxx ¹⁾	
24,500		24500	
24,501 - 24,999		xxxxx ¹⁾	
25,000		25000	25000
25,001 - 25,499		xxxxx ¹⁾	
25,500		25500	
25,501 - 25,999		xxxxx ¹⁾	
26,000		26000	26000
26,001 - 26,499		xxxxx ¹⁾	
26,500		26500	
26,501 - 26,999		xxxxx ¹⁾	
27,000		27000	27000
27,001 - 27,499		xxxxx ¹⁾	
27,500		27500	
27,501 - 27,999		xxxxx ¹⁾	
28,000		28000	
28,001 - 28,499		xxxxx ¹⁾	
28,500		28500	
28,501 - 28,999		xxxxx ¹⁾	
29,000		29000	
29,001 - 29,499		xxxxx ¹⁾	
29,500		29500	
29,501 - 29,999		xxxxx ¹⁾	
30,000		30000	
30,001 - 30,499		xxxxx ¹⁾	
30,500		30500	
30,501 - 30,999		xxxxx ¹⁾	
31,000		31000	
31,001 - 31,499		xxxxx ¹⁾	
31,500		31500	
31,501 - 31,999		xxxxx ¹⁾	
32,000		32000	

1) Not available ex stock, articles are non-returnable and cannot be exchanged / Delivery time 7 working days



For xxxx please specify the required diameter when ordering (e.g. Ø 6.789 – article number 81 041 06789).

Flexible guide bushes

Designation	DFC mm	OAL mm	BHTA °
GBE 28	28	40	22.5

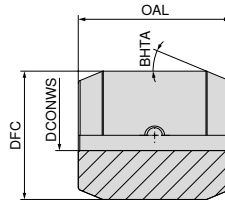

Guide bush GBE 28



GBE 28

81 059 ...

DCONWS mm	DCONWS inch	
3.000		03000
4.000		04000
5.000		05000
6.000		06000
6.350	1/4	06350
7.000		07000
8.000		08000
9.000		09000
9.525	3/8	09525
10.000		10000
11.000		11000
12.000		12000
12.700	1/2	12700
13.000		13000
14.000		14000
15.000		15000
16.000		16000
17.000		17000
18.000		18000
19.000		19000
19.050	3/4	19050
20.000		20000

Flexible guide bushes

Designation	DFC mm	OAL mm	BHTA °
GBE 42	42	50	22.5

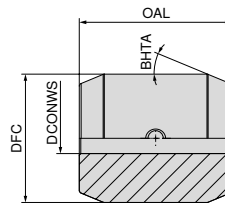

Guide bush GBE 42



















●
GBE 42

81 060 ...

DCONWS mm	DCONWS inch	
3.000		03000
4.000		04000
5.000		05000
6.000		06000
6.350	1/4	06350
7.000		07000
8.000		08000
9.000		09000
10.000		10000
11.000		11000
12.000		12000
12.700	1/2	12700
13.000		13000
14.000		14000
15.000		15000
15.875	5/8	15880
16.000		16000
17.000		17000
18.000		18000
19.000		19000
19.050	3/4	19050
20.000		20000
21.000		21000
22.000		22000
22.225	7/8	22225
23.000		23000
24.000		24000
25.000		25000
25.400	1/1	25400
26.000		26000
27.000		27000
28.000		28000
29.000		29000
30.000		30000
31.000		31000
32.000		32000

Clamping sleeves overview

Norm	External diameter range in mm	Clamping diameter range	Profile	Version	Page No.
S 10 / 210 E	10	Ø 3,0 - 10,0			32
		SW 3,0 - 8,0			32
S 12 / 212 E	12	Ø 3,0 - 11,0			33
		SW 3,0 - 9,0			33
S 15 / 203 E	15	Ø 3,0 - 14,0			34
		SW 3,0 - 12,0			34
S 16	16	Ø 3,0 - 15,0			35
		SW 3,0 - 13,0			35
S 18 / 218 E	18	Ø 3,0 - 16,0			36
		SW 5,0 - 14,0			36
S 20 / 225 E	20	Ø 4,0 - 19,0			37
		SW 5,0 - 16,0			37
S 25 / 222 E	25	Ø 4,0 - 24,0			38
		SW 5,0 - 20,0			38
ST32 „Turbo“	32	Ø 5,0 - 32,0		Turbo	39
		SW 5,0 - 26,0			39



Other profile shapes and sizes and extended options available on request.

Clamping sleeves

Designation	Pusher Ø	DFC mm	KWW mm	DCOB _{H7} mm	OAL mm
S 10 / 210 E	D 10	10	4	7	40

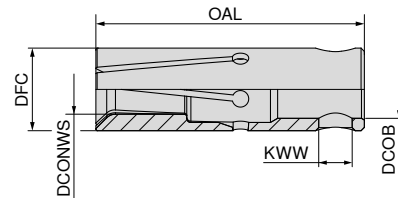

Clamping sleeve S 10 / 210 E

▲ Also suitable for all INDEX multi-spindle machines



DCONWS mm	DCONWS inch	S 10 / 210 E	
		81 043 ...	81 044 ...
3,000		03000	03000
3,001 - 3,499		xxxxx ¹⁾	
3,500		03500	
3,501 - 3,999		xxxxx ¹⁾	
4,000		04000	04000
4,001 - 4,499		xxxxx ¹⁾	
4,500		04500	
4,501 - 4,999		xxxxx ¹⁾	
5,000		05000	05000
5,001 - 5,499		xxxxx ¹⁾	
5,500		05500	
5,501 - 5,999		xxxxx ¹⁾	
6,000		06000	06000
6,001 - 6,349		xxxxx ¹⁾	
6,350	1/4	06350	
6,351 - 6,499		xxxxx ¹⁾	
6,500		06500	
6,501 - 6,999		xxxxx ¹⁾	
7,000		07000	07000
7,001 - 7,143		xxxxx ¹⁾	
7,144	9/32	07144	
7,145 - 7,499		xxxxx ¹⁾	
7,500		07500	
7,501 - 7,937		xxxxx ¹⁾	
7,938	5/16	07938	
7,939 - 7,999		xxxxx ¹⁾	
8,000		08000	08000
8,001 - 8,499		xxxxx ¹⁾	
8,500		08500	
8,501 - 8,999		xxxxx ¹⁾	
9,000		09000	
9,001 - 9,499		xxxxx ¹⁾	
9,500		09500	
9,501 - 9,999		xxxxx ¹⁾	
10,000		10000	

1) Not available ex stock, articles are non-returnable and cannot be exchanged / Delivery time 7 working days



For xxxxx please specify the required diameter when ordering (e.g. Ø 6.789 – article number 81 043 06789).

Clamping sleeves

Designation	Pusher Ø	DFC mm	KWW mm	DCOB _{H7} mm	OAL mm
S 12 / 212 E	D 12	12	4	8	40

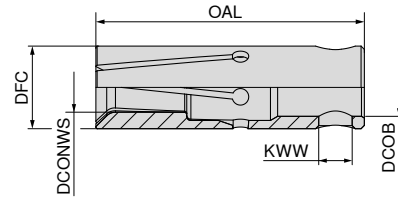

Clamping sleeve S 12 / 212 E

▲ Also suitable for all INDEX multi-spindle machines



DCONWS mm	DCONWS inch	S 12 / 212 E	
		81 045 ...	81 046 ...
3,000		03000	03000
3,001 - 3,499		xxxxx ¹⁾	
3,500		03500	
3,501 - 3,999		xxxxx ¹⁾	
4,000		04000	04000
4,001 - 4,499		xxxxx ¹⁾	
4,500		04500	
4,501 - 4,762		xxxxx ¹⁾	
4,763	3/16	04763	
4,764 - 4,999		xxxxx ¹⁾	
5,000		05000	05000
5,001 - 5,499		xxxxx ¹⁾	
5,500		05500	
5,501 - 5,999		xxxxx ¹⁾	
6,000		06000	06000
6,001 - 6,349		xxxxx ¹⁾	
6,350	1/4	06350	06350
6,351 - 6,499		xxxxx ¹⁾	
6,500		06500	
6,501 - 6,999		xxxxx ¹⁾	
7,000		07000	07000
7,001 - 7,499		xxxxx ¹⁾	
7,500		07500	
7,501 - 7,937		xxxxx ¹⁾	
7,938	5/16	07938	
7,939 - 7,999		xxxxx ¹⁾	
8,000		08000	08000
8,001 - 8,499		xxxxx ¹⁾	
8,500		08500	
8,501 - 8,999		xxxxx ¹⁾	
9,000		09000	09000
9,001 - 9,499		xxxxx ¹⁾	
9,500		09500	
9,501 - 9,524		xxxxx ¹⁾	
9,525	3/8	09525	
9,526 - 9,999		xxxxx ¹⁾	
10,000		10000	
10,001 - 10,499		xxxxx ¹⁾	
10,500		10500	
10,501 - 10,999		xxxxx ¹⁾	
11,000		11000	

1) Not available ex stock, articles are non-returnable and cannot be exchanged / Delivery time 7 working days



For xxxxx please specify the required diameter when ordering (e.g. Ø 6.789 – article number 81 045 06789).

Clamping sleeves

Designation	Pusher Ø	DFC mm	KWW mm	DCOB _{H7} mm	OAL mm
S 15 / 203 E	D 15	15	6	11	40

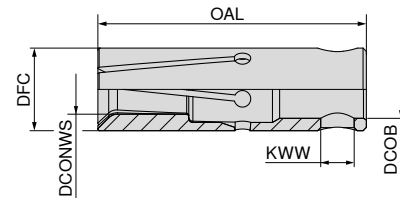

Clamping sleeve S 15 / 203 E

▲ Also suitable for all INDEX multi-spindle machines



S 15 / 203 E S 15 / 203 E

DCONWS mm	DCONWS inch	81 047 ...	81 048 ...
3,000		03000	03000
3,001 - 3,174		xxxxx ¹⁾	
3,175	1/8	03175	
3,176 - 3,499		xxxxx ¹⁾	
3,500		03500	
3,501 - 3,999		xxxxx ¹⁾	
4,000		04000	04000
4,001 - 4,499		xxxxx ¹⁾	
4,500		04500	
4,501 - 4,999		xxxxx ¹⁾	
5,000		05000	05000
5,001 - 5,499		xxxxx ¹⁾	
5,500		05500	
5,501 - 5,999		xxxxx ¹⁾	
6,000		06000	06000
6,001 - 6,349		xxxxx ¹⁾	
6,350	1/4	06350	06350
6,351 - 6,499		xxxxx ¹⁾	
6,500		06500	
6,501 - 6,999		xxxxx ¹⁾	
7,000		07000	07000
7,001 - 7,499		xxxxx ¹⁾	
7,500		07500	
7,501 - 7,937		xxxxx ¹⁾	
7,938	5/16	07938	07938
7,939 - 7,999		xxxxx ¹⁾	
8,000		08000	08000
8,001 - 8,499		xxxxx ¹⁾	
8,500		08500	
8,501 - 8,999		xxxxx ¹⁾	
9,000		09000	09000
9,001 - 9,499		xxxxx ¹⁾	
9,500		09500	
9,501 - 9,524		xxxxx ¹⁾	
9,525	3/8	09525	
9,526 - 9,999		xxxxx ¹⁾	
10,000		10000	10000
10,001 - 10,499		xxxxx ¹⁾	
10,500		10500	
10,501 - 10,999		xxxxx ¹⁾	
11,000		11000	11000
11,001 - 11,112		xxxxx ¹⁾	
11,113	7/16	11113	
11,114 - 11,499		xxxxx ¹⁾	
11,500		11500	
11,501 - 11,999		xxxxx ¹⁾	
12,000		12000	12000
12,001 - 12,499		xxxxx ¹⁾	
12,500		12500	
12,501 - 12,699		xxxxx ¹⁾	

81 047 ... 81 048 ...

DCONWS mm	DCONWS inch	81 047 ...	81 048 ...
12,700	1/2		12700
12,701 - 12,999			xxxxx ¹⁾
13,000			13000
13,001 - 13,499			xxxxx ¹⁾
13,500			13500
13,501 - 13,999			xxxxx ¹⁾
14,000			14000

1) Not available ex stock, articles are non-returnable and cannot be exchanged / Delivery time 7 working days



For xxxxx please specify the required diameter when ordering (e.g. Ø 6.789 - article number 81 047 06789).

Clamping sleeves

Designation	Pusher Ø	DFC mm	KWW mm	DCOB _{H7} mm	OAL mm
S 16	D 16	16	6	11	40

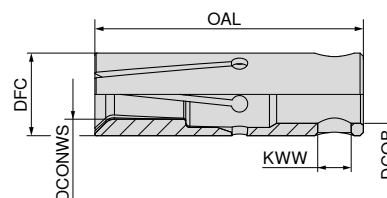

Clamping sleeve S 16

▲ Also suitable for all INDEX multi-spindle machines



DCONWS mm	DCONWS inch	81 049 ...	81 050 ...
3,000		03000	03000
3,001 - 3,499		xxxxx ¹⁾	
3,500		03500	
3,501 - 3,999		xxxxx ¹⁾	
4,000		04000	04000
4,001 - 4,499		xxxxx ¹⁾	
4,500		04500	
4,501 - 4,999		xxxxx ¹⁾	
5,000		05000	05000
5,001 - 5,499		xxxxx ¹⁾	
5,500		05500	
5,501 - 5,999		xxxxx ¹⁾	
6,000		06000	06000
6,001 - 6,349		xxxxx ¹⁾	
6,350	1/4	06350	
6,351 - 6,499		xxxxx ¹⁾	
6,500		06500	
6,501 - 6,999		xxxxx ¹⁾	
7,000		07000	07000
7,001 - 7,499		xxxxx ¹⁾	
7,500		07500	
7,501 - 7,999		xxxxx ¹⁾	
8,000		08000	08000
8,001 - 8,499		xxxxx ¹⁾	
8,500		08500	
8,501 - 8,999		xxxxx ¹⁾	
9,000		09000	09000
9,001 - 9,499		xxxxx ¹⁾	
9,500		09500	
9,501 - 9,524		xxxxx ¹⁾	
9,525	3/8	09525	
9,526 - 9,999		xxxxx ¹⁾	
10,000		10000	10000
10,001 - 10,499		xxxxx ¹⁾	
10,500		10500	
10,501 - 10,999		xxxxx ¹⁾	
11,000		11000	11000
11,001 - 11,112		xxxxx ¹⁾	
11,113	7/16	11113	
11,114 - 11,499		xxxxx ¹⁾	
11,500		11500	
11,501 - 11,999		xxxxx ¹⁾	
12,000		12000	12000
12,001 - 12,499		xxxxx ¹⁾	
12,500		12500	
12,501 - 12,699		xxxxx ¹⁾	
12,700	1/2	12700	
12,701 - 12,999		xxxxx ¹⁾	
13,000		13000	13000
13,001 - 13,499		xxxxx ¹⁾	

81 049 ... 81 050 ...

DCONWS mm	DCONWS inch	81 049 ...	81 050 ...
13,500			13500
13,501 - 13,999			xxxxx ¹⁾
14,000			14000
14,001 - 14,287			xxxxx ¹⁾
14,288	9/16		14288
14,289 - 14,499			xxxxx ¹⁾
14,500			14500
14,501 - 14,999			xxxxx ¹⁾
15,000			15000

1) Not available ex stock, articles are non-returnable and cannot be exchanged / Delivery time 7 working days



For xxxx please specify the required diameter when ordering (e.g. Ø 6.789 – article number 81 049 06789).

Clamping sleeves

Designation	Pusher Ø	DFC mm	KWW mm	DCOB _{H7} mm	OAL mm
S 18 / 218 E	D 18	18	6	11	40

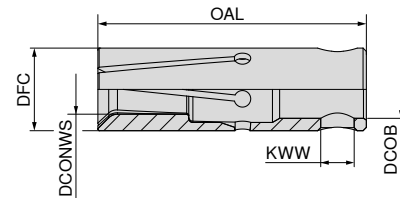

Clamping sleeve S 18 / 218 E

▲ Also suitable for all INDEX multi-spindle machines



S 18 / 218 E

S 18 / 218 E

81 051 ...

81 052 ...

DCONWS mm	DCONWS inch	81 051 ...	81 052 ...
3,000		03000	
3,001 - 3,174		xxxxx ¹⁾	
3,175	1/8	03175	
3,176 - 3,499		xxxxx ¹⁾	
3,500		03500	
3,501 - 3,999		xxxxx ¹⁾	
4,000		04000	
4,001 - 4,499		xxxxx ¹⁾	
4,500		04500	
4,501 - 4,762		xxxxx ¹⁾	
4,763	3/16	04763	
4,764 - 4,999		xxxxx ¹⁾	
5,000		05000	05000
5,001 - 5,499		xxxxx ¹⁾	
5,500		05500	
5,501 - 5,999		xxxxx ¹⁾	
6,000		06000	06000
6,001 - 6,499		xxxxx ¹⁾	
6,500		06500	
6,501 - 6,999		xxxxx ¹⁾	
7,000		07000	07000
7,001 - 7,499		xxxxx ¹⁾	
7,500		07500	
7,501 - 7,937		xxxxx ¹⁾	
7,938	5/16	07938	
7,939 - 7,999		xxxxx ¹⁾	
8,000		08000	08000
8,001 - 8,499		xxxxx ¹⁾	
8,500		08500	
8,501 - 8,999		xxxxx ¹⁾	
9,000		09000	09000
9,001 - 9,499		xxxxx ¹⁾	
9,500		09500	
9,501 - 9,524		xxxxx ¹⁾	
9,525	3/8	09525	
9,526 - 9,999		xxxxx ¹⁾	
10,000		10000	10000
10,001 - 10,499		xxxxx ¹⁾	
10,500		10500	
10,501 - 10,999		xxxxx ¹⁾	
11,000		11000	11000
11,001 - 11,112		xxxxx ¹⁾	
11,113	7/16	11113	
11,114 - 11,499		xxxxx ¹⁾	
11,500		11500	
11,501 - 11,999		xxxxx ¹⁾	
12,000		12000	12000
12,001 - 12,499		xxxxx ¹⁾	
12,500		12500	
12,501 - 12,699		xxxxx ¹⁾	
12,700	1/2	12700	12700
12,701 - 12,999		xxxxx ¹⁾	
13,000		13000	13000
13,001 - 13,499		xxxxx ¹⁾	
13,500		13500	

81 051 ... 81 052 ...

DCONWS mm	DCONWS inch	81 051 ...	81 052 ...
13,501 - 13,999		xxxxx ¹⁾	
14,000		14000	14000
14,001 - 14,287		xxxxx ¹⁾	
14,288	9/16	14288	
14,289 - 14,499		xxxxx ¹⁾	
14,500		14500	
14,501 - 14,999		xxxxx ¹⁾	
15,000		15000	
15,001 - 15,499		xxxxx ¹⁾	
15,500		15500	
15,501 - 15,874		xxxxx ¹⁾	
15,875	5/8	15875	
15,876 - 15,999		xxxxx ¹⁾	
16,000		16000	

1) Not available ex stock, articles are non-returnable and cannot be exchanged / Delivery time 7 working days



For xxxxx please specify the required diameter when ordering (e.g. Ø 6.789 – article number 81 051 06789).

Clamping sleeves

Designation	Pusher Ø	DFC mm	KWW mm	DCOB _{H7} mm	OAL mm
S 20 / 225 E	D 20	20	8	14	65

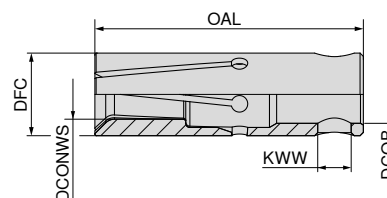

Clamping sleeve S 20 / 225 E

▲ Also suitable for all INDEX multi-spindle machines



S 20 / 225 E S 20 / 225 E

81 053 ... 81 054 ...

DCONWS mm	DCONWS inch	81 053 ...	81 054 ...
4,000		04000	
4,001 - 4,499		xxxxx ¹⁾	
4,500		04500	
4,501 - 4,762		xxxxx ¹⁾	
4,763	3/16	04763	
4,764 - 4,999		xxxxx ¹⁾	
5,000		05000	05000
5,001 - 5,499		xxxxx ¹⁾	
5,500		05500	
5,501 - 5,999		xxxxx ¹⁾	
6,000		06000	06000
6,001 - 6,349		xxxxx ¹⁾	
6,350	1/4	06350	06350
6,351 - 6,499		xxxxx ¹⁾	
6,500		06500	
6,501 - 6,999		xxxxx ¹⁾	
7,000		07000	07000
7,001 - 7,499		xxxxx ¹⁾	
7,500		07500	
7,501 - 7,937		xxxxx ¹⁾	
7,938	5/16	07938	
7,939 - 7,999		xxxxx ¹⁾	
8,000		08000	08000
8,001 - 8,499		xxxxx ¹⁾	
8,500		08500	
8,501 - 8,999		xxxxx ¹⁾	
9,000		09000	09000
9,001 - 9,499		xxxxx ¹⁾	
9,500		09500	
9,501 - 9,524		xxxxx ¹⁾	
9,525	3/8	09525	
9,526 - 9,999		xxxxx ¹⁾	
10,000		10000	10000
10,001 - 10,499		xxxxx ¹⁾	
10,500		10500	
10,501 - 10,999		xxxxx ¹⁾	
11,000		11000	11000
11,001 - 11,112		xxxxx ¹⁾	
11,113	7/16	11113	
11,114 - 11,499		xxxxx ¹⁾	
11,500		11500	
11,501 - 11,999		xxxxx ¹⁾	
12,000		12000	12000
12,001 - 12,499		xxxxx ¹⁾	
12,500		12500	
12,501 - 12,699		xxxxx ¹⁾	
12,700	1/2	12700	12700
12,701 - 12,999		xxxxx ¹⁾	
13,000		13000	13000
13,001 - 13,499		xxxxx ¹⁾	
13,500		13500	
13,501 - 13,999		xxxxx ¹⁾	
14,000		14000	14000
14,001 - 14,499		xxxxx ¹⁾	
14,500		14500	

81 053 ... 81 054 ...

DCONWS mm	DCONWS inch	81 053 ...	81 054 ...
14,501 - 14,999		xxxxx ¹⁾	
15,000		15000	15000
15,001 - 15,499		xxxxx ¹⁾	
15,500		15500	
15,501 - 15,999		xxxxx ¹⁾	
16,000		16000	16000
16,001 - 16,499		xxxxx ¹⁾	
16,500		16500	
16,501 - 16,999		xxxxx ¹⁾	
17,000		17000	
17,001 - 17,499		xxxxx ¹⁾	
17,500		17500	
17,501 - 17,999		xxxxx ¹⁾	
18,000		18000	
18,001 - 18,499		xxxxx ¹⁾	
18,500		18500	
18,501 - 18,999		xxxxx ¹⁾	
19,000		19000	

1) Not available ex stock, articles are non-returnable and cannot be exchanged / Delivery time 7 working days



For xxxxx please specify the required diameter when ordering (e.g. Ø 6.789 – article number 81 053 06789).

Clamping sleeves

Designation	Pusher Ø	DFC mm	KWW mm	DCOB _{H7} mm	OAL mm
S 25 / 222 E	D 25	25	8	20	65

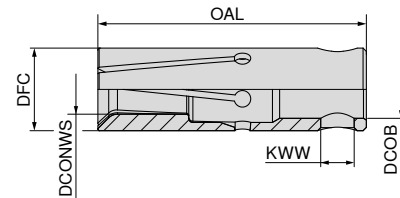

Clamping sleeve S 25 / 222 E

▲ Also suitable for all INDEX multi-spindle machines



S 25 / 222 E S 25 / 222 E

81 056 ... 81 055 ...

DCONWS mm	DCONWS inch	81 056 ...	81 055 ...
4,000			04000
4,001 - 4,499			xxxxx ¹⁾
4,500			04500
4,501 - 4,999			xxxxx ¹⁾
5,000		05000	05000
5,001 - 5,499			xxxxx ¹⁾
5,500			05500
5,501 - 5,999			xxxxx ¹⁾
6,000		06000	06000
6,001 - 6,349			xxxxx ¹⁾
6,350	1/4	06350	06350
6,351 - 6,499			xxxxx ¹⁾
6,500			06500
6,501 - 6,999			xxxxx ¹⁾
7,000		07000	07000
7,001 - 7,499			xxxxx ¹⁾
7,500			07500
7,501 - 7,999			xxxxx ¹⁾
8,000		08000	08000
8,001 - 8,499			xxxxx ¹⁾
8,500			08500
8,501 - 8,999			xxxxx ¹⁾
9,000		09000	09000
9,001 - 9,499			xxxxx ¹⁾
9,500			09500
9,501 - 9,999			xxxxx ¹⁾
10,000		10000	10000
10,001 - 10,499			xxxxx ¹⁾
10,500			10500
10,501 - 10,999			xxxxx ¹⁾
11,000		11000	11000
11,001 - 11,499			xxxxx ¹⁾
11,500			11500
11,501 - 11,999			xxxxx ¹⁾
12,000		12000	12000
12,001 - 12,499			xxxxx ¹⁾
12,500			12500
12,501 - 12,699			xxxxx ¹⁾
12,700	1/2		12700
12,701 - 12,999			xxxxx ¹⁾
13,000		13000	13000
13,001 - 13,499			xxxxx ¹⁾
13,500			13500
13,501 - 13,999			xxxxx ¹⁾
14,000		14000	14000
14,001 - 14,499			xxxxx ¹⁾
14,500			14500
14,501 - 14,999			xxxxx ¹⁾
15,000		15000	15000
15,001 - 15,499			xxxxx ¹⁾
15,500			15500
15,501 - 15,999			xxxxx ¹⁾
16,000		16000	16000
16,001 - 16,499			xxxxx ¹⁾
16,500			16500

DCONWS mm	DCONWS inch	81 056 ...	81 055 ...
16,501 - 16,999			xxxxx ¹⁾
17,000		17000	17000
17,001 - 17,499			xxxxx ¹⁾
17,500			17500
17,501 - 17,999			xxxxx ¹⁾
18,000		18000	18000
18,001 - 18,499			xxxxx ¹⁾
18,500			18500
18,501 - 18,999			xxxxx ¹⁾
19,000		19000	19000
19,001 - 19,049			xxxxx ¹⁾
19,050	3/4		19050
19,051 - 19,499			xxxxx ¹⁾
19,500			19500
19,501 - 19,999			xxxxx ¹⁾
20,000		20000	20000
20,001 - 20,499			xxxxx ¹⁾
20,500			20500
20,501 - 20,999			xxxxx ¹⁾
21,000			21000
21,001 - 21,499			xxxxx ¹⁾
21,500			21500
21,501 - 21,999			xxxxx ¹⁾
22,000			22000
22,001 - 22,499			xxxxx ¹⁾
22,500			22500
22,501 - 22,999			xxxxx ¹⁾
23,000			23000
23,001 - 23,499			xxxxx ¹⁾
23,500			23500
23,501 - 23,999			xxxxx ¹⁾
24,000			24000

1) Not available ex stock, articles are non-returnable and cannot be exchanged / Delivery time 7 working days



For xxxx please specify the required diameter when ordering (e.g. Ø 6.789 – article number 81 056 06789).

Clamping sleeves

Designation	Pusher Ø	DFC mm	DCOB _{H7} mm	OAL mm
ST 32	D 32	32	20	90

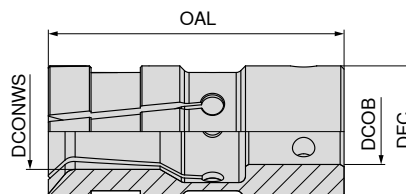

Clamping sleeve ST 32 (turbo version)

▲ Also suitable for all INDEX multi-spindle machines



ST 32 ST 32

DCONWS		81 057 ...	81 058 ...
mm	inch		
5,000		05000	05000
5,001 - 5,499		xxxxx ¹⁾	
5,500		05500	
5,501 - 5,999		xxxxx ¹⁾	
6,000		06000	06000
6,001 - 6,349		xxxxx ¹⁾	
6,350	1/4	06350	
6,351 - 6,499		xxxxx ¹⁾	
6,500		06500	
6,501 - 6,999		xxxxx ¹⁾	
7,000		07000	07000
7,001 - 7,499		xxxxx ¹⁾	
7,500		07500	
7,501 - 7,999		xxxxx ¹⁾	
8,000		08000	08000
8,001 - 8,499		xxxxx ¹⁾	
8,500		08500	
8,501 - 8,999		xxxxx ¹⁾	
9,000		09000	09000
9,001 - 9,499		xxxxx ¹⁾	
9,500		09500	
9,501 - 9,524		xxxxx ¹⁾	
9,525	3/8	09525	
9,526 - 9,999		xxxxx ¹⁾	
10,000		10000	10000
10,001 - 10,499		xxxxx ¹⁾	
10,500		10500	
10,501 - 10,999		xxxxx ¹⁾	
11,000		11000	11000
11,001 - 11,499		xxxxx ¹⁾	
11,500		11500	
11,501 - 11,999		xxxxx ¹⁾	
12,000		12000	12000
12,001 - 12,499		xxxxx ¹⁾	
12,500		12500	
12,501 - 12,699		xxxxx ¹⁾	
12,700	1/2	12700	
12,701 - 12,999		xxxxx ¹⁾	
13,000		13000	13000
13,001 - 13,499		xxxxx ¹⁾	
13,500		13500	
13,501 - 13,999		xxxxx ¹⁾	
14,000		14000	14000
14,001 - 14,499		xxxxx ¹⁾	
14,500		14500	
14,501 - 14,999		xxxxx ¹⁾	
15,000		15000	15000
15,001 - 15,499		xxxxx ¹⁾	
15,500		15500	
15,501 - 15,874		xxxxx ¹⁾	
15,875	5/8	15875	
15,876 - 15,999		xxxxx ¹⁾	
16,000		16000	16000
16,001 - 16,499		xxxxx ¹⁾	
16,500		16500	
16,501 - 16,999		xxxxx ¹⁾	
17,000		17000	17000
17,001 - 17,462		xxxxx ¹⁾	
17,463	11/16	17463	
17,464 - 17,499		xxxxx ¹⁾	
17,500		17500	
17,501 - 17,999		xxxxx ¹⁾	
18,000		18000	18000
18,001 - 18,499		xxxxx ¹⁾	

81 057 ... 81 058 ...

DCONWS mm	DCONWS inch	81 057 ...	81 058 ...
18,500		18500	
18,501 - 18,999		xxxxx ¹⁾	
19,000		19000	19000
19,001 - 19,049		xxxxx ¹⁾	
19,050	3/4	19050	
19,051 - 19,499		xxxxx ¹⁾	
19,500		19500	
19,501 - 19,999		xxxxx ¹⁾	
20,000		20000	20000
20,001 - 20,499		xxxxx ¹⁾	
20,500		20500	
20,501 - 20,999		xxxxx ¹⁾	
21,000		21000	21000
21,001 - 21,499		xxxxx ¹⁾	
21,500		21500	
21,501 - 21,999		xxxxx ¹⁾	
22,000		22000	22000
22,001 - 22,224		xxxxx ¹⁾	
22,225	7/8	22225	
22,226 - 22,499		xxxxx ¹⁾	
22,500		22500	
22,501 - 22,999		xxxxx ¹⁾	
23,000		23000	23000
23,001 - 23,499		xxxxx ¹⁾	
23,500		23500	
23,501 - 23,999		xxxxx ¹⁾	
24,000		24000	24000
24,001 - 24,499		xxxxx ¹⁾	
24,500		24500	
24,501 - 24,999		xxxxx ¹⁾	
25,000		25000	25000
25,001 - 25,399		xxxxx ¹⁾	
25,400	1/1	25400	
25,401 - 25,499		xxxxx ¹⁾	
25,500		25500	
25,501 - 25,999		xxxxx ¹⁾	
26,000		26000	26000
26,001 - 26,499		xxxxx ¹⁾	
26,500		26500	
26,501 - 26,999		xxxxx ¹⁾	
27,000		27000	
27,001 - 27,499		xxxxx ¹⁾	
27,500		27500	
27,501 - 27,999		xxxxx ¹⁾	
28,000		28000	
28,001 - 28,499		xxxxx ¹⁾	
28,500		28500	
28,501 - 28,574		xxxxx ¹⁾	
28,575	1 1/8	28575	
28,576 - 28,999		xxxxx ¹⁾	
29,000		29000	
29,001 - 29,499		xxxxx ¹⁾	
29,500		29500	
29,501 - 29,999		xxxxx ¹⁾	
30,000		30000	

1) Not available ex stock, articles are non-returnable and cannot be exchanged / Delivery time 7 working days



For xxxxx please specify the required diameter when ordering (e.g. Ø 6.789 – article number 81 057 06789).

Reduction sleeve

- ▲ for tools with cylindrical shank
- ▲ Radial run-out accuracy < 0.01 mm

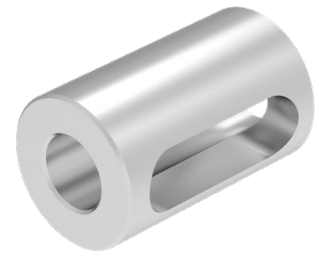
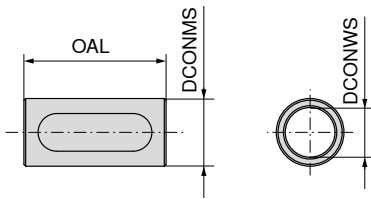

NEW

81 427 ...

DCONMS _{g6} mm	DCONMS _{g6} inch	DCONWS _{H7} mm	OAL mm	
15.875	5/8	12	30	15912
16.000		12	30	16012
19.050	3/4	8	40	19108
19.050	3/4	10	40	19110
19.050	3/4	12	40	19112
19.050	3/4	14	40	19114
19.050	3/4	16	40	19116
20.000		10	40	20010
20.000		12	40	20012
20.000		16	40	20016
22.000		12	40	22012
22.000		16	40	22016
25.000		12	40	25012
25.000		16	40	25016
25.000		20	40	25020
25.400	1	12	40	25412
25.400	1	16	40	25416
25.400	1	20	40	25420
33.000		20	40	33020
33.000		22	40	33022
33.000		25	40	33025

Technical Information

Runout accuracy

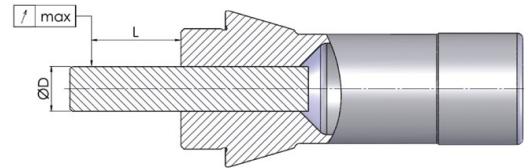
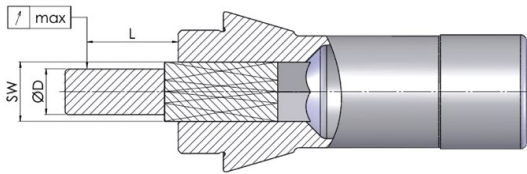

Run-out tolerances of collets with profiles					
Profile size		L mm	Standard norm	Norm	
from	up to			Standard	HP*
0,5	0,9	3	0,12	< 0,02	< 0,01
1	1,5	6	0,12	< 0,02	< 0,01
1,6	3	10	0,12	< 0,02	< 0,01
3,1	6	16	0,12	< 0,02	< 0,01
6,1	10	25	0,15	< 0,02	< 0,01
10,1	18	40	0,2	< 0,02	< 0,01
18,1	24	50	0,2	< 0,02	< 0,01
24,1	30	60	0,2	< 0,02	< 0,01
30,0		80	0,2	< 0,02	< 0,01

* Lower run-out tolerances with the HP (High Precision) option on request.

Run-out tolerances of round collets				
hole		L mm	Norm	
from	up to		Standard	HP*
0,5	0,9	3	< 0,01	< 0,008
1	1,5	6	< 0,01	< 0,008
1,6	3	10	< 0,015	< 0,008
3,1	6	16	< 0,015	< 0,008
6,1	10	25	< 0,015	< 0,008
10,1	18	40	< 0,02	< 0,01
18,1	24	50	< 0,02	< 0,01
24,1	30	60	< 0,02	< 0,01
30,0		80	< 0,03	< 0,015

* Lower run-out tolerances with the HP (High Precision) option on request.

Our profile collets and guide bushes are micro-eroded with up to 7 slots. This ensures maximum quality with minimal run-out tolerances.

Your wish is our command. That is why the WNT tolerances are far tighter than standard tolerances. The service lives of both the machine components and the tools are extended.

Special shapes

Due to the variety of different applications, it may be necessary to individually adapt some products to the processes.

To do this, we offer you maximum quality according to your specifications.

Get in touch using one of the options below and let us create your clamping device:

Technical Advice

Interested in our clamping devices?

Our Technical Sales Engineers would be happy to advise you. You can of course also talk to our in-house Technical Sales Engineers by calling our freefone number.

Enquiry Form

Should you wish to send us a request for specially adjusted solutions, you will find a detailed form in the download area on our homepage. Please fill it out carefully and send it via email or print it out and send via fax.

→ cuttingtools.ceratizit.com/gb/en/download.html

Please email the completed form to techsupport.uk@ceratizit.com.

 Other profile shapes and sizes and extended options available on request.





Solid drilling and bore machining

HSS drilling

Solid carbide drilling

Reamers

1

Threading

HSS taps

Circular and Thread Milling

Thread turning

2

Turning

Turning Tools

Multi-function tool – EcoCut

Grooving Tools

Miniature turning tools

3

Milling

Solid Carbide milling cutters

4

Workholding

Collets and reduction sleeves

5

Material examples and
article no. index

6

Extended Material Examples for the Cutting Data Tables

	Material sub-group	Index	Composition / Structure / Heat treatment	Tensile strength N/mm ² / HB / HRC
P	Unalloyed steel	P.1.1	< 0,15 % C Annealed	420 N/mm ² / 125 HB
		P.1.2	< 0,45 % C Annealed	640 N/mm ² / 190 HB
		P.1.3	< 0,45 % C Tempered	840 N/mm ² / 250 HB
		P.1.4	< 0,75 % C Annealed	910 N/mm ² / 270 HB
		P.1.5	< 0,75 % C Tempered	1010 N/mm ² / 300 HB
	Low-alloy steel	P.2.1	Annealed	610 N/mm ² / 180 HB
		P.2.2	Tempered	930 N/mm ² / 275 HB
		P.2.3	Tempered	1010 N/mm ² / 300 HB
		P.2.4	Tempered	1200 N/mm ² / 375 HB
	High-alloy steel and high-alloy tool steel	P.3.1	Annealed	680 N/mm ² / 200 HB
		P.3.2	Hardened and tempered	1100 N/mm ² / 300 HB
		P.3.3	Hardened and tempered	1300 N/mm ² / 400 HB
	Stainless steel	P.4.1	Ferritic / martensitic Annealed	680 N/mm ² / 200 HB
P.4.2		Martensitic Tempered	1010 N/mm ² / 300 HB	
M	Stainless steel	M.1.1	Austenitic / austenitic-ferritic Quenched	610 N/mm ² / 180 HB
		M.2.1	Austenitic Tempered	300 HB
		M.3.1	Austenitic / ferritic (Duplex)	780 N/mm ² / 230 HB
K	Grey cast iron	K.1.1	Pearlitic / ferritic	350 N/mm ² / 180 HB
		K.1.2	Pearlitic (martensitic)	500 N/mm ² / 260 HB
	Spherulitic graphite cast iron	K.2.1	Ferritic	540 N/mm ² / 160 HB
		K.2.2	Pearlitic	845 N/mm ² / 250 HB
	Malleable iron	K.3.1	Ferritic	440 N/mm ² / 130 HB
		K.3.2	Pearlitic	780 N/mm ² / 230 HB
N	Aluminium wrought alloy	N.1.1	Non-hardenable	60 HB
		N.1.2	Hardenable Age-hardened	340 N/mm ² / 100 HB
	Cast aluminium alloy	N.2.1	≤ 12 % Si, non-hardenable	250 N/mm ² / 75 HB
		N.2.2	≤ 12 % Si, hardenable Age-hardened	300 N/mm ² / 90 HB
		N.2.3	> 12 % Si, non-hardenable	440 N/mm ² / 130 HB
	Copper and copper alloys (bronze/brass)	N.3.1	Free-machining alloys, PB > 1 %	375 N/mm ² / 110 HB
		N.3.2	CuZn, CuSnZn	300 N/mm ² / 90 HB
		N.3.3	CuSn, lead-free copper and electrolytic copper	340 N/mm ² / 100 HB
	Magnesium alloys	N.4.1	Magnesium and magnesium alloys	70 HB
S	Heat-resistant alloys	S.1.1	Fe - basis Annealed	680 N/mm ² / 200 HB
		S.1.2	Fe - basis Age-hardened	950 N/mm ² / 280 HB
		S.2.1	Ni or Co basis Annealed	840 N/mm ² / 250 HB
		S.2.2	Ni or Co basis Age-hardened	1180 N/mm ² / 350 HB
		S.2.3	Ni or Co basis Cast	1080 N/mm ² / 320 HB
	Titanium alloys	S.3.1	Pure titanium	400 N/mm ²
		S.3.2	Alpha + beta alloys Age-hardened	1050 N/mm ² / 320 HB
S.3.3	Beta alloys	1400 N/mm ² / 410 HB		
H	Hardened steel	H.1.1	Hardened and tempered	46-55 HRC
		H.1.2	Hardened and tempered	56-60 HRC
		H.1.3	Hardened and tempered	61-65 HRC
		H.1.4	Hardened and tempered	66-70 HRC
	Chilled iron	H.2.1	Cast	400 HB
	Hardened cast iron	H.3.1	Hardened and tempered	55 HRC
O	Non-metal materials	O.1.1	Plastics, duroplastic	≤ 150 N/mm ²
		O.1.2	Plastics, thermoplastic	≤ 100 N/mm ²
		O.2.1	Aramid fibre-reinforced	≤ 1000 N/mm ²
		O.2.2	Glass/carbon-fibre reinforced	≤ 1000 N/mm ²
		O.3.1	Graphite	

* Tensile strength

On the following 16 pages you will find an extension of the material examples to our usual indexes with additional international standards.

Overview of standards:

DIN

Deutsche Industrie Norm (German Standard)

AFNOR

Association Francaise de Normalisation (French Standard)

UNI

Unificazione Italiana (Italian Standard)

CSN

Czechoslovakian Standard

BS

British Standards

SIS

Standardiseringen i Sverige (Swedish Standard)

UNE

Spanish Standard

JIS

Japanese Industrial Standard

GOST

Soviet Standard

UNS

Unified Numbering System

USA

Under USA several American standards are summarized

	Index	Material number	DIN	AFNOR	UNI	ČSN	BS	SIS	UNE	JIS	GOST	UNS	USA	
P	P.1.1	1.5423	16 Mo 5		16 Mo 5		1503-245-420					G 45200	4520	
		1.0037	St 37-2	E 24-2		11 343				STKM 12 C				
		1.0044	St 44-2	E 28-2	Fe 430 B FN	11 443	4360-43 B	1412			SM 41 B			A 570 Gr. 40
		1.0116	St 37-3	E 24-3; E 24-4	Fe 360 D FF	11 378	4360-40 C	1312; 1313				St 3 kp; ps; sp		A 573 Gr. 58
		1.0144	St 44-3	E 28-3; E 28-4	Fe 430 D FF		4360-43 C	1412; 1414			SM 41 C	St 4 kp; ps; sp		A 573 Gr. 70
		1.0301	C 10	AF 34 C 10; XC 10	C 10	12 010	045 M 10				S 10 C	10	G 10100	1010
		1.0401	C 15	AF 3 7 C 12; XC 18	C 15; C 16	12 020	080 M 15	1350	F-111				G 10170	1015
		1.0402	C 22	AF 42 C 20	C 20; C 21	12 024	050 A 20	1450	F-112			20	G 10200	1020
		1.0406	C 25	AF 50 C 30	C 25	12 030	070 M 26							1025
		1.0570	St 52-3	E 36-3; E 36-4	Fe 510 B; C; D	11 523	4360-50 B	2132			SM 50 YA	17 GS		
		1.1121	Ck 10	XC 10	C 10	12 010	045 M 10	1265	F-1510		S 10 C; S 9 CK	08; 10	G 10100	1010
		1.1133	20 Mn 5	20 M 5	G 22 Mn 3		120 M 19				SMnC 420		G 10220	1022; 1518
		1.1141	Ck 15	XC 15; XC 18	C 15; C 16	12 020	080 M 15	1370	F-1511		S 15 C; S 15 CK	15	G 10170	1015
		1.1151	Ck 22	XC 25; XC 18	C 20		050 A 20				S 20 C; S 20 CK	20		1023
		1.1158	Ck 25	XC 25	C 25	12 030	070 M 26				S 25 C	25	G 10250	1025
	P.1.2	1.0050	St 50-2	A 50-2	Fe 490	11 500	4360-50 B	2172			SS 50	BSt 5 ps; sp		A 570 Gr. 50
		1.0060	St 60-2	A 60-2	Fe 590; Fe 60-2	11 600	4360-SSE; SSC				SM 58	St 6 ps; sp		
		1.0406	C 25	AF 50 C 30	C 25	12 030	070 M 26							1025
		1.0420	GS-38											
		1.0446	GS-45											
		1.0481	17 Mn 4			11 748								
		1.0501	C 35	AF 55 C 35	C 35	12 040	060 A 35	1550	F-113			35	G 10350	1035
		1.0503	C 45	AF 65 C 45	C 45	12 050	080 M 46	1650	F-114			45	G 10430	1045
		1.0511	C 40	AF 60 C 40	C 40	12 041								1040
		1.0528	C 30			12 031								
		1.0540	C 50											
		1.0552	GS-52											
		1.0558	GS-60											
		1.0619	GS-C 25											
		1.0711	9 S 20		CF 9 S 22		220 M 07	220 M 07			SUM 21	SUM 21	G 12120	1212
1.0715		9 SMn 28	S 250	CF 9 SMn 28	11 109	230 M 07	1912	F-211 / F-2111		SUM 22		G 12130	1213	
1.0718		9 SMnPb 28	S 250 Pb	CF 9 SMnPb 28			1914	F-212 / F-2112		SUM 22 L		G 12134	12 L 13	
1.0721		10 S 20	10 F 1	CF 10 S 20	10 110	210 M 15		F-2121					1108	
1.0722		10 SPb 20	10 PbF 2	CF 10 SPb 20				F-2122					11 L 08	
1.0723		15 S 20				210 A 15	1922			SUM 32				
1.0736		9 SMn 36	S 300	CF 9 SMn 36		240 M 07		F-2113				G 12150	1215	
1.0737		9 SMnPb 36	S 300 Pb	CF 9 SMnPb 36			1926	F-2114				G 12144	12 L 14	
1.1118		GS-24 Mn 6			42 2714									
1.1120		GS-20 Mn 5												
1.1131		GS-16 Mn 5												
1.1138	GS-21 Mn 5													
1.1142	GS-Ck 16													
1.1151	Ck 22	XC 25; XC 18	C 20		050 A 20				S 20 C; S 20 CK	20		1023		
1.1155	GS-Ck 25													
1.1158	Ck 25	XC 25	C 25	12 030	070 M 26				S 25 C	25	G 10250	1025		
1.1178	Ck 30													
1.1181	Ck 35	XC 38 H1; XC 32	C 35		080 M 36	1572			S 35 C	35	G 10340	1035		
1.1186	Ck 40	XC 42 H1	C 40		080 M 40				S 40 C	40		1040		
1.1191	Ck 45	XC 42	C 45		080 M 46	1672			S 45 C	45	G 10420	1045		
1.1206	Ck 50	XC 48 H1			080 M 50					50		1050		
1.1730	C 45 W	Y3 42												

	Index	Material number	DIN	AFNOR	UNI	ČSN	BS	SIS	UNE	JIS	GOST	UNS	USA	
P	P.1.3	1.0501	C 35	AF 55 C 35	C 35	12 040	060 A 35	1550	F-113		35	G 10350	1035	
		1.0503	C 45	AF 65 C 45	C 45	12 050	080 M 46	1650	F-114		45	G 10430	1045	
		1.0511	C 40	AF 60 C 40	C 40	12 041								1040
		1.0528	C 30			12 031								
		1.0540	C 50											
		1.0726	35 S 20	35 MF 4			11 140	212 M 36	1957	F-210.G			G 11400	1140
		1.0727	45 S 20	45 MF 4				212 M 44	1973				G 11460	1146
		1.0728	60 S 20	60 MF 4										
		1.1178	Ck 30											
		1.1181	Ck 35	XC 38 H1:XC 32	C 35			080 M 36	1572		S 35 C	35	G 10340	1035
		1.1186	Ck 40	XC 42 H1	C 40			080 M 40			S 40 C	40		1040
		1.1191	Ck 45	XC 42	C 45			080 M 46	1672		S 45 C	45	G 10420	1045
		1.1206	Ck 50	XC 48 H1				080 M 50				50		1050
		P.1.4	1.0535	C 55	AF 70 C55	C 55	12 060	070 M 55	1655				55	
	1.0601		C 60	CC 55	C 60		080 A 62					60	G 10600	1060
	1.0757		46 SPb 20											
	1.1203		Ck 55	XC 55	C50		070 M 55				S 55 C	55		1055
	1.1221		Ck 60	XC 60	C60		080 A 62	1665; 1678			S 58 C	60; 60G	G 10640	1060
	1.1248		Ck 75	XC 75	C 75	12 081	060 A 78	1774; 1778				75	G 10780	1078; 1080
	1.1274		Ck 101	XC 100			060 A 96	1870			SUP 4		G 10950	1095
	1.1520		C 70 W1											
	1.1525		C 80 W1	Y1 90; Y1 80	C 80 KU							U8A	T 72301	W 108
	1.1545+G502		C 105 W1	Y1 105	C 100 KU				1880			U10A	T 72301	W 110
	1.1620		C 70 W2											
	1.1625		C 80 W2		C 80 KU			BW 1 B			SKC 3; SK 5; SK 6	U8; 80	T 72301	W 1
	1.1645		C 105 W2	Y2 105	C 100 KU						SK 3	U10	T 72301	
	1.1663		C 125 W	Y2 120	C 120 KU						SK 2	U13	T 72301	W 112
	1.1673		C 135 W	Y2 140	C 140 KU						SK 1			
	1.1740		C 60 W	Y3 55							SK 7			
	1.1750		C 75 W					BW 1A				75		W 1
	1.1820		C 55 W											
	1.1830		C 85 W	Y3 90							SK 5			
	P.1.5	1.0535	C 55	AF 70 C55	C 55	12 060	070 M 55	1655				55		1055
1.0601		C 60	CC 55	C 60		080 A 62					60	G 10600	1060	
1.1203		Ck 55	XC 55	C50		070 M 55				S 55 C	55		1055	
1.1221		Ck 60	XC 60	C60		080 A 62	1665; 1678			S 58 C	60; 60G	G 10640	1060	
1.1231		Ck 67	XC 68	C 70	12 071	060 A 67	1770				70	G 10700	1070	
1.1274		Ck 101	XC 100			060 A 96	1870			SUP 4		G 10950	1095	
1.1520		C 70 W1												
P.2.1	1.2162	21 MnCr 5	20 NC 5			19 487				SCR 420 H				
	1.2210	115 CrV 3	100 C 3	107 CrV 3 KU	19 421							T 61202	L 2	
	1.2323	GS-48 CrMoV 6 7												
	1.2341	X 6 CrMo 4												
	1.2369	81 CrMov 42 16												
	1.2516	120 WV 4	110 WC 20	110 W 4 KU	19 711	BF 1								
	1.2542	45 WCrV 7		45 WCrV 8 KU	19 732	BS 1	2710					T 41901	S 1	
	1.2550	60 WCrV 7	55 WC 20	55 WCrV 8 KU	19 735									
	1.2711	54 NiCrMoV 6	55 NCDV 6		19 662									
	1.2735	15 NiCr 14	10 NC 12		16 240					SNC 22		T 51606		
	1.2762	75 CrMoNiW 6 7												
	1.2842	90 MnCrV 8	90 MV 8	90 MnVCr 8 KU	19 314	B0 2						T 31502	0 2	

	Index	Material number	DIN	AFNOR	UNI	ČSN	BS	SIS	UNE	JIS	GOST	UNS	USA		
P	P.2.1	1.5015	GS-8 Mn 7												
		1.5122	37 MnSi 4			13 240									
		1.5415	15 Mo 3	15 D 3	16 Mo 3			1501-240	2912					A 204 Gr. A	
		1.5419	GS-22 Mo 4												
		1.5621	GS-10 Ni 6												
		1.5622	14 Ni 6	16 N 6	14 Ni 6									A 350-LF 5	
		1.5633	GS-24 Ni 8												
		1.5638	GS-10 Ni 14												
		1.5732	14 NiCr 10	14 NC 11	16 NiCr 11					F-1540	SNC 415 (H)			3415	
		1.5752	14 NiCr 14	12 NC 15			16 240	655 M 13		F-1540	SNC 815 (H)		G 33106	3310; 9314	
		1.5919	15 CrNi 6	16 NC 6	16 CrNi 4	16 220	S 107								
		1.5920	18 CrNi 8	20 NC 6			13 231								
		1.6221	GS-13 MnNi 6 4												
		1.6523	21 NiCrMo 2	20 NCD 2	20 NiCrMo 2			805 M 20	2506	F-1522	SNCM 220 (H)		G 86170	8620	
		1.6587	17 CrNiMo 6	18 NCD 6	18 NiCrMo 7			820 A 16							
		1.6750	GS-20 NiCrMo 3 7												
		1.7003	38 Cr 2	38 C 2	38 Cr 2										
		1.7006	46 Cr 2	42 C 2	45 Cr 2										5045
		1.7012	13 Cr 2												
		1.7015	15 Cr 3	12 C 3			14 120	523 M 15			SCr 415 (H)	15Ch	G 50150	5015	
		1.7020	32 Cr 2												
		1.7030	28 Cr 4					530 A 30				30Ch		5130	
		1.7033	34 Cr 4	32 C 4	34 Cr 4 (KB)			530 A 32			SCr 430 (H)	35Ch	G 51320	5132	
		1.7131	16 MnCr 5	16 MC 5	16 MnCr 5	14 220	527 M 17	2511		F-1516/ F-1517	SCR 415	18ChG	G 51170	5115	
		1.7139	16 MnCrS 5							F-150D					
		1.7147	20 MnCr 5	20 MC 5	20 MnCr 5	14 221					SMnC 420 (H)	18ChG	G 51200	5120	
		1.7149	20 MnCrS 5							F-1551					
		1.7218	25 CrMo 4	25 CD 4 S	25 CrMo 4 (KB)	15 130	1717 CDS 110	2225			SCM 420; SCM 430	30ChM	G 41300	4130	
		1.7219	GS-26 CrMo 4												
		1.7220	34 CrMo 4	35 CD 4	35 CrMo 4	15 131	708 A 37	2234			SCM 432; SCCrM 3	AS38ChGM	G 41350	4135; 4137	
		1.7262	15 CrMo 5	12 CD 4	12 CrMo 4						SCM 415 (H)				
		1.7264	20 CrMo 5	18 CD 4							SCM 421				
		1.7271	23 CrMoB 3 3												
		1.7311	20 CrMo 2							F-1523					
		1.7321	20 MoCr 4	20 CD 4											
		1.7335	13 CrMo 4 4	15 CD 3.5	14 CrMo 4 5			1501-620 Gr. 27	2216			12ChM; 15ChM		A 182-F11; F12	
		1.7337	16 CrMo 4 4	15 CD 4.5	14 CrMo 4 5			1501-620 Gr. 27	2216			15ChM		A 387 Gr. 12 Cl. 2	
		1.7357	GS-17 CrMo 5 5												
		1.7363	GS-12 CrMo 19 5												
		1.7377	GS-17 CrMo 9 10												
		1.7379	GS-18 CrMo 9 10												
		1.7380	10 CrMo 9 10	10 CD 9.10	12 CrMo 9 10			1501-622 Gr. 31; 45 1503-660- 440	2218					J 21890	A 182-F22
		1.7715	14 MoV 6 3												
		1.7725	GS-30 CrMoV 6 4												
		1.8504	34 CrAl 6				14 340								
1.8506	34 CrAlS 5											K 23745			
1.8521	15 CrMoV 5 9														
1.0904	55 Si 7	55 S 7	55 Si 8			250 A 53	2085; 2090				55S2		9255		
P.2.2	1.2067	100 Cr 6	Y 100 C 6				BL 3					T 61203	L 3		
	1.2101	62 SiMnCr 4													
	1.2103	58 SiCr 8				19 452									

Index	Material number	DIN	AFNOR	UNI	ČSN	BS	SIS	UNE	JIS	GOST	UNS	USA
	1.2108	90 CrSi 5P										
	1.2162	21 MnCr 5	20 NC 5		19 487				SCR 420 H			
	1.2210	115 CrV 3	100 C 3	107 CrV 3 KU	19 421						T 61202	L 2
	1.2311	40 CrMnMo 7			19 520							
	1.2312	40 CrMnMoS 8 6	40 CMD 8 + S									
	1.2323	GS-48 CrMoV 6 7										
	1.2330	35 CrMo 4	34 CD 4	35 CrMo 4		708 A 37	2234			35 HM	T 51620	4135
	1.2332	47 CrMo 4	42 CD 4	40 CrMo 4		708 M 40	2244					4142
	1.2419	105 WCr 6	105 WC 13	107 WCr 5 KU					SKS 31	ChWG		
	1.2510	100 MnCrW 4	90 MWCV 5	95 MnWCr 5 KU	19 314	B0 1	2140	F-5220	SKS 3		T 31501	O 1
	1.2542	45 WCrV 7		45 WCrV 8 KU	19 732	BS 1	2710				T 41901	S 1
	1.2550	60 WCrV 7	55 WC 20	55 WCrV 8 KU	19 735							
	1.2711	54 NiCrMoV 6	55 NCDV 6		19 662							
	1.2713	55 NiCrMoV 6	55 NCDV 7		19 662			F-520.S	SKT 4	5ChNM	T 61206	L 6
	1.2721	50 NiCr 13										
	1.2738	40 CrMnNiMo 8						F-5303				
	1.2826	60 MnSiCr 4										
	1.2833	100 V 1	Y1 105 V	102 V 2 KU	19 356	BW 2			SKS 43		T 72302	W 210
	1.2842	90 MnCrV 8	90 MV 8	90 MnVCr 8 KU	19 314	B0 2					T 31502	O 2
	1.3505	100 Cr 6	100 C 6	100 Cr 6	14 100	534 A 99	2258	F-131 / F-1310	SUJ 2	SchCh 15	G 52986	52100
	1.3520	100 CrMn 6			14 209							
	1.3561	44 Cr 2										
	1.3563	43 CrMo 4										
	1.5120	38 MnSi 4										
	1.5121	46 MnSi 4										
	1.5122	37 MnSi 5			13 240							
	1.5131	50 MnSi 4										
	1.5141	53 MnSi 4										
	1.5223	42 MnV 7			13 242							
	1.5710	36 NiCr 6	35 NC 6		16 240	640 A 35			SNC 236			3135
	1.5736	36 NiCr 10	30 NC 11	35 NiCr 9					SNC 631 (H)			3435
	1.5755	31 NiCr 14	18 NC 13			653 M 31			SNC 836			
	1.6511	36 CrNiMo 4	40 NCD 3	38 NiCrMo 4 (KB)	16 341	816 M 40				40 ChN2MA	G 98400	9840
	1.6513	28 NiCrMo 4										
	1.6546	40 NiCrMo 2 2	40 NCD 2	40 NiCrMo 2 (KB)		311-Type 7			SNCM 240	38ChGNM	G 87400	8740
	1.6565	40 NiCrMo 6				311-Type 6			SNCM 439	40Ch2N2MA		4340
	1.6570	GS-30 NiCrMo 8 5										
	1.6580	30 CrNiMo 8	30 CND 8	30 NiCrMo 8		823 M 30		F-1272	SNCM 431			
	1.6582	34 CrNiMo 6	35 NCD 6	35 NiCrMo 6 (KW)	16 342	817 M 40	2541	F-128 / F-1270	SNCM 447	38Ch2N2MA		4340
	1.6746	32 NiCrMo 14 5	35 NCD 14			830 M 31						
	1.6781	GS-18 NiCrMo 12 6										
	1.7003	38 Cr 2	38 C 2	38 Cr 2								
	1.7006	46 Cr 2	42 C 2	45 Cr 2								5045
	1.7030	28 Cr 4				530 A 30				30Ch		5130
	1.7033	34 Cr 4	32 C 4	34 Cr 4 (KB)		530 A 32			ScR 430 (H)	35Ch	G 51320	5132
	1.7034	37 Cr 4	38 C 4	38 Cr 4	14 140	530 A 36			ScR 435 H	40Ch		5135
	1.7035	41 Cr 4	42 C 4	41 Cr 4		530 M 40			ScR 440 (H)	40Ch	G 51400	5140
	1.7045	42 Cr 4	42 C 4 TS	41 Cr 4		530 A 40	2245		ScR 440	40Ch		5140
	1.7103	67 SiCr 5										
	1.7131	16 MnCr 5	16 MC 5	16 MnCr 5	14 220	527 M 17	2511	F-1516 / F-1517	SCR 415	18ChG	G 51170	5115
	1.7139	16 MnCrS 5						F-150D				

	Index	Material number	DIN	AFNOR	UNI	ČSN	BS	SIS	UNE	JIS	GOST	UNS	USA		
P	P.2.2	1.7147	20 MnCr 5	20 MC 5	20 MnCr 5	14 221				SMnC 420 (H)	18ChG	G 51200	5120		
		1.7149	20 MnCrS 5						F-1551						
		1.7176	55 Cr 3	55 C 3	55 Cr 3			527 A 60	2253	F-1431	SUP 9 (A)	50ChGA	G 51550	5155	
		1.7218	25 CrMo 4	25 CD 4 S	25 CrMo 4 (KB)	15 130	1717 CDS 110		2225		SCM 420; SCM 430	30ChM	G 41300	4130	
		1.7220	34 CrMo 4	35 CD 4	35 CrMo 4	15 131	708 A 37		2234		SCM 432; SCCrM 3	AS38ChGM	G 41350	4135; 4137	
		1.7223	41 CrMo 4	42 CD 4 TS	41 CrMo 4		708 M 40		2244		SCM 440	40 ChFA	G 41420	4142; 4140	
		1.7225	42 CrMo 4	42 CD 4	42 CrMo 4	15 142	708 M 40		2244		SCM 440 (H)		G 41400	4142; 4140	
		1.7228	50 CrMo 4	50 CR M04			708 A 47				SCM 445 (H)	50ChFA	G 41470	4150	
		1.7323	20 MoCrS 4	20 CD 4 S											
		1.7325	25 MoCr 4	25 CD 4											
		1.7326	25 MoCrS 4	25 CD 4 S											
		1.7361	32 CrMo 12	30 CD 12	32 CrMo 12	15 230	722 M 24		2240	F-124A					
		1.7707	30 CrMoV 9			15 330									
		1.7709	21 CrMoV 5 7												
		1.7725	GS-30 CrMoV 6 4												
		1.7735	14 CrMoV 6 9	15 CDV 6											
		1.8159	50 CrV 4	50 CV 4	51 CrV 4	15 260	735 A 50		2230	F-143 / F-1430	SUP 10	50ChGFA	G 61500	6150	
		1.8161	58 CrV 4			15 261									
		1.8507	34 CrAlMo 5	30 CAD 6.12	34 CrAlMo 7		905 M 31			F-1741			K 23545	A 355 Cl. D	
		1.8509	41 CrAlMo 7	40 CAD 6.12	41 CrAlMo 7	15 340	905 M 39		2940	F-1740	SACM 645	38ChMJuA	K 24065	A 355 Cl. A	
		1.8515	31 CrMo 12	30 CD 12	31 CrMo 12		722 M 24		2240	F-1712					
		1.8519	31 CrMoV 9							F-1721					
		1.8523	39 CrMoV 13 9		36 CrMoV 13 9		897 M 39								
		1.8550	34 CrAlNi 7										K 52440		
		1.0904	55 Si 7	55 S 7	55 Si 8				250 A 53	2085; 2090			55S2		9255
		1.1157	40 Mn 4	35 M 5					150 M 36				40G	G 10390	1039
		1.1165	30 Mn 5	35 M 5					120 M 36			SMn 433 H; SCMn 2	30GSL		1330
		1.1167	36 Mn 5	40 M 5		42 2715	150 M 36		2120			SMn 438 (H); SCMn 3	35G2; 35GL	G 13350	1335
		1.1170	28 Mn 6	20 M 5	C 28 Mn		150 M 28					SCMn 1	30G		1330
		P.2.3	1.2744	57 NiCrMoV 7 7											
			1.7131	16 MnCr 5	16 MC 5	16 MnCr 5	14 220	527 M 17			F-1516 / F-1517	SCR 415	18ChG	G 51170	5115
			1.7755	GS-35 CrMoV 10 4											
		P.2.4	1.2714	56 NiCrMoV 7											
	1.3505		100 Cr 6	100 C 6	100 Cr 6	14 100	534 A 99		2258	F-131 / F-1310	SUJ 2	SchCh 15	G 52986	52100	
	1.7225		42 CrMo 4	42 CD 4	42 CrMo 4	15 142	708 M 40		2244		SCM 440 (H)		G 41400	4142; 4140	
	P.3.1	1.2080	X 210 Cr 12	Z 200 C 12	X 210 Cr 13 KU	19 436	BD 3				SKD 1	Ch12	T 30403	D 3	
		1.2201	G-X 165 CrV 12												
		1.2343	X 38 CrMoV 5 1	Z 38 CDV 5	X 37 CrMoV 5 1 KU	19 552	BH 11			F-5317	SKD 6	4Ch5MFS	T 28811	H 11	
		1.2363	X 100 CrMoV 5 1	Z 100 CDV 5	X 100 CrMoV 5 1 KU	19 571	BA 2		2260	F-5227	SKD 12		T 30102	A 2	
		1.2365	X 32 CrMoV 3 3	32 DCV 28	30 CrMoV 12 27 KU	19 541	BH 10				SKD 7	3Ch3M3F	T 20810	H 10	
		1.2367	X 38 CrMoV 5 3												
		1.2379	X 155 CrVMo 12 1	Z 160 CDV 12	X 155 CrVMo 12 1 KU	19 573	BD 2			F-5211	SKD 11		T 30402	D 2	
		1.2436	X 210 CrW 12	Z 200 CW 12	X 215 CrW 12 1 KU	19 437			2312	F-5213	SKD 2				
		1.2567	X 30 WCrV 5 3	Z 32 WCV 5	X 30 WCrV 5 3 KU	19 720					SKD 4				
		1.2581	X 30 WCrV 9 3	Z 30 WCV 9	X 30 WCrV 9 3 KU	19 721	BH 21				SKD 5	3Ch2W8F	T 20821	H 21	
1.2601		X 165 CrMoV 12		X 165 CrMoV 12 KU	19 572			2310							
1.2606		G-X 37 CrMoW 5 1													
1.2764		X 19 NiCrMo 4													
1.2767		X 45 NiCrMo 4	Y 35 NCD 16	42 NiCrMo 15 7	19 655										
1.2880		G-X 165 CrCoMo 12													
1.2885	X 32 CrMoCoV 3 3 3	30 DCKV 28													

	Index	Material number	DIN	AFNOR	UNI	ČSN	BS	SIS	UNE	JIS	GOST	UNS	USA		
P	P.3.1	1.3302	S 12-1-4			19 810									
		1.3318	S 12-1-2			19 802									
		1.3333	S 3-3-2		HS 3-3-2	19 820									
		1.3343	S 6-5-2	Z 85 WDCV 06-05-04-0	HS 6-5-2	19 830	BM 2	2722	F-5603	SKH 9; SKH 51	R6AM5	T 11302	M 2		
		1.3346	S 2-9-1	Z 85 DCVV 08-04-02-0	HS 1-8-1		BM 1				H41	T 11301	H 41; M 1		
		1.4943	X 4 NiCrTi 25 15	Z 6 NCTDV 25.15 B				HR 251; HR 52; HR 51			SUH 660				
		1.5662	G-X 8 Ni 9												
		1.5680	12 Ni 19	Z 18 N 5											2515
	P.3.2	1.2080	X 210 Cr 12	Z 200 C 12	X 210 Cr 13 KU	19 436	BD 3				SKD 1	Ch12	T 30403	D 3	
		1.2343	X 38 CrMoV 5 1	Z 38 CDV 5	X 37 CrMoV 5 1 KU	19 552	BH 11			F-5317	SKD 6	4Ch5MFS	T 28811	H 11	
		1.2344	X 40 CrMoV 5 1	Z 40 CDV 5	X 40 CrMo 5 1 1 KU	19 554	BH 13	2242		F-5318	SKD 61	4Ch5MF1S	T 20813	H 13	
		1.2363	X 100 CrMoV 5 1	Z 100 CDV 5	X 100 CrMoV 5 1 KU	19 571	BA 2	2260		F-5227	SKD 12		T 30102	A 2	
		1.2365	X 32 CrMoV 3 3	32 DCV 28	30 CrMoV 12 27 KU	19 541	BH 10				SKD 7	3Ch3M3F	T 20810	H 10	
		1.2367	X 38 CrMoV 5 3												
		1.2379	X 155 CrVMo 12 1	Z 160 CDV 12	X 155 CrVMo 12 1 KU	19 573	BD 2			F-5211	SKD 11		T 30402	D 2	
		1.2567	X 30 WCrV 5 3	Z 32 WCV 5	X 30 WCrV 5 3 KU	19 720					SKD 4				
		1.2581	X 30 WCrV 9 3	Z 30 WCV 9	X 30 WCrV 9 3 KU	19 721	BH 21				SKD 5	3Ch2W8F	T 20821	H 21	
		1.2606	G-X 37 CrMoW 5 1												
		1.2709	X 2 NiCoMoTi 18 9 5												
		1.2764	X 19 NiCrMo 4												
		1.2767	X 45 NiCrMo 4	Y 35 NCD 16	42 NiCrMo 15 7	19 655									
		1.2885	X 32 CrMoCoV 3 3 3	30 DCKV 28											
		1.3207	S 10-4-3-10	Z 130 WKCDV 10-10-04	HS 10-4-3-10	19 861	BT 42			F-5553	SKH 57				
		1.3243	S 6-5-2-5	Z 85 WDKCV 06-05-05	HS 6-5-2-5	19 852		2723		F-5613	SKH 55	R6M5K5			
		1.3246	S 7-4-2-5	Z 110 WKCDV 07-05-04	HS 7-4-2-5	19 851								T 11341	M 41
		1.3247	S 2-10-1-8	Z 110 DKCWW 09-08-04	HS 2-9-1-8				BM 42		SKH 51			T 11342	M 42
		1.3249	S 2-9-2-8						BM 34					T 11333	M 33; M 34
		1.3255	S 18-1-2-5	Z 80 WKCVC 18- 05-04-0	HS 18-1-1-5	19 855	BT 4				SKH 3			T 12004	T 4
		1.3265	S 18-1-2-10		HS 18-0-1-10	19 860	BT 5				SKH 4 A			T 12005	T 5
		1.3344	S 6-5-3	Z 120 WDCV 06-05-04	HS 6-5-3				BM 4		SKH 52; SKH 53			T 11323	M 3 Cl. 2
		1.3348	S 2-9-2	Z 100 DCVV 09-04-02	HS 2-9-2					2782				T 11307	M 7
		1.3401	G-X 120 Mn 12	Z 120 M 12	XG 120 Mn 12			Z 120 M 12				SCMnH 1	110G13L		A 128 (A)
		1.5860	14 NiCr 18				16 523								
		1.5864	35 NiCr 18				16 640			F-122					
		P.3.3	1.6359	X 2 NiCrMo 18 8 5	Maraging 250									K 92890	
	P.4.1	1.2083	X 42 Cr 13	Z 40 C 14	X 41 Cr 13 KU	19 435				F-5263	SUS 420 J 2				
		1.2316	X 36 CrMo 17	Z 38 CD 17	X 38 CrMo 16 1 KU										
		1.3543	X 102 CrMo 17	Z 100 CD 17											
		1.4001	G-X 7 Cr 13	Z 8 C 13 FF		17 020				F-8401					
		1.4002	X 6 CrAl 13	Z 6 CA 13	X 6 CrAl 13		405 S 17	2302		F-3111	SUS 405		S 40500	405	
		1.4005	X 12 CrS 13	Z 12 CF 13	X 12 CrS 13		416 S 21	2380			SUS 416		S 41600	416	
		1.4006	X 10 Cr 13	Z 12 C 13	X 12 Cr 13	17 021	410 S 21	2302		F-3401	SUS 410	12Ch13	S 41000	410; CA-15	
		1.4008	G-X 8 CrNi 13	Z 12 CN 13 M		42 2904									
		1.4016	X 6 Cr 17	Z 8 C 17	X 8 Cr 17	17 040	430 S 15	2320		F-3113	SUS 430	12Ch17	S 43000	430	
		1.4021	X 20 Cr 13	Z 20 C 13	X 20 Cr 13	17 022	420 S 37	2303		F-3402	SUS 420 J 1	20Ch13	S 42000	420	
1.4024		X 15 Cr 13	Z 13 C 13		17 021	420 S 29				SUS 410 J 1					
1.4027		G-X 20 Cr 14	Z 20 C 13 M		42 2906	420 C 29				SCS 2	20Ch13L				
1.4028		X 30 Cr 13	Z 30 C 13	X 30 Cr 13	17 023	420 S 45	2304			SUS 420 J 2	30Ch13				
1.4031		X 38 Cr 13	Z 40 C 14	X 40 Cr 14	17 024		2304		F-3404	SUS 420 J 2	40Ch13				
1.4034		X 46 Cr 13	Z 40 C 14	X 40 Cr 14	17 029	420 S 45			F-3405		40Ch13				
1.4085		G-X 70 Cr 29													

	Index	Material number	DIN	AFNOR	UNI	ČSN	BS	SIS	UNE	JIS	GOST	UNS	USA	
P	P.4.1	1.4104	X 12 CrMoS 17	Z 10 CF 17	X 10 CrS 17	17 140		2383	F-3403	SUS 430 F		S 43020	430 F	
		1.4105	X 4 CrMoS 18						F-3114					
		1.4106	X 2 CrMoSiS 18 2 1											
		1.4107	G-X 8 CrNi 12				42 2904							
		1.4109	X 65 CrMo 14											
		1.4112	X 90 CrMoV 18										S 44003	
		1.4113	X 6 CrMo 17	Z 8 CD 17.01	X 8 CrMo 17			434 S 17	2325	F-3116	SUS 434		S 43400	434
		1.4116	X 45 CrMoV 15							F-3422				
		1.4122	G-X 35 CrMo 17				17 137							
		1.4125	X 105 CrMo 17	Z 100 CD 17	X 105 CrMo 17						SUS 440 C		S 44004	440 C
		1.4136	G-X 70 CrMo 29 2											
		1.4405	G-X 5 CrNiMo 16 5											
		1.4407	G-X 5 CrNiMo 13 4											
		1.4510	X 6 CrTi 17	Z 8 CT 17	X 6 CrTi 17						SUS 430 LX	08Ch17T	S 43036	XM 8; 430 Ti
		1.4511	X 8 CrNb 17	Z 8 CNb 17	X 6 CrNb 17					F-3122	SUS 430 LX			
		1.4512	X 5 CrTi 12	Z 6 CT 12	X 6 CrTi 12			409 S 19		F-3121	SUH 409		S 40900	409
		1.4528	X 105 CrCoMo 18 2											
		1.4540	G-X 4 CrNiCuNb 16 4											
		1.4724	X 10 CrAl 13	Z 10 C 13	X 10 CrAl 12	17 125	403 S 17			F-3152			10Ch13SJj	
		1.4742	X 10 CrAl 18	Z 10 CAS 18	X 8 Cr 17			430 S 15		F-3153	SUS 430; SUH21			430
	1.4761	G-X 120 CrSi 23												
	1.4762	X 10 CrAl 24	Z 10 CAS 24	X 16 Cr 26	17 153				F-3154			S 44600	446	
	1.4931	G-X 22 CrMoV 12 1												
	1.4962	X 12 CrNiWTi 16 3												
	1.6982	G-X 3 CrNi 13 4												
	P.4.2	1.2316	X 36 CrMo 17	Z 38 CD 17	X 38 CrMo 16 1 KU									
		1.4000	X 6 Cr 13	Z 6 C 13	X 6 Cr 13	17 020	403 S 17	2301		SUS 403	08Ch13	S 40300	403	
		1.4021	X 20 Cr 13	Z 20 C 13	X 20 Cr 13	17 022	420 S 37	2303	F-3402	SUS 420 J 1	20Ch13	S 42000	420	
		1.4024	X 15 Cr 13	Z 13 C 13		17 021	420 S 29			SUS 410 J 1				
		1.4028	X 30 Cr 13	Z 30 C 13	X 30 Cr 13	17 023	420 S 45	2304		SUS 420 J 2	30Ch13			
		1.4031	X 38 Cr 13	Z 40 C 14	X 40 Cr 14	17 024		2304	F-3404	SUS 420 J 2	40Ch13			
		1.4034	X 46 Cr 13	Z 40 C 14	X 40 Cr 14	17 029	420 S 45		F-3405		40Ch13			
		1.4057	X 20 CrNi 17 2	Z 15 CN 16.02	X 16 CrNi 16	17 145	431 S 29	2321	F-3427	SUS 431	20Ch17N2	S 43100	431	
		1.4059	G-X 22 CrNi 17											
1.4086		G-X 120 Cr 29												
1.4108		X 100 CrMo 13												
1.4112		X 90 CrMoV 18										S 44003		
1.4116		X 45 CrMoV 15							F-3422					
1.4120		G-X 20 CrMo 13												
1.4122		G-X 35 CrMo 17				17 137								
1.4138		G-X 120 CrMo 29 2												
1.4313		X 5 CrNi 13 4	Z 5 CN 13.4	X 6 CrNi 13 04			425 C 11	2385		SCS 5			CA 6-NM	
1.4340		G-X 40 CrNi 27 4												
1.4464		G-X 40 CrNiMo 27 5												
1.4542		X 7 CrNiCu 16 4 4	Z 7 CNU 17 04 04 (17-4PH)							SCS 24; SUS 630		S 17400	630	
1.4545		X 5 CrNiCu 15-5	E-Z5 CNU 15 05 (15-5PH)											
1.4710		G-X 30 CrSi 6												
1.4718		X 45 CrSi 9 3	Z 45 CS 9	X 45 CrSi 8	17 115	401 S 45			F-3220	SUH 1	40Ch9S2	S 65007	HNV 3	
1.4729		G-X 40 CrSi 13												
1.4740	G-X 40 CrSi 17													
1.4743	G-X 160 CrSi 18													

	Index	Material number	DIN	AFNOR	UNI	ČSN	BS	SIS	UNE	JIS	GOST	UNS	USA	
P	P.4.2	1.4745	G-X 40 CrSi 23											
		1.4747	X 80 CrNiSi 20	Z 80 CSN 20.02	X 80 CrSiNi 20		443 S 65			SUH 4		S 65006	HNV 6	
		1.4776	G-X 40 CrSi 29											
		1.4823	G-X 40 CrNiSi 27 4											
		1.4923	X 22 CrMoV 12 1				17 134	762						
		1.4928	G-X 12 CrNiMoCoVN 12											
		1.4935	X 20 CrMoWV 12 1										S 42200	
M	M.1.1	1.3941	G-X 4 CrNi 18 13											
		1.3944	G-X 5 CrNi 18 11											
		1.3952	G-X 4 CrNiMoN 18 14											
		1.3953	G-X 2 CrNiMo 18 15											
		1.3955	G-X 12 CrNi 18 11											
		1.3959	G-X 10 CrNiNb 16 13											
		1.4301	X 5 CrNi 18 10	Z 6 CN 18-09	X 5 CrNi 18 10	17 240	304 S 15	2332; 2333	F-3504	SUS 304	08Ch18N10	S 30400	304; 304 H	
		1.4303	X 5 CrNi 18 12	Z 8 CN 18.12	X 8 CrNi 19 10		305 S 19			SUS 305	06Ch18N11	S 30500	308; 305	
		1.4305	X 10 CrNiS 18 9	Z 8 CNF 18-03	X 10 CrNi 18 09	17 243	303 S 21	2346		SUS 303		S 30300	303	
		1.4306	X 2 CrNi 19 11	Z 3 CN 18-10	X 2 CrNi 18 11	17 249	304 S 12	2352; 2333	F-3503	SCS 19	03Ch18N11	S 30403	304 L	
		1.4308	G-X 6 CrNi 18 9	Z 6 CN 18.10 M		42 2930	304 C 15	2333	F-8411	SCS 13	07Ch18N9L		CF-8	
		1.4311	X 2 CrNiN 18 10	Z 2 CN 18.10	X 2 CrNiN 18 11	17 249	304 S 62	2371		SUS 304 LN		S 30453	304 LN	
		1.4312	G-X 10 CrNi 18 8			42 2931								
		1.4401	X 5 CrNiMo 18 10	Z 6 CND 17 12 02	X 5 CrNiMo 17 12	17 346	316 S 16	2347	F-3543	SUS 316		S 31600	316	
		1.4404	X 2 CrNiMo 17 13 2	Z 3 CND 17 12 02	X 2 CrNiMo 17 12	17 349	316 S 11	2348	F-3533	SUS 316 L		S 31603	316 L	
		1.4406	X 2 CrNiMoN 17 12 2	Z 2 CND 17.12 Az	X 2 CrNiMoN 17 12		316 S 61			SUS 316 LN		S 31653	316 LN	
		1.4408	G-X 6 CrNiMo 18 10			42 2940			F-8414					
		1.4413	G-X 4 CrNiMo 13-4											
		1.4429	X 2 CrNiMoN 17 13 3	Z 3 CND 17 11 03 Az	X 2 CrNiMoN 17 13		316 S 62	2375		SUS 316 LN		S 31653	316 LN	
		1.4435	X 2 CrNiMo 18 14 3	Z 2 CND 17.13	X 2 CrNiMo 17 13		316 S 12	2353		SCS 16; SUS 316 L	03Ch17N 14M2	S 31603	316 L	
		1.4436	X 5 CrNiMo 17 13 3	Z 6 CND 17.12	X 5 CrNiMo 17 13		316 S 16	2343		SUS 316		S 31600	316	
		1.4437	G-X 6 CrNiMo 18 12			42 2940								
		1.4438	X 2 CrNiMo 18 16 4	Z 2 CND 19.15	X 2 CrNiMo 18 15		317 S 12	2367		SUS 317 L		S 31703	317 L	
		1.4439	G-X 3 CrNiMo 17 13 5						F-3544					
		1.4446	G-X 2 CrNiMo 17 13 4											
		1.4448	G-X 6 CrNiMo 17 13											
		1.4449	X 3 CrNiMo 18 12 3											
		1.4507	X 2 CrNiMoCuN 25 6 3	Z 3 CNDU 25 07 Az (Uranus 52 N)									S 32750	F61
		1.4541	X 6 CrNiTi 18 10	Z 6 CNT 18.10	X 6 CrNiTi 18 11	17 248	321 S 12	2337		SUS 321	12Ch18N 10T	S 32100	321	
		1.4546	X 5 CrNiNb 18 10		X 6 CrNiNb 18 11		347 S 18					S 34800	348	
		1.4550	X 6 CrNiNb 18 10	Z 10 CNNb 18-10	X 6 CrNiNb 18 11	17 245	347 S 17	2338	F-3552/ F-3524	SUS 347	08Ch18N 12B	S 34700	347	
		1.4552	G-X 5 CrNiNb 18 9			42 2933			F-8413					
		1.4571	X 6 CrNiMoTi 17 12 2	Z 6 CNT 17.12	X 6 CrNiMoTi 17 12	17 348	320 S 31	2350	F-3535		10Ch17N- 13M2T	S 31635	316 Ti	
		1.4573	X 10 CrNiMoTi 18 12		X 6 CrNiMoTi 17 13		320 S 33				10Ch17N- 13M3T	S 31635	316 Ti	
		1.4580	X 6 CrNiMoNb 17 12 2	Z 6 CNDNb 17.12	X 6 CrNiMoNb 17 12		318 S 17		F-3536		08Ch16N- 13M2B	S 31640	316 Nb	
		1.4581	G-X 5 CrNiMoNb 18 10	Z 4 CNDNb 18.12 M	GX 6 CrMoNb 20 11	42 2941	318 C 17			SCS 22				
		1.4583	X 10 CrNiMoNb 18 12		X 6 CrNiMoNb 17 13								318	
		1.4821	X 15 CrNiSi 25-4	Z 20 CNS 25 04										
		1.4825	G-X 25 CrNiSi 18 9			42 2932								
		1.4826	G-X 40 CrNiSi 22 9			42 2934								
		1.4828	X 15 CrNiSi 20 12	Z 15 CNS 20.12			17 251	309 S 24		F-3312	SUH 309	20Ch20N 14S2	S 30900	309
		1.4832	G-X 25 CrNiSi 20 14											
		1.4876	X 10 NiCrAlTi 32 20	Z 10 NCAT 32-21 (Incoloy 800)			17 358	NA 15 (H)		F-3314	NCF 800			B 163
1.4878	X 12 CrNiTi 18 9	Z 6 CNT 18.12 (B)	X 6 CrNiTi 18 11	17 246	321 S 20	2337		SUS 321	12Ch18N 10T		321			

	Index	Material number	DIN	AFNOR	UNI	ČSN	BS	SIS	UNE	JIS	GOST	UNS	USA		
M	M.1.1	1.4968	G-X 7 CrNiNb 16 13												
		1.4988	G-X 8 CrNiMoVNb 16 1												
		1.6901	G-X 8 CrNi 18 10												
		1.6902	G-X 6 CrNi 18 10												
		1.6905	G-X 5 CrNiNb 18 10												
	M.2.1	1.3964	G-X 4 CrNiMnMoN 19 1												
		1.4310	X 12 CrNi 17 7	Z 12 CN 17.07	X 12 CrNi 17 07			301 S 21			SUS 301		S 30100	301	
		1.4465	G-X 2 CrNiMoN 25 25												
		1.4536	G-X 2 NiCrMoCuN 25 2												
		1.4539	X 1 NiCrMoCu 25 20 5	Z2 NCDU 25 20 (Uranus B6)									N 08904	904L	
		1.4547	X 1 CrNiMoCuN 20 18 17	Z1 CNDU 20 18 06 Az (254 SMO)										F44	
		1.4568	X 7 CrNiAl 17 7											17-7 PH	
		1.4837	G-X 40 CrNiSi 25 12				42 2936								
		1.4840	G-X 15 CrNi 25 20												
		1.4841	X 15 CrNiSi 25 20	Z 15 CNS 25.20	X 16 CrNiSi 25 20	17 255				F-3310	SUH 310	20Ch25N 20S2	S 31000	314; 310	
		1.4845	X 12 CrNi 25 21	Z 12 CN 25.20	X 6 CrNi 26 20	17 255	310 S24	2361			SUH 310;		S 31008	310 S	
		1.4848	G-X 40 CrNiSi 25 20		GX 40 CrNi 26 20	42 2952									
		1.4849	G-X 40 NiCrSiNb 38 1												
		1.4852	G-X 40 NiCrNb 35 25												
		1.4855	G-X 30 CrNiSiNb 24 2												
		1.4857	G-X 40 NiCrSi 35 25												
		1.4864	X 12 NiCrSi 36 16	Z 12 NCS 37.18			17 253	NA 17		F-3313	SUH 330		N 08330	330	
		1.4865	G-X 40 NiCrSi 38 18		GX 50 NiCr 39 19			330 C 40			SCH 15; SCH 16				
		1.4871	X 53 CrMnNiN 21 9	Z 52 CMN 21.09	X 53 CrMnNiN 21 9			349 S 54		F-3217	SUH 35; SUH 36	55Ch-20G9AN4	S 63008	EV 8	
		1.4873	X 45 CrNiW 18 9	Z 35 CNWS 20.09	X 45 CrNiW 18 9			331 S 40			SUH 31				
	M.3.1	1.4339	G-X 32 CrNi 28 10												
		1.4347	G-X 8 CrNi 26 7												
		1.4410	X 2 CrNiMoN 25 7 4	Z2 CND 25 07 04 Az						F-3552				F53	
		1.4460	X 8 CrNiMo 27 5	Z5 CND 25 05 AZ					2324		SUS 329 J 1		S 32900	329 LN	
		1.4462	X 2 CrNiMoN 22 5 3	Z2 CND 22 05 03 AZ (Uranus 45 N)			17 381			F-3308			S 31803	329 A (F51)	
		1.4463	G-X 6 CrNiMo 24 8 2												
		1.4501	X 2 CrNiMoCuWN 25 7 4	Z2 CNDUW 25 07 04 Az (Zeron 100)									S 32760	F55	
		1.4815	G-X 8 CrNi 19 10												
1.4822		G-X 40 CrNi 24 5													
K	K.1.1	0.6010	GG-10	Ft 10 D	G 10	42 2410		01 10-00		FC 10	Sc 10		A48-20 B		
		0.6015	GG-15	Ft 15 D	G 15	42 2415	Grade 150	01 15-00	FG-15	FC 15	Sc 15		A48-25 B		
		0.6020	GG-20	Ft 20 D	G 20	42 2420	Grade 220	01 20-00	FG-20	FC 20	Sc 20		A48-30 B		
		0.6025	GG-25	Ft 25 D	G 25	42 2425	Grade 260	01 25-00	FG-25	FC 25	Sc 25		A48-40 B		
	K.1.2	0.6030	GG-30	Ft 30 D	G 30	42 2430	Grade 300	01 30-00	FG-30	FC 30	Sc 30		A48-45 B		
		0.6035	GG-35	Ft 35 D	G 35	42 2435	Grade 350	01 35-00	FG-35	FC 35	Sc 35		A48-50 B		
		0.6040	GG-40	Ft 40 D		42 2440	Grade 400	01 40-00			Sc 40		A48-60 B		
		0.6652	GGL-NiMn 13 7	L- NM 13 7			L-NiMn 13 7								
		0.6655	GGL-NiCuCr 15 6 2	L-NUC 15 6 2			L-NiCuCr 15 6 2						A 436 Type 1		
		0.6656	GGL-NiCuCr 15 6 3	L-NUC 15 6 3			L-NiCuCr 15 6 3						A 436 Type 1b		
		0.6660	GGL-NiCr 20 2	L-NC 20 2			L-NiCr 20 2	05 23-00					A 436 Type 2		
		0.6661	GGL-NiCr 20 3	L-NC 20 3			L-NiCr 20 3						A 436 Type 2b		
		0.6667	GGL-NiSiCr 20 5 3	L-NSC 20 5 3			L-NiSiCr 20 5 3								
		0.6676	GGL-NiCr 30 3	L-NC 30 3			L-NiCr 30 3						A 436 Type 3		
		0.6680	GGL-NiSiCr 30 5 5	L-NSC 30 5 5			L-NiSiCr 30 5 5						A 436 Type 4		
		K.2.1	0.7033	GGG-35.3				42 2303							
			0.7040	GGG-40	FGS 400-12	GS 400-12	42 2304	SNG 420/12	0717-02	FGE 38-17	FCD 40	VC 42-12			60 40 18

	Index	Material number	DIN	AFNOR	UNI	ČSN	BS	SIS	UNE	JIS	GOST	UNS	USA	
K	K.2.1	0.7043	GGG-40.3	FGS 370-17	GS0 42/17	42 2314	SNG 370/17	0717-15			VC 42-12			
		0.7050	GGG-50	FGS 500-7	GS 500/7	42 2305	SNG 500/7	0727-02	FGE 50-7	FCD 50	VC 50-2		65-45-12	
		0.7060	GGG-60	FGS 600-3	GS 600/3	42 2306	SNG 600/3	0732-03		FCD 60	VC 60-2		80-55-06	
	K.2.2	0.7070	GGG-70	FGS 700-2	GS 700-2	42 2307	SNG 700/2	0737-01	FGS 70-2	FCD 70	VC 70-2		100-70-03	
		0.7080	GGG-80	FGS 800-2	GS 800-2	42 2308	SNG 800/2				VC 80-2		120-90-02	
		0.7652	GGG-NiMn 13 7	S-NM 13 7			S-NiMn 13 7							
		0.7660	GGG-NiCr 20 2	S-NC 20 2			S-NiCr 20 2						A 439 Type D-2	
		0.7661	GGG-NiCr 20 3	S-NC 20 3			S-NiCr 20 3						A 439 Type D-2B	
		0.7665	GGG-NiSiCr 20 5 2	S-NSC 20 5 2			S-NiSiCr 20 5 2							
		0.7670	GGG-Ni 22	S-N 22			S-Ni 22							A 439 Type D-2C
		0.7673	GGG-NiMn 23 4	S-NM 23 4			S-NiMn 23 4							A 439 Type D-2M
		0.7676	GGG-NiCr 30 3	S-NC 30 3			S-NiCr 30 3							A 439 Type D-3
		0.7677	GGG-NiCr 30 1	S-NC 30 1			S-NiCr 30 1							A 439 Type D-3A
		0.7680	GGG-NiSiCr 30 5 5	S-NSC 30 5 5			S-NiSiCr 30 5 5							A 439 Type D-4
		0.7683	GGG-Ni 35	S-N 35			S-Ni 35							A 439 Type D-5
		0.7685	GGG-NiCr 35 3	S-NC 35 3			S-NiCr 35 3							A 439 Type D-5B
		0.8065	GTW-65											
		K.3.1	0.8035	GTW-35-04				42 2536			GTW 35			
	0.8040		GTW-40-05				42 2540							
	0.8045		GTW-45-07											
	0.8055		GTW-55											
	0.8135		GTS-35-10	MN 35-10			42 2533	B 340/12		GTS 35				
	0.8145		GTS-45-06				42 2545	P 440/7		GTS 45				
	0.8155		GTS-55-04	MP 50-5			42 2555	P 510/4		GTS 55				
	0.8165	GTS-65-02	MP 60-3				P 570/3		GTS 65					
K.3.2	0.8170	GTS-70-02	IP 70-2				P 690/2		GTS 70					
N	N.1.1	3.3307	Al99.85Mg0.5											
		3.3308	Al99.9Mg0.5											
		3.3315	AlMg1	5005 (AlMg1)						L-3350				
		3.3316	AlMg1.5											
		3.3317	Al99.85Mg1											
		3.3318	Al99.9Mg1											
		3.3326	AlMg1.8											
		3.3523	AlMg2.5											
		3.3525	AlMg2Mn0.3											
		3.3527	AlMg2Mn0.8											
		3.3535	AlMg3	5754										
		3.3537	AlMg2.7Mn											
		3.3555	AlMg5	5056 A										
		3.3561	G-AlMg5											
		3.3591	G-AlMg10											
		3.0205	Al99	1200 (A4)	9001/1	42 4009				L-3001				
		3.0255	Al99.5	1050 A	9001/2	42 4004				L-3051				
		3.0275	Al99.7	1070 A		42 4003				L-3071				
		3.0285	Al99.8	1080 A (A8)		42 4002				L-3081				
		3.0305	Al99.9											
		3.0505	AlMn0.5Mg0.5											
		3.0506	AlMn0.6											
		3.0515	AlMn1			42 4432				L-3810				
		3.0517	AlMnCu											
		3.0525	AlMn1Mg0.5	3005										

Index	Material number	DIN	AFNOR	UNI	ČSN	BS	SIS	UNE	JIS	GOST	UNS	USA	
N	N.1.1	3.0526	AlMn1Mg1										
		3.0615	AlMgSiPb										
		3.0915	AlFeSi										
	N.1.2	3.2307	Al99.85MgSi										
		3.2315	AlMgSi1	6082	9006/4	42 4400							6082
		3.3206	AlMgSi0,5	6060 (AGS)		42 4401			L-3441				6063
		3.3208	Al99.9MgSi										
		3.3210	AlMgSi0.7	6005 A									
		3.3211	AlMg1SiCu	6061									
		3.3345	AlMg4.5										
		3.3545	AlMg4Mn	5086 (AG4MC)	9005/5				L-3322				5083
		3.3547	AlMg4,5Mn0,7	5083 (AlMg5Mn0,7)			N8		L-3321	A 5083			A95083
		3.3549	AlMg5Mn										
		3.4335	AlZn4,5Mg1	7020 (AZ5G)	9007/1	42 4441			L-3741				7020
		3.4337	Al99.8ZnMg										
		3.4345	AlZnMgCu0.5										
		3.4365	AlZnMgCu1.5	7075 (AZ5GU)			42 4222		L-3710				7075
		2.1086	G-CuSn10Zn										
		3.1255	AlCuSiMn	2014	9002/3								2014
		3.1305	AlCu2.5Mg0.5										
		3.1325	AlCuMg1	2017 A (AU4G)					L-3120				2017 A
		3.1355	AlCuMg2	2024 (AU4G1)	9002/4	42 4203			L-3140				2024
		3.1645	AlCuMgPb	2030 (AU4PB)			42 4254		L-3121				
	3.1655	AlCuBiPb	2011 (AU5PbBi)	9002/5				L-3192				2011	
	MFK												
	N.2.1	3.2581	G-AlSi12			42 4330							
		3.2583	G-AlSi12(Cu)			42 4330							
		3.3261	G-AlMg5Si			42 4515							
		3.3292	GD-AlMg9			42 4519							
		3.3541	G-AlMg3										
		3.3543	G-AlMg3(Cu)										
	N.2.2	3.2134	G-AlSi5Cu1Mg										
		3.2151	G-AlSi6Cu4			42 4357							
		3.2161	G-AlSi8Cu3										
		3.2341	G-AlSi5Mg										
		3.2371	G-AlSi7Mg			42 4334							
3.2373		G-AlSi9Mg			42 4331								
3.2381		G-AlSi10Mg			42 4331								
3.2383		G-AlSi10Mg(Cu)			42 4331								
3.3241		G-AlMg3Si											
3.1371		G-AlCu4TiMg											
3.1841		G-AlCu4Ti											
N.3.1	2.0040	OF-Cu			42 3000								
	2.0060	E-Cu57			42 3001								
	2.0065	E-Cu58			42 3001								
	2.0070	SE-Cu											
	2.0076	SW-Cu											
	2.0090	SF-Cu			42 3003								
	2.0220	CuZn5			42 3200								
	2.0230	CuZn10			42 3201								
2.0240	CuZn15			42 3202									

	Index	Material number	DIN	AFNOR	UNI	ČSN	BS	SIS	UNE	JIS	GOST	UNS	USA
N	N.3.1	2.0250	CuZn20			42 3203							
		2.0261	CuZn28										
		2.0265	CuZn30			42 3210							
		2.0280	CuZn33			42 3212							
		2.0321	CuZn37			C2700	42 3213						
		2.0335	CuZn36										
		2.0360	CuZn40			42 3220							
		2.0460	CuZn20Al2										
		2.0470	CuZn28Sn1										
		2.0510	CuZn37Al1			42 3231							
		2.0530	CuZn38Sn1			42 3237							
		2.0730	CuNi12Zn24										
		2.0740	CuNi18Zn20										
		2.0830	CuNi25										
		2.0842	CuNi44Mn1										
		2.0853	CuNi1.5Si										
		2.0855	CuNi2Si				42 3054						
		2.0857	CuNi3Si										
		2.0872	CuNi10Fe1Mn										
		2.0875	CuNi9Sn2										
		2.0882	CuNi30Mn1Fe										
		2.0883	CuNi30Fe2Mn2										
		2.0918	CuAl5As										
		2.0920	CuAl8										
		2.0932	CuAl8Fe3										
		2.0936	CuAl10Fe3Mn2										
		2.0960	CuAl9Mn2										
		2.0966	CuAl10Ni5Fe4										
		2.0971	CuAl9Ni3Fe2										
		2.1016	CuSn4										
		2.1020	CuSn6										
		2.1030	CuSn8										
		2.1080	CuSn6Zn6										
		2.1191	CuAg0.1P										
		2.1203	CuAg0.1										
		2.1245	CuBe1.7										
		2.1247	CuBe2										
		2.1293	CuCrZr				42 3039						
		2.1310	CuFe2P										
		2.1522	CuSi2Mn										
		2.1525	CuSi3Mn										
		Ampco 16	CuAl10Fe3										
		Ampco 18	CuAl10.5Fe3.5										
		Ampco 8	CuAl6.5Fe2.5Sn										
			Ampco 8-16										
		N.3.2	2.0331	CuZn36Pb1.5			42 3214						
2.0332	CuZn37Pb0.5												
2.0372	CuZn39Pb0.5				42 3221								
2.0540	CuZn35Ni2												
2.0550	CuZn40Al2												
2.0561	CuZn40Al1				42 3231								

	Index	Material number	DIN	AFNOR	UNI	ČSN	BS	SIS	UNE	JIS	GOST	UNS	USA	
N	N.3.2	2.0572	CuZn40Mn1			42 3234								
		2.0580	CuZn40Mn1Pb											
		2.0780	CuNi12Zn30Pb1											
		2.0790	CuNi18Zn19Pb1											
		2.1498	CuSP											
		2.1504	NiAlBz											
		2.1546	CuTeP											
		Ampco 12	CuAl9Fe3											
		Ampco 20	CuAl11Fe4											
	N.3.3	2.0371	CuZn38Pb1.5				42 3222							
		2.0375	CuZn36Pb3											
		2.0380	CuZn39Pb2				42 3223							
		2.0401	CuZn39Pb3											
		2.0402	CuZn40Pb2				42 3223							
		2.0410	CuZn44Pb2											
		2.0490	CuZn31Si1											
		2.0500	CuZn23Al6Mn-4Fe3											
		2.0771	CuNi7Zn39Mn-5Pb3											
		2.0978	CuAl11Ni6Fe5											
		2.1093	G-CuSn6ZnNi											
		2.1096	G-CuSn5ZnPb											
		2.1285	CuCo2Be											
		Ampco 21	CuAl13Fe4.5											
		Ampco 22	CuAl14Fe5											
		Ampco 25												
		Ampco 26												
			Ampco 18-26											
	N.4.1	3.5101	G-MgZn4SE1Zr1											
		3.5102	G-MgZn5Th2Zr1											
		3.5103	G-MgSE3Zn2Zr1											
		3.5105	G-MgTh3Zn2Zr1											
		3.5106	G-MgAg3Se2Zr1											
		3.5200	MgMn2											
3.5312		MgAl3Zn												
3.5470		GD-MgAl4Si1												
3.5612		GD-MgAl6Zn1												
3.5662		G-MgAl6												
3.5812		G-MgAl8Zn1												
3.5912		GD-MgAl9Zn1												
S		S.1.2	1.4980	X 5 NiCrTi 26 15									S66286	
	S.2.1	1.3924	Ni54											
		1.3926	RNi12				42 3484							
		1.3927	RNi8				42 3484							
		2.4360	NiCu30Fe	Monel 400			42 3431							
		2.4610	NiMo16Cr16Ti	Hastelloy C-4										
		2.4617	NiMo28	Hastelloy B-2										
		2.4630	NiCr20Ti	Nimonic 75				HR 5						
		2.4668	NiCr19Fe18Nb5Mg	Inconel 718										
		2.4812	NiCr17Mo17FeW	Hastelloy C										
		2.4819	NiMo16Cr15W	Hastelloy C-276										
		2.4851	NiCr23Fe, Inconel 601	Inconel 601										

	Index	Material number	DIN	AFNOR	UNI	ČSN	BS	SIS	UNE	JIS	GOST	UNS	USA	
S	S.2.1	2.4856	NiCr22Mo9Nb	Inconel 625										
		2.4858	NiCr21Mo				NA 16			NCF 825		N 08825		
		2.4951	NiCr20Ti	Nimonic 75			HR 5							
		2.4964	CoCr20W15Ni											
		2.4989	CoCr20NiW											
	S.2.2	2.4375	NiCu30Al	Monel K 500										
		2.4631	NiCr20TiAl	Nimonic 80 A				HR 401; 601			NCF 80 A		N 07080	
		2.4634	NiCo20Cr15MoAlTi	Nimonic 105										
		2.4640	NiCr15Fe	Inconel 600										
		2.4654	NiCr20Co13Mo- 4Ti4Al	Waspaloy										
		2.4662	NiCr13Mo6Ti3	Nimonic 901										
		2.4668	NiCr19Fe18Nb5Mg	Inconel 718										
		2.4816	NiCr15Fe	Inconel 600				NA 14			NCF 600		N 06600	
		2.4952	NiCr20TiAl	Nimonic 80 A										
		2.4973	NiCr19Co11MoTi											
		2.4983	NiCr18Co18MoAlTi	Udimet 500										
	S.2.3	2.4670	G-NiCr13Al6MoNb	Nimocast 713										
		2.4674	NiCo15Cr10MoAlTi	Nimocast PK 24										
		2.4979	CoCr28MoNi											
	S.3.1	3.7024	Ti99,5											
		3.7025	Ti99,8											
		3.7034	Ti99,7											
		3.7055	Ti99,4											
		3.7064	Ti99,2											
		3.7124	TiCu2											
	S.3.2	3.7114	TiAl5Sn2											
		3.7144	TiAl6Sn2Zr4Mo2											
		3.7154	TiAl6Zr5											
		3.7165	TiAl6V4	T-A 6 V				TA 10 – TA 13					R 56400	
		3.7174	TiAl6V6Sn2											
		3.7184	TiAl4Mo4Sn2					TA 45 – TA 51						
	H	H.1.1	1.2311	40 CrMnMo 7			19 520							
1.2312			40 CrMnMoS 8 6	40 CMD 8 + S										
1.2316			X 36 CrMo 17	Z 38 CD 17	X 38 CrMo 16 1 KU									
1.2365			X 32 CrMoV 3 3	32 DCV 28	30 CrMoV 12 27 KU	19 541	BH 10				SKD 7	3Ch3M3F	T 20810	H 10
1.2567			X 30 WCrV 5 3	Z 32 WCV 5	X 30 WCrV 5 3 KU	19 720					SKD 4			
1.2581			X 30 WCrV 9 3	Z 30 WCV 9	X 30 WCrV 9 3 KU	19 721	BH 21				SKD 5	3Ch2W8F	T 20821	H 21
1.2738			40 CrMnNiMo 8							F-5303				
1.2885			X 32 CrMoCoV 3 3 3	30 DCKV 28										
1.4028			X 30 Cr 13	Z 30 C 13	X 30 Cr 13	17 023	420 S 45	2304			SUS 420 J 2	30Ch13		
1.4031			X 38 Cr 13	Z 40 C 14	X 40 Cr 14	17 024			2304	F-3404	SUS 420 J 2	40Ch13		
1.4034			X 46 Cr 13	Z 40 C 14	X 40 Cr 14	17 029	420 S 45			F-3405		40Ch13		
1.4112			X 90 CrMoV 18										S 44003	
1.5122			37 MnSi 4				13 240							
1.6358			X 2 NiCoMoTi 18 9 5											
1.6582			34 CrNiMo 6	35 NCD 6	35 NiCrMo 6 (KW)	16 342	817 M 40	2541		F-128 / F-1270	SNCM 447	38Ch2N2MA		4340
1.7003			38 Cr 2	38 C 2	38 Cr 2									
1.7006			46 Cr 2	42 C 2	45 Cr 2									5045
1.7030			28 Cr 4					530 A 30				30Ch		5130
1.7176			55 Cr 3	55 C 3	55 Cr 3			527 A 60	2253	F-1431	SUP 9 (A)	50ChGA	G 51550	5155
1.0961			60 SiCr 7	60 SC 7	60 SiCr 8						SUP 7			9262

Index	Material number	DIN	AFNOR	UNI	ČSN	BS	SIS	UNE	JIS	GOST	UNS	USA	
H.1.1	1.1248	Ck 75	XC 75	C 75	12 081	060 A 78	1774; 1778			75	G 10780	1078; 1080	
	1.1273	90 Mn 4											
H.1.2	1.2083	X 42 Cr 13	Z 40 C 14	X 41 Cr 13 KU	19 435			F-5263	SUS 420 J 2				
	1.2323	GS-48 CrMoV 6 7											
	1.2343	X 38 CrMoV 5 1	Z 38 CDV 5	X 37 CrMoV 5 1 KU	19 552	BH 11		F-5317	SKD 6	4Ch5MFS	T 28811	H 11	
	1.2367	X 38 CrMoV 5 3											
	1.2510	100 MnCrW 4	90 MWCV 5	95 MnWCr 5 KU	19 314	B0 1	2140	F-5220	SKS 3		T 31501	O 1	
	1.2542	45 WCrV 7		45 WCrV 8 KU	19 732	BS 1	2710				T 41901	S 1	
	1.2550	60 WCrV 7	55 WC 20	55 WCrV 8 KU	19 735								
	1.2606	G-X 37 CrMoW 5 1											
	1.2711	54 NiCrMoV 6	55 NCDV 6		19 662								
	1.2713	55 NiCrMoV 6	55 NCDV 7		19 662			F-520.S	SKT 4	5ChNM	T 61206	L 6	
	1.2764	X 19 NiCrMo 4											
	1.2767	X 45 NiCrMo 4	Y 35 NCD 16	42 NiCrMo 15 7	19 655								
	1.4109	X 65 CrMo 14											
	1.4112	X 90 CrMoV 18									S 44003		
	1.1157	40 Mn 4	35 M 5				150 M 36				40G	G 10390	1039
	1.1231	Ck 67	XC 68	C 70	12 071	060 A 67	1770				70	G 10700	1070
	1.1274	Ck 101	XC 100				060 A 96	1870		SUP 4		G 10950	1095
	H.1.3	1.2080	X 210 Cr 12	Z 200 C 12	X 210 Cr 13 KU	19 436	BD 3			SKD 1	Ch12	T 30403	D 3
1.2101		62 SiMnCr 4											
1.2162		21 MnCr 5	20 NC 5		19 487				SCR 420 H				
1.2201		G-X 165 CrV 12											
1.2210		115 CrV 3	100 C 3	107 CrV 3 KU	19 421						T 61202	L 2	
1.2341		X 6 CrMo 4											
1.2379		X 155 CrVMo 12 1	Z 160 CDV 12	X 155 CrV-Mo 12 1 KU	19 573	BD 2		F-5211	SKD 11		T 30402	D 2	
1.2419		105 WCr 6	105 WC 13	107 WCr 5 KU					SKS 31	ChWG			
1.2601		X 165 CrMoV 12		X 165 CrMoV 12 KU	19 572		2310						
1.2721		50 NiCr 13											
1.2735		15 NiCr 14	10 NC 12		16 240				SNC 22		T 51606		
1.2833		100 V 1	Y1 105 V	102 V 2 KU	19 356	BW 2			SKS 43		T 72302	W 210	
1.2842		90 MnCrV 8	90 MV 8	90 MnVCr 8 KU	19 314	B0 2					T 31502	O 2	
1.3505		100 Cr 6	100 C 6	100 Cr 6	14 100	534 A 99	2258	F-131 / F-1310	SUJ 2	SchCh 15	G 52986	52100	
1.4112		X 90 CrMoV 18									S 44003		
1.4125		X 105 CrMo 17	Z 100 CD 17	X 105 CrMo 17					SUS 440 C		S 44004	440 C	
1.8161		58 CrV 4			15 261								
1.1520		C 70 W1											
H.1.4	1.2363	X 100 CrMoV 5 1	Z 100 CDV 5	X 100 CrMoV 5 1 KU	19 571	BA 2	2260	F-5227	SKD 12		T 30102	A 2	
	1.2436	X 210 CrW 12	Z 200 CW 12	X 215 CrW 12 1 KU	19 437		2312	F-5213	SKD 2				
	1.2880	G-X 165 CrCoMo 12											
	1.3202	S 12-1-4-5			19 858						T 12015	T15	
	1.3207	S 10-4-3-10	Z 130 WKCDV 10-10-04	HS 10-4-3-10	19 861	BT 42		F-5553	SKH 57				
	1.3243	S 6-5-2-5	Z 85 WDKCV 06-05-05	HS 6-5-2-5	19 852		2723	F-5613	SKH 55	R6M5K5			
	1.3246	S 7-4-2-5	Z 110 WKCDV 07-05-04	HS 7-4-2-5	19 851						T 11341	M 41	
	1.3247	S 2-10-1-8	Z 110 DKCWV 09-08-04	HS 2-9-1-8			BM 42		SKH 51		T 11342	M 42	
	1.3249	S 2-9-2-8					BM 34				T 11333	M 33; M 34	
	1.3257	S 18-1-2-15											
	1.3333	S 3-3-2		HS 3-3-2	19 820								
	1.3343	S 6-5-2	Z 85 WDCV 06-05-04-0	HS 6-5-2	19 830	BM 2	2722	F-5603	SKH 9; SKH 51	R6AM5	T 11302	M 2	
1.3344	S 6-5-3	Z 120 WDCV 06-05-04	HS 6-5-3		BM 4			SKH 52; SKH 53		T 11323	M 3 Cl. 2		
1.3346	S 2-9-1	Z 85 DCWV 08-04-02-0	HS 1-8-1		BM 1				H41	T 11301	H 41; M 1		

	Index	Material number	DIN	AFNOR	UNI	ČSN	BS	SIS	UNE	JIS	GOST	UNS	USA	
H	H.1.4	1.3348	S 2-9-2	Z 100 DCWV 09-04-02	HS 2-9-2			2782				T 11307	M 7	
		1.3355	S 18-0-1	Z 80 WCV 18-04-01	HS 18-0-1	19 824	BT 1			SKH 2	R18	T 12001	T 1	
		1.1654	C 110 W											
	H.3.1	0.9620	G-X 260 NiCr 4 2					Grade 2 A	0512-00					A 532 I B NiCr-LC
		0.9625	G-X 330 NiCr 4 2					Grade 2 B	0513-00					A 532 I A NiCr-HC
		0.9630	G-X 300 CrNiSi 9 5 2					Grade 2 C; D; E	0457-00					A 532 I D Ni-HiCr
		0.9635	G-X 330 CrMo 15 3					Grade 3 A; B						A 532 II C 15% CrMo-
		0.9640	G-X 300 CrMoNi 15 2					Grade 3 A; B						
		0.9645	G-X 260 CrMoNi 20 2					Grade 3 C						A 532 II D 20% CrMo-
		0.9650	G-X 260 Cr 27					Grade 3 D	0466-00					A 532 III A 25% Cr
0.9655	G-X 300 CrMo 27 1					Grade 3 E						A 532 III A 25% Cr		
O	O.1.1	EP												
		MF												
		PF												
		UP												
	O.1.2	PA												
		PC												
		PE												
		PI												
		PMMA												
		POM												
		PP												
		PS												
	PTFE													
	PVC													
	O.2.1	AFK												
	O.2.2	CFK												
		GFK												
	O.3.1	Graphit												

Article No.	Designation	Page No.	Article No.	Designation	Page No.
10 103 ...	Solid drilling and bore machining	1 / 9	40 471 ...	Solid drilling and bore machining	1 / 57
10 107 ...	Solid drilling and bore machining	1 / 6	40 472 ...	Solid drilling and bore machining	1 / 60
10 113 ...	Solid drilling and bore machining	1 / 6	40 473 ...	Solid drilling and bore machining	1 / 58
10 171 ...	Solid drilling and bore machining	1 / 7	40 474 ...	Solid drilling and bore machining	1 / 61
10 173 ...	Solid drilling and bore machining	1 / 7	40 481 ...	Solid drilling and bore machining	1 / 54
10 270 ...	Solid drilling and bore machining	1 / 8	40 483 ...	Solid drilling and bore machining	1 / 51
10 512 ...	Solid drilling and bore machining	1 / 9	40 484 ...	Solid drilling and bore machining	1 / 57
10 522 ...	Solid drilling and bore machining	1 / 9	40 485 ...	Solid drilling and bore machining	1 / 60
10 693 ...	Solid drilling and bore machining	1 / 30	40 486 ...	Solid drilling and bore machining	1 / 58
10 694 ...	Solid drilling and bore machining	1 / 30	40 487 ...	Solid drilling and bore machining	1 / 61
10 695 ...	Solid drilling and bore machining	1 / 31	40 488 ...	Solid drilling and bore machining	1 / 55
10 703 ...	Solid drilling and bore machining	1 / 32	40 489 ...	Solid drilling and bore machining	1 / 52
10 720 ...	Solid drilling and bore machining	1 / 21	40 605 ...	Solid drilling and bore machining	1 / 49
10 721 ...	Solid drilling and bore machining	1 / 28	40 625 ...	Solid drilling and bore machining	1 / 49
10 786 ...	Solid drilling and bore machining	1 / 19	40 635 ...	Solid drilling and bore machining	1 / 49
10 787 ...	Solid drilling and bore machining	1 / 25	40 640 ...	Solid drilling and bore machining	1 / 50
10 791 ...	Solid drilling and bore machining	1 / 26	40 644 ...	Solid drilling and bore machining	1 / 50
11 600 ...	Solid drilling and bore machining	1 / 17	40 648 ...	Solid drilling and bore machining	1 / 49
11 603 ...	Solid drilling and bore machining	1 / 20	40 652 ...	Solid drilling and bore machining	1 / 49
11 606 ...	Solid drilling and bore machining	1 / 23	40 657 ...	Solid drilling and bore machining	1 / 50
11 609 ...	Solid drilling and bore machining	1 / 27	50 966 ...	Milling	4 / 6
11 770 ...	Solid drilling and bore machining	1 / 29	50 973 ...	Milling	4 / 7
11 777 ...	Solid drilling and bore machining	1 / 16	52 195 ...	Milling	4 / 14
11 780 ...	Solid drilling and bore machining	1 / 18	52 802 ...	Milling	4 / 13
11 783 ...	Solid drilling and bore machining	1 / 22	53 003 ...	Threading	2 / 36
11 786 ...	Solid drilling and bore machining	1 / 24	53 004 ...	Threading	2 / 36
22 202 ...	Threading	2 / 12	53 007 ...	Threading	2 / 32
22 468 ...	Threading	2 / 8	53 008 ...	Threading	2 / 33
22 469 ...	Threading	2 / 10	53 009 ...	Threading	2 / 34
22 501 ...	Threading	2 / 8	53 013 ...	Threading	2 / 35
22 503 ...	Threading	2 / 8	53 015 ...	Threading	2 / 31
22 518 ...	Threading	2 / 9	53 050 ...	Threading	2 / 30
22 520 ...	Threading	2 / 9	53 051 ...	Threading	2 / 30
22 550 ...	Threading	2 / 11	53 052 ...	Threading	2 / 24
22 553 ...	Threading	2 / 12	53 053 ...	Threading	2 / 24
22 572 ...	Threading	2 / 15	53 614 ...	Milling	4 / 9
22 582 ...	Threading	2 / 16	53 622 ...	Milling	4 / 8
22 590 ...	Threading	2 / 11	53 632 ...	Milling	4 / 8
22 602 ...	Threading	2 / 17	54 001 ...	Milling	4 / 11
22 606 ...	Threading	2 / 18	54 002 ...	Milling	4 / 11
22 630 ...	Threading	2 / 13	54 005 ...	Milling	4 / 12
22 633 ...	Threading	2 / 14	54 006 ...	Milling	4 / 12
22 635 ...	Threading	2 / 14	54 700 ...	Milling	4 / 16
40 115 ...	Solid drilling and bore machining	1 / 65	54 800 ...	Threading	2 / 25
40 139 ...	Solid drilling and bore machining	1 / 69	54 802 ...	Threading	2 / 25
40 140 ...	Solid drilling and bore machining	1 / 67	54 804 ...	Threading	2 / 25
40 145 ...	Solid drilling and bore machining	1 / 68	54 806 ...	Threading	2 / 26
40 401 ...	Solid drilling and bore machining	1 / 57	54 808 ...	Threading	2 / 26
40 402 ...	Solid drilling and bore machining	1 / 60	54 810 ...	Threading	2 / 26
40 403 ...	Solid drilling and bore machining	1 / 58	54 812 ...	Threading	2 / 27
40 404 ...	Solid drilling and bore machining	1 / 61	54 832 ...	Threading	2 / 28
40 430 ...	Solid drilling and bore machining	1 / 63	70 245 ...	Turning	3 / 15
40 431 ...	Solid drilling and bore machining	1 / 64	70 246 ...	Turning	3 / 26

Article No.	Designation	Page No.	Article No.	Designation	Page No.
70 248 ...	Turning	3 / 15	70 716 ...	Turning	3 / 21
70 254 ...	Turning	3 / 15	70 717 ...	Turning	3 / 21
70 255 ...	Turning	3 / 15	70 718 ...	Turning	3 / 22
70 260 ...	Turning	3 / 25	70 719 ...	Turning	3 / 22
70 261 ...	Turning	3 / 25	70 726 ...	Turning	3 / 47
70 263 ...	Turning	3 / 25	70 727 ...	Turning	3 / 47
70 276 ...	Turning	3 / 36	70 728 ...	Turning	3 / 39
70 280 ...	Turning	3 / 40	70 729 ...	Turning	3 / 39
70 282 ...	Turning	3 / 40	70 730 ...	Turning	3 / 49
70 286 ...	Turning	3 / 179	70 731 ...	Turning	3 / 49
70 287 ...	Turning	3 / 48	70 732 ...	Turning	3 / 34
70 289 ...	Turning	3 / 183	70 733 ...	Turning	3 / 34
70 330 ...	Turning	3 / 218	70 736 ...	Turning	3 / 33
70 331 ...	Turning	3 / 217	70 737 ...	Turning	3 / 33
70 332 ...	Turning	3 / 219	70 738 ...	Turning	3 / 33
70 334 ...	Turning	3 / 220	70 739 ...	Turning	3 / 33
70 338 ...	Turning	3 / 254	70 740 ...	Turning	3 / 34
70 339 ...	Turning	3 / 255	70 741 ...	Turning	3 / 34
70 340 ...	Turning	3 / 256	70 742 ...	Turning	3 / 49
70 342 ...	Turning	3 / 211	70 743 ...	Turning	3 / 49
70 343 ...	Turning	3 / 212	70 744 ...	Turning	3 / 46
70 346 ...	Turning	3 / 210	70 745 ...	Turning	3 / 46
70 349 ...	Turning	3 / 213	70 746 ...	Turning	3 / 46
70 350 ...	Turning	3 / 237	70 747 ...	Turning	3 / 46
70 351 ...	Turning	3 / 225	70 752 ...	Turning	3 / 19
70 352 ...	Turning	3 / 228	70 756 ...	Turning	3 / 17
70 354 ...	Turning	3 / 241	70 757 ...	Turning	3 / 17
70 355 ...	Turning	3 / 248	70 760 ...	Turning	3 / 17
70 356 ...	Turning	3 / 250	70 761 ...	Turning	3 / 17
70 357 ...	Turning	3 / 246	70 766 ...	Turning	3 / 18
70 358 ...	Turning	3 / 247	70 767 ...	Turning	3 / 19
70 359 ...	Turning	3 / 249	70 768 ...	Turning	3 / 38
70 360 ...	Turning	3 / 223	70 769 ...	Turning	3 / 38
70 362 ...	Turning	3 / 226	70 771 ...	Turning	3 / 30
70 363 ...	Turning	3 / 239	70 774 ...	Turning	3 / 31
70 364 ...	Turning	3 / 240	70 780 ...	Turning	3 / 45
70 386 ...	Turning	3 / 179	70 781 ...	Turning	3 / 45
70 540 ...	Turning	3 / 9	70 782 ...	Turning	3 / 38
70 541 ...	Turning	3 / 9	70 784 ...	Turning	3 / 32
70 542 ...	Turning	3 / 12	70 788 ...	Turning	3 / 29
70 543 ...	Turning	3 / 12	70 789 ...	Turning	3 / 29
70 680 ...	Turning	3 / 30	70 792 ...	Turning	3 / 22
70 684 ...	Turning	3 / 28	70 793 ...	Turning	3 / 22
70 685 ...	Turning	3 / 28	70 800 ...	Turning	3 / 177
70 690 ...	Turning	3 / 44	70 801 ...	Turning	3 / 178
70 691 ...	Turning	3 / 44	70 804 ...	Turning	3 / 176
70 692 ...	Turning	3 / 44	70 805 ...	Turning	3 / 176
70 694 ...	Turning	3 / 43	70 820 ...	Turning	3 / 185
70 695 ...	Turning	3 / 43	70 821 ...	Turning	3 / 185
70 696 ...	Turning	3 / 43	70 836 ...	Turning	3 / 222
70 697 ...	Turning	3 / 43	70 837 ...	Turning	3 / 222
70 698 ...	Turning	3 / 9	70 842 ...	Turning	3 / 233
70 699 ...	Turning	3 / 9	70 843 ...	Turning	3 / 234

Article No.	Designation	Page No.	Article No.	Designation	Page No.
70 844 ...	Turning	3 / 244	71 272 ...	Threading	2 / 65
70 845 ...	Turning	3 / 245	71 273 ...	Threading	2 / 66
70 846 ...	Turning	3 / 216	71 274 ...	Threading	2 / 65
70 847 ...	Turning	3 / 215	71 280 ...	Threading	2 / 61
70 850 ...	Turning	3 / 259	71 281 ...	Threading	2 / 61
70 851 ...	Turning	3 / 259	71 282 ...	Threading	2 / 69
70 854 ...	Turning	3 / 260	71 283 ...	Threading	2 / 62
70 855 ...	Turning	3 / 260	71 284 ...	Threading	2 / 48
70 856 ...	Turning	3 / 253	71 285 ...	Threading	2 / 48
70 857 ...	Turning	3 / 253	71 286 ...	Threading	2 / 47
70 858 ...	Turning	3 / 235	71 287 ...	Threading	2 / 47
70 859 ...	Turning	3 / 235	71 300 ...	Turning	3 / 16
70 862 ...	Turning	3 / 232	71 301 ...	Turning	3 / 16
70 863 ...	Turning	3 / 232	71 302 ...	Turning	3 / 16
70 865 ...	Turning	3 / 231	71 305 ...	Turning	3 / 16
70 866 ...	Turning	3 / 231	71 306 ...	Turning	3 / 16
70 867 ...	Turning	3 / 243	71 310 ...	Turning	3 / 27
70 868 ...	Turning	3 / 243	71 311 ...	Turning	3 / 27
70 870 ...	Turning	3 / 230	71 312 ...	Turning	3 / 27
70 871 ...	Turning	3 / 230	71 325 ...	Turning	3 / 37
70 872 ...	Turning	3 / 251	71 326 ...	Turning	3 / 37
70 873 ...	Turning	3 / 257	71 330 ...	Turning	3 / 42
70 874 ...	Turning	3 / 258	71 331 ...	Turning	3 / 42
70 875 ...	Turning	3 / 221	71 332 ...	Turning	3 / 42
70 876 ...	Turning	3 / 221	71 950 ...	Threading	2 / 70
70 882 ...	Turning	3 / 252	72 300 ...	Turning	3 / 127
70 883 ...	Turning	3 / 252	72 301 ...	Turning	3 / 131
70 896 ...	Turning	3 / 214	72 302 ...	Turning	3 / 127
70 897 ...	Turning	3 / 214	72 304 ...	Turning	3 / 130
71 140 ...	Turning	3 / 37	72 305 ...	Turning	3 / 131
71 154 ...	Turning	3 / 48	72 306 ...	Turning	3 / 130
71 184 ...	Turning	3 / 37	72 307 ...	Turning	3 / 132
71 200 ...	Threading	2 / 59	72 308 ...	Turning	3 / 128
71 202 ...	Threading	2 / 59	72 309 ...	Turning	3 / 128
71 203 ...	Threading	2 / 60	72 310 ...	Turning	3 / 127
71 204 ...	Threading	2 / 60	72 311 ...	Turning	3 / 127
71 206 ...	Threading	2 / 57	72 312 ...	Turning	3 / 129
71 208 ...	Threading	2 / 57	72 313 ...	Turning	3 / 129
71 210 ...	Threading	2 / 58	72 314 ...	Turning	3 / 128
71 212 ...	Threading	2 / 58	72 315 ...	Turning	3 / 128
71 220 ...	Threading	2 / 43	72 316 ...	Turning	3 / 129
71 222 ...	Threading	2 / 44	72 317 ...	Turning	3 / 129
71 224 ...	Threading	2 / 45	72 319 ...	Turning	3 / 132
71 226 ...	Threading	2 / 46	72 320 ...	Turning	3 / 132
71 228 ...	Threading	2 / 49	72 350 ...	Turning	3 / 20
71 229 ...	Threading	2 / 50	72 351 ...	Turning	3 / 20
71 230 ...	Threading	2 / 51	72 352 ...	Turning	3 / 20
71 231 ...	Threading	2 / 52	72 353 ...	Turning	3 / 20
71 264 ...	Threading	2 / 53	72 356 ...	Turning	3 / 28
71 266 ...	Threading	2 / 54	72 357 ...	Turning	3 / 28
71 268 ...	Threading	2 / 55	72 360 ...	Turning	3 / 54
71 270 ...	Threading	2 / 56	72 361 ...	Turning	3 / 54
71 271 ...	Threading	2 / 64	72 362 ...	Turning	3 / 55

Article No.	Designation	Page No.	Article No.	Designation	Page No.
72 363 ...	Turning	3 / 55	72 499 ...	Turning	3 / 110
72 364 ...	Turning	3 / 55	72 500 ...	Turning	3 / 111
72 365 ...	Turning	3 / 55	72 501 ...	Turning	3 / 111
72 380 ...	Turning	3 / 53	72 504 ...	Turning	3 / 111
72 382 ...	Turning	3 / 53	72 505 ...	Turning	3 / 111
72 384 ...	Turning	3 / 53	72 506 ...	Turning	3 / 111
72 386 ...	Turning	3 / 53	72 507 ...	Turning	3 / 111
72 388 ...	Turning	3 / 54	72 510 ...	Turning	3 / 116
72 390 ...	Turning	3 / 54	72 511 ...	Turning	3 / 116
72 400 ...	Turning	3 / 25	72 512 ...	Turning	3 / 116
72 401 ...	Turning	3 / 8	72 513 ...	Turning	3 / 116
72 402 ...	Turning	3 / 51	72 514 ...	Turning	3 / 109
72 403 ...	Turning	3 / 51	72 515 ...	Turning	3 / 109
72 404 ...	Turning	3 / 51	72 516 ...	Turning	3 / 115
72 405 ...	Turning	3 / 51	72 517 ...	Turning	3 / 115
72 412 ...	Turning	3 / 126	72 518 ...	Turning	3 / 115
72 414 ...	Turning	3 / 126	72 519 ...	Turning	3 / 115
72 416 ...	Turning	3 / 106	72 520 ...	Turning	3 / 112
72 418 ...	Turning	3 / 106	72 521 ...	Turning	3 / 112
72 420 ...	Turning	3 / 106	72 526 ...	Turning	3 / 122
72 422 ...	Turning	3 / 106	72 527 ...	Turning	3 / 122
72 424 ...	Turning	3 / 107	72 528 ...	Turning	3 / 123
72 426 ...	Turning	3 / 107	72 529 ...	Turning	3 / 123
72 428 ...	Turning	3 / 107	72 530 ...	Turning	3 / 121
72 430 ...	Turning	3 / 107	72 531 ...	Turning	3 / 121
72 432 ...	Turning	3 / 107	72 560 ...	Turning	3 / 113
72 434 ...	Turning	3 / 107	72 561 ...	Turning	3 / 113
72 436 ...	Turning	3 / 108	72 562 ...	Turning	3 / 113
72 438 ...	Turning	3 / 108	72 563 ...	Turning	3 / 113
72 440 ...	Turning	3 / 108	72 800 ...	Turning	3 / 60
72 442 ...	Turning	3 / 108	72 801 ...	Turning	3 / 60
72 444 ...	Turning	3 / 112	72 802 ...	Turning	3 / 59
72 446 ...	Turning	3 / 112	72 803 ...	Turning	3 / 59
72 456 ...	Turning	3 / 114	72 804 ...	Turning	3 / 60
72 457 ...	Turning	3 / 114	72 805 ...	Turning	3 / 60
72 464 ...	Turning	3 / 117	72 808 ...	Turning	3 / 57
72 466 ...	Turning	3 / 117	72 809 ...	Turning	3 / 57
72 468 ...	Turning	3 / 118	72 810 ...	Turning	3 / 57
72 470 ...	Turning	3 / 118	72 811 ...	Turning	3 / 58
72 472 ...	Turning	3 / 120	72 812 ...	Turning	3 / 59
72 474 ...	Turning	3 / 120	72 813 ...	Turning	3 / 59
72 476 ...	Turning	3 / 119	72 814 ...	Turning	3 / 58
72 478 ...	Turning	3 / 119	72 840 ...	Turning	3 / 61
72 480 ...	Turning	3 / 124	72 841 ...	Turning	3 / 61
72 482 ...	Turning	3 / 124	72 900 ...	Milling	4 / 17
72 484 ...	Turning	3 / 125	72 930 ...	Milling	4 / 18
72 486 ...	Turning	3 / 125	72 950 ...	Turning	3 / 101
72 492 ...	Turning	3 / 52	72 951 ...	Turning	3 / 68
72 493 ...	Turning	3 / 52	72 952 ...	Turning	3 / 64
72 494 ...	Turning	3 / 8	72 953 ...	Turning	3 / 68
72 496 ...	Turning	3 / 110	72 954 ...	Turning	3 / 65
72 497 ...	Turning	3 / 110	72 955 ...	Turning	3 / 66
72 498 ...	Turning	3 / 110	72 956 ...	Turning	3 / 66

Article No.	Designation	Page No.	Article No.	Designation	Page No.
72 957 ...	Turning	3 / 91	73 059 ...	Turning	3 / 311
72 958 ...	Turning	3 / 67	73 060 ...	Turning	3 / 312
72 981 ...	Turning	3 / 69	73 061 ...	Turning	3 / 312
72 982 ...	Turning	3 / 74	73 080 ...	Turning	3 / 315
72 983 ...	Turning	3 / 75	73 081 ...	Turning	3 / 318
72 984 ...	Turning	3 / 77	73 083 ...	Turning	3 / 319
72 985 ...	Turning	3 / 100	73 084 ...	Turning	3 / 319
72 986 ...	Turning	3 / 73	73 086 ...	Turning	3 / 319
72 987 ...	Turning	3 / 101	73 088 ...	Turning	3 / 317
72 988 ...	Turning	3 / 102	73 089 ...	Turning	3 / 316
72 989 ...	Turning	3 / 101	73 090 ...	Turning	3 / 320
72 990 ...	Turning	3 / 102	73 091 ...	Turning	3 / 320
72 991 ...	Turning	3 / 101	73 100 ...	Turning	3 / 304
72 992 ...	Turning	3 / 102	73 101 ...	Turning	3 / 304
72 993 ...	Turning	3 / 102	73 102 ...	Turning	3 / 306
72 994 ...	Turning	3 / 102	73 103 ...	Turning	3 / 306
72 995 ...	Turning	3 / 76	73 104 ...	Turning	3 / 307
72 996 ...	Turning	3 / 103	73 105 ...	Turning	3 / 307
73 000 ...	Turning	3 / 295	73 202 ...	Turning	3 / 301
73 001 ...	Turning	3 / 295	73 203 ...	Turning	3 / 301
73 002 ...	Turning	3 / 299	73 206 ...	Turning	3 / 307
73 003 ...	Turning	3 / 299	73 207 ...	Turning	3 / 307
73 004 ...	Turning	3 / 291	73 208 ...	Turning	3 / 305
73 005 ...	Turning	3 / 291	73 209 ...	Turning	3 / 305
73 006 ...	Turning	3 / 298	73 210 ...	Turning	3 / 308
73 007 ...	Turning	3 / 298	73 211 ...	Turning	3 / 308
73 008 ...	Turning	3 / 298	73 252 ...	Turning	3 / 310
73 009 ...	Turning	3 / 298	73 253 ...	Turning	3 / 310
73 010 ...	Turning	3 / 302	73 256 ...	Turning	3 / 314
73 011 ...	Turning	3 / 302	73 257 ...	Turning	3 / 314
73 012 ...	Turning	3 / 297	73 260 ...	Turning	3 / 312
73 013 ...	Turning	3 / 297	73 261 ...	Turning	3 / 312
73 014 ...	Turning	3 / 296	73 262 ...	Turning	3 / 313
73 015 ...	Turning	3 / 296	73 263 ...	Turning	3 / 313
73 016 ...	Turning	3 / 293	73 310 ...	Turning	3 / 325
73 017 ...	Turning	3 / 293	73 312 ...	Turning	3 / 325
73 018 ...	Turning	3 / 303	73 314 ...	Turning	3 / 322
73 019 ...	Turning	3 / 303	73 316 ...	Turning	3 / 322
73 020 ...	Turning	3 / 292	73 318 ...	Turning	3 / 328
73 021 ...	Turning	3 / 292	73 320 ...	Turning	3 / 328
73 022 ...	Turning	3 / 292	73 322 ...	Turning	3 / 321
73 023 ...	Turning	3 / 292	73 324 ...	Turning	3 / 321
73 026 ...	Turning	3 / 294	73 326 ...	Turning	3 / 327
73 027 ...	Turning	3 / 294	73 328 ...	Turning	3 / 327
73 050 ...	Turning	3 / 309	73 330 ...	Turning	3 / 323
73 051 ...	Turning	3 / 309	73 332 ...	Turning	3 / 323
73 052 ...	Turning	3 / 309	73 334 ...	Turning	3 / 323
73 053 ...	Turning	3 / 309	73 336 ...	Turning	3 / 323
73 054 ...	Turning	3 / 314	73 338 ...	Turning	3 / 324
73 055 ...	Turning	3 / 314	73 340 ...	Turning	3 / 324
73 056 ...	Turning	3 / 314	73 342 ...	Turning	3 / 329
73 057 ...	Turning	3 / 314	73 344 ...	Turning	3 / 329
73 058 ...	Turning	3 / 311	73 346 ...	Turning	3 / 330

Article No.	Designation	Page No.	Article No.	Designation	Page No.
73 348 ...	Turning	3 / 330	76 274 ...	Turning	3 / 35
73 350 ...	Turning	3 / 331	76 275 ...	Turning	3 / 35
73 352 ...	Turning	3 / 331	76 277 ...	Turning	3 / 40
73 358 ...	Turning	3 / 333	76 284 ...	Turning	3 / 35
73 360 ...	Turning	3 / 333	76 285 ...	Turning	3 / 40
73 362 ...	Turning	3 / 332	76 288 ...	Turning	3 / 40
73 364 ...	Turning	3 / 332	81 000 ...	Clamping technology	5 / 4
73 370 ...	Turning	3 / 326	81 001 ...	Clamping technology	5 / 15
73 372 ...	Turning	3 / 326	81 002 ...	Clamping technology	5 / 4
73 374 ...	Turning	3 / 332	81 003 ...	Clamping technology	5 / 5
73 376 ...	Turning	3 / 332	81 004 ...	Clamping technology	5 / 15
73 382 ...	Turning	3 / 326	81 005 ...	Clamping technology	5 / 5
73 384 ...	Turning	3 / 326	81 006 ...	Clamping technology	5 / 15
73 386 ...	Turning	3 / 321	81 007 ...	Clamping technology	5 / 7
73 388 ...	Turning	3 / 321	81 008 ...	Clamping technology	5 / 17
73 520 ...	Turning	3 / 335	81 009 ...	Clamping technology	5 / 7
73 522 ...	Turning	3 / 334	81 010 ...	Clamping technology	5 / 17
73 523 ...	Turning	3 / 337	81 011 ...	Clamping technology	5 / 8
73 524 ...	Turning	3 / 337	81 012 ...	Clamping technology	5 / 16
73 525 ...	Turning	3 / 336	81 013 ...	Clamping technology	5 / 8
73 526 ...	Turning	3 / 336	81 014 ...	Clamping technology	5 / 16
75 013 ...	Turning	3 / 8	81 015 ...	Clamping technology	5 / 9
75 014 ...	Turning	3 / 8	81 016 ...	Clamping technology	5 / 18
75 024 ...	Turning	3 / 11	81 017 ...	Clamping technology	5 / 9
75 025 ...	Turning	3 / 11	81 018 ...	Clamping technology	5 / 18
75 026 ...	Turning	3 / 11	81 019 ...	Clamping technology	5 / 6
75 210 ...	Turning	3 / 14	81 020 ...	Clamping technology	5 / 16
75 211 ...	Turning	3 / 14	81 021 ...	Clamping technology	5 / 6
75 213 ...	Turning	3 / 24	81 022 ...	Clamping technology	5 / 16
75 214 ...	Turning	3 / 24	81 023 ...	Clamping technology	5 / 11
75 217 ...	Turning	3 / 35	81 024 ...	Clamping technology	5 / 19
75 218 ...	Turning	3 / 35	81 025 ...	Clamping technology	5 / 11
76 134 ...	Turning	3 / 7	81 026 ...	Clamping technology	5 / 8
76 136 ...	Turning	3 / 7	81 027 ...	Clamping technology	5 / 9
76 139 ...	Turning	3 / 10	81 028 ...	Clamping technology	5 / 11
76 157 ...	Turning	3 / 10	81 029 ...	Clamping technology	5 / 9
76 195 ...	Turning	3 / 24	81 030 ...	Clamping technology	5 / 11
76 243 ...	Turning	3 / 15	81 031 ...	Clamping technology	5 / 5
76 249 ...	Turning	3 / 13	81 032 ...	Clamping technology	5 / 23
76 250 ...	Turning	3 / 13	81 033 ...	Clamping technology	5 / 24
76 251 ...	Turning	3 / 13	81 034 ...	Clamping technology	5 / 22
76 252 ...	Turning	3 / 14	81 035 ...	Clamping technology	5 / 21
76 253 ...	Turning	3 / 13	81 036 ...	Clamping technology	5 / 26
76 254 ...	Turning	3 / 26	81 037 ...	Clamping technology	5 / 25
76 255 ...	Turning	3 / 41	81 038 ...	Clamping technology	5 / 25
76 256 ...	Turning	3 / 24	81 039 ...	Clamping technology	5 / 25
76 257 ...	Turning	3 / 23	81 040 ...	Clamping technology	5 / 27
76 258 ...	Turning	3 / 24	81 041 ...	Clamping technology	5 / 28
76 259 ...	Turning	3 / 23	81 042 ...	Clamping technology	5 / 28
76 263 ...	Turning	3 / 7	81 043 ...	Clamping technology	5 / 32
76 265 ...	Turning	3 / 23	81 044 ...	Clamping technology	5 / 32
76 270 ...	Turning	3 / 35	81 045 ...	Clamping technology	5 / 33
76 273 ...	Turning	3 / 10	81 046 ...	Clamping technology	5 / 33

ISO designation system

ISO attribute	Feature Description
A	
ADJRG	Adjustment range
ADJRGR	Adjustment range radial
ALP	Clearance angle axial
AN	Clearance angle major
APMX	Depth of cut maximum
B	
B	Shank width
BD	Body diameter
BD_1	Body diameter, 1st cutting step
BD_2	Body diameter, 2nd cutting step
BD_3	Body diameter, 3rd cutting step
BD_4	Body diameter, 4th cutting step
BDRED	Body diameter, reduced
BDX	Body diameter maximum
BHTA	Body half taper angle
BN	Face land width
BS	Wiper edge length
BTED	Body taper end diameter
C	
CDX	Cutting depth maximum
CF	Central flat
CHW	Corner chamfer width
CHWTL	Flank chamfer width left hand
CLDIS_1	centre line distance 1
CLDIS_2	centre line distance 2
CLDIS_3	centre line distance 3
CND	Coolant entry diameter
CNT	Coolant entry, thread size
CODX	Parting off diameter, max.
CRE	Spot radius
CRKS	Pull stud thread size
CW	Cutting width
CXD	Coolant exit diameter
D	
D1	Fixing hole diameter
DAXN	Axial groove outside diameter minimum
DAXX	Axial groove outside diameter maximum
DC	Cutting diameter
DC_1	Cutting diameter, 1st cutting step
DC_2	Cutting diameter, 2nd cutting step
DCD	Cutting diameter drilling part
DCINTF	Interference cutting diameter
DCN	Cutting diameter minimum
DCONMS	Mounting spigot diameter
DCONWS	Connection diameter workpiece side
DCONWS_1	Connection diameter workpiece side – 1
DCONWS_2	Connection diameter workpiece side – 2
DCSKX	Countersunk diameter, max
DCX	Cutting diameter maximum
DF	Flange diameter
DFC	Functional diameter
DHUB	Hub diameter
DLN	Diameter lock nut
DMIN	Minimum bore diameter
DN	Neck Diameter
DRVS	Drive size

ISO attribute	Feature Description
G	
GAN	Insert rake angle
GB	Face land angle
H	
H	Shank height
HDD	Head diameter
HDW	head width
HF	Functional height
HLN	Lock nut height
HSUP	Support height
I	
IC	Inscribed circle diameter
IH	Insert hand
INSL	Insert length
K	
KAPR	Tool cutting edge angle
KCH	Corner chamfer angle
L	
L	Cutting edge length
L_1	Cutting edge length 1
L_2	Cutting edge length 2
L_3	Cutting edge length 3
LB	Body length
LB_1	Body length 1
LB_2	Body length 2
LCF	Length chip flute
LCOL	Collet length
LDRED	Reduced body diameter length
LE	Cutting edge effective length
LF	Functional length
LF_1	Functional length 1
LF_2	Functional length 2
LF_3	Functional length 3
LFSF	Distance to face
LH	Head length
LPCON	Connection protruding length
LPR	Protruding length
LS	Shank length
LSC	Clamping length machine side
LSCN	Clamping length minimum machine side
LSCX	Clamping length maximum machine side
LTA	length tool assembly
LU	Usable length
LUX	Usable length maximum
M	
MXC_R	Clamping force maximum
N	
NOF	Flute count
NT	Tooth count
O	
OAH	Overall height
OAL	Overall length
OAW	Overall width

Continued on next page

ISO designation system

ISO attribute	Feature Description
P	
PDPT	Profile depth insert
PDX	Profile distance ex
PDY	Profile distance ey
PHD	Premachined hole diameter
PL	Point length
PLGL	Plug length
PNA	Profile included angle
PRFA	Profile angle
PRFRAD	Profile radius
PRFRAD1	Profile radius 1
PRFRAD2	Profile radius 2
PRFRAD3	Profile radius 3
PSIR	Tool lead angle
R	
RA	Relief angle
RADH	Radial height
RADW	Radial width
RADWOF	Radial offset width
RAR	Relief angle rh
RCSK	Radius countersunk
RE	Corner radius
RE_1	Corner radius 1
RE_2	Corner radius 2
RE_3	Corner radius 3
REL	Corner radius left hand
RETL	Flank radius left hand
RETR	Flank radius right hand
RPMX	Rotational speed maximum
S	
S	Insert thickness
S1	Insert thickness total
SD	Step distance
SDL	Step diameter length
SDL_1	Step diameter length 1
SDL_2	Step diameter length 2
SZID	nominal size
T	
THID	Thread designation inside
THL	Thread cutting part length
THOD	Thread designation outside
THSZMS	Connection thread nominal size
THSZWS	Connection thread nominal size workpiece side
TP	Thread pitch
TPI	Threads per inch
TQX	Torque maximum
W	
W1	Insert width
WF	Functional width
WF2	Functional width 2
WT	Weight of item
Z	
ZEFP	Peripheral effective cutting edge count
ZNF	Face mounted insert count
ZNP	Peripheral mounted insert count



DRAGONSKIN

The coatings for the highest performance

Find out more at:
cutting.tools/en/dragonskin