

New products for machining technicians

NEW WOEX indexable inserts



BK7710 -11

- ▲ Specialist in the machining of non-ferrous metals
- ▲ Extended application range also for heat-resistant and hardened materials

→ Page 49

NEW SOGX indexable inserts



BK8430 -21

- ▲ Highly positive and soft-cutting topography
- ▲ Universal applicable and high wear-resistance grade
- ▲ Can be used for centre and periphery



BK7935 -21

- ▲ Highly positive and soft-cutting topography
- ▲ Tougher grade, particularly suitable for machining stainless and acid-resistant steels as well as special alloys
- ▲ Recommended only for the peripheral insert

→ Page 30



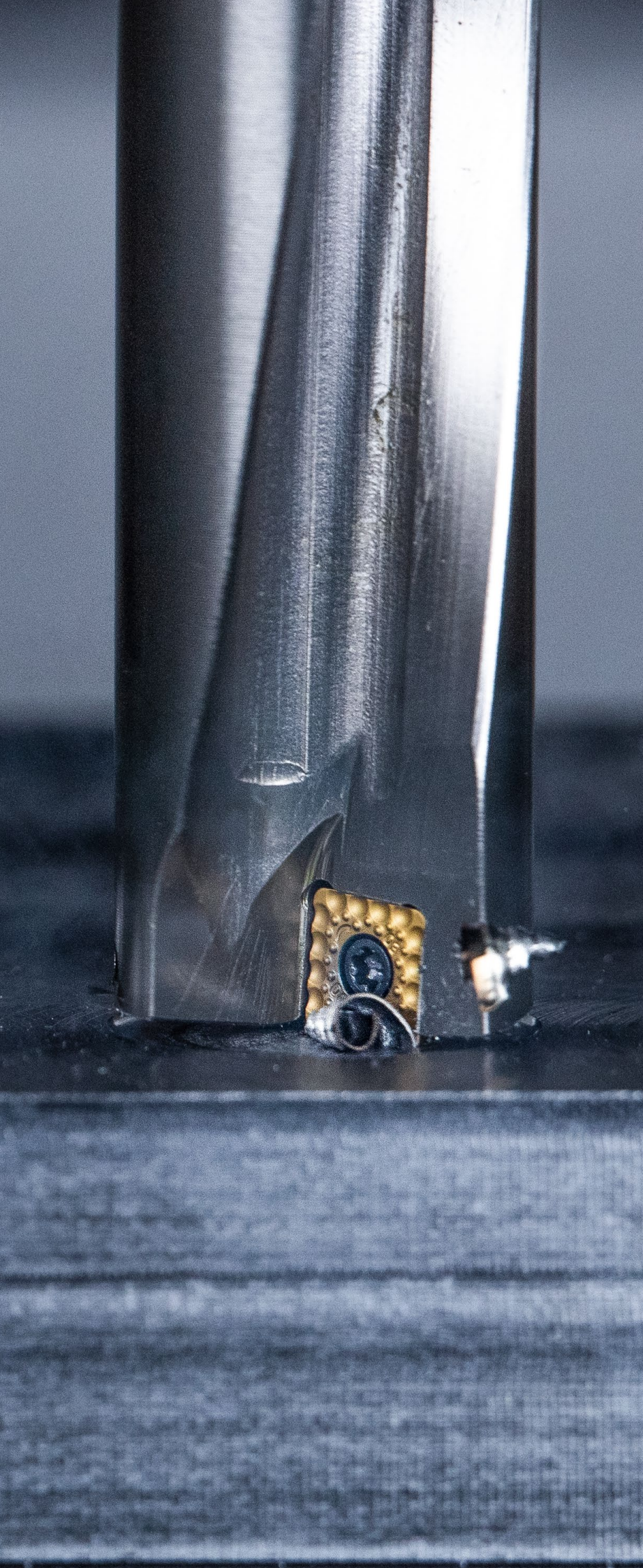

Solid drilling and bore machining

1 HSS drilling

2 Solid carbide drilling

3 Indexable insert drilling

4 Reaming and Countersinking

5 Spindle Tooling

Threading

6 Taps and thread formers

7 Circular and Thread Milling

8 Thread turning

Turning

9 Turning Tools

10 Multifunctional Tools –
EcoCut and FreeTurn

11 Grooving Tools

12 Miniature turning tools

Milling

13 HSS Milling Cutters

14 Solid Carbide milling cutters

15 Milling tools with indexable inserts

Clamping technology

16 Adaptors and Accessories

17 Workpiece clamping

18 Material examples

List of contents

Symbol explanation	4
Application tips – eccentric sleeves	5
Toolfinder	6+7
Product programme	8–60
Technical Information	
Cutting Data	61–77
Maximum Offset Range	78–80
Coding example, coolant supply	81
Indexable insert drilling – problems / possible causes / solutions	82
KUB Centron – drilling instructions + problems / possible causes / solutions	83+84
Overview of grades and chip breakers, application	85–87

KOMET \ Performance

Premium quality tools for high performance.

The premium quality tools from the **KOMET Performance** product line have been designed for specific applications and are distinguished by their outstanding performance. If you make high demands on the performance of your production and want to achieve the very best results, we recommend the Premium tools in this product line.

KOMET \ Standard

Quality tools for standard applications.

The quality tools of the **KOMET Standard** product line are high quality, high performance, reliable and enjoy the highest level of trust among our customers worldwide. Tools from this product line are the first choice for many standard applications and guarantee optimal results.

Symbol explanation

Shank

- C** Cylindrical shank with clamping flat
Guarantees optimum clamping of the tool and can be clamped in every standard adapter
- K** Drill with combi shank
This drill shank has two clamping flats (DIN 6535HE, DIN 6595) that guarantee pull-out protection and good face contact of the drill. Both Weldon and Whistle Notch adapters can be used.
- ABS** Drill with ABS connection.
The ABS connection by Komet is a modular coupling system for rotating tools and stationary tools, and offers a number of advantages, such as improved force transmission.
Technical information and spare parts
→ Chapter 16 Adapters and accessories, page 301.
- PSC** Drill with polygonal shank
The polygonal shank offers the best rigidity during the transmission of force from the drill to the adapter.
The tapered polygonal shape easily absorbs torsional forces and bending forces

Version

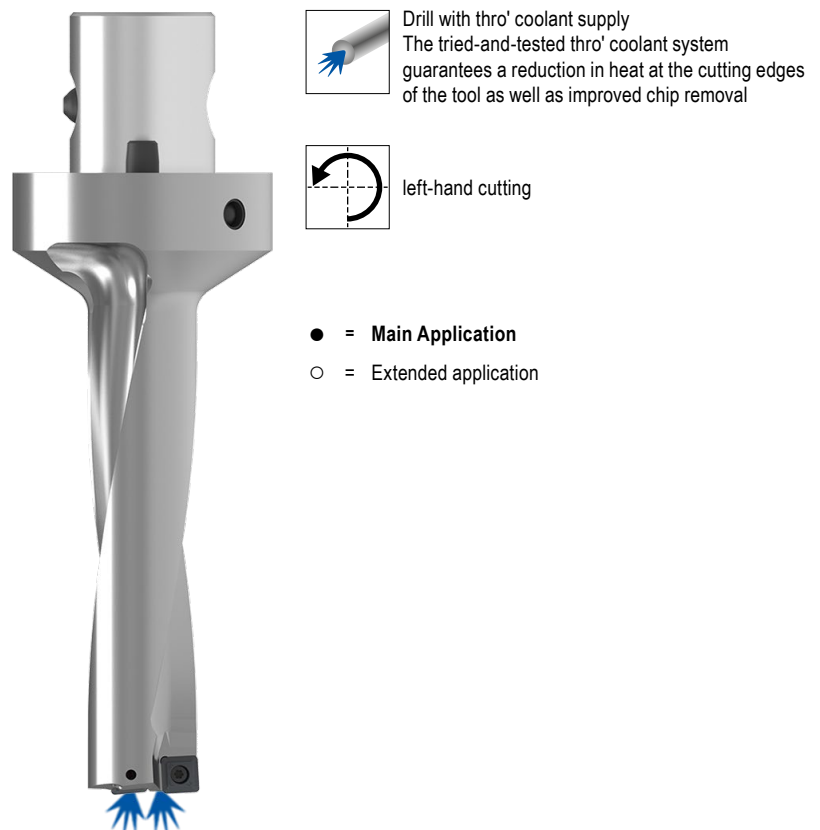

Application tips – eccentric sleeves

Using eccentric sleeves, the diameter of the hole can be varied and adjusted by +/- 0.3 mm with ease.

Two types of eccentric sleeve are available:

One for use with the indexable insert drill adapter and one for use with a Weldon adapter.

The difference lies solely in the design and position of the slots for the adapter's clamping screws.

There are four sizes per type, which are tailored to the shank diameter.



Eccentric sleeve for indexable insert drill adapter

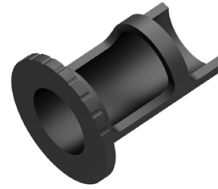

Eccentric sleeve for Weldon adapter

Designation		Page No.
Eccentric sleeves for indexable insert drill adapters		58+59
Eccentric sleeves for Weldon adapters		58+59

Designation		Page No.
Adjuster with ABS connection		60

Adapters can be found in → **Chapter 16 Adapters and accessoires in the clamping technology catalogue**

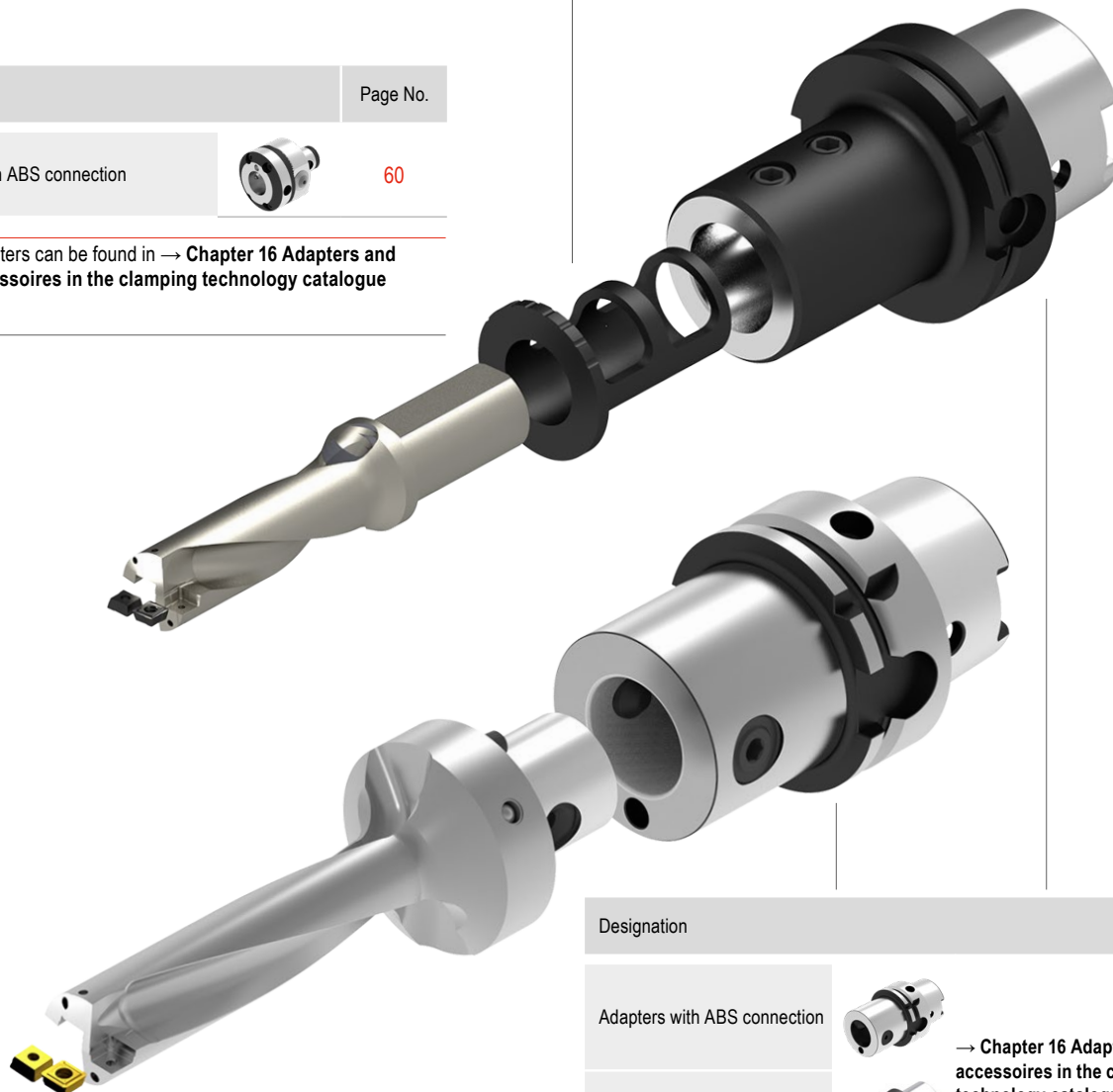

Designation	
Adapters with ABS connection	→ Chapter 16 Adapters and accessoires in the clamping technology catalogue
Indexable insert drill adapter	

Toolfinder

KUB Pentron
KOMET \ Performance



- ▲ High-performance indexable insert drill for process-secure drilling under a wide range of conditions
- ▲ Ideal for extreme machining situations

	Boring depth	Solid drilling	Boring	Drilling through a transverse hole	Stack plate drilling	Spot drilling uneven surfaces	Spot drilling an edge	Spot drilling convex surfaces	Angled hole entrance	Spot drilling pointed contours	Chain drilling	Drilling through a centre or pre-op
2xD	●	○	●	●	●	●	●	●	●	●	●	●
3xD	●	○	●	●	●	●	●	●	●	●	●	●
4xD	●	-	●	●	○	●	●	●	●	●	○	●
5xD	●	-	●	○	○	●	○	●	○	-	○	○

KUB Pentron CS
KOMET \ Performance



- ▲ Process-secure, reliable, modular system for creating large holes with a diameter of up to 96.00 mm

	Boring depth	Solid drilling	Boring	Drilling through a transverse hole	Stack plate drilling	Spot drilling uneven surfaces	Spot drilling an edge	Spot drilling convex surfaces	Angled hole entrance	Spot drilling pointed contours	Chain drilling	Drilling through a centre or pre-op
3xD	●	-	●	○	●	●	●	●	●	●	●	●

KUB Trigon
KOMET \ Performance

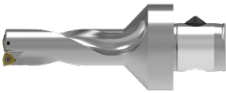

- ▲ Ideal for machining under unstable conditions
- ▲ Well-suited to machining on less powerful machines
- ▲ The first choice for creating dimensionally accurate holes

	Boring depth	Solid drilling	Boring	Drilling through a transverse hole	Stack plate drilling	Spot drilling uneven surfaces	Spot drilling an edge	Spot drilling convex surfaces	Angled hole entrance	Spot drilling pointed contours	Chain drilling	Drilling through a centre or pre-op
2xD	●	●	●	-	●	○	●	●	○	●	○	○
3xD	●	●	●	-	●	○	●	●	○	●	○	○
4xD	●	-	○	-	○	-	○	○	-	○	○	○

KUB Centron
KOMET \ Performance



- ▲ Cost-effective and process-secure drilling
- ▲ Hole depths up to 9xD in virtually all materials
- ▲ HSS or solid carbide centring tip for optimum positioning accuracy













	Boring depth	Solid drilling	Boring	Drilling through a transverse hole	Stack plate drilling	Spot drilling uneven surfaces	Spot drilling an edge	Spot drilling convex surfaces	Angled hole entrance	Spot drilling pointed contours	Chain drilling	Drilling through a centre or pre-op
4xD	●	-	○	-	●	-	○	-	-	○	●	○
6xD	●	-	○	-	●	-	○	-	-	○	●	○
9xD	●	-	○	-	●	-	○	-	-	○	●	○

MaxiDrill 900
KOMET \ Standard



- ▲ Provides perfect drilling quality even under enormous loads
- ▲ Ideal for large drilling depths: The high feed rates increase productivity
- ▲ For stable machining situations

	Boring depth	Solid drilling	Boring	Drilling through a transverse hole	Stack plate drilling	Spot drilling uneven surfaces	Spot drilling an edge	Spot drilling convex surfaces	Angled hole entrance	Spot drilling pointed contours	Chain drilling	Drilling through a centre or pre-op
2xD	●	○	●	●	●	●	●	●	●	○	●	○
3xD	●	○	●	○	○	●	●	●	●	○	●	○
4xD	●	○	●	○	○	○	○	○	○	○	○	○
5xD	●	○	●	○	○	○	○	○	○	○	○	○

Shank	Diameter Ø DC	Direction of cut	Tool holder Page No.	Insert type	No. of cutting edges	Material compatibility								Inserts Page No.			
						Steel P	Stainless steel M	Cast iron K	Non-ferrous metals N	Heat-resistant S	Tempered steel H	Non-metal materials O					
ABS	14-65	R	8+9														
C	14-46	R	18+19														
ABS	14-65	R	10+11														
PSC	14-37	R	16+17														
C	14-46	R	20+21	 SOGX	4									29+30			
ABS	14-46	R	12+13			→ v. Page 62-67											
C	14-46	R	22+23														
ABS	14-46	R	14+15														
C	14-46	R	24+25														
ABS	64-96	R	26-28			 SOGX	4									29+30	
								→ v. Page 62-67									
ABS	14-82	R	31-33			 WOEX	3									48-49	
ABS	14-44	L	34														
K	14-44	R	40														
ABS	14-82	R	35-37														
ABS	14-44	L	38														
K	14-44	R	41														
ABS	14-44	R	39														
K	14-35	R	42														
ABS	20-81	R		 WOEX	3									48-49			
ABS	20-81	R	43														
				 KUB Centron – centring tips	5-12 mm									47			
						→ v. Page 72+73											
				 KUB Centron – drill bits	20-81 mm									44-47			
ABS	20-81	R															
C	12-63	R	50+51	 SONT	2/4									57			
C	12-63	R	52+53														
C	12-54	R	54-55														
C	12-41	R	56														

 Further information on grades and chip breakers can be found on → page 85 + 86.

KUB Pentron – Indexable insert drill

Scope of supply:

Indexable Insert Drill incl. clamping screws

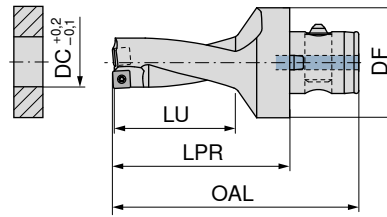
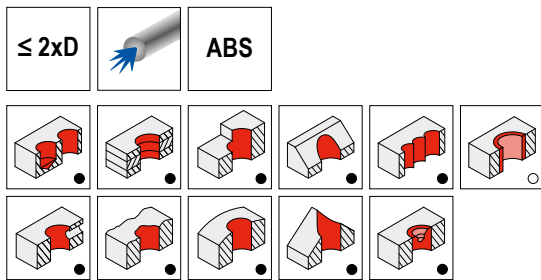

10 872 ...

Designation	KOMET no.	DC mm	DF mm	OAL mm	LU mm	LPR mm	torque moment Nm	Insert	10 872 ...	
									£	2B/6#
KUB-P.2D.140.R.04-ABS50	U42 51400	14	50	86	28	55	0,38	SOGX 040204	419.06	14095
KUB-P.2D.145.R.04-ABS50	U42 51450	14.5	50	89	30	58	0,38	SOGX 040204	419.06	14595
KUB-P.2D.150.R.04-ABS50	U42 51500	15	50	89	30	58	0,38	SOGX 040204	419.06	15095
KUB-P.2D.155.R.04-ABS50	U42 51550	15.5	50	93	32	62	0,38	SOGX 040204	419.06	15595
KUB-P.2D.160.R.04-ABS50	U42 51600	16	50	93	32	62	0,38	SOGX 040204	419.06	16095
KUB-P.2D.165.R.05-ABS50	U42 51650	16.5	50	96	34	65	0,62	SOGX 050204	427.13	16595
KUB-P.2D.170.R.05-ABS50	U42 51700	17	50	96	34	65	0,62	SOGX 050204	427.13	17095
KUB-P.2D.175.R.05-ABS50	U42 51750	17.5	50	98	36	67	0,62	SOGX 050204	427.13	17595
KUB-P.2D.180.R.05-ABS50	U42 51800	18	50	98	36	67	0,62	SOGX 050204	427.13	18095
KUB-P.2D.185.R.06-ABS50	U42 51850	18.5	50	101	38	70	1,01	SOGX 060206	439.70	18595
KUB-P.2D.190.R.06-ABS50	U42 51900	19	50	101	38	70	1,01	SOGX 060206	439.70	19095
KUB-P.2D.195.R.06-ABS50	U42 51950	19.5	50	103	40	72	1,01	SOGX 060206	439.70	19595
KUB-P.2D.200.R.06-ABS50	U42 52000	20	50	103	40	72	1,01	SOGX 060206	439.70	20095
KUB-P.2D.205.R.07-ABS50	U42 52050	20.5	50	105	42	74	1,01	SOGX 07T208	454.60	20595
KUB-P.2D.210.R.07-ABS50	U42 52100	21	50	105	42	74	1,01	SOGX 07T208	454.60	21095
KUB-P.2D.215.R.07-ABS50	U42 52150	21.5	50	107	44	76	1,01	SOGX 07T208	454.60	21595
KUB-P.2D.220.R.07-ABS50	U42 52200	22	50	107	44	76	1,01	SOGX 07T208	454.60	22095
KUB-P.2D.225.R.07-ABS50	U42 52250	22.5	50	109	46	78	1,01	SOGX 07T208	454.60	22595
KUB-P.2D.230.R.07-ABS50	U42 52300	23	50	109	46	78	1,01	SOGX 07T208	454.60	23095
KUB-P.2D.235.R.08-ABS50	U42 52350	23.5	50	111	48	80	1,28	SOGX 080308	468.42	23595
KUB-P.2D.240.R.08-ABS50	U42 52400	24	50	111	48	80	1,28	SOGX 080308	468.42	24095
KUB-P.2D.245.R.08-ABS50	U42 52450	24.5	50	114	50	83	1,28	SOGX 080308	468.42	24595
KUB-P.2D.250.R.08-ABS50	U42 52500	25	50	114	50	83	1,28	SOGX 080308	468.42	25095
KUB-P.2D.255.R.08-ABS50	U42 52550	25.5	50	116	52	85	1,28	SOGX 080308	468.42	25595
KUB-P.2D.260.R.08-ABS50	U42 52600	26	50	116	52	85	1,28	SOGX 080308	468.42	26095
KUB-P.2D.265.R.09-ABS50	U42 52650	26.5	50	119	54	88	2,25	SOGX 09T308	520.07	26595
KUB-P.2D.270.R.09-ABS50	U42 52700	27	50	119	54	88	2,25	SOGX 09T308	520.07	27095
KUB-P.2D.275.R.09-ABS50	U42 52750	27.5	50	121	56	90	2,25	SOGX 09T308	520.07	27595
KUB-P.2D.280.R.09-ABS50	U42 52800	28	50	121	56	90	2,25	SOGX 09T308	520.07	28095
KUB-P.2D.285.R.09-ABS50	U42 52850	28.5	50	124	58	93	2,25	SOGX 09T308	520.07	28595
KUB-P.2D.290.R.09-ABS50	U42 52900	29	50	124	58	93	2,25	SOGX 09T308	520.07	29095
KUB-P.2D.295.R.09-ABS50	U42 52950	29.5	50	126	60	95	2,25	SOGX 09T308	520.07	29595
KUB-P.2D.300.R.09-ABS50	U42 53000	30	50	126	60	95	2,25	SOGX 09T308	520.07	30095
KUB-P.2D.305.R.10-ABS63	U42 63050	30.5	63	139	62	101	2,8	SOGX 100408	547.67	30596
KUB-P.2D.310.R.10-ABS63	U42 63100	31	63	139	62	101	2,8	SOGX 100408	547.67	31096
KUB-P.2D.315.R.10-ABS63	U42 63150	31.5	63	141	64	103	2,8	SOGX 100408	547.67	31596
KUB-P.2D.320.R.10-ABS63	U42 63200	32	63	141	64	103	2,8	SOGX 100408	547.67	32096
KUB-P.2D.325.R.10-ABS63	U42 63250	32.5	63	144	66	106	2,8	SOGX 100408	547.67	32596
KUB-P.2D.330.R.10-ABS63	U42 63300	33	63	144	66	106	2,8	SOGX 100408	547.67	33096
KUB-P.2D.335.R.11-ABS63	U42 63350	33.5	63	146	68	108	2,8	SOGX 110408	584.43	33596
KUB-P.2D.340.R.11-ABS63	U42 63400	34	63	146	68	108	2,8	SOGX 110408	584.43	34096
KUB-P.2D.345.R.11-ABS63	U42 63450	34.5	63	149	70	111	2,8	SOGX 110408	584.43	34596
KUB-P.2D.350.R.11-ABS63	U42 63500	35	63	149	70	111	2,8	SOGX 110408	584.43	35096
KUB-P.2D.355.R.11-ABS63	U42 63550	35.5	63	152	72	113	2,8	SOGX 110408	584.43	35596
KUB-P.2D.360.R.11-ABS63	U42 63600	36	63	152	72	113	2,8	SOGX 110408	584.43	36096
KUB-P.2D.365.R.11-ABS63	U42 63650	36.5	63	154	74	116	2,8	SOGX 110408	584.43	36596
KUB-P.2D.370.R.11-ABS63	U42 63700	37	63	154	74	116	2,8	SOGX 110408	584.43	37096
KUB-P.2D.375.R.12-ABS63	U42 63750	37.5	63	156	76	118	6,25	SOGX 120408	611.93	37596
KUB-P.2D.380.R.12-ABS63	U42 63800	38	63	156	76	118	6,25	SOGX 120408	611.93	38096
KUB-P.2D.385.R.12-ABS63	U42 63850	38.5	63	159	78	121	6,25	SOGX 120408	611.93	38596
KUB-P.2D.390.R.12-ABS63	U42 63900	39	63	159	78	121	6,25	SOGX 120408	611.93	39096
KUB-P.2D.395.R.12-ABS63	U42 63950	39.5	63	161	80	123	6,25	SOGX 120408	611.93	39596
KUB-P.2D.400.R.12-ABS63	U42 64000	40	63	161	80	123	6,25	SOGX 120408	611.93	40096
KUB-P.2D.405.R.12-ABS63	U42 64050	40.5	63	164	82	126	6,25	SOGX 120408	611.93	40596

KUB Pentron – Indexable insert drill

Scope of supply:

Indexable Insert Drill incl. clamping screws

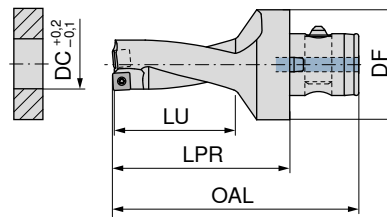
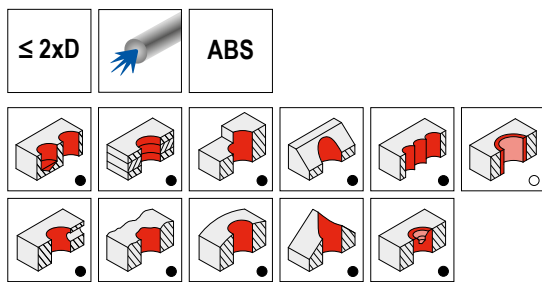

3

Designation	KOMET no.	DC mm	DF mm	OAL mm	LU mm	LPR mm	torque moment Nm	Insert	10 872 ...	
									£ 2B/6#	
KUB-P.2D.410.R.12-ABS63	U42 64100	41	63	164	82	126	6,25	SOGX 120408	611.93	41096
KUB-P.2D.415.R.12-ABS63	U42 64150	41.5	63	166	84	128	6,25	SOGX 120408	611.93	41596
KUB-P.2D.420.R.12-ABS63	U42 64200	42	63	166	84	128	6,25	SOGX 120408	611.93	42096
KUB-P.2D.425.R.13-ABS63	U42 64250	42.5	63	169	86	131	6,25	SOGX 130508	611.93	42596
KUB-P.2D.430.R.13-ABS63	U42 64300	43	63	169	86	131	6,25	SOGX 130508	611.93	43096
KUB-P.2D.435.R.13-ABS63	U42 64350	43.5	63	171	88	133	6,25	SOGX 130508	611.93	43596
KUB-P.2D.440.R.13-ABS63	U42 64400	44	63	171	88	133	6,25	SOGX 130508	611.93	44096
KUB-P.2D.445.R.13-ABS63	U42 64450	44.5	63	174	90	136	6,25	SOGX 130508	611.93	44596
KUB-P.2D.450.R.13-ABS63	U42 64500	45	63	174	90	136	6,25	SOGX 130508	611.93	45096
KUB-P.2D.455.R.13-ABS63	U42 64550	45.5	63	173	92	135	6,25	SOGX 130508	611.93	45596
KUB-P.2D.460.R.13-ABS63	U42 64600	46	63	173	92	135	6,25	SOGX 130508	611.93	46096
KUB-P.2D.470.R.08-ABS63	U42 64700	47	63	187	94	149	1,28	SOGX 080308	654.10	47096
KUB-P.2D.480.R.08-ABS63	U42 64800	48	63	189	96	151	1,28	SOGX 080308	654.10	48096
KUB-P.2D.490.R.08-ABS63	U42 64900	49	63	191	98	153	1,28	SOGX 080308	654.10	49096
KUB-P.2D.500.R.08-ABS63	U42 65000	50	63	193	100	155	1,28	SOGX 080308	654.10	50096
KUB-P.2D.510.R.08-ABS63	U42 65100	51	63	195	102	157	1,28	SOGX 080308	654.10	51096
KUB-P.2D.520.R.08-ABS63	U42 65200	52	63	197	104	159	1,28	SOGX 080308	654.10	52096
KUB-P.2D.530.R.10-ABS63	U42 65300	53	63	199	106	161	2,8	SOGX 100408	654.10	53096
KUB-P.2D.540.R.10-ABS63	U42 65400	54	63	201	108	163	2,8	SOGX 100408	654.10	54096
KUB-P.2D.550.R.10-ABS80	U42 75500	55	80	208	110	165	2,8	SOGX 100408	789.65	55098
KUB-P.2D.560.R.10-ABS80	U42 75600	56	80	210	112	167	2,8	SOGX 100408	789.65	56098
KUB-P.2D.570.R.10-ABS80	U42 75700	57	80	212	114	169	2,8	SOGX 100408	789.65	57098
KUB-P.2D.580.R.10-ABS80	U42 75800	58	80	214	116	171	2,8	SOGX 100408	789.65	58098
KUB-P.2D.590.R.10-ABS80	U42 75900	59	80	216	118	173	2,8	SOGX 100408	789.65	59098
KUB-P.2D.600.R.10-ABS80	U42 76000	60	80	218	120	175	2,8	SOGX 100408	789.65	60098
KUB-P.2D.610.R.10-ABS80	U42 76100	61	80	220	122	177	2,8	SOGX 100408	789.65	61098
KUB-P.2D.620.R.10-ABS80	U42 76200	62	80	222	124	179	2,8	SOGX 100408	789.65	62098
KUB-P.2D.630.R.10-ABS80	U42 76300	63	80	224	126	181	2,8	SOGX 100408	789.65	63098
KUB-P.2D.640.R.10-ABS80	U42 76400	64	80	226	128	183	2,8	SOGX 100408	789.65	64098
KUB-P.2D.650.R.10-ABS80	U42 76500	65	80	228	130	185	2,8	SOGX 100408	789.65	65098

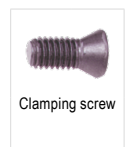
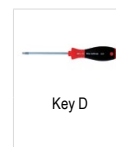

Spare parts	80 950 ...		80 950 ...		10 950 ...	
	£		£		£	
DC	Y7		Y7		W7/6B	
14 - 16		T05 - IP	9.73	057	M1,8x3,8 - 05IP	2.73 10100
16,5 - 18					M2,0x4,3 - 06IP	2.73 10000
18,5 - 23					M2,2x5,5 - 06IP	2.73 10700
23,5 - 26					M2,5x6,3 - 08IP	2.73 10800
26,5 - 30					M3,0x7,6 - 08IP	2.73 10200
30,5 - 37					M3,5x7,5 - 15IP	2.73 10300
37,5 - 46					M4,5x10 - 20IP	2.73 10400
47 - 52					M2,5x6,3 - 08IP	2.73 10800
53 - 65					M3,5x7,5 - 15IP	2.73 10300

1 Matching holders can be found in → Chapter 16 Adapters and accessories in the clamping technology catalogue

KUB Pentron – Indexable insert drill

Scope of supply:

Indexable Insert Drill incl. clamping screws

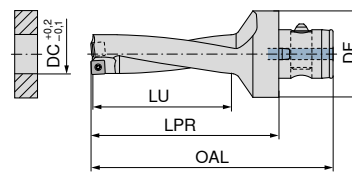
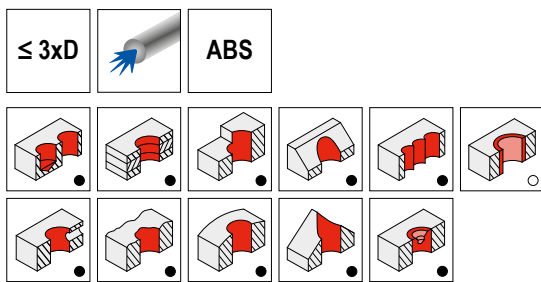

10 873 ...

Designation	KOMET no.	DC mm	DF mm	OAL mm	LU mm	LPR mm	torque moment Nm	Insert	£ 2B/6#	
KUB-P.3D.140.R.04-ABS50	U43 51400	14	50	100	42	69	0,38	SOGX 040204	446.66	14095
KUB-P.3D.145.R.04-ABS50	U43 51450	14.5	50	104	45	73	0,38	SOGX 040204	446.66	14595
KUB-P.3D.150.R.04-ABS50	U43 51500	15	50	104	45	73	0,38	SOGX 040204	446.66	15095
KUB-P.3D.155.R.04-ABS50	U43 51550	15.5	50	109	48	78	0,38	SOGX 040204	446.66	15595
KUB-P.3D.160.R.04-ABS50	U43 51600	16	50	109	48	78	0,38	SOGX 040204	446.66	16095
KUB-P.3D.165.R.05-ABS50	U43 51650	16.5	50	113	51	82	0,62	SOGX 050204	456.92	16595
KUB-P.3D.170.R.05-ABS50	U43 51700	17	50	113	51	82	0,62	SOGX 050204	456.92	17095
KUB-P.3D.175.R.05-ABS50	U43 51750	17.5	50	116	54	85	0,62	SOGX 050204	456.92	17595
KUB-P.3D.180.R.05-ABS50	U43 51800	18	50	116	54	85	0,62	SOGX 050204	456.92	18095
KUB-P.3D.185.R.06-ABS50	U43 51850	18.5	50	120	57	89	1,01	SOGX 060206	468.42	18595
KUB-P.3D.190.R.06-ABS50	U43 51900	19	50	120	57	89	1,01	SOGX 060206	468.42	19095
KUB-P.3D.195.R.06-ABS50	U43 51950	19.5	50	123	60	92	1,01	SOGX 060206	468.42	19595
KUB-P.3D.200.R.06-ABS50	U43 52000	20	50	123	60	92	1,01	SOGX 060206	468.42	20095
KUB-P.3D.205.R.07-ABS50	U43 52050	20.5	50	126	63	95	1,01	SOGX 07T208	482.20	20595
KUB-P.3D.210.R.07-ABS50	U43 52100	21	50	126	63	95	1,01	SOGX 07T208	482.20	21095
KUB-P.3D.215.R.07-ABS50	U43 52150	21.5	50	129	66	98	1,01	SOGX 07T208	482.20	21595
KUB-P.3D.220.R.07-ABS50	U43 52200	22	50	129	66	98	1,01	SOGX 07T208	482.20	22095
KUB-P.3D.225.R.07-ABS50	U43 52250	22.5	50	132	69	101	1,01	SOGX 07T208	482.20	22595
KUB-P.3D.230.R.07-ABS50	U43 52300	23	50	132	69	101	1,01	SOGX 07T208	482.20	23095
KUB-P.3D.235.R.08-ABS50	U43 52350	23.5	50	135	72	104	1,28	SOGX 080308	497.10	23595
KUB-P.3D.240.R.08-ABS50	U43 52400	24	50	135	72	104	1,28	SOGX 080308	497.10	24095
KUB-P.3D.245.R.08-ABS50	U43 52450	24.5	50	139	75	108	1,28	SOGX 080308	497.10	24595
KUB-P.3D.250.R.08-ABS50	U43 52500	25	50	139	75	108	1,28	SOGX 080308	497.10	25095
KUB-P.3D.255.R.08-ABS50	U43 52550	25.5	50	142	78	111	1,28	SOGX 080308	497.10	25595
KUB-P.3D.260.R.08-ABS50	U43 52600	26	50	142	78	111	1,28	SOGX 080308	497.10	26095
KUB-P.3D.265.R.09-ABS50	U43 52650	26.5	50	146	81	115	2,25	SOGX 09T308	556.84	26595
KUB-P.3D.270.R.09-ABS50	U43 52700	27	50	146	81	115	2,25	SOGX 09T308	556.84	27095
KUB-P.3D.275.R.09-ABS50	U43 52750	27.5	50	149	84	118	2,25	SOGX 09T308	556.84	27595
KUB-P.3D.280.R.09-ABS50	U43 52800	28	50	149	84	118	2,25	SOGX 09T308	556.84	28095
KUB-P.3D.285.R.09-ABS50	U43 52850	28.5	50	153	87	122	2,25	SOGX 09T308	556.84	28595
KUB-P.3D.290.R.09-ABS50	U43 52900	29	50	153	87	122	2,25	SOGX 09T308	556.84	29095
KUB-P.3D.295.R.09-ABS50	U43 52950	29.5	50	156	90	125	2,25	SOGX 09T308	556.84	29595
KUB-P.3D.300.R.09-ABS50	U43 53000	30	50	156	90	125	2,25	SOGX 09T308	556.84	30095
KUB-P.3D.305.R.10-ABS63	U43 63050	30.5	63	170	93	132	2,8	SOGX 100408	582.12	30596
KUB-P.3D.310.R.10-ABS63	U43 63100	31	63	170	93	132	2,8	SOGX 100408	582.12	31096
KUB-P.3D.315.R.10-ABS63	U43 63150	31.5	63	173	96	135	2,8	SOGX 100408	582.12	31596
KUB-P.3D.320.R.10-ABS63	U43 63200	32	63	173	96	135	2,8	SOGX 100408	582.12	32096
KUB-P.3D.325.R.10-ABS63	U43 63250	32.5	63	177	99	139	2,8	SOGX 100408	582.12	32596
KUB-P.3D.330.R.10-ABS63	U43 63300	33	63	177	99	139	2,8	SOGX 100408	582.12	33096
KUB-P.3D.335.R.11-ABS63	U43 63350	33.5	63	180	102	142	2,8	SOGX 110408	619.98	33596
KUB-P.3D.340.R.11-ABS63	U43 63400	34	63	180	102	142	2,8	SOGX 110408	619.98	34096
KUB-P.3D.345.R.11-ABS63	U43 63450	34.5	63	184	105	146	2,8	SOGX 110408	619.98	34596
KUB-P.3D.350.R.11-ABS63	U43 63500	35	63	184	105	146	2,8	SOGX 110408	619.98	35096
KUB-P.3D.355.R.11-ABS63	U43 63550	35.5	63	187	108	149	2,8	SOGX 110408	619.98	35596
KUB-P.3D.360.R.11-ABS63	U43 63600	36	63	187	108	149	2,8	SOGX 110408	619.98	36096
KUB-P.3D.365.R.11-ABS63	U43 63650	36.5	63	191	111	153	2,8	SOGX 110408	619.98	36596
KUB-P.3D.370.R.11-ABS63	U43 63700	37	63	191	111	153	2,8	SOGX 110408	619.98	37096
KUB-P.3D.375.R.12-ABS63	U43 63750	37.5	63	194	114	156	6,25	SOGX 120408	649.78	37596
KUB-P.3D.380.R.12-ABS63	U43 63800	38	63	194	114	156	6,25	SOGX 120408	649.78	38096
KUB-P.3D.385.R.12-ABS63	U43 63850	38.5	63	198	117	160	6,25	SOGX 120408	649.78	38596
KUB-P.3D.390.R.12-ABS63	U43 63900	39	63	198	117	160	6,25	SOGX 120408	649.78	39096
KUB-P.3D.395.R.12-ABS63	U43 63950	39.5	63	201	120	163	6,25	SOGX 120408	649.78	39596
KUB-P.3D.400.R.12-ABS63	U43 64000	40	63	201	120	163	6,25	SOGX 120408	649.78	40096
KUB-P.3D.405.R.12-ABS63	U43 64050	40.5	63	205	123	167	6,25	SOGX 120408	649.78	40596

KUB Pentron – Indexable insert drill

Scope of supply:

Indexable Insert Drill incl. clamping screws

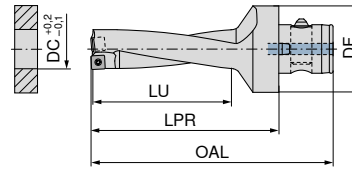
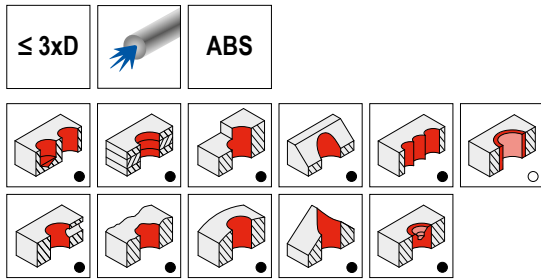

3

10 873 ...

Designation	KOMET no.	DC mm	DF mm	OAL mm	LU mm	LPR mm	torque moment Nm	Insert	£ 2B/6#
KUB-P.3D.410.R.12-ABS63	U43 64100	41	63	205	123	167	6,25	SOGX 120408	649.78 41096
KUB-P.3D.415.R.12-ABS63	U43 64150	41.5	63	208	126	170	6,25	SOGX 120408	649.78 41596
KUB-P.3D.420.R.12-ABS63	U43 64200	42	63	208	126	170	6,25	SOGX 120408	649.78 42096
KUB-P.3D.425.R.13-ABS63	U43 64250	42.5	63	212	129	174	6,25	SOGX 130508	649.78 42596
KUB-P.3D.430.R.13-ABS63	U43 64300	43	63	212	129	174	6,25	SOGX 130508	649.78 43096
KUB-P.3D.435.R.13-ABS63	U43 64350	43.5	63	215	132	177	6,25	SOGX 130508	649.78 43596
KUB-P.3D.440.R.13-ABS63	U43 64400	44	63	215	132	177	6,25	SOGX 130508	649.78 44096
KUB-P.3D.445.R.13-ABS63	U43 64450	44.5	63	219	135	181	6,25	SOGX 130508	649.78 44596
KUB-P.3D.450.R.13-ABS63	U43 64500	45	63	219	135	181	6,25	SOGX 130508	649.78 45096
KUB-P.3D.455.R.13-ABS63	U43 64550	45.5	63	219	138	181	6,25	SOGX 130508	649.78 45596
KUB-P.3D.460.R.13-ABS63	U43 64600	46	63	219	138	181	6,25	SOGX 130508	649.78 46096
KUB-P.3D.470.R.08-ABS63	U43 64700	47	63	234	141	196	1,28	SOGX 080308	731.70 47096
KUB-P.3D.480.R.08-ABS63	U43 64800	48	63	237	144	199	1,28	SOGX 080308	731.70 48096
KUB-P.3D.490.R.08-ABS63	U43 64900	49	63	240	147	202	1,28	SOGX 080308	731.70 49096
KUB-P.3D.500.R.08-ABS63	U43 65000	50	63	243	150	205	1,28	SOGX 080308	731.70 50096
KUB-P.3D.510.R.08-ABS63	U43 65100	51	63	246	153	208	1,28	SOGX 080308	731.70 51096
KUB-P.3D.520.R.08-ABS63	U43 65200	52	63	249	156	211	1,28	SOGX 080308	731.70 52096
KUB-P.3D.530.R.10-ABS63	U43 65300	53	63	252	159	214	2,8	SOGX 100408	731.70 53096
KUB-P.3D.540.R.10-ABS63	U43 65400	54	63	255	162	217	2,8	SOGX 100408	731.70 54096
KUB-P.3D.550.R.10-ABS80	U43 75500	55	80	263	165	220	2,8	SOGX 100408	880.62 55098
KUB-P.3D.560.R.10-ABS80	U43 75600	56	80	266	168	223	2,8	SOGX 100408	880.62 56098
KUB-P.3D.570.R.10-ABS80	U43 75700	57	80	269	171	226	2,8	SOGX 100408	880.62 57098
KUB-P.3D.580.R.10-ABS80	U43 75800	58	80	272	174	229	2,8	SOGX 100408	880.62 58098
KUB-P.3D.590.R.10-ABS80	U43 75900	59	80	275	177	232	2,8	SOGX 100408	880.62 59098
KUB-P.3D.600.R.10-ABS80	U43 76000	60	80	278	180	235	2,8	SOGX 100408	880.62 60098
KUB-P.3D.610.R.10-ABS80	U43 76100	61	80	281	183	238	2,8	SOGX 100408	880.62 61098
KUB-P.3D.620.R.10-ABS80	U43 76200	62	80	284	186	241	2,8	SOGX 100408	880.62 62098
KUB-P.3D.630.R.10-ABS80	U43 76300	63	80	287	189	244	2,8	SOGX 100408	880.62 63098
KUB-P.3D.640.R.10-ABS80	U43 76400	64	80	290	192	247	2,8	SOGX 100408	880.62 64098
KUB-P.3D.650.R.10-ABS80	U43 76500	65	80	293	195	250	2,8	SOGX 100408	880.62 65098

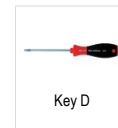
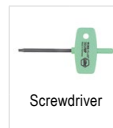

Spare parts	80 950 ...		80 950 ...		10 950 ...		
	£	Y7	£	Y7	£	W7/6B	
DC							
14 - 16		T05 - IP	9.73	057		M1,8x3,8 - 05IP	2.73 10100
16,5 - 18						M2,0x4,3 - 06IP	2.73 10000
18,5 - 23						M2,2x5,5 - 06IP	2.73 10700
23,5 - 26						M2,5x6,3 - 08IP	2.73 10800
26,5 - 30						M3,0x7,6 - 08IP	2.73 10200
30,5 - 37						M3,5x7,5 - 15IP	2.73 10300
37,5 - 46						M4,5x10 - 20IP	2.73 10400
47 - 52						M2,5x6,3 - 08IP	2.73 10800
53 - 65						M3,5x7,5 - 15IP	2.73 10300

Matching holders can be found in → Chapter 16 Adapters and accessories in the clamping technology catalogue

KUB Pentron – Indexable insert drill

Scope of supply:

Indexable Insert Drill incl. clamping screws

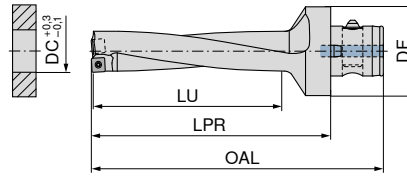
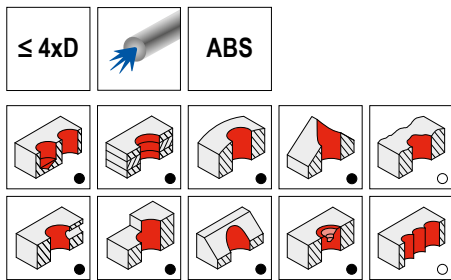

10 874 ...

Designation	KOMET no.	DC mm	DF mm	OAL mm	LU mm	LPR mm	torque moment Nm	Insert	£ 2B/6#	
KUB-P.4D.140.R.04-ABS50	U44 51400	14	50	114	56	83	0,38	SOGX 040204	531.56	14095
KUB-P.4D.145.R.04-ABS50	U44 51450	14.5	50	119	60	88	0,38	SOGX 040204	531.56	14595
KUB-P.4D.150.R.04-ABS50	U44 51500	15	50	119	60	88	0,38	SOGX 040204	531.56	15095
KUB-P.4D.155.R.04-ABS50	U44 51550	15.5	50	125	64	94	0,38	SOGX 040204	531.56	15595
KUB-P.4D.160.R.04-ABS50	U44 51600	16	50	125	64	94	0,38	SOGX 040204	531.56	16095
KUB-P.4D.165.R.05-ABS50	U44 51650	16.5	50	130	68	99	0,62	SOGX 050204	546.46	16595
KUB-P.4D.170.R.05-ABS50	U44 51700	17	50	130	68	99	0,62	SOGX 050204	546.46	17095
KUB-P.4D.175.R.05-ABS50	U44 51750	17.5	50	134	72	103	0,62	SOGX 050204	546.46	17595
KUB-P.4D.180.R.05-ABS50	U44 51800	18	50	134	72	103	0,62	SOGX 050204	546.46	18095
KUB-P.4D.185.R.06-ABS50	U44 51850	18.5	50	139	76	108	1,01	SOGX 060206	556.75	18595
KUB-P.4D.190.R.06-ABS50	U44 51900	19	50	139	76	108	1,01	SOGX 060206	556.84	19095
KUB-P.4D.195.R.06-ABS50	U44 51950	19.5	50	143	80	112	1,01	SOGX 060206	556.84	19595
KUB-P.4D.200.R.06-ABS50	U44 52000	20	50	143	80	112	1,01	SOGX 060206	556.84	20095
KUB-P.4D.205.R.07-ABS50	U44 52050	20.5	50	147	84	116	1,01	SOGX 07T208	578.70	20595
KUB-P.4D.210.R.07-ABS50	U44 52100	21	50	147	84	116	1,01	SOGX 07T208	578.70	21095
KUB-P.4D.215.R.07-ABS50	U44 52150	21.5	50	151	88	120	1,01	SOGX 07T208	578.70	21595
KUB-P.4D.220.R.07-ABS50	U44 52200	22	50	151	88	120	1,01	SOGX 07T208	578.70	22095
KUB-P.4D.225.R.07-ABS50	U44 52250	22.5	50	155	92	124	1,01	SOGX 07T208	578.70	22595
KUB-P.4D.230.R.07-ABS50	U44 52300	23	50	155	92	124	1,01	SOGX 07T208	578.70	23095
KUB-P.4D.235.R.08-ABS50	U44 52350	23.5	50	159	96	128	1,28	SOGX 080308	595.92	23595
KUB-P.4D.240.R.08-ABS50	U44 52400	24	50	159	96	128	1,28	SOGX 080308	595.92	24095
KUB-P.4D.245.R.08-ABS50	U44 52450	24.5	50	164	100	133	1,28	SOGX 080308	595.92	24595
KUB-P.4D.250.R.08-ABS50	U44 52500	25	50	164	100	133	1,28	SOGX 080308	595.92	25095
KUB-P.4D.255.R.08-ABS50	U44 52550	25.5	50	168	104	137	1,28	SOGX 080308	595.92	25595
KUB-P.4D.260.R.08-ABS50	U44 52600	26	50	168	104	137	1,28	SOGX 080308	595.92	26095
KUB-P.4D.265.R.09-ABS50	U44 52650	26.5	50	173	108	142	2,25	SOGX 09T308	668.22	26595
KUB-P.4D.270.R.09-ABS50	U44 52700	27	50	173	108	142	2,25	SOGX 09T308	668.22	27095
KUB-P.4D.275.R.09-ABS50	U44 52750	27.5	50	177	112	146	2,25	SOGX 09T308	668.22	27595
KUB-P.4D.280.R.09-ABS50	U44 52800	28	50	177	112	146	2,25	SOGX 09T308	668.22	28095
KUB-P.4D.285.R.09-ABS50	U44 52850	28.5	50	182	116	151	2,25	SOGX 09T308	668.22	28595
KUB-P.4D.290.R.09-ABS50	U44 52900	29	50	182	116	151	2,25	SOGX 09T308	668.22	29095
KUB-P.4D.295.R.09-ABS50	U44 52950	29.5	50	186	120	155	2,25	SOGX 09T308	668.22	29595
KUB-P.4D.300.R.09-ABS50	U44 53000	30	50	186	120	155	2,25	SOGX 09T308	668.22	30095
KUB-P.4D.305.R.10-ABS63	U44 63050	30.5	63	201	124	163	2,8	SOGX 100408	701.46	30596
KUB-P.4D.310.R.10-ABS63	U44 63100	31	63	201	124	163	2,8	SOGX 100408	701.46	31096
KUB-P.4D.315.R.10-ABS63	U44 63150	31.5	63	205	128	167	2,8	SOGX 100408	701.46	31596
KUB-P.4D.320.R.10-ABS63	U44 63200	32	63	205	128	167	2,8	SOGX 100408	701.46	32096
KUB-P.4D.325.R.10-ABS63	U44 63250	32.5	63	210	132	172	2,8	SOGX 100408	701.46	32596
KUB-P.4D.330.R.10-ABS63	U44 63300	33	63	210	132	172	2,8	SOGX 100408	701.46	33096
KUB-P.4D.335.R.11-ABS63	U44 63350	33.5	63	214	136	176	2,8	SOGX 110408	717.57	33596
KUB-P.4D.340.R.11-ABS63	U44 63400	34	63	214	136	176	2,8	SOGX 110408	717.57	34096
KUB-P.4D.345.R.11-ABS63	U44 63450	34.5	63	219	140	181	2,8	SOGX 110408	717.57	34596
KUB-P.4D.350.R.11-ABS63	U44 63500	35	63	219	140	181	2,8	SOGX 110408	717.57	35096
KUB-P.4D.355.R.11-ABS63	U44 63550	35.5	63	223	144	185	2,8	SOGX 110408	717.57	35596
KUB-P.4D.360.R.11-ABS63	U44 63600	36	63	223	144	185	2,8	SOGX 110408	717.57	36096
KUB-P.4D.365.R.11-ABS63	U44 63650	36.5	63	228	148	190	2,8	SOGX 110408	717.57	36596
KUB-P.4D.370.R.11-ABS63	U44 63700	37	63	228	148	190	2,8	SOGX 110408	717.57	37096
KUB-P.4D.375.R.12-ABS63	U44 63750	37.5	63	232	152	194	6,25	SOGX 120408	738.22	37596
KUB-P.4D.380.R.12-ABS63	U44 63800	38	63	232	152	194	6,25	SOGX 120408	738.22	38096

KUB Pentron – Indexable insert drill

Scope of supply:

Indexable Insert Drill incl. clamping screws

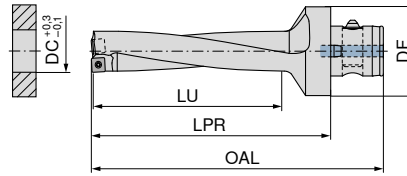
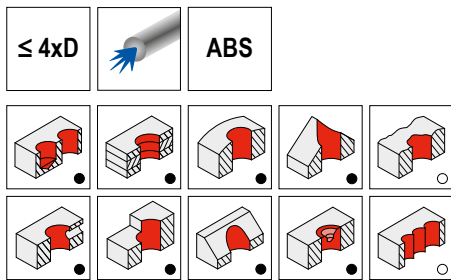

3

Designation	KOMET no.	DC mm	DF mm	OAL mm	LU mm	LPR mm	torque moment Nm	Insert	10 874 ...	
									£	2B/6#
KUB-P.4D.385.R.12-ABS63	U44 63850	38.5	63	237	156	199	6,25	SOGX 120408	738.22	38596
KUB-P.4D.390.R.12-ABS63	U44 63900	39	63	237	156	199	6,25	SOGX 120408	738.22	39096
KUB-P.4D.395.R.12-ABS63	U44 63950	39.5	63	241	160	203	6,25	SOGX 120408	738.22	39596
KUB-P.4D.400.R.12-ABS63	U44 64000	40	63	241	160	203	6,25	SOGX 120408	738.22	40096
KUB-P.4D.405.R.12-ABS63	U44 64050	40.5	63	246	164	208	6,25	SOGX 120408	738.22	40596
KUB-P.4D.410.R.12-ABS63	U44 64100	41	63	246	164	208	6,25	SOGX 120408	738.22	41096
KUB-P.4D.415.R.12-ABS63	U44 64150	41.5	63	250	168	212	6,25	SOGX 120408	738.22	41596
KUB-P.4D.420.R.12-ABS63	U44 64200	42	63	250	168	212	6,25	SOGX 120408	738.22	42096
KUB-P.4D.425.R.13-ABS63	U44 64250	42.5	63	255	172	217	6,25	SOGX 130508	791.08	42596
KUB-P.4D.430.R.13-ABS63	U44 64300	43	63	255	172	217	6,25	SOGX 130508	791.08	43096
KUB-P.4D.435.R.13-ABS63	U44 64350	43.5	63	259	176	221	6,25	SOGX 130508	791.08	43596
KUB-P.4D.440.R.13-ABS63	U44 64400	44	63	259	176	221	6,25	SOGX 130508	791.08	44096
KUB-P.4D.445.R.13-ABS63	U44 64450	44.5	63	264	180	226	6,25	SOGX 130508	791.08	44596
KUB-P.4D.450.R.13-ABS63	U44 64500	45	63	264	180	226	6,25	SOGX 130508	791.08	45096
KUB-P.4D.455.R.13-ABS63	U44 64550	45.5	63	268	184	230	6,25	SOGX 130508	791.08	45596
KUB-P.4D.460.R.13-ABS63	U44 64600	46	63	268	184	230	6,25	SOGX 130508	791.08	46096

Spare parts	Screwdriver		Key D		Clamping screw	
	£	Y7	£	Y7	£	W7/6B
DC	80 950 ...		80 950 ...		10 950 ...	
14 - 16						
16,5 - 18						
18,5 - 23						
23,5 - 26						
26,5 - 30						
30,5 - 37						
37,5 - 46						
		T05 - IP			M1,8x3,8 - 05IP	
				T06 - IP	M2,0x4,3 - 06IP	
				T06 - IP	M2,2x5,5 - 06IP	
				T08 - IP	M2,5x6,3 - 08IP	
				T08 - IP	M3,0x7,6 - 08IP	
				T15 - IP	M3,5x7,5 - 15IP	
				T20 - IP	M4,5x10 - 20IP	

Matching holders can be found in → Chapter 16 Adapters and accessoires in the clamping technology catalogue

KUB Pentron – Indexable insert drill

Scope of supply:

Indexable Insert Drill incl. clamping screws

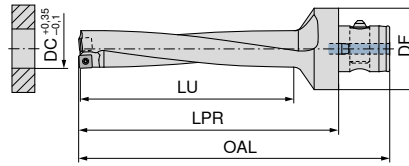
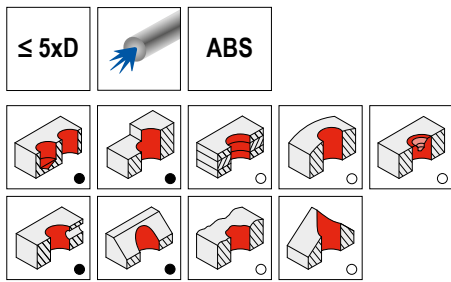

10 875 ...

Designation	KOMET no.	DC mm	DF mm	OAL mm	LU mm	LPR mm	torque moment Nm	Insert	£	
									2B/6#	
KUB-P.5D.140.R.04-ABS50	U45 51400	14	50	128	70	97	0,38	SOGX 040204	569.43	14095
KUB-P.5D.145.R.04-ABS50	U45 51450	14.5	50	134	75	103	0,38	SOGX 040204	569.43	14595
KUB-P.5D.150.R.04-ABS50	U45 51500	15	50	134	75	103	0,38	SOGX 040204	569.43	15095
KUB-P.5D.155.R.04-ABS50	U45 51550	15.5	50	141	80	110	0,38	SOGX 040204	569.43	15595
KUB-P.5D.160.R.04-ABS50	U45 51600	16	50	141	80	110	0,38	SOGX 040204	569.43	16095
KUB-P.5D.165.R.05-ABS50	U45 51650	16.5	50	147	85	116	0,62	SOGX 050204	584.43	16595
KUB-P.5D.170.R.05-ABS50	U45 51700	17	50	147	85	116	0,62	SOGX 050204	584.43	17095
KUB-P.5D.175.R.05-ABS50	U45 51750	17.5	50	152	90	121	0,62	SOGX 050204	584.43	17595
KUB-P.5D.180.R.05-ABS50	U45 51800	18	50	152	90	121	0,62	SOGX 050204	584.43	18095
KUB-P.5D.185.R.06-ABS50	U45 51850	18.5	50	158	95	127	1,01	SOGX 060206	595.90	18595
KUB-P.5D.190.R.06-ABS50	U45 51900	19	50	158	95	127	1,01	SOGX 060206	595.92	19095
KUB-P.5D.195.R.06-ABS50	U45 51950	19.5	50	163	100	132	1,01	SOGX 060206	595.92	19595
KUB-P.5D.200.R.06-ABS50	U45 52000	20	50	163	100	132	1,01	SOGX 060206	595.92	20095
KUB-P.5D.205.R.07-ABS50	U45 52050	20.5	50	168	105	137	1,01	SOGX 07T208	616.57	20595
KUB-P.5D.210.R.07-ABS50	U45 52100	21	50	168	105	137	1,01	SOGX 07T208	616.57	21095
KUB-P.5D.215.R.07-ABS50	U45 52150	21.5	50	173	110	142	1,01	SOGX 07T208	616.57	21595
KUB-P.5D.220.R.07-ABS50	U45 52200	22	50	173	110	142	1,01	SOGX 07T208	616.57	22095
KUB-P.5D.225.R.07-ABS50	U45 52250	22.5	50	178	115	147	1,01	SOGX 07T208	616.57	22595
KUB-P.5D.230.R.07-ABS50	U45 52300	23	50	178	115	147	1,01	SOGX 07T208	616.57	23095
KUB-P.5D.235.R.08-ABS50	U45 52350	23.5	50	183	120	152	1,28	SOGX 080308	636.10	23595
KUB-P.5D.240.R.08-ABS50	U45 52400	24	50	183	120	152	1,28	SOGX 080308	636.10	24095
KUB-P.5D.245.R.08-ABS50	U45 52450	24.5	50	189	125	158	1,28	SOGX 080308	636.10	24595
KUB-P.5D.250.R.08-ABS50	U45 52500	25	50	189	125	158	1,28	SOGX 080308	636.10	25095
KUB-P.5D.255.R.08-ABS50	U45 52550	25.5	50	194	130	163	1,28	SOGX 080308	636.10	25595
KUB-P.5D.260.R.08-ABS50	U45 52600	26	50	194	130	163	1,28	SOGX 080308	636.10	26095
KUB-P.5D.265.R.09-ABS50	U45 52650	26.5	50	200	135	169	2,25	SOGX 09T308	706.08	26595
KUB-P.5D.270.R.09-ABS50	U45 52700	27	50	200	135	169	2,25	SOGX 09T308	706.08	27095
KUB-P.5D.275.R.09-ABS50	U45 52750	27.5	50	205	140	174	2,25	SOGX 09T308	706.08	27595
KUB-P.5D.280.R.09-ABS50	U45 52800	28	50	205	140	174	2,25	SOGX 09T308	706.08	28095
KUB-P.5D.285.R.09-ABS50	U45 52850	28.5	50	211	145	180	2,25	SOGX 09T308	706.08	28595
KUB-P.5D.290.R.09-ABS50	U45 52900	29	50	211	145	180	2,25	SOGX 09T308	706.08	29095
KUB-P.5D.295.R.09-ABS50	U45 52950	29.5	50	216	150	185	2,25	SOGX 09T308	706.08	29595
KUB-P.5D.300.R.09-ABS50	U45 53000	30	50	216	150	185	2,25	SOGX 09T308	706.08	30095
KUB-P.5D.305.R.10-ABS63	U45 63050	30.5	63	232	155	194	2,8	SOGX 100408	752.00	30596
KUB-P.5D.310.R.10-ABS63	U45 63100	31	63	232	155	194	2,8	SOGX 100408	752.00	31096
KUB-P.5D.315.R.10-ABS63	U45 63150	31.5	63	237	160	199	2,8	SOGX 100408	752.00	31596
KUB-P.5D.320.R.10-ABS63	U45 63200	32	63	237	160	199	2,8	SOGX 100408	752.00	32096
KUB-P.5D.325.R.10-ABS63	U45 63250	32.5	63	243	165	205	2,8	SOGX 100408	752.00	32596
KUB-P.5D.330.R.10-ABS63	U45 63300	33	63	243	165	205	2,8	SOGX 100408	752.00	33096
KUB-P.5D.335.R.11-ABS63	U45 63350	33.5	63	248	170	210	2,8	SOGX 110408	770.33	33596
KUB-P.5D.340.R.11-ABS63	U45 63400	34	63	248	170	210	2,8	SOGX 110408	770.33	34096
KUB-P.5D.345.R.11-ABS63	U45 63450	34.5	63	254	175	216	2,8	SOGX 110408	770.33	34596
KUB-P.5D.350.R.11-ABS63	U45 63500	35	63	254	175	216	2,8	SOGX 110408	770.33	35096
KUB-P.5D.355.R.11-ABS63	U45 63550	35.5	63	259	180	221	2,8	SOGX 110408	770.33	35596
KUB-P.5D.360.R.11-ABS63	U45 63600	36	63	259	180	221	2,8	SOGX 110408	770.33	36096
KUB-P.5D.365.R.11-ABS63	U45 63650	36.5	63	265	185	227	2,8	SOGX 110408	770.33	36596
KUB-P.5D.370.R.11-ABS63	U45 63700	37	63	265	185	227	2,8	SOGX 110408	770.33	37096
KUB-P.5D.375.R.12-ABS63	U45 63750	37.5	63	270	190	232	6,25	SOGX 120408	791.08	37596
KUB-P.5D.380.R.12-ABS63	U45 63800	38	63	270	190	232	6,25	SOGX 120408	791.08	38096

KUB Pentron – Indexable insert drill

Scope of supply:

Indexable Insert Drill incl. clamping screws

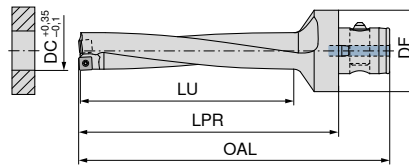
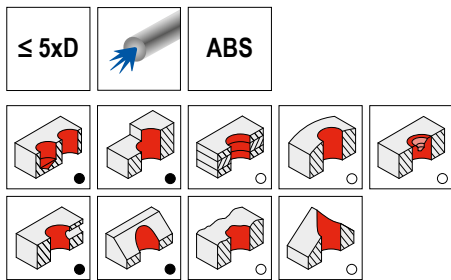

3

10 875 ...

Designation	KOMET no.	DC mm	DF mm	OAL mm	LU mm	LPR mm	torque moment Nm	Insert	£ 2B/6#
KUB-P.5D.385.R.12-ABS63	U45 63850	38.5	63	276	195	238	6,25	SOGX 120408	791.08 38596
KUB-P.5D.390.R.12-ABS63	U45 63900	39	63	276	195	238	6,25	SOGX 120408	791.08 39096
KUB-P.5D.395.R.12-ABS63	U45 63950	39.5	63	281	200	243	6,25	SOGX 120408	791.08 39596
KUB-P.5D.400.R.12-ABS63	U45 64000	40	63	281	200	243	6,25	SOGX 120408	791.08 40096
KUB-P.5D.405.R.12-ABS63	U45 64050	40.5	63	287	205	249	6,25	SOGX 120408	791.08 40596
KUB-P.5D.410.R.12-ABS63	U45 64100	41	63	287	205	249	6,25	SOGX 120408	791.08 41096
KUB-P.5D.415.R.12-ABS63	U45 64150	41.5	63	292	210	254	6,25	SOGX 120408	791.08 41596
KUB-P.5D.420.R.12-ABS63	U45 64200	42	63	292	210	254	6,25	SOGX 120408	791.08 42096
KUB-P.5D.425.R.13-ABS63	U45 64250	42.5	63	298	215	260	6,25	SOGX 130508	855.34 42596
KUB-P.5D.430.R.13-ABS63	U45 64300	43	63	298	215	260	6,25	SOGX 130508	855.34 43096
KUB-P.5D.435.R.13-ABS63	U45 64350	43.5	63	303	220	265	6,25	SOGX 130508	855.34 43596
KUB-P.5D.440.R.13-ABS63	U45 64400	44	63	303	220	265	6,25	SOGX 130508	855.34 44096
KUB-P.5D.445.R.13-ABS63	U45 64450	44.5	63	309	225	271	6,25	SOGX 130508	855.34 44596
KUB-P.5D.450.R.13-ABS63	U45 64500	45	63	309	225	271	6,25	SOGX 130508	855.34 45096
KUB-P.5D.455.R.13-ABS63	U45 64550	45.5	63	314	230	276	6,25	SOGX 130508	855.34 45596
KUB-P.5D.460.R.13-ABS63	U45 64600	46	63	314	230	276	6,25	SOGX 130508	855.34 46096

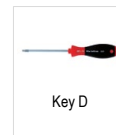
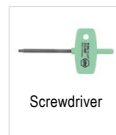

Spare parts	80 950 ...		80 950 ...		10 950 ...				
	£	Y7	£	Y7	£	W7/6B			
DC									
14 - 16		T05 - IP	9.73	057					
16,5 - 18				T06 - IP	17.37	123	M1,8x3,8 - 05IP	2.73	10100
18,5 - 23				T06 - IP	17.37	123	M2,0x4,3 - 06IP	2.73	10000
23,5 - 26				T08 - IP	17.13	125	M2,5x6,3 - 08IP	2.73	10800
26,5 - 30				T08 - IP	17.13	125	M3,0x7,6 - 08IP	2.73	10200
30,5 - 37				T15 - IP	20.03	128	M3,5x7,5 - 15IP	2.73	10300
37,5 - 46				T20 - IP	21.03	129	M4,5x10 - 20IP	2.73	10400



Matching holders can be found in → Chapter 16 Adapters and accessoires in the clamping technology catalogue

KUB Pentron – Indexable insert drill

Scope of supply:

Indexable Insert Drill incl. clamping screws

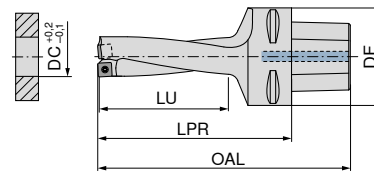
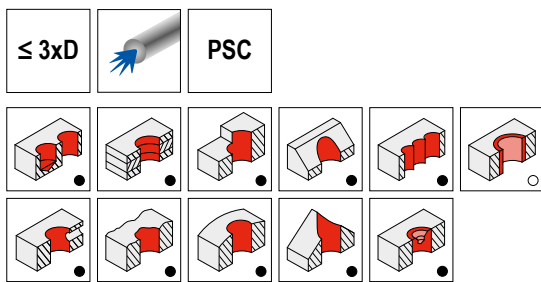

10 873 ...

Designation	KOMET no.	DC mm	DF mm	OAL mm	LU mm	LPR mm	torque moment Nm	Insert	£ 2B/6#	
KUB-P.3D.140.R.04-PSC50	U40 61400	14	50	103	42	73	0,38	SOGX 040204	485.64	14055
KUB-P.3D.145.R.04-PSC50	U40 61450	14.5	50	107	45	77	0,38	SOGX 040204	485.64	14555
KUB-P.3D.150.R.04-PSC50	U40 61500	15	50	107	45	77	0,38	SOGX 040204	485.64	15055
KUB-P.3D.155.R.04-PSC50	U40 61550	15.5	50	112	48	82	0,38	SOGX 040204	485.64	15555
KUB-P.3D.160.R.04-PSC50	U40 61600	16	50	112	48	82	0,38	SOGX 040204	485.64	16055
KUB-P.3D.160.R.04-PSC63	U40 71600	16	63	124	48	86	0,38	SOGX 040204	485.64	16056
KUB-P.3D.165.R.05-PSC50	U40 61650	16.5	50	116	51	86	0,62	SOGX 050204	497.10	16555
KUB-P.3D.170.R.05-PSC50	U40 61700	17	50	116	51	86	0,62	SOGX 050204	497.10	17055
KUB-P.3D.175.R.05-PSC50	U40 61750	17.5	50	119	54	89	0,62	SOGX 050204	497.10	17555
KUB-P.3D.180.R.05-PSC50	U40 61800	18	50	119	54	89	0,62	SOGX 050204	497.10	18055
KUB-P.3D.165.R.05-PSC63	U40 71650	16.5	63	128	51	90	0,62	SOGX 050204	497.10	16556
KUB-P.3D.170.R.05-PSC63	U40 71700	17	63	128	51	90	0,62	SOGX 050204	497.10	17056
KUB-P.3D.175.R.05-PSC63	U40 71750	17.5	63	131	54	93	0,62	SOGX 050204	497.10	17556
KUB-P.3D.180.R.05-PSC63	U40 71800	18	63	131	54	93	0,62	SOGX 050204	497.10	18056
KUB-P.3D.185.R.06-PSC50	U40 61850	18.5	50	123	57	93	1,01	SOGX 060206	509.81	18555
KUB-P.3D.190.R.06-PSC50	U40 61900	19	50	123	57	93	1,01	SOGX 060206	509.81	19055
KUB-P.3D.195.R.06-PSC50	U40 61950	19.5	50	126	60	96	1,01	SOGX 060206	509.81	19555
KUB-P.3D.200.R.06-PSC50	U40 62000	20	50	126	60	96	1,01	SOGX 060206	509.81	20055
KUB-P.3D.185.R.06-PSC63	U40 71850	18.5	63	135	57	97	1,01	SOGX 060206	509.81	18556
KUB-P.3D.190.R.06-PSC63	U40 71900	19	63	135	57	97	1,01	SOGX 060206	509.81	19056
KUB-P.3D.195.R.06-PSC63	U40 71950	19.5	63	138	60	100	1,01	SOGX 060206	509.81	19556
KUB-P.3D.200.R.06-PSC63	U40 72000	20	63	138	60	100	1,01	SOGX 060206	509.81	20056
KUB-P.3D.205.R.07-PSC50	U40 62050	20.5	50	130	63	100	1,01	SOGX 07T208	524.70	20555
KUB-P.3D.210.R.07-PSC50	U40 62100	21	50	130	63	100	1,01	SOGX 07T208	524.70	21055
KUB-P.3D.215.R.07-PSC50	U40 62150	21.5	50	133	66	103	1,01	SOGX 07T208	524.70	21555
KUB-P.3D.220.R.07-PSC50	U40 62200	22	50	133	66	103	1,01	SOGX 07T208	524.70	22055
KUB-P.3D.225.R.07-PSC50	U40 62250	22.5	50	137	69	107	1,01	SOGX 07T208	524.70	22555
KUB-P.3D.230.R.07-PSC50	U40 62300	23	50	137	69	107	1,01	SOGX 07T208	524.70	23055
KUB-P.3D.205.R.07-PSC63	U40 72050	20.5	63	142	63	104	1,01	SOGX 07T208	524.70	20556
KUB-P.3D.210.R.07-PSC63	U40 72100	21	63	142	63	104	1,01	SOGX 07T208	524.70	21056
KUB-P.3D.215.R.07-PSC63	U40 72150	21.5	63	145	66	107	1,01	SOGX 07T208	524.70	21556
KUB-P.3D.220.R.07-PSC63	U40 72200	22	63	145	66	107	1,01	SOGX 07T208	524.70	22056
KUB-P.3D.225.R.07-PSC63	U40 72250	22.5	63	149	69	111	1,01	SOGX 07T208	524.70	22556
KUB-P.3D.230.R.07-PSC63	U40 72300	23	63	149	69	111	1,01	SOGX 07T208	524.70	23056
KUB-P.3D.235.R.08-PSC50	U40 62350	23.5	50	140	72	110	1,28	SOGX 080308	540.71	23555
KUB-P.3D.240.R.08-PSC50	U40 62400	24	50	140	72	110	1,28	SOGX 080308	540.71	24055
KUB-P.3D.245.R.08-PSC50	U40 62450	24.5	50	144	75	114	1,28	SOGX 080308	540.71	24555
KUB-P.3D.250.R.08-PSC50	U40 62500	25	50	144	75	114	1,28	SOGX 080308	540.71	25055
KUB-P.3D.255.R.08-PSC50	U40 62550	25.5	50	147	78	117	1,28	SOGX 080308	540.71	25555
KUB-P.3D.260.R.08-PSC50	U40 62600	26	50	147	78	117	1,28	SOGX 080308	540.71	26055
KUB-P.3D.235.R.08-PSC63	U40 72350	23.5	63	152	72	114	1,28	SOGX 080308	540.71	23556
KUB-P.3D.240.R.08-PSC63	U40 72400	24	63	152	72	114	1,28	SOGX 080308	540.71	24056
KUB-P.3D.245.R.08-PSC63	U40 72450	24.5	63	156	75	118	1,28	SOGX 080308	540.71	24556
KUB-P.3D.250.R.08-PSC63	U40 72500	25	63	156	75	118	1,28	SOGX 080308	540.71	25056
KUB-P.3D.255.R.08-PSC63	U40 72550	25.5	63	159	78	121	1,28	SOGX 080308	540.71	25556
KUB-P.3D.260.R.08-PSC63	U40 72600	26	63	159	78	121	1,28	SOGX 080308	540.71	26056
KUB-P.3D.265.R.09-PSC50	U40 62650	26.5	50	151	81	121	2,25	SOGX 09T308	605.07	26555
KUB-P.3D.270.R.09-PSC50	U40 62700	27	50	151	81	121	2,25	SOGX 09T308	605.07	27055
KUB-P.3D.275.R.09-PSC50	U40 62750	27.5	50	154	84	124	2,25	SOGX 09T308	605.07	27555
KUB-P.3D.280.R.09-PSC50	U40 62800	28	50	154	84	124	2,25	SOGX 09T308	605.07	28055
KUB-P.3D.285.R.09-PSC50	U40 62850	28.5	50	158	87	128	2,25	SOGX 09T308	605.07	28555
KUB-P.3D.290.R.09-PSC50	U40 62900	29	50	158	87	128	2,25	SOGX 09T308	605.07	29055
KUB-P.3D.295.R.09-PSC50	U40 62950	29.5	50	161	90	131	2,25	SOGX 09T308	605.07	29555
KUB-P.3D.300.R.09-PSC50	U40 63000	30	50	161	90	131	2,25	SOGX 09T308	605.07	30055
KUB-P.3D.265.R.09-PSC63	U40 72650	26.5	63	163	81	125	2,25	SOGX 09T308	605.07	26556
KUB-P.3D.270.R.09-PSC63	U40 72700	27	63	163	81	125	2,25	SOGX 09T308	605.07	27056
KUB-P.3D.275.R.09-PSC63	U40 72750	27.5	63	166	84	128	2,25	SOGX 09T308	605.07	27556
KUB-P.3D.280.R.09-PSC63	U40 72800	28	63	166	84	128	2,25	SOGX 09T308	605.07	28056
KUB-P.3D.285.R.09-PSC63	U40 72850	28.5	63	170	87	132	2,25	SOGX 09T308	605.07	28556

KUB Pentron – Indexable insert drill

Scope of supply:

Indexable Insert Drill incl. clamping screws

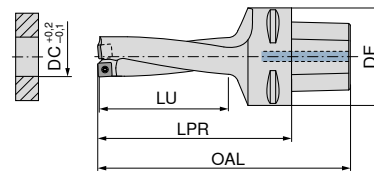
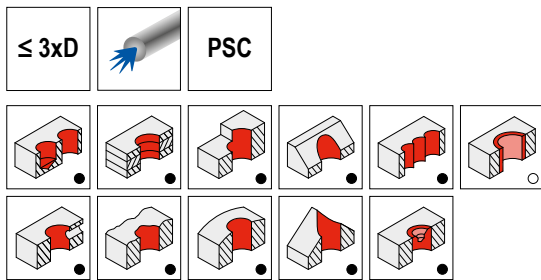

3

Designation	KOMET no.	DC mm	DF mm	OAL mm	LU mm	LPR mm	torque moment Nm	Insert	10 873 ...	
									£	2B/6#
KUB-P.3D.290.R.09-PSC63	U40 72900	29	63	170	87	132	2,25	SOGX 09T308	605.07	29056
KUB-P.3D.295.R.09-PSC63	U40 72950	29.5	63	173	90	135	2,25	SOGX 09T308	605.07	29556
KUB-P.3D.300.R.09-PSC63	U40 73000	30	63	173	90	135	2,25	SOGX 09T308	605.07	30056
KUB-P.3D.305.R.10-PSC50	U40 63050	30.5	50	165	98	135	2,8	SOGX 100408	647.88	30555
KUB-P.3D.310.R.10-PSC50	U40 63100	31	50	165	98	135	2,8	SOGX 100408	647.88	31055
KUB-P.3D.315.R.10-PSC50	U40 63150	31.5	50	168	101	138	2,8	SOGX 100408	647.88	31555
KUB-P.3D.320.R.10-PSC50	U40 63200	32	50	168	101	138	2,8	SOGX 100408	647.88	32055
KUB-P.3D.325.R.10-PSC50	U40 63250	32.5	50	172	104	142	2,8	SOGX 100408	647.88	32555
KUB-P.3D.330.R.10-PSC50	U40 63300	33	50	172	104	142	2,8	SOGX 100408	647.88	33055
KUB-P.3D.305.R.10-PSC63	U40 73050	30.5	63	177	98	139	2,8	SOGX 100408	647.88	30556
KUB-P.3D.310.R.10-PSC63	U40 73100	31	63	177	98	139	2,8	SOGX 100408	647.88	31056
KUB-P.3D.315.R.10-PSC63	U40 73150	31.5	63	180	101	142	2,8	SOGX 100408	647.88	31556
KUB-P.3D.320.R.10-PSC63	U40 73200	32	63	180	101	142	2,8	SOGX 100408	647.88	32056
KUB-P.3D.325.R.10-PSC63	U40 73250	32.5	63	184	104	146	2,8	SOGX 100408	652.51	32556
KUB-P.3D.330.R.10-PSC63	U40 73300	33	63	184	104	146	2,8	SOGX 100408	652.51	33056
KUB-P.3D.335.R.11-PSC50	U40 63350	33.5	50	175	107	145	2,8	SOGX 110408	653.55	33555
KUB-P.3D.340.R.11-PSC50	U40 63400	34	50	175	107	145	2,8	SOGX 110408	653.55	34055
KUB-P.3D.345.R.11-PSC50	U40 63450	34.5	50	179	110	149	2,8	SOGX 110408	653.55	34555
KUB-P.3D.350.R.11-PSC50	U40 63500	35	50	179	110	149	2,8	SOGX 110408	653.55	35055
KUB-P.3D.355.R.11-PSC50	U40 63550	35.5	50	182	113	152	2,8	SOGX 110408	660.95	35555
KUB-P.3D.360.R.11-PSC50	U40 63600	36	50	182	113	152	2,8	SOGX 110408	660.95	36055
KUB-P.3D.365.R.11-PSC50	U40 63650	36.5	50	186	116	156	2,8	SOGX 110408	660.95	36555
KUB-P.3D.370.R.11-PSC50	U40 63700	37	50	186	116	156	2,8	SOGX 110408	660.95	37055
KUB-P.3D.335.R.11-PSC63	U40 73350	33.5	63	187	107	149	2,8	SOGX 110408	660.95	33556
KUB-P.3D.340.R.11-PSC63	U40 73400	34	63	187	107	149	2,8	SOGX 110408	660.95	34056
KUB-P.3D.345.R.11-PSC63	U40 73450	34.5	63	191	110	153	2,8	SOGX 110408	660.95	34556
KUB-P.3D.350.R.11-PSC63	U40 73500	35	63	191	110	153	2,8	SOGX 110408	660.95	35056
KUB-P.3D.355.R.11-PSC63	U40 73550	35.5	63	194	113	156	2,8	SOGX 110408	660.95	35556
KUB-P.3D.360.R.11-PSC63	U40 73600	36	63	194	113	156	2,8	SOGX 110408	660.95	36056
KUB-P.3D.365.R.11-PSC63	U40 73650	36.5	63	198	116	160	2,8	SOGX 110408	660.95	36556
KUB-P.3D.370.R.11-PSC63	U40 73700	37	63	198	116	160	2,8	SOGX 110408	660.95	37056

Spare parts	DC	T05 - IP	80 950 ...		80 950 ...		10 950 ...			
			£	057	£	123	£			
14 - 16			Y7	9.73	Y7	123	W7/6B	M1,8x3,8 - 05IP	2.73	10100
16,5 - 18								M2,0x4,3 - 06IP	2.73	10000
18,5 - 23								M2,2x5,5 - 06IP	2.73	10700
23,5 - 26								M2,5x6,3 - 08IP	2.73	10800
26,5 - 30								M3,0x7,6 - 08IP	2.73	10200
30,5 - 37								M3,5x7,5 - 15IP	2.73	10300

Matching holders can be found in → Chapter 16 Adapters and accessories in the clamping technology catalogue

KUB Pentron – Size PSC 40 available on request.

KUB Pentron – Indexable insert drill

Scope of supply:

Indexable Insert Drill incl. clamping screws

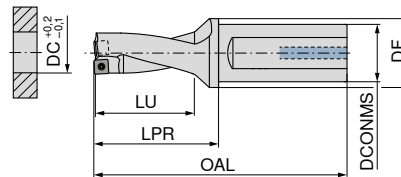
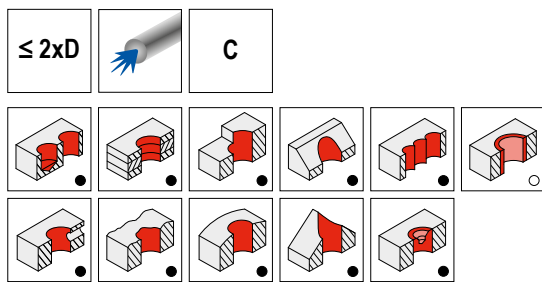

10 872 ...

Designation	KOMET no.	DC mm	DCONMS mm	DF mm	OAL mm	LU mm	LPR mm	torque moment Nm	Insert	10 872 ...	
										£	2B/6#
KUB-P.2D.140.R.04-C20	U42 01400	14	20	30	91	28	41	0,38	SOGX 040204	352.49	14001
KUB-P.2D.145.R.04-C20	U42 01450	14.5	20	30	94	30	44	0,38	SOGX 040204	352.49	14501
KUB-P.2D.150.R.04-C20	U42 01500	15	20	30	94	30	44	0,38	SOGX 040204	352.49	15001
KUB-P.2D.155.R.04-C20	U42 01550	15.5	20	30	98	32	48	0,38	SOGX 040204	352.49	15501
KUB-P.2D.160.R.04-C20	U42 01600	16	20	30	98	32	48	0,38	SOGX 040204	352.49	16001
KUB-P.2D.165.R.05-C20	U42 01650	16.5	20	30	101	34	51	0,62	SOGX 050204	352.49	16501
KUB-P.2D.170.R.05-C20	U42 01700	17	20	30	101	34	51	0,62	SOGX 050204	359.35	17001
KUB-P.2D.175.R.05-C25	U42 11750	17.5	25	30	109	36	53	0,62	SOGX 050204	359.35	17502
KUB-P.2D.180.R.05-C25	U42 11800	18	25	30	109	36	53	0,62	SOGX 050204	359.35	18002
KUB-P.2D.185.R.06-C25	U42 11850	18.5	25	30	112	38	56	1,01	SOGX 060206	359.35	18502
KUB-P.2D.190.R.06-C25	U42 11900	19	25	30	112	38	56	1,01	SOGX 060206	367.40	19002
KUB-P.2D.195.R.06-C25	U42 11950	19.5	25	30	114	40	58	1,01	SOGX 060206	367.40	19502
KUB-P.2D.200.R.06-C25	U42 12000	20	25	30	114	40	58	1,01	SOGX 060206	367.40	20002
KUB-P.2D.205.R.07-C25	U42 12050	20.5	25	30	117	42	61	1,01	SOGX 07T208	391.45	20502
KUB-P.2D.210.R.07-C25	U42 12100	21	25	30	117	42	61	1,01	SOGX 07T208	391.45	21002
KUB-P.2D.215.R.07-C25	U42 12150	21.5	25	30	119	44	63	1,01	SOGX 07T208	391.45	21502
KUB-P.2D.220.R.07-C25	U42 12200	22	25	30	119	44	63	1,01	SOGX 07T208	391.45	22002
KUB-P.2D.225.R.07-C25	U42 12250	22.5	25	30	122	46	66	1,01	SOGX 07T208	391.45	22502
KUB-P.2D.230.R.07-C25	U42 12300	23	25	30	122	46	66	1,01	SOGX 07T208	391.45	23002
KUB-P.2D.235.R.08-C32	U42 22350	23.5	32	39	128	48	68	1,28	SOGX 080308	424.81	23503
KUB-P.2D.240.R.08-C32	U42 22400	24	32	39	128	48	68	1,28	SOGX 080308	424.81	24003
KUB-P.2D.245.R.08-C32	U42 22450	24.5	32	39	131	50	71	1,28	SOGX 080308	424.81	24503
KUB-P.2D.250.R.08-C32	U42 22500	25	32	39	131	50	71	1,28	SOGX 080308	424.81	25003
KUB-P.2D.255.R.08-C32	U42 22550	25.5	32	39	133	52	73	1,28	SOGX 080308	424.81	25503
KUB-P.2D.260.R.08-C32	U42 22600	26	32	39	133	52	73	1,28	SOGX 080308	424.81	26003
KUB-P.2D.265.R.09-C32	U42 22650	26.5	32	39	136	54	76	2,25	SOGX 09T308	448.88	26503
KUB-P.2D.270.R.09-C32	U42 22700	27	32	39	136	54	76	2,25	SOGX 09T308	448.88	27003
KUB-P.2D.275.R.09-C32	U42 22750	27.5	32	39	138	56	78	2,25	SOGX 09T308	448.88	27503
KUB-P.2D.280.R.09-C32	U42 22800	28	32	39	138	56	78	2,25	SOGX 09T308	448.88	28003
KUB-P.2D.285.R.09-C32	U42 22850	28.5	32	39	141	58	81	2,25	SOGX 09T308	448.88	28503
KUB-P.2D.290.R.09-C32	U42 22900	29	32	39	141	58	81	2,25	SOGX 09T308	448.88	29003
KUB-P.2D.295.R.09-C32	U42 22950	29.5	32	39	143	60	83	2,25	SOGX 09T308	448.88	29503
KUB-P.2D.300.R.09-C32	U42 23000	30	32	39	143	60	83	2,25	SOGX 09T308	448.88	30003
KUB-P.2D.305.R.10-C40	U42 33050	30.5	40	50	154	62	86	2,8	SOGX 100408	487.96	30504
KUB-P.2D.310.R.10-C40	U42 33100	31	40	50	154	62	86	2,8	SOGX 100408	487.96	31004
KUB-P.2D.315.R.10-C40	U42 33150	31.5	40	50	156	64	88	2,8	SOGX 100408	487.96	31504
KUB-P.2D.320.R.10-C40	U42 33200	32	40	50	156	64	88	2,8	SOGX 100408	487.96	32004
KUB-P.2D.325.R.10-C40	U42 33250	32.5	40	50	159	66	91	2,8	SOGX 100408	487.96	32504
KUB-P.2D.330.R.10-C40	U42 33300	33	40	50	159	66	91	2,8	SOGX 100408	487.96	33004
KUB-P.2D.335.R.11-C40	U42 33350	33.5	40	50	161	68	93	2,8	SOGX 110408	510.92	33504
KUB-P.2D.340.R.11-C40	U42 33400	34	40	50	161	68	93	2,8	SOGX 110408	510.92	34004
KUB-P.2D.345.R.11-C40	U42 33450	34.5	40	50	164	70	96	2,8	SOGX 110408	510.92	34504
KUB-P.2D.350.R.11-C40	U42 33500	35	40	50	164	70	96	2,8	SOGX 110408	510.92	35004
KUB-P.2D.355.R.11-C40	U42 33550	35.5	40	50	166	72	98	2,8	SOGX 110408	510.92	35504
KUB-P.2D.360.R.11-C40	U42 33600	36	40	50	166	72	98	2,8	SOGX 110408	510.92	36004
KUB-P.2D.365.R.11-C40	U42 33650	36.5	40	50	169	74	101	2,8	SOGX 110408	510.92	36504
KUB-P.2D.370.R.11-C40	U42 33700	37	40	50	169	74	101	2,8	SOGX 110408	510.92	37004
KUB-P.2D.375.R.12-C40	U42 33750	37.5	40	50	171	76	103	6,25	SOGX 120408	525.81	37504
KUB-P.2D.380.R.12-C40	U42 33800	38	40	50	171	76	103	6,25	SOGX 120408	525.81	38004
KUB-P.2D.385.R.12-C40	U42 33850	38.5	40	50	174	78	106	6,25	SOGX 120408	525.81	38504

KUB Pentron – Indexable insert drill

Scope of supply:

Indexable Insert Drill incl. clamping screws

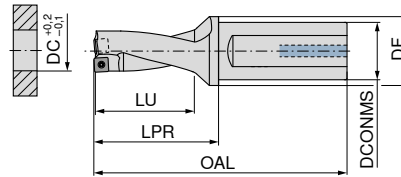
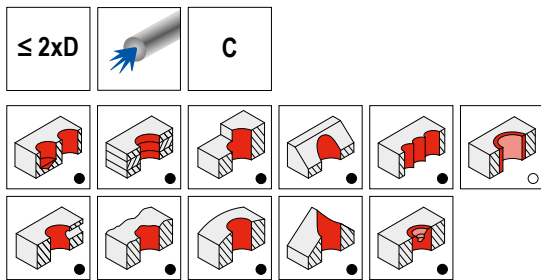

3

10 872 ...

Designation	KOMET no.	DC mm	DCONMS mm	DF mm	OAL mm	LU mm	LPR mm	torque moment Nm	Insert	£
										2B/6#
KUB-P.2D.390.R.12-C40	U42 33900	39	40	50	174	78	106	6,25	SOGX 120408	525.81 39004
KUB-P.2D.395.R.12-C40	U42 33950	39.5	40	50	176	80	108	6,25	SOGX 120408	525.81 39504
KUB-P.2D.400.R.12-C40	U42 34000	40	40	50	176	80	108	6,25	SOGX 120408	525.81 40004
KUB-P.2D.405.R.12-C40	U42 34050	40.5	40	50	179	82	111	6,25	SOGX 120408	525.81 40504
KUB-P.2D.410.R.12-C40	U42 34100	41	40	50	179	82	111	6,25	SOGX 120408	525.81 41004
KUB-P.2D.415.R.12-C40	U42 34150	41.5	40	50	181	84	113	6,25	SOGX 120408	525.81 41504
KUB-P.2D.420.R.12-C40	U42 34200	42	40	50	181	84	113	6,25	SOGX 120408	525.81 42004
KUB-P.2D.425.R.13-C40	U42 34250	42.5	40	50	184	86	116	6,25	SOGX 130508	525.81 42504
KUB-P.2D.430.R.13-C40	U42 34300	43	40	50	184	86	116	6,25	SOGX 130508	525.81 43004
KUB-P.2D.435.R.13-C40	U42 34350	43.5	40	50	186	88	118	6,25	SOGX 130508	525.81 43504
KUB-P.2D.440.R.13-C40	U42 34400	44	40	50	186	88	118	6,25	SOGX 130508	525.81 44004
KUB-P.2D.445.R.13-C40	U42 34450	44.5	40	50	189	90	121	6,25	SOGX 130508	525.81 44504
KUB-P.2D.450.R.13-C40	U42 34500	45	40	50	189	90	121	6,25	SOGX 130508	525.81 45004
KUB-P.2D.455.R.13-C40	U42 34550	45.5	40	50	191	92	123	6,25	SOGX 130508	525.81 45504
KUB-P.2D.460.R.13-C40	U42 34600	46	40	50	191	92	123	6,25	SOGX 130508	525.81 46004

Spare parts DC	Screwdriver		Key D		Clamping screw	
	80 950 ...	£	80 950 ...	£	10 950 ...	£
14 - 16	T05 - IP	9.73	057		M1,8x3,8 - 05IP	2.73 10100
16,5 - 18					M2,0x4,3 - 06IP	2.73 10000
18,5 - 23					M2,2x5,5 - 06IP	2.73 10700
23,5 - 26					M2,5x6,3 - 08IP	2.73 10800
26,5 - 30					M3,0x7,6 - 08IP	2.73 10200
30,5 - 37					M3,5x7,5 - 15IP	2.73 10300
37,5 - 46					M4,5x10 - 20IP	2.73 10400

Matching holders can be found in → Chapter 16 Adapters and accessories in the clamping technology catalogue

KUB Pentron – Indexable insert drill

Scope of supply:

Indexable Insert Drill incl. clamping screws

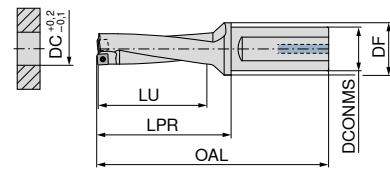
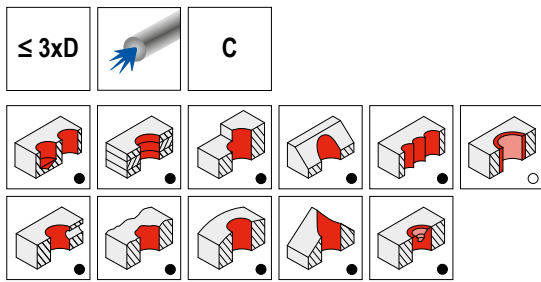

10 873 ...

Designation	KOMET no.	DC mm	DCONMS mm	DF mm	OAL mm	LU mm	LPR mm	torque moment Nm	Insert	10 873 ...	
										£	2B/6#
KUB-P.3D.140.R.04-C20	U43 01400	14	20	30	105	42	55	0,38	SOGX 040204	366.30	14001
KUB-P.3D.145.R.04-C20	U43 01450	14.5	20	30	109	45	59	0,38	SOGX 040204	366.30	14501
KUB-P.3D.150.R.04-C20	U43 01500	15	20	30	109	45	59	0,38	SOGX 040204	366.30	15001
KUB-P.3D.155.R.04-C20	U43 01550	15.5	20	30	114	48	64	0,38	SOGX 040204	366.30	15501
KUB-P.3D.160.R.04-C20	U43 01600	16	20	30	114	48	64	0,38	SOGX 040204	366.30	16001
KUB-P.3D.165.R.05-C20	U43 01650	16.5	20	30	118	51	68	0,62	SOGX 050204	366.30	16501
KUB-P.3D.170.R.05-C20	U43 01700	17	20	30	118	51	68	0,62	SOGX 050204	375.45	17001
KUB-P.3D.175.R.05-C25	U43 11750	17.5	25	30	127	54	71	0,62	SOGX 050204	375.45	17501
KUB-P.3D.180.R.05-C25	U43 11800	18	25	30	127	54	71	0,62	SOGX 050204	375.45	18001
KUB-P.3D.185.R.06-C25	U43 11850	18.5	25	30	131	57	75	1,01	SOGX 060206	375.45	18501
KUB-P.3D.190.R.06-C25	U43 11900	19	25	30	131	57	75	1,01	SOGX 060206	386.94	19001
KUB-P.3D.195.R.06-C25	U43 11950	19.5	25	30	134	60	78	1,01	SOGX 060206	386.94	19501
KUB-P.3D.200.R.06-C25	U43 12000	20	25	30	134	60	78	1,01	SOGX 060206	386.94	20001
KUB-P.3D.205.R.07-C25	U43 12050	20.5	25	30	138	63	82	1,01	SOGX 07T208	412.21	20501
KUB-P.3D.210.R.07-C25	U43 12100	21	25	30	138	63	82	1,01	SOGX 07T208	412.21	21001
KUB-P.3D.215.R.07-C25	U43 12150	21.5	25	30	141	66	85	1,01	SOGX 07T208	412.21	21501
KUB-P.3D.220.R.07-C25	U43 12200	22	25	30	141	66	85	1,01	SOGX 07T208	412.21	22002
KUB-P.3D.225.R.07-C25	U43 12250	22.5	25	30	145	69	89	1,01	SOGX 07T208	412.21	22502
KUB-P.3D.230.R.07-C25	U43 12300	23	25	30	145	69	89	1,01	SOGX 07T208	412.21	23002
KUB-P.3D.235.R.08-C32	U43 22350	23.5	32	39	152	72	92	1,28	SOGX 080308	446.66	23503
KUB-P.3D.240.R.08-C32	U43 22400	24	32	39	152	72	92	1,28	SOGX 080308	446.66	24003
KUB-P.3D.245.R.08-C32	U43 22450	24.5	32	39	156	75	96	1,28	SOGX 080308	446.66	24503
KUB-P.3D.250.R.08-C32	U43 22500	25	32	39	156	75	96	1,28	SOGX 080308	446.66	25003
KUB-P.3D.255.R.08-C32	U43 22550	25.5	32	39	159	78	99	1,28	SOGX 080308	446.66	25503
KUB-P.3D.260.R.08-C32	U43 22600	26	32	39	159	78	99	1,28	SOGX 080308	446.66	26003
KUB-P.3D.265.R.09-C32	U43 22650	26.5	32	39	163	81	103	2,25	SOGX 09T308	469.62	26503
KUB-P.3D.270.R.09-C32	U43 22700	27	32	39	163	81	103	2,25	SOGX 09T308	469.62	27003
KUB-P.3D.275.R.09-C32	U43 22750	27.5	32	39	166	84	106	2,25	SOGX 09T308	469.62	27503
KUB-P.3D.280.R.09-C32	U43 22800	28	32	39	166	84	106	2,25	SOGX 09T308	469.62	28003
KUB-P.3D.285.R.09-C32	U43 22850	28.5	32	39	170	87	110	2,25	SOGX 09T308	469.62	28503
KUB-P.3D.290.R.09-C32	U43 22900	29	32	39	170	87	110	2,25	SOGX 09T308	469.62	29003
KUB-P.3D.295.R.09-C32	U43 22950	29.5	32	39	173	90	113	2,25	SOGX 09T308	469.62	29503
KUB-P.3D.300.R.09-C32	U43 23000	30	32	39	173	90	113	2,25	SOGX 09T308	469.62	30003
KUB-P.3D.305.R.10-C40	U43 33050	30.5	40	50	185	93	117	2,8	SOGX 100408	512.02	30504
KUB-P.3D.310.R.10-C40	U43 33100	31	40	50	185	93	117	2,8	SOGX 100408	512.02	31004
KUB-P.3D.315.R.10-C40	U43 33150	31.5	40	50	188	96	120	2,8	SOGX 100408	512.02	31504
KUB-P.3D.320.R.10-C40	U43 33200	32	40	50	188	96	120	2,8	SOGX 100408	512.02	32004
KUB-P.3D.325.R.10-C40	U43 33250	32.5	40	50	192	99	124	2,8	SOGX 100408	512.02	32504
KUB-P.3D.330.R.10-C40	U43 33300	33	40	50	192	99	124	2,8	SOGX 100408	512.02	33004
KUB-P.3D.335.R.11-C40	U43 33350	33.5	40	50	195	102	127	2,8	SOGX 110408	536.19	33504
KUB-P.3D.340.R.11-C40	U43 33400	34	40	50	195	102	127	2,8	SOGX 110408	536.19	34004
KUB-P.3D.345.R.11-C40	U43 33450	34.5	40	50	199	105	131	2,8	SOGX 110408	536.19	34504
KUB-P.3D.350.R.11-C40	U43 33500	35	40	50	199	105	131	2,8	SOGX 110408	536.19	35004
KUB-P.3D.355.R.11-C40	U43 33550	35.5	40	50	202	108	134	2,8	SOGX 110408	536.19	35504
KUB-P.3D.360.R.11-C40	U43 33600	36	40	50	202	108	134	2,8	SOGX 110408	536.19	36004
KUB-P.3D.365.R.11-C40	U43 33650	36.5	40	50	206	111	138	2,8	SOGX 110408	536.19	36504
KUB-P.3D.370.R.11-C40	U43 33700	37	40	50	206	111	138	2,8	SOGX 110408	536.19	37004
KUB-P.3D.375.R.12-C40	U43 33750	37.5	40	50	209	114	141	6,25	SOGX 120408	552.21	37504
KUB-P.3D.380.R.12-C40	U43 33800	38	40	50	209	114	141	6,25	SOGX 120408	552.21	38004
KUB-P.3D.385.R.12-C40	U43 33850	38.5	40	50	213	117	145	6,25	SOGX 120408	552.21	38504

KUB Pentron – Indexable insert drill

Scope of supply:

Indexable Insert Drill incl. clamping screws

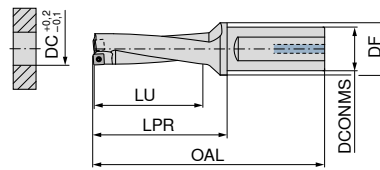
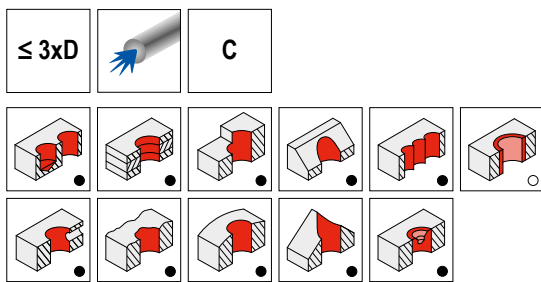

3

10 873 ...

Designation	KOMET no.	DC mm	DCONMS mm	DF mm	OAL mm	LU mm	LPR mm	torque moment Nm	Insert	£	2B/6#
KUB-P.3D.390.R.12-C40	U43 33900	39	40	50	213	117	145	6,25	SOGX 120408	552.21	39004
KUB-P.3D.395.R.12-C40	U43 33950	39.5	40	50	216	120	148	6,25	SOGX 120408	552.21	39504
KUB-P.3D.400.R.12-C40	U43 34000	40	40	50	216	120	148	6,25	SOGX 120408	552.21	40004
KUB-P.3D.405.R.12-C40	U43 34050	40.5	40	50	220	123	152	6,25	SOGX 120408	552.21	40504
KUB-P.3D.410.R.12-C40	U43 34100	41	40	50	220	123	152	6,25	SOGX 120408	552.21	41004
KUB-P.3D.415.R.12-C40	U43 34150	41.5	40	50	223	126	155	6,25	SOGX 120408	552.21	41504
KUB-P.3D.420.R.12-C40	U43 34200	42	40	50	223	126	155	6,25	SOGX 120408	552.21	42004
KUB-P.3D.425.R.13-C40	U43 34250	42.5	40	50	227	129	159	6,25	SOGX 130508	552.21	42504
KUB-P.3D.430.R.13-C40	U43 34300	43	40	50	227	129	159	6,25	SOGX 130508	552.21	43004
KUB-P.3D.435.R.13-C40	U43 34350	43.5	40	50	230	132	162	6,25	SOGX 130508	552.21	43504
KUB-P.3D.440.R.13-C40	U43 34400	44	40	50	230	132	162	6,25	SOGX 130508	552.21	44004
KUB-P.3D.445.R.13-C40	U43 34450	44.5	40	50	234	135	166	6,25	SOGX 130508	552.21	44504
KUB-P.3D.450.R.13-C40	U43 34500	45	40	50	234	135	166	6,25	SOGX 130508	552.21	45004
KUB-P.3D.455.R.13-C40	U43 34550	45.5	40	50	237	138	169	6,25	SOGX 130508	552.21	45504
KUB-P.3D.460.R.13-C40	U43 34600	46	40	50	237	138	169	6,25	SOGX 130508	552.21	46004

Spare parts DC	Screwdriver		Key D		Clamping screw	
	£	Y7	£	Y7	£	W7/6B
14 - 16		9.73				2.73
16,5 - 18						2.73
18,5 - 23						2.73
23,5 - 26						2.73
26,5 - 30						2.73
30,5 - 37						2.73
37,5 - 46						2.73

Matching holders can be found in → Chapter 16 Adapters and accessories in the clamping technology catalogue

KUB Pentron – Indexable insert drill

Scope of supply:

Indexable Insert Drill incl. clamping screws

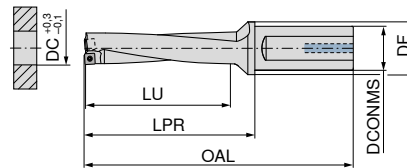
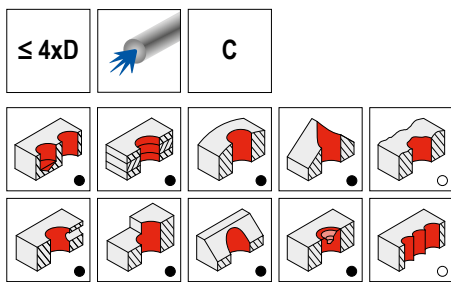

10 874 ...

Designation	KOMET no.	DC mm	DCONMS mm	DF mm	OAL mm	LU mm	LPR mm	torque moment Nm	Insert	10 874 ...	
										£	2B/6#
KUB-P.4D.140.R.04-C20	U44 01400	14	20	30	119	56	69	0,38	SOGX 040204	467.30	14001
KUB-P.4D.145.R.04-C20	U44 01450	14.5	20	30	124	60	74	0,38	SOGX 040204	467.30	14501
KUB-P.4D.150.R.04-C20	U44 01500	15	20	30	124	60	74	0,38	SOGX 040204	467.30	15001
KUB-P.4D.155.R.04-C20	U44 01550	15.5	20	30	130	64	80	0,38	SOGX 040204	467.30	15501
KUB-P.4D.160.R.04-C20	U44 01600	16	20	30	130	64	80	0,38	SOGX 040204	467.30	16001
KUB-P.4D.165.R.05-C20	U44 01650	16.5	20	30	135	68	85	0,62	SOGX 050204	467.30	16501
KUB-P.4D.170.R.05-C20	U44 01700	17	20	30	135	68	85	0,62	SOGX 050204	479.89	17001
KUB-P.4D.175.R.05-C25	U44 11750	17.5	25	30	145	72	89	0,62	SOGX 050204	479.89	17502
KUB-P.4D.180.R.05-C25	U44 11800	18	25	30	145	72	89	0,62	SOGX 050204	479.89	18002
KUB-P.4D.185.R.06-C25	U44 11850	18.5	25	30	150	76	94	1,01	SOGX 060206	479.89	18502
KUB-P.4D.190.R.06-C25	U44 11900	19	25	30	150	76	94	1,01	SOGX 060206	493.69	19002
KUB-P.4D.195.R.06-C25	U44 11950	19.5	25	30	154	80	98	1,01	SOGX 060206	493.69	19502
KUB-P.4D.200.R.06-C25	U44 12000	20	25	30	154	80	98	1,01	SOGX 060206	493.69	20002
KUB-P.4D.205.R.07-C25	U44 12050	20.5	25	30	159	84	103	1,01	SOGX 07T208	512.02	20502
KUB-P.4D.210.R.07-C25	U44 12100	21	25	30	159	84	103	1,01	SOGX 07T208	512.02	21002
KUB-P.4D.215.R.07-C25	U44 12150	21.5	25	30	163	88	107	1,01	SOGX 07T208	512.02	21502
KUB-P.4D.220.R.07-C25	U44 12200	22	25	30	163	88	107	1,01	SOGX 07T208	512.02	22002
KUB-P.4D.225.R.07-C25	U44 12250	22.5	25	30	168	92	112	1,01	SOGX 07T208	512.02	22502
KUB-P.4D.230.R.07-C25	U44 12300	23	25	30	168	92	112	1,01	SOGX 07T208	512.02	23002
KUB-P.4D.235.R.08-C32	U44 22350	23.5	32	39	176	96	116	1,28	SOGX 080308	531.56	23503
KUB-P.4D.240.R.08-C32	U44 22400	24	32	39	176	96	116	1,28	SOGX 080308	531.56	24003
KUB-P.4D.245.R.08-C32	U44 22450	24.5	32	39	181	100	121	1,28	SOGX 080308	531.56	24503
KUB-P.4D.250.R.08-C32	U44 22500	25	32	39	181	100	121	1,28	SOGX 080308	531.56	25003
KUB-P.4D.255.R.08-C32	U44 22550	25.5	32	39	185	104	125	1,28	SOGX 080308	531.56	25503
KUB-P.4D.260.R.08-C32	U44 22600	26	32	39	185	104	125	1,28	SOGX 080308	531.56	26003
KUB-P.4D.265.R.09-C32	U44 22650	26.5	32	39	190	108	130	2,25	SOGX 09T308	600.43	26503
KUB-P.4D.270.R.09-C32	U44 22700	27	32	39	190	108	130	2,25	SOGX 09T308	600.43	27003
KUB-P.4D.275.R.09-C32	U44 22750	27.5	32	39	194	112	134	2,25	SOGX 09T308	600.43	27503
KUB-P.4D.280.R.09-C32	U44 22800	28	32	39	194	112	134	2,25	SOGX 09T308	600.43	28003
KUB-P.4D.285.R.09-C32	U44 22850	28.5	32	39	199	116	139	2,25	SOGX 09T308	600.43	28503
KUB-P.4D.290.R.09-C32	U44 22900	29	32	39	199	116	139	2,25	SOGX 09T308	600.43	29003
KUB-P.4D.295.R.09-C32	U44 22950	29.5	32	39	203	120	143	2,25	SOGX 09T308	600.43	29503
KUB-P.4D.300.R.09-C32	U44 23000	30	32	39	203	120	143	2,25	SOGX 09T308	600.43	30003
KUB-P.4D.305.R.10-C40	U44 33050	30.5	40	50	216	124	148	2,8	SOGX 100408	636.10	30504
KUB-P.4D.310.R.10-C40	U44 33100	31	40	50	216	124	148	2,8	SOGX 100408	636.10	31004
KUB-P.4D.315.R.10-C40	U44 33150	31.5	40	50	220	128	152	2,8	SOGX 100408	636.10	31504
KUB-P.4D.320.R.10-C40	U44 33200	32	40	50	220	128	152	2,8	SOGX 100408	636.10	32004
KUB-P.4D.325.R.10-C40	U44 33250	32.5	40	50	225	132	157	2,8	SOGX 100408	636.10	32504
KUB-P.4D.330.R.10-C40	U44 33300	33	40	50	225	132	157	2,8	SOGX 100408	636.10	33004
KUB-P.4D.335.R.11-C40	U44 33350	33.5	40	50	229	136	161	2,8	SOGX 110408	654.42	33504
KUB-P.4D.340.R.11-C40	U44 33400	34	40	50	229	136	161	2,8	SOGX 110408	654.42	34004
KUB-P.4D.345.R.11-C40	U44 33450	34.5	40	50	234	140	166	2,8	SOGX 110408	654.42	34504
KUB-P.4D.350.R.11-C40	U44 33500	35	40	50	234	140	166	2,8	SOGX 110408	654.42	35004
KUB-P.4D.355.R.11-C40	U44 33550	35.5	40	50	238	144	170	2,8	SOGX 110408	654.42	35504
KUB-P.4D.360.R.11-C40	U44 33600	36	40	50	238	144	170	2,8	SOGX 110408	654.42	36004
KUB-P.4D.365.R.11-C40	U44 33650	36.5	40	50	243	148	175	2,8	SOGX 110408	654.42	36504
KUB-P.4D.370.R.11-C40	U44 33700	37	40	50	243	148	175	2,8	SOGX 110408	654.42	37004
KUB-P.4D.375.R.12-C40	U44 33750	37.5	40	50	247	152	179	6,25	SOGX 120408	675.08	37504
KUB-P.4D.380.R.12-C40	U44 33800	38	40	50	247	152	179	6,25	SOGX 120408	675.08	38004
KUB-P.4D.385.R.12-C40	U44 33850	38.5	40	50	252	156	184	6,25	SOGX 120408	675.08	38504

KUB Pentron – Indexable insert drill

Scope of supply:

Indexable Insert Drill incl. clamping screws

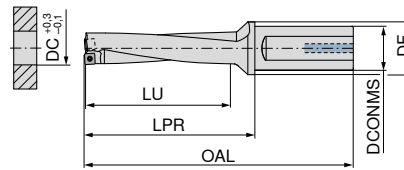
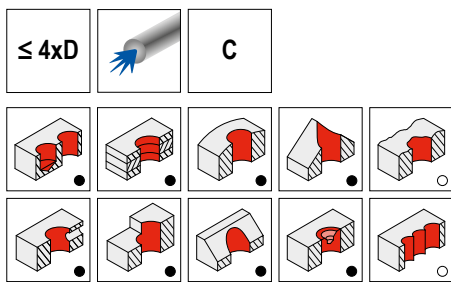

3

10 874 ...

Designation	KOMET no.	DC mm	DCONMS mm	DF mm	OAL mm	LU mm	LPR mm	torque moment Nm	Insert	£
										2B/6#
KUB-P.4D.390.R.12-C40	U44 33900	39	40	50	252	156	184	6,25	SOGX 120408	675.08 39004
KUB-P.4D.395.R.12-C40	U44 33950	39.5	40	50	256	160	188	6,25	SOGX 120408	675.08 39504
KUB-P.4D.400.R.12-C40	U44 34000	40	40	50	256	160	188	6,25	SOGX 120408	675.08 40004
KUB-P.4D.405.R.12-C40	U44 34050	40.5	40	50	261	164	193	6,25	SOGX 120408	675.08 40504
KUB-P.4D.410.R.12-C40	U44 34100	41	40	50	261	164	193	6,25	SOGX 120408	675.08 41004
KUB-P.4D.415.R.12-C40	U44 34150	41.5	40	50	265	166	197	6,25	SOGX 120408	675.08 41504
KUB-P.4D.420.R.12-C40	U44 34200	42	40	50	265	168	197	6,25	SOGX 120408	675.08 42004
KUB-P.4D.425.R.13-C40	U44 34250	42.5	40	50	270	172	202	6,25	SOGX 130508	725.63 42504
KUB-P.4D.430.R.13-C40	U44 34300	43	40	50	270	172	202	6,25	SOGX 130508	725.63 43004
KUB-P.4D.435.R.13-C40	U44 34350	43.5	40	50	274	176	206	6,25	SOGX 130508	725.63 43504
KUB-P.4D.440.R.13-C40	U44 34400	44	40	50	274	176	206	6,25	SOGX 130508	725.63 44004
KUB-P.4D.445.R.13-C40	U44 34450	44.5	40	50	279	180	211	6,25	SOGX 130508	725.63 44504
KUB-P.4D.450.R.13-C40	U44 34500	45	40	50	279	180	211	6,25	SOGX 130508	725.63 45004
KUB-P.4D.455.R.13-C40	U44 34550	45.5	40	50	283	184	215	6,25	SOGX 130508	725.63 45504
KUB-P.4D.460.R.13-C40	U44 34600	46	40	50	283	184	215	6,25	SOGX 130508	725.63 46004

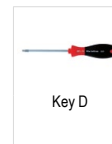
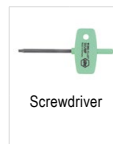

Spare parts DC	80 950 ...	80 950 ...	10 950 ...			
				£	£	£
14 - 16	T05 - IP	9.73	057	M1,8x3,8 - 05IP	2.73	10100
16,5 - 18				M2,0x4,3 - 06IP	2.73	10000
18,5 - 23				M2,2x5,5 - 06IP	2.73	10700
23,5 - 26				M2,5x6,3 - 08IP	2.73	10800
26,5 - 30				M3,0x7,6 - 08IP	2.73	10200
30,5 - 37				M3,5x7,5 - 15IP	2.73	10300
37,5 - 46				M4,5x10 - 20IP	2.73	10400

Matching holders can be found in → Chapter 16 Adapters and accessories in the clamping technology catalogue

KUB Pentron – Indexable insert drill

Scope of supply:

Indexable Insert Drill incl. clamping screws

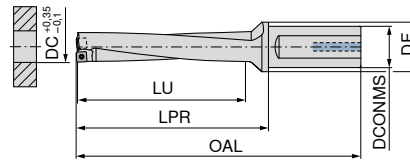
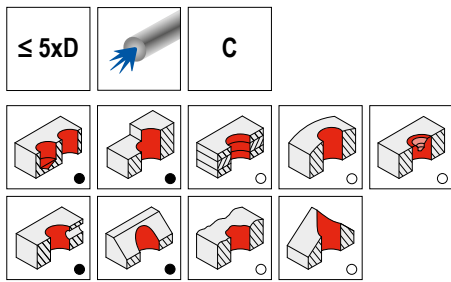

10 875 ...

Designation	KOMET no.	DC mm	DCONMS mm	DF mm	OAL mm	LU mm	LPR mm	torque moment Nm	Insert	£	
										2B/6#	
KUB-P.5D.140.R.04-C20	U45 01400	14	20	30	133	70	83	0,38	SOGX 040204	505.17	14001
KUB-P.5D.145.R.04-C20	U45 01450	14.5	20	30	139	75	89	0,38	SOGX 040204	505.17	14501
KUB-P.5D.150.R.04-C20	U45 01500	15	20	30	139	75	89	0,38	SOGX 040204	505.17	15001
KUB-P.5D.155.R.04-C20	U45 01550	15.5	20	30	146	80	96	0,38	SOGX 040204	505.17	15501
KUB-P.5D.160.R.04-C20	U45 01600	16	20	30	146	80	96	0,38	SOGX 040204	505.17	16001
KUB-P.5D.165.R.05-C20	U45 01650	16.5	20	30	152	85	102	0,62	SOGX 050204	505.17	16501
KUB-P.5D.170.R.05-C20	U45 01700	17	20	30	152	85	102	0,62	SOGX 050204	520.07	17001
KUB-P.5D.175.R.05-C25	U45 11750	17.5	25	30	163	90	107	0,62	SOGX 050204	520.07	17502
KUB-P.5D.180.R.05-C25	U45 11800	18	25	30	163	90	107	0,62	SOGX 050204	520.07	18002
KUB-P.5D.185.R.06-C25	U45 11850	18.5	25	30	169	95	113	1,01	SOGX 060206	520.07	18502
KUB-P.5D.190.R.06-C25	U45 11900	19	25	30	169	95	113	1,01	SOGX 060206	531.56	19002
KUB-P.5D.195.R.06-C25	U45 11950	19.5	25	30	174	100	118	1,01	SOGX 060206	531.56	19502
KUB-P.5D.200.R.06-C25	U45 12000	20	25	30	174	100	118	1,01	SOGX 060206	531.56	20002
KUB-P.5D.205.R.07-C25	U45 12050	20.5	25	30	180	105	124	1,01	SOGX 07T208	551.10	20502
KUB-P.5D.210.R.07-C25	U45 12100	21	25	30	180	105	124	1,01	SOGX 07T208	551.10	21002
KUB-P.5D.215.R.07-C25	U45 12150	21.5	25	30	185	110	129	1,01	SOGX 07T208	551.10	21502
KUB-P.5D.220.R.07-C25	U45 12200	22	25	30	185	110	129	1,01	SOGX 07T208	551.10	22002
KUB-P.5D.225.R.07-C25	U45 12250	22.5	25	30	191	115	135	1,01	SOGX 07T208	551.10	22502
KUB-P.5D.230.R.07-C25	U45 12300	23	25	30	191	115	135	1,01	SOGX 07T208	551.10	23002
KUB-P.5D.235.R.08-C32	U45 22350	23.5	32	39	200	120	140	1,28	SOGX 080308	569.43	23503
KUB-P.5D.240.R.08-C32	U45 22400	24	32	39	200	120	140	1,28	SOGX 080308	569.43	24003
KUB-P.5D.245.R.08-C32	U45 22450	24.5	32	39	206	125	146	1,28	SOGX 080308	569.43	24503
KUB-P.5D.250.R.08-C32	U45 22500	25	32	39	206	125	146	1,28	SOGX 080308	569.43	25003
KUB-P.5D.255.R.08-C32	U45 22550	25.5	32	39	211	130	151	1,28	SOGX 080308	569.43	25503
KUB-P.5D.260.R.08-C32	U45 22600	26	32	39	211	130	151	1,28	SOGX 080308	569.43	26003
KUB-P.5D.265.R.09-C32	U45 22650	26.5	32	39	217	135	157	2,25	SOGX 09T308	641.84	26503
KUB-P.5D.270.R.09-C32	U45 22700	27	32	39	217	135	157	2,25	SOGX 09T308	641.84	27003
KUB-P.5D.275.R.09-C32	U45 22750	27.5	32	39	222	140	162	2,25	SOGX 09T308	641.84	27503
KUB-P.5D.280.R.09-C32	U45 22800	28	32	39	222	140	162	2,25	SOGX 09T308	641.84	28003
KUB-P.5D.285.R.09-C32	U45 22850	28.5	32	39	228	145	168	2,25	SOGX 09T308	641.84	28503
KUB-P.5D.290.R.09-C32	U45 22900	29	32	39	228	145	168	2,25	SOGX 09T308	641.84	29003
KUB-P.5D.295.R.09-C32	U45 22950	29.5	32	39	233	150	173	2,25	SOGX 09T308	641.84	29503
KUB-P.5D.300.R.09-C32	U45 23000	30	32	39	233	150	173	2,25	SOGX 09T308	641.84	30003
KUB-P.5D.305.R.10-C40	U45 33050	30.5	40	50	247	155	179	2,8	SOGX 100408	686.54	30504
KUB-P.5D.310.R.10-C40	U45 33100	31	40	50	247	155	179	2,8	SOGX 100408	686.54	31004
KUB-P.5D.315.R.10-C40	U45 33150	31.5	40	50	252	160	184	2,8	SOGX 100408	686.54	31504
KUB-P.5D.320.R.10-C40	U45 33200	32	40	50	252	160	184	2,8	SOGX 100408	686.54	32004
KUB-P.5D.325.R.10-C40	U45 33250	32.5	40	50	258	165	190	2,8	SOGX 100408	686.54	32504
KUB-P.5D.330.R.10-C40	U45 33300	33	40	50	258	165	190	2,8	SOGX 100408	686.54	33004
KUB-P.5D.335.R.11-C40	U45 33350	33.5	40	50	263	170	195	2,8	SOGX 110408	706.08	33504
KUB-P.5D.340.R.11-C40	U45 33400	34	40	50	263	170	195	2,8	SOGX 110408	706.08	34004
KUB-P.5D.345.R.11-C40	U45 33450	34.5	40	50	269	175	201	2,8	SOGX 110408	706.08	34504
KUB-P.5D.350.R.11-C40	U45 33500	35	40	50	269	175	201	2,8	SOGX 110408	706.08	35004
KUB-P.5D.355.R.11-C40	U45 33550	35.5	40	50	274	180	206	2,8	SOGX 110408	706.08	35504
KUB-P.5D.360.R.11-C40	U45 33600	36	40	50	274	180	206	2,8	SOGX 110408	706.08	36004
KUB-P.5D.365.R.11-C40	U45 33650	36.5	40	50	280	185	212	2,8	SOGX 110408	706.08	36504
KUB-P.5D.370.R.11-C40	U45 33700	37	40	50	280	185	212	2,8	SOGX 110408	706.08	37004
KUB-P.5D.375.R.12-C40	U45 33750	37.5	40	50	285	190	217	6,25	SOGX 120408	725.63	37504
KUB-P.5D.380.R.12-C40	U45 33800	38	40	50	285	190	217	6,25	SOGX 120408	725.63	38004
KUB-P.5D.385.R.12-C40	U45 33850	38.5	40	50	291	195	223	6,25	SOGX 120408	725.63	38504

KUB Pentron – Indexable insert drill

Scope of supply:

Indexable Insert Drill incl. clamping screws

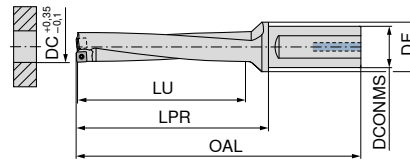
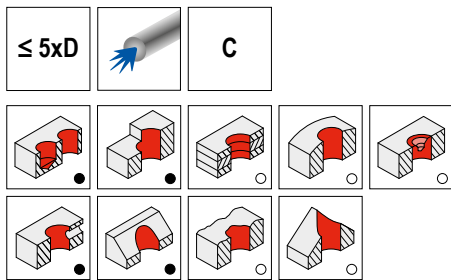

3

10 875 ...

Designation	KOMET no.	DC mm	DCONMS mm	DF mm	OAL mm	LU mm	LPR mm	torque moment Nm	Insert	10 875 ...	
										£	2B/6#
KUB-P.5D.390.R.12-C40	U45 33900	39	40	50	291	195	223	6,25	SOGX 120408	725.63	39004
KUB-P.5D.395.R.12-C40	U45 33950	39.5	40	50	296	200	228	6,25	SOGX 120408	725.63	39504
KUB-P.5D.400.R.12-C40	U45 34000	40	40	50	296	200	228	6,25	SOGX 120408	725.63	40004
KUB-P.5D.405.R.12-C40	U45 34050	40.5	40	50	302	205	234	6,25	SOGX 120408	725.63	40504
KUB-P.5D.410.R.12-C40	U45 34100	41	40	50	302	205	234	6,25	SOGX 120408	725.63	41004
KUB-P.5D.415.R.12-C40	U45 34150	41.5	40	50	307	210	239	6,25	SOGX 120408	725.63	41504
KUB-P.5D.420.R.12-C40	U45 34200	42	40	50	307	210	239	6,25	SOGX 120408	725.63	42004
KUB-P.5D.425.R.13-C40	U45 34250	42.5	40	50	313	215	245	6,25	SOGX 130508	791.08	42504
KUB-P.5D.430.R.13-C40	U45 34300	43	40	50	313	215	245	6,25	SOGX 130508	791.08	43004
KUB-P.5D.435.R.13-C40	U45 34350	43.5	40	50	318	220	250	6,25	SOGX 130508	791.08	43504
KUB-P.5D.440.R.13-C40	U45 34400	44	40	50	318	220	250	6,25	SOGX 130508	791.08	44004
KUB-P.5D.445.R.13-C40	U45 34450	44.5	40	50	324	225	256	6,25	SOGX 130508	791.08	44504
KUB-P.5D.450.R.13-C40	U45 34500	45	40	50	324	225	256	6,25	SOGX 130508	791.08	45004
KUB-P.5D.455.R.13-C40	U45 34550	45.5	40	50	329	230	261	6,25	SOGX 130508	791.08	45504
KUB-P.5D.460.R.13-C40	U45 34600	46	40	50	329	230	261	6,25	SOGX 130508	791.08	46004

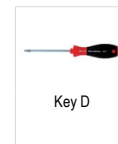
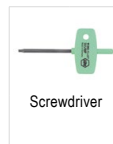

Spare parts DC	80 950 ...		80 950 ...		10 950 ...	
	£	Y7	£	Y7	£	W7/6B
14 - 16		057				
16,5 - 18					M1,8x3,8 - 05IP	2.73 10100
18,5 - 23			T06 - IP	17.37 123	M2,0x4,3 - 06IP	2.73 10000
23,5 - 26			T06 - IP	17.37 123	M2,2x5,5 - 06IP	2.73 10700
26,5 - 30			T08 - IP	17.13 125	M2,5x6,3 - 08IP	2.73 10800
30,5 - 37			T08 - IP	17.13 125	M3,0x7,6 - 08IP	2.73 10200
37,5 - 46			T15 - IP	20.03 128	M3,5x7,5 - 15IP	2.73 10300
			T20 - IP	21.03 129	M4,5x10 - 20IP	2.73 10400

Matching holders can be found in → Chapter 16 Adapters and accessories in the clamping technology catalogue

KUB Pentron CS – basic element

- ▲ SZID = nominal size
- ▲ Tightening torque refers to the fixing screws of the cartridge

Scope of supply:

Cartridge drill incl. fixing screws
Please order cartridges and indexable inserts separately

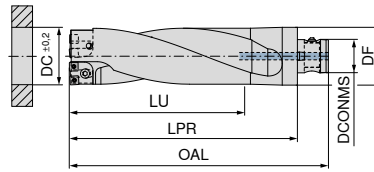
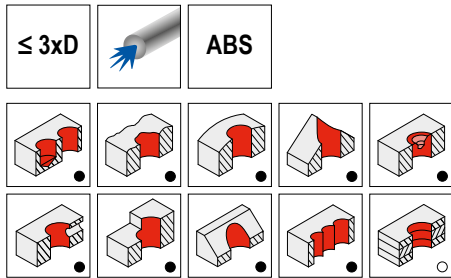

10 876 ...

Designation	KOMET no.	DC mm	DF mm	OAL mm	DCONMS mm	LU mm	LPR mm	SZID	torque moment Nm	£ 2B/6#	
KUB-P.GH-CS.1.3D.64-66.ABS80	U60 46400	64 - 66	80	314	46	198	271	1	17,3	1,133.65	64092
KUB-P.GH-CS.1.3D.67-69.ABS80	U60 46700	67 - 69	80	323	46	207	280	1	17,3	1,145.19	67092
KUB-P.GH-CS.2.3D.70-72.ABS80	U60 47000	70 - 72	80	332	46	216	289	2	17,3	1,156.73	70092
KUB-P.GH-CS.2.3D.73-75.ABS80	U60 47300	73 - 75	80	341	46	225	298	2	17,3	1,168.27	73092
KUB-P.GH-CS.3.3D.76-78.ABS80	U60 47600	76 - 78	80	350	46	234	307	3	42	1,179.81	76092
KUB-P.GH-CS.3.3D.79-81.ABS80	U60 47900	79 - 81	80	359	46	243	316	3	42	1,191.35	79092
KUB-P.GH-CS.3.3D.82-84.ABS80	U60 48200	82 - 84	80	368	46	252	325	3	42	1,202.89	82092
KUB-P.GH-CS.4.3D.85-87.ABS100	U60 58500	85 - 87	100	397	56	261	342	4	42	1,227.15	85091
KUB-P.GH-CS.4.3D.88-90.ABS100	U60 58800	88 - 90	100	406	56	270	351	4	42	1,251.39	88091
KUB-P.GH-CS.4.3D.91-93.ABS100	U60 59100	91 - 93	100	415	56	279	360	4	42	1,274.48	91091
KUB-P.GH-CS.5.3D.94-96.ABS100	U60 59400	94 - 96	100	424	56	288	369	5	42	1,297.57	94091

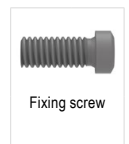

80 397 ...

10 950 ...

Spare parts		£ Y7		£ W7/6B	
DC					
64 - 66	SW5	7.73	050	0.97	16700
67 - 69	SW5	7.73	050	0.97	16700
70 - 72	SW5	7.73	050	0.97	16700
73 - 75	SW5	7.73	050	0.97	16700
76 - 78	SW6	7.59	060	1.02	16800
79 - 81	SW6	7.59	060	1.02	16800
82 - 84	SW6	7.59	060	1.02	16800
85 - 87	SW6	7.59	060	1.02	16900
88 - 90	SW6	7.59	060	1.02	16900
91 - 93	SW6	7.59	060	1.02	16900
94 - 96	SW6	7.59	060	1.02	16900

KUB Pentron CS – internal cartridge

▲ SZID = nominal size

▲ Tightening torque refers to the clamping screws of the indexable inserts

Scope of supply:

Internal cartridge incl. clamping screws of indexable inserts

3

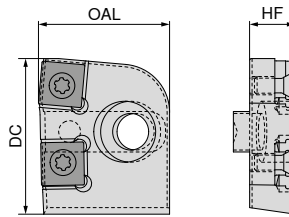
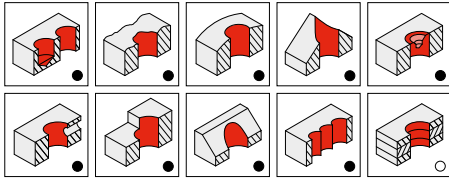

DC mm	KOMET no.	OAL mm	SZID	HF mm	torque moment Nm	Insert
64 - 69	D60 06400	28	1	9	2,8	SOGX 100408
70 - 75	D60 07000	30	2	10	2,8	SOGX 110408
76 - 84	D60 07600	33	3	11	6,25	SOGX 120408
85 - 96	D60 08500	36	4	12	6,25	SOGX 130508

10 877 ...

£	
2B/6#	
212.41	16400
212.41	27000
212.41	37600
212.41	48500

Spare parts

DC		£		£	
64 - 69	T15 - IP	20.03	128	M3,5x7,5 - 15IP	2.73 10300
70 - 75	T15 - IP	20.03	128	M3,5x7,5 - 15IP	2.73 10300
76 - 84	T20 - IP	21.03	129	M4,5x10 - 20IP	2.73 10400
85 - 96	T20 - IP	21.03	129	M4,5x10 - 20IP	2.73 10400

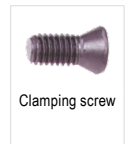
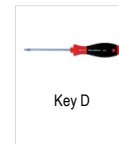

80 950 ...

10 950 ...

£ Y7

£ W7/6B

 The internal cartridge and the place where the internal cartridge sits on the base body are designed to prevent the internal and external cartridges from being incorrectly installed.

Installation aid

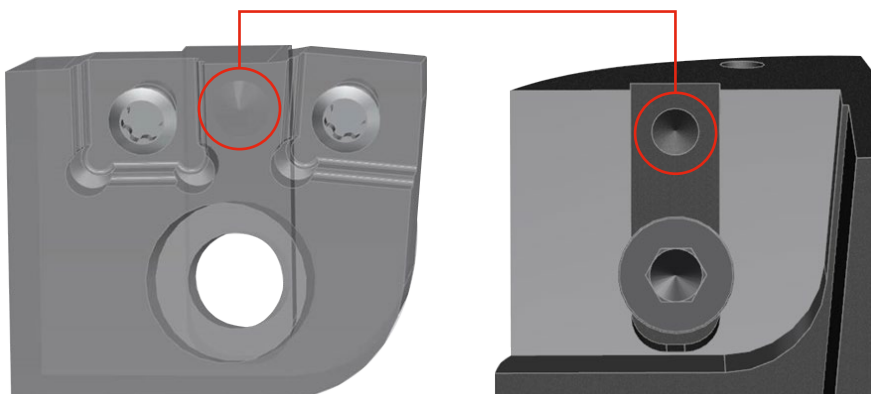

KUB Pentron CS – external cartridge

▲ SZID = nominal size

▲ Tightening torque refers to the clamping screws of the indexable inserts

Scope of supply:

External cartridge incl. clamping screws for indexable inserts

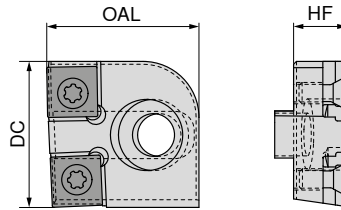
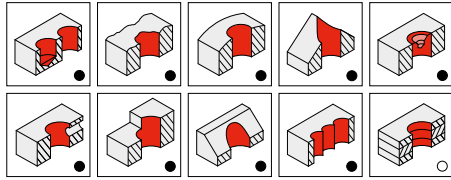

DC mm	KOMET no.	OAL mm	SZID	HF mm	torque moment Nm	Insert	£
64	D60 16400	27.8	1	9	2,8	SOGX 100408	286.76 16400
65	D60 16500	27.8	1	9	2,8	SOGX 100408	286.76 16500
66	D60 16600	27.8	1	9	2,8	SOGX 100408	286.76 16600
67	D60 16700	27.8	1	9	2,8	SOGX 100408	286.76 16700
68	D60 16800	27.8	1	9	2,8	SOGX 100408	286.76 16800
69	D60 16900	27.8	1	9	2,8	SOGX 100408	286.76 16900
70	D60 17000	29.8	2	10	2,8	SOGX 110408	286.76 27000
71	D60 17100	29.8	2	10	2,8	SOGX 110408	286.76 27100
72	D60 17200	29.8	2	10	2,8	SOGX 110408	286.76 27200
73	D60 17300	29.8	2	10	2,8	SOGX 110408	286.76 27300
74	D60 17400	29.8	2	10	2,8	SOGX 110408	286.76 27400
75	D60 17500	29.8	2	10	2,8	SOGX 110408	286.76 27500
76	D60 17600	32.8	3	11	6,25	SOGX 120408	286.76 37600
77	D60 17700	32.8	3	11	6,25	SOGX 120408	286.76 37700
78	D60 17800	32.8	3	11	6,25	SOGX 120408	286.76 37800
79	D60 17900	32.8	3	11	6,25	SOGX 120408	286.76 37900
80	D60 18000	32.8	3	11	6,25	SOGX 120408	286.76 38000
81	D60 18100	32.8	3	11	6,25	SOGX 120408	286.76 38100
82	D60 18200	32.8	3	11	6,25	SOGX 120408	286.76 38200
83	D60 18300	32.8	3	11	6,25	SOGX 120408	286.76 38300
84	D60 18400	32.8	3	11	6,25	SOGX 120408	286.76 38400
85	D60 18500	35.8	4	12	6,25	SOGX 130508	286.76 48500
86	D60 18600	35.8	4	12	6,25	SOGX 130508	286.76 48600
87	D60 18700	35.8	4	12	6,25	SOGX 130508	286.76 48700
88	D60 18800	35.8	4	12	6,25	SOGX 130508	286.76 48800
89	D60 18900	35.8	4	12	6,25	SOGX 130508	286.76 48900
90	D60 19000	35.8	4	12	6,25	SOGX 130508	286.76 49000
91	D60 19100	35.8	4	12	6,25	SOGX 130508	286.76 49100
92	D60 19200	35.8	4	12	6,25	SOGX 130508	286.76 49200
93	D60 19300	35.8	4	12	6,25	SOGX 130508	286.76 49300
94	D60 19400	35.8	4	12	6,25	SOGX 130508	286.76 49400
95	D60 19500	35.8	4	12	6,25	SOGX 130508	286.76 49500
96	D60 19600	35.8	4	12	6,25	SOGX 130508	286.76 49600

10 878 ...

£
2B/6#

Spare parts	DC		80 950 ...		10 950 ...	
			£		£	
			Y7		W7/6B	
64 - 75		T15 - IP	20.03	128	M3,5x7,5 - 15IP	2.73 10300
76 - 96		T20 - IP	21.03	129	M4,5x10 - 20IP	2.73 10400

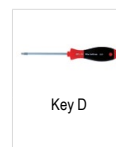

 Intermediate dimensions available on request.

SOGX

Designation	L mm	IC mm	D1 mm	S mm
SOGX 0402..	4.8	4.8	2.05	2.20
SOGX 0502..	5.5	5.5	2.30	2.40
SOGX 0602..	6.2	6.2	2.60	2.75
SOGX 07T2..	7.1	7.1	2.60	2.97
SOGX 0803..	8.0	8.0	2.85	3.40
SOGX 09T3..	8.9	8.9	3.40	3.90
SOGX 1004..	9.8	9.8	4.10	4.20
SOGX 1104..	10.9	10.9	4.10	4.50
SOGX 1204..	12.0	12.0	5.20	4.80
SOGX 1305..	13.2	13.2	5.20	5.20

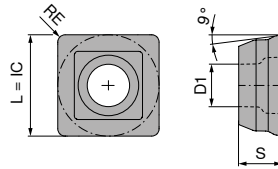

3

SOGX

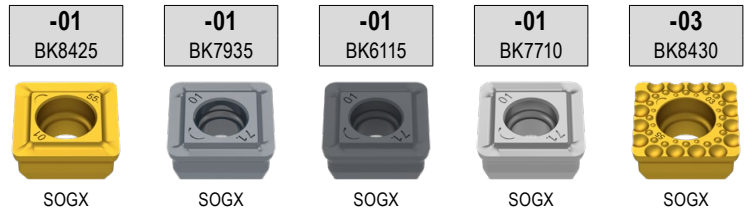

ISO	KOMET no.	RE mm	-01 BK8425		-01 BK7935		-01 BK6115		-01 BK7710		-03 BK8430	
			10 820 ... £ 1A/3#	30401	10 820 ... £ 1A/3#	50401	10 820 ... £ 1A/3#	40401	10 820 ... £ 1A/3#	90401	10 820 ... £ 1A/3#	00403
040204	W80 10010.046115	0.4					17.79	40401		17.80	90401	
040204	W80 10010.047710	0.4										
040204	W80 10010.047935	0.4										
040204	W80 10010.048425	0.4	17.79	30401	17.80	50401						
040204	W80 10030.048430	0.4									17.79	00403
050204	W80 12010.046115	0.4					17.91	40501		17.93	90501	
050204	W80 12010.047710	0.4										
050204	W80 12010.047935	0.4					17.93	50501				
050204	W80 12010.048425	0.4	17.91	30501								
050204	W80 12030.048430	0.4										
060206	W80 18010.066115	0.6					18.03	40601		18.05	90601	
060206	W80 18010.067710	0.6										
060206	W80 18010.067935	0.6					18.05	50601				
060206	W80 18010.068425	0.6	18.03	30601								
060206	W80 18030.068430	0.6									18.03	00603
07T208	W80 20010.086115	0.8					18.14	40701		18.19	90701	
07T208	W80 20010.087710	0.8										
07T208	W80 20010.087935	0.8					18.19	50701				
07T208	W80 20010.088425	0.8	18.14	30701								
07T208	W80 20030.088430	0.8									18.14	00703
080308	W80 24010.086115	0.8					18.26	40801		18.25	90801	
080308	W80 24010.087710	0.8										
080308	W80 24010.087935	0.8					18.25	50801				
080308	W80 24010.088425	0.8	18.26	30801								
080308	W80 24030.088430	0.8									18.26	00803
09T308	W80 28010.086115	0.8					18.94	40901		18.93	90901	
09T308	W80 28010.087710	0.8										
09T308	W80 28010.087935	0.8					18.93	50901				
09T308	W80 28010.088425	0.8	18.94	30901								
09T308	W80 28030.088430	0.8									18.94	00903
100408	W80 32010.086115	0.8					19.51	41001		19.56	91001	
100408	W80 32010.087710	0.8										
100408	W80 32010.087935	0.8					19.56	51001				
100408	W80 32010.088425	0.8	19.51	31001								
100408	W80 32030.088430	0.8									19.51	01003
110408	W80 38010.086115	0.8					20.10	41101		20.10	91101	
110408	W80 38010.087710	0.8										
110408	W80 38010.087935	0.8					20.10	51101				
110408	W80 38010.088425	0.8	20.10	31101								
110408	W80 38030.088430	0.8									20.10	01103
120408	W80 42010.086115	0.8					21.13	41201		21.11	91201	
120408	W80 42010.087710	0.8										
120408	W80 42010.087935	0.8					21.11	51201				
120408	W80 42010.088425	0.8	21.13	31201								
120408	W80 42030.088430	0.8									21.13	01203
130508	W80 46010.086115	0.8					24.57	41301		24.64	91301	
130508	W80 46010.087710	0.8										
130508	W80 46010.087935	0.8					24.64	51301				
130508	W80 46010.088425	0.8	24.57	31301								
130508	W80 46030.088430	0.8									24.57	01303
P			●		●		●				●	
M			●		●		●				●	
K			●		●		●				●	
N			○		○		○		●		○	
S			●		●		●		○		●	
H			○		○		○				○	
O					○				○			



→ v_c Page 62-67

1 BK6115 -01 is exclusively recommended for use on the peripheral cutting edge!

SOGX

ISO	KOMET no.	RE mm	-13 BK8425		NEW -21 BK8430		NEW -21 BK7935		-32 BK8425		-34 BK8425	
			SOGX		SOGX		SOGX		SOGX		SOGX	
			10 820 ...	10 820 ...	10 820 ...	10 820 ...	10 820 ...	10 820 ...	10 820 ...	10 820 ...		
			£ 1A/3#	£ 1A/3#	£ 1A/3#	£ 1A/3#	£ 1A/3#	£ 1A/3#	£ 1A/3#	£ 1A/3#	£ 1A/3#	£ 1A/3#
040204	W80 10130.048425	0.4										
040204	W80 10210.047935	0.4										
040204	W80 10210.048430	0.4										
040204	W80 10320.048425	0.4										
040204	W80 10340.048425	0.4										
050204	W80 12130.048425	0.4	17.91	30513								
050204	W80 12210.047935	0.4										
050204	W80 12210.048430	0.4			19.02	00521	19.02	50521				
050204	W80 12320.048425	0.4							19.89	30532		
050204	W80 12340.048425	0.4									19.89	30534
060206	W80 18130.068425	0.6	18.03	30613								
060206	W80 18210.067935	0.6										
060206	W80 18210.068430	0.6			19.16	00621	19.16	50621				
060206	W80 18320.068425	0.6							20.02	30632		
060206	W80 18340.068425	0.6									20.02	30634
07T208	W80 20130.088425	0.8	18.14	30713								
07T208	W80 20210.087935	0.8										
07T208	W80 20210.088430	0.8			19.27	00721	19.27	50721				
07T208	W80 20320.088425	0.8							20.16	30732		
07T208	W80 20340.088425	0.8									20.16	30734
080308	W80 24130.088425	0.8	18.26	30813								
080308	W80 24210.087935	0.8										
080308	W80 24210.088430	0.8			19.40	00821	19.40	50821				
080308	W80 24320.088425	0.8							20.30	30832		
080308	W80 24340.088425	0.8									20.30	30834
09T308	W80 28130.088425	0.8	18.94	30913								
09T308	W80 28210.087935	0.8										
09T308	W80 28210.088430	0.8			20.13	00921	20.13	50921				
09T308	W80 28320.088425	0.8							21.06	30932		
09T308	W80 28340.088425	0.8									21.06	30934
100408	W80 32130.088425	0.8	19.51	31013								
100408	W80 32210.087935	0.8										
100408	W80 32210.088430	0.8			20.74	01021	20.74	51021				
100408	W80 32320.088425	0.8							21.67	31032		
100408	W80 32340.088425	0.8									21.67	31034
110408	W80 38130.088425	0.8	20.10	31113								
110408	W80 38210.087935	0.8										
110408	W80 38210.088430	0.8			21.35	01121	21.35	51121				
110408	W80 38320.088425	0.8							22.32	31132		
110408	W80 38340.088425	0.8									22.32	31134
120408	W80 42130.088425	0.8	21.13	31213								
120408	W80 42210.087935	0.8										
120408	W80 42210.088430	0.8			22.45	01221	22.45	51221				
120408	W80 42320.088425	0.8							23.50	31232		
120408	W80 42340.088425	0.8									23.50	31234
130508	W80 46130.088425	0.8	24.57	31313								
130508	W80 46210.087935	0.8										
130508	W80 46210.088430	0.8			26.12	01321	26.12	51321				
130508	W80 46320.088425	0.8							27.29	31332		
130508	W80 46340.088425	0.8									27.29	31334
P			●	●	●	●	●	●	●	●	●	●
M			●	●	●	●	●	●	●	●	●	●
K			●	●	●	●	●	●	●	●	●	●
N			○	○	○	○	○	○	○	○	○	○
S			●	●	●	●	●	●	●	●	●	●
H			○	○	○	○	○	○	○	○	○	○
O												

→ v_c Page 62–67

-  BK7935 -21 is exclusively recommended for use on the peripheral cutting edge!
-  BK8425 -34 is recommended only for KUB Pentron 2xD and 3xD (10 872 ... / 10 873 ...)
-  Further information on grades and chip breakers can be found on page 85 + 86

 Further indexable inserts can be found in our online shop cuttingtools.ceratizit.com



KUB Trigon – Indexable insert drill

Scope of supply:

Indexable Insert Drill incl. clamping screws

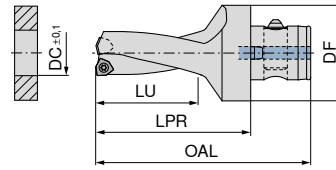
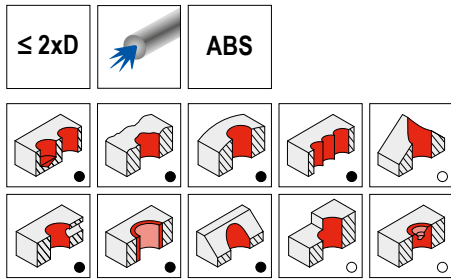

3

10 892 ...

Designation	KOMET no.	DC mm	DF mm	OAL mm	LU mm	LPR mm	torque moment Nm	Insert	£ 2B/6#
KUB-T.2D.140.R.03-ABS50	V30 31403	14	50	94	28	63	0,62	WOEX 030204	411.77 14095
KUB-T.2D.150.R.03-ABS50	V30 31503	15	50	96	30	65	0,62	WOEX 030204	411.77 15095
KUB-T.2D.160.R.03-ABS50	V30 31601	16	50	98	32	67	0,62	WOEX 030204	411.77 16095
KUB-T.2D.170.R.03-ABS50	V30 31701	17	50	100	34	69	0,62	WOEX 030204	411.77 17095
KUB-T.2D.180.R.03-ABS50	V30 31801	18	50	102	36	71	0,62	WOEX 030204	411.77 18095
KUB-T.2D.190.R.03-ABS50	V30 31901	19	50	104	38	73	0,62	WOEX 030204	411.77 19095
KUB-T.2D.200.R.04-ABS50	V30 32001	20	50	106	40	75	1,01	WOEX 040304	414.20 20095
KUB-T.2D.210.R.04-ABS50	V30 32101	21	50	108	42	77	1,01	WOEX 040304	414.20 21095
KUB-T.2D.220.R.04-ABS50	V30 32201	22	50	110	44	79	1,01	WOEX 040304	414.20 22095
KUB-T.2D.230.R.04-ABS50	V30 32301	23	50	112	46	81	1,01	WOEX 040304	414.20 23095
KUB-T.2D.240.R.04-ABS50	V30 32401	24	50	114	48	83	1,01	WOEX 040304	414.20 24095
KUB-T.2D.250.R.05-ABS50	V30 32501	25	50	116	50	85	1,28	WOEX 05T304	420.22 25095
KUB-T.2D.260.R.05-ABS50	V30 32601	26	50	118	52	87	1,28	WOEX 05T304	420.22 26095
KUB-T.2D.270.R.05-ABS50	V30 32701	27	50	120	54	89	1,28	WOEX 05T304	420.22 27095
KUB-T.2D.280.R.05-ABS50	V30 32801	28	50	122	56	91	1,28	WOEX 05T304	420.22 28095
KUB-T.2D.290.R.05-ABS50	V30 32901	29	50	124	58	93	1,28	WOEX 05T304	420.22 29095
KUB-T.2D.300.R.05-ABS50	V30 33001	30	50	131	60	100	1,28	WOEX 05T304	420.22 30095
KUB-T.2D.310.R.05-ABS50	V30 33101	31	50	133	62	102	1,28	WOEX 05T304	420.22 31095
KUB-T.2D.320.R.05-ABS50	V30 33201	32	50	135	64	104	1,28	WOEX 05T304	420.22 32095
KUB-T.2D.330.R.05-ABS50	V30 33301	33	50	137	66	106	1,28	WOEX 05T304	420.22 33095
KUB-T.2D.340.R.05-ABS50	V30 33401	34	50	139	68	108	1,28	WOEX 05T304	420.22 34095
KUB-T.2D.350.R.05-ABS50	V30 33501	35	50	141	70	110	1,28	WOEX 05T304	420.22 35095
KUB-T.2D.360.R.05-ABS50	V30 33601	36	50	143	72	112	1,28	WOEX 05T304	420.22 36095
KUB-T.2D.370.R.06-ABS50	V30 33701	37	50	155	74	124	2,8	WOEX 06T304	441.81 37095
KUB-T.2D.380.R.06-ABS50	V30 33801	38	50	157	76	126	2,8	WOEX 06T304	441.81 38095
KUB-T.2D.390.R.06-ABS50	V30 33901	39	50	159	78	128	2,8	WOEX 06T304	441.81 39095
KUB-T.2D.400.R.06-ABS50	V30 34001	40	50	161	80	130	2,8	WOEX 06T304	441.81 40095
KUB-T.2D.410.R.06-ABS50	V30 34101	41	50	163	82	132	2,8	WOEX 06T304	441.81 41095
KUB-T.2D.420.R.06-ABS50	V30 34201	42	50	165	84	134	2,8	WOEX 06T304	441.81 42095
KUB-T.2D.430.R.06-ABS50	V30 34301	43	50	167	86	136	2,8	WOEX 06T304	441.81 43095
KUB-T.2D.440.R.06-ABS50	V30 34401	44	50	169	88	138	2,8	WOEX 06T304	441.81 44095

Spare parts

DC	Key D	80 950 ...	Clamping screw	10 950 ...
	£	£	£	£
14 - 19	T06 - IP	17.37 123	M2,0x4,3 - 06IP	2.73 10000
20 - 24	T06 - IP	17.37 123	M2,2x5,5 - 06IP	2.73 10700
25 - 36	T08 - IP	17.13 125	M2,5x7,2 - 08IP	2.73 10500
37 - 44	T10 - IP	19.45 127	M3,5x7,3 - 10IP	2.73 10600

Matching holders can be found in → Chapter 16 Adapters and accessories in the clamping technology catalogue

KUB Trigon – Indexable insert drill

▲ Tightening torque refers to the clamping screws of the indexable inserts



Scope of supply:

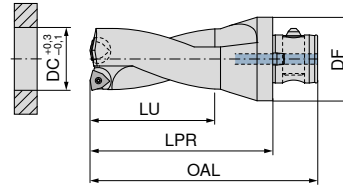
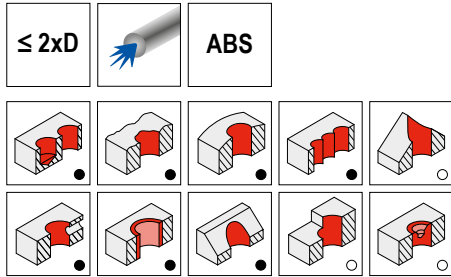

with indexable insert (10 897 ...) incl. fixing screw, cylindrical pin and clamping screw
with indexable insert (10 898 ...) incl. fixing screw, cylindrical pin and clamping screw

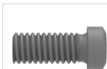

10 892 ...

Designation	KOMET no.	DC mm	DF mm	OAL mm	LU mm	LPR mm	torque moment Nm	Insert	10 892 ...	
									£	2B/6#
KUB-T.2D.450.R.08-ABS63	V13 34500	45	63	183	90	145	4,3	WOEX 080404	770.81	45096
KUB-T.2D.460.R.08-ABS63	V13 34600	46	63	185	92	147	4,3	WOEX 080404	770.81	46096
KUB-T.2D.470.R.08-ABS63	V13 34700	47	63	187	94	149	4,3	WOEX 080404	770.81	47096
KUB-T.2D.480.R.08-ABS63	V13 34800	48	63	189	96	151	4,3	WOEX 080404	770.81	48096
KUB-T.2D.490.R.08-ABS63	V13 34900	49	63	191	98	153	4,3	WOEX 080404	770.81	49096
KUB-T.2D.500.R.08-ABS63	V13 35000	50	63	193	100	155	4,3	WOEX 080404	770.81	50096
KUB-T.2D.510.R.08-ABS63	V13 35100	51	63	195	102	157	4,3	WOEX 080404	770.81	51096
KUB-T.2D.520.R.08-ABS63	V13 35200	52	63	197	104	159	4,3	WOEX 080404	770.81	52096
KUB-T.2D.530.R.08-ABS63	V13 35300	53	63	199	106	161	4,3	WOEX 080404	770.81	53096
KUB-T.2D.540.R.08-ABS63	V13 35400	54	63	201	108	163	4,3	WOEX 080404	770.81	54096
KUB-T.2D.550.R.10-ABS80	V14 35500	55	80	208	110	165	4,3	WOEX 100504	931.62	55098
KUB-T.2D.560.R.10-ABS80	V14 35600	56	80	210	112	167	4,3	WOEX 100504	931.62	56098
KUB-T.2D.570.R.10-ABS80	V14 35700	57	80	212	114	169	4,3	WOEX 100504	931.62	57098
KUB-T.2D.580.R.10-ABS80	V14 35800	58	80	214	116	171	4,3	WOEX 100504	931.62	58098
KUB-T.2D.590.R.10-ABS80	V14 35900	59	80	216	118	173	4,3	WOEX 100504	931.62	59098
KUB-T.2D.600.R.10-ABS80	V14 36000	60	80	218	120	175	4,3	WOEX 100504	931.62	60098
KUB-T.2D.610.R.10-ABS80	V14 36100	61	80	220	122	177	4,3	WOEX 100504	931.62	61098
KUB-T.2D.620.R.10-ABS80	V14 36200	62	80	222	124	179	4,3	WOEX 100504	931.62	62098
KUB-T.2D.630.R.10-ABS80	V14 36300	63	80	224	126	181	4,3	WOEX 100504	931.62	63098
KUB-T.2D.640.R.10-ABS80	V14 36400	64	80	226	128	183	4,3	WOEX 100504	931.62	64098
KUB-T.2D.650.R.10-ABS80	V14 36500	65	80	228	130	185	4,3	WOEX 100504	931.62	65098
KUB-T.2D.660.R.10-ABS80	V14 36600	66	80	230	132	187	4,3	WOEX 100504	931.62	66098
KUB-T.2D.670.R.10-ABS80	V14 36700	67	80	232	134	189	4,3	WOEX 100504	931.62	67098
KUB-T.2D.680.R.10-ABS80	V14 36800	68	80	234	136	191	4,3	WOEX 100504	931.62	68098
KUB-T.2D.690.R.12-ABS80	V14 36900	69	80	246	138	203	6,25	WOEX 120608	985.64	69098
KUB-T.2D.700.R.12-ABS80	V14 37000	70	80	248	140	205	6,25	WOEX 120608	985.64	70098
KUB-T.2D.710.R.12-ABS80	V14 37100	71	80	250	142	207	6,25	WOEX 120608	985.64	71098
KUB-T.2D.720.R.12-ABS80	V14 37200	72	80	252	144	209	6,25	WOEX 120608	985.64	72098
KUB-T.2D.730.R.12-ABS80	V14 37300	73	80	254	146	211	6,25	WOEX 120608	985.64	73098
KUB-T.2D.740.R.12-ABS80	V14 37400	74	80	256	148	213	6,25	WOEX 120608	985.64	74098
KUB-T.2D.750.R.12-ABS80	V14 37500	75	80	258	150	215	6,25	WOEX 120608	985.64	75098
KUB-T.2D.760.R.12-ABS80	V14 37600	76	80	260	152	217	6,25	WOEX 120608	985.64	76098
KUB-T.2D.770.R.12-ABS80	V14 37700	77	80	262	154	219	6,25	WOEX 120608	985.64	77098
KUB-T.2D.780.R.12-ABS80	V14 37800	78	80	264	156	221	6,25	WOEX 120608	985.64	78098
KUB-T.2D.790.R.12-ABS80	V14 37900	79	80	266	158	223	6,25	WOEX 120608	985.64	79098
KUB-T.2D.800.R.12-ABS80	V14 38000	80	80	268	160	225	6,25	WOEX 120608	985.64	80098
KUB-T.2D.810.R.12-ABS80	V14 38100	81	80	270	162	227	6,25	WOEX 120608	985.64	81098
KUB-T.2D.820.R.12-ABS80	V14 38200	82	80	272	164	229	6,25	WOEX 120608	985.64	82098

							
		80 950 ...		10 950 ...		10 950 ...	
Spare parts		£		£		£	
DC		Y7		W7/6B		W7/6B	
45 - 54	T15 - IP	15.30	120	M4,5x9 - 15IP	2.93 12700	M4,5x9 - 10IP	3.30 17000
55 - 68	T15 - IP	15.30	120	M4,5x9 - 15IP	2.93 12700	M4,5x9 - 10IP	3.30 17000
69 - 82	T20 - IP	16.39	121	M5,5x11 - 20IP	2.93 17400	M5,5x13,5 - 20IP	3.30 17100

							
		10 950 ...		10 897 ...		10 898 ...	
Spare parts		£		£		£	
DC		W7/6B		2B/6#		2B/6#	
45 - 54	Ø3	1.22	17200	89.45	14800	89.45	14800
55 - 68	Ø3	1.22	17200	97.01	25300	97.01	25300
69 - 82	Ø4	1.35	17300	103.26	36000	103.26	36000

 Matching holders can be found in → Chapter 16 Adapters and accessoires in the clamping technology catalogue

KUB Trigon – Indexable insert drill

▲ left-hand cutting

Scope of supply:

Indexable Insert Drill incl. clamping screws

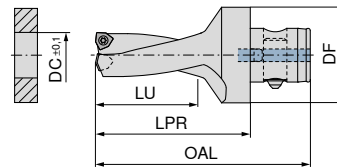
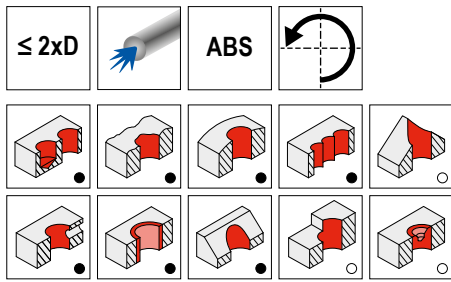

11 892 ...

Designation	KOMET no.	DC mm	DF mm	OAL mm	LU mm	LPR mm	torque moment Nm	Insert	£ 2B/6#
KUB-T.2D.140.L.03-ABS50	V30 21402	14	50	94	28	63	0,62	WOEX 030204	411.77 14095
KUB-T.2D.150.L.03-ABS50	V30 21502	15	50	96	30	65	0,62	WOEX 030204	411.77 15095
KUB-T.2D.160.L.03-ABS50	V30 21600	16	50	98	32	67	0,62	WOEX 030204	411.77 16095
KUB-T.2D.170.L.03-ABS50	V30 21700	17	50	100	34	69	0,62	WOEX 030204	411.77 17095
KUB-T.2D.180.L.03-ABS50	V30 21800	18	50	102	36	71	0,62	WOEX 030204	411.77 18095
KUB-T.2D.190.L.03-ABS50	V30 21900	19	50	104	38	73	0,62	WOEX 030204	411.77 19095
KUB-T.2D.200.L.04-ABS50	V30 22000	20	50	106	40	75	1,01	WOEX 040304	414.20 20095
KUB-T.2D.210.L.04-ABS50	V30 22100	21	50	108	42	77	1,01	WOEX 040304	414.20 21095
KUB-T.2D.220.L.04-ABS50	V30 22200	22	50	110	44	79	1,01	WOEX 040304	414.20 22095
KUB-T.2D.230.L.04-ABS50	V30 22300	23	50	112	46	81	1,01	WOEX 040304	414.20 23095
KUB-T.2D.240.L.04-ABS50	V30 22400	24	50	114	48	83	1,01	WOEX 040304	414.20 24095
KUB-T.2D.250.L.05-ABS50	V30 22500	25	50	116	50	85	1,28	WOEX 05T304	420.22 25095
KUB-T.2D.260.L.05-ABS50	V30 22600	26	50	118	52	87	1,28	WOEX 05T304	420.22 26095
KUB-T.2D.270.L.05-ABS50	V30 22700	27	50	120	54	89	1,28	WOEX 05T304	420.22 27095
KUB-T.2D.280.L.05-ABS50	V30 22800	28	50	122	56	91	1,28	WOEX 05T304	420.22 28095
KUB-T.2D.290.L.05-ABS50	V30 22900	29	50	124	58	93	1,28	WOEX 05T304	420.22 29095
KUB-T.2D.300.L.05-ABS50	V30 23000	30	50	131	60	100	1,28	WOEX 05T304	420.22 30095
KUB-T.2D.310.L.05-ABS50	V30 23100	31	50	133	62	102	1,28	WOEX 05T304	420.22 31095
KUB-T.2D.320.L.05-ABS50	V30 23200	32	50	135	64	104	1,28	WOEX 05T304	420.22 32095
KUB-T.2D.330.L.05-ABS50	V30 23300	33	50	137	66	106	1,28	WOEX 05T304	420.22 33095
KUB-T.2D.340.L.05-ABS50	V30 23400	34	50	139	68	108	1,28	WOEX 05T304	420.22 34095
KUB-T.2D.350.L.05-ABS50	V30 23500	35	50	141	70	110	1,28	WOEX 05T304	420.22 35095
KUB-T.2D.360.L.05-ABS50	V30 23600	36	50	143	72	112	1,28	WOEX 05T304	420.22 36095
KUB-T.2D.370.L.06-ABS50	V30 23700	37	50	155	74	124	2,8	WOEX 06T304	441.81 37095
KUB-T.2D.380.L.06-ABS50	V30 23800	38	50	157	76	126	2,8	WOEX 06T304	441.81 38095
KUB-T.2D.390.L.06-ABS50	V30 23900	39	50	159	78	128	2,8	WOEX 06T304	441.81 39095
KUB-T.2D.400.L.06-ABS50	V30 24000	40	50	161	80	130	2,8	WOEX 06T304	441.81 40095
KUB-T.2D.410.L.06-ABS50	V30 24100	41	50	163	82	132	2,8	WOEX 06T304	441.81 41095
KUB-T.2D.420.L.06-ABS50	V30 24200	42	50	165	84	134	2,8	WOEX 06T304	441.81 42095
KUB-T.2D.430.L.06-ABS50	V30 24300	43	50	167	86	136	2,8	WOEX 06T304	441.81 43095
KUB-T.2D.440.L.06-ABS50	V30 24400	44	50	169	88	138	2,8	WOEX 06T304	441.81 44095

Spare parts

DC	Key D	Clamping screw
14 - 19	T06 - IP	M2,0x4,3 - 06IP
20 - 24	T06 - IP	M2,2x5,5 - 06IP
25 - 36	T08 - IP	M2,5x7,2 - 08IP
37 - 44	T10 - IP	M3,5x7,3 - 10IP

Matching holders can be found in → Chapter 16 Adapters and accessories in the clamping technology catalogue

KUB Trigon – Indexable insert drill

Scope of supply:

Indexable Insert Drill incl. clamping screws

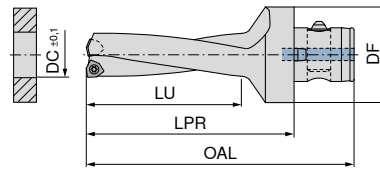
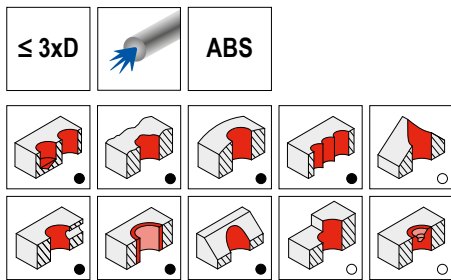

3

10 893 ...

Designation	KOMET no.	DC mm	DF mm	OAL mm	LU mm	LPR mm	torque moment Nm	Insert	£ 2B/6#
KUB-T.3D.140.R.03-ABS50	V30 71403	14	50	108	42	77	0,62	WOEX 030204	452.64 14095
KUB-T.3D.150.R.03-ABS50	V30 71503	15	50	111	45	80	0,62	WOEX 030204	452.64 15095
KUB-T.3D.160.R.03-ABS50	V30 71601	16	50	114	48	83	0,62	WOEX 030204	452.64 16095
KUB-T.3D.170.R.03-ABS50	V30 71701	17	50	117	51	86	0,62	WOEX 030204	452.64 17095
KUB-T.3D.180.R.03-ABS50	V30 71801	18	50	120	54	89	0,62	WOEX 030204	452.64 18095
KUB-T.3D.190.R.03-ABS50	V30 71901	19	50	123	57	92	0,62	WOEX 030204	452.64 19095
KUB-T.3D.200.R.04-ABS50	V30 72001	20	50	126	60	95	1,01	WOEX 040304	461.06 20095
KUB-T.3D.210.R.04-ABS50	V30 72101	21	50	129	63	98	1,01	WOEX 040304	461.06 21095
KUB-T.3D.220.R.04-ABS50	V30 72201	22	50	132	66	101	1,01	WOEX 040304	461.06 22095
KUB-T.3D.230.R.04-ABS50	V30 72301	23	50	135	69	104	1,01	WOEX 040304	461.06 23095
KUB-T.3D.240.R.04-ABS50	V30 72401	24	50	138	72	107	1,01	WOEX 040304	461.06 24095
KUB-T.3D.250.R.05-ABS50	V30 72501	25	50	141	75	110	1,28	WOEX 05T304	471.82 25095
KUB-T.3D.260.R.05-ABS50	V30 72601	26	50	144	78	113	1,28	WOEX 05T304	471.82 26095
KUB-T.3D.270.R.05-ABS50	V30 72701	27	50	147	81	116	1,28	WOEX 05T304	471.82 27095
KUB-T.3D.280.R.05-ABS50	V30 72801	28	50	150	84	119	1,28	WOEX 05T304	471.82 28095
KUB-T.3D.290.R.05-ABS50	V30 72901	29	50	153	87	122	1,28	WOEX 05T304	471.82 29095
KUB-T.3D.300.R.05-ABS50	V30 73001	30	50	161	90	130	1,28	WOEX 05T304	471.82 30095
KUB-T.3D.310.R.05-ABS50	V30 73101	31	50	164	93	133	1,28	WOEX 05T304	471.82 31095
KUB-T.3D.320.R.05-ABS50	V30 73201	32	50	167	96	136	1,28	WOEX 05T304	471.82 32095
KUB-T.3D.330.R.05-ABS50	V30 73301	33	50	170	99	139	1,28	WOEX 05T304	471.82 33095
KUB-T.3D.340.R.05-ABS50	V30 73401	34	50	173	102	142	1,28	WOEX 05T304	471.82 34095
KUB-T.3D.350.R.05-ABS50	V30 73501	35	50	176	105	145	1,28	WOEX 05T304	471.82 35095
KUB-T.3D.360.R.05-ABS50	V30 73601	36	50	179	108	148	1,28	WOEX 05T304	471.82 36095
KUB-T.3D.370.R.06-ABS50	V30 73701	37	50	192	111	161	2,8	WOEX 06T304	512.69 37095
KUB-T.3D.380.R.06-ABS50	V30 73801	38	50	195	114	164	2,8	WOEX 06T304	512.69 38095
KUB-T.3D.390.R.06-ABS50	V30 73901	39	50	198	117	167	2,8	WOEX 06T304	512.69 39095
KUB-T.3D.400.R.06-ABS50	V30 74001	40	50	201	120	170	2,8	WOEX 06T304	512.69 40095
KUB-T.3D.410.R.06-ABS50	V30 74101	41	50	204	123	173	2,8	WOEX 06T304	512.69 41095
KUB-T.3D.420.R.06-ABS50	V30 74201	42	50	207	126	176	2,8	WOEX 06T304	512.69 42095
KUB-T.3D.430.R.06-ABS50	V30 74301	43	50	210	129	179	2,8	WOEX 06T304	512.69 43095
KUB-T.3D.440.R.06-ABS50	V30 74401	44	50	213	132	182	2,8	WOEX 06T304	512.69 44095

Spare parts

DC	80 950 ...	£ Y7	10 950 ...	£ W7/6B
14 - 19	T06 - IP	17.37 123	M2,0x4,3 - 06IP	2.73 10000
20 - 24	T06 - IP	17.37 123	M2,2x5,5 - 06IP	2.73 10700
25 - 36	T08 - IP	17.13 125	M2,5x7,2 - 08IP	2.73 10500
37 - 44	T10 - IP	19.45 127	M3,5x7,3 - 10IP	2.73 10600

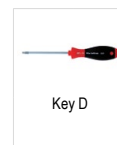

Key D



Clamping screw

Matching holders can be found in → Chapter 16 Adapters and accessories in the clamping technology catalogue

KUB Trigon – Indexable insert drill

▲ Tightening torque refers to the clamping screws of the indexable inserts



Scope of supply:

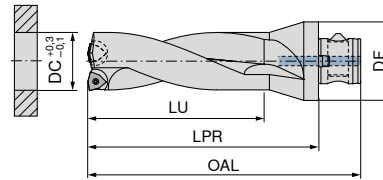
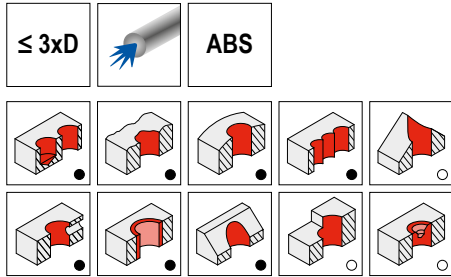

with indexable insert (10 897 ...) incl. fixing screw, cylindrical pin and clamping screw
with indexable insert (10 898 ...) incl. fixing screw, cylindrical pin and clamping screw

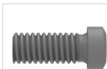

10 893 ...

Designation	KOMET no.	DC mm	DF mm	OAL mm	LU mm	LPR mm	torque moment Nm	Insert	10 893 ...	
									£	2B/6#
KUB-T.3D.450.R.08-ABS63	V13 74500	45	63	228	135	190	4,3	WOEX 080404	863.28	45096
KUB-T.3D.460.R.08-ABS63	V13 74600	46	63	231	138	193	4,3	WOEX 080404	863.28	46096
KUB-T.3D.470.R.08-ABS63	V13 74700	47	63	234	141	196	4,3	WOEX 080404	863.28	47096
KUB-T.3D.480.R.08-ABS63	V13 74800	48	63	237	144	199	4,3	WOEX 080404	863.28	48096
KUB-T.3D.490.R.08-ABS63	V13 74900	49	63	240	147	202	4,3	WOEX 080404	863.28	49096
KUB-T.3D.500.R.08-ABS63	V13 75000	50	63	243	150	205	4,3	WOEX 080404	863.28	50096
KUB-T.3D.510.R.08-ABS63	V13 75100	51	63	246	153	208	4,3	WOEX 080404	863.28	51096
KUB-T.3D.520.R.08-ABS63	V13 75200	52	63	249	156	211	4,3	WOEX 080404	863.28	52096
KUB-T.3D.530.R.08-ABS63	V13 75300	53	63	252	159	214	4,3	WOEX 080404	863.28	53096
KUB-T.3D.540.R.08-ABS63	V13 75400	54	63	255	162	217	4,3	WOEX 080404	863.28	54096
KUB-T.3D.550.R.10-ABS80	V14 75500	55	80	263	165	220	4,3	WOEX 100504	1,038.52	55098
KUB-T.3D.560.R.10-ABS80	V14 75600	56	80	266	168	223	4,3	WOEX 100504	1,038.52	56098
KUB-T.3D.570.R.10-ABS80	V14 75700	57	80	269	171	226	4,3	WOEX 100504	1,038.52	57098
KUB-T.3D.580.R.10-ABS80	V14 75800	58	80	272	174	229	4,3	WOEX 100504	1,038.52	58098
KUB-T.3D.590.R.10-ABS80	V14 75900	59	80	275	177	232	4,3	WOEX 100504	1,038.52	59098
KUB-T.3D.600.R.10-ABS80	V14 76000	60	80	278	180	235	4,3	WOEX 100504	1,038.52	60098
KUB-T.3D.610.R.10-ABS80	V14 76100	61	80	281	183	238	4,3	WOEX 100504	1,038.52	61098
KUB-T.3D.620.R.10-ABS80	V14 76200	62	80	284	186	241	4,3	WOEX 100504	1,038.52	62098
KUB-T.3D.630.R.10-ABS80	V14 76300	63	80	287	189	244	4,3	WOEX 100504	1,038.52	63098
KUB-T.3D.640.R.10-ABS80	V14 76400	64	80	290	192	247	4,3	WOEX 100504	1,038.52	64098
KUB-T.3D.650.R.10-ABS80	V14 76500	65	80	293	195	250	4,3	WOEX 100504	1,038.52	65098
KUB-T.3D.660.R.10-ABS80	V14 76600	66	80	296	198	253	4,3	WOEX 100504	1,038.52	66098
KUB-T.3D.670.R.10-ABS80	V14 76700	67	80	299	201	256	4,3	WOEX 100504	1,038.52	67098
KUB-T.3D.680.R.10-ABS80	V14 76800	68	80	302	204	259	4,3	WOEX 100504	1,038.52	68098
KUB-T.3D.690.R.12-ABS80	V14 76900	69	80	315	207	272	6,25	WOEX 120608	1,098.54	69098
KUB-T.3D.700.R.12-ABS80	V14 77000	70	80	318	210	275	6,25	WOEX 120608	1,098.54	70098
KUB-T.3D.710.R.12-ABS80	V14 77100	71	80	321	213	278	6,25	WOEX 120608	1,098.54	71098
KUB-T.3D.720.R.12-ABS80	V14 77200	72	80	324	216	281	6,25	WOEX 120608	1,098.54	72098
KUB-T.3D.730.R.12-ABS80	V14 77300	73	80	327	219	284	6,25	WOEX 120608	1,098.54	73098
KUB-T.3D.740.R.12-ABS80	V14 77400	74	80	330	222	287	6,25	WOEX 120608	1,098.54	74098
KUB-T.3D.750.R.12-ABS80	V14 77500	75	80	333	225	290	6,25	WOEX 120608	1,098.54	75098
KUB-T.3D.760.R.12-ABS80	V14 77600	76	80	336	228	293	6,25	WOEX 120608	1,098.54	76098
KUB-T.3D.770.R.12-ABS80	V14 77700	77	80	339	231	296	6,25	WOEX 120608	1,098.54	77098
KUB-T.3D.780.R.12-ABS80	V14 77800	78	80	342	234	299	6,25	WOEX 120608	1,098.54	78098
KUB-T.3D.790.R.12-ABS80	V14 77900	79	80	345	237	302	6,25	WOEX 120608	1,098.54	79098
KUB-T.3D.800.R.12-ABS80	V14 78000	80	80	348	240	305	6,25	WOEX 120608	1,098.54	80098
KUB-T.3D.810.R.12-ABS80	V14 78100	81	80	351	243	308	6,25	WOEX 120608	1,098.54	81098
KUB-T.3D.820.R.12-ABS80	V14 78200	82	80	354	246	311	6,25	WOEX 120608	1,098.54	82098

							
		80 950 ...		10 950 ...		10 950 ...	
Spare parts		£		£		£	
DC		Y7		W7/6B		W7/6B	
45 - 54	T15 - IP	15.30	120	M4,5x9 - 15IP	2.93 12700	M4,5x9 - 10IP	3.30 17000
55 - 68	T15 - IP	15.30	120	M4,5x9 - 15IP	2.93 12700	M4,5x9 - 10IP	3.30 17000
69 - 82	T20 - IP	16.39	121	M5,5x11 - 20IP	2.93 17400	M5,5x13,5 - 20IP	3.30 17100

							
		10 950 ...		10 897 ...		10 898 ...	
Spare parts		£		£		£	
DC		W7/6B		2B/6#		2B/6#	
45 - 54	Ø3	1.22	17200	89.45	14800	89.45	14800
55 - 68	Ø3	1.22	17200	97.01	25300	97.01	25300
69 - 82	Ø4	1.35	17300	103.26	36000	103.26	36000

 Matching holders can be found in → Chapter 16 Adapters and accessoires in the clamping technology catalogue

KUB Trigon – Indexable insert drill

▲ left-hand cutting

Scope of supply:

Indexable Insert Drill incl. clamping screws

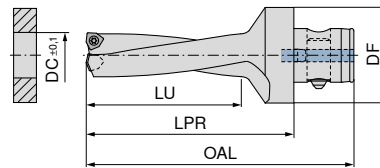
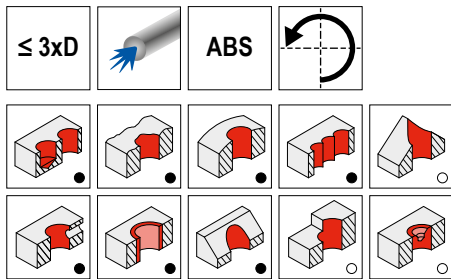

11 893 ...

Designation	KOMET no.	DC mm	DF mm	OAL mm	LU mm	LPR mm	torque moment Nm	Insert	£ 2B/6#	...
KUB-T.3D.140.L.03-ABS50	V30 61402	14	50	108	42	77	0,62	WOEX 030204	452.64	14095
KUB-T.3D.150.L.03-ABS50	V30 61502	15	50	111	45	80	0,62	WOEX 030204	452.64	15095
KUB-T.3D.160.L.03-ABS50	V30 61600	16	50	114	48	83	0,62	WOEX 030204	452.64	16095
KUB-T.3D.170.L.03-ABS50	V30 61700	17	50	117	51	86	0,62	WOEX 030204	452.64	17095
KUB-T.3D.180.L.03-ABS50	V30 61800	18	50	120	54	89	0,62	WOEX 030204	452.64	18095
KUB-T.3D.190.L.03-ABS50	V30 61900	19	50	123	57	92	0,62	WOEX 030204	452.64	19095
KUB-T.3D.200.L.04-ABS50	V30 62000	20	50	126	60	95	1,01	WOEX 040304	461.06	20095
KUB-T.3D.210.L.04-ABS50	V30 62100	21	50	129	63	98	1,01	WOEX 040304	461.06	21095
KUB-T.3D.220.L.04-ABS50	V30 62200	22	50	132	66	101	1,01	WOEX 040304	461.06	22095
KUB-T.3D.230.L.04-ABS50	V30 62300	23	50	135	69	104	1,01	WOEX 040304	461.06	23095
KUB-T.3D.240.L.04-ABS50	V30 62400	24	50	138	72	107	1,01	WOEX 040304	461.06	24095
KUB-T.3D.250.L.05-ABS50	V30 62500	25	50	141	75	110	1,28	WOEX 05T304	471.82	25095
KUB-T.3D.260.L.05-ABS50	V30 62600	26	50	144	78	113	1,28	WOEX 05T304	471.82	26095
KUB-T.3D.270.L.05-ABS50	V30 62700	27	50	147	81	116	1,28	WOEX 05T304	471.82	27095
KUB-T.3D.280.L.05-ABS50	V30 62800	28	50	150	84	119	1,28	WOEX 05T304	471.82	28095
KUB-T.3D.290.L.05-ABS50	V30 62900	29	50	153	87	122	1,28	WOEX 05T304	471.82	29095
KUB-T.3D.300.L.05-ABS50	V30 63000	30	50	161	90	130	1,28	WOEX 05T304	471.82	30095
KUB-T.3D.310.L.05-ABS50	V30 63100	31	50	164	93	133	1,28	WOEX 05T304	471.82	31095
KUB-T.3D.320.L.05-ABS50	V30 63200	32	50	167	96	136	1,28	WOEX 05T304	471.82	32095
KUB-T.3D.330.L.05-ABS50	V30 63300	33	50	170	99	139	1,28	WOEX 05T304	471.82	33095
KUB-T.3D.340.L.05-ABS50	V30 63400	34	50	173	102	142	1,28	WOEX 05T304	471.82	34095
KUB-T.3D.350.L.05-ABS50	V30 63500	35	50	176	105	145	1,28	WOEX 05T304	471.82	35095
KUB-T.3D.360.L.05-ABS50	V30 63600	36	50	179	108	148	1,28	WOEX 05T304	471.82	36095
KUB-T.3D.370.L.06-ABS50	V30 63700	37	50	192	111	161	2,8	WOEX 06T304	512.69	37095
KUB-T.3D.380.L.06-ABS50	V30 63800	38	50	195	114	164	2,8	WOEX 06T304	512.69	38095
KUB-T.3D.390.L.06-ABS50	V30 63900	39	50	198	117	167	2,8	WOEX 06T304	512.69	39095
KUB-T.3D.400.L.06-ABS50	V30 64000	40	50	201	120	170	2,8	WOEX 06T304	512.69	40095
KUB-T.3D.410.L.06-ABS50	V30 64100	41	50	204	123	173	2,8	WOEX 06T304	512.69	41095
KUB-T.3D.420.L.06-ABS50	V30 64200	42	50	207	126	176	2,8	WOEX 06T304	512.69	42095
KUB-T.3D.430.L.06-ABS50	V30 64300	43	50	210	129	179	2,8	WOEX 06T304	512.69	43095
KUB-T.3D.440.L.06-ABS50	V30 64400	44	50	213	132	182	2,8	WOEX 06T304	512.69	44095



Key D



Clamping screw

80 950 ...

10 950 ...

Spare parts

DC		£ Y7		£ W7/6B	
14 - 19	T06 - IP	17.37	123	M2,0x4,3 - 06IP	2.73 10000
20 - 24	T06 - IP	17.37	123	M2,2x5,5 - 06IP	2.73 10700
25 - 36	T08 - IP	17.13	125	M2,5x7,2 - 08IP	2.73 10500
37 - 44	T10 - IP	19.45	127	M3,5x7,3 - 10IP	2.73 10600

Matching holders can be found in → Chapter 16 Adapters and accessories in the clamping technology catalogue

KUB Trigon – Indexable insert drill

Scope of supply:

Indexable Insert Drill incl. clamping screws

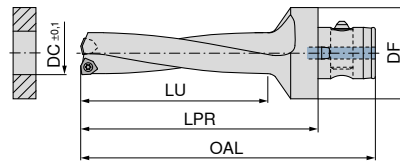
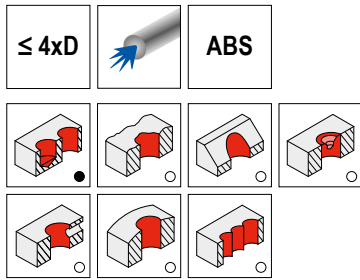

3

10 894 ...

Designation	KOMET no.	DC mm	DF mm	OAL mm	LU mm	LPR mm	torque moment Nm	Insert	£ 2B/6#
KUB-T.4D.140.R.03-ABS50	V30 91403	14	50	122	56	91	0,62	WOEX 030204	498.25 14095
KUB-T.4D.150.R.03-ABS50	V30 91503	15	50	126	60	95	0,62	WOEX 030204	498.25 15095
KUB-T.4D.160.R.03-ABS50	V30 91601	16	50	130	64	99	0,62	WOEX 030204	498.25 16095
KUB-T.4D.170.R.03-ABS50	V30 91701	17	50	134	68	103	0,62	WOEX 030204	498.25 17095
KUB-T.4D.180.R.03-ABS50	V30 91801	18	50	138	72	107	0,62	WOEX 030204	498.25 18095
KUB-T.4D.190.R.03-ABS50	V30 91901	19	50	142	76	111	0,62	WOEX 030204	498.25 19095
KUB-T.4D.200.R.04-ABS50	V30 92001	20	50	146	80	115	1,01	WOEX 040304	507.84 20095
KUB-T.4D.210.R.04-ABS50	V30 92101	21	50	150	84	119	1,01	WOEX 040304	507.84 21095
KUB-T.4D.220.R.04-ABS50	V30 92201	22	50	154	88	123	1,01	WOEX 040304	507.84 22095
KUB-T.4D.230.R.04-ABS50	V30 92301	23	50	158	92	127	1,01	WOEX 040304	507.84 23095
KUB-T.4D.240.R.04-ABS50	V30 92401	24	50	162	96	131	1,01	WOEX 040304	507.84 24095
KUB-T.4D.250.R.05-ABS50	V30 92501	25	50	166	100	135	1,28	WOEX 05T304	518.67 25095
KUB-T.4D.260.R.05-ABS50	V30 92601	26	50	170	104	139	1,28	WOEX 05T304	518.67 26095
KUB-T.4D.270.R.05-ABS50	V30 92701	27	50	174	108	143	1,28	WOEX 05T304	518.67 27095
KUB-T.4D.280.R.05-ABS50	V30 92801	28	50	178	112	147	1,28	WOEX 05T304	518.67 28095
KUB-T.4D.290.R.05-ABS50	V30 92901	29	50	182	116	151	1,28	WOEX 05T304	518.67 29095
KUB-T.4D.300.R.05-ABS50	V30 93001	30	50	191	120	160	1,28	WOEX 05T304	518.67 30095
KUB-T.4D.310.R.05-ABS50	V30 93101	31	50	195	124	164	1,28	WOEX 05T304	518.67 31095
KUB-T.4D.320.R.05-ABS50	V30 93201	32	50	199	128	168	1,28	WOEX 05T304	518.67 32095
KUB-T.4D.330.R.05-ABS50	V30 93301	33	50	203	132	172	1,28	WOEX 05T304	518.67 33095
KUB-T.4D.340.R.05-ABS50	V30 93401	34	50	207	136	176	1,28	WOEX 05T304	518.67 34095
KUB-T.4D.350.R.05-ABS50	V30 93501	35	50	211	140	180	1,28	WOEX 05T304	518.67 35095
KUB-T.4D.360.R.05-ABS50	V30 93601	36	50	215	144	184	1,28	WOEX 05T304	518.67 36095
KUB-T.4D.370.R.06-ABS50	V30 93701	37	50	229	148	198	2,8	WOEX 06T304	563.12 37095
KUB-T.4D.380.R.06-ABS50	V30 93801	38	50	233	152	202	2,8	WOEX 06T304	563.12 38095
KUB-T.4D.390.R.06-ABS50	V30 93901	39	50	237	156	206	2,8	WOEX 06T304	563.12 39095
KUB-T.4D.400.R.06-ABS50	V30 94001	40	50	241	160	210	2,8	WOEX 06T304	563.12 40095
KUB-T.4D.410.R.06-ABS50	V30 94101	41	50	245	164	214	2,8	WOEX 06T304	563.12 41095
KUB-T.4D.420.R.06-ABS50	V30 94201	42	50	249	168	218	2,8	WOEX 06T304	563.12 42095
KUB-T.4D.430.R.06-ABS50	V30 94301	43	50	253	172	222	2,8	WOEX 06T304	563.12 43095
KUB-T.4D.440.R.06-ABS50	V30 94401	44	50	257	176	226	2,8	WOEX 06T304	563.12 44095

Spare parts

DC	80 950 ...	£ Y7	10 950 ...	£ W7/6B
14 - 19	T06 - IP	17.37 123	M2,0x4,3 - 06IP	2.73 10000
20 - 24	T06 - IP	17.37 123	M2,2x5,5 - 06IP	2.73 10700
25 - 36	T08 - IP	17.13 125	M2,5x7,2 - 08IP	2.73 10500
37 - 44	T10 - IP	19.45 127	M3,5x7,3 - 10IP	2.73 10600

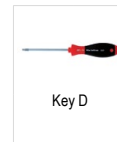

Key D



Clamping screw

Matching holders can be found in → Chapter 16 Adapters and accessoires in the clamping technology catalogue

KUB Trigon – Indexable insert drill

Scope of supply:

Indexable Insert Drill incl. clamping screws

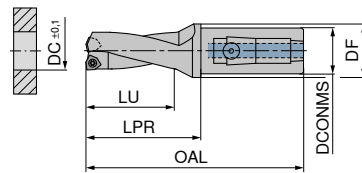
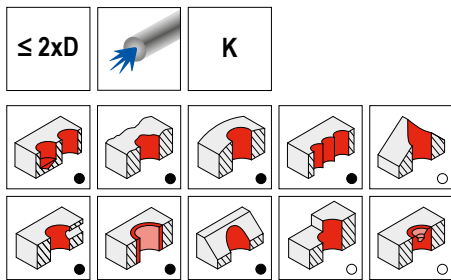

10 892 ...

Designation	KOMET no.	DC mm	DCONMS mm	DF mm	OAL mm	LU mm	LPR mm	torque moment Nm	Insert	£	
										2B/6#	
KUB-T.2D.140.R.03-K20	V43 31404	14	20	30	102	28	52	0,62	WOEX 030204	349.32	14011
KUB-T.2D.150.R.03-K20	V43 31504	15	20	30	104	30	54	0,62	WOEX 030204	349.32	15011
KUB-T.2D.160.R.03-K20	V43 31602	16	20	30	106	32	56	0,62	WOEX 030204	349.32	16011
KUB-T.2D.170.R.03-K20	V43 31702	17	20	30	108	34	58	0,62	WOEX 030204	349.32	17011
KUB-T.2D.180.R.03-K20	V43 31802	18	20	30	110	36	60	0,62	WOEX 030204	349.32	18011
KUB-T.2D.190.R.03-K20	V43 31902	19	20	30	112	38	62	0,62	WOEX 030204	349.32	19011
KUB-T.2D.200.R.04-K25	V44 32002	20	25	30	120	40	64	1,01	WOEX 040304	353.03	20012
KUB-T.2D.210.R.04-K25	V44 32102	21	25	30	122	42	66	1,01	WOEX 040304	353.03	21012
KUB-T.2D.220.R.04-K25	V44 32202	22	25	30	124	44	68	1,01	WOEX 040304	353.03	22012
KUB-T.2D.230.R.04-K25	V44 32302	23	25	30	126	46	70	1,01	WOEX 040304	353.03	23012
KUB-T.2D.240.R.04-K25	V44 32402	24	25	30	128	48	72	1,01	WOEX 040304	353.03	24012
KUB-T.2D.250.R.05-K32	V45 32502	25	32	39	134	50	74	1,28	WOEX 05T304	383.05	25013
KUB-T.2D.260.R.05-K32	V45 32602	26	32	39	136	52	76	1,28	WOEX 05T304	383.05	26013
KUB-T.2D.270.R.05-K32	V45 32702	27	32	39	138	54	78	1,28	WOEX 05T304	383.05	27013
KUB-T.2D.280.R.05-K32	V45 32802	28	32	39	140	56	80	1,28	WOEX 05T304	383.05	28013
KUB-T.2D.290.R.05-K32	V45 32902	29	32	39	142	58	82	1,28	WOEX 05T304	383.05	29013
KUB-T.2D.300.R.05-K32	V45 33002	30	32	39	149	60	89	1,28	WOEX 05T304	383.05	30013
KUB-T.2D.310.R.05-K32	V45 33102	31	32	39	151	62	91	1,28	WOEX 05T304	383.05	31013
KUB-T.2D.320.R.05-K32	V45 33202	32	32	39	153	64	93	1,28	WOEX 05T304	383.05	32013
KUB-T.2D.330.R.05-K32	V45 33302	33	32	39	155	66	95	1,28	WOEX 05T304	383.05	33013
KUB-T.2D.340.R.05-K32	V45 33402	34	32	39	157	68	97	1,28	WOEX 05T304	383.05	34013
KUB-T.2D.350.R.05-K32	V45 33502	35	32	39	159	70	99	1,28	WOEX 05T304	383.05	35013
KUB-T.2D.360.R.05-K32	V45 33602	36	32	39	161	72	101	1,28	WOEX 05T304	383.05	36013
KUB-T.2D.370.R.06-K32	V45 33702	37	32	39	173	74	113	2,8	WOEX 06T304	399.78	37013
KUB-T.2D.380.R.06-K32	V45 33802	38	32	39	175	76	115	2,8	WOEX 06T304	399.78	38013
KUB-T.2D.390.R.06-K32	V45 33902	39	32	39	177	78	117	2,8	WOEX 06T304	399.78	39013
KUB-T.2D.400.R.06-K32	V45 34002	40	32	39	179	80	119	2,8	WOEX 06T304	399.78	40013
KUB-T.2D.410.R.06-K32	V45 34102	41	32	39	181	82	121	2,8	WOEX 06T304	399.78	41013
KUB-T.2D.420.R.06-K32	V45 34202	42	32	39	183	84	123	2,8	WOEX 06T304	399.78	42013
KUB-T.2D.430.R.06-K32	V45 34302	43	32	39	185	86	125	2,8	WOEX 06T304	399.78	43013
KUB-T.2D.440.R.06-K32	V45 34402	44	32	39	187	88	127	2,8	WOEX 06T304	399.78	44013

Spare parts

DC		£		£	
14 - 19	T06 - IP	17.37	123	M2,0x4,3 - 06IP	2.73 10000
20 - 24	T06 - IP	17.37	123	M2,2x5,5 - 06IP	2.73 10700
25 - 36	T08 - IP	17.13	125	M2,5x7,2 - 08IP	2.73 10500
37 - 44	T10 - IP	19.45	127	M3,5x7,3 - 10IP	2.73 10600

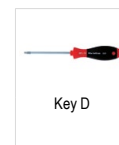

Key D

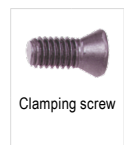

Clamping screw

80 950 ...

10 950 ...

£

£

Y7

W7/6B

Matching holders can be found in → Chapter 16 Adapters and accessories in the clamping technology catalogue

KUB Trigon – Indexable insert drill

Scope of supply:

Indexable Insert Drill incl. clamping screws

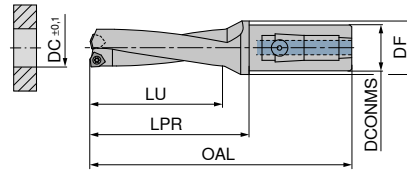
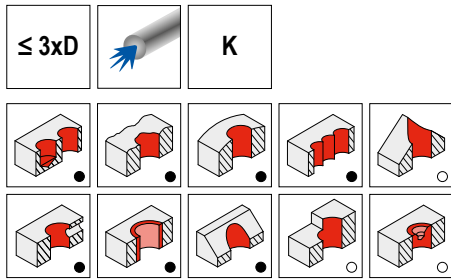

3

10 893 ...

Designation	KOMET no.	DC mm	DCONMS mm	DF mm	OAL mm	LU mm	LPR mm	torque moment Nm	Insert	£	
										2B/6#	
KUB-T.3D.140.R.03-K20	V43 71404	14	20	30	116	42	66	0,62	WOEX 030204	366.18	14011
KUB-T.3D.150.R.03-K20	V43 71504	15	20	30	119	45	69	0,62	WOEX 030204	366.18	15011
KUB-T.3D.160.R.03-K20	V43 71602	16	20	30	122	48	72	0,62	WOEX 030204	366.18	16011
KUB-T.3D.170.R.03-K20	V43 71702	17	20	30	125	51	75	0,62	WOEX 030204	366.18	17011
KUB-T.3D.180.R.03-K20	V43 71802	18	20	30	128	54	78	0,62	WOEX 030204	366.18	18011
KUB-T.3D.190.R.03-K20	V43 71902	19	20	30	131	57	81	0,62	WOEX 030204	366.18	19011
KUB-T.3D.200.R.04-K25	V44 72002	20	25	30	140	60	84	1,01	WOEX 040304	392.61	20012
KUB-T.3D.210.R.04-K25	V44 72102	21	25	30	143	63	87	1,01	WOEX 040304	392.61	21012
KUB-T.3D.220.R.04-K25	V44 72202	22	25	30	146	66	90	1,01	WOEX 040304	392.61	22012
KUB-T.3D.230.R.04-K25	V44 72302	23	25	30	149	69	93	1,01	WOEX 040304	392.61	23012
KUB-T.3D.240.R.04-K25	V44 72402	24	25	30	152	72	96	1,01	WOEX 040304	392.61	24012
KUB-T.3D.250.R.05-K32	V45 72502	25	32	39	159	75	99	1,28	WOEX 05T304	427.37	25013
KUB-T.3D.260.R.05-K32	V45 72602	26	32	39	162	78	102	1,28	WOEX 05T304	427.37	26013
KUB-T.3D.270.R.05-K32	V45 72702	27	32	39	165	81	105	1,28	WOEX 05T304	427.37	27013
KUB-T.3D.280.R.05-K32	V45 72802	28	32	39	168	84	108	1,28	WOEX 05T304	427.37	28013
KUB-T.3D.290.R.05-K32	V45 72902	29	32	39	171	87	111	1,28	WOEX 05T304	427.37	29013
KUB-T.3D.300.R.05-K32	V45 73002	30	32	39	179	90	119	1,28	WOEX 05T304	427.37	30013
KUB-T.3D.310.R.05-K32	V45 73102	31	32	39	182	93	122	1,28	WOEX 05T304	427.37	31013
KUB-T.3D.320.R.05-K32	V45 73202	32	32	39	185	96	125	1,28	WOEX 05T304	427.37	32013
KUB-T.3D.330.R.05-K32	V45 73302	33	32	39	188	99	128	1,28	WOEX 05T304	427.37	33013
KUB-T.3D.340.R.05-K32	V45 73402	34	32	39	191	102	131	1,28	WOEX 05T304	427.37	34013
KUB-T.3D.350.R.05-K32	V45 73502	35	32	39	194	105	134	1,28	WOEX 05T304	427.37	35013
KUB-T.3D.360.R.05-K32	V45 73602	36	32	39	197	108	137	1,28	WOEX 05T304	427.37	36013
KUB-T.3D.370.R.06-K32	V45 73702	37	32	39	210	111	150	2,8	WOEX 06T304	463.39	37013
KUB-T.3D.380.R.06-K32	V45 73802	38	32	39	213	114	153	2,8	WOEX 06T304	463.39	38013
KUB-T.3D.390.R.06-K32	V45 73902	39	32	39	216	117	156	2,8	WOEX 06T304	463.39	39013
KUB-T.3D.400.R.06-K32	V45 74002	40	32	39	219	120	159	2,8	WOEX 06T304	463.39	40013
KUB-T.3D.410.R.06-K32	V45 74102	41	32	39	222	123	162	2,8	WOEX 06T304	463.39	41013
KUB-T.3D.420.R.06-K32	V45 74202	42	32	39	225	126	165	2,8	WOEX 06T304	463.39	42013
KUB-T.3D.430.R.06-K32	V45 74302	43	32	39	228	129	168	2,8	WOEX 06T304	463.39	43013
KUB-T.3D.440.R.06-K32	V45 74402	44	32	39	231	132	171	2,8	WOEX 06T304	463.39	44013

Spare parts

DC	80 950 ...	10 950 ...
	£ Y7	£ W7/6B
14 - 19	T06 - IP 17.37 123	M2,0x4,3 - 06IP 2.73 10000
20 - 24	T06 - IP 17.37 123	M2,2x5,5 - 06IP 2.73 10700
25 - 36	T08 - IP 17.13 125	M2,5x7,2 - 08IP 2.73 10500
37 - 44	T10 - IP 19.45 127	M3,5x7,3 - 10IP 2.73 10600

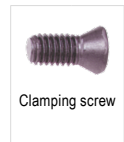
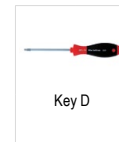

Matching holders can be found in → Chapter 16 Adapters and accessories in the clamping technology catalogue

KUB Trigon – Indexable insert drill

Scope of supply:

Indexable Insert Drill incl. clamping screws

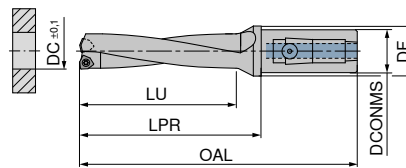
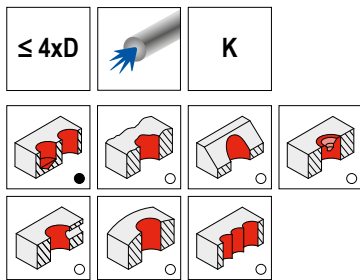

10 894 ...

Designation	KOMET no.	DC mm	DCONMS mm	DF mm	OAL mm	LU mm	LPR mm	torque moment Nm	Insert	10 894 ...	
										£	2B/6#
KUB-T.4D.140.R.03-K20	V43 91404	14	20	30	130	56	80	0,62	WOEX 030204	402.21	14011
KUB-T.4D.150.R.03-K20	V43 91504	15	20	30	134	60	84	0,62	WOEX 030204	402.21	15011
KUB-T.4D.160.R.03-K20	V43 91602	16	20	30	138	64	88	0,62	WOEX 030204	402.21	16011
KUB-T.4D.170.R.03-K20	V43 91702	17	20	30	142	68	92	0,62	WOEX 030204	402.21	17011
KUB-T.4D.180.R.03-K20	V43 91802	18	20	30	146	72	96	0,62	WOEX 030204	402.21	18011
KUB-T.4D.190.R.03-K20	V43 91902	19	20	30	150	76	100	0,62	WOEX 030204	402.21	19011
KUB-T.4D.200.R.04-K25	V44 92002	20	25	30	160	80	104	1,01	WOEX 040304	432.22	20012
KUB-T.4D.210.R.04-K25	V44 92102	21	25	30	164	84	108	1,01	WOEX 040304	432.22	21012
KUB-T.4D.220.R.04-K25	V44 92202	22	25	30	168	88	112	1,01	WOEX 040304	432.22	22012
KUB-T.4D.230.R.04-K25	V44 92302	23	25	30	172	92	116	1,01	WOEX 040304	432.22	23012
KUB-T.4D.240.R.04-K25	V44 92402	24	25	30	176	96	120	1,01	WOEX 040304	432.22	24012
KUB-T.4D.250.R.05-K32	V45 92502	25	32	39	184	100	124	1,28	WOEX 05T304	467.06	25013
KUB-T.4D.260.R.05-K32	V45 92602	26	32	39	188	104	128	1,28	WOEX 05T304	467.06	26013
KUB-T.4D.270.R.05-K32	V45 92702	27	32	39	192	108	132	1,28	WOEX 05T304	467.06	27013
KUB-T.4D.280.R.05-K32	V45 92802	28	32	39	196	112	136	1,28	WOEX 05T304	467.06	28013
KUB-T.4D.290.R.05-K32	V45 92902	29	32	39	200	116	140	1,28	WOEX 05T304	467.08	29013
KUB-T.4D.300.R.05-K32	V45 93002	30	32	39	209	120	149	1,28	WOEX 05T304	467.08	30013
KUB-T.4D.310.R.05-K32	V45 93102	31	32	39	213	124	153	1,28	WOEX 05T304	467.08	31013
KUB-T.4D.320.R.05-K32	V45 93202	32	32	39	217	128	157	1,28	WOEX 05T304	467.08	32013
KUB-T.4D.330.R.05-K32	V45 93302	33	32	39	221	132	161	1,28	WOEX 05T304	467.08	33013
KUB-T.4D.340.R.05-K32	V45 93402	34	32	39	225	136	165	1,28	WOEX 05T304	467.08	34013
KUB-T.4D.350.R.05-K32	V45 93502	35	32	39	229	140	169	1,28	WOEX 05T304	467.08	35013

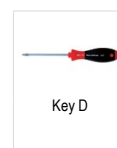

80 950 ...

10 950 ...

Spare parts

DC		£		£
14 - 19	T06 - IP	17.37	123	M2,0x4,3 - 06IP 2.73 10000
20 - 24	T06 - IP	17.37	123	M2,2x5,5 - 06IP 2.73 10700
25 - 35	T08 - IP	17.13	125	M2,5x7,2 - 08IP 2.73 10500

Matching holders can be found in → Chapter 16 Adapters and accessoires in the clamping technology catalogue

KUB Centron – basic element

▲ KLG = Coupling Size

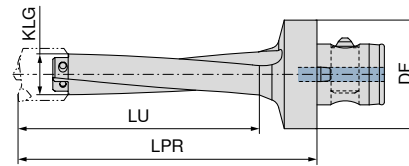
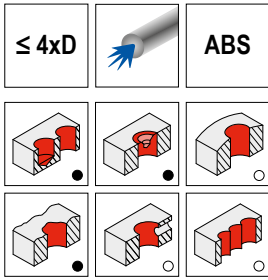

3

Designation	KOMET no.	DF mm	LU mm	LPR mm	KLK
KUB-C.GH.4D.190-ABS50	V47 20201	50	113	145	19
KUB-C.GH.4D.250-ABS50	V47 20261	50	130	160	25
KUB-C.GH.4D.320-ABS50	V47 20331	50	160	195	32
KUB-C.GH.4D.385-ABS63	V47 20401	63	185	235	38,5
KUB-C.GH.4D.445-ABS80	V47 20461	80	215	280	44,5
KUB-C.GH.4D.535-ABS80	V47 20551	80	260	325	53,5
KUB-C.GH.4D.635-ABS80	V47 20651	80	295	375	63,5
KUB-C.GH.4D.705-ABS100	V47 20721	100	325	405	70,5

10 864 ...	£
2B/6#	
464.66	19095
464.66	25095
464.66	32095
695.18	38596
695.18	44598
863.28	53598
966.48	63598
1,030.09	70591

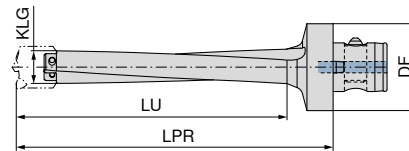
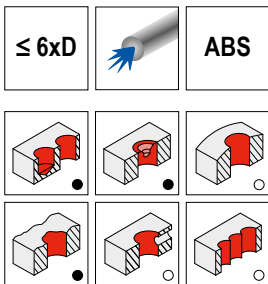

Designation	KOMET no.	DF mm	LU mm	LPR mm	KLK
KUB-C.GH.6D.190-ABS50	V47 40201	50	150	185	19
KUB-C.GH.6D.250-ABS50	V47 40261	50	175	210	25
KUB-C.GH.6D.320-ABS50	V47 40331	50	215	255	32
KUB-C.GH.6D.385-ABS63	V47 40401	63	260	310	38,5
KUB-C.GH.6D.445-ABS80	V47 40461	80	310	375	44,5
KUB-C.GH.6D.535-ABS80	V47 40551	80	370	435	53,5
KUB-C.GH.6D.635-ABS80	V47 40651	80	420	500	63,5
KUB-C.GH.6D.705-ABS100	V47 40721	100	460	540	70,5

10 866 ...	£
2B/6#	
553.42	19095
553.42	25095
553.42	32095
759.95	38596
759.95	44598
1,030.09	53598
1,085.38	63598
1,154.42	70591

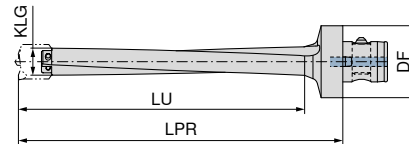
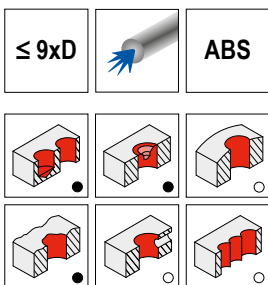

Designation	KOMET no.	DF mm	LU mm	LPR mm	KLK
KUB-C.GH.9D.190-ABS50	V47 60201	50	200	235	19
KUB-C.GH.9D.250-ABS50	V47 60261	50	230	260	25
KUB-C.GH.9D.320-ABS50	V47 60331	50	290	330	32
KUB-C.GH.9D.385-ABS63	V47 60401	63	340	390	38,5
KUB-C.GH.9D.445-ABS80	V47 60461	80	415	480	44,5
KUB-C.GH.9D.535-ABS80	V47 60551	80	495	560	53,5
KUB-C.GH.9D.635-ABS80	V47 60651	80	560	640	63,5
KUB-C.GH.9D.705-ABS100	V47 60721	100	610	690	70,5

10 869 ...	£
2B/6#	
611.15	19095
611.15	25095
611.15	32095
827.24	38596
827.24	44598
1,146.58	53598
1,238.69	63598
1,299.88	70591

For correct assembly, please observe the operating instructions provided.

KUB Centron – drill bit Ø 20–64 mm

- ▲ The pre-assembled drill bit is ready to use
- ▲ The indexable inserts and centring tip must be professionally assembled
- ▲ Tightening torque refers to the clamping screws of the indexable inserts
- ▲ KLG = Coupling size



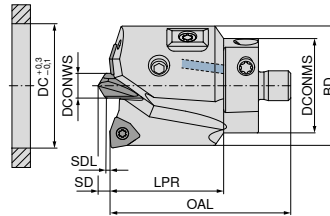
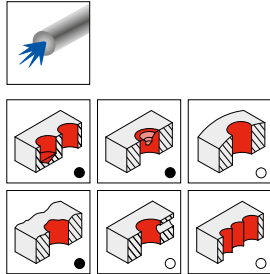

Scope of supply:

Drill bit incl. screws, guide pads and shim set
Order centring tip and indexable inserts separately





10 860 ...

Designation	KOMET no.	DC mm	OAL mm	LPR mm	SD mm	BD mm	SDL mm	DCONMS mm	DCONWS mm	KLG	torque moment Nm	Insert	£ 2B/6#	
KUB-C.BK.200.R.03-19	V46 50201	20	36.5	23	2.25	19.0	1.00	19.0	5	19	0,62	WOEX 030204	408.45	20000
KUB-C.BK.210.R.03-19	V46 50211	21	36.5	23	2.25	20.0	1.00	19.0	5	19	0,62	WOEX 030204	408.45	21000
KUB-C.BK.220.R.03-19	V46 50221	22	36.5	23	2.25	21.0	1.00	19.0	5	19	0,62	WOEX 030204	408.45	22000
KUB-C.BK.230.R.03-19	V46 50231	23	36.5	23	2.25	22.0	1.00	19.0	5	19	0,62	WOEX 030204	408.45	23000
KUB-C.BK.240.R.03-19	V46 50241	24	36.5	23	2.25	23.0	1.00	19.0	5	19	0,62	WOEX 030204	408.45	24000
KUB-C.BK.250.R.03-19	V46 50251	25	36.5	23	2.25	24.0	1.00	19.0	5	19	0,62	WOEX 030204	408.45	25000
KUB-C.BK.260.R.04-25	V46 50260	26	38.0	23	2.65	25.0	1.10	25.0	6	25	1,01	WOEX 040304	467.08	26000
KUB-C.BK.270.R.04-25	V46 50270	27	38.0	23	2.65	26.0	1.10	25.0	6	25	1,01	WOEX 040304	467.08	27000
KUB-C.BK.280.R.04-25	V46 50280	28	38.0	23	2.65	27.0	1.10	25.0	6	25	1,01	WOEX 040304	467.08	28000
KUB-C.BK.290.R.04-25	V46 50290	29	38.0	23	2.65	28.0	1.10	25.0	6	25	1,01	WOEX 040304	467.08	29000
KUB-C.BK.300.R.04-25	V46 50300	30	38.0	23	2.65	29.0	1.10	25.0	6	25	1,01	WOEX 040304	467.08	30000
KUB-C.BK.310.R.04-25	V46 50310	31	38.0	23	2.65	30.0	1.10	25.0	6	25	1,01	WOEX 040304	467.08	31000
KUB-C.BK.320.R.04-25	V46 50320	32	38.0	23	2.65	31.0	1.10	25.0	6	25	1,01	WOEX 040304	467.08	32000
KUB-C.BK.330.R.05-32	V46 50330	33	39.2	23	2.65	32.0	1.10	32.0	6	32	1,28	WOEX 05T304	605.15	33000
KUB-C.BK.340.R.05-32	V46 50340	34	39.2	23	2.65	33.0	1.10	32.0	6	32	1,28	WOEX 05T304	605.15	34000
KUB-C.BK.350.R.05-32	V46 50350	35	39.2	23	2.65	34.0	1.10	32.0	6	32	1,28	WOEX 05T304	605.15	35000
KUB-C.BK.360.R.05-32	V46 50360	36	39.2	23	2.65	35.0	1.10	32.0	6	32	1,28	WOEX 05T304	605.15	36000
KUB-C.BK.370.R.05-32	V46 50370	37	39.2	23	2.65	36.0	1.10	32.0	6	32	1,28	WOEX 05T304	605.15	37000
KUB-C.BK.380.R.05-32	V46 50380	38	39.2	23	2.65	37.0	1.10	32.0	6	32	1,28	WOEX 05T304	605.15	38000
KUB-C.BK.390.R.05-32	V46 50390	39	39.2	23	2.65	38.0	1.10	32.0	6	32	1,28	WOEX 05T304	605.15	39000
KUB-C.BK.400.R.05-38,5	V46 50400	40	43.1	25	3.38	38.5	1.25	38.5	8	38,5	1,28	WOEX 05T304	621.90	40000
KUB-C.BK.410.R.05-38,5	V46 50410	41	43.1	25	3.38	39.5	1.25	38.5	8	38,5	1,28	WOEX 05T304	621.90	41000
KUB-C.BK.420.R.05-38,5	V46 50420	42	43.1	25	3.38	40.5	1.09	38.5	8	38,5	1,28	WOEX 05T304	621.90	42000
KUB-C.BK.430.R.05-38,5	V46 50430	43	43.1	25	3.38	41.5	1.09	38.5	8	38,5	1,28	WOEX 05T304	621.90	43000
KUB-C.BK.440.R.05-38,5	V46 50440	44	43.1	25	3.38	42.5	1.25	38.5	8	38,5	1,28	WOEX 05T304	621.90	44000
KUB-C.BK.450.R.05-38,5	V46 50450	45	43.1	25	3.38	43.5	1.25	38.5	8	38,5	1,28	WOEX 05T304	621.90	45000
KUB-C.BK.460.R.06-44,5	V46 50460	46	47.0	25	3.86	44.5	1.25	44.5	10	44,5	2,8	WOEX 06T304	666.34	46000
KUB-C.BK.470.R.06-44,5	V46 50470	47	47.0	25	3.86	45.5	1.25	44.5	10	44,5	2,8	WOEX 06T304	666.34	47000
KUB-C.BK.480.R.06-44,5	V46 50480	48	47.0	25	3.86	46.5	1.25	44.5	10	44,5	2,8	WOEX 06T304	666.34	48000
KUB-C.BK.490.R.06-44,5	V46 50490	49	47.0	25	3.86	47.5	1.25	44.5	10	44,5	2,8	WOEX 06T304	666.34	49000
KUB-C.BK.500.R.06-44,5	V46 50500	50	47.0	25	3.86	48.5	1.25	44.5	10	44,5	2,8	WOEX 06T304	666.34	50000
KUB-C.BK.510.R.06-44,5	V46 50510	51	47.0	25	3.86	49.5	1.25	44.5	10	44,5	2,8	WOEX 06T304	666.34	51000
KUB-C.BK.520.R.06-44,5	V46 50520	52	47.0	25	3.86	50.5	1.25	44.5	10	44,5	2,8	WOEX 06T304	666.34	52000
KUB-C.BK.530.R.06-44,5	V46 50530	53	47.0	25	3.86	51.5	1.25	44.5	10	44,5	2,8	WOEX 06T304	690.35	53000
KUB-C.BK.540.R.06-44,5	V46 50540	54	47.0	25	3.86	52.5	1.25	44.5	10	44,5	2,8	WOEX 06T304	690.35	54000
KUB-C.BK.550.R.08-53,5	V46 50550	55	52.0	30	3.86	53.5	1.25	53.5	10	53,5	6,25	WOEX 080404	714.36	55000
KUB-C.BK.560.R.08-53,5	V46 50560	56	52.0	30	3.86	54.5	1.25	53.5	10	53,5	6,25	WOEX 080404	714.36	56000
KUB-C.BK.570.R.08-53,5	V46 50570	57	52.0	30	3.86	55.5	1.25	53.5	10	53,5	6,25	WOEX 080404	714.36	57000
KUB-C.BK.580.R.08-53,5	V46 50580	58	52.0	30	3.86	56.5	1.25	53.5	10	53,5	6,25	WOEX 080404	714.36	58000
KUB-C.BK.590.R.08-53,5	V46 50590	59	52.0	30	3.86	57.5	1.25	53.5	10	53,5	6,25	WOEX 080404	714.36	59000
KUB-C.BK.600.R.08-53,5	V46 50600	60	52.0	30	3.86	58.5	1.25	53.5	10	53,5	6,25	WOEX 080404	714.36	60000
KUB-C.BK.610.R.08-53,5	V46 50610	61	52.0	30	3.86	59.5	1.25	53.5	10	53,5	6,25	WOEX 080404	714.36	61000
KUB-C.BK.620.R.08-53,5	V46 50620	62	52.0	30	3.86	60.5	1.25	53.5	10	53,5	6,25	WOEX 080404	714.36	62000
KUB-C.BK.630.R.08-53,5	V46 50630	63	52.0	30	3.86	61.5	1.25	53.5	10	53,5	6,25	WOEX 080404	714.36	63000
KUB-C.BK.640.R.08-53,5	V46 50640	64	52.0	30	3.86	62.5	1.25	53.5	10	53,5	6,25	WOEX 080404	714.36	64000

		 Guide pad clamping screw		 Indexable insert clamping screw		 Guide pad		 Shim set		
		10 950 ...		10 950 ...		10 950 ...		10 950 ...		
		£		£		£		£		
		W7/6B		W7/6B		W7/6B		W7/6B		
Spare parts										
DC										
20	M2,5x4,2 - 8IP - 1,28Nm	3.30	11900	M2,0x4,3 - 06IP	2.73	10000	83.11	14600	25.70	15200
21 - 22	M2,5x4,2 - 8IP - 1,28Nm	3.30	11900	M2,0x4,3 - 06IP	2.73	10000	83.11	14600	25.70	15200
23 - 25	M2,5x4,5 - 8IP - 1,28Nm	3.79	11700	M2,0x4,3 - 06IP	2.73	10000	70.90	14700	25.70	15200
26 - 29	M2,5x4,5 - 8IP - 1,28Nm	3.79	11700	M2,2x5,5 - 06IP	2.73	10700	70.90	14700	25.70	15200
30 - 32	M2,5x4,5 - 8IP - 1,28Nm	3.79	11700	M2,2x5,5 - 06IP	2.73	10700	70.90	14800	25.70	15200
33 - 36	M2,5x4,5 - 8IP - 1,28Nm	3.79	11700	M2,5x7,2 - 08IP	2.73	10500	70.90	14800	25.70	15200
37 - 39	M2,5x4,5 - 8IP - 1,28Nm	3.79	11700	M2,5x7,2 - 08IP	2.73	10500	70.90	14900	25.70	15200
40 - 45	M2,5x4,5 - 8IP - 1,28Nm	3.79	11700	M2,5x7,2 - 08IP	2.73	10500	70.90	14900	25.70	15200
46 - 54	M3,5x5,0 - 8IP - 2,25Nm	3.30	11800	M3,5x7,3 - 10IP	2.73	10600	86.74	15000	25.70	15300
55 - 64	M3,5x5,0 - 8IP - 2,25Nm	3.30	11800	M4,5x9 - 15IP	2.93	12700	86.74	15100	25.70	15300

3

		 Basic element clamping screw		 Centring tip clamping screw		
		10 950 ...		10 950 ...		
		£		£		
		W7/6B		W7/6B		
Spare parts						
DC						
20	M2,5x6,4 - 08IP - 1,28Nm	3.30	12400	M4x6 - SW2 - 1,5Nm	3.79	12800
21 - 22	M2,5x6,4 - 08IP - 1,28Nm	3.30	12400	M4x8 - SW2 - 1,5Nm	3.79	12900
23 - 25	M2,5x6,4 - 08IP - 1,28Nm	3.30	12400	M4x8 - SW2 - 1,5Nm	3.79	12900
26 - 29	M3x7,4 - 08IP - 2,25Nm	3.30	12500	M5x10 - SW2,5 - 2,5Nm	3.79	13000
30 - 32	M3x7,4 - 08IP - 2,25Nm	3.30	12500	M5x10 - SW2,5 - 2,5Nm	3.79	13000
33 - 36	M4x8,9 - 15IP - 4,3Nm	3.30	12000	M5x12 - SW2,5 - 2,5Nm	3.79	13100
37 - 39	M4x8,9 - 15IP - 4,3Nm	3.30	12000	M5x12 - SW2,5 - 2,5Nm	3.79	13100
40 - 45	M4,5x10,5 - 20IP - 6,25Nm	3.30	12600	M6x12 - SW3 - 5Nm	3.79	13200
46 - 54	M5x11,5 - 20IP - 6,25Nm	3.30	12100	M8x16 - SW4 - 8Nm	3.79	13300
55 - 64	M5,5x14 - 20IP - 6,25Nm	3.30	12200	M8x16 - SW4 - 8Nm	3.79	13300

Drill bit Ø 20–64 mm exploded view

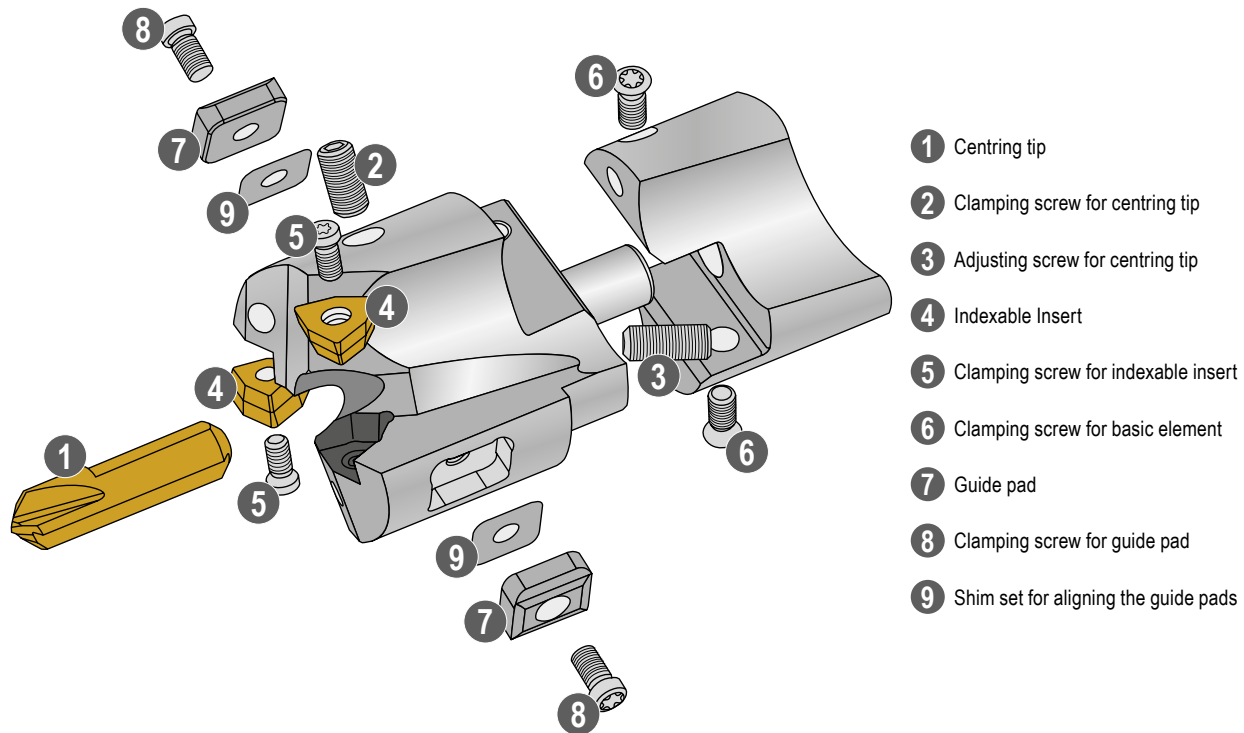

 For correct assembly, please observe the operating instructions provided.

KUB Centron – drill bit Ø 65–81 mm

- ▲ The pre-assembled drill bit is ready to use
- ▲ The indexable inserts and centring tip must be professionally assembled
- ▲ Tightening torque refers to the clamping screws of the indexable inserts
- ▲ Adjustable diameter of outer indexable insert seat
- ▲ KLG = Coupling size

Scope of supply:

Drill bit incl. screws, indexable insert, carbide bolt, key, grub screw and copper disc
Order centring tip and indexable inserts separately

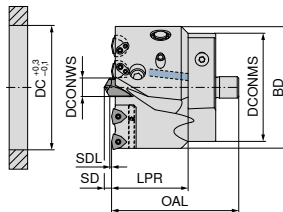
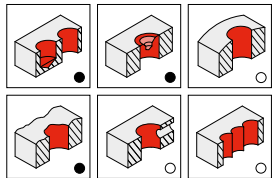

Designation	KOMET no.	DC	OAL	LPR	SD	BD	SDL	DCONMS	DCONWS	KLG	torque moment	Insert	10 860 ...	
													£	2B/6#
KUB-C.BK.650.R.05-63,5	V46 50650	65	63.0	35	4.67	63.5	1.45	63.5	12	63,5	1,28	WOEX 05T304	845.27	65000
KUB-C.BK.660.R.05-63,5	V46 50660	66	63.0	35	4.67	64.5	1.45	63.5	12	63,5	1,28	WOEX 05T304	845.27	66000
KUB-C.BK.670.R.05-63,5	V46 50670	67	63.0	35	4.67	65.5	1.45	63.5	12	63,5	1,28	WOEX 05T304	845.27	67000
KUB-C.BK.680.R.05-63,5	V46 50680	68	63.0	35	4.67	66.5	1.45	63.5	12	63,5	1,28	WOEX 05T304	845.27	68000
KUB-C.BK.690.R.05-63,5	V46 50690	69	63.0	35	4.67	67.5	1.45	63.5	12	63,5	1,28	WOEX 05T304	845.27	69000
KUB-C.BK.700.R.05-63,5	V46 50700	70	63.0	35	4.67	68.5	1.45	63.5	12	63,5	1,28	WOEX 05T304	845.27	70000
KUB-C.BK.710.R.05-63,5	V46 50710	71	63.0	35	4.67	69.5	1.45	63.5	12	63,5	1,28	WOEX 05T304	845.27	71000
KUB-C.BK.720.R.05-70,5	V46 50720	72	80.5	50	4.67	70.5	1.45	70.5	12	70,5	1,28	WOEX 05T304	991.66	72000
KUB-C.BK.730.R.05-70,5	V46 50730	73	80.5	50	4.67	71.5	1.45	70.5	12	70,5	1,28	WOEX 05T304	991.66	73000
KUB-C.BK.740.R.05-70,5	V46 50740	74	80.5	50	4.67	72.5	1.45	70.5	12	70,5	1,28	WOEX 05T304	991.66	74000
KUB-C.BK.750.R.05-70,5	V46 50750	75	80.5	50	4.67	73.5	1.45	70.5	12	70,5	1,28	WOEX 05T304	991.66	75000
KUB-C.BK.760.R.05-70,5	V46 50760	76	80.5	50	4.67	74.5	1.45	70.5	12	70,5	1,28	WOEX 05T304	991.66	76000
KUB-C.BK.770.R.05-70,5	V46 50770	77	80.5	50	4.67	75.5	1.45	70.5	12	70,5	1,28	WOEX 05T304	991.66	77000
KUB-C.BK.780.R.05-70,5	V46 50780	78	80.5	50	4.67	76.5	1.45	70.5	12	70,5	1,28	WOEX 05T304	991.66	78000
KUB-C.BK.790.R.05-70,5	V46 50790	79	80.5	50	4.67	77.5	1.45	70.5	12	70,5	1,28	WOEX 05T304	991.66	79000
KUB-C.BK.800.R.05-70,5	V46 50800	80	80.5	50	4.67	78.5	1.45	70.5	12	70,5	1,28	WOEX 05T304	991.66	80000
KUB-C.BK.810.R.05-70,5	V46 50810	81	80.5	50	4.67	79.5	1.45	70.5	12	70,5	1,28	WOEX 05T304	991.66	81000

Spare parts	10 950 ...		10 950 ...		10 950 ...		10 950 ...	
	£	W7/6B	£	W7/6B	£	W7/6B	£	W7/6B
DC								
65 - 71	M6x8 - SW3	1.22 11300	Ø4,5x1,5	2.45 11400	M4,5x11,5 - T15	3.30 13500		
72 - 75	M6x8 - SW3	1.22 11300	Ø4,5x1,5	2.45 11400	M5x12 - SW2,5	1.22 11000	M2,5x6 - 08IP - 1,28Nm	3.30 11600
76 - 78	M6x8 - SW3	1.22 11300	Ø4,5x1,5	2.45 11400	M5x12 - SW2,5	1.22 11000	M2,5x6 - 08IP - 1,28Nm	3.30 11600
79 - 81	M6x8 - SW3	1.22 11300	Ø4,5x1,5	2.45 11400	M5x12 - SW2,5	1.22 11000	M2,5x6 - 08IP - 1,28Nm	3.30 11600

Spare parts	10 950 ...		10 950 ...		10 950 ...		10 950 ...		10 950 ...		
	£	2B/6#	£	2B/6#	£	2B/6#	£	W7/6B	£	W7/6B	
DC											
65 - 71	189.67	13800					M4x8 - SW2	1.22 11100	M6x16 - 20IP - 6,25Nm	3.39 12300	
72 - 75	302.56	13900	84.39	13700	84.39	13600	1.35 11500	M4x10 - SW2	1.22 11200	M6x16 - 20IP - 6,25Nm	3.39 12300
76 - 78	302.56	14000	84.39	13700	84.39	13600	1.35 11500	M4x10 - SW2	1.22 11200	M6x16 - 20IP - 6,25Nm	3.39 12300
79 - 81	302.56	14100	84.39	13700	84.39	13600	1.35 11500	M4x10 - SW2	1.22 11200	M6x16 - 20IP - 6,25Nm	3.39 12300

Spare parts	10 950 ...		10 950 ...		10 950 ...		10 950 ...	
	£	W7/6B	£	W7/6B	£	W7/6B	£	W7/6B
DC								
65 - 71	35.45	15500	M12x1	162.73 15400	M2,5x7,2 - 08IP	2.73 10500	M10x20 - SW5 - 16Nm	3.79 13400
72 - 75	35.45	15500	M12x1	162.73 15400	M2,5x7,2 - 08IP	2.73 10500	M10x20 - SW5 - 16Nm	3.79 13400
76 - 78	35.45	15500	M12x1	162.73 15400	M2,5x7,2 - 08IP	2.73 10500	M10x20 - SW5 - 16Nm	3.79 13400
79 - 81	35.45	15500	M12x1	162.73 15400	M2,5x7,2 - 08IP	2.73 10500	M10x20 - SW5 - 16Nm	3.79 13400

Drill bit Ø 65–81 mm exploded view

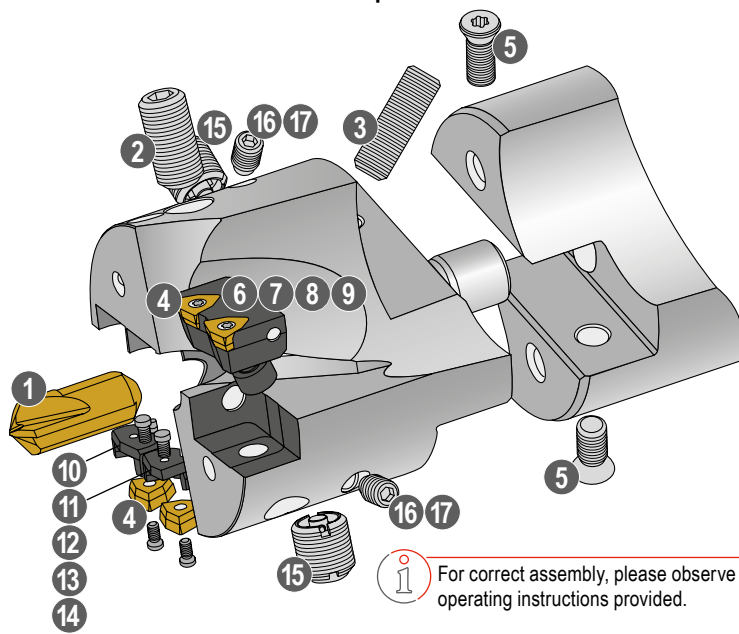

- 1 Centring tip
- 2 Clamping screw for centring tip
- 3 Adjusting screw for centring tip
- 4 Indexable Insert
- 5 Clamping screw for basic element
- 6 Indexable insert seat
- 7 Fixing screw for indexable insert
- 8 Adjusting screw for indexable insert
- 9 Clamping screw for indexable insert
- 10 Indexable insert seat
- 11 Indexable insert seat
- 12 Fixing screw for indexable insert
- 13 Cylindrical pin for indexable insert
- 14 Clamping screw for indexable insert
- 15 Carbide bolt
- 16 Grub screw
- 17 Copper disc

3

KUB Centron – centring tip

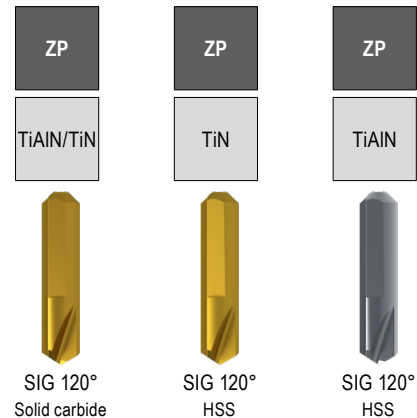
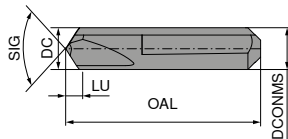

DC mm	KOMET no.	OAL mm	LU mm	DCONMS mm	10 863 ...		10 862 ...		10 862 ...	
					£	T2/9D	£	T2/9D	£	T2/9D
5	V95 10012.0089	23.0	2.25	5			44.95	00500	44.95	10500
5	V95 10012.0090	23.0	2.25	5						
5	V95 10310.8450	23.0	2.25	5	103.77	20500				
6	V95 10022.0089	23.0	2.65	6			44.95	00600	44.95	10600
6	V95 10022.0090	23.0	2.65	6						
6	V95 10320.8450	23.0	2.65	6	103.77	20600				
8	V95 10032.0089	27.0	3.38	8			49.06	00800	49.06	10800
8	V95 10032.0090	27.0	3.38	8						
8	V95 10330.8450	27.0	3.38	8	128.00	20800				
10	V95 10042.0089	28.0	3.86	10			55.30	01000	55.30	11000
10	V95 10042.0090	28.0	3.86	10						
10	V95 10340.8450	28.0	3.86	10	139.07	21000				
12	V95 10050.0089	30.8	4.67	12			70.01	01200	70.01	11200
12	V95 10050.0090	30.8	4.67	12						

P	●	●	
M	●		●
K	●		●
N	●	●	
S	○		●
H			
O	○	○	

→ v_c Page 72+73

1 ▲ The cutting data of the KUB Centron depends on the centring tip and not on the indexable inserts. Please select the cutting data of the centring tip.
▲ Article No. 10 863 ... is only suitable up to drilling depth 6xD.

WOEX

Designation	L mm	IC mm	S mm	D1 mm
WOEX 0302..	3.2	5.00	2.30	2.30
WOEX 0403..	4.1	6.35	3.18	2.55
WOEX 05T3..	5.3	8.00	3.80	2.85
WOEX 06T3..	6.6	10.00	3.80	4.05
WOEX 0804..	7.9	12.00	4.80	4.90
WOEX 1005..	9.9	15.00	5.30	4.90
WOEX 1206..	11.6	17.60	6.00	5.95

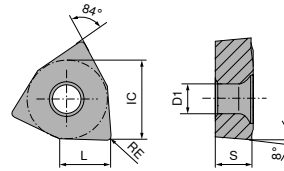

WOEX



ISO	KOMET no.	RE mm	10 821 ...						
			£ 1A/3#	£ 1A/3#	£ 1A/3#	£ 1A/3#	£ 1A/3#		
030204	W29 10010.046115	0.4			18.97	40301			
030204	W29 10010.0462	0.4					21.85	05301	13.63
030204	W29 10010.047615	0.4							
030204	W29 10010.047935	0.4		13.82	50301				
030204	W29 10010.048425	0.4	13.10						
040304	W29 18010.046115	0.4				19.09	40401		
040304	W29 18010.0462	0.4						21.97	05401
040304	W29 18010.047615	0.4							14.32
040304	W29 18010.047935	0.4		14.67	50401				
040304	W29 18010.048425	0.4	13.92						
05T304	W29 24010.046115	0.4				20.64	40501		
05T304	W29 24010.0462	0.4						22.93	05501
05T304	W29 24010.047615	0.4		14.89	50501				14.47
05T304	W29 24010.047935	0.4							
05T304	W29 24010.048425	0.4	14.28						
06T304	W29 34010.046115	0.4				20.40	40601		
06T304	W29 34010.0462	0.4						24.62	05601
06T304	W29 34010.047615	0.4		16.91	50601				
06T304	W29 34010.047935	0.4	15.96						
06T304	W29 34010.048425	0.4							16.35
080404	W29 42010.046115	0.4				25.20	40801		
080404	W29 42010.0462	0.4						30.02	05801
080404	W29 42010.047615	0.4		21.31	50801				20.40
080404	W29 42010.047935	0.4							
080404	W29 42010.048425	0.4	20.16						
100504	W29 50010.046115	0.4				29.78	41001		
100504	W29 50010.0462	0.4						33.51	06001
100504	W29 50010.047615	0.4		29.00	51001				28.46
100504	W29 50010.047935	0.4							
100504	W29 50010.048425	0.4	27.49						
120608	W29 58010.086115	0.8				37.33	41201		
120608	W29 58010.0862	0.8						41.32	08201
120608	W29 58010.087615	0.8		33.75	53201				36.38
120608	W29 58010.087935	0.8							
120608	W29 58010.088425	0.8	31.94						
P			●	●	●				
M			●	●	●				
K			●	●	●		●		●
N			○	○					
S			●	●					
H			○			○			○
O									

→ v_c Page 68

BK6115 -01 / BK8425 -03 are exclusively recommended for use on the peripheral cutting edge!

Further indexable inserts can be found in our online shop cuttingtools.ceratizit.com



WOEX

Designation	L mm	IC mm	S mm	D1 mm
WOEX 0302..	3.2	5.00	2.30	2.30
WOEX 0403..	4.1	6.35	3.18	2.55
WOEX 05T3..	5.3	8.00	3.80	2.85
WOEX 06T3..	6.6	10.00	3.80	4.05
WOEX 0804..	7.9	12.00	4.80	4.90
WOEX 1005..	9.9	15.00	5.30	4.90
WOEX 1206..	11.6	17.60	6.00	5.95

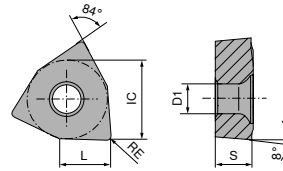

WOEX

ISO	KOMET no.	RE mm	NEW				
			-03 BK8425	-11 BK77	-11 BK7710	-13 BK8425	-13 BK79
			WOEX	WOEX	WOEX	WOEX	WOEX
			10 821 ...	10 821 ...	10 821 ...	10 821 ...	10 821 ...
			£	£	£	£	£
			1A/3#	1A/3#	1A/3#	1A/3#	1A/3#
030204	W29 10110.047710	0.4			14.28 90311		
030204	W29 10130.0479	0.4				15.84 30313	15.84 15313
030204	W29 10130.048425	0.4		13.63 80311			
030204	W29 10110.0477	0.4					
030204	W29 10030.048425	0.4	13.45 30303				
040304	W29 18110.047710	0.4			15.13 90411		
040304	W29 18130.0479	0.4				15.96 30413	15.96 15413
040304	W29 18130.048425	0.4		14.32 80411			
040304	W29 18110.0477	0.4					
040304	W29 18030.048425	0.4	14.28 30403				
05T304	W29 24110.047710	0.4			15.25 90511		
05T304	W29 24130.0479	0.4				16.31 30513	16.31 15513
05T304	W29 24130.048425	0.4		14.47 80511			
05T304	W29 24110.0477	0.4					
05T304	W29 24030.048425	0.4	20.16 30503				
06T304	W29 34110.047710	0.4			17.17 90611		
06T304	W29 34130.0479	0.4				18.01 30613	18.01 15613
06T304	W29 34130.048425	0.4		16.21 80611			
06T304	W29 34110.0477	0.4					
06T304	W29 34030.048425	0.4	21.13 30603				
080404	W29 42110.047710	0.4			21.85 90811		
080404	W29 42130.0479	0.4				22.81 30813	23.05 15813
080404	W29 42130.048425	0.4		20.76 80811			
080404	W29 42110.0477	0.4					
080404	W29 42030.048425	0.4	26.77 30803				
100504	W29 50110.047710	0.4			30.02 91011		
100504	W29 50130.0479	0.4				31.70 31013	31.70 16013
100504	W29 50130.048425	0.4		28.70 81011			
100504	W29 50110.0477	0.4					
100504	W29 50030.048425	0.4	26.77 31003			36.62 38213	
120608	W29 58130.088425	0.8					36.62 16213
120608	W29 58130.0879	0.8					
120608	W29 58030.088425	0.8	29.66 33203				
P			●			●	●
M			●			●	●
K			●			●	●
N			○		●	○	○
S			●	●	○	●	
H			○	○	○	○	
O				○	○		

→ v_c Page 68

BK6115 -01 / BK8425 -03 are exclusively recommended for use on the peripheral cutting edge!

Further information on grades and chip breakers can be found on page 85 + 86

MaxiDrill 900 – Indexable insert drill

Scope of supply:

Indexable Insert Drill including clamping screws and key

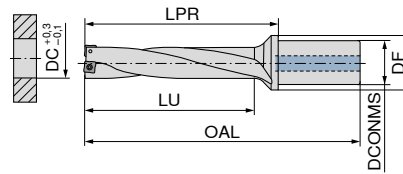
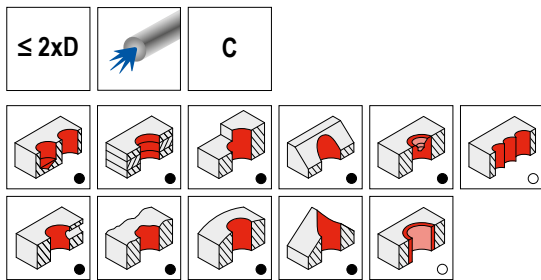

10 852 ...

Designation	DC mm	DCONMS mm	DF mm	OAL mm	LU mm	LPR mm	torque moment Nm	Insert	£	
									2B/41	
MD900.2D.120.R.03-C20	12	20	28	90	24	40	0,4	SONT 031804	281.45	120
MD900.2D.125.R.03-C20	12.5	20	28	91	25	41	0,4	SONT 031804	281.45	125
MD900.2D.130.R.03-C20	13	20	28	92	26	42	0,4	SONT 031804	281.45	130
MD900.2D.135.R.03-C20	13.5	20	28	93	27	43	0,4	SONT 031804	281.45	135
MD900.2D.140.R.04-C20	14	20	30	96	28	46	0,7	SONT 042105	299.58	140
MD900.2D.145.R.04-C20	14.5	20	30	97	29	47	0,7	SONT 042105	299.58	145
MD900.2D.150.R.04-C20	15	20	30	98	30	48	0,7	SONT 042105	299.58	150
MD900.2D.155.R.04-C20	15.5	20	30	99	31	49	0,7	SONT 042105	299.58	155
MD900.2D.160.R.05-C20	16	20	30	100	32	50	0,7	SONT 052306	299.58	160
MD900.2D.165.R.05-C20	16.5	20	30	101	33	51	0,7	SONT 052306	299.58	165
MD900.2D.170.R.05-C20	17	20	30	102	34	52	0,7	SONT 052306	318.84	170
MD900.2D.175.R.05-C20	17.5	20	30	103	35	53	0,7	SONT 052306	318.84	175
MD900.2D.180.R.06-C25	18	25	32	111	36	55	1	SONT 062506	318.84	180
MD900.2D.185.R.06-C25	18.5	25	32	112	37	56	1	SONT 062506	318.84	185
MD900.2D.190.R.06-C25	19	25	32	113	38	57	1	SONT 062506	342.64	190
MD900.2D.195.R.06-C25	19.5	25	32	114	39	58	1	SONT 062506	342.64	195
MD900.2D.200.R.06-C25	20	25	32	115	40	59	1	SONT 062506	342.64	200
MD900.2D.205.R.06-C25	20.5	25	32	116	41	60	1	SONT 062506	342.64	205
MD900.2D.210.R.07-C25	21	25	32	118	42	62	1	SONT 072907	342.64	210
MD900.2D.220.R.07-C25	22	25	32	120	44	64	1	SONT 072907	342.64	220
MD900.2D.230.R.07-C25	23	25	32	122	46	66	1	SONT 072907	353.36	230
MD900.2D.240.R.08-C32	24	32	40	132	48	72	1,2	SONT 083308	353.36	240
MD900.2D.250.R.08-C32	25	32	40	134	50	74	1,2	SONT 083308	353.36	250
MD900.2D.260.R.08-C32	26	32	40	136	52	76	1,2	SONT 083308	391.22	260
MD900.2D.270.R.08-C32	27	32	40	138	54	78	1,2	SONT 083308	391.22	270
MD900.2D.280.R.09-C32	28	32	40	140	56	80	2,2	SONT 093808	391.22	280
MD900.2D.290.R.09-C32	29	32	40	142	58	82	2,2	SONT 093808	391.22	290
MD900.2D.300.R.09-C32	30	32	40	144	60	84	2,2	SONT 093808	391.22	300
MD900.2D.310.R.09-C32	31	32	40	146	62	86	2,2	SONT 093808	424.36	310
MD900.2D.320.R.09-C32	32	32	40	148	64	88	2,2	SONT 093808	424.36	320
MD900.2D.330.R.10-C40	33	40	50	163	66	93	3,2	SONT 104408	424.36	330
MD900.2D.340.R.10-C40	34	40	50	165	68	95	3,2	SONT 104408	424.36	340
MD900.2D.350.R.10-C40	35	40	50	167	70	97	3,2	SONT 104408	433.95	350
MD900.2D.360.R.10-C40	36	40	50	169	72	99	3,2	SONT 104408	433.95	360
MD900.2D.370.R.12-C40	37	40	56	174	74	104	3,2	SONT 124810	448.03	370
MD900.2D.380.R.12-C40	38	40	56	176	76	106	3,2	SONT 124810	448.03	380
MD900.2D.390.R.12-C40	39	40	56	178	78	108	3,2	SONT 124810	448.03	390
MD900.2D.400.R.12-C40	40	40	56	180	80	110	3,2	SONT 124810	448.03	400
MD900.2D.410.R.12-C40	41	40	56	182	82	112	3,2	SONT 124810	448.03	410
MD900.2D.420.R.13-C40	42	40	60	187	84	117	5	SONT 135012	470.66	420
MD900.2D.430.R.13-C40	43	40	60	189	86	119	5	SONT 135012	470.66	430
MD900.2D.440.R.13-C40	44	40	60	191	88	121	5	SONT 135012	470.66	440

MaxiDrill 900 – Indexable insert drill

Scope of supply:

Indexable Insert Drill including clamping screws and key

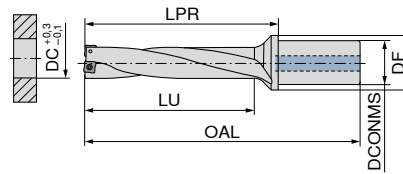
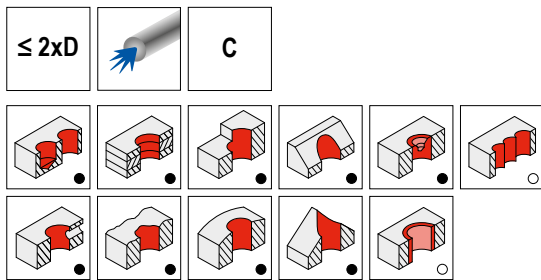

3

10 852 ...

Designation	DC mm	DCONMS mm	DF mm	OAL mm	LU mm	LPR mm	torque moment Nm	Insert	£	
MD900.2D.450.R.13-C40	45	40	60	193	90	123	5	SONT 135012	2B/41	450
MD900.2D.460.R.13-C40	46	40	60	195	92	125	5	SONT 135012	470.66	460
MD900.2D.470.R.15-C40	47	40	60	198	94	128	5	SONT 155312	494.43	470
MD900.2D.480.R.15-C40	48	40	60	200	96	130	5	SONT 155312	494.43	480
MD900.2D.490.R.15-C40	49	40	60	202	98	132	5	SONT 155312	533.44	490
MD900.2D.500.R.15-C40	50	40	60	204	100	134	5	SONT 155312	533.44	500
MD900.2D.520.R.15-C40	51	40	60	206	102	136	5	SONT 155312	547.77	510
MD900.2D.510.R.15-C40	52	40	60	208	104	138	5	SONT 155312	547.77	520
MD900.2D.530.R.15-C40	53	40	60	210	106	140	5	SONT 155312	547.77	530
MD900.2D.540.R.15-C40	54	40	60	212	108	142	5	SONT 155312	547.77	540
MD900.2D.550.R.17-C40	55	40	60	215	110	145	5	SONT 175612	547.77	550
MD900.2D.560.R.17-C40	56	40	60	217	112	147	5	SONT 175612	567.86	560
MD900.2D.570.R.17-C40	57	40	60	219	114	149	5	SONT 175612	567.86	570
MD900.2D.580.R.17-C40	58	40	60	221	116	151	5	SONT 175612	567.86	580
MD900.2D.590.R.17-C40	59	40	60	223	118	153	5	SONT 175612	567.86	590
MD900.2D.600.R.17-C40	60	40	62	225	120	155	5	SONT 175612	567.86	600
MD900.2D.610.R.17-C40	61	40	62	227	122	157	5	SONT 175612	567.86	610
MD900.2D.620.R.17-C40	62	40	64	229	124	159	5	SONT 175612	567.86	620
MD900.2D.630.R.17-C40	63	40	64	231	126	161	5	SONT 175612	567.86	630

Spare parts

DC		80 950 ...	70 950 ...
		£	£
12 - 13,5	T06 - IP	17.37 123	M1,8x3,6 - IP 4.26 862
14 - 17,5	T06 - IP	17.37 123	M2x4,3 - IP 3.79 863
18 - 23	T07 - IP	17.13 124	M2,2x5 - IP 3.67 856
24 - 27	T08 - IP	17.13 125	M2,5x6 - IP 4.73 857
28 - 32	T09 - IP	18.76 126	M3x7 - IP 3.61 819
33 - 41	T15 - IP	20.03 128	M3,5x8,6 - IP 3.61 859
42 - 63	T20 - IP	21.03 129	M4,5x10,5 - IP 3.61 864

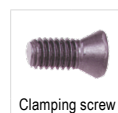
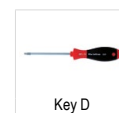

Matching holders can be found in → Chapter 16 Adapters and accessoires in the clamping technology catalogue

MaxiDrill 900 – Indexable insert drill

Scope of supply:

Indexable Insert Drill including clamping screws and key

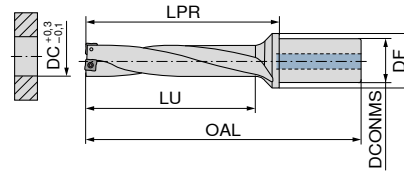
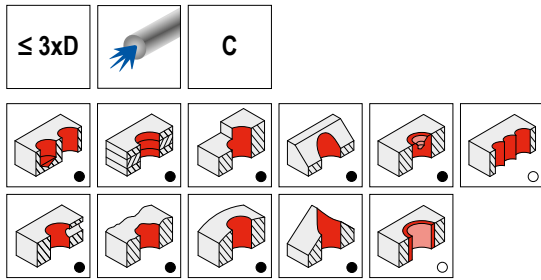

10 853 ...

Designation	DC mm	DCONMS mm	DF mm	OAL mm	LU mm	LPR mm	torque moment Nm	Insert	£	
									2B/41	
MD900.3D.120.R.03-C20	12	20	28	102	36.0	52	0,4	SONT 031804	299.79	120
MD900.3D.125.R.03-C20	12.5	20	28	104	37.5	54	0,4	SONT 031804	299.79	125
MD900.3D.130.R.03-C20	13	20	28	105	39.0	55	0,4	SONT 031804	299.79	130
MD900.3D.135.R.03-C20	13.5	20	28	107	40.5	57	0,4	SONT 031804	299.79	135
MD900.3D.140.R.04-C20	14	20	30	109	42.0	59	0,7	SONT 042105	315.73	140
MD900.3D.145.R.04-C20	14.5	20	30	111	44.0	61	0,7	SONT 042105	315.73	145
MD900.3D.150.R.04-C20	15	20	30	112	45.0	62	0,7	SONT 042105	315.73	150
MD900.3D.155.R.04-C20	15.5	20	30	114	47.0	64	0,7	SONT 042105	323.24	155
MD900.3D.160.R.05-C20	16	20	30	115	48.0	65	0,7	SONT 052306	323.24	160
MD900.3D.165.R.05-C20	16.5	20	30	117	50.0	67	0,7	SONT 052306	323.24	165
MD900.3D.170.R.05-C20	17	20	30	118	51.0	68	0,7	SONT 052306	335.70	170
MD900.3D.175.R.05-C20	17.5	20	30	120	53.0	70	0,7	SONT 052306	335.70	175
MD900.3D.180.R.06-C25	18	25	32	128	54.0	72	1	SONT 062506	335.70	180
MD900.3D.185.R.06-C25	18.5	25	32	130	56.0	74	1	SONT 062506	335.70	185
MD900.3D.190.R.06-C25	19	25	32	131	57.0	75	1	SONT 062506	360.64	190
MD900.3D.195.R.06-C25	19.5	25	32	133	59.0	77	1	SONT 062506	360.64	195
MD900.3D.200.R.06-C25	20	25	32	134	60.0	78	1	SONT 062506	360.64	200
MD900.3D.205.R.06-C25	20.5	25	32	136	62.0	80	1	SONT 062506	360.64	205
MD900.3D.210.R.07-C25	21	25	32	138	63.0	82	1	SONT 072907	360.64	210
MD900.3D.215.R.07-C25	21.5	25	32	140	65.0	84	1	SONT 072907	360.64	215
MD900.3D.220.R.07-C25	22	25	32	141	66.0	85	1	SONT 072907	360.64	220
MD900.3D.225.R.07-C25	22.5	25	32	143	68.0	87	1	SONT 072907	371.84	225
MD900.3D.230.R.07-C25	23	25	32	144	69.0	88	1	SONT 072907	371.84	230
MD900.3D.235.R.07-C25	23.5	25	32	146	71.0	90	1	SONT 072907	371.84	235
MD900.3D.240.R.08-C32	24	32	40	155	72.0	95	1,2	SONT 083308	371.84	240
MD900.3D.245.R.08-C32	24.5	32	40	157	74.0	97	1,2	SONT 083308	371.84	245
MD900.3D.250.R.08-C32	25	32	40	158	75.0	98	1,2	SONT 083308	371.84	250
MD900.3D.255.R.08-C32	25.5	32	40	160	77.0	100	1,2	SONT 083308	371.84	255
MD900.3D.260.R.08-C32	26	32	40	161	78.0	101	1,2	SONT 083308	411.77	260
MD900.3D.265.R.08-C32	26.5	32	40	163	80.0	103	1,2	SONT 083308	411.77	265
MD900.3D.270.R.08-C32	27	32	40	164	81.0	104	1,2	SONT 083308	411.77	270
MD900.3D.275.R.08-C32	27.5	32	40	166	83.0	106	1,2	SONT 083308	411.77	275
MD900.3D.280.R.09-C32	28	32	40	167	84.0	107	2,2	SONT 093808	411.77	280
MD900.3D.285.R.09-C32	28.5	32	40	169	86.0	109	2,2	SONT 093808	411.77	285
MD900.3D.290.R.09-C32	29	32	40	170	87.0	110	2,2	SONT 093808	411.77	290
MD900.3D.295.R.09-C32	29.5	32	40	172	89.0	112	2,2	SONT 093808	411.77	295
MD900.3D.300.R.09-C32	30	32	40	173	90.0	113	2,2	SONT 093808	411.77	300
MD900.3D.305.R.09-C32	30.5	32	40	175	92.0	115	2,2	SONT 093808	411.77	305
MD900.3D.310.R.09-C32	31	32	40	176	93.0	116	2,2	SONT 093808	446.77	310
MD900.3D.315.R.09-C32	31.5	32	40	178	95.0	118	2,2	SONT 093808	446.77	315
MD900.3D.320.R.09-C32	32	32	40	179	96.0	119	2,2	SONT 093808	446.77	320
MD900.3D.325.R.10-C40	32.5	40	50	192	98.0	124	3,2	SONT 104408	446.77	325
MD900.3D.330.R.10-C40	33	40	50	193	99.0	125	3,2	SONT 104408	446.77	330
MD900.3D.335.R.10-C40	33.5	40	50	195	101.0	127	3,2	SONT 104408	446.77	335
MD900.3D.340.R.10-C40	34	40	50	196	102.0	128	3,2	SONT 104408	446.77	340
MD900.3D.345.R.10-C40	34.5	40	50	198	104.0	130	3,2	SONT 104408	446.77	345
MD900.3D.350.R.10-C40	35	40	50	199	105.0	131	3,2	SONT 104408	456.69	350
MD900.3D.355.R.10-C40	35.5	40	50	201	107.0	133	3,2	SONT 104408	456.69	355
MD900.3D.360.R.10-C40	36	40	50	202	108.0	134	3,2	SONT 104408	456.69	360
MD900.3D.365.R.10-C40	36.5	40	50	204	110.0	136	3,2	SONT 104408	456.69	365
MD900.3D.370.R.12-C40	37	40	56	211	111.0	141	3,2	SONT 124810	471.69	370
MD900.3D.380.R.12-C40	38	40	56	214	114.0	144	3,2	SONT 124810	471.69	380

MaxiDrill 900 – Indexable insert drill

Scope of supply:

Indexable Insert Drill including clamping screws and key

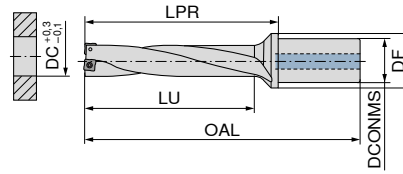
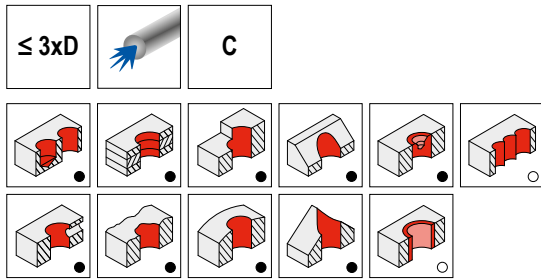

3

10 853 ...

Designation	DC mm	DCONMS mm	DF mm	OAL mm	LU mm	LPR mm	torque moment Nm	Insert	£	
									2B/41	
MD900.3D.390.R.12-C40	39	40	56	217	117.0	147	3,2	SONT 124810	471.69	390
MD900.3D.400.R.12-C40	40	40	56	220	120.0	150	3,2	SONT 124810	471.69	400
MD900.3D.410.R.12-C40	41	40	56	223	123.0	153	3,2	SONT 124810	471.69	410
MD900.3D.420.R.13-C40	42	40	60	229	126.0	159	5	SONT 135012	495.35	420
MD900.3D.430.R.13-C40	43	40	60	232	129.0	162	5	SONT 135012	495.35	430
MD900.3D.440.R.13-C40	44	40	60	235	132.0	165	5	SONT 135012	495.35	440
MD900.3D.450.R.13-C40	45	40	60	238	135.0	168	5	SONT 135012	495.35	450
MD900.3D.460.R.13-C40	46	40	60	241	138.0	171	5	SONT 135012	495.35	460
MD900.3D.470.R.15-C40	47	40	60	245	141.0	175	5	SONT 155312	520.30	470
MD900.3D.480.R.15-C40	48	40	60	248	144.0	178	5	SONT 155312	520.30	480
MD900.3D.490.R.15-C40	49	40	60	251	147.0	181	5	SONT 155312	561.51	490
MD900.3D.500.R.15-C40	50	40	60	254	150.0	184	5	SONT 155312	561.51	500
MD900.3D.510.R.15-C40	51	40	60	257	153.0	187	5	SONT 155312	576.53	510
MD900.3D.520.R.15-C40	52	40	60	260	156.0	190	5	SONT 155312	576.53	520
MD900.3D.530.R.15-C40	53	40	60	263	159.0	193	5	SONT 155312	576.53	530
MD900.3D.540.R.15-C40	54	40	60	266	162.0	196	5	SONT 155312	576.53	540
MD900.3D.550.R.17-C40	55	40	60	270	165.0	200	5	SONT 175612	576.53	550
MD900.3D.560.R.17-C40	56	40	60	273	168.0	203	5	SONT 175612	597.76	560
MD900.3D.570.R.17-C40	57	40	60	276	171.0	206	5	SONT 175612	597.76	570
MD900.3D.580.R.17-C40	58	40	60	279	174.0	209	5	SONT 175612	597.76	580
MD900.3D.590.R.17-C40	59	40	60	282	177.0	212	5	SONT 175612	597.76	590
MD900.3D.600.R.17-C40	60	40	62	285	180.0	215	5	SONT 175612	597.76	600
MD900.3D.610.R.17-C40	61	40	62	288	183.0	218	5	SONT 175612	597.76	610
MD900.3D.620.R.17-C40	62	40	64	291	186.0	221	5	SONT 175612	597.76	620
MD900.3D.630.R.17-C40	63	40	64	294	189.0	224	5	SONT 175612	597.76	630

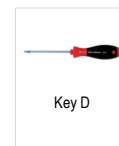

Spare parts	80 950 ...		70 950 ...	
	£		£	
DC	Y7		2A/28	
12 - 13,5		T06 - IP 17.37 123	M1,8x3,6 - IP 4.26	862
14 - 17,5		T06 - IP 17.37 123	M2x4,3 - IP 3.79	863
18 - 23,5		T07 - IP 17.13 124	M2,2x5 - IP 3.67	856
24 - 27,5		T08 - IP 17.13 125	M2,5x6 - IP 4.73	857
28 - 32		T09 - IP 18.76 126	M3x7 - IP 3.61	819
32,5 - 41		T15 - IP 20.03 128	M3,5x8,6 - IP 3.61	859
42 - 63		T20 - IP 21.03 129	M4,5x10,5 - IP 3.61	864



Matching holders can be found in → Chapter 16 Adapters and accessories in the clamping technology catalogue

MaxiDrill 900 – Indexable insert drill

Scope of supply:

Indexable Insert Drill including clamping screws and key

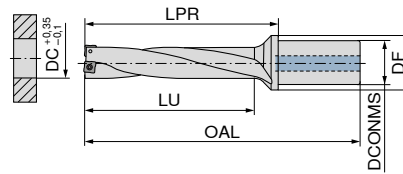
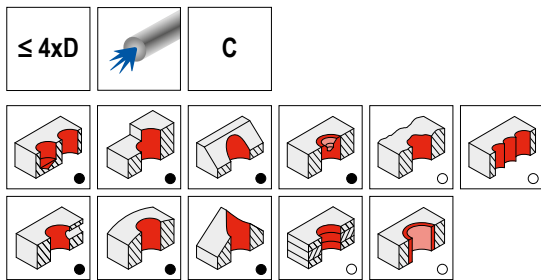

10 854 ...

Designation	DC mm	DCONMS mm	DF mm	OAL mm	LU mm	LPR mm	torque moment Nm	Insert	£	
									2B/41	
MD900.4D.120.R.03-C20	12	20	28	114	48	64	0,4	SONT 031804	413.52	120
MD900.4D.125.R.03-C20	12.5	20	28	116	50	66	0,4	SONT 031804	413.52	125
MD900.4D.130.R.03-C20	13	20	28	118	52	68	0,4	SONT 031804	413.52	130
MD900.4D.135.R.03-C20	13.5	20	28	120	54	70	0,4	SONT 031804	413.52	135
MD900.4D.140.R.04-C20	14	20	30	123	56	73	0,7	SONT 042105	425.51	140
MD900.4D.145.R.04-C20	14.5	20	30	125	58	75	0,7	SONT 042105	425.51	145
MD900.4D.150.R.04-C20	15	20	30	127	60	77	0,7	SONT 042105	425.51	150
MD900.4D.155.R.04-C20	15.5	20	30	129	62	79	0,7	SONT 042105	425.51	155
MD900.4D.160.R.05-C20	16	20	30	131	64	81	0,7	SONT 052306	435.44	160
MD900.4D.165.R.05-C20	16.5	20	30	133	66	83	0,7	SONT 052306	435.44	165
MD900.4D.170.R.05-C20	17	20	30	135	68	85	0,7	SONT 052306	451.84	170
MD900.4D.175.R.05-C20	17.5	20	30	137	70	87	0,7	SONT 052306	451.84	175
MD900.4D.180.R.06-C25	18	25	32	146	72	90	1	SONT 062506	451.84	180
MD900.4D.185.R.06-C25	18.5	25	32	148	74	92	1	SONT 062506	451.84	185
MD900.4D.190.R.06-C25	19	25	32	150	76	94	1	SONT 062506	485.43	190
MD900.4D.195.R.06-C25	19.5	25	32	152	78	96	1	SONT 062506	485.43	195
MD900.4D.200.R.06-C25	20	25	32	154	80	98	1	SONT 062506	485.43	200
MD900.4D.205.R.06-C25	20.5	25	32	156	82	100	1	SONT 062506	485.43	205
MD900.4D.210.R.07-C25	21	25	32	159	84	103	1	SONT 072907	485.43	210
MD900.4D.220.R.07-C25	22	25	32	163	88	107	1	SONT 072907	485.43	220
MD900.4D.230.R.07-C25	23	25	32	167	92	111	1	SONT 072907	501.60	230
MD900.4D.240.R.08-C32	24	32	40	179	96	119	1,2	SONT 083308	501.60	240
MD900.4D.250.R.08-C32	25	32	40	183	100	123	1,2	SONT 083308	501.60	250
MD900.4D.260.R.08-C32	26	32	40	187	104	127	1,2	SONT 083308	554.12	260
MD900.4D.270.R.08-C32	27	32	40	191	108	131	1,2	SONT 083308	554.12	270
MD900.4D.280.R.09-C32	28	32	40	195	112	135	2,2	SONT 093808	554.12	280
MD900.4D.290.R.09-C32	29	32	40	199	116	139	2,2	SONT 093808	554.12	290
MD900.4D.300.R.09-C32	30	32	40	203	120	143	2,2	SONT 093808	554.12	300
MD900.4D.310.R.09-C32	31	32	40	207	124	147	2,2	SONT 093808	601.46	310
MD900.4D.320.R.09-C32	32	32	40	211	128	151	2,2	SONT 093808	601.46	320
MD900.4D.330.R.10-C40	33	40	50	228	132	158	3,2	SONT 104408	601.46	330
MD900.4D.340.R.10-C40	34	40	50	232	136	162	3,2	SONT 104408	601.46	340
MD900.4D.350.R.10-C40	35	40	50	236	140	166	3,2	SONT 104408	614.05	350
MD900.4D.360.R.10-C40	36	40	50	240	144	170	3,2	SONT 104408	614.05	360
MD900.4D.370.R.12-C40	37	40	56	248	148	178	3,2	SONT 124810	635.16	370
MD900.4D.380.R.12-C40	38	40	56	252	152	182	3,2	SONT 124810	635.16	380
MD900.4D.390.R.12-C40	39	40	56	256	156	186	3,2	SONT 124810	635.16	390
MD900.4D.400.R.12-C40	40	40	56	260	160	190	3,2	SONT 124810	635.16	400
MD900.4D.410.R.12-C40	41	40	56	264	164	194	3,2	SONT 124810	635.16	410
MD900.4D.420.R.13-C40	42	40	60	271	168	201	5	SONT 135012	666.34	420
MD900.4D.430.R.13-C40	43	40	60	275	172	205	5	SONT 135012	666.34	430
MD900.4D.440.R.13-C40	44	40	60	279	176	209	5	SONT 135012	666.34	440

MaxiDrill 900 – Indexable insert drill

Scope of supply:

Indexable Insert Drill including clamping screws and key

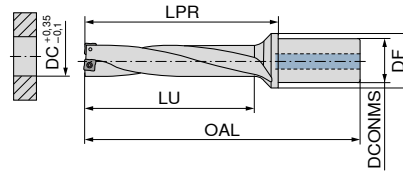
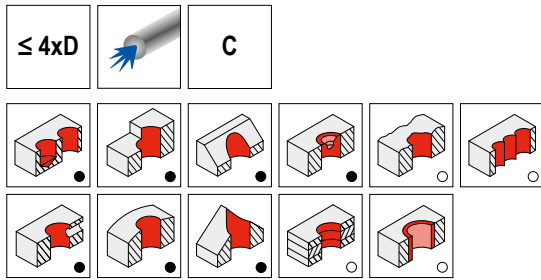

3

Designation	DC mm	DCONMS mm	DF mm	OAL mm	LU mm	LPR mm	torque moment Nm	Insert	10 854 ...	
									£	
MD900.4D.450.R.13-C40	45	40	60	283	180	213	5	SONT 135012	2B/41	666.34 450
MD900.4D.460.R.13-C40	46	40	60	287	184	217	5	SONT 135012	2B/41	666.34 460
MD900.4D.470.R.15-C40	47	40	60	292	188	222	5	SONT 155312	2A/28	702.58 470
MD900.4D.480.R.15-C40	48	40	60	296	192	226	5	SONT 155312	2A/28	702.58 480
MD900.4D.490.R.15-C40	49	40	60	300	196	230	5	SONT 155312	2A/28	702.58 490
MD900.4D.500.R.15-C40	50	40	60	304	200	234	5	SONT 155312	2A/28	702.58 500
MD900.4D.510.R.15-C40	51	40	60	308	204	238	5	SONT 155312	2A/28	702.58 510
MD900.4D.520.R.15-C40	52	40	60	312	208	242	5	SONT 155312	2A/28	702.58 520
MD900.4D.530.R.15-C40	53	40	60	316	212	246	5	SONT 155312	2A/28	702.58 530
MD900.4D.540.R.15-C40	54	40	60	320	216	250	5	SONT 155312	2A/28	702.58 540

Spare parts
DC

DC	80 950 ...		70 950 ...	
	£		£	
12 - 13,5	Y7		2A/28	
14 - 17,5	17.37	123	4.26	862
18 - 23	17.37	123	3.79	863
24 - 27	17.13	124	3.67	856
28 - 32	17.13	125	4.73	857
33 - 41	18.76	126	3.61	819
42 - 54	20.03	128	3.61	859
	21.03	129	3.61	864

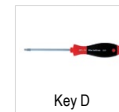

Matching holders can be found in → Chapter 16 Adapters and accessories in the clamping technology catalogue

MaxiDrill 900 – Indexable insert drill

Scope of supply:

Indexable Insert Drill including clamping screws and key

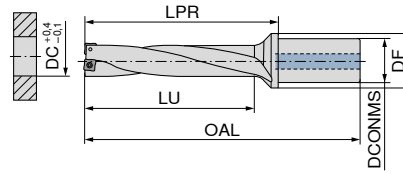
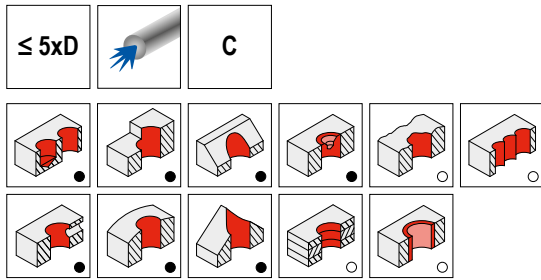

10 855 ...

Designation	DC mm	DCONMS mm	DF mm	OAL mm	LU mm	LPR mm	torque moment Nm	Insert	£	
									2B/41	
MD900.5D.120.R.03-C20	12	20	28	126	60.0	76.0	0,4	SONT 031804	494.32	120
MD900.5D.125.R.03-C20	12.5	20	28	128	62.5	78.0	0,4	SONT 031804	494.32	125
MD900.5D.130.R.03-C20	13	20	28	131	65.0	81.0	0,4	SONT 031804	494.32	130
MD900.5D.135.R.03-C20	13.5	20	28	132	67.5	82.0	0,4	SONT 031804	494.32	135
MD900.5D.140.R.04-C20	14	20	30	137	70.0	87.0	0,7	SONT 042105	505.41	140
MD900.5D.145.R.04-C20	14.5	20	30	139	72.5	89.0	0,7	SONT 042105	505.41	145
MD900.5D.150.R.04-C20	15	20	30	142	75.0	92.0	0,7	SONT 042105	505.41	150
MD900.5D.155.R.04-C20	15.5	20	30	144	77.5	94.5	0,7	SONT 042105	505.41	155
MD900.5D.160.R.05-C20	16	20	30	147	80.0	97.0	0,7	SONT 052306	517.87	160
MD900.5D.165.R.05-C20	16.5	20	30	149	82.5	99.0	0,7	SONT 052306	517.87	165
MD900.5D.170.R.05-C20	17	20	30	152	85.0	102.0	0,7	SONT 052306	536.58	170
MD900.5D.175.R.05-C20	17.5	20	30	154	87.5	104.0	0,7	SONT 052306	536.58	175
MD900.5D.180.R.06-C25	18	25	32	164	90.0	108.0	1	SONT 062506	536.58	180
MD900.5D.185.R.06-C25	18.5	25	32	166	92.5	110.0	1	SONT 062506	536.58	185
MD900.5D.190.R.06-C25	19	25	32	169	95.0	113.0	1	SONT 062506	576.53	190
MD900.5D.195.R.06-C25	19.5	25	32	171	97.5	115.0	1	SONT 062506	576.53	195
MD900.5D.200.R.06-C25	20	25	32	174	100.0	118.0	1	SONT 062506	576.53	200
MD900.5D.205.R.06-C25	20.5	25	32	175	102.5	119.0	1	SONT 062506	576.53	205
MD900.5D.210.R.07-C25	21	25	32	180	105.0	124.0	1	SONT 072907	576.53	210
MD900.5D.220.R.07-C25	22	25	32	184	110.0	128.0	1	SONT 072907	576.53	220
MD900.5D.230.R.07-C25	23	25	32	189	115.0	133.0	1	SONT 072907	597.06	230
MD900.5D.240.R.08-C32	24	32	40	203	120.0	143.0	1,2	SONT 083308	597.06	240
MD900.5D.250.R.08-C32	25	32	40	208	125.0	148.0	1,2	SONT 083308	597.06	250
MD900.5D.260.R.08-C32	26	32	40	212	130.0	152.0	1,2	SONT 083308	658.94	260
MD900.5D.270.R.08-C32	27	32	40	217	135.0	157.0	1,2	SONT 083308	658.94	270
MD900.5D.280.R.09-C32	28	32	40	221	140.0	161.0	2,2	SONT 093808	658.94	280
MD900.5D.290.R.09-C32	29	32	40	226	145.0	166.0	2,2	SONT 093808	658.94	290
MD900.5D.300.R.09-C32	30	32	40	230	150.0	170.0	2,2	SONT 093808	658.94	300
MD900.5D.310.R.09-C32	31	32	40	235	155.0	175.0	2,2	SONT 093808	713.78	310
MD900.5D.320.R.09-C32	32	32	40	239	160.0	179.0	2,2	SONT 093808	713.78	320
MD900.5D.330.R.10-C40	33	40	50	259	165.0	191.0	3,2	SONT 104408	713.78	330
MD900.5D.340.R.10-C40	34	40	50	264	170.0	196.0	3,2	SONT 104408	713.78	340
MD900.5D.350.R.10-C40	35	40	50	269	175.0	201.0	3,2	SONT 104408	729.94	350
MD900.5D.360.R.10-C40	36	40	50	274	180.0	206.0	3,2	SONT 104408	729.94	360
MD900.5D.370.R.12-C40	37	40	56	285	185.0	215.0	3,2	SONT 124810	755.00	370
MD900.5D.380.R.12-C40	38	40	56	290	190.0	220.0	3,2	SONT 124810	755.00	380
MD900.5D.390.R.12-C40	39	40	56	295	195.0	225.0	3,2	SONT 124810	755.00	390
MD900.5D.400.R.12-C40	40	40	56	300	200.0	230.0	3,2	SONT 124810	755.00	400
MD900.5D.410.R.12-C40	41	40	56	305	205.0	235.0	3,2	SONT 124810	755.00	410

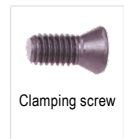
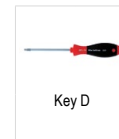

Spare parts

DC	80 950 ...	70 950 ...
	£ Y7	£ 2A/28
12 - 13,5	T06 - IP 17.37 123	M1,8x3,6 - IP 4.26 862
14 - 17,5	T06 - IP 17.37 123	M2x4,3 - IP 3.79 863
18 - 23	T07 - IP 17.13 124	M2,2x5 - IP 3.67 856
24 - 27	T08 - IP 17.13 125	M2,5x6 - IP 4.73 857
28 - 32	T09 - IP 18.76 126	M3x7 - IP 3.61 819
33 - 41	T15 - IP 20.03 128	M3,5x8,6 - IP 3.61 859

Matching holders can be found in → Chapter 16 Adapters and accessories in the clamping technology catalogue

SONT

Designation	IC mm	D1 mm	L mm	S mm
SONT 0318..	5.4	2.10	3.8	1.80
SONT 0421..	4.6	2.25	4.2	2.10
SONT 0523..	5.3	2.25	4.8	2.30
SONT 0625..	5.9	2.50	5.5	2.50
SONT 0729..	6.5	2.50	6.1	2.90
SONT 0833..	7.7	2.90	7.3	3.30
SONT 0938..	8.9	3.50	8.5	3.80
SONT 1044..	10.1	4.10	9.6	4.40
SONT 1248..	11.6	4.10	11.0	4.80
SONT 1350..	13.0	5.30	12.2	5.00
SONT 1553..	15.2	5.30	14.4	5.30
SONT 1756..	17.5	5.30	16.7	5.60

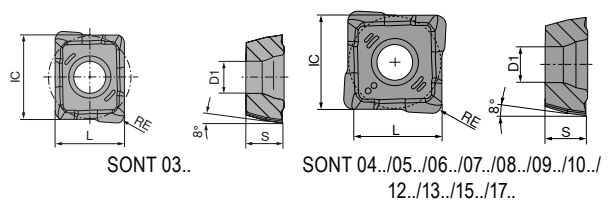

3

SONT

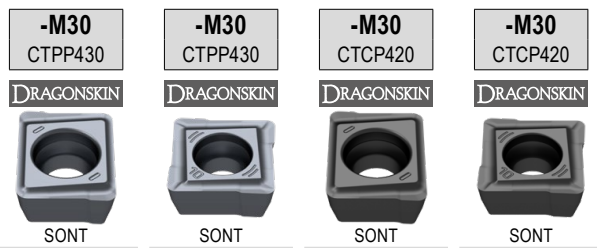

ISO	RE mm	10 830 ...		10 830 ...		10 830 ...		10 830 ...	
		£		£		£		£	
031804	0.4	1A/08	103 ¹⁾	1A/08		1A/08	703 ¹⁾	1A/08	
042105	0.5	13.98		16.02	104	13.98		16.02	704
052306	0.6			16.24	105			16.24	705
062506	0.6			16.50	106			16.50	706
072907	0.7			16.88	107			16.88	707
083308	0.8			17.24	108			17.24	708
093808	0.8			17.67	109			17.67	709
104408	0.8			18.51	110			18.51	710
124810	1.0			19.60	112			19.60	712
135012	1.2			20.76	113			20.76	713
155312	1.2			23.54	115			23.54	715
175612	1.2			24.95	117			24.95	717

P	●	●	●	●
M	●	●	●	●
K	○	○	●	●
N	○	○		
S	○	○		
H				
O				

1) two usable cutting edges

→ v_c Page 74-77

i CTCP420 -M30 is exclusively recommended for use on the peripheral cutting edge!

i Further information on grades and chip breakers can be found on page 85 + 86

Application tips – eccentric sleeves

Using eccentric sleeves, the diameter of the hole can be varied and adjusted by ± 0.3 mm with ease.

Two types of eccentric sleeve are available:

One for use with the new indexable insert drill adapter and one for use with the existing Weldon adapter.

The difference lies solely in the design and position of the slots for the adapter's clamping screws.

There are four sizes per type, which are tailored to the shank diameter.



Eccentric sleeve for indexable insert drill adapter

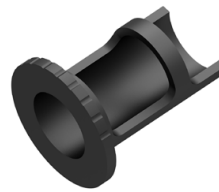

Eccentric sleeve for Weldon adapter

A scale is engraved on every eccentric sleeve (radially and on the face), so that the user can adjust the bore diameter according to requirements.

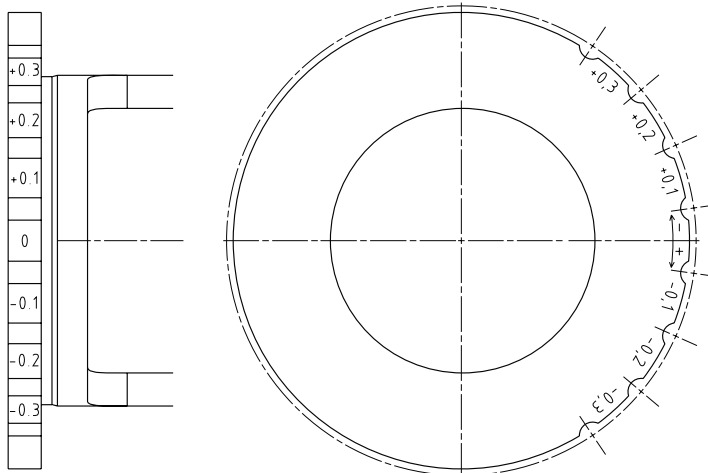

Side view

End view

Instructions for use

1. Position the sleeve in the respective adapter and insert the indexable insert drill.
2. Set the sleeve to the zero position. → The „0“ must align with the clamping screws on the adapter.
3. Clamp the adapter's clamping screws.
4. Drill.
5. Measure the bore diameter.
6. Loosen the clamping screws.
7. Correct the bore diameter using the sleeve. → Observe the scale on the sleeve. The value must align with the clamping screws on the adapter.
8. Clamp the clamping screws.
9. Drill.



A scale is engraved on every eccentric sleeve (radially and on the face).



Owing to the radial adjustment of the drill axis, the feed rate should be reduced by approx. 30 % for longer drilling tools (4xD and 5xD).

Eccentric sleeve – indexable insert drill adapter

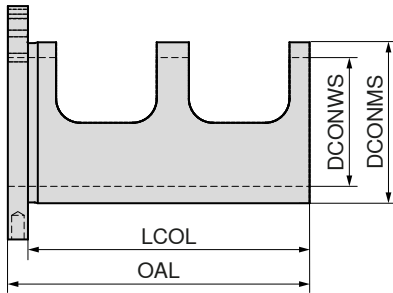

3

Designation	DCONWS mm	DCONMS mm	OAL mm	LCOL mm	10 870 ...	
					£	
EHB.D20.D25	20	25	61	56	180.32	120
EHB.D25.D32	25	32	65	60	196.12	125
EHB.D32.D40	32	40	75	70	214.27	132
EHB.D40.D50	40	50	85	80	234.82	140

Eccentric sleeve – standard Weldon adapter

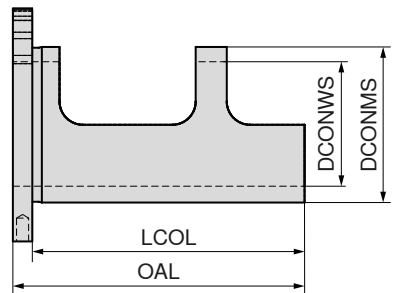

Designation	DCONWS mm	DCONMS mm	OAL mm	LCOL mm	10 871 ...	
					£	
EHW.D20.D25	20	25	61	56	180.32	120
EHW.D25.D32	25	32	65	60	196.12	125
EHW.D32.D40	32	40	75	70	214.27	132
EHW.D40.D50	40	50	85	80	234.82	140

 Application tips for eccentric sleeves can be found on → **Page 58**.

Adjuster with ABS connection

- ▲ Precise adjustment using micrometric adjusting spindle
- ▲ Max. adjustment range 3 mm on diameter
- ▲ Graduation of scale 1 line 0.02 mm on diameter
- ▲ Stable clamping of the top section after adjustment using four clamping screws arranged on the face
- ▲ SZID = nominal size

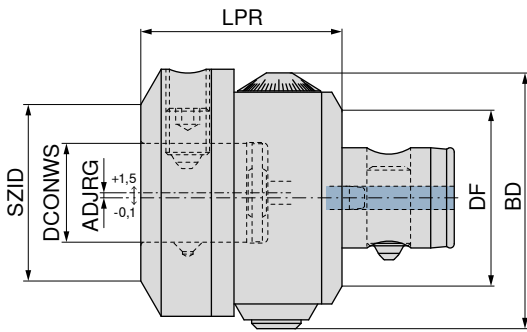

AD

84 210 ...

£

W4/6A

1,793.55 05097

1,793.55 06397

1,379.15 06396

Adapter	KOMET no.	BD mm	LPR mm	DF mm	DCONWS mm	ADJRG mm	SZID
ABS 50	M01 00001	70	57	50	28	1.5	ABS 50
ABS 63	M01 00011	88	70	63	28	1.5	ABS 50
ABS 63	M01 00021	88	70	63	34	1.5	ABS 63

Material examples for cutting data tables

	Material sub-group	Index	Composition / Structure / Heat treatment	Tensile strength N/mm ² / HB / HRC	Material number	Material designation	Material number	Material designation
P	Unalloyed steel	P.1.1	< 0,15 % C Annealed	420 N/mm ² / 125 HB	1.0401	C15	1.1141	Ck15
		P.1.2	< 0,45 % C Annealed	640 N/mm ² / 190 HB	1.1191	C45E	1.0718	9SMnPb28
		P.1.3	< 0,45 % C Tempered	840 N/mm ² / 250 HB	1.1191	C45E	1.0535	C55
		P.1.4	< 0,75 % C Annealed	910 N/mm ² / 270 HB	1.1223	C60R	1.0535	C55
		P.1.5	< 0,75 % C Tempered	1010 N/mm ² / 300 HB	1.1223	C60R	1.0727	45S20
	Low-alloy steel	P.2.1	Annealed	610 N/mm ² / 180 HB	1.7131	16MnCr5	1.6587	17CrNiMo6
		P.2.2	Tempered	930 N/mm ² / 275 HB	1.7131	16MnCr5	1.6587	17CrNiMo6
		P.2.3	Tempered	1010 N/mm ² / 300 HB	1.7225	42CrMo4	1.3505	100Cr6
		P.2.4	Tempered	1200 N/mm ² / 375 HB	1.7225	42CrMo4	1.3505	100Cr6
	High-alloy steel and high-alloy tool steel	P.3.1	Annealed	680 N/mm ² / 200 HB	1.4021	X20Cr13	1.4034	X46Cr13
		P.3.2	Hardened and tempered	1100 N/mm ² / 300 HB	1.2343	X38CrMoV5-1	1.4034	X46Cr13
		P.3.3	Hardened and tempered	1300 N/mm ² / 400 HB	1.2343	X38CrMoV5-1	1.4034	X46Cr13
	Stainless steel	P.4.1	Ferritic / martensitic Annealed	680 N/mm ² / 200 HB	1.4016	X6Cr17	1.2316	X36CrMo16
		P.4.2	Martensitic Tempered	1010 N/mm ² / 300 HB	1.4112	X90CrMoV18	1.2316	X36CrMo16
M	Stainless steel	M.1.1	Austenitic / austenitic-ferritic Quenched	610 N/mm ² / 180 HB	1.4301	X5CrNi18-10	1.4571	X6CrNiMoTi17-12-2
		M.2.1	Austenitic Tempered	300 HB	1.4841	X15CrNiSi25-21	1.4539	X1NiCrMoCu25-20-5
		M.3.1	Austenitic / ferritic (Duplex)	780 N/mm ² / 230 HB	1.4462	X2CrNiMoN22-5-3	1.4501	X2CrNiMoCuWN25-7-4
K	Grey cast iron	K.1.1	Pearlitic / ferritic	350 N/mm ² / 180 HB	0.6010	GG-10	0.6025	GG-25
		K.1.2	Pearlitic (martensitic)	500 N/mm ² / 260 HB	0.6030	GG-30	0.6045	GG-45
	Spherulitic graphite cast iron	K.2.1	Ferritic	540 N/mm ² / 160 HB	0.7040	GGG-40	0.7060	GGG-60
		K.2.2	Pearlitic	845 N/mm ² / 250 HB	0.7070	GGG-70	0.7080	GGG-80
	Malleable iron	K.3.1	Ferritic	440 N/mm ² / 130 HB	0.8035	GTW-35-04	0.8045	GTW-45
		K.3.2	Pearlitic	780 N/mm ² / 230 HB	0.8165	GTS-65-02	0.8170	GTS-70-02
N	Aluminium wrought alloy	N.1.1	Non-hardenable	60 HB	3.0255	Al99,5	3.3315	AlMg1
		N.1.2	Hardenable Age-hardened	340 N/mm ² / 100 HB	3.1355	AlCuMg2	3.2315	AlMgSi1
	Cast aluminium alloy	N.2.1	≤ 12 % Si, non-hardenable	250 N/mm ² / 75 HB	3.2581	G-AlSi12	3.2163	G-AlSi9Cu3
		N.2.2	≤ 12 % Si, hardenable Age-hardened	300 N/mm ² / 90 HB	3.2134	G-AlSi5Cu1Mg	3.2373	G-AlSi9Mg
		N.2.3	> 12 % Si, non-hardenable	440 N/mm ² / 130 HB		G-AlSi17Cu4Mg		G-AlSi18CuNiMg
	Copper and copper alloys (bronze/brass)	N.3.1	Free-machining alloys, PB > 1 %	375 N/mm ² / 110 HB	2.0380	CuZn39Pb2 (Ms58)	2.0410	CuZn44Pb2
		N.3.2	CuZn, CuSnZn	300 N/mm ² / 90 HB	2.0331	CuZn15	2.4070	CuZn28Sn1As
		N.3.3	CuSn, lead-free copper and electrolytic copper	340 N/mm ² / 100 HB	2.0060	E-Cu57	2.0590	CuZn40Fe
	Magnesium alloys	N.4.1	Magnesium and magnesium alloys	70 HB	3.5612	MgAl6Zn	3.5312	MgAl3Zn
	S	Heat-resistant alloys	S.1.1	Fe - basis Annealed	680 N/mm ² / 200 HB	1.4864	X12NiCrSi 36-16	1.4865
S.1.2			Fe - basis Age-hardened	950 N/mm ² / 280 HB	1.4980	X6NiCrTiMoVB25-15-2	1.4876	X10NiCrAlTi32-20
S.2.1			Ni or Co basis Annealed	840 N/mm ² / 250 HB	2.4631	NiCr20TiAl (Nimonic80A)	3.4856	NiCr22Mo9Nb
S.2.2			Ni or Co basis Age-hardened	1180 N/mm ² / 350 HB	2.4668	NiCr19Nb5Mo3 (Inconel 718)	2.4955	NiFe25Cr20NbTi
S.2.3			Ni or Co basis Cast	1080 N/mm ² / 320 HB	2.4765	CoCr20W15Ni	1.3401	G-X120Mn12
Titanium alloys		S.3.1	Pure titanium	400 N/mm ²	3.7025	Ti99,8	3.7034	Ti99,7
		S.3.2	Alpha + beta alloys Age-hardened	1050 N/mm ² / 320 HB	3.7165	TiAl6V4	Ti-6246	Ti-6Al-2Sn-4Zr-6Mo
S.3.3	Beta alloys	1400 N/mm ² / 410 HB	Ti555.3	Ti-5Al-5V-5Mo-3Cr	R56410	Ti-10V-2Fe-3Al		
H	Hardened steel	H.1.1	Hardened and tempered	46–55 HRC				
		H.1.2	Hardened and tempered	56–60 HRC				
		H.1.3	Hardened and tempered	61–65 HRC				
		H.1.4	Hardened and tempered	66–70 HRC				
	Chilled iron	H.2.1	Cast	400 HB				
	Hardened cast iron	H.3.1	Hardened and tempered	55 HRC				
O	Non-metal materials	O.1.1	Plastics, duroplastic	≤ 150 N/mm ²				
		O.1.2	Plastics, thermoplastic	≤ 100 N/mm ²				
		O.2.1	Aramid fibre-reinforced	≤ 1000 N/mm ²				
		O.2.2	Glass/carbon-fibre reinforced	≤ 1000 N/mm ²				
		O.3.1	Graphite					

* Tensile strength

Cutting data standard values for SOGX indexable inserts

Index	10 820 ...					
	-01 / -13 / -32 BK8425	-03 / -21 BK8430	-01 / -21 BK7935	-01 BK6115	-01 BK7710	-34 BK8425
	v _c (m/min)					
P.1.1	260	260	250	300		
P.1.2	260	260	220	300		260
P.1.3	270	270	270	270		
P.1.4	250	250	250	250		
P.1.5	270	270	200	300		270
P.2.1	270	270	270	270		
P.2.2	260	260	260	260		
P.2.3	180	180	160	240		180
P.2.4	150	150	130	200		150
P.3.1	160	160	140	200		160
P.3.2	130	130	120	160		130
P.3.3	120	120	110	140		120
P.4.1	180	180	150	220		
P.4.2	130	130	120	160		
M.1.1	150	150	160	220		
M.2.1	150	150	160	220		
M.3.1	140	140	150	200		
K.1.1	160	160	150	240		160
K.1.2	120	120	120	180		120
K.2.1	160	160	150	160		160
K.2.2	100	100	90	100		100
K.3.1	120	120	110	120		120
K.3.2	100	100	90	100		100
N.1.1	400	400	400		500	
N.1.2	400	400	400		500	
N.2.1	250	250	250		280	
N.2.2	250	250	250		280	
N.2.3	230	230	230		250	
N.3.1	200	200	200		250	
N.3.2	220	220	220		280	
N.3.3	330	330	330		390	
N.4.1	200	200	200		250	
S.1.1	60	60	60			
S.1.2	50	50	50			
S.2.1	60	60	60			
S.2.2	50	50	50			
S.2.3	30	30	30			
S.3.1	100	100	100		100	
S.3.2	80	80	80		80	
S.3.3	50	50	50		50	
H.1.1	100	100		100		
H.1.2	80	80		80		
H.1.3	50	50		50		
H.1.4						
H.2.1	100	100		100		
H.3.1	80	80		80		
O.1.1			100		100	
O.1.2			100		100	
O.2.1						
O.2.2			100		100	
O.3.1			100		100	



Feed rate values of -34 topography, see → page 65.

BK6115 -01 / BK7935 -21 are exclusively recommended for use on the peripheral cutting edge!

During the drilling operation on through holes a sharp disk will be produced. Safety precautions must be observed. A safety guard has to be provided as protection.

Cutting data standard values for KUB Pentron – 2xD, 3xD / KUB Pentron CS

Index	10 872 ..., 10 873 ...								
	ABS / PSC / C								
	Ø 14–15,5	Ø 16–17,5	Ø 18–19,5	Ø 20–21,5	Ø 22–23,5	Ø 24–25,5	Ø 26–27,5	Ø 28–30	Ø 31–33
	f (mm/rev)								
P.1.1	0,08	0,08	0,09	0,10	0,10	0,10	0,10	0,10	0,10
P.1.2	0,10	0,13	0,13	0,15	0,16	0,15	0,18	0,18	0,18
P.1.3	0,08	0,12	0,12	0,13	0,13	0,13	0,13	0,13	0,13
P.1.4	0,08	0,11	0,11	0,12	0,12	0,12	0,12	0,12	0,12
P.1.5	0,09	0,12	0,12	0,14	0,14	0,14	0,16	0,16	0,16
P.2.1	0,08	0,12	0,12	0,13	0,13	0,13	0,13	0,13	0,13
P.2.2	0,08	0,11	0,11	0,12	0,12	0,12	0,12	0,12	0,12
P.2.3	0,12	0,14	0,16	0,16	0,16	0,18	0,18	0,18	0,18
P.2.4	0,10	0,11	0,13	0,13	0,13	0,14	0,14	0,14	0,14
P.3.1	0,08	0,12	0,12	0,16	0,16	0,18	0,18	0,18	0,18
P.3.2	0,07	0,10	0,10	0,13	0,13	0,14	0,14	0,14	0,14
P.3.3	0,06	0,08	0,08	0,11	0,11	0,13	0,13	0,13	0,13
P.4.1	0,09	0,13	0,13	0,18	0,18	0,20	0,20	0,20	0,20
P.4.2	0,07	0,10	0,10	0,13	0,13	0,14	0,14	0,14	0,14
M.1.1	0,10	0,10	0,12	0,14	0,15	0,15	0,15	0,15	0,15
M.2.1	0,10	0,08	0,08	0,11	0,11	0,14	0,14	0,14	0,14
M.3.1	0,09	0,07	0,07	0,10	0,10	0,13	0,13	0,13	0,13
K.1.1	0,12	0,15	0,15	0,18	0,18	0,22	0,25	0,25	0,25
K.1.2	0,09	0,11	0,11	0,14	0,14	0,17	0,19	0,19	0,19
K.2.1	0,12	0,15	0,15	0,18	0,18	0,22	0,25	0,25	0,25
K.2.2	0,10	0,12	0,12	0,14	0,14	0,18	0,20	0,20	0,20
K.3.1	0,12	0,15	0,15	0,18	0,18	0,22	0,25	0,25	0,25
K.3.2	0,10	0,12	0,12	0,14	0,14	0,18	0,20	0,20	0,20
N.1.1	0,10	0,11	0,11	0,11	0,13	0,13	0,13	0,13	0,13
N.1.2	0,10	0,11	0,11	0,11	0,13	0,13	0,13	0,13	0,13
N.2.1	0,10	0,13	0,13	0,13	0,15	0,15	0,15	0,15	0,15
N.2.2	0,10	0,13	0,13	0,13	0,15	0,15	0,15	0,15	0,15
N.2.3	0,09	0,12	0,12	0,12	0,14	0,14	0,14	0,14	0,14
N.3.1	0,10	0,12	0,13	0,13	0,15	0,15	0,15	0,15	0,15
N.3.2	0,11	0,13	0,14	0,14	0,17	0,17	0,17	0,17	0,17
N.3.3	0,11	0,12	0,12	0,14	0,14	0,14	0,14	0,14	0,14
N.4.1	0,10	0,12	0,13	0,13	0,15	0,15	0,15	0,15	0,15
S.1.1	0,03	0,03	0,03	0,03	0,04	0,06	0,06	0,06	0,06
S.1.2	0,03	0,03	0,03	0,03	0,04	0,04	0,06	0,06	0,06
S.2.1	0,03	0,03	0,03	0,03	0,04	0,06	0,06	0,06	0,06
S.2.2	0,03	0,03	0,03	0,03	0,04	0,04	0,06	0,06	0,06
S.2.3	0,02	0,02	0,02	0,02	0,03	0,03	0,04	0,04	0,04
S.3.1	0,05	0,05	0,05	0,05	0,06	0,08	0,10	0,10	0,10
S.3.2	0,04	0,04	0,04	0,04	0,05	0,07	0,09	0,09	0,09
S.3.3	0,03	0,03	0,03	0,03	0,04	0,04	0,06	0,06	0,06
H.1.1	0,05	0,05	0,05	0,05	0,06	0,06	0,06	0,06	0,06
H.1.2	0,03	0,03	0,03	0,03	0,04	0,04	0,04	0,04	0,04
H.1.3	0,03	0,03	0,03	0,03	0,04	0,04	0,04	0,04	0,04
H.1.4									
H.2.1	0,04	0,04	0,04	0,04	0,05	0,05	0,05	0,05	0,05
H.3.1	0,03	0,03	0,03	0,03	0,04	0,04	0,04	0,04	0,04
O.1.1	0,08	0,08	0,08	0,10	0,10	0,10	0,10	0,10	0,10
O.1.2	0,08	0,08	0,08	0,10	0,10	0,10	0,10	0,10	0,10
O.2.1									
O.2.2	0,06	0,06	0,06	0,06	0,07	0,07	0,07	0,07	0,07
O.3.1	0,10	0,10	0,10	0,10	0,11	0,11	0,11	0,11	0,11

 In order to ensure efficient chip evacuation, coolant pressure must be at least 5 bar. Optimum pressure is > 15 bar.

Cutting data standard values for KUB Pentron – 2xD, 3xD / KUB Pentron CS

Index	10 872 ..., 10 873 ...					10 876 ...			
	ABS / PSC / C					KUB Pentron CS – 3xD			
	Ø 34–37	Ø 38–42	Ø 43–46	Ø 46–52	Ø 53–65	Ø 64–69	Ø 70–75	Ø 76–84	Ø 85–96
	f (mm/rev)					f (mm/rev)			
P.1.1	0,10	0,10	0,10	0,10	0,10	0,10	0,10	0,10	0,10
P.1.2	0,18	0,18	0,18	0,18	0,18	0,15	0,15	0,15	0,15
P.1.3	0,13	0,13	0,13	0,16	0,16	0,15	0,15	0,15	0,15
P.1.4	0,12	0,12	0,12	0,14	0,14	0,14	0,14	0,14	0,14
P.1.5	0,16	0,16	0,16	0,16	0,16	0,14	0,14	0,14	0,14
P.2.1	0,13	0,13	0,13	0,16	0,16	0,15	0,15	0,15	0,15
P.2.2	0,12	0,12	0,12	0,14	0,14	0,14	0,14	0,14	0,14
P.2.3	0,18	0,18	0,18	0,18	0,18	0,20	0,20	0,20	0,20
P.2.4	0,14	0,14	0,14	0,14	0,14	0,16	0,16	0,16	0,16
P.3.1	0,18	0,18	0,18	0,18	0,18	0,18	0,18	0,18	0,18
P.3.2	0,14	0,14	0,14	0,14	0,14	0,14	0,14	0,14	0,14
P.3.3	0,13	0,13	0,13	0,13	0,13	0,13	0,13	0,13	0,13
P.4.1	0,20	0,20	0,20	0,20	0,20	0,20	0,20	0,20	0,20
P.4.2	0,14	0,14	0,14	0,14	0,14	0,14	0,14	0,14	0,14
M.1.1	0,15	0,15	0,15	0,16	0,16	0,16	0,16	0,16	0,16
M.2.1	0,14	0,14	0,14	0,14	0,14	0,14	0,14	0,14	0,14
M.3.1	0,13	0,13	0,13	0,13	0,13	0,13	0,13	0,13	0,13
K.1.1	0,25	0,25	0,25	0,25	0,25	0,25	0,25	0,25	0,25
K.1.2	0,19	0,19	0,19	0,19	0,19	0,19	0,19	0,19	0,19
K.2.1	0,25	0,25	0,25	0,25	0,25	0,25	0,25	0,25	0,25
K.2.2	0,20	0,20	0,20	0,20	0,20	0,20	0,20	0,20	0,20
K.3.1	0,25	0,25	0,25	0,25	0,25	0,25	0,25	0,25	0,25
K.3.2	0,20	0,20	0,20	0,20	0,20	0,20	0,20	0,20	0,20
N.1.1	0,13	0,13	0,13	0,14	0,14	0,14	0,14	0,14	0,14
N.1.2	0,13	0,13	0,13	0,14	0,14	0,14	0,14	0,14	0,14
N.2.1	0,15	0,15	0,15	0,18	0,18	0,18	0,18	0,18	0,18
N.2.2	0,15	0,15	0,15	0,18	0,18	0,18	0,18	0,18	0,18
N.2.3	0,14	0,14	0,14	0,16	0,16	0,16	0,16	0,16	0,16
N.3.1	0,15	0,15	0,15	0,16	0,16	0,16	0,16	0,16	0,16
N.3.2	0,17	0,17	0,17	0,18	0,18	0,18	0,18	0,18	0,18
N.3.3	0,14	0,14	0,14	0,18	0,18	0,16	0,16	0,16	0,16
N.4.1	0,15	0,15	0,15	0,16	0,16	0,16	0,16	0,16	0,16
S.1.1	0,06	0,06	0,06	0,06	0,06	0,06	0,06	0,06	0,06
S.1.2	0,06	0,06	0,06	0,06	0,06	0,06	0,06	0,06	0,06
S.2.1	0,06	0,06	0,06	0,06	0,06	0,06	0,06	0,06	0,06
S.2.2	0,06	0,06	0,06	0,06	0,06	0,06	0,06	0,06	0,06
S.2.3	0,04	0,04	0,04	0,04	0,04	0,04	0,04	0,04	0,04
S.3.1	0,10	0,10	0,10	0,10	0,10	0,10	0,10	0,10	0,10
S.3.2	0,09	0,09	0,09	0,09	0,09	0,09	0,09	0,09	0,09
S.3.3	0,06	0,06	0,06	0,06	0,06	0,06	0,06	0,06	0,06
H.1.1	0,06	0,06	0,06	0,06	0,06	0,06	0,06	0,06	0,06
H.1.2	0,04	0,04	0,04	0,04	0,04	0,04	0,04	0,04	0,04
H.1.3	0,04	0,04	0,04	0,04	0,04	0,04	0,04	0,04	0,04
H.1.4									
H.2.1	0,05	0,05	0,05	0,05	0,05	0,05	0,05	0,05	0,05
H.3.1	0,04	0,04	0,04	0,04	0,04	0,04	0,04	0,04	0,04
O.1.1	0,10	0,10	0,10	0,10	0,10	0,10	0,10	0,10	0,10
O.1.2	0,10	0,10	0,10	0,10	0,10	0,10	0,10	0,10	0,10
O.2.1									
O.2.2	0,07	0,07	0,07	0,07	0,07	0,07	0,07	0,07	0,07
O.3.1	0,11	0,11	0,11	0,11	0,11	0,11	0,11	0,11	0,11

 During the drilling operation on through holes a sharp disk will be produced. Safety precautions must be observed. A safety guard has to be provided as protection.

Cutting data standard values for KUB Pentron – 2xD, 3xD / -34 indexable inserts topography

Index	-34 BK8425 v _c m/min	10 872 ..., 10 873 ...													
		ABS / PSC / C													
		∅ 14-15,5	∅ 16-17,5	∅ 18-19,5	∅ 20-21,5	∅ 22-23,5	∅ 24-25,5	∅ 26-27,5	∅ 28-30	∅ 31-33	∅ 34-37	∅ 38-42	∅ 43-46	∅ 46-52	∅ 53-65
		f (mm/rev)													
P.1.1															
P.1.2	260	0,17	0,20	0,20	0,23	0,23	0,23	0,27	0,27	0,27	0,27	0,27	0,27	0,23	0,27
P.1.3															
P.1.4															
P.1.5	270	0,17	0,20	0,20	0,23	0,23	0,23	0,27	0,27	0,27	0,27	0,27	0,27	0,23	0,27
P.2.1															
P.2.2															
P.2.3	180	0,18	0,21	0,24	0,24	0,24	0,27	0,27	0,27	0,27	0,27	0,27	0,27	0,27	0,27
P.2.4	150	0,17	0,2	0,23	0,23	0,23	0,26	0,26	0,26	0,26	0,26	0,26	0,26	0,26	0,26
P.3.1	160	0,12	0,18	0,18	0,24	0,24	0,27	0,27	0,27	0,27	0,27	0,27	0,27	0,27	0,27
P.3.2	130	0,11	0,17	0,17	0,23	0,23	0,26	0,26	0,26	0,26	0,26	0,26	0,26	0,26	0,26
P.3.3	120	0,11	0,17	0,17	0,23	0,23	0,26	0,26	0,26	0,26	0,26	0,26	0,26	0,26	0,26
P.4.1															
P.4.2															
M.1.1															
M.2.1															
M.3.1															
K.1.1	160	0,18	0,23	0,23	0,27	0,27	0,33	0,38	0,38	0,38	0,38	0,38	0,38	0,33	0,38
K.1.2	120	0,14	0,18	0,18	0,22	0,22	0,26	0,30	0,30	0,30	0,30	0,30	0,30	0,26	0,30
K.2.1	160	0,18	0,23	0,23	0,27	0,27	0,33	0,38	0,38	0,38	0,38	0,38	0,38	0,33	0,38
K.2.2	100	0,14	0,18	0,18	0,22	0,22	0,26	0,30	0,30	0,30	0,30	0,30	0,30	0,26	0,30
K.3.1	120	0,18	0,23	0,23	0,27	0,27	0,33	0,38	0,38	0,38	0,38	0,38	0,38	0,33	0,38
K.3.2	100	0,14	0,18	0,18	0,22	0,22	0,26	0,30	0,30	0,30	0,30	0,30	0,30	0,26	0,30
N.1.1															
N.1.2															
N.2.1															
N.2.2															
N.2.3															
N.3.1															
N.3.2															
N.3.3															
N.4.1															
S.1.1															
S.1.2															
S.2.1															
S.2.2															
S.2.3															
S.3.1															
S.3.2															
S.3.3															
H.1.1															
H.1.2															
H.1.3															
H.1.4															
H.2.1															
H.3.1															
O.1.1															
O.1.2															
O.2.1															
O.2.2															
O.3.1															

3

 In order to ensure efficient chip evacuation, coolant pressure must be at least 5 bar. Optimum pressure is > 15 bar.

 Usage of -34 topography is recommended only for KUB Pentron 2xD and 3xD. Not recommended for KUB Pentron 4xD and 5xD as well as KUB Pentron CS. Higher drive power and stable setup needed!

Cutting data standard values for KUB Pentron – 4xD

Index	10 874 ...											
	ABS / C											
	Ø 14–15,5	Ø 16–17,5	Ø 18–19,5	Ø 20–21,5	Ø 22–23,5	Ø 24–25,5	Ø 26–27,5	Ø 28–30	Ø 31–33	Ø 34–37	Ø 38–42	Ø 43–46
	f (mm/rev)											
P.1.1	0,06	0,07	0,07	0,09	0,09	0,09	0,09	0,09	0,09	0,09	0,09	0,09
P.1.2	0,08	0,13	0,13	0,15	0,15	0,15	0,18	0,18	0,18	0,18	0,18	0,18
P.1.3	0,06	0,12	0,12	0,13	0,13	0,13	0,13	0,13	0,13	0,13	0,13	0,13
P.1.4	0,05	0,11	0,11	0,12	0,12	0,12	0,12	0,12	0,12	0,12	0,12	0,12
P.1.5	0,07	0,12	0,12	0,14	0,14	0,14	0,16	0,16	0,16	0,16	0,16	0,16
P.2.1	0,06	0,12	0,12	0,13	0,13	0,13	0,13	0,13	0,13	0,13	0,13	0,13
P.2.2	0,05	0,11	0,11	0,12	0,12	0,12	0,12	0,12	0,12	0,12	0,12	0,12
P.2.3	0,08	0,14	0,14	0,15	0,16	0,18	0,18	0,18	0,18	0,18	0,18	0,18
P.2.4	0,06	0,11	0,11	0,12	0,13	0,14	0,14	0,14	0,14	0,14	0,14	0,14
P.3.1	0,08	0,12	0,12	0,16	0,15	0,18	0,18	0,18	0,18	0,18	0,18	0,18
P.3.2	0,06	0,10	0,10	0,13	0,12	0,14	0,14	0,14	0,14	0,14	0,14	0,14
P.3.3	0,06	0,08	0,08	0,11	0,11	0,13	0,13	0,13	0,13	0,13	0,13	0,13
P.4.1	0,09	0,13	0,13	0,18	0,17	0,20	0,20	0,20	0,20	0,20	0,20	0,20
P.4.2	0,06	0,10	0,10	0,13	0,12	0,14	0,14	0,14	0,14	0,14	0,14	0,14
M.1.1	0,08	0,10	0,10	0,13	0,15	0,15	0,15	0,15	0,15	0,15	0,15	0,15
M.2.1	0,08	0,08	0,08	0,11	0,11	0,14	0,14	0,14	0,14	0,14	0,14	0,14
M.3.1	0,07	0,07	0,07	0,10	0,10	0,13	0,13	0,13	0,13	0,13	0,13	0,13
K.1.1	0,12	0,15	0,15	0,18	0,18	0,22	0,25	0,25	0,25	0,25	0,25	0,25
K.1.2	0,10	0,10	0,10	0,10	0,10	0,20	0,20	0,20	0,20	0,20	0,20	0,20
K.2.1	0,12	0,15	0,15	0,18	0,18	0,22	0,25	0,25	0,25	0,25	0,25	0,25
K.2.2	0,10	0,12	0,12	0,14	0,14	0,18	0,20	0,20	0,20	0,20	0,20	0,20
K.3.1	0,12	0,15	0,15	0,18	0,18	0,22	0,25	0,25	0,25	0,25	0,25	0,25
K.3.2	0,10	0,12	0,12	0,14	0,14	0,18	0,20	0,20	0,20	0,20	0,20	0,20
N.1.1	0,10	0,11	0,11	0,11	0,13	0,13	0,13	0,13	0,13	0,13	0,13	0,13
N.1.2	0,10	0,11	0,11	0,11	0,13	0,13	0,13	0,13	0,13	0,13	0,13	0,13
N.2.1	0,10	0,13	0,13	0,13	0,15	0,15	0,15	0,15	0,15	0,15	0,15	0,15
N.2.2	0,10	0,13	0,13	0,13	0,15	0,15	0,15	0,15	0,15	0,15	0,15	0,15
N.2.3	0,09	0,12	0,12	0,12	0,14	0,14	0,14	0,14	0,14	0,14	0,14	0,14
N.3.1	0,10	0,12	0,13	0,13	0,15	0,15	0,15	0,15	0,15	0,15	0,15	0,15
N.3.2	0,11	0,13	0,14	0,14	0,17	0,17	0,17	0,17	0,17	0,17	0,17	0,17
N.3.3	0,11	0,12	0,12	0,14	0,14	0,14	0,14	0,14	0,14	0,14	0,14	0,14
N.4.1	0,10	0,12	0,13	0,13	0,15	0,15	0,15	0,15	0,15	0,15	0,15	0,15
S.1.1	0,03	0,03	0,03	0,03	0,04	0,06	0,06	0,06	0,06	0,06	0,06	0,06
S.1.2	0,03	0,03	0,03	0,03	0,04	0,04	0,06	0,06	0,06	0,06	0,06	0,06
S.2.1	0,03	0,03	0,03	0,03	0,04	0,06	0,06	0,06	0,06	0,06	0,06	0,06
S.2.2	0,03	0,03	0,03	0,03	0,04	0,04	0,06	0,06	0,06	0,06	0,06	0,06
S.2.3	0,02	0,02	0,02	0,02	0,03	0,03	0,04	0,04	0,04	0,04	0,04	0,04
S.3.1	0,05	0,05	0,05	0,05	0,06	0,08	0,10	0,10	0,10	0,10	0,10	0,10
S.3.2	0,04	0,04	0,04	0,04	0,05	0,07	0,09	0,09	0,09	0,09	0,09	0,09
S.3.3	0,03	0,03	0,03	0,03	0,04	0,04	0,06	0,06	0,06	0,06	0,06	0,06
H.1.1	0,05	0,05	0,05	0,05	0,06	0,06	0,06	0,06	0,06	0,06	0,06	0,06
H.1.2	0,03	0,03	0,03	0,03	0,04	0,04	0,04	0,04	0,04	0,04	0,04	0,04
H.1.3	0,03	0,03	0,03	0,03	0,04	0,04	0,04	0,04	0,04	0,04	0,04	0,04
H.1.4												
H.2.1	0,04	0,04	0,04	0,04	0,05	0,05	0,05	0,05	0,05	0,05	0,05	0,05
H.3.1	0,03	0,03	0,03	0,03	0,04	0,04	0,04	0,04	0,04	0,04	0,04	0,04
O.1.1	0,08	0,08	0,08	0,10	0,10	0,10	0,10	0,10	0,10	0,10	0,10	0,10
O.1.2	0,08	0,08	0,08	0,10	0,10	0,10	0,10	0,10	0,10	0,10	0,10	0,10
O.2.1												
O.2.2	0,06	0,06	0,06	0,06	0,07	0,07	0,07	0,07	0,07	0,07	0,07	0,07
O.3.1	0,10	0,10	0,10	0,10	0,11	0,11	0,11	0,11	0,11	0,11	0,11	0,11

 During the drilling operation on through holes a sharp disk will be produced. Safety precautions must be observed. A safety guard has to be provided as protection.

Cutting data standard values for KUB Pentron – 5xD

Index	10 875 ...											
	ABS / C											
	Ø 14–15,5	Ø 16–17,5	Ø 18–19,5	Ø 20–21,5	Ø 22–23,5	Ø 24–25,5	Ø 26–27,5	Ø 28–30	Ø 31–33	Ø 34–37	Ø 38–42	Ø 43–46
	f (mm/rev)											
P.1.1	0,06	0,08	0,07	0,09	0,09	0,09	0,10	0,10	0,10	0,10	0,10	0,10
P.1.2	0,08	0,11	0,11	0,13	0,13	0,13	0,15	0,15	0,15	0,15	0,15	0,15
P.1.3	0,06	0,10	0,10	0,11	0,11	0,11	0,11	0,11	0,11	0,11	0,11	0,11
P.1.4	0,05	0,09	0,09	0,10	0,10	0,10	0,10	0,10	0,10	0,10	0,10	0,10
P.1.5	0,07	0,10	0,10	0,12	0,12	0,12	0,14	0,14	0,14	0,14	0,14	0,14
P.2.1	0,06	0,10	0,10	0,11	0,11	0,11	0,11	0,11	0,11	0,11	0,11	0,11
P.2.2	0,05	0,09	0,09	0,10	0,10	0,10	0,10	0,10	0,10	0,10	0,10	0,10
P.2.3	0,08	0,09	0,10	0,15	0,18	0,18	0,15	0,15	0,15	0,15	0,15	0,15
P.2.4	0,06	0,07	0,08	0,12	0,14	0,14	0,12	0,12	0,12	0,12	0,12	0,12
P.3.1	0,08	0,12	0,12	0,16	0,15	0,18	0,18	0,18	0,18	0,18	0,18	0,18
P.3.2	0,06	0,10	0,10	0,13	0,12	0,14	0,14	0,14	0,14	0,14	0,14	0,14
P.3.3	0,06	0,08	0,08	0,11	0,11	0,13	0,13	0,13	0,13	0,13	0,13	0,13
P.4.1	0,09	0,13	0,13	0,18	0,17	0,20	0,20	0,20	0,20	0,20	0,20	0,20
P.4.2	0,06	0,10	0,10	0,13	0,12	0,14	0,14	0,14	0,14	0,14	0,14	0,14
M.1.1	0,08	0,08	0,08	0,11	0,11	0,14	0,11	0,11	0,11	0,11	0,11	0,11
M.2.1	0,08	0,08	0,08	0,09	0,09	0,12	0,12	0,12	0,12	0,12	0,12	0,12
M.3.1	0,07	0,07	0,07	0,08	0,08	0,11	0,11	0,11	0,11	0,11	0,11	0,11
K.1.1	0,10	0,13	0,13	0,16	0,16	0,20	0,23	0,23	0,23	0,23	0,23	0,23
K.1.2	0,08	0,10	0,10	0,12	0,12	0,15	0,17	0,17	0,17	0,17	0,17	0,17
K.2.1	0,10	0,13	0,13	0,16	0,16	0,20	0,23	0,23	0,23	0,23	0,23	0,23
K.2.2	0,08	0,10	0,10	0,13	0,13	0,16	0,18	0,18	0,18	0,18	0,18	0,18
K.3.1	0,10	0,13	0,13	0,16	0,16	0,20	0,23	0,23	0,23	0,23	0,23	0,23
K.3.2	0,08	0,10	0,10	0,13	0,13	0,16	0,18	0,18	0,18	0,18	0,18	0,18
N.1.1	0,10	0,11	0,11	0,13	0,13	0,13	0,13	0,13	0,13	0,13	0,13	0,13
N.1.2	0,10	0,11	0,11	0,13	0,13	0,13	0,13	0,13	0,13	0,13	0,13	0,13
N.2.1	0,10	0,13	0,13	0,13	0,15	0,15	0,15	0,15	0,15	0,15	0,15	0,15
N.2.2	0,10	0,13	0,13	0,13	0,15	0,15	0,15	0,15	0,15	0,15	0,15	0,15
N.2.3	0,09	0,12	0,12	0,12	0,14	0,14	0,14	0,14	0,14	0,14	0,14	0,14
N.3.1	0,10	0,13	0,13	0,13	0,15	0,15	0,15	0,15	0,15	0,15	0,15	0,15
N.3.2	0,11	0,14	0,14	0,14	0,17	0,17	0,17	0,17	0,17	0,17	0,17	0,17
N.3.3	0,11	0,12	0,12	0,12	0,14	0,14	0,14	0,14	0,14	0,14	0,14	0,14
N.4.1	0,10	0,13	0,13	0,13	0,15	0,15	0,15	0,15	0,15	0,15	0,15	0,15
S.1.1	0,03	0,03	0,03	0,03	0,04	0,06	0,06	0,06	0,06	0,06	0,06	0,06
S.1.2	0,03	0,03	0,03	0,03	0,04	0,04	0,06	0,06	0,06	0,06	0,06	0,06
S.2.1	0,03	0,03	0,03	0,03	0,04	0,06	0,06	0,06	0,06	0,06	0,06	0,06
S.2.2	0,03	0,03	0,03	0,03	0,04	0,04	0,06	0,06	0,06	0,06	0,06	0,06
S.2.3	0,02	0,02	0,02	0,02	0,03	0,03	0,04	0,04	0,04	0,04	0,04	0,04
S.3.1	0,05	0,05	0,05	0,05	0,06	0,08	0,10	0,10	0,10	0,10	0,10	0,10
S.3.2	0,04	0,04	0,04	0,04	0,05	0,07	0,09	0,09	0,09	0,09	0,09	0,09
S.3.3	0,03	0,03	0,03	0,03	0,04	0,04	0,06	0,06	0,06	0,06	0,06	0,06
H.1.1	0,05	0,05	0,05	0,05	0,06	0,06	0,06	0,06	0,06	0,06	0,06	0,06
H.1.2	0,03	0,03	0,03	0,03	0,04	0,04	0,04	0,04	0,04	0,04	0,04	0,04
H.1.3	0,03	0,03	0,03	0,03	0,04	0,04	0,04	0,04	0,04	0,04	0,04	0,04
H.1.4												
H.2.1	0,04	0,04	0,04	0,04	0,05	0,05	0,05	0,05	0,05	0,05	0,05	0,05
H.3.1	0,03	0,03	0,03	0,03	0,04	0,04	0,04	0,04	0,04	0,04	0,04	0,04
O.1.1	0,08	0,08	0,08	0,10	0,10	0,10	0,10	0,10	0,10	0,10	0,10	0,10
O.1.2	0,08	0,08	0,08	0,10	0,10	0,10	0,10	0,10	0,10	0,10	0,10	0,10
O.2.1												
O.2.2	0,06	0,06	0,06	0,06	0,07	0,07	0,07	0,07	0,07	0,07	0,07	0,07
O.3.1	0,10	0,10	0,10	0,10	0,11	0,11	0,11	0,11	0,11	0,11	0,11	0,11

 In order to ensure efficient chip evacuation, coolant pressure must be at least 5 bar. Optimum pressure is > 15 bar.

Cutting data standard values for WOEX indexable inserts

Index	10 821 ...							
	BK8425	BK7935	BK6115	BK7615	BK62	BK77	BK79	BK7710
	v _c (m/min)							
P.1.1	260	250	300				260	
P.1.2	260	220	300				260	
P.1.3	270	270	270				270	
P.1.4	240	240	250				240	
P.1.5	230	200	270				230	
P.2.1	270	270	270				270	
P.2.2	260	260	260				260	
P.2.3	180	160	240				180	
P.2.4	150	130	190				150	
P.3.1	160	140	200				160	
P.3.2	130	110	160				130	
P.3.3	120	100	140				120	
P.4.1	180	160	220				180	
P.4.2	130	110	160				130	
M.1.1	150	160	220				150	
M.2.1	150	160	220				150	
M.3.1	130	150	200				130	
K.1.1	160	150	240	260	240		160	
K.1.2	120	110	140	160	140		120	
K.2.1	160	150	160	180	160		160	
K.2.2	100	90	100	120	100		100	
K.3.1	120	110	120	140	120		120	
K.3.2	100	90	100	120	100		100	
N.1.1	400	400					400	600
N.1.2	400	400					400	500
N.2.1	250	250					250	400
N.2.2	250	250					250	300
N.2.3	230	230					230	250
N.3.1	200	200					200	400
N.3.2	220	220					220	300
N.3.3	330	330					330	300
N.4.1	200	200					200	300
S.1.1	60	50				50		60
S.1.2	50	40				40		60
S.2.1	60	50				50		60
S.2.2	50	40				40		60
S.2.3	30	30				30		60
S.3.1	100	70				70		80
S.3.2	80	60				60		80
S.3.3	50	40				40		80
H.1.1	100		100		100	40		80
H.1.2	80		80		80	30		40
H.1.3	50		50		50	20		40
H.1.4								40
H.2.1	100		100		100	40		80
H.3.1	80		80		80	30		80
O.1.1						100		100
O.1.2						100		100
O.2.1								
O.2.2						100		100
O.3.1						100		100

 BK6115 -01 / BK8425 -03 are exclusively recommended for use on the peripheral cutting edge!

 During the drilling operation on through holes a sharp disk will be produced. Safety precautions must be observed. A safety guard has to be provided as protection.

Cutting data standard values for KUB Trigon – 2xD

Index	10 892 ...												
	ABS / K												
	Ø 14–16	Ø 17–19	Ø 20–24	Ø 25–29	Ø 30–36	Ø 37–40	Ø 41–44	Ø 45–46	Ø 46–52	Ø 53–65	Ø 64–69	Ø 70–75	Ø 76–82
	f (mm/rev)												
P.1.1	0,08	0,10	0,10	0,12	0,12	0,12	0,12	0,12	0,12	0,12	0,12	0,12	0,12
P.1.2	0,08	0,10	0,12	0,14	0,16	0,16	0,18	0,20	0,20	0,25	0,25	0,25	0,25
P.1.3	0,06	0,08	0,12	0,14	0,14	0,14	0,16	0,14	0,18	0,20	0,25	0,25	0,25
P.1.4	0,05	0,07	0,11	0,13	0,13	0,13	0,14	0,12	0,16	0,18	0,22	0,22	0,22
P.1.5	0,07	0,09	0,11	0,13	0,14	0,14	0,16	0,18	0,20	0,22	0,22	0,22	0,22
P.2.1	0,06	0,08	0,12	0,14	0,14	0,14	0,16	0,14	0,18	0,20	0,25	0,25	0,25
P.2.2	0,06	0,08	0,11	0,13	0,13	0,13	0,15	0,12	0,16	0,18	0,22	0,22	0,22
P.2.3	0,06	0,08	0,10	0,14	0,16	0,16	0,16	0,16	0,16	0,18	0,20	0,20	0,20
P.2.4	0,05	0,06	0,08	0,11	0,13	0,13	0,13	0,14	0,14	0,16	0,18	0,18	0,18
P.3.1	0,06	0,08	0,10	0,12	0,12	0,12	0,14	0,14	0,16	0,16	0,16	0,16	0,16
P.3.2	0,05	0,06	0,08	0,10	0,10	0,10	0,11	0,12	0,14	0,14	0,14	0,14	0,14
P.3.3	0,04	0,06	0,07	0,08	0,08	0,08	0,10	0,11	0,13	0,13	0,13	0,13	0,13
P.4.1	0,07	0,09	0,11	0,13	0,13	0,13	0,15	0,15	0,17	0,17	0,17	0,17	0,17
P.4.2	0,05	0,06	0,08	0,10	0,10	0,10	0,11	0,12	0,14	0,14	0,14	0,14	0,14
M.1.1	0,06	0,06	0,08	0,12	0,12	0,12	0,14	0,14	0,14	0,16	0,16	0,16	0,16
M.2.1	0,06	0,06	0,08	0,12	0,12	0,12	0,12	0,12	0,12	0,16	0,16	0,16	0,16
M.3.1	0,05	0,05	0,07	0,11	0,11	0,11	0,11	0,11	0,11	0,15	0,15	0,15	0,15
K.1.1	0,10	0,12	0,14	0,20	0,20	0,20	0,25	0,25	0,25	0,30	0,30	0,30	0,30
K.1.2	0,08	0,08	0,10	0,14	0,14	0,16	0,18	0,18	0,18	0,20	0,25	0,25	0,25
K.2.1	0,08	0,10	0,14	0,20	0,20	0,20	0,25	0,25	0,25	0,30	0,30	0,30	0,30
K.2.2	0,08	0,10	0,13	0,20	0,13	0,13	0,14	0,22	0,22	0,25	0,25	0,25	0,25
K.3.1	0,10	0,12	0,16	0,25	0,16	0,16	0,18	0,25	0,25	0,30	0,30	0,30	0,30
K.3.2	0,08	0,10	0,13	0,20	0,13	0,13	0,14	0,22	0,22	0,25	0,25	0,25	0,25
N.1.1	0,05	0,08	0,08	0,10	0,10	0,12	0,12	0,12	0,12	0,14	0,14	0,14	0,14
N.1.2	0,05	0,08	0,08	0,10	0,10	0,12	0,12	0,12	0,12	0,14	0,14	0,14	0,14
N.2.1	0,10	0,12	0,14	0,18	0,18	0,20	0,20	0,18	0,20	0,20	0,20	0,20	0,20
N.2.2	0,10	0,12	0,14	0,18	0,18	0,20	0,20	0,18	0,20	0,20	0,20	0,20	0,20
N.2.3	0,09	0,11	0,13	0,16	0,16	0,18	0,18	0,16	0,18	0,18	0,18	0,18	0,18
N.3.1	0,05	0,08	0,12	0,16	0,16	0,18	0,20	0,20	0,20	0,25	0,25	0,25	0,25
N.3.2	0,06	0,09	0,13	0,18	0,18	0,20	0,22	0,22	0,22	0,26	0,26	0,26	0,26
N.3.3	0,05	0,08	0,08	0,10	0,10	0,10	0,12	0,12	0,12	0,16	0,16	0,16	0,16
N.4.1	0,05	0,08	0,12	0,16	0,16	0,18	0,20	0,20	0,20	0,25	0,25	0,25	0,25
S.1.1	0,04	0,06	0,08	0,10	0,10	0,10	0,10	0,10	0,10	0,12	0,12	0,12	0,12
S.1.2	0,03	0,05	0,06	0,08	0,08	0,08	0,08	0,08	0,08	0,10	0,10	0,10	0,10
S.2.1	0,04	0,06	0,08	0,10	0,10	0,10	0,10	0,10	0,10	0,12	0,12	0,12	0,12
S.2.2	0,03	0,05	0,06	0,08	0,08	0,08	0,08	0,08	0,08	0,10	0,10	0,10	0,10
S.2.3	0,02	0,03	0,04	0,05	0,05	0,05	0,05	0,06	0,06	0,06	0,06	0,06	0,06
S.3.1	0,07	0,09	0,11	0,13	0,11	0,13	0,13	0,10	0,10	0,12	0,12	0,14	0,14
S.3.2	0,06	0,08	0,10	0,12	0,10	0,12	0,12	0,10	0,10	0,12	0,12	0,14	0,14
S.3.3	0,04	0,05	0,06	0,07	0,06	0,07	0,07	0,06	0,06	0,08	0,08	0,08	0,08
H.1.1	0,06	0,06	0,06	0,06	0,06	0,06	0,06	0,08	0,08	0,08	0,08	0,08	0,08
H.1.2	0,04	0,04	0,04	0,04	0,04	0,04	0,04	0,06	0,06	0,06	0,06	0,08	0,08
H.1.3	0,04	0,04	0,04	0,04	0,04	0,04	0,04						
H.1.4													
H.2.1	0,05	0,05	0,05	0,05	0,05	0,05	0,05	0,05	0,05	0,05	0,05	0,05	0,05
H.3.1	0,04	0,04	0,04	0,04	0,04	0,04	0,04	0,04	0,04	0,04	0,04	0,04	0,04
O.1.1	0,08	0,08	0,10	0,10	0,10	0,10	0,10	0,10	0,10	0,10	0,10	0,10	0,10
O.1.2	0,08	0,08	0,10	0,10	0,10	0,10	0,10	0,10	0,10	0,10	0,10	0,10	0,10
O.2.1													
O.2.2	0,06	0,06	0,06	0,07	0,07	0,07	0,07	0,07	0,07	0,07	0,07	0,07	0,07
O.3.1	0,10	0,10	0,10	0,11	0,11	0,11	0,11	0,11	0,11	0,11	0,11	0,11	0,11

 In order to ensure efficient chip evacuation, coolant pressure must be at least 5 bar. Optimum pressure is > 15 bar.

Cutting data standard values for KUB Trigon – 3xD

Index	10 893 ...												
	ABS / K												
	Ø 14-16	Ø 17-19	Ø 20-24	Ø 25-29	Ø 30-36	Ø 37-40	Ø 41-44	Ø 45-46	Ø 46-52	Ø 53-65	Ø 64-69	Ø 70-75	Ø 76-82
	f (mm/rev)												
P.1.1	0,08	0,10	0,10	0,12	0,12	0,12	0,12	0,12	0,12	0,12	0,12	0,12	0,12
P.1.2	0,08	0,10	0,12	0,14	0,16	0,16	0,20	0,20	0,20	0,25	0,25	0,25	0,25
P.1.3	0,06	0,08	0,12	0,14	0,14	0,14	0,16	0,14	0,18	0,20	0,25	0,25	0,25
P.1.4	0,05	0,07	0,11	0,13	0,13	0,13	0,14	0,12	0,16	0,18	0,22	0,22	0,22
P.1.5	0,07	0,09	0,11	0,13	0,14	0,14	0,18	0,18	0,20	0,22	0,22	0,22	0,22
P.2.1	0,06	0,08	0,12	0,14	0,14	0,14	0,16	0,14	0,18	0,20	0,25	0,25	0,25
P.2.2	0,06	0,08	0,11	0,13	0,13	0,13	0,15	0,12	0,16	0,18	0,22	0,22	0,22
P.2.3	0,06	0,08	0,10	0,14	0,16	0,16	0,16	0,16	0,16	0,18	0,20	0,20	0,20
P.2.4	0,05	0,06	0,08	0,11	0,13	0,13	0,13	0,14	0,14	0,16	0,18	0,18	0,18
P.3.1	0,06	0,08	0,10	0,12	0,12	0,12	0,14	0,14	0,16	0,16	0,16	0,16	0,16
P.3.2	0,05	0,06	0,08	0,10	0,10	0,10	0,11	0,12	0,14	0,14	0,14	0,14	0,14
P.3.3	0,04	0,06	0,07	0,08	0,08	0,08	0,10	0,11	0,13	0,13	0,13	0,13	0,13
P.4.1	0,07	0,09	0,11	0,13	0,13	0,13	0,15	0,15	0,17	0,17	0,17	0,17	0,17
P.4.2	0,05	0,06	0,08	0,10	0,10	0,10	0,11	0,12	0,14	0,14	0,14	0,14	0,14
M.1.1	0,06	0,06	0,08	0,12	0,12	0,12	0,14	0,14	0,14	0,16	0,16	0,16	0,16
M.2.1	0,06	0,06	0,08	0,12	0,12	0,12	0,12	0,12	0,12	0,16	0,16	0,16	0,16
M.3.1	0,05	0,05	0,07	0,11	0,11	0,11	0,11	0,11	0,11	0,15	0,15	0,15	0,15
K.1.1	0,10	0,12	0,14	0,20	0,20	0,20	0,25	0,25	0,25	0,30	0,30	0,30	0,30
K.1.2	0,08	0,08	0,10	0,14	0,14	0,16	0,18	0,18	0,18	0,20	0,25	0,25	0,25
K.2.1	0,08	0,10	0,14	0,20	0,20	0,20	0,25	0,25	0,25	0,30	0,30	0,30	0,30
K.2.2	0,08	0,10	0,13	0,20	0,20	0,20	0,20	0,22	0,22	0,25	0,25	0,25	0,25
K.3.1	0,10	0,12	0,16	0,25	0,25	0,25	0,25	0,25	0,25	0,30	0,30	0,30	0,30
K.3.2	0,08	0,10	0,13	0,20	0,20	0,20	0,20	0,22	0,22	0,25	0,25	0,25	0,25
N.1.1	0,05	0,08	0,08	0,10	0,10	0,12	0,12	0,12	0,12	0,14	0,14	0,14	0,14
N.1.2	0,05	0,08	0,08	0,10	0,10	0,12	0,12	0,12	0,12	0,14	0,14	0,14	0,14
N.2.1	0,10	0,12	0,14	0,18	0,18	0,20	0,20	0,18	0,20	0,20	0,20	0,20	0,20
N.2.2	0,10	0,12	0,14	0,18	0,18	0,20	0,20	0,18	0,20	0,20	0,20	0,20	0,20
N.2.3	0,09	0,11	0,13	0,16	0,16	0,18	0,18	0,16	0,18	0,18	0,18	0,18	0,18
N.3.1	0,05	0,08	0,12	0,16	0,16	0,18	0,20	0,20	0,20	0,25	0,25	0,25	0,25
N.3.2	0,06	0,09	0,13	0,18	0,18	0,20	0,22	0,22	0,22	0,26	0,26	0,26	0,26
N.3.3	0,06	0,09	0,09	0,11	0,11	0,11	0,13	0,122	0,12	0,16	0,16	0,16	0,16
N.4.1	0,05	0,08	0,12	0,16	0,16	0,18	0,20	0,20	0,20	0,25	0,25	0,25	0,25
S.1.1	0,04	0,06	0,08	0,10	0,10	0,10	0,10	0,10	0,10	0,12	0,12	0,12	0,12
S.1.2	0,03	0,05	0,06	0,08	0,08	0,08	0,08	0,08	0,08	0,10	0,10	0,10	0,10
S.2.1	0,04	0,06	0,08	0,10	0,10	0,10	0,10	0,10	0,10	0,12	0,12	0,12	0,12
S.2.2	0,03	0,05	0,06	0,08	0,08	0,08	0,08	0,08	0,08	0,10	0,10	0,10	0,10
S.2.3	0,02	0,03	0,04	0,05	0,05	0,05	0,05	0,06	0,06	0,06	0,06	0,06	0,06
S.3.1	0,07	0,09	0,11	0,13	0,11	0,13	0,13	0,10	0,10	0,12	0,12	0,14	0,14
S.3.2	0,06	0,08	0,10	0,12	0,10	0,12	0,12	0,10	0,10	0,12	0,12	0,14	0,14
S.3.3	0,04	0,05	0,06	0,07	0,06	0,07	0,07	0,06	0,06	0,08	0,08	0,08	0,08
H.1.1	0,05	0,08	0,08	0,10	0,10	0,10	0,10	0,08	0,08	0,08	0,08	0,08	0,08
H.1.2	0,04	0,06	0,06	0,08	0,08	0,08	0,08	0,06	0,06	0,06	0,06	0,08	0,08
H.1.3	0,03	0,04	0,04	0,05	0,05	0,05	0,05						
H.1.4													
H.2.1	0,05	0,08	0,08	0,10	0,10	0,10	0,10	0,05	0,05	0,05	0,05	0,05	0,05
H.3.1	0,04	0,06	0,06	0,08	0,08	0,08	0,08	0,04	0,04	0,04	0,04	0,04	0,04
O.1.1	0,08	0,08	0,10	0,10	0,10	0,10	0,10	0,10	0,10	0,10	0,10	0,10	0,10
O.1.2	0,08	0,08	0,10	0,10	0,10	0,10	0,10	0,10	0,10	0,10	0,10	0,10	0,10
O.2.1													
O.2.2	0,06	0,06	0,06	0,07	0,07	0,07	0,07	0,07	0,07	0,07	0,07	0,07	0,07
O.3.1	0,10	0,10	0,10	0,11	0,11	0,11	0,11	0,11	0,11	0,11	0,11	0,11	0,11

 During the drilling operation on through holes a sharp disk will be produced. Safety precautions must be observed. A safety guard has to be provided as protection.

Cutting data standard values for KUB Trigon – 4xD

Index	10 894 ...					10 894 ...						
	K					ABS						
	Ø 14–16	Ø 17–19	Ø 20–24	Ø 25–29	Ø 30–35	Ø 14–16	Ø 17–19	Ø 20–24	Ø 25–29	Ø 30–36	Ø 37–40	Ø 41–44
	f (mm/rev)					f (mm/rev)						
P.1.1	0,06	0,08	0,08	0,10	0,11	0,06	0,08	0,08	0,10	0,10	0,10	0,10
P.1.2	0,06	0,08	0,10	0,12	0,14	0,06	0,08	0,10	0,12	0,14	0,14	0,18
P.1.3	0,04	0,06	0,10	0,12	0,12	0,04	0,06	0,10	0,12	0,12	0,12	0,14
P.1.4	0,04	0,05	0,09	0,11	0,11	0,04	0,05	0,09	0,11	0,11	0,11	0,13
P.1.5	0,05	0,07	0,09	0,11	0,13	0,05	0,07	0,09	0,11	0,13	0,13	0,16
P.2.1	0,04	0,06	0,10	0,12	0,12	0,04	0,06	0,10	0,12	0,12	0,12	0,14
P.2.2	0,04	0,06	0,10	0,11	0,11	0,04	0,06	0,10	0,11	0,11	0,11	0,13
P.2.3	0,04	0,06	0,08	0,12	0,14	0,04	0,06	0,08	0,12	0,14	0,14	0,14
P.2.4	0,03	0,05	0,06	0,10	0,11	0,03	0,05	0,06	0,10	0,11	0,11	0,11
P.3.1	0,04	0,06	0,08	0,10	0,11	0,04	0,06	0,08	0,10	0,10	0,10	0,12
P.3.2	0,03	0,05	0,06	0,08	0,09	0,03	0,05	0,06	0,08	0,08	0,08	0,10
P.3.3	0,03	0,04	0,06	0,07	0,08	0,03	0,04	0,06	0,07	0,07	0,07	0,08
P.4.1	0,04	0,07	0,09	0,11	0,12	0,04	0,07	0,09	0,11	0,11	0,11	0,13
P.4.2	0,03	0,05	0,06	0,08	0,09	0,03	0,05	0,06	0,08	0,08	0,08	0,10
M.1.1	0,04	0,04	0,06	0,10	0,11	0,04	0,04	0,06	0,10	0,10	0,10	0,12
M.2.1	0,04	0,04	0,06	0,10	0,11	0,04	0,04	0,06	0,10	0,10	0,10	0,10
M.3.1	0,04	0,04	0,05	0,09	0,10	0,04	0,04	0,05	0,09	0,09	0,09	0,09
K.1.1	0,08	0,10	0,12	0,18	0,19	0,08	0,10	0,12	0,18	0,18	0,18	0,23
K.1.2	0,06	0,06	0,08	0,12	0,12	0,06	0,06	0,08	0,12	0,12	0,14	0,16
K.2.1	0,06	0,08	0,12	0,18	0,19	0,06	0,08	0,12	0,18	0,18	0,18	0,23
K.2.2	0,06	0,08	0,11	0,18	0,19	0,06	0,08	0,11	0,18	0,18	0,18	0,18
K.3.1	0,08	0,10	0,14	0,23	0,24	0,08	0,10	0,14	0,23	0,23	0,23	0,23
K.3.2	0,06	0,08	0,11	0,18	0,19	0,06	0,08	0,11	0,18	0,18	0,18	0,18
N.1.1	0,03	0,06	0,06	0,08	0,09	0,03	0,06	0,06	0,08	0,08	0,10	0,10
N.1.2	0,03	0,06	0,06	0,08	0,09	0,03	0,06	0,06	0,08	0,08	0,10	0,10
N.2.1	0,08	0,10	0,12	0,16	0,17	0,08	0,10	0,12	0,16	0,16	0,18	0,18
N.2.2	0,08	0,10	0,12	0,16	0,17	0,08	0,10	0,12	0,16	0,16	0,18	0,18
N.2.3	0,07	0,09	0,11	0,14	0,15	0,07	0,09	0,11	0,14	0,14	0,16	0,16
N.3.1	0,04	0,06	0,10	0,14	0,15	0,03	0,06	0,10	0,14	0,14	0,16	0,18
N.3.2	0,04	0,07	0,11	0,15	0,17	0,03	0,07	0,11	0,15	0,15	0,18	0,20
N.3.3	0,03	0,07	0,07	0,09	0,10	0,03	0,06	0,06	0,08	0,08	0,08	0,10
N.4.1	0,04	0,06	0,10	0,14	0,15	0,03	0,06	0,10	0,14	0,14	0,16	0,18
S.1.1	0,03	0,05	0,07	0,08	0,09	0,02	0,04	0,06	0,08	0,08	0,08	0,08
S.1.2	0,02	0,04	0,06	0,06	0,07	0,02	0,03	0,05	0,06	0,06	0,06	0,06
S.2.1	0,03	0,05	0,07	0,08	0,09	0,02	0,04	0,06	0,08	0,08	0,08	0,08
S.2.2	0,02	0,04	0,06	0,06	0,07	0,02	0,03	0,05	0,06	0,06	0,06	0,06
S.2.3	0,02	0,03	0,04	0,04	0,05	0,01	0,02	0,03	0,04	0,04	0,04	0,04
S.3.1	0,04	0,07	0,09	0,11	0,11	0,04	0,07	0,09	0,11	0,09	0,11	0,11
S.3.2	0,04	0,06	0,08	0,10	0,10	0,04	0,06	0,08	0,10	0,08	0,10	0,10
S.3.3	0,02	0,04	0,05	0,06	0,06	0,02	0,04	0,05	0,06	0,05	0,06	0,06
H.1.1	0,03	0,06	0,06	0,08	0,08	0,03	0,06	0,06	0,08	0,08	0,08	0,08
H.1.2	0,02	0,05	0,05	0,06	0,06	0,02	0,05	0,05	0,06	0,06	0,06	0,06
H.1.3	0,02	0,03	0,03	0,04	0,04	0,02	0,03	0,03	0,04	0,04	0,04	0,04
H.1.4												
H.2.1	0,03	0,06	0,06	0,08	0,08	0,03	0,06	0,06	0,08	0,08	0,08	0,08
H.3.1	0,02	0,05	0,05	0,06	0,06	0,02	0,05	0,05	0,06	0,06	0,06	0,06
O.1.1	0,08	0,08	0,10	0,10	0,10	0,08	0,08	0,10	0,10	0,10	0,10	0,10
O.1.2	0,08	0,08	0,10	0,10	0,10	0,08	0,08	0,10	0,10	0,10	0,10	0,10
O.2.1												
O.2.2	0,06	0,06	0,06	0,07	0,07	0,06	0,06	0,06	0,07	0,07	0,07	0,07
O.3.1	0,10	0,10	0,10	0,11	0,11	0,10	0,10	0,10	0,11	0,11	0,11	0,11

3

 In order to ensure efficient chip evacuation, coolant pressure must be at least 5 bar. Optimum pressure is > 15 bar.

Cutting data standard values for KUB Centron

Index	Ø 20–25 mm				Ø 26–32 mm				Ø 33–45 mm			
	f (mm/rev)	Centring tip			f (mm/rev)	Centring tip			f (mm/rev)	Centring tip		
		10 863 ... (TiN/TiAlN)	10 862 ... (TiN)	10 862 ... (TiAlN)		10 863 ... (TiN/TiAlN)	10 862 ... (TiN)	10 862 ... (TiAlN)		10 863 ... (TiN/TiAlN)	10 862 ... (TiN)	10 862 ... (TiAlN)
		v _c (m/min)				v _c (m/min)				v _c (m/min)		
P.1.1	0,08	250	160		0,08	250	160		0,10	250	160	
P.1.2	0,12	250	160		0,14	250	160		0,14	250	160	
P.1.3	0,10	200	160		0,12	200	160		0,12	200	160	
P.1.4	0,09	180	160		0,11	180	160		0,11	180	160	
P.1.5	0,11	230	160		0,12	230	160		0,12	230	160	
P.2.1	0,10	200	160		0,12	200	160		0,12	200	160	
P.2.2	0,10	190	150		0,11	190	150		0,11	190	150	
P.2.3	0,12	180	140		0,14	180	140		0,14	180	140	
P.2.4	0,10	150	120		0,12	150	120		0,12	150	120	
P.3.1	0,08	160	120		0,10	160	120		0,10	160	120	
P.3.2	0,06	140	100		0,08	140	100		0,08	140	100	
P.3.3	0,07	130	90		0,07	130	90		0,07	130	90	
P.4.1	0,09	180	130		0,11	180	130		0,11	180	130	
P.4.2	0,06	140	100		0,08	140	100		0,08	140	100	
M.1.1	0,10	160		70	0,12	160		70	0,12	160		70
M.2.1	0,08	120		70	0,10	120		70	0,10	120		70
M.3.1	0,07	110		60	0,08	110		60	0,08	110		60
K.1.1	0,14	200		100	0,16	200		100	0,16	200		100
K.1.2	0,12	160		100	0,14	160		100	0,14	160		100
K.2.1	0,12	160		100	0,14	160		100	0,14	160		100
K.2.2	0,10	100		80	0,12	100		80	0,12	100		80
K.3.1	0,12	120		100	0,14	120		100	0,14	120		100
K.3.2	0,10	100		80	0,12	100		80	0,12	100		80
N.1.1	0,07	350	350		0,07	350	350		0,10	350	350	
N.1.2	0,07	350	350		0,07	350	350		0,10	350	350	
N.2.1	0,10	250	250		0,12	250	250		0,16	250	250	
N.2.2	0,10	250	250		0,12	250	250		0,16	250	250	
N.2.3	0,09	230	230		0,11	230	230		0,15	230	230	
N.3.1	0,14	200	200		0,16	200	200		0,18	200	200	
N.3.2	0,15	220	220		0,18	220	220		0,20	220	220	
N.3.3	0,09	250	250		0,10	250	250		0,14	250	250	
N.4.1	0,14	200	200		0,16	200	200		0,18	200	200	
S.1.1	0,04	50		25	0,05	50		25	0,05	50		25
S.1.2	0,03	40		20	0,04	40		20	0,04	40		20
S.2.1	0,04	50		25	0,05	50		25	0,05	50		25
S.2.2	0,03	40		20	0,04	40		20	0,04	40		20
S.2.3	0,03	30		20	0,04	30		20	0,04	30		20
S.3.1	0,06	80		50	0,07	80		50	0,07	80		50
S.3.2	0,05	80		40	0,06	80		40	0,06	80		40
S.3.3	0,03	50		30	0,04	50		30	0,04	50		30
H.1.1												
H.1.2												
H.1.3												
H.1.4												
H.2.1												
H.3.1												
O.1.1	0,08	100	100		0,10	100	100		0,10	100	100	
O.1.2	0,08	100	100		0,10	100	100		0,10	100	100	
O.2.1												
O.2.2	0,08	50	30		0,10	50	30		0,10	50	30	
O.3.1	0,08	100	100		0,10	100	100		0,10	100	100	

 During the drilling operation on through holes a sharp disk will be produced. Safety precautions must be observed. A safety guard has to be provided as protection.

 The cutting data of the KUB Centron depends on the centring tip and not on the indexable inserts. Please select the cutting data of the centring tip.

Index	Ø 46–54 mm					Ø 55–64 mm					Ø 65–71 mm					Ø 72–81 mm				
	f (mm/rev)	Centring tip			f (mm/rev)	Centring tip			f (mm/rev)	Centring tip			f (mm/rev)	Centring tip						
		10 863 ... (TiN/TiAlN)	10 862 ... (TiN)	10 862 ... (TiAlN)		10 863 ... (TiN/TiAlN)	10 862 ... (TiN)	10 862 ... (TiAlN)		10 862 ... (TiN)	10 862 ... (TiAlN)	10 862 ... (TiN)		10 862 ... (TiAlN)						
		v _c (m/min)				v _c (m/min)				v _c (m/min)				v _c (m/min)						
P.1.1	0,10	250	160		0,10	250	160		0,10	160		0,10	160							
P.1.2	0,14	250	160		0,16	250	160		0,16	160		0,16	160							
P.1.3	0,12	200	160		0,14	200	160		0,14	160		0,14	160							
P.1.4	0,11	180	160		0,12	180	160		0,12	160		0,12	160							
P.1.5	0,12	230	160		0,14	230	160		0,14	160		0,14	160							
P.2.1	0,12	200	160		0,14	200	160		0,14	160		0,14	160							
P.2.2	0,11	190	150		0,12	190	150		0,12	150		0,12	150							
P.2.3	0,14	180	140		0,16	180	140		0,16	140		0,16	140							
P.2.4	0,12	150	120		0,13	150	120		0,13	120		0,13	120							
P.3.1	0,10	160	120		0,12	160	120		0,12	120		0,12	120							
P.3.2	0,08	140	100		0,10	140	100		0,10	100		0,10	100							
P.3.3	0,07	130	90		0,09	130	90		0,09	90		0,09	90							
P.4.1	0,11	180	130		0,14	180	130		0,14	130		0,14	130							
P.4.2	0,08	140	100		0,10	140	100		0,10	100		0,10	100							
M.1.1	0,12	160		70	0,12	160		70	0,12		70	0,12		70						
M.2.1	0,10	120		70	0,10	120		70	0,10		70	0,10		70						
M.3.1	0,08	110		60	0,08	110		60	0,08		60	0,08		60						
K.1.1	0,16	200		100	0,16	200		100	0,16		100	0,16		100						
K.1.2	0,14	160		100	0,14	160		100	0,14		100	0,14		100						
K.2.1	0,14	160		100	0,14	160		100	0,14		100	0,14		100						
K.2.2	0,12	100		80	0,12	100		80	0,12		80	0,12		80						
K.3.1	0,14	120		100	0,14	120		100	0,14		100	0,14		100						
K.3.2	0,12	100		80	0,12	100		80	0,12		80	0,12		80						
N.1.1	0,10	350	350		0,10	350	350		0,10	350		0,10	350							
N.1.2	0,10	350	350		0,10	350	350		0,10	350		0,10	350							
N.2.1	0,16	250	250		0,16	250	250		0,16	250		0,16	250							
N.2.2	0,16	250	250		0,16	250	250		0,16	250		0,16	250							
N.2.3	0,15	230	230		0,15	230	230		0,15	230		0,15	230							
N.3.1	0,18	200	200		0,18	200	200		0,18	200		0,18	200							
N.3.2	0,20	220	220		0,20	220	220		0,20	220		0,20	220							
N.3.3	0,14	250	250		0,14	250	250		0,14	250		0,14	250							
N.4.1	0,18	200	200		0,18	200	200		0,18	200		0,18	200							
S.1.1	0,05	50		25	0,05	50		25	0,05		25	0,05		25						
S.1.2	0,04	40		20	0,04	40		20	0,04		20	0,04		20						
S.2.1	0,05	50		25	0,05	50		25	0,05		25	0,05		25						
S.2.2	0,04	40		20	0,04	40		20	0,04		20	0,04		20						
S.2.3	0,04	30		20	0,04	30		20	0,04		20	0,04		20						
S.3.1	0,07	80		50	0,07	80		50	0,07		50	0,07		50						
S.3.2	0,06	80		40	0,06	80		40	0,06		40	0,06		40						
S.3.3	0,04	50		30	0,04	50		30	0,04		30	0,04		30						
H.1.1																				
H.1.2																				
H.1.3																				
H.1.4																				
H.2.1																				
H.3.1																				
O.1.1	0,10	100	100		0,10	100	100		0,10	100		0,10	100							
O.1.2	0,10	100	100		0,10	100	100		0,10	100		0,10	100							
O.2.1																				
O.2.2	0,10	50	30		0,10	50	30		0,10	30		0,10	30							
O.3.1	0,10	100	100		0,10	100	100		0,10	100		0,10	100							

 In order to ensure efficient chip evacuation, coolant pressure must be at least 5 bar. Optimum pressure is > 15 bar.

Cutting data standard values for MaxiDrill 900 – 2xD

Index	10 830 ...		10 852 ...									
	SONT		C									
	CTCP420	CTPP430	Ø 12–15,5	Ø 16–17,5	Ø 18–20,5	Ø 21–23,5	Ø 24–27,5	Ø 28–32	Ø 32,5–36,5	Ø 37–41	Ø 41,5–46	Ø 46,5–63
	v _c (m/min)		f (mm/rev)									
P.1.1	300	215	0,10	0,10	0,12	0,15	0,15	0,15	0,15	0,18	0,18	0,20
P.1.2	260	190	0,10	0,10	0,12	0,15	0,15	0,15	0,15	0,18	0,18	0,20
P.1.3	230	165	0,10	0,10	0,12	0,15	0,15	0,15	0,15	0,18	0,18	0,20
P.1.4	220	160	0,10	0,10	0,12	0,15	0,15	0,15	0,15	0,18	0,18	0,20
P.1.5	200	150	0,10	0,10	0,12	0,15	0,15	0,15	0,15	0,18	0,18	0,20
P.2.1	270	200	0,10	0,10	0,12	0,15	0,15	0,15	0,15	0,18	0,18	0,20
P.2.2	215	160	0,10	0,10	0,12	0,15	0,15	0,15	0,15	0,18	0,18	0,20
P.2.3	200	140	0,10	0,10	0,12	0,15	0,15	0,15	0,15	0,18	0,18	0,20
P.2.4	160	110	0,10	0,10	0,12	0,15	0,15	0,15	0,15	0,18	0,18	0,20
P.3.1	200	140	0,10	0,10	0,12	0,15	0,15	0,15	0,15	0,18	0,18	0,20
P.3.2	160	100	0,10	0,10	0,12	0,15	0,15	0,15	0,15	0,18	0,18	0,20
P.3.3	120	70	0,10	0,10	0,12	0,15	0,15	0,15	0,15	0,18	0,18	0,20
P.4.1	200	140	0,10	0,10	0,12	0,15	0,15	0,15	0,15	0,18	0,18	0,20
P.4.2	180	120	0,10	0,10	0,12	0,15	0,15	0,15	0,15	0,18	0,18	0,20
M.1.1		140	0,08	0,08	0,09	0,09	0,10	0,10	0,10	0,15	0,15	0,15
M.2.1		100	0,08	0,08	0,09	0,09	0,10	0,10	0,10	0,15	0,15	0,15
M.3.1		130	0,08	0,08	0,09	0,09	0,10	0,10	0,10	0,15	0,15	0,15
K.1.1	250	140	0,12	0,15	0,15	0,18	0,18	0,22	0,25	0,25	0,25	0,25
K.1.2	230	130	0,12	0,15	0,15	0,18	0,18	0,22	0,25	0,25	0,25	0,25
K.2.1	230	140	0,12	0,15	0,15	0,18	0,18	0,22	0,25	0,25	0,25	0,25
K.2.2	210	140	0,12	0,15	0,15	0,18	0,18	0,22	0,25	0,25	0,25	0,25
K.3.1	190	100	0,12	0,15	0,15	0,18	0,18	0,22	0,25	0,25	0,25	0,25
K.3.2	170	100	0,12	0,15	0,15	0,18	0,18	0,22	0,25	0,25	0,25	0,25
N.1.1		300	0,10	0,11	0,11	0,11	0,13	0,13	0,13	0,13	0,13	0,13
N.1.2		315	0,10	0,11	0,11	0,11	0,13	0,13	0,13	0,13	0,13	0,13
N.2.1		270	0,10	0,11	0,11	0,11	0,13	0,13	0,13	0,13	0,13	0,13
N.2.2		140	0,10	0,11	0,11	0,11	0,13	0,13	0,13	0,13	0,13	0,13
N.2.3		180	0,10	0,11	0,11	0,11	0,13	0,13	0,13	0,13	0,13	0,13
N.3.1		200	0,10	0,11	0,11	0,11	0,13	0,13	0,13	0,13	0,13	0,13
N.3.2		200	0,10	0,11	0,11	0,11	0,13	0,13	0,13	0,13	0,13	0,13
N.3.3		200	0,10	0,11	0,11	0,11	0,13	0,13	0,13	0,13	0,13	0,13
N.4.1		200	0,10	0,11	0,11	0,11	0,13	0,13	0,13	0,13	0,13	0,13
S.1.1		65	0,04	0,04	0,04	0,04	0,06	0,06	0,08	0,08	0,08	0,10
S.1.2		50	0,04	0,04	0,04	0,04	0,06	0,06	0,08	0,08	0,08	0,10
S.2.1		45	0,04	0,04	0,04	0,04	0,06	0,06	0,08	0,08	0,08	0,10
S.2.2		40	0,04	0,04	0,04	0,04	0,06	0,06	0,08	0,08	0,08	0,10
S.2.3		40	0,04	0,04	0,04	0,04	0,06	0,06	0,08	0,08	0,08	0,10
S.3.1		65	0,04	0,04	0,04	0,04	0,06	0,06	0,08	0,08	0,08	0,10
S.3.2		50	0,04	0,04	0,04	0,04	0,06	0,06	0,08	0,08	0,08	0,10
S.3.3		40	0,04	0,04	0,04	0,04	0,06	0,06	0,08	0,08	0,08	0,10
H.1.1												
H.1.2												
H.1.3												
H.1.4												
H.2.1												
H.3.1												
O.1.1												
O.1.2												
O.2.1												
O.2.2												
O.3.1												

 During the drilling operation on through holes a sharp disk will be produced. Safety precautions must be observed. A safety guard has to be provided as protection.

 CTCP420 -M30 is exclusively recommended for use on the peripheral cutting edge!

Cutting data standard values for MaxiDrill 900 – 3xD

Index	10 853 ...									
	C									
	Ø 12–15,5	Ø 16–17,5	Ø 18–20,5	Ø 21–23,5	Ø 24–27,5	Ø 28–32	Ø 32,5–36,5	Ø 37–41	Ø 41,5–46	Ø 46,5–63
	f (mm/rev)									
P.1.1	0,10	0,10	0,12	0,15	0,15	0,15	0,15	0,18	0,18	0,20
P.1.2	0,10	0,10	0,12	0,15	0,15	0,15	0,15	0,18	0,18	0,20
P.1.3	0,10	0,10	0,12	0,15	0,15	0,15	0,15	0,18	0,18	0,20
P.1.4	0,10	0,10	0,12	0,15	0,15	0,15	0,15	0,18	0,18	0,20
P.1.5	0,10	0,10	0,12	0,15	0,15	0,15	0,15	0,18	0,18	0,20
P.2.1	0,10	0,10	0,12	0,15	0,15	0,15	0,15	0,18	0,18	0,20
P.2.2	0,10	0,10	0,12	0,15	0,15	0,15	0,15	0,18	0,18	0,20
P.2.3	0,10	0,10	0,12	0,15	0,15	0,15	0,15	0,18	0,18	0,20
P.2.4	0,10	0,10	0,12	0,15	0,15	0,15	0,15	0,18	0,18	0,20
P.3.1	0,10	0,10	0,12	0,15	0,15	0,15	0,15	0,18	0,18	0,20
P.3.2	0,10	0,10	0,12	0,15	0,15	0,15	0,15	0,18	0,18	0,20
P.3.3	0,10	0,10	0,12	0,15	0,15	0,15	0,15	0,18	0,18	0,20
P.4.1	0,10	0,10	0,12	0,15	0,15	0,15	0,15	0,18	0,18	0,20
P.4.2	0,10	0,10	0,12	0,15	0,15	0,15	0,15	0,18	0,18	0,20
M.1.1	0,08	0,08	0,09	0,09	0,10	0,10	0,10	0,15	0,15	0,15
M.2.1	0,08	0,08	0,09	0,09	0,10	0,10	0,10	0,15	0,15	0,15
M.3.1	0,08	0,08	0,09	0,09	0,10	0,10	0,10	0,15	0,15	0,15
K.1.1	0,12	0,15	0,15	0,18	0,18	0,22	0,25	0,25	0,25	0,25
K.1.2	0,12	0,15	0,15	0,18	0,18	0,22	0,25	0,25	0,25	0,25
K.2.1	0,12	0,15	0,15	0,18	0,18	0,22	0,25	0,25	0,25	0,25
K.2.2	0,12	0,15	0,15	0,18	0,18	0,22	0,25	0,25	0,25	0,25
K.3.1	0,12	0,15	0,15	0,18	0,18	0,22	0,25	0,25	0,25	0,25
K.3.2	0,12	0,15	0,15	0,18	0,18	0,22	0,25	0,25	0,25	0,25
N.1.1	0,10	0,11	0,11	0,11	0,13	0,13	0,13	0,13	0,13	0,13
N.1.2	0,10	0,11	0,11	0,11	0,13	0,13	0,13	0,13	0,13	0,13
N.2.1	0,10	0,11	0,11	0,11	0,13	0,13	0,13	0,13	0,13	0,13
N.2.2	0,10	0,11	0,11	0,11	0,13	0,13	0,13	0,13	0,13	0,13
N.2.3	0,10	0,11	0,11	0,11	0,13	0,13	0,13	0,13	0,13	0,13
N.3.1	0,10	0,11	0,11	0,11	0,13	0,13	0,13	0,13	0,13	0,13
N.3.2	0,10	0,11	0,11	0,11	0,13	0,13	0,13	0,13	0,13	0,13
N.3.3	0,10	0,11	0,11	0,11	0,13	0,13	0,13	0,13	0,13	0,13
N.4.1	0,10	0,11	0,11	0,11	0,13	0,13	0,13	0,13	0,13	0,13
S.1.1	0,04	0,04	0,04	0,04	0,06	0,06	0,08	0,08	0,08	0,10
S.1.2	0,04	0,04	0,04	0,04	0,06	0,06	0,08	0,08	0,08	0,10
S.2.1	0,04	0,04	0,04	0,04	0,06	0,06	0,08	0,08	0,08	0,10
S.2.2	0,04	0,04	0,04	0,04	0,06	0,06	0,08	0,08	0,08	0,10
S.2.3	0,04	0,04	0,04	0,04	0,06	0,06	0,08	0,08	0,08	0,10
S.3.1	0,04	0,04	0,04	0,04	0,06	0,06	0,08	0,08	0,08	0,10
S.3.2	0,04	0,04	0,04	0,04	0,06	0,06	0,08	0,08	0,08	0,10
S.3.3	0,04	0,04	0,04	0,04	0,06	0,06	0,08	0,08	0,08	0,10
H.1.1										
H.1.2										
H.1.3										
H.1.4										
H.2.1										
H.3.1										
O.1.1										
O.1.2										
O.2.1										
O.2.2										
O.3.1										

 In order to ensure efficient chip evacuation, coolant pressure must be at least 5 bar. Optimum pressure is > 15 bar.

Cutting data standard values for MaxiDrill 900 – 4xD

Index	10 854 ...									
	C									
	Ø 12–15,5	Ø 16–17,5	Ø 18–20,5	Ø 21–23,5	Ø 24–27,5	Ø 28–32	Ø 32,5–36,5	Ø 37–41	Ø 41,5–46	Ø 46,5–54
	f (mm/rev)									
P.1.1	0,10	0,10	0,12	0,15	0,15	0,15	0,15	0,18	0,18	0,20
P.1.2	0,10	0,10	0,12	0,15	0,15	0,15	0,15	0,18	0,18	0,20
P.1.3	0,10	0,10	0,12	0,15	0,15	0,15	0,15	0,18	0,18	0,20
P.1.4	0,10	0,10	0,12	0,15	0,15	0,15	0,15	0,18	0,18	0,20
P.1.5	0,10	0,10	0,12	0,15	0,15	0,15	0,15	0,18	0,18	0,20
P.2.1	0,10	0,10	0,12	0,15	0,15	0,15	0,15	0,18	0,18	0,20
P.2.2	0,10	0,10	0,12	0,15	0,15	0,15	0,15	0,18	0,18	0,20
P.2.3	0,10	0,10	0,12	0,15	0,15	0,15	0,15	0,18	0,18	0,20
P.2.4	0,10	0,10	0,12	0,15	0,15	0,15	0,15	0,18	0,18	0,20
P.3.1	0,10	0,10	0,12	0,15	0,15	0,15	0,15	0,18	0,18	0,20
P.3.2	0,10	0,10	0,12	0,15	0,15	0,15	0,15	0,18	0,18	0,20
P.3.3	0,10	0,10	0,12	0,15	0,15	0,15	0,15	0,18	0,18	0,20
P.4.1	0,10	0,10	0,12	0,15	0,15	0,15	0,15	0,18	0,18	0,20
P.4.2	0,10	0,10	0,12	0,15	0,15	0,15	0,15	0,18	0,18	0,20
M.1.1	0,08	0,08	0,09	0,09	0,10	0,10	0,10	0,15	0,15	0,15
M.2.1	0,08	0,08	0,09	0,09	0,10	0,10	0,10	0,15	0,15	0,15
M.3.1	0,08	0,08	0,09	0,09	0,10	0,10	0,10	0,15	0,15	0,15
K.1.1	0,12	0,15	0,15	0,18	0,18	0,22	0,25	0,25	0,25	0,25
K.1.2	0,12	0,15	0,15	0,18	0,18	0,22	0,25	0,25	0,25	0,25
K.2.1	0,12	0,15	0,15	0,18	0,18	0,22	0,25	0,25	0,25	0,25
K.2.2	0,12	0,15	0,15	0,18	0,18	0,22	0,25	0,25	0,25	0,25
K.3.1	0,12	0,15	0,15	0,18	0,18	0,22	0,25	0,25	0,25	0,25
K.3.2	0,12	0,15	0,15	0,18	0,18	0,22	0,25	0,25	0,25	0,25
N.1.1	0,10	0,11	0,11	0,11	0,13	0,13	0,13	0,13	0,13	0,13
N.1.2	0,10	0,11	0,11	0,11	0,13	0,13	0,13	0,13	0,13	0,13
N.2.1	0,10	0,11	0,11	0,11	0,13	0,13	0,13	0,13	0,13	0,13
N.2.2	0,10	0,11	0,11	0,11	0,13	0,13	0,13	0,13	0,13	0,13
N.2.3	0,10	0,11	0,11	0,11	0,13	0,13	0,13	0,13	0,13	0,13
N.3.1	0,10	0,11	0,11	0,11	0,13	0,13	0,13	0,13	0,13	0,13
N.3.2	0,10	0,11	0,11	0,11	0,13	0,13	0,13	0,13	0,13	0,13
N.3.3	0,10	0,11	0,11	0,11	0,13	0,13	0,13	0,13	0,13	0,13
N.4.1	0,10	0,11	0,11	0,11	0,13	0,13	0,13	0,13	0,13	0,13
S.1.1	0,04	0,04	0,04	0,04	0,06	0,06	0,08	0,08	0,08	0,10
S.1.2	0,04	0,04	0,04	0,04	0,06	0,06	0,08	0,08	0,08	0,10
S.2.1	0,04	0,04	0,04	0,04	0,06	0,06	0,08	0,08	0,08	0,10
S.2.2	0,04	0,04	0,04	0,04	0,06	0,06	0,08	0,08	0,08	0,10
S.2.3	0,04	0,04	0,04	0,04	0,06	0,06	0,08	0,08	0,08	0,10
S.3.1	0,04	0,04	0,04	0,04	0,06	0,06	0,08	0,08	0,08	0,10
S.3.2	0,04	0,04	0,04	0,04	0,06	0,06	0,08	0,08	0,08	0,10
S.3.3	0,04	0,04	0,04	0,04	0,06	0,06	0,08	0,08	0,08	0,10
H.1.1										
H.1.2										
H.1.3										
H.1.4										
H.2.1										
H.3.1										
O.1.1										
O.1.2										
O.2.1										
O.2.2										
O.3.1										

 During the drilling operation on through holes a sharp disk will be produced. Safety precautions must be observed. A safety guard has to be provided as protection.

Cutting data standard values for MaxiDrill 900 – 5xD

Index	10 855 ...							
	C							
	Ø 12–15,5	Ø 16–17,5	Ø 18–20	Ø 21–23	Ø 24–27	Ø 28–32	Ø 33–36	Ø 37–41
	f (mm/rev)							
P.1.1	0,10	0,10	0,12	0,15	0,15	0,15	0,15	0,18
P.1.2	0,10	0,10	0,12	0,15	0,15	0,15	0,15	0,18
P.1.3	0,10	0,10	0,12	0,15	0,15	0,15	0,15	0,18
P.1.4	0,10	0,10	0,12	0,15	0,15	0,15	0,15	0,18
P.1.5	0,10	0,10	0,12	0,15	0,15	0,15	0,15	0,18
P.2.1	0,10	0,10	0,12	0,15	0,15	0,15	0,15	0,18
P.2.2	0,10	0,10	0,12	0,15	0,15	0,15	0,15	0,18
P.2.3	0,10	0,10	0,12	0,15	0,15	0,15	0,15	0,18
P.2.4	0,10	0,10	0,12	0,15	0,15	0,15	0,15	0,18
P.3.1	0,10	0,10	0,12	0,15	0,15	0,15	0,15	0,18
P.3.2	0,10	0,10	0,12	0,15	0,15	0,15	0,15	0,18
P.3.3	0,10	0,10	0,12	0,15	0,15	0,15	0,15	0,18
P.4.1	0,10	0,10	0,12	0,15	0,15	0,15	0,15	0,18
P.4.2	0,10	0,10	0,12	0,15	0,15	0,15	0,15	0,18
M.1.1	0,08	0,08	0,09	0,09	0,10	0,10	0,10	0,15
M.2.1	0,08	0,08	0,09	0,09	0,10	0,10	0,10	0,15
M.3.1	0,08	0,08	0,09	0,09	0,10	0,10	0,10	0,15
K.1.1	0,12	0,15	0,15	0,18	0,18	0,22	0,25	0,25
K.1.2	0,12	0,15	0,15	0,18	0,18	0,22	0,25	0,25
K.2.1	0,12	0,15	0,15	0,18	0,18	0,22	0,25	0,25
K.2.2	0,12	0,15	0,15	0,18	0,18	0,22	0,25	0,25
K.3.1	0,12	0,15	0,15	0,18	0,18	0,22	0,25	0,25
K.3.2	0,12	0,15	0,15	0,18	0,18	0,22	0,25	0,25
N.1.1	0,10	0,11	0,11	0,11	0,13	0,13	0,13	0,13
N.1.2	0,10	0,11	0,11	0,11	0,13	0,13	0,13	0,13
N.2.1	0,10	0,11	0,11	0,11	0,13	0,13	0,13	0,13
N.2.2	0,10	0,11	0,11	0,11	0,13	0,13	0,13	0,13
N.2.3	0,10	0,11	0,11	0,11	0,13	0,13	0,13	0,13
N.3.1	0,10	0,11	0,11	0,11	0,13	0,13	0,13	0,13
N.3.2	0,10	0,11	0,11	0,11	0,13	0,13	0,13	0,13
N.3.3	0,10	0,11	0,11	0,11	0,13	0,13	0,13	0,13
N.4.1	0,10	0,11	0,11	0,11	0,13	0,13	0,13	0,13
S.1.1	0,04	0,04	0,04	0,04	0,06	0,06	0,08	0,08
S.1.2	0,04	0,04	0,04	0,04	0,06	0,06	0,08	0,08
S.2.1	0,04	0,04	0,04	0,04	0,06	0,06	0,08	0,08
S.2.2	0,04	0,04	0,04	0,04	0,06	0,06	0,08	0,08
S.2.3	0,04	0,04	0,04	0,04	0,06	0,06	0,08	0,08
S.3.1	0,04	0,04	0,04	0,04	0,06	0,06	0,08	0,08
S.3.2	0,04	0,04	0,04	0,04	0,06	0,06	0,08	0,08
S.3.3	0,04	0,04	0,04	0,04	0,06	0,06	0,08	0,08
H.1.1								
H.1.2								
H.1.3								
H.1.4								
H.2.1								
H.3.1								
O.1.1								
O.1.2								
O.2.1								
O.2.2								
O.3.1								

 In order to ensure efficient chip evacuation, coolant pressure must be at least 5 bar. Optimum pressure is > 15 bar.

Maximum adjustment range (X) during solid drilling / from the centre for stationary applications – KUB Pentron

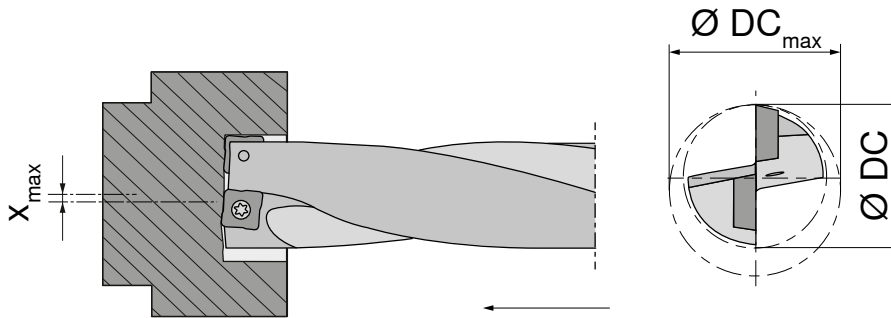

At max. offset X_{max} the hole will be:
 $D_{max} = D + 2X_{max}$
 e.g. for $D = 20 \text{ mm}$, $X_{max} = 0.20 \text{ mm}$:
 $D_{max} = D + 0.4 = 20.4 \text{ mm}$

Ø DC mm	Insert size	X_{max} mm	Ø DC _{max} mm
14,0	SOGX 04....	0,25	14,5
14,5		0,25	15,0
15,0		0,25	15,5
15,5		0,25	16,0
16,0		0,25	16,5
16,5	SOGX 05....	0,25	17,0
17,0		0,25	17,5
17,5		0,25	18,0
18,0		0,25	18,5
18,5		0,25	19,0
19,0	SOGX 06....	0,25	19,5
19,5		0,25	20,0
20,0		0,25	20,5
20,5		0,25	21,0
21,0		0,25	21,5
21,5	SOGX 07....	0,25	22,0
22,0		0,25	22,5
22,5		0,25	23,0
23,0		0,25	23,5
23,5		0,25	24,0
24,0	SOGX 08....	0,25	24,5
24,5		0,25	25,0
25,0		0,25	25,5
25,5		0,25	26,0
26,0		0,25	26,5
26,5	SOGX 09....	0,25	27,0
27,0		0,25	27,5
27,5		0,25	28,0
28,0		0,25	28,5
28,5		0,25	29,0
29,0	SOGX 10....	0,25	29,5
29,5		0,25	30,0
30,0		0,25	30,5
31,0		0,25	31,5
32,0		0,25	32,5
33,0	SOGX 11....	0,25	33,5
34,0		0,25	34,5
35,0		0,25	35,5
36,0		0,25	36,5
37,0		0,25	37,5
38,0	SOGX 12....	0,25	38,5
39,0		0,25	39,5
40,0		0,25	40,5
41,0		0,25	41,5
42,0		0,25	42,5
43,0	SOGX 13....	0,25	43,5
44,0		0,25	44,5
45,0		0,25	45,5
46,0		0,25	46,5
47,0		0,25	47,5
48,0	SOGX 08....	0,25	48,5
49,0		0,25	49,5
50,0		0,25	50,5
51,0		0,25	51,5
52,0		0,25	52,5

Ø DC mm	Insert size	X_{max} mm	Ø DC _{max} mm
53,0	SOGX 10....	0,25	53,5
54,0		0,25	54,5
55,0		0,25	55,5
56,0		0,25	56,5
57,0		0,25	57,5
58,0		0,25	58,5
59,0		0,25	59,5
60,0		0,25	60,5
61,0		0,25	61,5
62,0		0,25	62,5
63,0		0,25	63,5
64,0		0,25	64,5
65,0		0,25	65,5

KUB Pentron CS

Ø DC mm	Insert size	X_{max} mm	Ø DC _{max} mm
64,0	SOGX 10....	0,25	47,5
65,0		0,25	48,5
66,0		0,25	49,5
67,0		0,25	50,5
68,0		0,25	51,5
69,0	SOGX 11....	0,25	52,5
70,0		0,25	53,5
71,0		0,25	54,5
72,0		0,25	55,5
73,0		0,25	56,5
74,0	SOGX 12....	0,25	57,5
75,0		0,25	58,5
76,0		0,25	59,5
77,0		0,25	60,5
78,0		0,25	61,5
79,0	SOGX 13....	0,25	62,5
80,0		0,25	63,5
81,0		0,25	64,5
82,0		0,25	65,5
83,0		0,25	66,5
84,0	SOGX 13....	0,25	67,5
85,0		0,25	68,5
86,0		0,25	69,5
87,0		0,25	70,5
88,0		0,25	71,5
89,0	SOGX 13....	0,25	72,5
90,0		0,25	73,5
91,0		0,25	74,5
92,0		0,25	75,5
93,0		0,25	76,5
94,0	SOGX 13....	0,25	77,5
95,0		0,25	78,5
96,0		0,25	79,5

The maximum radial X-offset affects the cutting force balance of the drill, therefore, the use of lower feed rates is recommended!

Maximum adjustment range (X) during solid drilling / from the centre for stationary applications – KUB Trigon

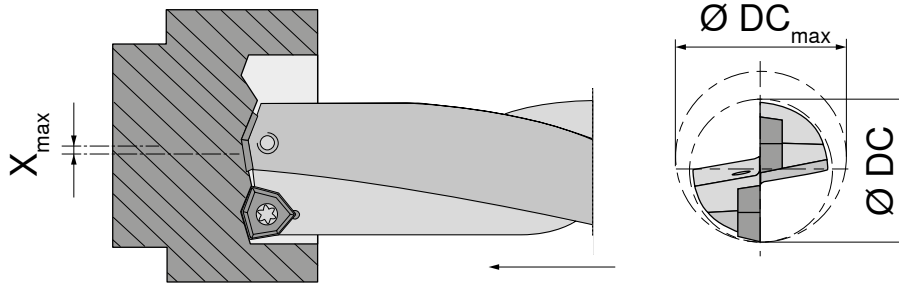

At max. offset X_{max} the hole will be:
 $D_{max} = D + 2X_{max}$
 e.g. for $D = 20 \text{ mm}$, $X_{max} = 0.20 \text{ mm}$:
 $D_{max} = D + 0.4 = 20.4 \text{ mm}$

Ø DC mm	Insert size	X_{max} mm	Ø DC _{max} mm	Ø DC mm	Insert size	X_{max} mm	Ø DC _{max} mm
14,0	WOEX 03....	0,5	15,0	45,0	WOEX 08....	1,5	48,0
15,0		0,5	16,0	46,0		1,5	49,0
16,0		0,5	17,0	47,0		1,5	50,0
17,0		0,5	18,0	48,0		1,5	51,0
18,0		0,5	19,0	49,0		1,5	52,0
19,0		0,5	20,0	50,0		1,5	53,0
20,0	WOEX 04....	0,5	21,0	51,0	1,5	54,0	
21,0		0,5	22,0	52,0	1,5	55,0	
22,0		0,5	23,0	53,0	1,0	55,0	
23,0		0,5	24,0	54,0	0,5	55,0	
24,0		0,5	25,0	55,0	1,5	58,0	
25,0		0,5	26,0	56,0	1,5	59,0	
26,0	WOEX 05....	1,0	28,0	57,0	1,5	60,0	
27,0		1,5	30,0	58,0	1,5	61,0	
28,0		1,5	31,0	59,0	1,5	62,0	
29,0		1,5	32,0	60,0	1,5	63,0	
30,0		1,25	32,5	61,0	1,5	64,0	
31,0		1,25	33,5	62,0	1,5	65,0	
32,0	1,0	34,0	63,0	1,5	66,0		
33,0	WOEX 06....	0,5	34,0	64,0	1,5	67,0	
34,0		0,5	35,0	65,0	1,5	68,0	
35,0		0,5	36,0	66,0	1,5	69,0	
36,0		0,5	37,0	67,0	1,25	69,5	
37,0		1,5	40,0	68,0	1,0	70,0	
38,0		1,5	41,0	69,0	1,5	72,0	
39,0	1,5	42,0	70,0	1,5	73,0		
40,0	1,5	43,0	71,0	1,5	74,0		
41,0	1,5	44,0	72,0	1,5	75,0		
42,0	1,5	45,0	73,0	1,5	76,0		
43,0	1,0	45,0	74,0	1,5	77,0		
44,0	0,5	45,0	75,0	1,5	78,0		
			76,0	WOEX 12....	1,5	79,0	
			77,0		1,5	80,0	
			78,0		1,5	81,0	
			79,0		1,5	82,0	
			80,0		1,0	82,0	
			81,0		0,75	82,5	
			82,0	0,5	83,0		

The maximum radial X-offset affects the cutting force balance of the drill, therefore, the use of lower feed rates is recommended!

Maximum off set (X) for drilling into full material / with stationary applications – MaxiDrill 900

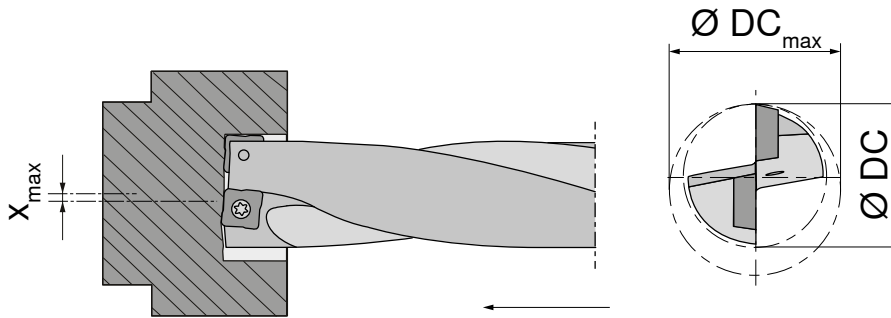

At max. offset X_{max} the hole will be:
 $D_{max} = D + 2X_{max}$
 e.g. for $D = 20$ mm, $X_{max} = 0.20$ mm:
 $D_{max} = D + 0.4 = 20.4$ mm

Ø DC mm	Insert size	X_{max} mm	Ø DC _{max} mm
12,0	SONT 03....	0,50	13,0
12,5		0,40	13,3
13,0		0,35	13,7
13,5		0,30	14,1
14,0	SONT 04....	0,35	14,7
14,5		0,25	15,0
15,0		0,20	15,4
15,5		0,15	15,8
16,0	SONT 05....	0,40	16,8
16,5		0,35	17,2
17,0		0,30	17,6
17,5		0,25	18,0
18,0	SONT 06....	0,50	19,0
18,5		0,40	19,3
19,0		0,35	19,7
19,5		0,25	20,0
20,0	SONT 07....	0,20	20,4
20,5		0,15	20,8
21,0		0,35	21,7
21,5		0,30	22,1
22,0	SONT 08....	0,25	22,5
22,5		0,15	22,8
23,0		0,15	23,3
23,5		0,10	23,7
24,0	SONT 09....	0,65	25,3
24,5		0,55	25,6
25,0		0,55	26,1
25,5		0,40	26,3
26,0	SONT 10....	0,35	26,7
26,5		0,30	27,1
27,0		0,25	27,5
27,5		0,15	27,8
28,0	SONT 11....	0,90	29,8
28,5		0,80	30,1
29,0		0,75	30,5
29,5		0,70	30,9
30,0	SONT 12....	0,60	31,2
30,5		0,55	31,6
31,0		0,45	31,9
31,5		0,40	32,3
32,0	SONT 13....	0,30	32,6

Ø DC mm	Insert size	X_{max} mm	Ø DC _{max} mm
32,5	SONT 14....	0,80	34,1
33,0		0,80	34,6
33,5		0,65	34,8
34,0		0,60	35,2
34,5	SONT 15....	0,50	35,5
35,0		0,45	35,9
35,5		0,35	36,2
36,0		0,35	36,7
36,5	SONT 16....	0,20	36,9
37,0		1,00	39,0
38,0		0,85	39,7
39,0		0,70	40,4
40,0	SONT 17....	0,50	41,0
41,0		0,35	41,7
42,0		0,95	43,9
43,0		0,80	44,6
44,0	SONT 18....	0,60	45,2
45,0		0,45	45,9
46,0		0,30	46,6
47,0		1,80	50,6
48,0	SONT 19....	1,65	51,3
49,0		1,50	52,0
50,0		1,35	52,7
51,0		1,15	53,3
52,0	SONT 20....	0,95	53,9
53,0		0,80	54,6
54,0		0,60	55,2
55,0		2,10	59,2
56,0	SONT 21....	1,90	59,8
57,0		1,75	60,5
58,0		1,55	61,1
59,0		1,35	61,7
60,0	SONT 22....	1,15	62,3
61,0		1,00	63,0
62,0		0,85	63,7
63,0		0,65	64,3

i The maximum radial X-offset affects the cutting force balance of the drill, therefore, the use of lower feed rates is recommended!

Technical data for turning – MaxiDrill 900

Insert size	a_p max. in mm	f in mm/rev.
SONT 03	0,40–1,50	0,08–0,22
SONT 04	0,40–1,80	0,09–0,27
SONT 05	0,60–2,40	0,10–0,30
SONT 06	0,60–2,80	0,11–0,34
SONT 07	0,60–3,40	0,13–0,38
SONT 08	0,70–4,20	0,15–0,41

Insert size	a_p max. in mm	f in mm/rev.
SONT 09	0,70–4,50	0,16–0,42
SONT 10	0,70–4,80	0,17–0,44
SONT 12	0,90–5,50	0,18–0,45
SONT 13	1,00–6,00	0,20–0,45
SONT 15	1,20–6,40	0,21–0,46
SONT 17	1,20–6,70	0,21–0,47

Coding example indexable insert drilling

System	Length	Bore diameter	Direction of rotation	Insert size	Machine connection and size
KUB-P	3D	215	R	07	ABS 50
KUB-P	3D	290	R	04	PSC 63
KUB-P.GH-CS	3D	76-78	R		ABS 80
MD-900	4D	240	R	08	C 32
KUB-T	2D	350	R	05	K 32
KUB-T	2D	350	L	05	ABS 50
KUB-C.GH	4D	320	R		ABS 50

3

KUB-P = KUB Pentron	215 = 21,5 mm	R = right	ABS50 = ABS adapter size 50
	290 = 29,0 mm	R = right	PSC63 = Polygon shank taper size 63
KUB-P.GH-CS = KUB Pentron CS	76-78 = 76-78 mm	R = right	ABS80 = ABS adapter size 80
MD-900 = MaxiDrill 900	240 = 24,0 mm	R = right	C32 = Cylindrical shank Ø 32.0 mm
KUB-T = KUB Trigon	350 = 35,0 mm	R = right	K32 = Cylindrical shank with combi clamping flat Ø 32.0 mm
		L = Left-hand	ABS50 = ABS adapter size 50
KUB-C.GH = KUB Centron	320 = KLG 32	R = right	ABS50 = ABS adapter size 50

 The KOMET number key for KOMET Performance indexable inserts (W80 ... / W29 ...) can be found in **Chapter 5 – Spindle tools on page 75.**

Recommended coolant pressure and coolant flow

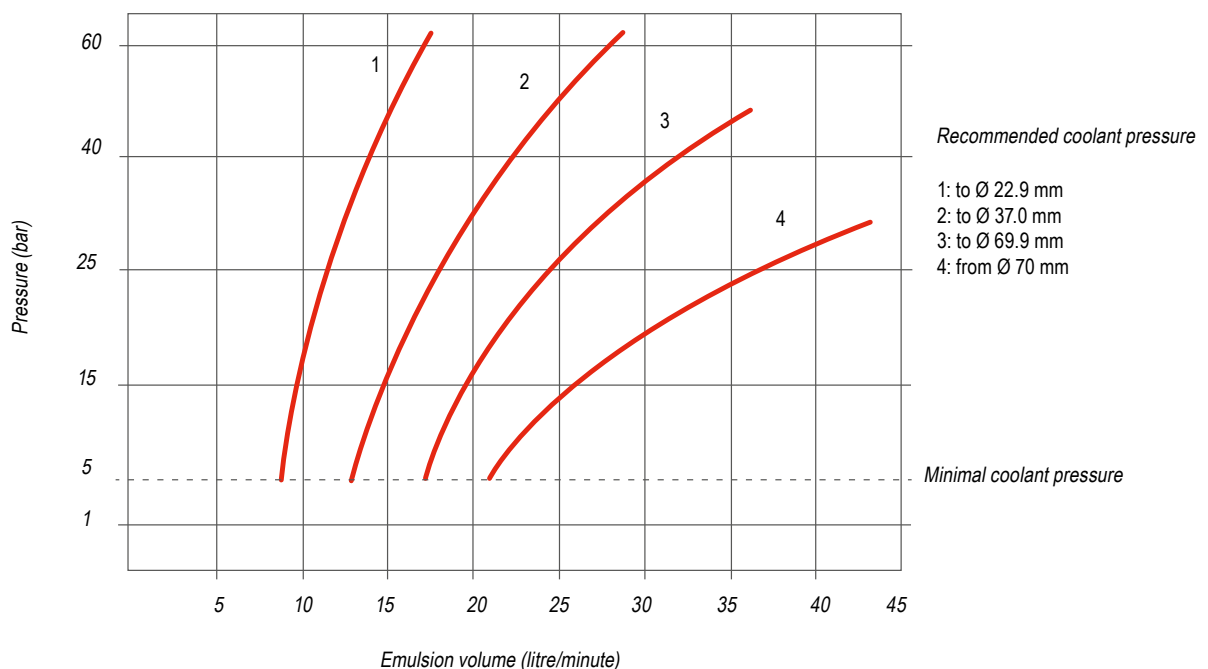

Indexable insert drilling – problems / possible causes / solutions

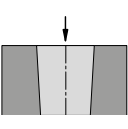
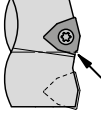
Rotating and stationary application		<p>Short service life / types of wear of indexable inserts</p> <ul style="list-style-type: none"> ▲ Cutting speed too high → select the correct cutting speed ▲ Insert grade selection has too little wear resistance → select a wear resistant grade ▲ Tool overhang too large → if possible, use a shorter tool ▲ Damaged insert seat → check tool, replace if necessary ▲ Clamping device stability too low → increase stability
		<p>Hole tapers in</p> <ul style="list-style-type: none"> ▲ Chip jam on the outer cutting edge → use a different chip breakage geometry, increase the feed if necessary ▲ Material very soft → increase the cutting speed, reduce the feed. Use a positive cutting edge geometry
		<p>Hole tapers out</p> <ul style="list-style-type: none"> ▲ Chip jam on the inner cutting edge → use a different chip breakage geometry, increase the feed if necessary
		<p>Poor surface quality</p> <ul style="list-style-type: none"> ▲ Poor chip evacuation → optimise the cutting parameters: Increase the cutting speed, reduce the feed
		<p>Built-up edge</p> <ul style="list-style-type: none"> ▲ Cutting speed too low → increase cutting speed ▲ Indexable insert too negative → use positive geometry ▲ Unsuitable coating → select the correct coating
		<p>Friction marks on the tool shank</p> <ul style="list-style-type: none"> ▲ Bore diameter too small → check the setting ▲ Chip evacuation problems → optimise the cutting parameters, check the geometry of the indexable insert ▲ Cutting radius too high → use the correct cutting radius
Stationary application		<p>Edge breakage on the inner cutting edge</p> <ul style="list-style-type: none"> ▲ Centre height of the tool too high/too low → adjust tool turret/adaptor if necessary → Recalibrate the machine ▲ Indexable insert grades interchanged → use correct indexable insert ▲ Feed too high → reduce feed ▲ Indexable insert grade too brittle → use a tougher indexable insert grade ▲ Incorrect indexable insert geometry → if necessary use a geometry with a chamfered cutting edge
		<p>Edge breakage on the outer cutting edge</p> <ul style="list-style-type: none"> ▲ Feed too high → reduce feed ▲ Interrupted cut → switch to a tougher grade of indexable insert ▲ Cutting radius too small → use an indexable insert with a larger cutting radius
		<p>Hole too small / too large</p> <ul style="list-style-type: none"> ▲ Machine is not in the X-0 position → move axis to correct position ▲ Machine axis has been moved → recalibrate the machine
Rotating application		<p>Edge breakage on the inner cutting edge</p> <ul style="list-style-type: none"> ▲ Indexable insert grades interchanged → use correct indexable insert ▲ Feed too high → reduce feed ▲ Indexable insert grade too brittle → use a tougher indexable insert grade ▲ Incorrect indexable insert geometry → if necessary use a geometry with a chamfered cutting edge
		<p>Edge breakage on the outer cutting edge</p> <ul style="list-style-type: none"> ▲ Feed too high → reduce feed ▲ Interrupted cut → switch to a tougher grade of indexable insert ▲ Cutting radius too small → use an indexable insert with a larger cutting radius
		<p>Hole too small / too large when using adjustable tools</p> <ul style="list-style-type: none"> ▲ Incorrect cutting radius used → use the correct cutting radius ▲ Incorrect setting → use the correct tool setting ▲ Increase cutting fluid supply

KUB Centron – notes on drilling technology

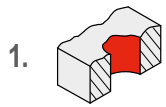

1.

Spot drilling on uneven surfaces (casting surfaces)

- ▲ Generally possible
- ▲ Reduce feed when spot drilling

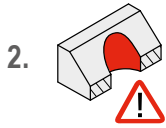

2.

Spot drilling on angled surfaces

- ▲ The spot drilling location must be spot faced in advance
- ▲ Avoid chips jamming on the drill shank

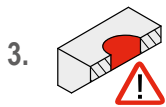

3.

Angled drill exit

- ▲ Possible under certain conditions
- ▲ If necessary, reduce feed
- ▲ Drilling angle max. 3°

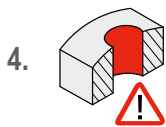

4.

Spot drilling on convex surfaces

- ▲ Central spot drilling possible with reduced feed
- ▲ If the spot drilling location is outside the centre of the radius, spot facing is required

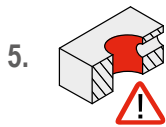

5.

Drilling through a transverse hole

- ▲ Halve the feed for interrupted cut
- ▲ Transverse hole max. 1/3 of the bore diameter
- ▲ Eccentric transverse hole not possible

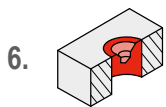

6.

Spot drilling in a pre-op or large centring hole

- ▲ Possible under certain conditions
- ▲ If necessary, reduce feed
- ▲ In the case of a large centre, face turning is required in advance
- ▲ If necessary, optimise the basic setting of the centring tip

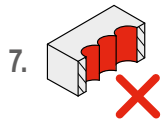

7.

Drilling a cavity

- ▲ Not possible

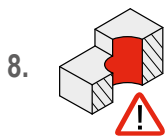

8.

Spot drilling on an edge

- ▲ Not possible with 4xD tools
- ▲ Preparation required due to undefined spot drilling location (spot facing, face milling)
- ▲ Then continue as described under Point 1

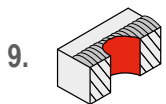

9.

Spot drilling on a forging/welding/casting seam

- ▲ Reduce feed when spot drilling
- ▲ If necessary, carry out facing in advance

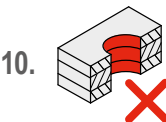

10.

Drilling through stacks

- ▲ Not possible

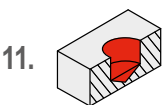

11.

Blind hole

- ▲ Possible
- ▲ Set guide rails 0.5 mm below actual Ø

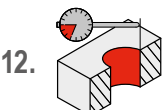

12.



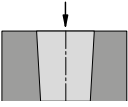
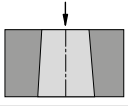
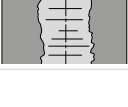
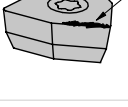
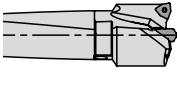
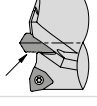
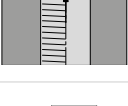
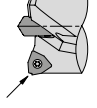
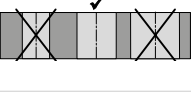
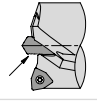
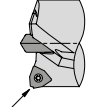
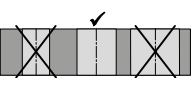

Adjustable

- ▲ Adjustable from a diameter of 65 mm

KUB Centron – problems / possible causes / solutions

Rotating and stationary application		<p>Short service life / types of wear of indexable inserts</p> <ul style="list-style-type: none"> ▲ Cutting speed too high → select the correct cutting speed ▲ Grade has too little wear resistance → select a wear-resistant grade ▲ Tool overhang too large → if possible, use a shorter tool ▲ Damaged insert seat → check tool, replace if necessary ▲ Clamping device stability too low → increase stability
		<p>Hole tapers in</p> <ul style="list-style-type: none"> ▲ Chip jam on the outer cutting edge → use a different chip breakage geometry, increase the feed if necessary ▲ Material very soft → increase the cutting speed, reduce the feed ▲ Use positive cutting edge geometry ▲ Axial adjustment of the centring tip not optimal → adjust according to the setting sheet in the operating instructions
		<p>Hole tapers out</p> <ul style="list-style-type: none"> ▲ Chip jam on the inner cutting edge → use a different chip breakage geometry, increase the feed if necessary
		<p>Poor surface quality</p> <ul style="list-style-type: none"> ▲ Poor chip evacuation → optimise the cutting parameters: Increase the cutting speed, reduce the feed
		<p>Built-up edge</p> <ul style="list-style-type: none"> ▲ Cutting speed too low → increase cutting speed ▲ Indexable insert too negative → use positive geometry ▲ Unsuitable coating → select the correct coating
		<p>Friction marks on the tool shank</p> <ul style="list-style-type: none"> ▲ Bore diameter too small → check the setting ▲ Chip evacuation problems → optimise the cutting parameters, check the geometry of the indexable insert ▲ Cutting radius too large → use the correct cutting radius ▲ Chips stuck on the supporting element, broken supporting elements, the supporting element does not have to be used for base elements of <math>< 6xD</math>
Stationary application		<p>Significant wear on one side of the centring tip</p> <ul style="list-style-type: none"> ▲ Tool not centred → tool turret/adaptor may have moved → recalibrate the machine
		<p>Single-sided retraction scoring</p> <ul style="list-style-type: none"> ▲ Tool not centred → tool turret/adaptor may have moved → recalibrate the machine
		<p>Edge breakage on the outer cutting edge</p> <ul style="list-style-type: none"> ▲ Feed too high → reduce feed ▲ Interrupted cut → switch to a tougher grade of indexable insert ▲ Cutting radius too small → use an indexable insert with a larger cutting radius
		<p>Hole too small / too large</p> <ul style="list-style-type: none"> ▲ Machine is not in the X-0 position → move axis to correct position ▲ Machine axis has been moved → recalibrate the machine
Rotating application		<p>Significant wear on one side of the centring tip</p> <ul style="list-style-type: none"> ▲ Guidance insufficient → check length adjustment of the centring tip
		<p>Edge breakage on the outer cutting edge</p> <ul style="list-style-type: none"> ▲ Feed too high → reduce feed ▲ Interrupted cut → switch to a tougher grade of indexable insert ▲ Cutting radius too small → use an indexable insert with a larger cutting radius
		<p>Hole too small / too large</p> <ul style="list-style-type: none"> ▲ Incorrect cutting radius used → use the correct cutting radius ▲ Incorrect setting → use the correct tool setting

Chip breakers

	KOMET \ Performance		KOMET \ Standard
	WOEX	SOGX	SONT
<p>-01</p> <ul style="list-style-type: none"> ▲ Universal geometry with stable cutting edge, suitable for a wide range of materials ▲ Can be used for centre and periphery (BK6115 -01: Recommended for periphery only) 			
<p>-03</p> <ul style="list-style-type: none"> ▲ Geometry for chip breakage problems with excellent chip control even at low feeds ▲ WOEX BK8425 -03: Can be used for periphery only ▲ SOGX BK8425 -03: Suitable for centre and periphery ▲ Main application in long-chipping materials as well as low alloy and stainless steels 			
<p>-11</p> <ul style="list-style-type: none"> ▲ Highly positive, minimally rounded chip breaker ▲ For soft-cutting usage ▲ Main application in aluminium or heat-resistant materials 			
<p>-13</p> <ul style="list-style-type: none"> ▲ Positive geometry, the dome-shaped chip breaker results in more controlled breaking of the chips ▲ Can be used for centre and periphery ▲ Also suitable for unstable machining conditions due to low cutting forces and power consumption ▲ Can be used with a wide range of materials 			
<p>-21</p> <ul style="list-style-type: none"> ▲ Highly positive, soft-cutting geometry ▲ Can be used for centre and periphery ▲ Lower cutting forces and reduced power consumption ▲ Main application (depending on grade) in non-ferrous metals, steels and stainless steels, extended application range also for titanium alloys 			
<p>-32</p> <ul style="list-style-type: none"> ▲ Minimised burr formation on entry and exit of hole ▲ Reliable separation of disc-shaped residual material when the drill exits the hole ▲ Suitable for a wide range of materials 			
<p>-34</p> <ul style="list-style-type: none"> ▲ High-feed geometry ▲ Extremely sturdy indexable insert ▲ Requires higher drive power and stable setup ▲ Designed specially for steel and cast iron materials 			
<p>-M30</p> <ul style="list-style-type: none"> ▲ Universal geometry ▲ Stable indexable insert, also suitable for high feeds ▲ CTPP430: Can be used for centre and periphery ▲ CTCPC420: Only suitable for periphery 			

 Further indexable inserts can be found in our online shop cuttingtools.ceratizit.com



Grades Overview

CTPP430

- ▲ Carbide, TiAlN-coated
- ▲ ISO | P30 | M25 | S25 | K30 | N25
- ▲ The universal high-performance grade for steel, austenitic steel and heat-resistant alloys.

DRAGONSKIN

BK8425

- ▲ Carbide, TiAlN/TiN-coated
- ▲ ISO | P25 | M25 | K25 | N25 | S25 | H25
- ▲ Universally applicable grade with increased wear resistance thanks to the innovative PVD coating in a multilayer design.

CTCP420

- ▲ Carbide, TiCN-Al₂O₃-coated
- ▲ ISO | P20 | K20
- ▲ The wear-resistant solution for steel and cast iron materials at high cutting speeds.

DRAGONSKIN

BK8430

- ▲ Carbide, TiAlN/TiN-coated
- ▲ ISO | P25 | M25 | K25 | N25 | S25 | H25
- ▲ Fine-grain grade with high wear resistance
- ▲ Extreme edge stability and maximum wear resistance in the middle and top speed range

BK7710

- ▲ Carbide, TiB₂-coated
- ▲ ISO | N10 | S10 | O10
- ▲ The wear-resistant grade with optimum cutting characteristics to prevent built-up edge formation for machining aluminium and titanium alloys.

BK6115

- ▲ Carbide, TiCN-TiN-Al₂O₃-coated
- ▲ ISO | P20 | M20 | K20 | H20
- ▲ High-quality, surface-treated coating for machining cast iron materials under normal to stable conditions and high cutting speeds.

BK7615

- ▲ Carbide, TiCN-Al₂O₃-coated
- ▲ ISO | K15
- ▲ Highly productive grade with extreme edge stability for wet and dry machining of all cast iron materials

BK7935

- ▲ Carbide, AlTiN-coated
- ▲ ISO | P35 | M30 | K30 | N30 | S30 | O30
- ▲ The tough carbide grade for machining stainless steel and acid-resistant steels as well as special alloys.

BK62

- ▲ Carbide, TiN-TiCN-Al₂O₃-coated
- ▲ ISO | K15 | H15
- ▲ Special carbide grade for machining cast iron materials at high cutting speeds. Not suitable for machining aluminium materials.

BK77

- ▲ Carbide, TiN-coated
- ▲ ISO | S10 | H10 | O10
- ▲ The wear-resistant carbide grade for machining aluminum alloys, superalloys and plastics at medium cutting speeds.

BK79

- ▲ Carbide, TiAlN-coated
- ▲ ISO | P40 | M35 | K25 | N30
- ▲ Universally applicable grade with high wear-resistance
- ▲ low to medium cutting speed for roughing and finishing as well as interrupted cut

Application

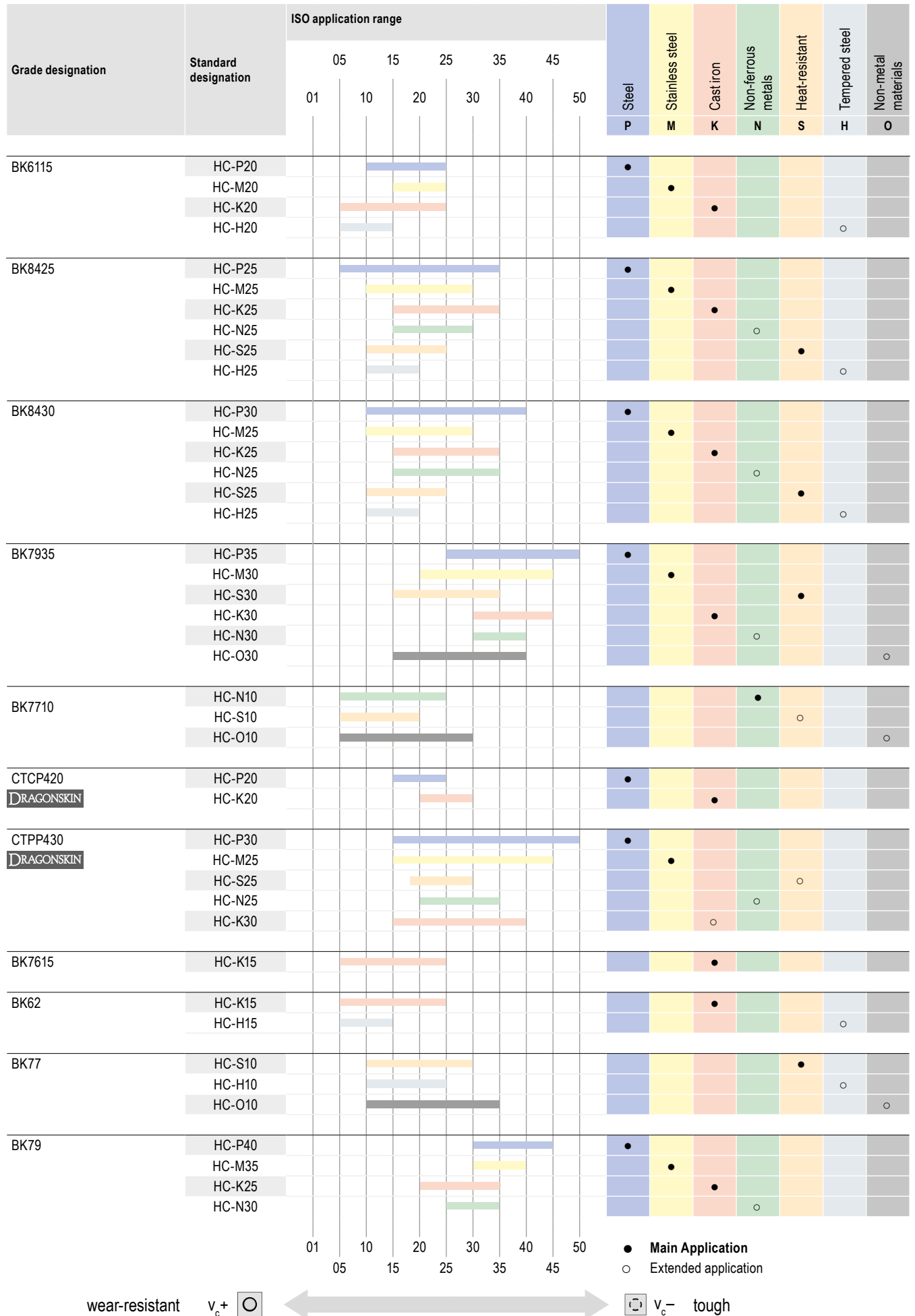

● Main Application
○ Extended application

wear-resistant $v_c +$



$v_c -$ tough

