

New products for machining technicians

NEW

MonsterMill – Ball Nosed Cutter



Our specialist for 3D milling and machining of nickel-based alloys.

NCR

→ Page 39

NEW

HPC-UNI end mill 3xDC



New outstanding products in our standard range.

N

→ Page 242

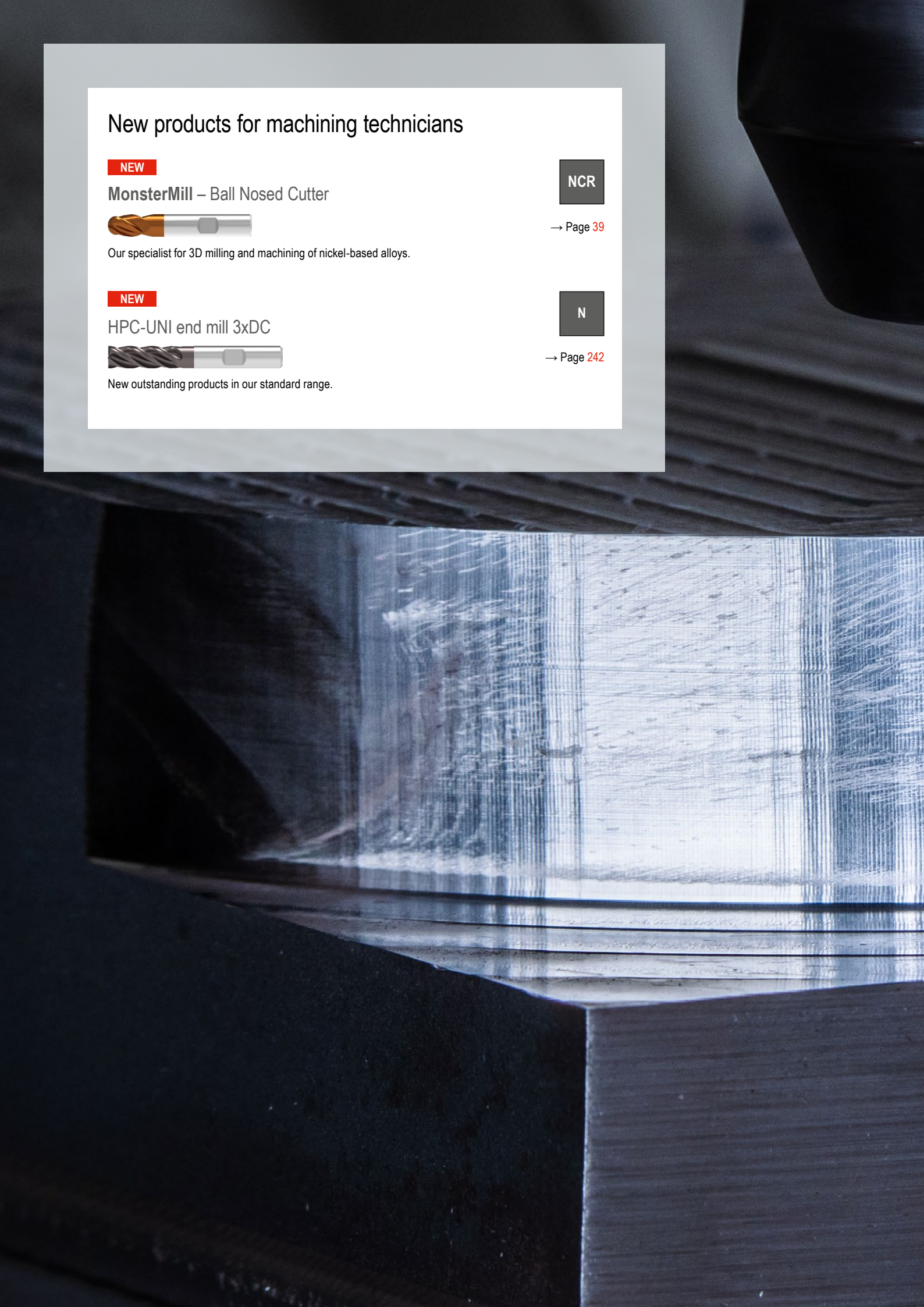

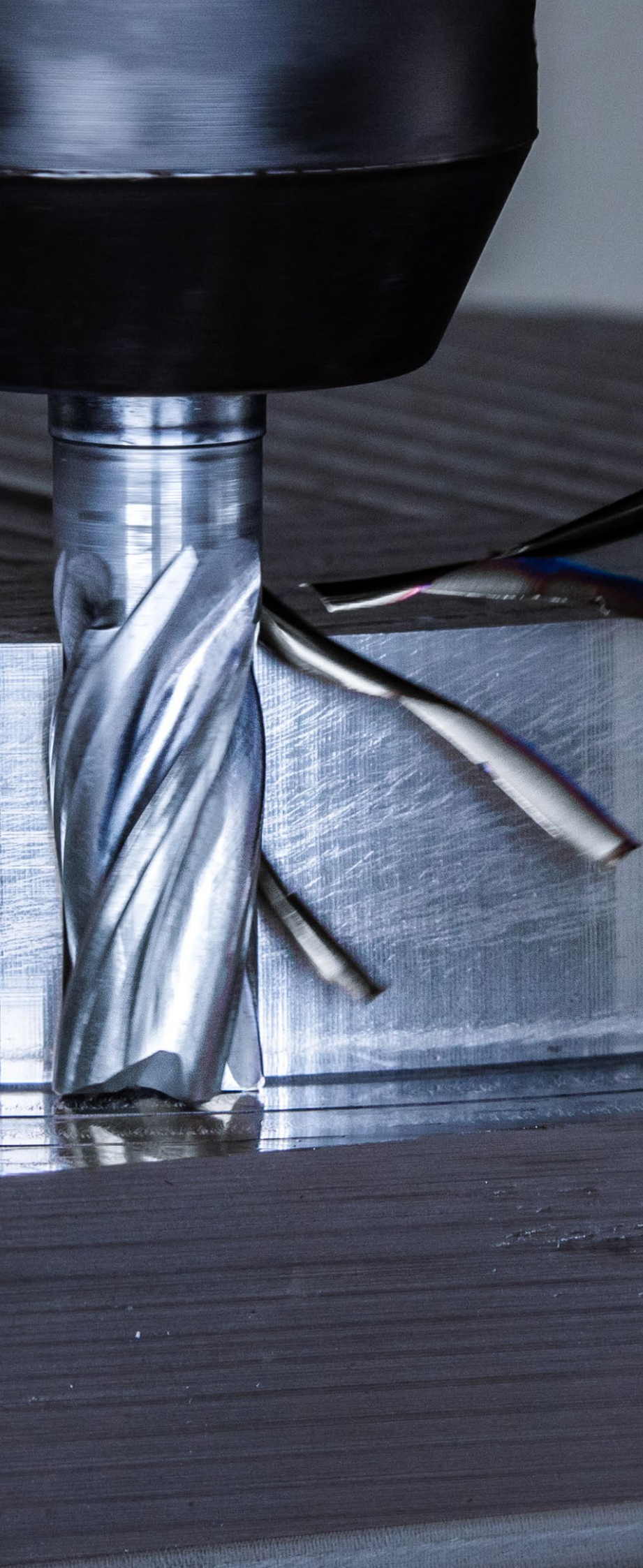

Solid drilling and bore machining

- 1 HSS drilling
- 2 Solid carbide drilling
- 3 Indexable insert drilling
- 4 Reaming and Countersinking
- 5 Spindle Tooling

Threading

- 6 Taps and thread formers
- 7 Circular and Thread Milling
- 8 Thread turning

Turning

- 9 Turning Tools
- 10 Multifunctional Tools – EcoCut and FreeTurn
- 11 Grooving Tools
- 12 Miniature turning tools

Milling

- 13 HSS Milling Cutters
- 14 Solid Carbide milling cutters
- 15 Milling tools with indexable inserts

Clamping technology

- 16 Adaptors and Accessories
- 17 Workpiece clamping

- 18 Material examples and article no. Index

Table of contents

Symbol explanation	4
Toolfinder for High Performance Milling Cutters	5-9
List of contents	10-18
Product programme	19-320
Technical Information	
Selection guide for cutters for plastic, fiberglass, carbon fibre	309
Cutting Data	321-485
Approximate feed rates	486
Trochoidal Milling	487
General references	488-496
Version description	497
Coatings	498

WNT \ Performance

Premium quality tools for high performance.

The premium quality tools from the **WNT Performance** product line have been designed for specific applications and are distinguished by their outstanding performance. If you make high demands on the performance of your production and want to achieve the very best results, we recommend the Premium tools in this product line.





WNT \ Standard

Quality tools for standard applications.





The quality tools of the **WNT Standard** product line are high quality, powerful and reliable and enjoy the highest trust of our customers worldwide. Tools from this product line are the first choice for many standard applications and guarantee optimal results.

Symbol explanation

Shank







-  Shank type
-  **Length:** extra short / short / medium / long / extra long
-  Axial thro' coolant
-  Radial thro' coolant

Cutting edge preparation

-  Sharp
-  Corner chamfer (CHW = chamfer width in mm)
-  Corner radius
-  Full Radius





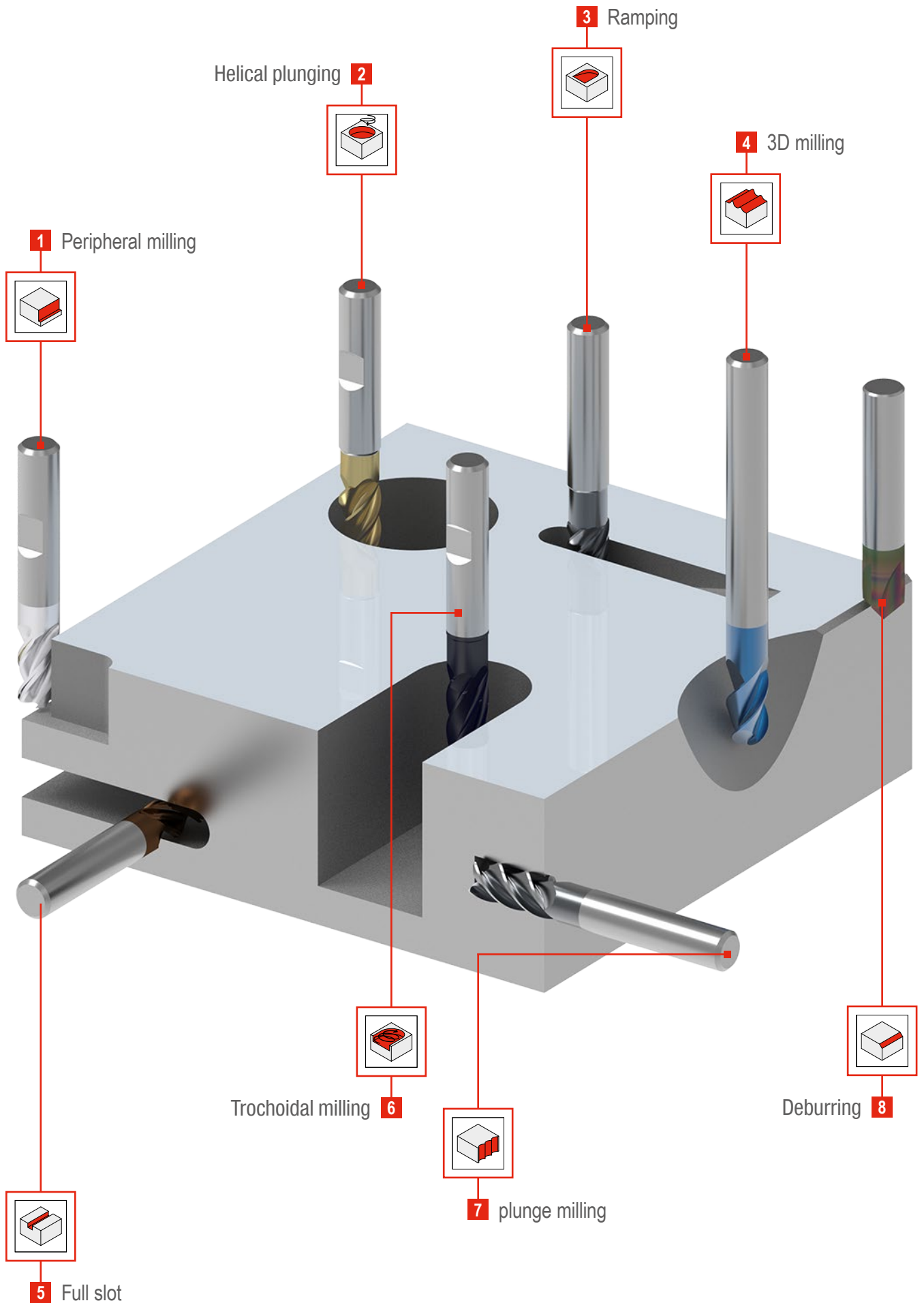

Application

-  **HPC** High volume machining
 -  **HFC** High-feed milling
 -  **54-70 HRC** Hard materials
 -  Machining example
 -  The red arrows describe the possible feed directions
 -  Cutting geometry
 $\lambda_s = 48^\circ$
 $\gamma_s = 10^\circ$
 λ_s = Helix Angle
 γ_s = Rake Angle
 -  λ_s var. Variable helix angle
- ZEFP = Number of flutes
- = **Main Application**
 - = Extended application

Toolfinder for High Performance Milling Cutters







Toolfinder for high-performance milling cutters – MonsterMill

		1 Peripheral milling	2 Helical plunging	3 Ramping	4 3D milling
					
P	Steel	MonsterMill – SCR MonsterMill – PCR	MonsterMill – PCR MonsterMill – SCR MonsterMill – MCR	MonsterMill – PCR MonsterMill – SCR MonsterMill – MCR	MonsterMill – SCR
M	Stainless steel	MonsterMill – ICR	MonsterMill – ICR	MonsterMill – ICR	MonsterMill – TCR
K	Cast iron	MonsterMill – SCR MonsterMill – PCR	MonsterMill – PCR MonsterMill – SCR MonsterMill – MCR	MonsterMill – PCR MonsterMill – SCR MonsterMill – MCR	MonsterMill – SCR
N	Non-ferrous metals	MonsterMill – PCR	MonsterMill – PCR	MonsterMill – PCR	
S	Heat resistant alloys	MonsterMill – NCR MonsterMill – TCR MonsterMill – ICR	MonsterMill – NCR MonsterMill – TCR MonsterMill – ICR	MonsterMill – NCR MonsterMill – TCR MonsterMill – ICR	MonsterMill – TCR MonsterMill – NCR
H	Tempered steel	< 55 HRC			
		> 55 HRC	MonsterMill – HCR		MonsterMill – HCR
O	Non-metal materials	MonsterMill – FRP / FRP CR	MonsterMill – FRP / FRP CR	MonsterMill – FRP / FRP CR	

MonsterMill – SCR → Page 19–26



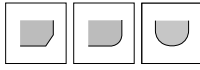

The specialist for machining steel and cast iron

ZEFP \varnothing DC mm
3–6 3–20

MonsterMill – ICR → Page 27+28





The specialist for machining stainless steel

ZEFP \varnothing DC mm
3–5 1,5–20

MonsterMill – HCR → Page 40–45



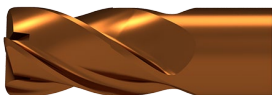

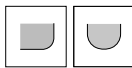
The specialist for finish machining tempered steel up to 70 HRC





ZEFP \varnothing DC mm
2–4 0,2–12

MonsterMill – PCR → Page 46–50

The specialist for ramping, plunging and helical milling

ZEFP \varnothing DC mm
4 5–20

5 Full slot	6 Trochoidal milling	7 plunge milling	8 Deburring
			
MonsterMill – PCR MonsterMill – SCR MonsterMill – MCR	MonsterMill – PCR	MonsterMill – PCR	
MonsterMill – ICR			
MonsterMill – PCR MonsterMill – SCR MonsterMill – MCR	MonsterMill – PCR	MonsterMill – PCR	
MonsterMill – PCR	MonsterMill – PCR	MonsterMill – PCR	
MonsterMill – NCR MonsterMill – TCR MonsterMill – ICR			
MonsterMill – FRP / FRP CR			

MonsterMill – TCR → Page 29–33

The specialist for machining titanium and titanium alloys

TCR











ZEFP \varnothing DC
2–5 mm
2–20

MonsterMill – NCR → Page 34–39

The specialist for machining nickel-based alloys

NCR







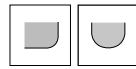



ZEFP \varnothing DC
4–5 mm
2–20

MonsterMill – MCR → Page 51

The specialist for rough machining steel and cast iron

MCR











ZEFP \varnothing DC
3–4 mm
1–20

MonsterMill – FRP / FRP CR → Page 52–56

The specialist for machining carbon fibre-reinforced plastics

FRP













ZEFP \varnothing DC
1–8 mm
6–12,7

Toolfinder for high-performance milling cutters

		1 Peripheral milling	2 Helical plunging	3 Ramping	4 3D milling
					
P	Steel	SilverLine S-Cut Micro-milling tools MultiLock / MultiChange	MultiLock / MultiChange		3D Finish SilverLine Micro-milling tools MultiLock / MultiChange
M	Stainless steel	SilverLine S-Cut Micro-milling tools			3D Finish SilverLine Micro-milling tools
K	Cast iron	SilverLine S-Cut Micro-milling tools MultiLock / MultiChange	MultiLock / MultiChange	MultiLock / MultiChange	3D Finish SilverLine Micro-milling tools MultiLock / MultiChange
N	Non-ferrous metals	AluLine PCD milling tools Micro-milling tools MultiChange	AluLine PCD milling tools MultiChange	AluLine PCD milling tools MultiChange	3D Finish AluLine PCD milling tools Micro-milling tools MultiChange
S	Heat resistant alloys	Micro-milling tools MultiLock	MultiLock	MultiLock	3D Finish Micro-milling tools MultiLock
H	Tempered steel	< 55 HRC BlueLine Micro-milling tools	BlueLine	BlueLine	BlueLine Micro-milling tools
		> 55 HRC			
O	Non-metal materials	PCD milling tools Micro-milling tools	PCD milling tools	PCD milling tools	3D Finish PCD milling tools Micro-milling tools

CircularLine → Page 57-76

The specialist for trochoidal machining

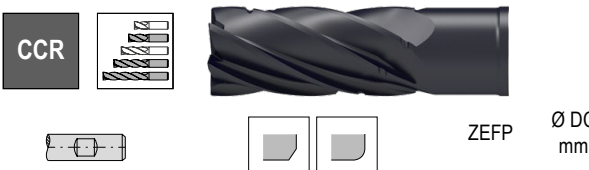

CCR

ZEFP Ø DC mm
4-6 6-20

AluLine → Page 77-115

The specialist for machining non-ferrous metals

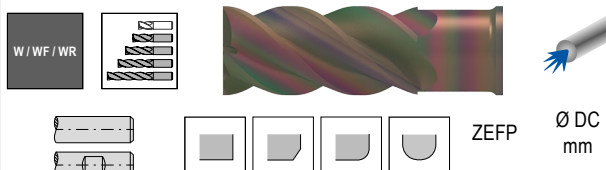

W / WF / WR

ZEFP Ø DC mm
2-6 2-25

S-Cut → Page 151-155

The all-rounder with soft cut and low power consumption

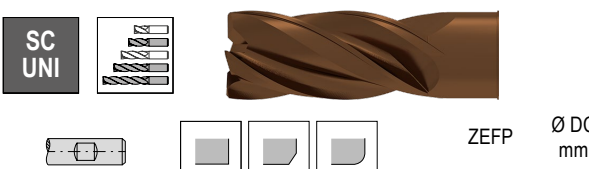

SC
UNI

ZEFP Ø DC mm
4-5 3-25

3D Finish → Page 156-160

The specialist for 3D finish machining

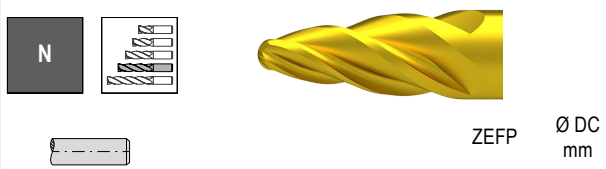

N

ZEFP Ø DC mm
2-4 4-16

MultiLock → Page 193-196

The sustainable exchangeable head system



N

ZEFP Ø DC mm
4-6 12-25

MultiChange → Page 197-202

The exchangeable head system for the highest demands and a wide range of applications

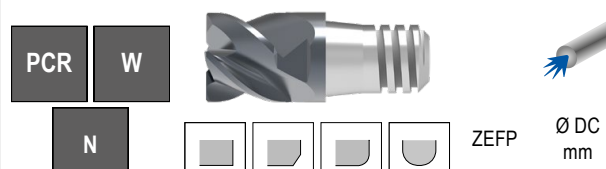

PCR W N

ZEFP Ø DC mm
3-6 8-20

5 Full slot	6 Trochoidal milling	7 plunge milling	8 Deburring
S-Cut SilverLine Micro-milling tools MultiLock / MultiChange	CircularLine		SilverLine MultiLock MultiChange
S-Cut SilverLine Micro-milling tools	CircularLine		SilverLine
S-Cut SilverLine Micro-milling tools MultiLock / MultiChange	CircularLine		SilverLine MultiLock MultiChange
AluLine PCD milling tools Micro-milling tools MultiChange	CircularLine	PCD milling tools	AluLine MultiChange
Micro-milling tools MultiLock	CircularLine		SilverLine
BlueLine Micro-milling tools	CircularLine		BlueLine
	CircularLine		BlueLine
PCD milling tools Micro-milling tools		PCD milling tools	AluLine

PCD milling tools → Page 116–128

The tool with the highest cutting parameters and longest service lives for machining non-ferrous metals and plastics

W

ZEFP Ø DC mm
1-22 2-125

SilverLine → Page 129–150

The all-rounder for universal application

N / NF / NR

ZEFP Ø DC mm
2-6 3-25

BlueLine → Page 161–185

The all-rounder for machining tempered steel

H

ZEFP Ø DC mm
2-10 0,1-20

Micro-milling tools → Page 186–192

The universal milling cutter for micro-cutting

N

ZEFP Ø DC mm
2 0,2-2,0

Overview High Performance Milling Cutters

Tool type	Number of flutes	Diameter in mm	Material compatibility								Geometry				Length	Tool design	Cooling		WNT \ Performance
			Steel	Stainless steel	Cast iron	Non-ferrous metals	Heat-resistant	Tempered steel	Non-metal materials	Sharp	Corner chamfer	Corner radius	Full Radius	coated			uncoated		
ZEFP	Ø DC	P	M	K	N	S	H	O											
MonsterMill																			
	SCR	4-6	3-20	●	○	●	○	○	○						HPC	<input type="checkbox"/>	19-24		
	SCR	3-4	3-16	●	○	●	○	○	○						HPC	<input type="checkbox"/>	25		
	SCR	4	3-16	●	○	●	○	○	○					HPC HFC	<input type="checkbox"/>	26			
	ICR	3-5	1,5-20	○	●	○	○	○	○					HPC	<input type="checkbox"/>	27+28			
	TCR	4-5	4-20	○	○	○	○	○	○					HPC	<input type="checkbox"/>	29-31			
	TCR	4	2-16	○	○	○	○	○	○						<input type="checkbox"/>	32			
	TCR	2-5	2-16	○	○	○	○	○	○					HPC HFC	<input type="checkbox"/>	33			
	NCR	4-5	4-20	○	○	○	○	○	○					HPC	<input type="checkbox"/>	34-38			
	NCR	4	2-16	○	○	○	○	○	○						<input type="checkbox"/>	39			
	HCR	2-4	0,2-12	○	○	○	○	○	○						<input type="checkbox"/>	40-42			
	HCR	2-4	0,2-12	○	○	○	○	○	○						<input type="checkbox"/>	43-45			
	PCR UNI	4	5-20	●	○	●	○	○	○					HPC	<input type="checkbox"/>	46-48			
	PCR ALU	4	5-20	○	○	○	○	○	○					HPC	<input type="checkbox"/>	49+50			
	MCR	3-4	1-20	●	○	●	○	○	○					HPC	<input type="checkbox"/>	51			
	FRP CR		6,0-12,7	○	○	○	○	○	○						<input type="checkbox"/>	52+53			
	FRP	8	6,0-12,7	○	○	○	○	○	○						<input type="checkbox"/>	54-56			
CircularLine																			
	CCR UNI	5-6	6-20	●	○	●	○	○	○					HPC	<input type="checkbox"/>	57-66			
	CCR VA	5-6	6-20	○	○	○	○	○	○					HPC	<input type="checkbox"/>	67+68			
	CCR AL	4	6-20	○	○	○	○	○	○						<input type="checkbox"/>	69-74			
	CCR Ti	5	6-20	○	○	○	○	○	○					HPC	<input type="checkbox"/>	75			
	CCR H	6	6-20	○	○	○	○	○	○						<input type="checkbox"/>	76			

Overview High Performance Milling Cutters

Tool type	Number of flutes	Diameter in mm	Material compatibility							Geometry				Length	Tool design	Cooling		WNT \ Performance	
			Steel	Stainless steel	Cast iron	Non-ferrous metals	Heat-resistant	Tempered steel	Non-metal materials	Sharp	Corner chamfer	Corner radius	Full Radius			coated	uncoated		
ZEFP	Ø DC	P	M	K	N	S	H	O											
AluLine																			
	W	2	2-20														<input type="checkbox"/>	<input type="checkbox"/>	77-82
	W	3	2-20														<input type="checkbox"/>	<input type="checkbox"/>	83-90
	W	3	2-20												HPC		<input type="checkbox"/>	<input type="checkbox"/>	91-97
	W	3	6-20														<input type="checkbox"/>	<input type="checkbox"/>	98-100
	W	4	2-25														<input type="checkbox"/>	<input type="checkbox"/>	101-106
	WF	3	3-20														<input type="checkbox"/>	<input type="checkbox"/>	107
	WR	3	6-20												HPC		<input type="checkbox"/>	<input type="checkbox"/>	108+109
	W	6	6-20												HPC		<input type="checkbox"/>	<input type="checkbox"/>	110
	W	2	3-20														<input type="checkbox"/>	<input type="checkbox"/>	111-113
	W	4	4-16														<input type="checkbox"/>	<input type="checkbox"/>	114+115
PCD milling tools																			
	W	1-4	2-20														<input type="checkbox"/>	<input type="checkbox"/>	116-118
	W	1-2	2-20														<input type="checkbox"/>	<input type="checkbox"/>	119
	W	1-2	2-20														<input type="checkbox"/>	<input type="checkbox"/>	120+121
	W	4-10	10-32												HPC		<input type="checkbox"/>	<input type="checkbox"/>	122
	W	3	16-25														<input type="checkbox"/>	<input type="checkbox"/>	123
	W	2-3	10-25														<input type="checkbox"/>	<input type="checkbox"/>	124
	W	2-6	10-32														<input type="checkbox"/>	<input type="checkbox"/>	125
	W	4-10	10-32												HPC		<input type="checkbox"/>	<input type="checkbox"/>	126
	W	2-3	10-16														<input type="checkbox"/>	<input type="checkbox"/>	127
	W	10-22	40-125														<input type="checkbox"/>	<input type="checkbox"/>	128

Overview High Performance Milling Cutters

Tool type	Number of flutes	Diameter in mm	Material compatibility							Geometry				Length	Tool design	Cooling		WNT \ Performance
			Steel	Stainless steel	Cast iron	Non-ferrous metals	Heat-resistant	Tempered steel	Non-metal materials	Sharp	Corner chamfer	Corner radius	Full Radius			coated	uncoated	
ZEPF		Ø DC	P	M	K	N	S	H	O									
SilverLine																		
	N	2	3-20	●	●	●	○	●	■	<input type="checkbox"/>	<input type="checkbox"/>		<input type="checkbox"/>	HPC	<input type="checkbox"/>			129+130
	N	3	3-20	●	●	●	○	●	■	<input type="checkbox"/>	<input type="checkbox"/>	<input type="checkbox"/>	<input type="checkbox"/>	HPC	<input type="checkbox"/>			131-133
	N	4	3-20	●	●	●	○	●	■		<input type="checkbox"/>		<input type="checkbox"/>	HPC	<input type="checkbox"/>			134-136
	N	4	6-20	●	●	●	○	●	■		<input type="checkbox"/>		<input type="checkbox"/>	HPC		<input type="checkbox"/>		137
	N	4-5	3-20	●	●	●	○	●	■	<input type="checkbox"/>	<input type="checkbox"/>		<input type="checkbox"/>	HPC	<input type="checkbox"/>			138-142
	NF	4	3-20	●	●	●	○	●	■		<input type="checkbox"/>		<input type="checkbox"/>	HPC	<input type="checkbox"/>			143
	NR	4	3-20	●	●	●	○	●	■		<input type="checkbox"/>		<input type="checkbox"/>	HPC	<input type="checkbox"/>			144
	N	6	6-25	●	●	○	○	●	■	<input type="checkbox"/>			<input type="checkbox"/>		<input type="checkbox"/>			145
	N	2	3-20	●	●	○	○	●	■			<input type="checkbox"/>	<input type="checkbox"/>		<input type="checkbox"/>			146
	N	4	4-20	●	○	●	○	●	■			<input type="checkbox"/>	<input type="checkbox"/>		<input type="checkbox"/>			147
	N	4	6-20	●	○	●	○	●	■		<input type="checkbox"/>		<input type="checkbox"/>	HPC HFC	<input type="checkbox"/>			148
	N	5	4-16	●	●	●	○	●	■						<input type="checkbox"/>	<input type="checkbox"/>		149+150
S-Cut																		
	SC UNI	4	3-25	●	●	●	○	○	■	<input type="checkbox"/>	<input type="checkbox"/>	<input type="checkbox"/>	<input type="checkbox"/>	HPC	<input type="checkbox"/>			151-153
	SC UNI	5	6-20	●	●	●	○	○	■		<input type="checkbox"/>		<input type="checkbox"/>	HPC	<input type="checkbox"/>			154
	SC NR	4	3-20	●	●	●	○	○	■		<input type="checkbox"/>		<input type="checkbox"/>	HPC	<input type="checkbox"/>			155
3D Finish																		
	N	4	10	●	●	●	○	●	■				<input type="checkbox"/>		<input type="checkbox"/>			156
	N	3-4	6-16	●	●	●	○	●	■				<input type="checkbox"/>		<input type="checkbox"/>			157
	N	3	6-16	●	●	●	○	●	■				<input type="checkbox"/>		<input type="checkbox"/>			158
	N	2	10	●	●	●	○	●	■				<input type="checkbox"/>		<input type="checkbox"/>			159
	N	3	4-12	●	●	●	○	●	■				<input type="checkbox"/>		<input type="checkbox"/>			160

Overview High Performance Milling Cutters

Tool type	Number of flutes	Diameter in mm	Material compatibility								Geometry				Length	Tool design	Cooling	coated	uncoated	WNT \ Performance
			Steel	Stainless steel	Cast iron	Non-ferrous metals	Heat-resistant	Tempered steel	Non-metal materials	Sharp	Corner chamfer	Corner radius	Full Radius							
ZEPF	Ø DC	P	M	K	N	S	H	O												
BlueLine																				
	H	2	0,2-3	●	●	●	●	●	●	●	●	●	●	●	●	●	●	●	161-163	
	H	2	0,2-3	●	●	●	●	●	●	●	●	●	●	●	●	●	●	●	164-166	
	H	2	0,4-3	●	●	●	●	●	●	●	●	●	●	●	●	●	●	●	167-169	
	H	2	0,5-20	●	●	●	●	●	●	●	●	●	●	●	●	●	●	●	170	
	H	4-6	1-20	●	●	●	●	●	●	●	●	●	●	●	●	●	●	●	171-173	
	H	4-10	2-20	●	●	●	●	●	●	●	●	●	●	●	●	●	●	●	174+175	
	H	2	0,1-20	○	●	●	●	●	●	●	●	●	●	●	●	●	●	●	176-179	
	H	3	3-12	●	●	●	●	●	●	●	●	●	●	●	●	●	●	●	180	
	H	4	2-20	○	●	●	●	●	●	●	●	●	●	●	●	●	●	●	181	
	H	2	0,5-16	○	●	●	●	●	●	●	●	●	●	●	●	●	●	●	182-184	
	H	5-8	4-16	●	●	●	●	●	●	●	●	●	●	●	●	●	●	●	185	
Micro-milling tools																				
	N	2	0,2-2	●	●	●	●	●	○	○	○	○	○	○	○	○	○	○	186+187	
	N	2	0,2-2	●	●	●	●	●	○	○	○	○	○	○	○	○	○	○	188-190	
	N	2	0,5-2	●	●	●	●	●	○	○	○	○	○	○	○	○	○	○	191+192	

Overview High Performance Milling Cutters

Tool type	ZEFP	Number of flutes	Diameter in mm Ø DC	Material							Geometry				Length	Tool design	Cooling		WNT \ Performance	
				Steel P	Stainless steel M	Cast iron K	Non-ferrous metals N	Heat-resistant S	Tempered steel H	Non-metal materials O	Sharp	Corner chamfer	Corner radius	Full Radius			coated	uncoated		
MultiLock – exchangeable head system																				
	N	4	12-25	●	○	●	○	●	○	●	○									193
	N	4-6	12-25	●	○	●	○	●	○	●	○									193
	N	5-6	12-25	●	○	●	○	●	○	●	○						HFC		194	
	N	4	12-16	●	○	●	○	●	○	●	○									194
MultiLock – Adapters and holders																				
				●	○	●	○	●	○	●	○									195+196
MultiChange – exchangeable head system																				
	PCR	4	10-20	●	○	●	○	●	○	●	○							HPC		198
	W	3	10-20	●	○	●	○	●	○	●	○									198
	N	3-4	8-20	●	○	●	○	●	○	●	○							HPC		199
	N	4-6	8-20	●	○	●	○	●	○	●	○									199
	N	6	8-20	●	○	●	○	●	○	●	○									200
	N	4	10-20	●	○	●	○	●	○	●	○									200
	N	4	8-20	●	○	●	○	●	○	●	○									200
	N	6	8-20	●	○	●	○	●	○	●	○						HFC		201	
	N	4	8-20	●	○	●	○	●	○	●	○									201
	N	4-6	10-20	●	○	●	○	●	○	●	○									202

End Mills Overview

Tool type	Number of flutes	Diameter in mm	Material compatibility								Geometry				Length	Tool design	Cooling		WNT \ Standard
			Steel	Stainless steel	Cast iron	Non-ferrous metals	Heat-resistant	Tempered steel	Non-metal materials	Sharp	Corner chamfer	Corner radius	Full Radius	coated			uncoated		
ZEFP	Ø DC	P	M	K	N	S	H	O											





































End Mills with Finishing Geometry

	W	2	0,2-6,0															<input checked="" type="checkbox"/>	203+204
	W	2	2,7-25												HPC			<input type="checkbox"/>	205-211
	W	3	3-25												HPC			<input type="checkbox"/>	212-214
	W	4	6-20												HPC			<input type="checkbox"/>	215+216
	W	5-7	6-20												HPC			<input type="checkbox"/>	217
	N	2	0,2-20															<input type="checkbox"/>	218-225
	N	3	3-20															<input type="checkbox"/>	226
	N	3	0,5-20															<input type="checkbox"/>	227-233
	N	4	1,5-25												HPC			<input type="checkbox"/>	234-237
	N	4	2-12												HPC			<input type="checkbox"/>	238
	N	4	3-20															<input type="checkbox"/>	239
	N	4	3-20												HPC			<input type="checkbox"/>	240-245
	N	6-8	4-32															<input type="checkbox"/>	246-249
	N	8-16	6-20															<input type="checkbox"/>	250
	H	4	4-20															<input type="checkbox"/>	251
	H	6-8	4-25															<input type="checkbox"/>	252+253











End Mills with Roughing and Finishing Geometry

	WF	4	5-20															<input type="checkbox"/>	254
	NTR	3-4	6-20															<input type="checkbox"/>	255

Overview of end milling, ball-nosed and torus cutters

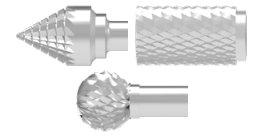
Tool type	Number of flutes	Diameter in mm	Material compatibility								Sharp	Corner chamfer	Corner radius	Full Radius	Length	Tool design	Cooling		WNT \ Standard
			Steel	Stainless steel	Cast iron	Non-ferrous metals	Heat-resistant	Tempered steel	Non-metal materials	coated							uncoated		
ZEFP	Ø DC	P	M	K	N	S	H	O											
End Mills with Roughing Geometry																			
	NR	4-6	4-25	●	●	●	○	●	○						HPC		<input type="checkbox"/>	256-258	
	HR	4-5	6-25	●	●	●	○	●	○								<input type="checkbox"/>	259-261	
Ball Nosed End Mills with Finishing Geometry																			
	W	2	0,5-12	●	●	●	○	●	○				<input type="checkbox"/>				<input type="checkbox"/>	262	
	W	2	0,2-6	●	●	●	○	●	○				<input type="checkbox"/>				<input type="checkbox"/>	263+264	
	W	2	3-20	●	●	●	○	●	○				<input type="checkbox"/>		HPC		<input type="checkbox"/>	265	
	W	2	0,5-12	●	●	●	○	●	○				<input type="checkbox"/>				<input type="checkbox"/>	266+267	
	N	2	0,1-20	●	○	●	○	○	○				<input type="checkbox"/>				<input type="checkbox"/>	268-273	
	N	2	1-12	●	○	●	○	○	○				<input type="checkbox"/>				<input type="checkbox"/>	274	
	N	2	3-20	●	●	○	●	○	○				<input type="checkbox"/>		HPC		<input type="checkbox"/>	275	
	N	4	3-20	●	●	●	○	●	○				<input type="checkbox"/>		HPC		<input type="checkbox"/>	276-278	
	H	2	0,2-20	●	○	●	○	○	○				<input type="checkbox"/>				<input type="checkbox"/>	279-280	
Torus Milling Cutters with Finishing Geometry																			
	W	2	0,2-12	●	●	●	○	●	○				<input type="checkbox"/>				<input type="checkbox"/>	281-284	
	W	2	2-12	●	●	●	○	●	○				<input type="checkbox"/>				<input type="checkbox"/>	285	
	W	4	4-12	●	●	●	○	●	○				<input type="checkbox"/>				<input type="checkbox"/>	286+287	
	N	2	0,5-16	●	○	●	○	○	○				<input type="checkbox"/>				<input type="checkbox"/>	288	
	H	2	0,4-12	●	○	●	○	○	○				<input type="checkbox"/>				<input type="checkbox"/>	289-292	
	H	4-8	3-16	●	○	●	○	○	○				<input type="checkbox"/>				<input type="checkbox"/>	293	

Overview Special Milling Cutters

Tool type	Number of flutes	Diameter in mm	Material	Sharp	Corner chamfer	Corner radius	Full Radius	Length	Tool design	Cooling	coated	uncoated	WNT / Standard
ZEFP	Ø DC		P M K N S H O	<input type="checkbox"/>	<input type="checkbox"/>	<input type="checkbox"/>	<input type="checkbox"/>			<input type="checkbox"/>	<input type="checkbox"/>		
Intermediate Size Torus End Mills													
	H	4	7-17	<input type="checkbox"/>	<input type="checkbox"/>	<input type="checkbox"/>	<input type="checkbox"/>	<input type="checkbox"/>	<input checked="" type="checkbox"/>	<input type="checkbox"/>	<input type="checkbox"/>	<input type="checkbox"/>	294
Form / Chamfering and Die Sinking / Deburring Cutters													
	W	1	3-6	<input type="checkbox"/>	<input type="checkbox"/>	<input type="checkbox"/>	<input type="checkbox"/>	<input type="checkbox"/>	<input type="checkbox"/>	<input type="checkbox"/>	<input type="checkbox"/>	<input type="checkbox"/>	295
	N	4	4-12	<input type="checkbox"/>	<input type="checkbox"/>	<input type="checkbox"/>	<input type="checkbox"/>	<input type="checkbox"/>	<input type="checkbox"/>	<input type="checkbox"/>	<input type="checkbox"/>	<input type="checkbox"/>	296
	N	4	3-12	<input type="checkbox"/>	<input type="checkbox"/>	<input type="checkbox"/>	<input type="checkbox"/>	<input type="checkbox"/>	<input type="checkbox"/>	<input type="checkbox"/>	<input type="checkbox"/>	<input type="checkbox"/>	297
	N	4	6-10	<input type="checkbox"/>	<input type="checkbox"/>	<input type="checkbox"/>	<input type="checkbox"/>	<input type="checkbox"/>	<input type="checkbox"/>	<input type="checkbox"/>	<input type="checkbox"/>	<input type="checkbox"/>	298
	N	6-10	11-40	<input type="checkbox"/>	<input type="checkbox"/>	<input type="checkbox"/>	<input type="checkbox"/>	<input type="checkbox"/>	<input type="checkbox"/>	<input type="checkbox"/>	<input type="checkbox"/>	<input type="checkbox"/>	299
			3-16	<input type="checkbox"/>	<input type="checkbox"/>	<input type="checkbox"/>	<input type="checkbox"/>	<input type="checkbox"/>	<input type="checkbox"/>	<input type="checkbox"/>	<input type="checkbox"/>	<input type="checkbox"/>	300+301
Circular saw blades													
		24-160	15-200	<input type="checkbox"/>	<input type="checkbox"/>	<input type="checkbox"/>	<input type="checkbox"/>	<input type="checkbox"/>	<input type="checkbox"/>	<input type="checkbox"/>	<input type="checkbox"/>	<input type="checkbox"/>	302-304
		20-80	15-200	<input type="checkbox"/>	<input type="checkbox"/>	<input type="checkbox"/>	<input type="checkbox"/>	<input type="checkbox"/>	<input type="checkbox"/>	<input type="checkbox"/>	<input type="checkbox"/>	<input type="checkbox"/>	305-307
Cylindrical shank adapter for circular saw blades													
				<input type="checkbox"/>	<input type="checkbox"/>	<input type="checkbox"/>	<input type="checkbox"/>	<input type="checkbox"/>	<input type="checkbox"/>	<input type="checkbox"/>	<input type="checkbox"/>	<input type="checkbox"/>	308

Overview Special Milling Cutters

Tool type	Number of flutes	Diameter in mm								Sharp	Corner chamfer	Corner radius	Full Radius	Length	Tool design	Cooling		WNT \ Standard	
		Ø DC	P	M	K	N	S	H	O							coated	uncoated		
Plastics-GFK-CFK- Cutters																			
	W	2-20															<input type="checkbox"/>	<input type="checkbox"/>	310
	W	2-20															<input type="checkbox"/>	<input type="checkbox"/>	311
	W	2-20															<input checked="" type="checkbox"/>	<input type="checkbox"/>	312
	W	5-16									<input checked="" type="checkbox"/>						<input checked="" type="checkbox"/>	<input type="checkbox"/>	313
	W	6-24									<input checked="" type="checkbox"/>						<input checked="" type="checkbox"/>	<input type="checkbox"/>	314
	W	2	2-12														<input checked="" type="checkbox"/>	<input type="checkbox"/>	315
	W	1	1,5-16,0														<input type="checkbox"/>	<input type="checkbox"/>	316
	W	1	1,5-12,0														<input checked="" type="checkbox"/>	<input type="checkbox"/>	317
	W	2	2-12														<input checked="" type="checkbox"/>	<input type="checkbox"/>	318
	W	3	3-12										<input checked="" type="checkbox"/>				<input checked="" type="checkbox"/>	<input type="checkbox"/>	319
	N	2	2-12														<input type="checkbox"/>	<input type="checkbox"/>	320

MonsterMill – End milling cutter

The specialist for machining steel and cast iron

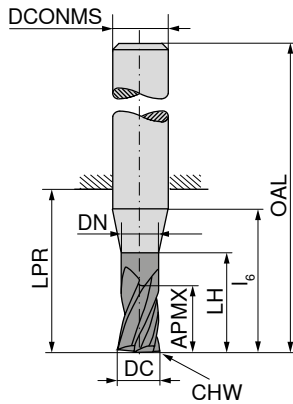
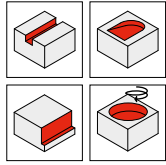
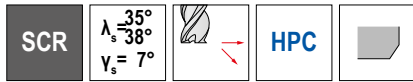

Ti1200 Ti1200 Ti1200 Ti1200



DIN 6527

DIN 6527

DIN 6527

DIN 6527



52 600 ...

52 601 ...

52 602 ...

52 603 ...

DC _{FB}	APMX	DN	LH	l ₆	LPR	OAL	DCONMS ₁₅	CHW	ZEFP	52 600 ...	52 601 ...	52 602 ...	52 603 ...
mm	mm	mm	mm	mm	mm	mm	mm	mm					
3,0	5	2,9	9	14	14	50	6	0,07	4	030	030		
3,0	8	2,9	14	20	22	58	6	0,07	4			030	030
3,5	5	3,4	9	14	14	50	6	0,07	4	035	035		
3,5	8	3,4	14	20	22	58	6	0,07	4			035	035
4,0	8	3,8	12	18	18	54	6	0,07	4	040	040		
4,0	11	3,8	18	20	22	58	6	0,07	4			040	040
4,5	9	4,3	12	18	18	54	6	0,07	4	045	045		
4,5	13	4,3	18	20	22	58	6	0,07	4			045	045
5,0	9	4,8	16	18	18	54	6	0,07	4	050	050		
5,0	13	4,8	19	20	22	58	6	0,07	4			050	050
5,5	9	5,3	16	18	18	54	6	0,07	4	055	055		
5,5	13	5,3	19	20	22	58	6	0,07	4			055	055
6,0	10	5,8		16	18	54	6	0,07	4	060	060		
6,0	13	5,8		20	22	58	6	0,07	4			060	060
6,5	12	6,3	18	20	23	59	8	0,07	4	065	065		
6,5	19	6,3	23	25	28	64	8	0,07	4			065	065
7,0	12	6,8	18	20	23	59	8	0,07	4	070	070		
7,0	19	6,8	23	25	28	64	8	0,07	4			070	070
7,5	12	7,3	18	20	23	59	8	0,12	4	075	075		
7,5	19	7,3	23	25	28	64	8	0,12	4			075	075
8,0	12	7,7		20	23	59	8	0,12	4	080	080		
8,0	19	7,7		25	28	64	8	0,12	4			080	080
8,5	15	8,2	22	24	27	67	10	0,20	4	085	085		
8,5	22	8,2	28	30	33	73	10	0,20	4			085	085
9,0	15	8,7	22	24	27	67	10	0,20	4	090	090		
9,0	22	8,7	28	30	33	73	10	0,20	4			090	090
9,5	15	9,2	22	24	27	67	10	0,20	4	095	095		
9,5	22	9,2	28	30	33	73	10	0,20	4			095	095
10,0	15	9,5		24	27	67	10	0,20	4	100	100		
10,0	22	9,5		30	33	73	10	0,20	4			100	100
11,0	18	10,5	24	26	28	73	12	0,20	4	110	110		
11,0	26	10,5	32	35	39	84	12	0,20	4			110	110
11,5	18	11,0	24	26	28	73	12	0,20	4	115	115		
11,5	26	11,0	32	35	39	84	12	0,20	4			115	115
12,0	18	11,5		26	28	73	12	0,20	4	120	120		
12,0	26	11,5		35	39	84	12	0,20	4			120	120
14,0	21	13,5		28	30	75	14	0,20	4	140	140		
14,0	26	13,5		35	39	84	14	0,20	4			140	140
15,0	24	14,5	30	32	35	83	16	0,20	4	150	150		
15,0	32	14,5	38	40	45	93	16	0,20	4			150	150

P	●	●	●	●
M	○	○	○	○
K	●	●	●	●
N	○	○	○	○
S	○	○	○	○
H	○	○	○	○
O	○	○	○	○

1) Cutter not suitable for full slot milling, use for finishing and trochoidal milling when slotting only!

MonsterMill – End milling cutter

The specialist for machining steel and cast iron

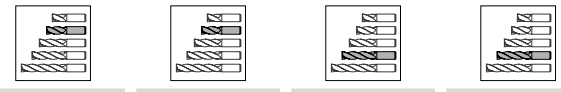
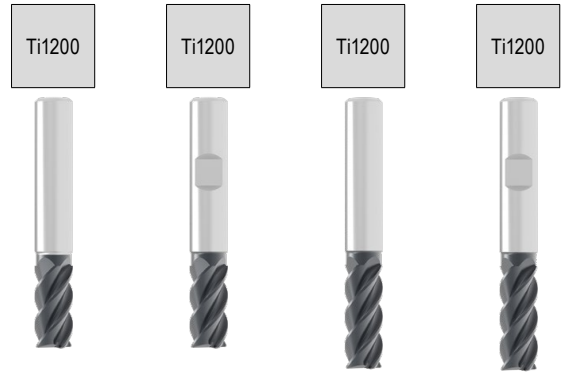
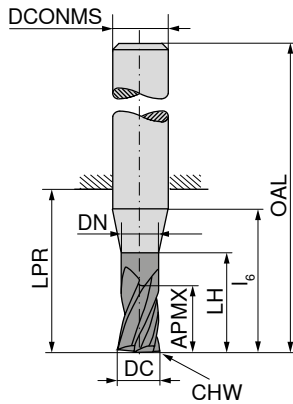
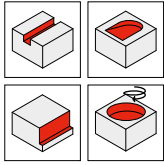
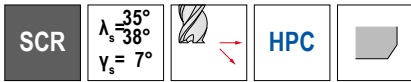

DC ₁₈ mm	APMX mm	DN mm	LH mm	l ₆ mm	LPR mm	OAL mm	DCONMS ₁₅ mm	CHW mm	ZEFP
16,0	24	15,5		32	35	83	16	0,20	4
16,0	24	15,5		32	35	83	16	0,20	5
16,0	32	15,5		40	45	93	16	0,20	5
16,0	32	15,5		40	45	93	16	0,20	4
17,0	32	16,5	48	50	52	100	18	0,20	4
18,0	27	17,5		34	37	85	18	0,20	5
18,0	27	17,5		34	37	85	18	0,20	4
18,0	32	17,5		50	52	100	18	0,20	5
18,0	32	17,5		50	52	100	18	0,20	4
19,0	38	18,5	48	50	54	104	20	0,30	4
19,5	38	19,0	48	50	54	104	20	0,30	4
20,0	30	19,5		40	43	93	20	0,30	5
20,0	30	19,5		40	43	93	20	0,30	4
20,0	38	19,5		50	54	104	20	0,30	4
20,0	38	19,5		50	54	104	20	0,30	5

52 600 ...	52 601 ...	52 602 ...	52 603 ...
160	160		
161 ¹⁾	161 ¹⁾		
		161 ¹⁾	161 ¹⁾
		160	160
			170
181 ¹⁾	181 ¹⁾		
180	180		
		181 ¹⁾	181 ¹⁾
		180	180
			190
			195
201 ¹⁾	201 ¹⁾		
200	200		
		200	200
		201 ¹⁾	201 ¹⁾

P	●	●	●	●
M	○	○	○	○
K	●	●	●	●
N	○	○	○	○
S	○	○	○	○
H	○	○	○	○
O	○	○	○	○

1) Cutter not suitable for full slot milling, use for finishing and trochoidal milling when slotting only!

MonsterMill – End milling cutter

The specialist for machining steel and cast iron

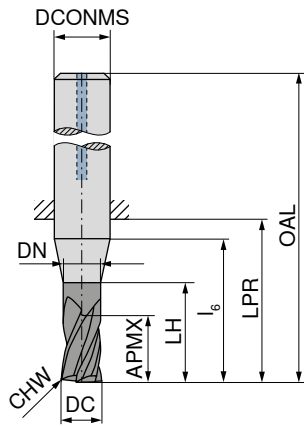
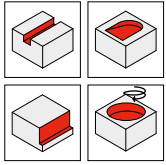
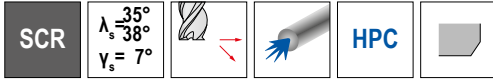

Ti1200



DIN 6527



52 606 ...

DC _{rs} mm	APMX mm	DN mm	LH mm	l ₆ mm	LPR mm	OAL mm	DCONMS _{r5} mm	CHW mm	ZEFP	
3	8	2,9	14	20	22	58	6	0,07	4	030
4	11	3,8	18	20	22	58	6	0,07	4	040
5	13	4,8	19	20	22	58	6	0,07	4	050
6	13	5,8		20	22	58	6	0,07	4	060
8	19	7,7		25	28	64	8	0,12	4	080
10	22	9,5		30	33	73	10	0,20	4	100
12	26	11,5		35	39	84	12	0,20	4	120
16	32	15,5		40	45	93	16	0,20	4	160
20	38	19,5		50	54	104	20	0,30	4	200
P										●
M										○
K										●
N										○
S										○
H										○
O										○

→ v_c/f_z Page 322+323

MonsterMill – End milling cutter

The specialist for machining steel and cast iron

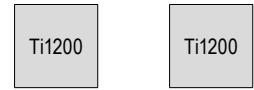
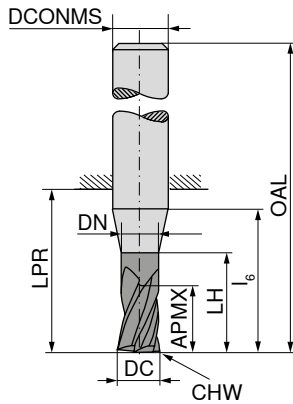
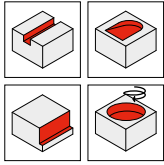

Factory standard Factory standard



DC _{FB} mm	APMX mm	DN mm	LH mm	l ₆ mm	LPR mm	OAL mm	DCONMS _{H5} mm	CHW mm	ZEFP
3	5	2,9	14	20	22	58	6	0,07	4
3	5	2,9	19	23	26	62	6	0,07	4
4	8	3,8	18	20	22	58	6	0,07	4
4	8	3,8	23	25	26	62	6	0,07	4
5	9	4,8	19	20	22	58	6	0,07	4
5	9	4,8	24	25	26	62	6	0,07	4
6	10	5,8		20	22	58	6	0,07	4
6	10	5,8		25	26	62	6	0,07	4
8	12	7,7		25	28	64	8	0,12	4
8	12	7,7		30	32	68	8	0,12	4
10	15	9,5		30	33	73	10	0,20	4
10	15	9,5		35	40	80	10	0,20	4
12	18	11,5		35	39	84	12	0,20	4
12	18	11,5		45	48	93	12	0,20	4
14	21	13,5		35	39	84	14	0,20	4
14	21	13,5		50	54	99	14	0,20	4
16	24	15,5		40	45	93	16	0,20	4
16	24	15,5		40	45	93	16	0,20	5
16	24	15,5		55	60	108	16	0,20	4
16	24	15,5		55	60	108	16	0,20	5
18	27	17,5		50	52	100	18	0,20	4
18	27	17,5		50	52	100	18	0,20	5
18	27	17,5		60	66	114	18	0,20	4
18	27	17,5		60	66	114	18	0,20	5
20	30	19,5		50	54	104	20	0,30	4
20	30	19,5		50	54	104	20	0,30	5
20	30	19,5		70	76	126	20	0,30	4
20	30	19,5		70	76	126	20	0,30	5

52 604 ...	52 605 ...
030	030
040	040
050	050
060	060
080	080
100	100
120	120
140	140
160	160
161 ¹⁾	161 ¹⁾
180	180
181 ¹⁾	181 ¹⁾
200	200
201 ¹⁾	201 ¹⁾

P	●	●
M	○	○
K	●	●
N	○	○
S	○	○
H	○	○
O	○	○

1) Cutter not suitable for full slot milling, use for finishing and trochoidal milling when slotting only!

MonsterMill – End milling cutter with corner radius

The specialist for machining steel and cast iron

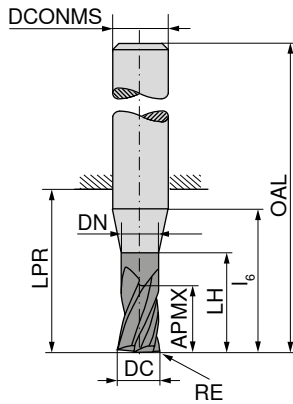
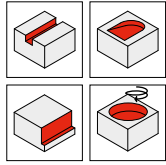
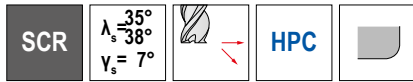

Ti1200



Factory standard



52 607 ...

DC _{FB}	RE _{±0.01}	APMX	DN	LH	l ₆	LPR	OAL	DCONMS _{H5}	ZEFP	
mm	mm	mm	mm	mm	mm	mm	mm	mm		
3	0,10	8	2,9	14	20	22	58	6	4	030
3	0,30	8	2,9	14	20	22	58	6	4	031
3	0,50	8	2,9	14	20	22	58	6	4	032
4	0,10	11	3,8	18	20	22	58	6	4	040
4	0,40	11	3,8	18	20	22	58	6	4	041
4	0,50	11	3,8	18	20	22	58	6	4	042
5	0,10	13	4,8	19	20	22	58	6	4	050
5	0,50	13	4,8	19	20	22	58	6	4	051
5	1,00	13	4,8	19	20	22	58	6	4	052
6	0,10	13	5,8		20	22	58	6	4	060
6	0,50	13	5,8		20	22	58	6	4	061
6	1,00	13	5,8		20	22	58	6	4	062
8	0,15	19	7,7		25	28	64	8	4	080
8	0,50	19	7,7		25	28	64	8	4	081
8	1,00	19	7,7		25	28	64	8	4	082
8	2,00	19	7,7		25	28	64	8	4	083
10	0,15	22	9,5		30	33	73	10	4	100
10	0,50	22	9,5		30	33	73	10	4	101
10	1,00	22	9,5		30	33	73	10	4	102
10	1,50	22	9,5		30	33	73	10	4	103
10	2,00	22	9,5		30	33	73	10	4	104
12	0,20	26	11,5		35	39	84	12	4	120
12	0,50	26	11,5		35	39	84	12	4	121
12	1,00	26	11,5		35	39	84	12	4	122
12	1,50	26	11,5		35	39	84	12	4	123
12	2,00	26	11,5		35	39	84	12	4	124
14	1,00	26	13,5		35	39	84	14	4	140
16	0,30	32	15,5		40	45	93	16	4	160
16	0,50	32	15,5		40	45	93	16	4	161
16	1,00	32	15,5		40	45	93	16	4	162
16	2,00	32	15,5		40	45	93	16	4	163
16	4,00	32	15,5		40	45	93	16	4	164
20	0,30	38	19,5		50	54	104	20	4	200
20	0,50	38	19,5		50	54	104	20	4	201
20	1,00	38	19,5		50	54	104	20	4	202
20	2,00	38	19,5		50	54	104	20	4	203



P	●
M	○
K	●
N	○
S	○
H	○
O	○

→ v_c/f_z Page 322+323

MonsterMill – End milling cutter

The specialist for machining steel and cast iron

SCR $\lambda_s = 35^\circ$
 $\lambda_s = 38^\circ$
 $\gamma_s = 7^\circ$

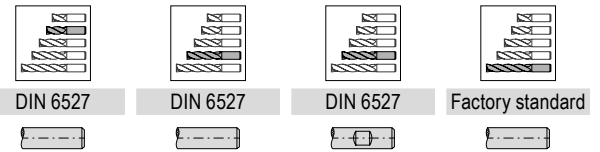
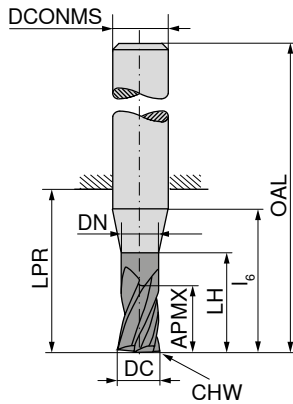
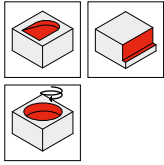
DC _{r8} mm	APMX mm	DN mm	LH mm	l ₆ mm	LPR mm	OAL mm	DCONMS _{r5} mm	CHW mm	ZEFP
5	9	4,8	16	18	18	54	6	0,12	6
5	13	4,8	19	20	22	58	6	0,12	6
5	13	4,8	24	25	26	62	6	0,12	6
6	10	5,8		16	18	54	6	0,12	6
6	13	5,8		20	22	58	6	0,12	6
6	13	5,8		25	26	62	6	0,12	6
8	12	7,7		20	23	59	8	0,12	6
8	19	7,7		25	28	64	8	0,12	6
8	19	7,7		30	32	68	8	0,12	6
10	15	9,5		24	27	67	10	0,20	6
10	22	9,5		30	33	73	10	0,20	6
10	22	9,5		35	40	80	10	0,20	6
12	18	11,5		26	28	73	12	0,20	6
12	26	11,5		35	39	84	12	0,20	6
12	26	11,5		45	48	93	12	0,20	6
16	24	15,5		32	35	83	16	0,20	6
16	32	15,5		40	45	93	16	0,20	6
16	32	15,5		55	60	108	16	0,20	6
20	30	19,5		40	43	93	20	0,30	6
20	38	19,5		50	54	104	20	0,30	6
20	38	19,5		70	76	126	20	0,30	6

52 608 ...	52 608 ...	52 608 ...	52 608 ...
050			
	051		
			052
060			
	061		
			062
080			
	081		
			082
100			
	101	103	
			102
120			
	121	123	
			122
160			
	161	163	
			162
200			
	201	203	
			202

P	●	●	●	●
M	○	○	○	○
K	●	●	●	●
N	○	○	○	○
S	○	○	○	○
H	○	○	○	○
O	○	○	○	○

→ v_c/f_z Page 322–325

MonsterMill – Ball Nosed Cutter

The specialist for machining steel and cast iron

▲ Radius accuracy: - 0,015 mm for $\varnothing \leq 6,0$ mm / - 0,02 mm for $\varnothing > 6,0$ mm

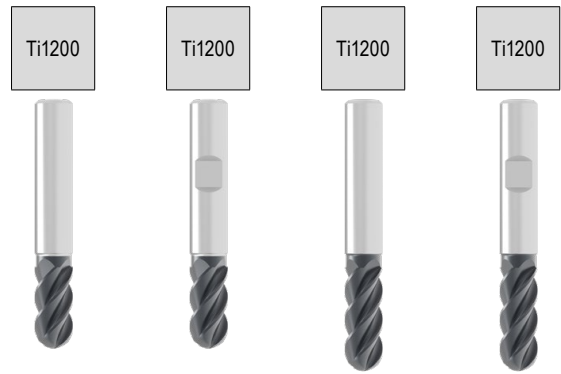
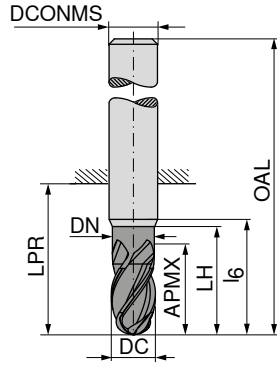
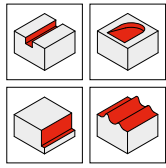
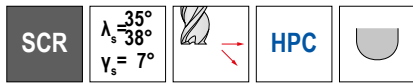

DC _{r8} mm	APMX mm	DN mm	LH mm	l ₆ mm	LPR mm	OAL mm	DCONMS _{r5} mm	ZEFP
3	5	2,9	9	14	14	50	6	3
3	8	2,9	14	20	22	58	6	3
4	8	3,8	12	18	18	54	6	3
4	11	3,8	18	20	22	58	6	3
5	9	4,8	16	18	18	54	6	3
5	13	4,8	19	20	22	58	6	3
6	10	5,8		16	18	54	6	4
6	13	5,8		20	22	58	6	4
8	12	7,7		20	23	59	8	4
8	19	7,7		25	28	64	8	4
10	15	9,5		24	27	67	10	4
10	22	9,5		30	33	73	10	4
12	18	11,5		26	28	73	12	4
12	26	11,5		35	39	84	12	4
16	24	15,5		32	35	83	16	4
16	32	15,5		40	45	93	16	4

52 611 ...	52 611 ...	52 612 ...	52 612 ...
030		030	
040		040	
050		050	
060	061	060	061
080	081	080	081
100	101	100	101
120	121	120	121
160	161	160	161

P	●	●	●	●
M	○	○	○	○
K	●	●	●	●
N	○	○	○	○
S	○	○	○	○
H	○	○	○	○
O	○	○	○	○

→ v_c/f_z Page 322+323

MonsterMill – Torus Face Milling Cutter

The specialist for machining steel and cast iron

▲ r_{3D} = programmed corner radius

▲ For HFC machining: APMX does not correspond to the maximum cutting depth

SCR $\lambda_s = 45^\circ$
 $\gamma_s = 7^\circ$

HFC HPC ≤ 60 HRC

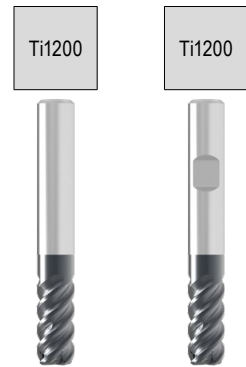
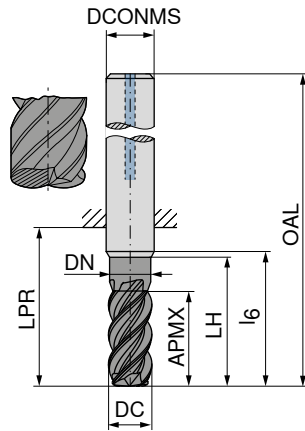
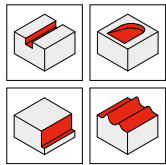

DIN 6527 DIN 6527

52 609 ... 52 609 ...

DC _{-0.04} mm	r_{3D} mm	APMX mm	DN mm	LH mm	LPR mm	OAL mm	l_6 mm	DCONMS _{h5} mm	T_{max} mm	ZEFP		
3	0,4	3	2,9	14,00	21	57	20	6	0,10	4		030
4	0,5	4	3,8	18,00	21	57	20	6	0,15	4		040
5	0,6	5	4,8	18,00	21	57	20	6	0,20	4		050
6	0,8	13	5,8	19,90	21	57	20	6	0,20	4		060
8	1,0	19	7,7	24,85	27	63	25	8	0,30	4		080
10	1,2	22	9,5	29,75	32	72	30	10	0,40	4		100
12	1,6	26	11,5	34,75	38	83	35	12	0,40	4		120
16	2,2	32	15,5	39,75	44	92	40	16	0,50	4		160
P												●
M												●
K												●
N												○
S												○
H												○
O												○

→ v_c/f_z Page 326–328

MonsterMill – End milling cutter

The specialist for machining stainless steel

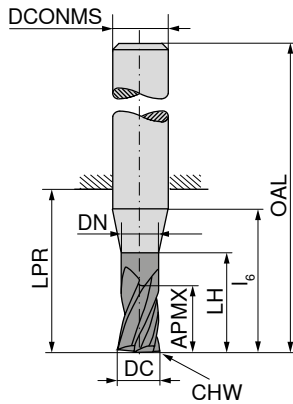
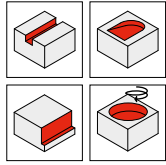
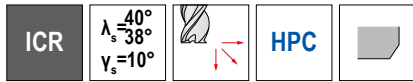

DIN 6527



Factory standard



Factory standard



52 784 ...

52 784 ...

52 784 ...

DC _{es}	APMX	DN	LH	l ₆	LPR	OAL	DCONMS ₁₆	CHW	ZEFP
mm	mm	mm	mm	mm	mm	mm	mm	mm	
1,5	2,3	1,4	6	14	21	57	6	0,04	3
2,0	3,0	1,9	8	15	21	57	6	0,04	3
2,5	3,8	2,4	10	16	21	57	6	0,07	3
3,0	5,0	2,9	14	18	21	57	6	0,07	3
3,0	8,0	2,9	14	18	21	57	6	0,07	3
3,0	5,0	2,9	19	23	26	62	6	0,07	3
4,0	8,0	3,8	18	20	21	57	6	0,07	3
4,0	11,0	3,8	18	20	21	57	6	0,07	3
4,0	8,0	3,8	23	25	26	62	6	0,07	3
5,0	9,0	4,8	19	20	21	57	6	0,12	3
5,0	13,0	4,8	19	20	21	57	6	0,12	3
5,0	9,0	4,8	24	25	26	62	6	0,12	3
6,0	10,0	5,8	20		21	57	6	0,12	4
6,0	13,0	5,8	20		21	57	6	0,12	4
6,0	10,0	5,8	25		26	62	6	0,12	4
8,0	12,0	7,7	25		27	63	8	0,12	4
8,0	19,0	7,7	25		27	63	8	0,12	4
8,0	12,0	7,7	30		32	68	8	0,12	4
10,0	15,0	9,5	30		32	72	10	0,20	4
10,0	22,0	9,5	30		32	72	10	0,20	4
10,0	15,0	9,5	35		40	80	10	0,20	4
12,0	18,0	11,5	35		38	83	12	0,20	4
12,0	26,0	11,5	35		38	83	12	0,20	4
12,0	18,0	11,5	45		48	93	12	0,20	4
14,0	21,0	13,5	35		38	83	14	0,20	4
14,0	26,0	13,5	35		38	83	14	0,20	4
14,0	21,0	13,5	50		54	99	14	0,20	4
16,0	24,0	15,5	40		44	92	16	0,20	4
16,0	24,0	15,5	40		44	92	16	0,20	5
16,0	32,0	15,5	40		44	92	16	0,20	4
16,0	32,0	15,5	40		44	92	16	0,20	5
16,0	24,0	15,5	55		60	108	16	0,20	4
16,0	24,0	15,5	55		60	108	16	0,20	5
18,0	27,0	17,5	40		44	92	18	0,20	4
18,0	27,0	17,5	40		44	92	18	0,20	5
18,0	32,0	17,5	40		44	92	18	0,20	4
18,0	32,0	17,5	40		44	92	18	0,20	5
18,0	27,0	17,5	60		66	114	18	0,20	4
18,0	27,0	17,5	60		66	114	18	0,20	5
20,0	30,0	19,5	50		54	104	20	0,30	4
20,0	30,0	19,5	50		54	104	20	0,30	5
20,0	38,0	19,5	50		54	104	20	0,30	4
20,0	38,0	19,5	50		54	104	20	0,30	5
20,0	30,0	19,5	70		76	126	20	0,30	4
20,0	30,0	19,5	70		76	126	20	0,30	5

52 784 ...	52 784 ...	52 784 ...
017		
022		
027		
032		
	034	
042		036
	044	
		046
052		
	054	
		056
062		
	064	
		066
082		
	084	
		086
102		
	104	
		106
122		
	124	
		126
142		
	144	
		146
161		
162 ¹⁾		
	163	
	164 ¹⁾	
		165
		166 ¹⁾
181		
182 ¹⁾		
	183	
	184 ¹⁾	
		185
		186 ¹⁾
201		
202 ¹⁾		
	203	
	204 ¹⁾	
		205
		206 ¹⁾

P	○	○	○
M	●	●	●
K	○	○	○
N	○	○	○
S	●	●	●
H	○	○	○
O	○	○	○

1) Cutter not suitable for full slot milling, use for finishing and trochoidal milling when slotting only!

MonsterMill – End milling cutter

The specialist for machining stainless steel

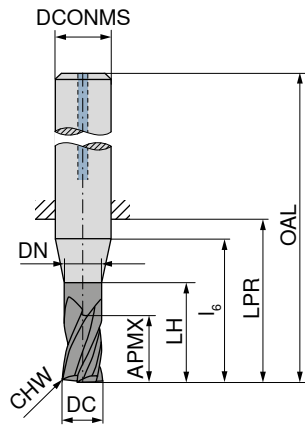
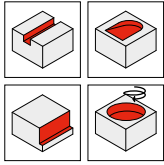
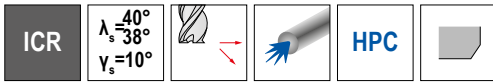

Ti1500



DIN 6527



52 786 ...

DC _{es} mm	APMX mm	DN mm	LH mm	l ₆ mm	LPR mm	OAL mm	DCONMS _{H6} mm	CHW mm	ZEFP	
3	8	2,9	14	18	21	57	6	0,07	3	034
4	11	3,8	18	20	21	57	6	0,07	3	044
5	13	4,8	19	20	21	57	6	0,12	3	054
6	13	5,8	20		21	57	6	0,12	4	064
8	19	7,7	25		27	63	8	0,12	4	084
10	22	9,5	30		32	72	10	0,20	4	104
12	26	11,5	35		38	83	12	0,20	4	124
14	26	13,5	35		38	83	14	0,20	4	144
16	32	15,5	40		44	92	16	0,20	4	163
16	32	15,5	40		44	92	16	0,20	5	164 ¹⁾
18	32	17,5	40		44	92	18	0,20	4	183
18	32	17,5	40		44	92	18	0,20	5	184 ¹⁾
20	38	19,5	50		54	104	20	0,30	4	203
20	38	19,5	50		54	104	20	0,30	5	204 ¹⁾

P	○
M	●
K	○
N	○
S	●
H	○
O	○

1) Cutter not suitable for full slot milling, use for finishing and trochoidal milling when slotting only!

MonsterMill – End milling cutter with corner radius

The specialist for machining titanium and titanium alloys

▲ PRFRAD3 = 1 mm

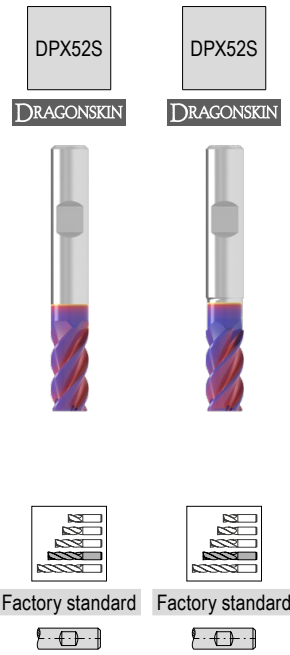
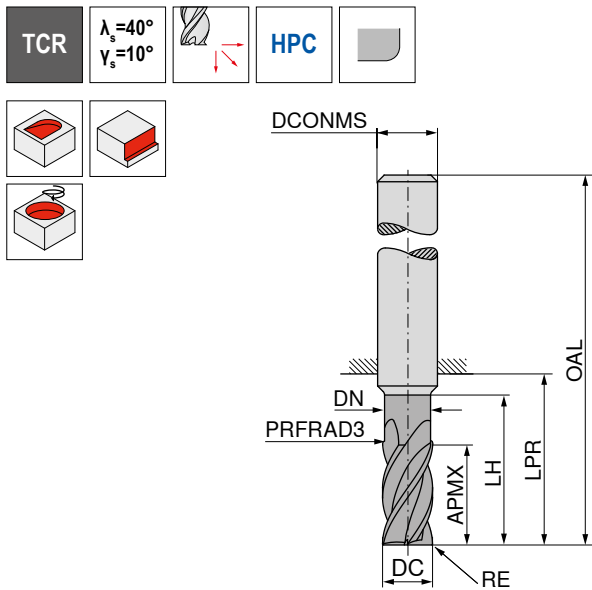

DC _{e8} mm	RE mm	APMX mm	DN mm	LH mm	LPR mm	OAL mm	DCONMS _{h5} mm	ZEFP	52 504 ...	52 506 ...
4	0,1	11		14	21	57	6	4	04000	
4	0,1	11	3,8	17	21	57	6	5		04000 ¹⁾
5	0,1	13		16	21	57	6	4	05000	
5	0,1	13	4,8	19	21	57	6	5		05000 ¹⁾
6	0,1	13			21	57	6	4	06000	
6	0,1	13	5,8	19	21	57	6	5		06000 ¹⁾
8	0,2	21			27	63	8	4	08000	
8	0,2	21	7,7	25	27	63	8	5		08000 ¹⁾
10	0,2	22			32	72	10	4	10000	
10	0,2	22	9,7	30	32	72	10	5		10000 ¹⁾
12	0,2	26			38	83	12	4	12000	
12	0,2	26	11,6	36	38	83	12	5		12000 ¹⁾
16	0,3	36			44	92	16	4	16000	
16	0,3	36	15,5	42	44	92	16	5		16000 ¹⁾
20	0,3	41			54	104	20	4	20000	
20	0,3	41	19,5	52	54	104	20	5		20000 ¹⁾
P									○	○
M									○	○
K										
N										
S									●	●
H										
O										

1) Cutter not suitable for full slot milling, use for finishing and trochoidal milling when slotting only!

→ v_c/f_z Page 336+337

MonsterMill – End milling cutter with corner radius

The specialist for machining titanium and titanium alloys

▲ PRFRAD3 = 1 mm

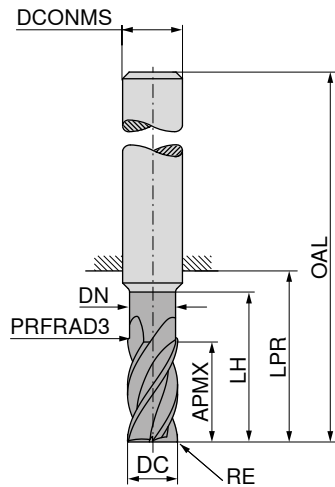
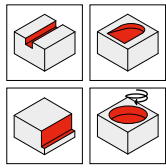
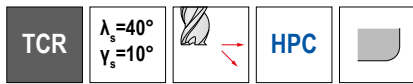

DC _{es} mm	RE mm	APMX mm	DN mm	LH mm	LPR mm	OAL mm	DCONMS ₀₅ mm	ZEFP
4	0,4	8,5	3,8	20	26	62	6	4
4	0,5	8,5	3,8	20	26	62	6	4
4	0,8	8,5	3,8	20	26	62	6	4
4	0,2	11,0		14	21	57	6	4
4	0,4	11,0		14	21	57	6	4
4	0,5	11,0		14	21	57	6	4
5	0,5	10,5	4,8	25	34	70	6	4
5	0,8	10,5	4,8	25	34	70	6	4
5	0,5	13,0		16	21	57	6	4
5	1,0	13,0		16	21	57	6	4
6	0,4	13,0			21	57	6	4
6	0,5	13,0			21	57	6	4
6	0,6	13,0			21	57	6	4
6	0,6	13,0	5,8	30	34	70	6	4
6	0,8	13,0			21	57	6	4
6	0,8	13,0	5,8	30	34	70	6	4
6	1,0	13,0			21	57	6	4
6	1,0	13,0	5,8	30	34	70	6	4
6	1,5	13,0			21	57	6	4
8	0,8	17,0	7,7	40	44	80	8	4
8	1,0	17,0	7,7	40	44	80	8	4
8	1,5	17,0	7,7	40	44	80	8	4
8	2,0	17,0	7,7	40	44	80	8	4
8	0,5	21,0			27	63	8	4
8	0,8	21,0			27	63	8	4
8	1,0	21,0			27	63	8	4
8	1,2	21,0			27	63	8	4
8	1,5	21,0			27	63	8	4
8	2,0	21,0			27	63	8	4
10	0,5	21,0	9,7	50	54	94	10	4
10	1,0	21,0	9,7	50	54	94	10	4
10	1,5	21,0	9,7	50	54	94	10	4
10	2,0	21,0	9,7	50	54	94	10	4
10	0,5	22,0			32	72	10	4
10	1,0	22,0			32	72	10	4
10	1,2	22,0			32	72	10	4
10	1,5	22,0			32	72	10	4
10	1,6	22,0			32	72	10	4
10	2,0	22,0			32	72	10	4
12	0,5	25,0	11,6	60	65	110	12	4
12	1,0	25,0	11,6	60	65	110	12	4

P	○	○
M	○	○
K		
N		
S	●	●
H		
O		

52 508 ...	52 508 ...
	04104
	04105
	04108
04002	
04004	
04005	
	05105
	05108
05005	
05010	
06004	
06005	
06006	
	06106
06008	
	06108
06010	
	06110
06015	
	08108
	08110
	08115
	08120
08005	
08008	
08010	
08012	
08015	
08020	
	10105
	10110
	10115
	10120
10005	
10010	
10012	
10015	
10016	
10020	
	12105
	12110

MonsterMill – End milling cutter with corner radius

The specialist for machining titanium and titanium alloys

▲ PRFRAD3 = 1 mm

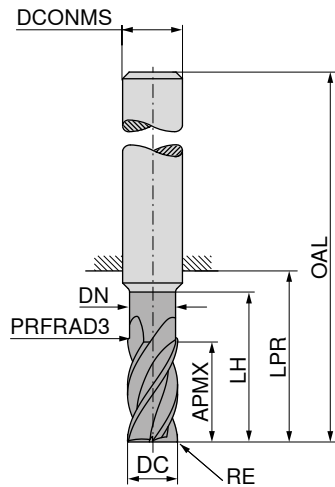
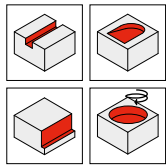
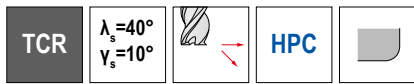

DC _{es} mm	RE mm	APMX mm	DN mm	LH mm	LPR mm	OAL mm	DCONMS ₀₅ mm	ZEFP
12	1,5	25,0	11,6	60	65	110	12	4
12	2,0	25,0	11,6	60	65	110	12	4
12	3,0	25,0	11,6	60	65	110	12	4
12	4,0	25,0	11,6	60	65	110	12	4
12	0,5	26,0			38	83	12	4
12	1,0	26,0			38	83	12	4
12	1,2	26,0			38	83	12	4
12	1,5	26,0			38	83	12	4
12	1,6	26,0			38	83	12	4
12	2,0	26,0			38	83	12	4
12	2,5	26,0			38	83	12	4
12	3,0	26,0			38	83	12	4
14	1,0	29,0	13,6	70	75	120	14	4
14	2,0	29,0	13,6	70	75	120	14	4
14	3,0	29,0	13,6	70	75	120	14	4
14	4,0	29,0	13,6	70	75	120	14	4
16	1,0	33,0	15,5	80	84	132	16	4
16	2,0	33,0	15,5	80	84	132	16	4
16	3,0	33,0	15,5	80	84	132	16	4
16	4,0	33,0	15,5	80	84	132	16	4
16	1,0	36,0			44	92	16	4
16	1,6	36,0			44	92	16	4
16	2,0	36,0			44	92	16	4
16	2,5	36,0			44	92	16	4
16	3,0	36,0			44	92	16	4
16	3,2	36,0			44	92	16	4
16	4,0	36,0			44	92	16	4
18	1,0	38,0	17,5	90	94	142	18	4
18	2,0	38,0	17,5	90	94	142	18	4
18	3,0	38,0	17,5	90	94	142	18	4
18	4,0	38,0	17,5	90	94	142	18	4
20	2,0	41,0			54	104	20	4
20	3,0	41,0			54	104	20	4
20	4,0	41,0			54	104	20	4
20	5,0	41,0			54	104	20	4
20	6,3	41,0			54	104	20	4
20	1,0	42,0	19,5	100	104	154	20	4
20	2,0	42,0	19,5	100	104	154	20	4
20	3,0	42,0	19,5	100	104	154	20	4
20	4,0	42,0	19,5	100	104	154	20	4

52 508 ...	52 508 ...
	12115
	12120
	12130
	12140
12005	
12010	
12012	
12015	
12016	
12020	
12025	
12030	
	14110
	14120
	14130
	14140
	16110
	16120
	16130
	16140
16010	
16016	
16020	
16025	
16030	
16032	
16040	
	18110
	18120
	18130
	18140
20020	
20030	
20040	
20050	
20063	
	20110
	20120
	20130
	20140

P	○	○
M	○	○
K		
N		
S	●	●
H		
O		

MonsterMill – Ball Nosed Cutter

The specialist for machining titanium and titanium alloys

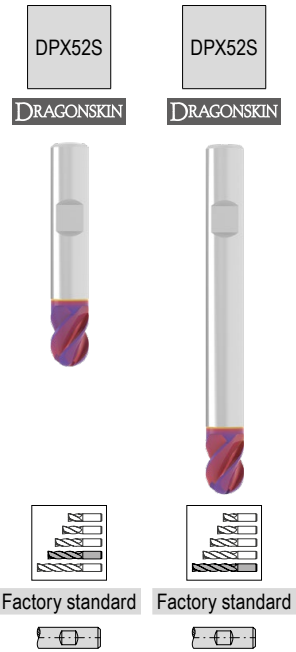
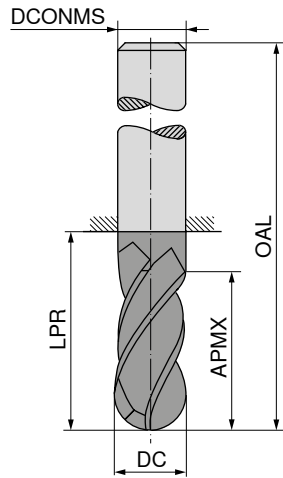
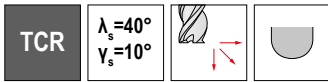

DC _{e8} mm	APMX mm	LPR mm	OAL mm	DCONMS _{h5} mm	ZEPF
2	4	18	54	6	4
2	4	44	80	6	4
3	5	18	54	6	4
3	5	44	80	6	4
4	8	18	54	6	4
4	8	44	80	6	4
5	9	18	54	6	4
5	9	44	80	6	4
6	10	18	54	6	4
6	10	44	80	6	4
8	12	22	58	8	4
8	12	64	100	8	4
10	14	26	66	10	4
10	14	60	100	10	4
12	16	28	73	12	4
12	16	55	100	12	4
16	20	34	82	16	4
16	20	52	100	16	4

	52 514 ...	52 514 ...
P	○	○
M	○	○
K		
N		
S	●	●
H		
O		

→ v_c/f_z Page 338+339

MonsterMill – Torus Face Milling Cutter

The specialist for machining titanium and titanium alloys

▲ r_{30} = programmed corner radius

▲ APMX does not correspond to the maximum cutting depth

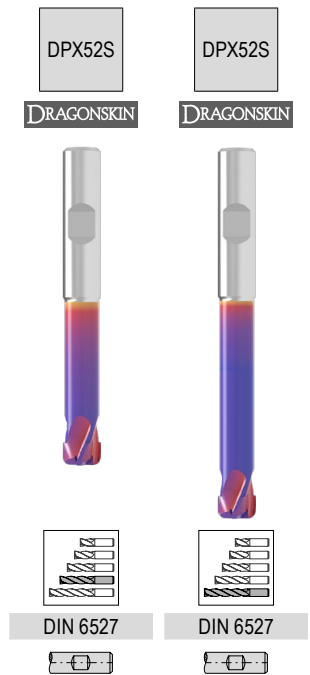
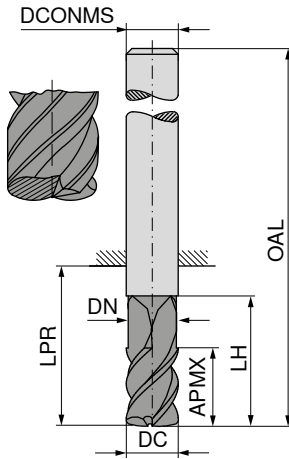

DC _{e8} mm	r_{30} mm	APMX mm	DN mm	LH mm	LPR mm	OAL mm	DCONMS _{H5} mm	ZEFP
2	0,3	1,5	1,7	13	18	54	6	2
2	0,3	1,5	1,7	18	39	75	6	2
3	0,3	1,5	2,7	15	18	54	6	2
3	0,3	1,5	2,7	20	39	75	6	2
4	0,5	2,5	3,6	16	22	58	6	2
4	0,5	2,5	3,6	24	49	85	6	2
5	0,5	3,5	4,6	18	29	65	6	4
5	0,5	3,5	4,6	28	64	100	6	4
6	1,0	3,5	5,2	20	29	65	6	4
6	1,0	3,5	5,2	28	64	100	6	4
8	1,5	4,8	7,0	24	34	70	8	5
8	1,5	4,8	7,0	40	64	100	8	5
10	2,0	5,8	9,0	26	45	85	10	5
10	2,0	5,8	9,0	48	60	100	10	5
12	2,0	6,8	11,0	30	48	93	12	5
12	2,0	6,8	11,0	56	75	120	12	5
16	2,5	8,8	14,5	35	52	100	16	5
16	2,5	8,8	14,5	65	102	150	16	5

52 512 ...	52 512 ...
02000	02100
03000	03100
04000	04100
05000	05100
06000	06100
08000	08100
10000	10100
12000	12100
16000	16100

P	○	○
M	○	○
K		
N		
S	●	●
H		
O		

→ v_c/f_z Page 338

MonsterMill – End milling cutter with corner radius

The specialist for machining nickel-based alloys

▲ PRFRAD3 = 1 mm

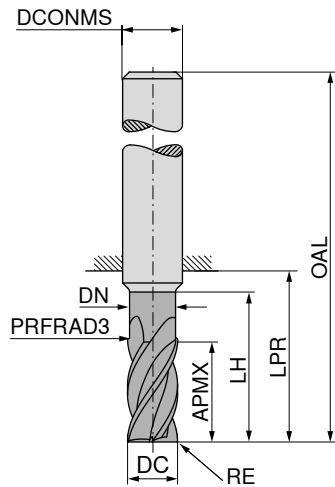
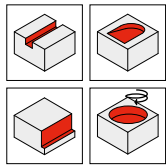
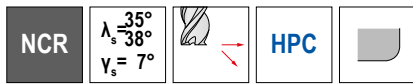

DPA52S

DRAGONSKIN



Factory standard



53 030 ...

DC ₁₈ mm	RE mm	APMX mm	DN mm	LH mm	LPR mm	OAL mm	DCONMS ₁₅ mm	ZEFP	
4	0,1	11	3,8	17	21	57	6	4	04201
4	0,2	11	3,8	17	21	57	6	4	04202
4	0,4	11	3,8	17	21	57	6	4	04204
4	0,5	11	3,8	17	21	57	6	4	04205
5	0,1	13	4,8	19	21	57	6	4	05201
5	0,5	13	4,8	19	21	57	6	4	05205
5	1,0	13	4,8	19	21	57	6	4	05210
6	0,1	13	5,8	19	21	57	6	4	06201
6	0,4	13	5,8	19	21	57	6	4	06204
6	0,5	13	5,8	19	21	57	6	4	06205
6	0,6	13	5,8	19	21	57	6	4	06206
6	0,8	13	5,8	19	21	57	6	4	06208
6	1,0	13	5,8	19	21	57	6	4	06210
6	1,5	13	5,8	19	21	57	6	4	06215
8	0,2	19	7,7	25	27	63	8	4	08202
8	0,5	21	7,7	25	27	63	8	4	08205
8	0,8	21	7,7	25	27	63	8	4	08208
8	1,0	21	7,7	25	27	63	8	4	08210
8	1,2	21	7,7	25	27	63	8	4	08212
8	1,5	21	7,7	25	27	63	8	4	08215
8	2,0	21	7,7	25	27	63	8	4	08220
10	0,2	22	9,7	30	32	72	10	4	10202
10	0,5	22	9,7	30	32	72	10	4	10205
10	1,0	22	9,7	30	32	72	10	4	10210
10	1,2	22	9,7	30	32	72	10	4	10212
10	1,5	22	9,7	30	32	72	10	4	10215
10	1,6	22	9,7	30	32	72	10	4	10216
10	2,0	22	9,7	30	32	72	10	4	10220
12	0,2	26	11,6	36	38	83	12	4	12202
12	0,5	26	11,6	36	38	83	12	4	12205
12	1,0	26	11,6	36	38	83	12	4	12210
12	1,2	26	11,6	36	38	83	12	4	12212
12	1,5	26	11,6	36	38	83	12	4	12215
12	1,6	26	11,6	36	38	83	12	4	12216
12	2,0	26	11,6	36	38	83	12	4	12220
12	2,5	26	11,6	36	38	83	12	4	12225
12	3,0	26	11,6	36	38	83	12	4	12230

P	
M	○
K	
N	
S	●
H	
O	

MonsterMill – End milling cutter with corner radius

The specialist for machining nickel-based alloys

▲ PRFRAD3 = 1 mm

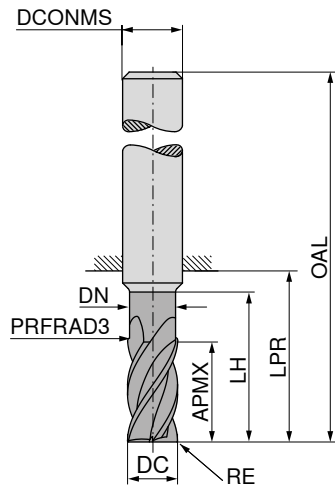
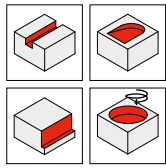
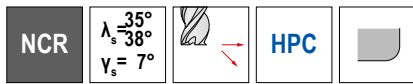

DPA52S

DRAGONSKIN



Factory standard



53 030 ...

DC ₁₈ mm	RE mm	APMX mm	DN mm	LH mm	LPR mm	OAL mm	DCONMS _{h5} mm	ZEFP	
16	0,3	36	15,5	42	44	92	16	4	16203
16	1,0	36	15,5	42	44	92	16	4	16210
16	1,6	36	15,5	42	44	92	16	4	16216
16	2,0	36	15,5	42	44	92	16	4	16220
16	2,5	36	15,5	42	44	92	16	4	16225
16	3,0	36	15,5	42	44	92	16	4	16230
16	3,2	36	15,5	42	44	92	16	4	16232
16	4,0	36	15,5	42	44	92	16	4	16240
20	0,3	41	19,5	52	54	104	20	4	20203
20	1,0	41	19,5	52	54	104	20	4	20210
20	2,0	41	19,5	52	54	104	20	4	20220
20	3,0	41	19,5	52	54	104	20	4	20230
20	4,0	41	19,5	52	54	104	20	4	20240
20	5,0	41	19,5	52	54	104	20	4	20250
20	6,3	41	19,5	52	54	104	20	4	20263

P
M
K
N
S
H
O

→ v_c/f_z Page 340+341

MonsterMill – End milling cutter with corner radius

The specialist for machining nickel-based alloys

▲ PRFRAD3 = 1 mm

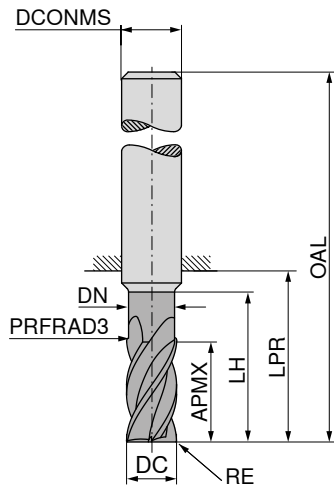
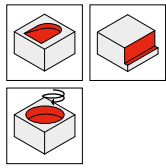
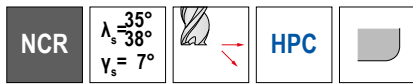

DPA52S

DRAGONSKIN



Factory standard



53 030 ...

DC ₁₈ mm	RE mm	APMX mm	DN mm	LH mm	LPR mm	OAL mm	DCONMS _{h5} mm	ZEFP	
4	0,1	8,5	3,8	20	26	62	6	4	04401
4	0,2	8,5	3,8	20	26	62	6	4	04402
4	0,4	8,5	3,8	20	26	62	6	4	04404
4	0,5	8,5	3,8	20	26	62	6	4	04405
5	0,1	10,5	4,8	25	34	70	6	4	05401
5	0,5	10,5	4,8	25	34	70	6	4	05405
5	1,0	10,5	4,8	25	34	70	6	4	05410
6	0,1	13,0	5,8	30	34	70	6	4	06401
6	0,4	13,0	5,8	30	34	70	6	4	06404
6	0,5	13,0	5,8	30	34	70	6	4	06405
6	0,6	13,0	5,8	30	34	70	6	4	06406
6	0,8	13,0	5,8	30	34	70	6	4	06408
6	1,0	13,0	5,8	30	34	70	6	4	06410
6	1,5	13,0	5,8	30	34	70	6	4	06415
8	0,2	17,0	7,7	40	44	80	8	4	08402
8	0,5	17,0	7,7	40	44	80	8	4	08405
8	0,8	17,0	7,7	40	44	80	8	4	08408
8	1,0	17,0	7,7	40	44	80	8	4	08410
8	1,2	17,0	7,7	40	44	80	8	4	08412
8	1,5	17,0	7,7	40	44	80	8	4	08415
8	2,0	17,0	7,7	40	44	80	8	4	08420
10	0,2	21,0	9,7	50	54	94	10	4	10402
10	0,5	21,0	9,7	50	54	94	10	4	10405
10	1,0	21,0	9,7	50	54	94	10	4	10410
10	1,2	21,0	9,7	50	54	94	10	4	10412
10	1,5	21,0	9,7	50	54	94	10	4	10415
10	1,6	21,0	9,7	50	54	94	10	4	10416
10	2,0	21,0	9,7	50	54	94	10	4	10420
12	0,2	25,0	11,6	60	65	110	12	4	12402
12	0,5	25,0	11,6	60	65	110	12	4	12405
12	1,0	25,0	11,6	60	65	110	12	4	12410
12	1,2	25,0	11,6	60	65	110	12	4	12412
12	1,5	25,0	11,6	60	65	110	12	4	12415
12	1,6	25,0	11,6	60	65	110	12	4	12416
12	2,0	25,0	11,6	60	65	110	12	4	12420
12	2,5	25,0	11,6	60	65	110	12	4	12425
12	3,0	25,0	11,6	60	65	110	12	4	12430

P	
M	○
K	
N	
S	●
H	
O	

MonsterMill – End milling cutter with corner radius

The specialist for machining nickel-based alloys

▲ PRFRAD3 = 1 mm

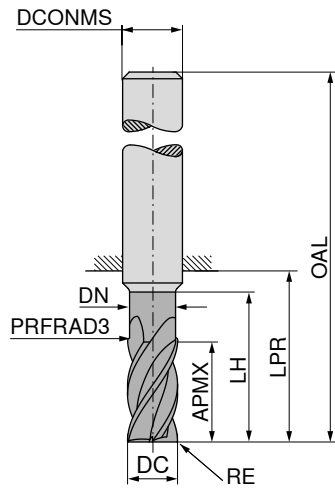
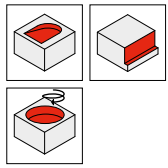
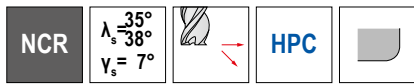

DPA52S

DRAGONSKIN



Factory standard



53 030 ...

DC ₁₈ mm	RE mm	APMX mm	DN mm	LH mm	LPR mm	OAL mm	DCONMS _{h5} mm	ZEFP	
16	0,3	33,0	15,5	80	84	132	16	4	16403
16	1,0	33,0	15,5	80	84	132	16	4	16410
16	1,6	33,0	15,5	80	84	132	16	4	16416
16	2,0	33,0	15,5	80	84	132	16	4	16420
16	2,5	33,0	15,5	80	84	132	16	4	16425
16	3,0	33,0	15,5	80	84	132	16	4	16430
16	3,2	33,0	15,5	80	84	132	16	4	16432
16	4,0	33,0	15,5	80	84	132	16	4	16440
20	0,3	42,0	19,5	100	104	154	20	4	20403
20	1,0	42,0	19,5	100	104	154	20	4	20410
20	2,0	42,0	19,5	100	104	154	20	4	20420
20	3,0	42,0	19,5	100	104	154	20	4	20430
20	4,0	42,0	19,5	100	104	154	20	4	20440
20	5,0	42,0	19,5	100	104	154	20	4	20450
20	6,3	42,0	19,5	100	104	154	20	4	20463

P	
M	○
K	
N	
S	●
H	
O	

→ v_c/f_z Page 342+343

MonsterMill – End milling cutter with corner radius

The specialist for machining nickel-based alloys

▲ PRFRAD3 = 1 mm

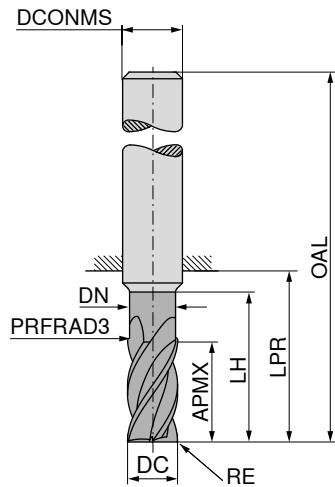
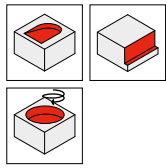
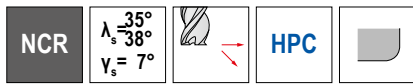

DPA52S

DRAGONSKIN



Factory standard



53 031 ...

DC ₁₈	RE	APMX	DN	LH	LPR	OAL	DCONMS _{h5}	ZEFP	
mm	mm	mm	mm	mm	mm	mm	mm		
6	0,1	13	5,8	19	21	57	6	5	06201
6	0,4	13	5,8	19	21	57	6	5	06204
6	0,5	13	5,8	19	21	57	6	5	06205
6	0,6	13	5,8	19	21	57	6	5	06206
6	0,8	13	5,8	19	21	57	6	5	06208
6	1,0	13	5,8	19	21	57	6	5	06210
6	1,5	13	5,8	19	21	57	6	5	06215
8	0,2	19	7,7	25	27	63	8	5	08202
8	0,5	21	7,7	25	27	63	8	5	08205
8	0,8	21	7,7	25	27	63	8	5	08208
8	1,0	21	7,7	25	27	63	8	5	08210
8	1,2	21	7,7	25	27	63	8	5	08212
8	1,5	21	7,7	25	27	63	8	5	08215
8	2,0	21	7,7	25	27	63	8	5	08220
10	0,2	22	9,7	30	32	72	10	5	10202
10	0,5	22	9,7	30	32	72	10	5	10205
10	1,0	22	9,7	30	32	72	10	5	10210
10	1,2	22	9,7	30	32	72	10	5	10212
10	1,5	22	9,7	30	32	72	10	5	10215
10	1,6	22	9,7	30	32	72	10	5	10216
10	2,0	22	9,7	30	27	72	10	5	10220
12	0,2	26	11,6	36	38	83	12	5	12202
12	0,5	26	11,6	36	38	83	12	5	12205
12	1,0	26	11,6	36	38	83	12	5	12210
12	1,2	26	11,6	36	38	83	12	5	12212
12	1,5	26	11,6	36	38	83	12	5	12215
12	1,6	26	11,6	36	38	83	12	5	12216
12	2,0	26	11,6	36	38	83	12	5	12220
12	2,5	26	11,6	36	38	83	12	5	12225
12	3,0	26	11,6	36	38	83	12	5	12230
16	0,3	36	15,5	42	44	92	16	5	16203
16	1,0	36	15,5	42	44	92	16	5	16210
16	1,6	36	15,5	42	44	92	16	5	16216
16	2,0	36	15,5	42	44	92	16	5	16220
16	2,5	36	15,5	42	44	92	16	5	16225
16	3,0	36	15,5	42	44	92	16	5	16230
16	3,2	36	15,5	42	44	92	16	5	16232
16	4,0	36	15,5	42	44	92	16	5	16240
20	0,3	41	19,5	52	54	104	20	5	20203
20	2,0	41	19,5	52	54	104	20	5	20220
20	3,0	41	19,5	52	54	104	20	5	20230
20	4,0	41	19,5	52	54	104	20	5	20240
20	5,0	41	19,5	52	54	104	20	5	20250
20	6,3	41	19,5	52	54	104	20	5	20263

P	
M	○
K	
N	
S	●
H	
O	

MonsterMill – Ball Nosed Cutter

The specialist for machining nickel-based alloys

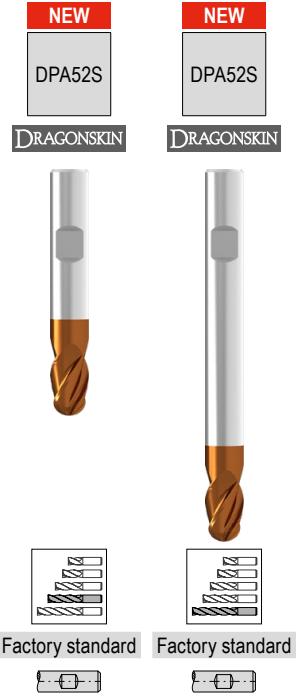
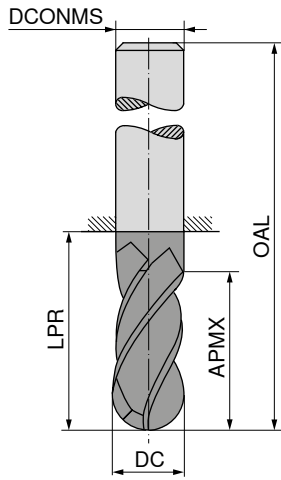
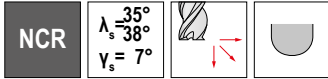

DC ±0.01 mm	APMX mm	LPR mm	OAL mm	DCONMS ^{h5} mm	ZEFP
2	4	18	54	6	4
2	4	44	80	6	4
3	5	18	54	6	4
3	5	44	80	6	4
4	8	18	54	6	4
4	8	44	80	6	4
5	9	18	54	6	4
5	9	44	80	6	4
6	10	18	54	6	4
6	10	44	80	6	4
8	12	22	58	8	4
8	12	64	100	8	4
10	14	26	66	10	4
10	14	60	100	10	4
12	16	28	73	12	4
12	16	55	100	12	4
16	20	34	82	16	4
16	20	52	100	16	4

53 032 ...	53 033 ...
02210	02410
03215	03415
04220	04420
05225	05425
06230	06430
08240	08440
10250	10450
12260	12460
16280	16480

P		
M	○	○
K		
N		
S	●	●
H		
O		

→ v_c/f_z Page 342+343

MonsterMill – Finish milling cutter with corner radius

The specialist for finish machining tempered steel up to 70 HRC

▲ Radius accuracy ± 0.005 mm

▲ T_x = maximum depth of cut

▲ DC Tolerance

up to Ø 6 mm: 0/ -0.01 mm

from Ø 6 mm: 0/ -0.02 mm

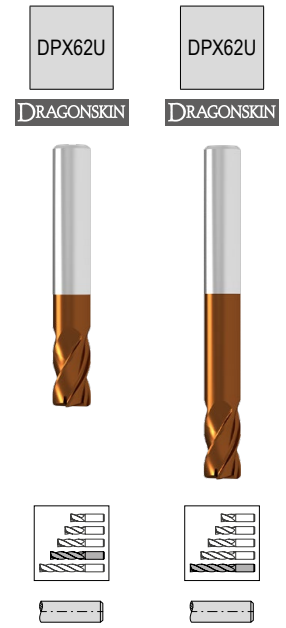
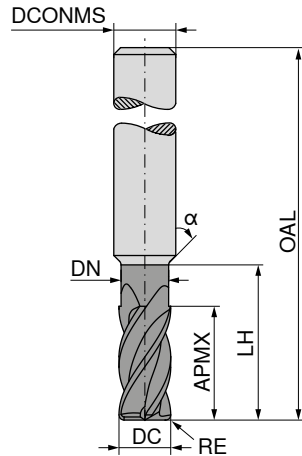
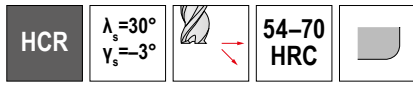

DC	RE	APMX	DN	LH	α°	OAL	DCONMS _{h5}	T _x	ZEFP	53 603 ...	53 604 ...
mm	mm	mm	mm	mm		mm	mm				
0,2	0,05	0,5		0,5	30	48	4	2,5 x DC	2	30205	
0,2	0,05	0,5	0,18	1,0	30	48	4	5 x DC	2	40205	
0,3	0,05	0,6	0,27	1,0	30	48	4	3,3 x DC	2	30305	
0,3	0,05	0,6	0,27	2,0	30	48	4	6,7 x DC	2	40305	
0,4	0,05	0,7	0,35	1,0	30	48	4	2,5 x DC	2	30405	
0,4	0,05	0,7	0,35	2,0	30	48	4	5 x DC	2	40405	
0,4	0,05	0,7	0,35	3,0	30	48	4	7,5 x DC	2	50405	
0,5	0,05	0,7	0,45	1,0	30	48	4	2 x DC	2	30505	
0,5	0,05	0,7	0,45	2,0	30	48	4	4 x DC	2	40505	
0,5	0,05	0,7	0,45	2,5	30	48	4	5 x DC	2	50505	
0,5	0,05	0,7	0,45	3,0	30	48	4	6 x DC	2	60505	
0,5	0,05	0,7	0,45	4,0	30	48	4	8 x DC	2	70505	
0,6	0,05	0,8	0,55	2,0	30	48	4	3,3 x DC	2	30605	
0,6	0,05	0,8	0,55	3,0	30	48	4	5 x DC	2	40605	
0,6	0,05	0,8	0,55	4,5	30	48	4	7,5 x DC	2	50605	
0,6	0,05	0,8	0,55	6,0	30	48	4	10 x DC	2	60605	
0,8	0,05	1,0	0,75	2,0	30	48	4	2,5 x DC	2	30805	30605
0,8	0,05	1,0	0,75	4,0	30	48	4	5 x DC	2	40805	
0,8	0,05	1,0	0,75	6,0	30	48	4	7,5 x DC	2	50805	
0,8	0,05	1,0	0,75	8,0	30	48	4	10 x DC	2		30805
0,8	0,05	1,0	0,75	10,0	30	48	4	12,5 x DC	2		40805
1,0	0,10	1,5	0,95	2,0	30	48	4	2 x DC	4	31001	
1,0	0,10	1,5	0,95	4,0	30	48	4	4 x DC	4	41001	
1,0	0,10	1,5	0,95	6,0	30	48	4	6 x DC	4	51001	
1,0	0,10	1,5	0,95	8,0	30	48	4	8 x DC	4	61001	
1,0	0,10	1,5	0,95	10,0	30	48	4	10 x DC	4		31001
1,0	0,10	1,5	0,95	14,0	30	48	4	14 x DC	4		41001
1,5	0,10	2,0	1,45	4,0	30	48	4	2,7 x DC	4	31501	
1,5	0,10	2,0	1,45	6,0	30	48	4	4 x DC	4	41501	
1,5	0,10	2,0	1,45	10,0	30	48	4	6,7 x DC	4	51501	
1,5	0,10	2,0	1,45	12,0	30	48	4	8 x DC	4	61501	
1,5	0,10	2,0	1,45	15,0	30	60	4	10 x DC	4		31501
1,5	0,10	2,0	1,45	20,0	30	60	4	13,3 x DC	4		41501
2,0	0,20	2,5	1,90	4,0	30	48	4	2 x DC	4	32002	
2,0	0,20	2,5	1,90	6,0	30	48	4	3 x DC	4	42002	
2,0	0,20	2,5	1,90	8,0	30	48	4	4 x DC	4	52002	
2,0	0,20	2,5	1,90	10,0	30	48	4	5 x DC	4	62002	
2,0	0,20	2,5	1,90	12,0	30	48	4	6 x DC	4	72002	
2,0	0,20	2,5	1,90	16,0	30	60	4	8 x DC	4	82002	
2,0	0,20	2,5	1,90	20,0	30	60	4	10 x DC	4		32002
2,0	0,20	2,5	1,90	25,0	30	60	4	12,5 x DC	4		42002
3,0	0,20	3,5	2,90	8,0	30	60	6	2,7 x DC	4	33002	

P		○	○
M			
K			
N			
S			
H		●	●
O			

MonsterMill – Finish milling cutter with corner radius

The specialist for finish machining tempered steel up to 70 HRC

▲ Radius accuracy ± 0.005 mm

▲ T_x = maximum depth of cut

▲ DC Tolerance

up to Ø 6 mm: 0/ -0.01 mm

from Ø 6 mm: 0/ -0.02 mm

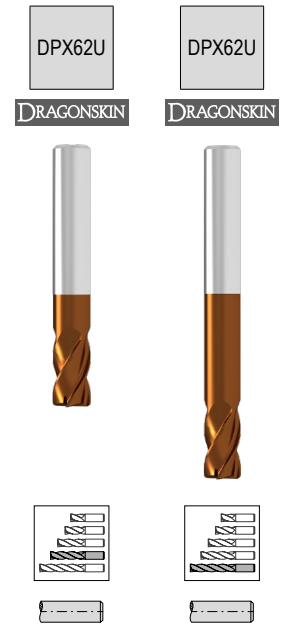
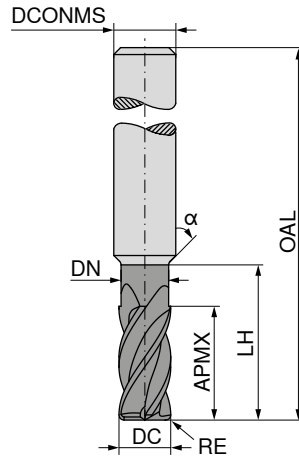
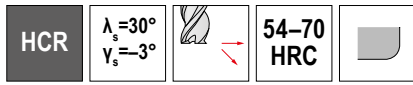

DC	RE	APMX	DN	LH	α°	OAL	DCONMS _{h5}	T_x	ZEPF	53 603 ...	53 604 ...
mm	mm	mm	mm	mm		mm	mm				
3,0	0,20	3,5	2,90	12,0	30	60	6	4 x DC	4	43002	
3,0	0,20	3,5	2,90	16,0	30	60	6	5,3 x DC	4	53002	
3,0	0,20	3,5	2,90	20,0	30	70	6	6,7 x DC	4	63002	
3,0	0,20	3,5	2,90	24,0	30	70	6	8 x DC	4	73002	
4,0	0,20	4,5	3,90	8,0	30	60	6	2 x DC	4	34002	
4,0	0,20	4,5	3,90	12,0	30	60	6	3 x DC	4	44002	
4,0	0,20	4,5	3,90	16,0	30	60	6	4 x DC	4	54002	
4,0	0,20	4,5	3,90	20,0	30	70	6	5 x DC	4	64002	
4,0	0,20	4,5	3,90	24,0	30	70	6	6 x DC	4	74002	
4,0	0,20	4,5	3,90	28,0	30	70	6	7 x DC	4	84002	
4,0	0,50	4,5	3,90	8,0	30	60	6	2 x DC	4	34005	
4,0	0,50	4,5	3,90	12,0	30	60	6	3 x DC	4	44005	
4,0	0,50	4,5	3,90	16,0	30	60	6	4 x DC	4	54005	
4,0	0,50	4,5	3,90	20,0	30	70	6	5 x DC	4	64005	
4,0	0,50	4,5	3,90	24,0	30	70	6	6 x DC	4	74005	
4,0	0,50	4,5	3,90	28,0	30	70	6	7 x DC	4	84005	
4,0	1,00	4,5	3,90	8,0	30	60	6	2 x DC	4	34010	
4,0	1,00	4,5	3,90	12,0	30	60	6	3 x DC	4	44010	
4,0	1,00	4,5	3,90	16,0	30	60	6	4 x DC	4	54010	
4,0	1,00	4,5	3,90	20,0	30	70	6	5 x DC	4	64010	
4,0	1,00	4,5	3,90	24,0	30	70	6	6 x DC	4	74010	
4,0	1,00	4,5	3,90	28,0	30	70	6	7 x DC	4	84010	
6,0	0,20	6,5	5,90	12,0		60	6	2 x DC	4	36002	
6,0	0,20	6,5	5,90	16,0		60	6	2,7 x DC	4	46002	
6,0	0,20	6,5	5,90	20,0		60	6	3,3 x DC	4	56002	
6,0	0,50	6,5	5,90	12,0		60	6	2 x DC	4	36005	
6,0	0,50	6,5	5,90	16,0		60	6	2,7 x DC	4	46005	
6,0	0,50	6,5	5,90	20,0		60	6	3,3 x DC	4	56005	
6,0	1,00	6,5	5,90	12,0		60	6	2 x DC	4	36010	
6,0	1,00	6,5	5,90	16,0		60	6	2,7 x DC	4	46010	
6,0	1,00	6,5	5,90	20,0		60	6	3,3 x DC	4	56010	
8,0	0,50	8,5	7,90	16,0		60	8	2 x DC	4	38005	
8,0	0,50	8,5	7,90	40,0		80	8	5 x DC	4	48005	
8,0	1,00	8,5	7,90	16,0		60	8	2 x DC	4	38010	
8,0	1,00	8,5	7,90	40,0		80	8	5 x DC	4	48010	
10,0	0,50	10,5	9,90	20,0		70	10	2 x DC	4	10005	
10,0	0,50	10,5	9,90	40,0		90	10	4 x DC	4	10105	
10,0	1,00	10,5	9,90	20,0		70	10	2 x DC	4	10010	
10,0	1,00	10,5	9,90	40,0		90	10	4 x DC	4	10110	
12,0	1,00	12,5	11,90	24,0		70	12	2 x DC	4	12010	
12,0	1,00	12,5	11,90	40,0		90	12	3,3 x DC	4	12110	

P		○	○
M			
K			
N			
S			
H		●	●
O			

→ v_c/f_z Page 344–349

MonsterMill – Finish milling cutter with corner radius

The specialist for finish machining tempered steel up to 70 HRC

- ▲ Radius accuracy ± 0.005 mm
- ▲ T_x = maximum depth of cut
- ▲ DC Tolerance
up to $\varnothing 6$ mm: 0/-0.01 mm
from $\varnothing 6$ mm: 0/ -0.02 mm

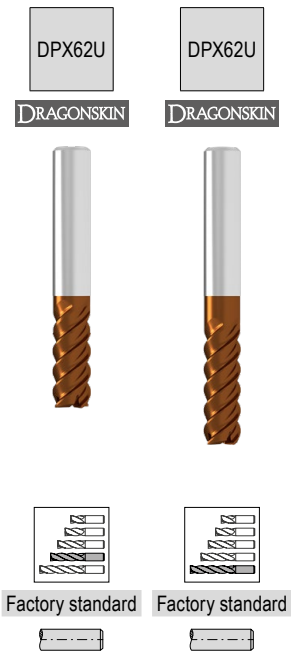
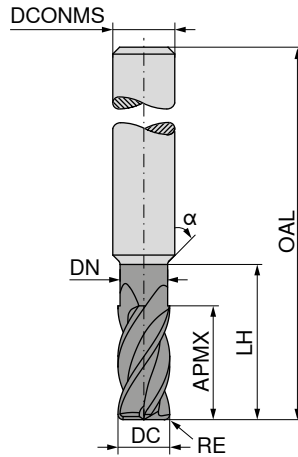
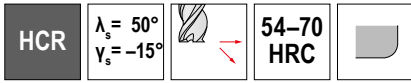

DC mm	RE mm	APMX mm	DN mm	LH mm	α°	OAL mm	DCONMS _{H5} mm	T_x	ZEFP
1	0,03	2			30	48	4	2 x DC	4
1	0,03	3	0,95	4	30	48	4	3 x DC	4
2	0,03	4			30	48	4	2 x DC	4
2	0,03	6	1,90	8	30	48	4	3 x DC	4
3	0,03	6			30	60	6	2 x DC	4
3	0,03	9	2,90	12	30	60	6	3 x DC	4
4	0,05	8			30	60	6	2 x DC	4
4	0,05	12	3,90	16	30	60	6	3 x DC	4
6	0,05	12				60	6	2 x DC	4
6	0,05	18	5,90	24		60	6	3 x DC	4
8	0,05	16				60	8	2 x DC	4
8	0,05	24	7,90	32		70	8	3 x DC	4
10	0,05	20				70	10	2 x DC	4
10	0,05	30	9,90	40		80	10	3 x DC	4
12	0,05	24				70	12	2 x DC	4
12	0,05	36	11,90	44		90	12	3 x DC	4

	53 605 ...	53 606 ...
P	○	○
M		
K		
N		
S		
H	●	●
O		

→ v_c/f_z Page 350

MonsterMill – Ball Nosed Cutter

The specialist for finish machining tempered steel up to 70 HRC

▲ Radius accuracy: ± 0.005 mm

▲ T_x = maximum depth of cut

▲ DC Tolerance

up to Ø 6 mm: 0/ -0.01 mm

from Ø 6 mm: 0/ -0.02 mm

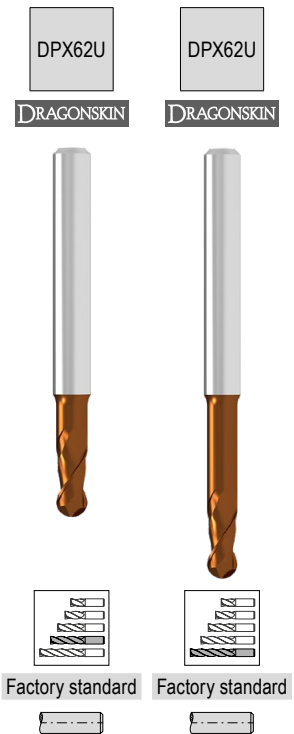
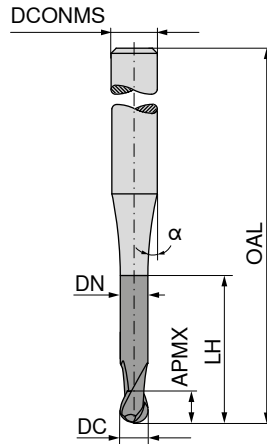
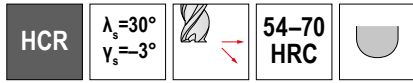

DC	APMX	DN	LH	α°	OAL	DCONMS _{ns}	T_x	ZEFP	53 600 ...	53 601 ...
mm	mm	mm	mm		mm	mm				
0,2	0,5		0,5	15	48	4	2,5 x DC	2	302	
0,2	0,5	0,18	1,0	15	48	4	5 x DC	2	402	
0,3	0,5	0,27	1,0	15	48	4	3,3 x DC	2	303	
0,3	0,5	0,27	2,0	15	48	4	6,7 x DC	2	403	
0,4	0,5	0,35	1,0	15	48	4	2,5 x DC	2	304	
0,4	0,5	0,35	2,0	15	48	4	5 x DC	2	404	
0,4	0,5	0,35	3,0	15	48	4	7,5 x DC	2	504	
0,5	0,5	0,45	1,0	15	48	4	2 x DC	2	305	
0,5	0,5	0,45	2,0	15	48	4	4 x DC	2	405	
0,5	0,5	0,45	2,5	15	48	4	5 x DC	2	505	
0,5	0,5	0,45	3,0	15	48	4	6 x DC	2	605	
0,5	0,5	0,45	4,0	15	48	4	8 x DC	2	705	
0,6	0,6	0,55	2,0	15	48	4	3,3 x DC	2	306	
0,6	0,6	0,55	3,0	15	48	4	5 x DC	2	406	
0,6	0,6	0,55	4,5	15	48	4	7,5 x DC	2	506	
0,6	0,6	0,55	6,0	15	48	4	10 x DC	2		306
0,8	1,0	0,75	2,0	15	48	4	2,5 x DC	2	308	
0,8	1,0	0,75	4,0	15	48	4	5 x DC	2	408	
0,8	1,0	0,75	6,0	15	48	4	7,5 x DC	2	508	
0,8	1,0	0,75	8,0	15	48	4	10 x DC	2		308
0,8	1,0	0,75	10,0	15	48	4	12,5 x DC	2		408
1,0	1,5	0,95	2,0	15	48	4	2 x DC	2	310	
1,0	1,5	0,95	4,0	15	48	4	4 x DC	2	410	
1,0	1,5	0,95	6,0	15	48	4	6 x DC	2	510	
1,0	1,5	0,95	8,0	15	48	4	8 x DC	2	610	
1,0	1,5	0,95	10,0	15	48	4	10 x DC	2		310
1,0	1,5	0,95	14,0	15	48	4	14 x DC	2		410
1,5	1,5	1,45	4,0	15	48	4	2,7 x DC	2	315	
1,5	1,5	1,45	6,0	15	48	4	4 x DC	2	415	
1,5	1,5	1,45	8,0	15	48	4	5,3 x DC	2	515	
1,5	1,5	1,45	10,0	15	48	4	6,7 x DC	2	615	
1,5	1,5	1,45	15,0	15	60	4	10 x DC	2		315

P	○	○
M		
K		
N		
S		
H	●	●
O		

→ v_c/f_z Page 352+353

MonsterMill – Ball Nosed Cutter

The specialist for finish machining tempered steel up to 70 HRC

- ▲ Radius accuracy: ± 0.005 mm
- ▲ T_x = maximum depth of cut
- ▲ DC Tolerance
up to Ø 6 mm: 0/ -0.01 mm
from Ø 6 mm: 0/ -0.02 mm

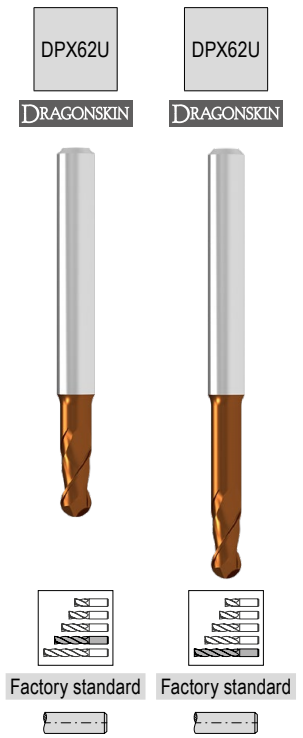
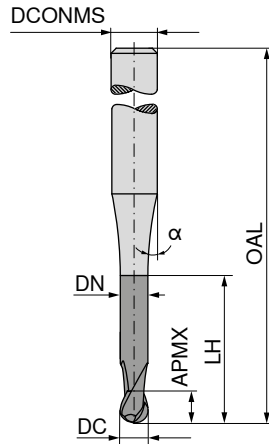
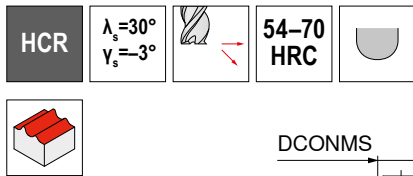

DC	APMX	DN	LH	α°	OAL	DCONMS _{ns}	T_x	ZEFP
mm	mm	mm	mm		mm	mm		
1,5	1,5	1,45	20,0	15	60	4	13,3 x DC	2
2,0	2,5	1,90	4,0	15	48	4	2 x DC	2
2,0	2,5	1,90	6,0	15	48	4	3 x DC	2
2,0	2,5	1,90	8,0	15	48	4	4 x DC	2
2,0	2,5	1,90	10,0	15	48	4	5 x DC	2
2,0	2,5	1,90	12,0	15	48	4	6 x DC	2
2,0	2,5	1,90	16,0	15	60	4	8 x DC	2
2,0	2,5	1,90	20,0	15	60	4	10 x DC	2
2,0	2,5	1,90	25,0	15	60	4	12,5 x DC	2
3,0	3,5	2,90	8,0	15	60	6	2,7 x DC	2
3,0	3,5	2,90	12,0	15	60	6	4 x DC	2
3,0	3,5	2,90	16,0	15	60	6	5,3 x DC	2
3,0	3,5	2,90	20,0	15	70	6	6,7 x DC	2
3,0	3,5	2,90	24,0	15	70	6	8 x DC	2
4,0	4,5	3,90	8,0	15	60	6	2 x DC	2
4,0	4,5	3,90	12,0	15	60	6	3 x DC	2
4,0	4,5	3,90	16,0	15	60	6	4 x DC	2
4,0	4,5	3,90	20,0	15	70	6	5 x DC	2
4,0	4,5	3,90	24,0	15	70	6	6 x DC	2
4,0	4,5	3,90	28,0	15	70	6	7 x DC	2
6,0	6,5	5,90	12,0		60	6	2 x DC	2
6,0	6,5	5,90	16,0		60	6	2,7 x DC	2
6,0	6,5	5,90	20,0		60	6	3,3 x DC	2
8,0	8,5	7,90	16,0		60	8	2 x DC	2
8,0	8,5	7,90	40,0		80	8	5 x DC	2
10,0	10,5	9,90	20,0	15	70	10	2 x DC	2
10,0	10,5	9,90	40,0		90	10	4 x DC	2
12,0	12,5	11,90	24,0		75	12	2 x DC	2
12,0	12,5	11,90	40,0		90	12	3,3 x DC	2

	53 600 ...	53 601 ...
P	○	○
M		
K		
N		
S		
H	●	●
O		

→ v_c/f_z Page 352+353

MonsterMill – Ball Nosed Cutter

The specialist for finish machining tempered steel up to 70 HRC

▲ Radius accuracy: ± 0,01 mm

HCR
 $\lambda_s=30^\circ$
 $\gamma_s=-3^\circ$
54-70 HRC

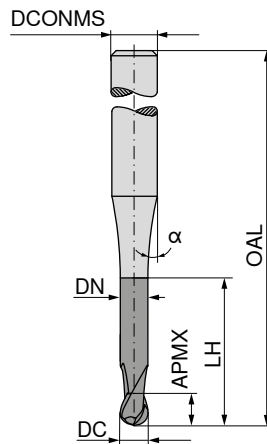

DPX62U
DRAGONSKIN



Factory standard



53 602 ...

DC mm	APMX mm	DN mm	LH mm	α°	OAL mm	DCONMS _{h5} mm	T _x	ZEFP	
3	3,5	2,9	8	15	60	6	2,7 x DC	4	330
3	3,5	2,9	12	15	60	6	4 x DC	4	430
3	3,5	2,9	16	15	60	6	5,3 x DC	4	530
3	3,5	2,9	20	15	70	6	6,7 x DC	4	630
3	3,5	2,9	24	15	70	6	8 x DC	4	730
4	4,5	3,9	8	15	60	6	2 x DC	4	340
4	4,5	3,9	12	15	60	6	3 x DC	4	440
4	4,5	3,9	16	15	60	6	4 x DC	4	540
4	4,5	3,9	20	15	70	6	5 x DC	4	640
4	4,5	3,9	24	15	70	6	6 x DC	4	740
4	4,5	3,9	28	15	70	6	7 x DC	4	840
6	6,5	5,9	12		60	6	2 x DC	4	360
6	6,5	5,9	16		60	6	2,7 x DC	4	460
6	6,5	5,9	20		60	6	3,3 x DC	4	560
8	8,5	7,9	16		60	8	2 x DC	4	380
8	8,5	7,9	40		80	8	5 x DC	4	480
10	10,5	9,9	20		70	10	2 x DC	4	100
10	10,5	9,9	40		90	10	4 x DC	4	101
12	12,5	11,9	24		75	12	2 x DC	4	120
12	12,5	11,9	40		90	12	3,3 x DC	4	121

P	○
M	
K	
N	
S	
H	
O	●

→ v_c/f_z Page 351

MonsterMill – Plunge milling cutter with corner radius

The specialist for ramping, plunging and helical milling

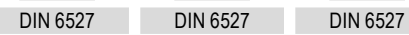
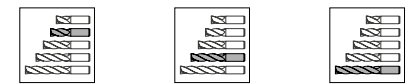
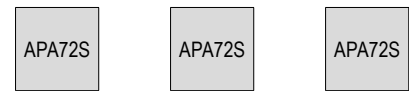
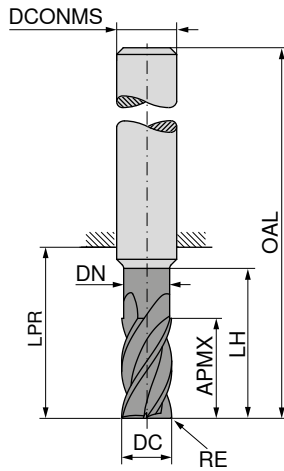
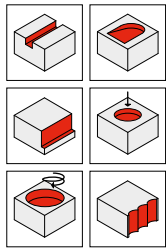
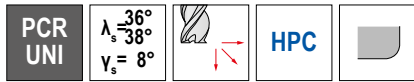

	52 613 ...	52 614 ...	52 615 ...
	05000		
		05000	
			05000
	057		
		057	
			057
	060		
		060	
			060
	067		
		067	
			067
	070		
		070	
			070
	077		
		077	
			077
	080		
		080	
			080
	087		
		087	
			087
	090		
		090	
			090
	097		
		097	
			097
	100		
		100	
			100
	117		
		117	
			117
	120		
		120	
			120

DC _{FB}	RE _{±0.03}	APMX	DN	LH	LPR	OAL	DCONMS _{H6}	ZEFP
mm	mm	mm	mm	mm	mm	mm	mm	
5,0	0,20	9			18	54	6	4
5,0	0,20	13	4,8	19	21	57	6	4
5,0	0,20	13	4,8	24	26	62	6	4
5,7	0,20	10			18	54	6	4
5,7	0,20	13	5,5	19	21	57	6	4
5,7	0,20	13	5,5	24	26	62	6	4
6,0	0,20	10			18	54	6	4
6,0	0,20	13	5,8	19	21	57	6	4
6,0	0,20	13	5,8	24	26	62	6	4
6,7	0,20	11			22	58	8	4
6,7	0,20	16	6,5	25	27	63	8	4
6,7	0,20	16	6,4	30	32	68	8	4
7,0	0,20	11			22	58	8	4
7,0	0,20	16	6,8	25	27	63	8	4
7,0	0,20	16	6,7	30	32	68	8	4
7,7	0,20	12			22	58	8	4
7,7	0,20	19	7,5	25	27	63	8	4
7,7	0,20	21	7,4	30	32	68	8	4
8,0	0,20	12			22	58	8	4
8,0	0,20	19	7,8	25	27	63	8	4
8,0	0,20	21	7,7	30	32	68	8	4
8,7	0,32	13			26	66	10	4
8,7	0,32	19	8,5	30	32	72	10	4
8,7	0,32	22	8,4	38	40	80	10	4
9,0	0,32	13			26	66	10	4
9,0	0,32	19	8,8	30	32	72	10	4
9,0	0,32	22	8,7	38	40	80	10	4
9,7	0,32	14			26	66	10	4
9,7	0,32	22	9,5	30	32	72	10	4
9,7	0,32	22	9,4	38	40	80	10	4
10,0	0,32	14			26	66	10	4
10,0	0,32	22	9,8	30	32	72	10	4
10,0	0,32	22	9,7	38	40	80	10	4
11,7	0,32	16			28	73	12	4
11,7	0,32	26	11,5	36	38	83	12	4
11,7	0,32	26	11,3	46	48	93	12	4
12,0	0,32	16			28	73	12	4
12,0	0,32	26	11,8	36	38	83	12	4
12,0	0,32	26	11,6	46	48	93	12	4

P	●	●	●
M	○	○	○
K	●	●	●
N			
S			
H			
O			

MonsterMill – Plunge milling cutter with corner radius

The specialist for ramping, plunging and helical milling

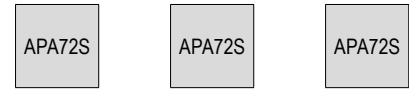
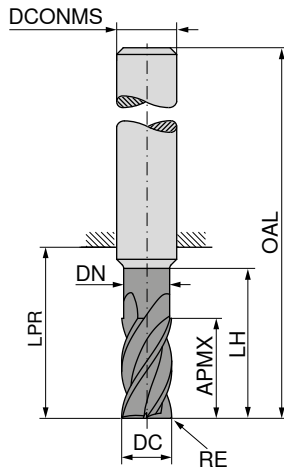
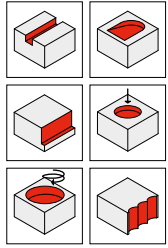
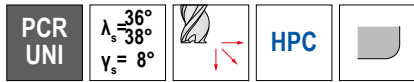

DIN 6527



DIN 6527



DIN 6527



52 613 ...	52 614 ...	52 615 ...
137	137	137
140	140	140
155	155	155
160	160	160
175	175	175
180	180	180
195	195	195
200	200	200

DC ₁₈	RE _{±0.03}	APMX	DN	LH	LPR	OAL	DCONMS _{H6}	ZEFP
mm	mm	mm	mm	mm	mm	mm	mm	
13,7	0,32	18			30	75	14	4
13,7	0,32	26	13,5	36	38	83	14	4
13,7	0,32	26	13,3	52	54	99	14	4
14,0	0,32	18			30	75	14	4
14,0	0,32	26	13,8	36	38	83	14	4
14,0	0,32	26	13,6	52	54	99	14	4
15,5	0,32	22			34	82	16	4
15,5	0,32	32	15,3	42	44	92	16	4
15,5	0,32	36	15,0	58	60	108	16	4
16,0	0,32	22			34	82	16	4
16,0	0,32	32	15,8	42	44	92	16	4
16,0	0,32	36	15,5	58	60	108	16	4
17,5	0,32	24			36	84	18	4
17,5	0,32	32	17,3	42	44	92	18	4
17,5	0,32	36	17,0	67	69	117	18	4
18,0	0,32	24			36	84	18	4
18,0	0,32	32	17,8	42	44	92	18	4
18,0	0,32	36	17,5	67	69	117	18	4
19,5	0,50	26			42	92	20	4
19,5	0,50	38	19,3	52	54	104	20	4
19,5	0,50	41	19,0	74	76	126	20	4
20,0	0,50	26			42	92	20	4
20,0	0,50	38	19,8	52	54	104	20	4
20,0	0,50	41	19,5	74	76	126	20	4

P	●	●	●
M	○	○	○
K	●	●	●
N			
S			
H			
O			

→ v_c/f_z Page 354+355

MonsterMill – Plunge milling cutter with corner radius

The specialist for ramping, plunging and helical milling

▲ suitable for trochoidal milling

▲ Chip breaker 0.9 x DC

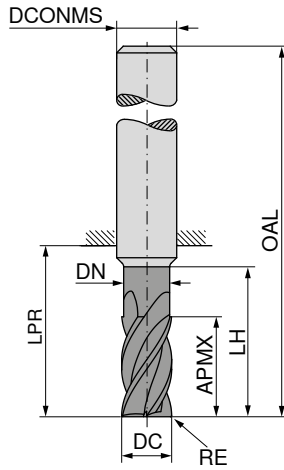
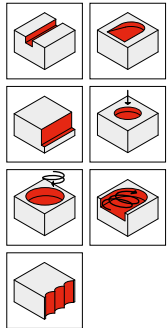

APA72S



DIN 6527



52 619 ...

DC ₁₈ mm	RE _{±0.03} mm	APMX mm	DN mm	LH mm	LPR mm	OAL mm	DCONMS ₁₈ mm	ZEFP	
5	0,20	17	4,8	24	26	62	6	4	05202
6	0,20	17	5,8	25	26	62	6	4	06202
8	0,20	24	7,7	30	32	68	8	4	08202
10	0,32	30	9,7	35	40	80	10	4	10203
12	0,32	36	11,6	45	48	93	12	4	12203
14	0,32	42	13,6	50	54	99	14	4	14203
16	0,32	48	15,5	56	60	108	16	4	16203
18	0,32	54	17,5	67	69	117	18	4	18203
20	0,50	60	19,5	70	76	126	20	4	20205

P	●
M	○
K	●
N	
S	
H	
O	

→ v_c/f_z Page 356+357

MonsterMill – Plunge milling cutter with corner radius

The specialist for ramping, plunging and helical milling

PCR ALU $\lambda_s=36^\circ$ $\gamma_s=13^\circ$ HPC

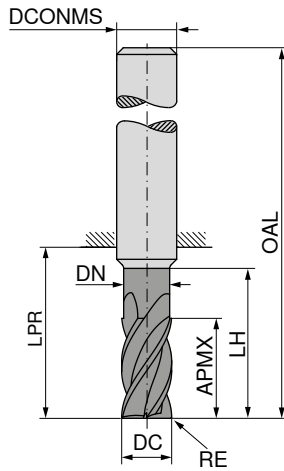
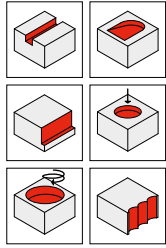

DC ₁₈	RE _{±0.03}	APMX	DN	LH	LPR	OAL	DCONMS _{h6}	ZEFP
mm	mm	mm	mm	mm	mm	mm	mm	
5,0	0,20	13	4,8	19	21	57	6	4
5,0	0,20	13	4,8	24	26	62	6	4
5,7	0,20	13	5,5	19	21	57	6	4
5,7	0,20	13	5,5	24	26	62	6	4
6,0	0,20	13	5,8	19	21	57	6	4
6,0	0,20	13	5,8	24	26	62	6	4
7,7	0,20	19	7,5	25	27	63	8	4
7,7	0,20	21	7,4	30	32	68	8	4
8,0	0,20	19	7,8	25	27	63	8	4
8,0	0,20	21	7,7	30	32	68	8	4
9,0	0,32	19	8,8	30	32	72	10	4
9,0	0,32	22	8,7	38	40	80	10	4
9,7	0,32	22	9,5	30	32	72	10	4
9,7	0,32	22	9,4	38	40	80	10	4
10,0	0,32	22	9,8	30	32	72	10	4
10,0	0,32	22	9,7	38	40	80	10	4
11,7	0,32	26	11,5	36	38	83	12	4
11,7	0,32	26	11,3	46	48	93	12	4
12,0	0,32	26	11,8	36	38	83	12	4
12,0	0,32	26	11,6	46	48	93	12	4
13,7	0,32	26	13,5	36	38	83	14	4
13,7	0,32	26	13,3	52	54	99	14	4
14,0	0,32	26	13,8	36	38	83	14	4
14,0	0,32	26	13,6	52	54	99	14	4
15,5	0,32	32	15,3	42	44	92	16	4
15,5	0,32	36	15,0	58	60	108	16	4
16,0	0,32	32	15,8	42	44	92	16	4
16,0	0,32	36	15,5	58	60	108	16	4
17,5	0,32	32	17,3	42	44	92	18	4
17,5	0,32	36	17,0	67	69	117	18	4
18,0	0,32	32	17,8	42	44	92	18	4
18,0	0,32	36	17,5	67	69	117	18	4
19,5	0,50	38	19,3	52	54	104	20	4
19,5	0,50	41	19,0	74	76	126	20	4
20,0	0,50	38	19,8	52	54	104	20	4
20,0	0,50	41	19,5	74	76	126	20	4

52 616 ...	52 617 ...
050	050
057	057
060	060
077	077
080	080
090	090
097	097
100	100
117	117
120	120
137	137
140	140
155	155
160	160
175	175
180	180
195	195
200	200

P	
M	
K	
N	•
S	
H	
O	

→ v_c/f_z Page 358+359

MonsterMill – Plunge milling cutter with corner radius

The specialist for ramping, plunging and helical milling

▲ suitable for trochoidal milling

▲ Chip breaker 0.9 x DC

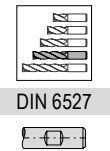
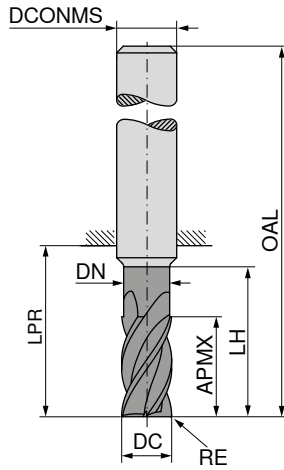
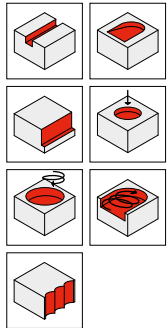
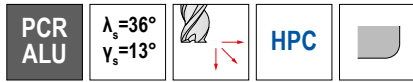

52 618 ...

DC ₁₈ mm	RE _{±0.03} mm	APMX mm	DN mm	LH mm	LPR mm	OAL mm	DCONMS _{H6} mm	ZEFP	
5	0,20	17	4,8	24	26	62	6	4	05202
6	0,20	18	5,8	25	26	62	6	4	06202
8	0,20	24	7,7	30	32	68	8	4	08202
10	0,32	30	9,7	35	40	80	10	4	10203
12	0,32	36	11,6	45	48	93	12	4	12203
14	0,32	42	13,6	50	54	99	14	4	14203
16	0,32	48	15,5	56	60	108	16	4	16203
18	0,32	54	17,5	67	69	117	18	4	18203
20	0,50	60	19,5	70	76	126	20	4	20205

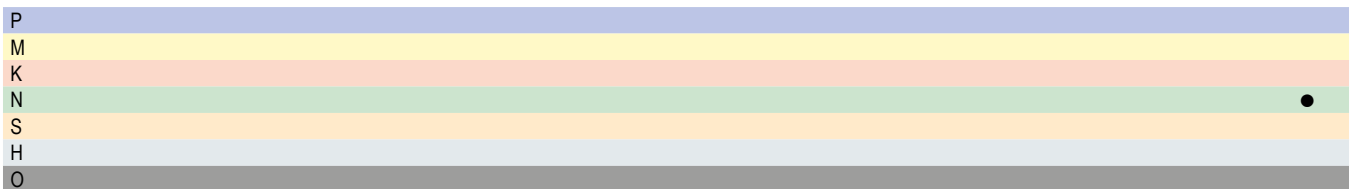

→ v_c/f_z Page 358–361

MonsterMill – Rough milling cutter

The specialist for rough machining steel and cast iron

- ▲ Cutting edges with irregular pitch
- ▲ With round cord profile

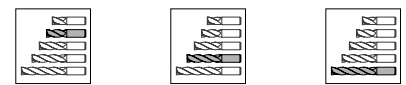
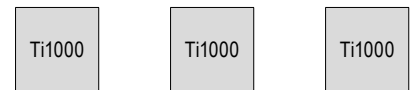
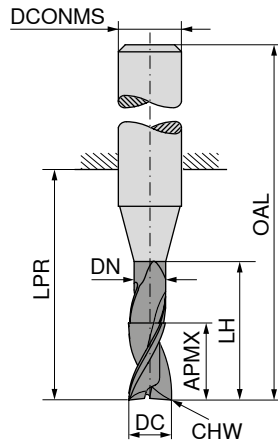
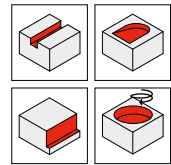
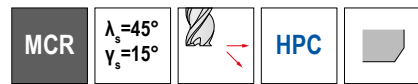

Factory standard Factory standard Factory standard

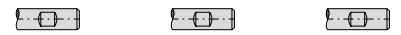

52 752 ... 52 752 ... 52 752 ...

DC _{h11} mm	APMX mm	DN mm	LH mm	LPR mm	OAL mm	DCONMS _{h6} mm	CHW mm	ZEFP			
1	1,5	0,9	3	10	38	3	0,09	3			010 ¹⁾
2	3,0	1,9	8	21	57	6	0,17	3			020
3	5,0	2,9	14	21	57	6	0,17	3			030
3	8,0	2,9	14	21	57	6	0,17	3			
3	5,0	2,9	19	26	62	6	0,17	3		031	032
4	8,0	3,8	18	21	57	6	0,17	3		040	
4	11,0	3,8	18	21	57	6	0,17	3		041	
4	8,0	3,8	23	26	62	6	0,17	3			042
5	9,0	4,8	19	21	57	6	0,17	3		050	
5	13,0	4,8	19	21	57	6	0,17	3			051
5	9,0	4,8	24	26	62	6	0,17	3			052
6	10,0	5,8	20	21	57	6	0,17	4		060	
6	13,0	5,8	20	21	57	6	0,17	4			061
6	10,0	5,8	25	26	62	6	0,17	4			062
8	12,0	7,7	25	27	63	8	0,28	4		080	
8	19,0	7,7	25	27	63	8	0,28	4			081
8	12,0	7,7	30	32	68	8	0,28	4			082
10	15,0	9,5	30	32	72	10	0,28	4		100	
10	22,0	9,5	30	32	72	10	0,28	4			101
10	15,0	9,5	35	40	80	10	0,28	4			102
12	18,0	11,5	35	38	83	12	0,28	4		120	
12	26,0	11,5	35	38	83	12	0,28	4			121
12	18,0	11,5	45	48	93	12	0,28	4			122
14	21,0	13,5	35	38	83	14	0,28	4		140	
14	26,0	13,5	35	38	83	14	0,28	4			141
14	21,0	13,5	50	54	99	14	0,28	4			142
16	24,0	15,5	40	44	92	16	0,43	4		160	
16	32,0	15,5	40	44	92	16	0,43	4			161
16	24,0	15,5	55	60	108	16	0,43	4			162
20	30,0	19,5	50	54	104	20	0,43	4		200	
20	38,0	19,5	50	54	104	20	0,43	4			201
20	30,0	19,5	70	76	126	20	0,43	4			202

P	●	●	●
M	○	○	○
K	●	●	●
N	○	○	○
S	○	○	○
H	○	○	○
O			

1) DIN 6535 HA Shank

MonsterMill – FRP CR fine pitched

The specialist for machining carbon fibre-reinforced plastics

- ▲ Compression zone across the entire cutting length
- ▲ right-hand cutting
- ▲ fine cross-pitched version
- ▲ Two effective end cutting edges

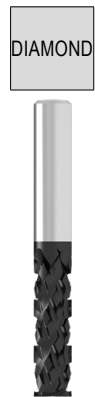
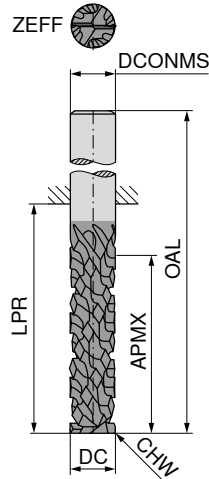
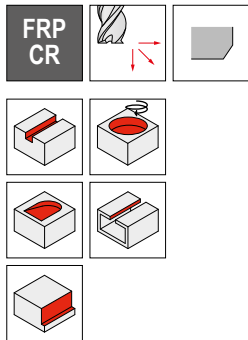

Factory standard



52 598 ...

DC _{h11} mm	APMX mm	LPR mm	OAL mm	DCONMS _{h6} mm	CHW mm	ZEFF
6,000	18	23,5	60	6,000	0,1	2
6,350	18	23,5	60	6,350	0,1	2
8,000	26	33,0	70	8,000	0,1	2
9,525	30	40,0	80	9,525	0,1	2
10,000	30	40,0	80	10,000	0,1	2
12,000	30	41,0	85	12,000	0,1	2
12,700	30	41,0	85	12,700	0,1	2

- 06000
- 06350
- 08000
- 09525
- 10000
- 12000
- 12700

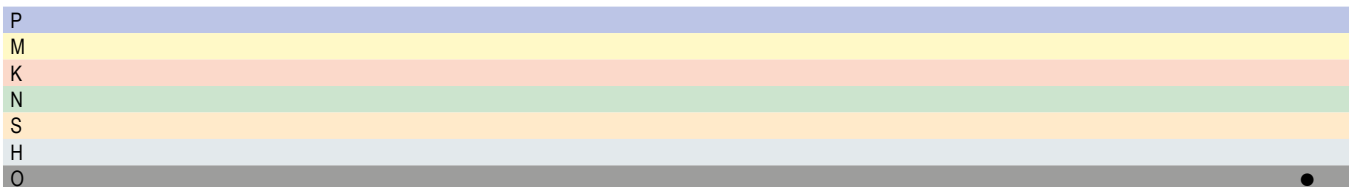

→ v_c/f Page 329

i For the MonsterMill FRP CR cutters, the feed rate must be selected in mm/rev.

MonsterMill – FRP CR coarse pitched

The specialist for machining carbon fibre-reinforced plastics

- ▲ Compression zone across the entire cutting length
- ▲ right-hand cutting
- ▲ coarse cross-pitched version
- ▲ One effective end cutting edge

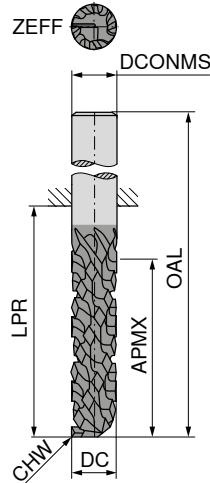
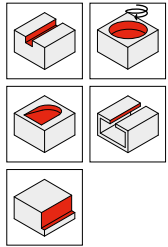
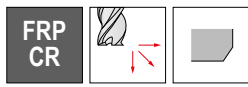

DIAMOND



Factory standard



52 599 ...

DC _{h11} mm	APMX mm	LPR mm	OAL mm	DCONMS _{h6} mm	CHW mm	ZEFF	
6,000	18	23,5	60	6,000	0,1	1	06000
6,350	18	23,5	60	6,350	0,1	1	06350
8,000	26	33,0	70	8,000	0,1	1	08000
9,525	30	40,0	80	9,525	0,1	1	09525
10,000	30	40,0	80	10,000	0,1	1	10000
12,000	30	41,0	85	12,000	0,1	1	12000
12,700	30	41,0	85	12,700	0,1	1	12700

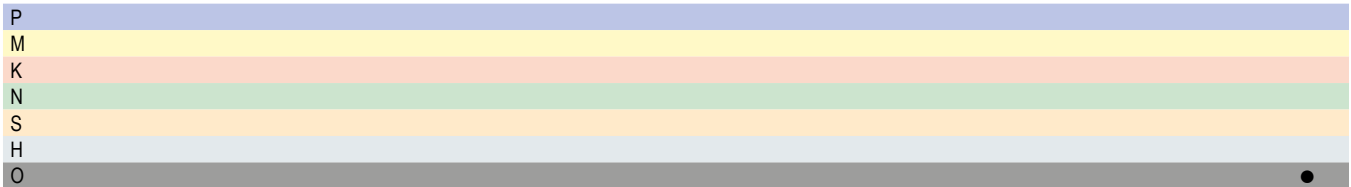

→ v_c/f Page 329

For the MonsterMill FRP CR cutters, the feed rate must be selected in mm/rev.

MonsterMill – FRP

The specialist for machining carbon fibre-reinforced plastics

- ▲ optimal removal of CFRP dust
- ▲ right-hand cutting
- ▲ straight-fluted, neutral cut
- ▲ Four end cutting edges / two central cutting edges

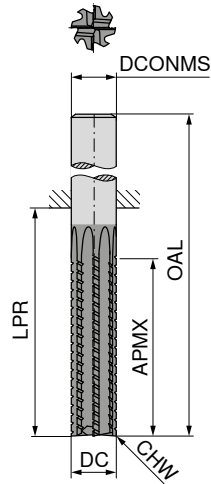
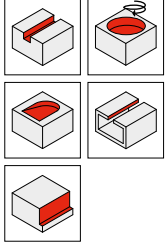
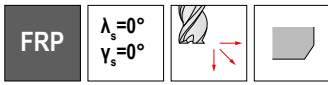

DIAMOND



Factory standard



52 595 ...

DC _{h11} mm	APMX mm	LPR mm	OAL mm	DCONMS _{h6} mm	CHW mm	ZEFP	
6,000	25	35	70	6,000	0,1	8	06000
6,350	25	35	70	6,350	0,1	8	06350
8,000	30	40	80	8,000	0,1	8	08000
9,525	32	44	85	9,525	0,1	8	09525
10,000	32	45	85	10,000	0,1	8	10000
12,000	32	46	95	12,000	0,1	8	12000
12,700	32	46	95	12,700	0,1	8	12700

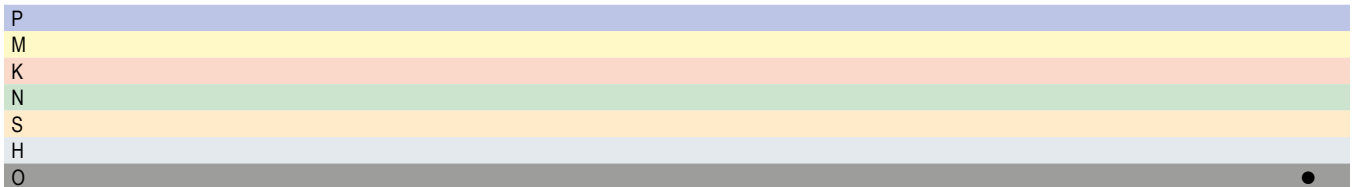

→ v_c/f_z Page 329

MonsterMill – FRP left-hand helix

The specialist for machining carbon fibre-reinforced plastics

- ▲ optimal removal of CFRP dust
- ▲ right-hand cutting
- ▲ slightly left-fluted, pushing cut
- ▲ Four end cutting edges / two central cutting edges

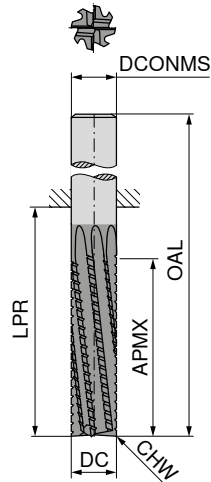
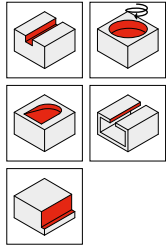
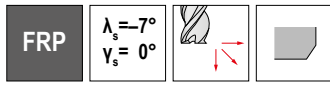

DIAMOND



Factory standard



52 596 ...

DC _{h11} mm	APMX mm	LPR mm	OAL mm	DCONMS _{h6} mm	CHW mm	ZEFP	
6,000	25	38	70	6,000	0,1	8	06000
6,350	25	39	70	6,350	0,1	8	06350
8,000	30	43	80	8,000	0,1	8	08000
9,525	32	48	85	9,525	0,1	8	09525
10,000	32	49	85	10,000	0,1	8	10000
12,000	32	53	95	12,000	0,1	8	12000
12,700	32	54	95	12,700	0,1	8	12700

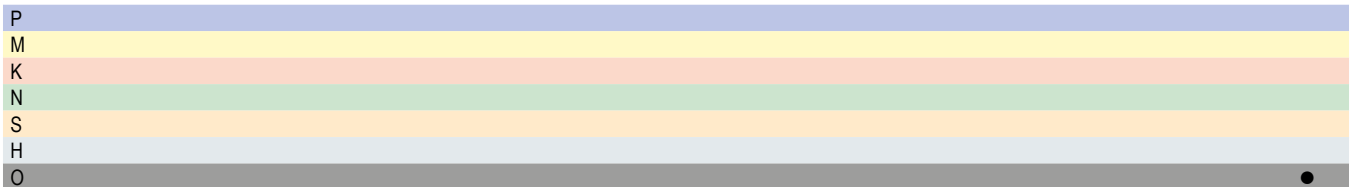

→ v_c/f_z Page 329

MonsterMill – FRP right-hand helix

The specialist for machining carbon fibre-reinforced plastics

- ▲ optimal removal of CFRP dust
- ▲ right-hand cutting
- ▲ slightly right-fluted, pulling cut
- ▲ Four end cutting edges / two central cutting edges

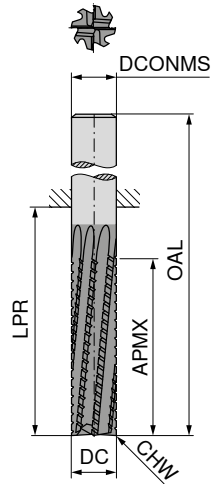
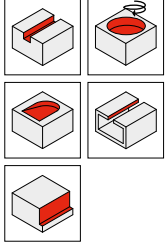
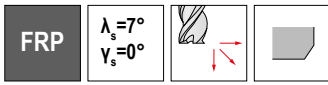

DIAMOND



Factory standard



52 597 ...

DC _{h11} mm	APMX mm	LPR mm	OAL mm	DCONMS _{h6} mm	CHW mm	ZEFP	
6,000	25	35	70	6,000	0,1	8	06000
6,350	25	35	70	6,350	0,1	8	06350
8,000	30	40	80	8,000	0,1	8	08000
9,525	32	44	85	9,525	0,1	8	09525
10,000	32	45	85	10,000	0,1	8	10000
12,000	32	49	95	12,000	0,1	8	12000
12,700	32	49	95	12,700	0,1	8	12700

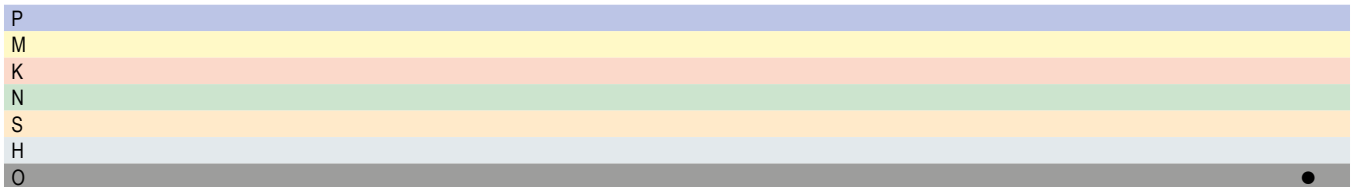

→ v_c/f_z Page 329

CircularLine – End milling cutter

The specialist for trochoidal machining

- ▲ Chip breaker 0.9 x DC
- ▲ 53 585 ... Cutting depth: 2 x DC
- ▲ 53 587 ... Cutting depth: 3 x DC

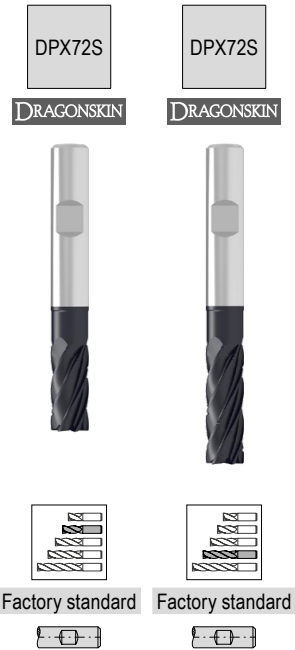
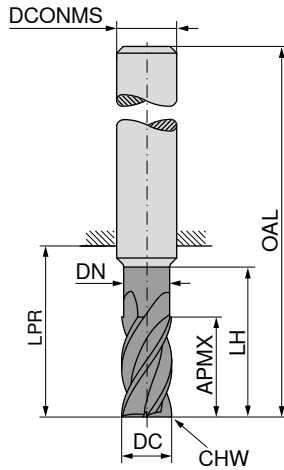
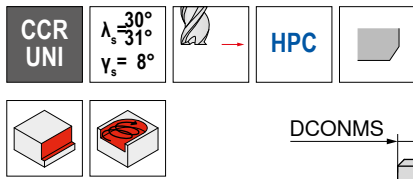

DC _{es} mm	APMX mm	DN mm	LH mm	LPR mm	OAL mm	DCONMS _{ns} mm	CHW mm	ZEFP
6	13	5,8	19	21	57	6	0,2	6
6	19	5,8	25	27	63	6	0,2	6
8	21	7,7	25	27	63	8	0,2	6
8	25	7,7	33	35	71	8	0,2	6
10	22	9,7	30	32	72	10	0,2	6
10	31	9,7	41	43	83	10	0,2	6
12	26	11,6	36	38	83	12	0,2	6
12	37	11,6	47	49	94	12	0,2	6
14	26	13,6	36	38	83	14	0,2	6
14	43	13,6	55	59	104	14	0,2	6
16	36	15,5	42	44	92	16	0,2	6
16	49	15,5	61	63	111	16	0,2	6
18	36	17,5	42	44	92	18	0,2	6
18	55	17,5	69	73	121	18	0,2	6
20	41	19,5	52	54	104	20	0,2	6
20	61	19,5	75	77	127	20	0,2	6

	53 585 ...	53 587 ...
P	●	●
M	○	○
K	●	●
N		
S	○	○
H		
O		

→ v_c/f_z Page 366+367

CircularLine – End milling cutter

The specialist for trochoidal machining

▲ Chip breaker 0,9 x DC

▲ Cutting depth: 4 x DC

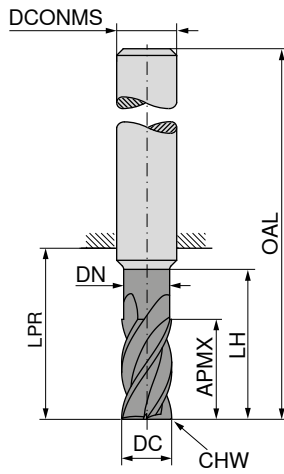
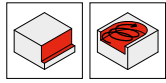
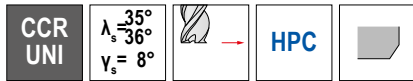

DPX72S

DRAGONSKIN



Factory standard



53 589 ...

DC _{es} mm	APMX mm	DN mm	LH mm	LPR mm	OAL mm	DCONMS ₁₆ mm	CHW mm	ZEFP	
6	25	5,8	29	31	67	6	0,2	5	060
8	33	7,7	38	40	76	8	0,2	5	080
10	41	9,7	47	49	89	10	0,2	5	100
12	49	11,6	55	57	102	12	0,2	5	120
14	57	13,6	64	68	113	14	0,2	5	14000
16	65	15,5	73	75	123	16	0,2	5	160
18	73	17,5	82	86	134	18	0,2	5	18000
20	82	19,5	91	93	143	20	0,2	5	200
P									●
M									○
K									●
N									
S									○
H									
O									

→ v_c/f_z Page 368+369

CircularLine – End milling cutter with corner radius

The specialist for trochoidal machining

▲ Chip breaker 0.9 x DC

▲ Cutting depth: 2 x DC

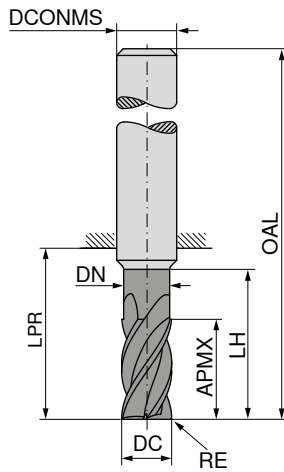
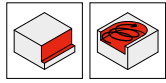
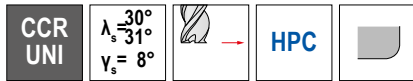

DPX72S

DRAGONSKIN



Factory standard



53 586 ...

DC _{e8} mm	RE _{±0.05} mm	APMX mm	DN mm	LH mm	LPR mm	OAL mm	DCONMS _{h6} mm	ZEFP	
6	0,2	13	5,8	19	21	57	6	6	06002
6	1,0	13	5,8	19	21	57	6	6	06010
6	1,5	13	5,8	19	21	57	6	6	06015
8	0,2	21	7,7	25	27	63	8	6	08002
8	1,0	21	7,7	25	27	63	8	6	08010
8	1,5	21	7,7	25	27	63	8	6	08015
8	2,0	21	7,7	25	27	63	8	6	08020
10	0,2	22	9,7	30	32	72	10	6	10002
10	1,0	22	9,7	30	32	72	10	6	10010
10	1,5	22	9,7	30	32	72	10	6	10015
10	1,6	22	9,7	30	32	72	10	6	10016
10	2,0	22	9,7	30	32	72	10	6	10020
12	0,2	26	11,6	36	38	83	12	6	12002
12	1,0	26	11,6	36	38	83	12	6	12010
12	1,5	26	11,6	36	38	83	12	6	12015
12	1,6	26	11,6	36	38	83	12	6	12016
12	2,0	26	11,6	36	38	83	12	6	12020
12	3,0	26	11,6	36	38	83	12	6	12030
14	0,2	26	13,6	36	38	83	14	6	14002
14	1,0	26	13,6	36	38	83	14	6	14010
14	1,5	26	13,6	36	38	83	14	6	14015
14	1,6	26	13,6	36	38	83	14	6	14016
14	2,0	30	13,6	36	38	83	14	6	14020
14	3,0	26	13,6	36	38	83	14	6	14030
16	0,2	36	15,5	42	44	92	16	6	16002
16	1,0	36	15,5	42	44	92	16	6	16010
16	1,5	36	15,5	42	44	92	16	6	16015
16	1,6	36	15,5	42	44	92	16	6	16016
16	2,0	36	15,5	42	44	92	16	6	16020
16	3,0	36	15,5	42	44	92	16	6	16030
16	4,0	36	15,5	42	44	92	16	6	16040
18	0,2	36	17,5	42	44	92	18	6	18002
18	1,0	36	17,5	42	44	92	18	6	18010
18	1,5	36	17,5	42	44	92	18	6	18015
18	1,6	36	17,5	42	44	92	18	6	18016
18	2,0	36	17,5	42	44	92	18	6	18020

P	●
M	○
K	●
N	●
S	○
H	○
O	○

→ v_c/f_z Page 366+367

CircularLine – End milling cutter with corner radius

The specialist for trochoidal machining

▲ Chip breaker 0.9 x DC

▲ Cutting depth: 2 x DC

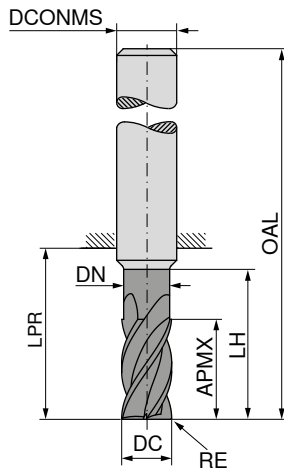
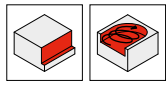
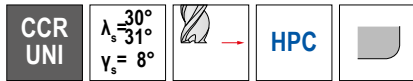

DPX72S

DRAGONSKIN



Factory standard



53 586 ...

DC _{e8} mm	RE _{±0.05} mm	APMX mm	DN mm	LH mm	LPR mm	OAL mm	DCONMS _{H6} mm	ZEFP	
18	3,0	36	17,5	42	44	92	18	6	18030
18	4,0	36	17,5	42	44	92	18	6	18040
20	0,2	41	19,5	52	54	104	20	6	20002
20	1,0	41	19,5	52	54	104	20	6	20010
20	1,5	41	19,5	52	54	104	20	6	20015
20	1,6	41	19,5	52	54	104	20	6	20016
20	2,0	41	19,5	52	54	104	20	6	20020
20	3,0	41	19,5	52	54	104	20	6	20030
20	4,0	41	19,5	52	54	104	20	6	20040

P	●
M	○
K	●
N	
S	○
H	
O	

→ v_c/f_z Page 366+367

CircularLine – End milling cutter with corner radius

The specialist for trochoidal machining

▲ Chip breaker 0.9 x DC

▲ Cutting depth: 3 x DC

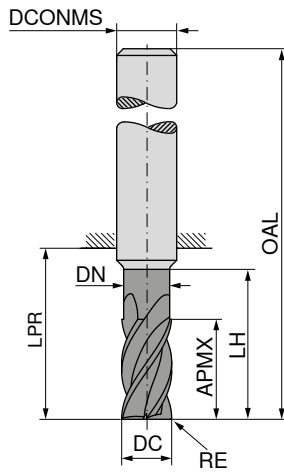
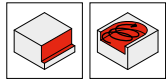
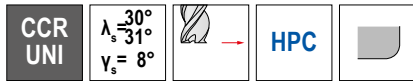

DPX72S

DRAGONSKIN



Factory standard



53 642 ...

DC _{e8} mm	RE _{±0.05} mm	APMX mm	DN mm	LH mm	LPR mm	OAL mm	DCONMS _{h6} mm	ZEFP	
6	0,2	19	5,8	25	27	63	6	6	06202
6	1,0	19	5,8	25	27	63	6	6	06210
6	1,5	19	5,8	25	27	63	6	6	06215
8	0,2	25	7,7	33	35	71	8	6	08202
8	1,0	25	7,7	33	35	71	8	6	08210
8	1,5	25	7,7	33	35	71	8	6	08215
8	2,0	25	7,7	33	35	71	8	6	08220
10	0,2	31	9,7	41	43	83	10	6	10202
10	1,0	31	9,7	41	43	83	10	6	10210
10	1,5	31	9,7	41	43	83	10	6	10215
10	1,6	31	9,7	41	43	83	10	6	10216
10	2,0	31	9,7	41	43	83	10	6	10220
12	0,2	37	11,6	47	49	94	12	6	12202
12	1,0	37	11,6	47	49	94	12	6	12210
12	1,5	37	11,6	47	49	94	12	6	12215
12	1,6	37	11,6	47	49	94	12	6	12216
12	2,0	37	11,6	47	49	94	12	6	12220
12	3,0	37	11,6	47	49	94	12	6	12230
14	0,2	43	13,6	55	59	104	14	6	14202
14	1,0	43	13,6	55	59	104	14	6	14210
14	1,5	43	13,6	55	59	104	14	6	14215
14	1,6	43	13,6	55	59	104	14	6	14216
14	2,0	43	13,6	55	59	104	14	6	14220
14	3,0	43	13,6	55	59	104	14	6	14230
16	0,2	49	15,5	61	63	111	16	6	16202
16	1,0	49	15,5	61	63	111	16	6	16210
16	1,5	49	15,5	61	63	111	16	6	16215
16	1,6	49	15,5	61	63	111	16	6	16216
16	2,0	49	15,5	61	63	111	16	6	16220
16	3,0	49	15,5	61	63	111	16	6	16230
16	4,0	49	15,5	61	63	111	16	6	16240
18	0,2	55	17,5	69	73	121	18	6	18202
18	1,0	55	17,5	69	73	121	18	6	18210
18	1,5	55	17,5	69	73	121	18	6	18215
18	1,6	55	17,5	69	73	121	18	6	18216
18	2,0	55	17,5	69	73	121	18	6	18220

P	●
M	○
K	●
N	●
S	○
H	○
O	○

→ v_c/f_z Page 366+367

CircularLine – End milling cutter with corner radius

The specialist for trochoidal machining

▲ Chip breaker 0.9 x DC

▲ Cutting depth: 3 x DC

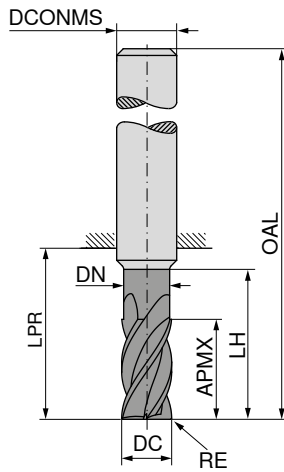
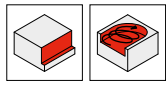
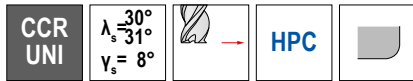

DPX72S

DRAGONSKIN



Factory standard



53 642 ...

DC _{e8} mm	RE _{±0.05} mm	APMX mm	DN mm	LH mm	LPR mm	OAL mm	DCONMS _{H6} mm	ZEFP	
18	3,0	55	17,5	69	73	121	18	6	18230
18	4,0	55	17,5	69	73	121	18	6	18240
20	0,2	61	19,5	75	77	127	20	6	20202
20	1,0	61	19,5	75	77	127	20	6	20210
20	1,5	61	19,5	75	77	127	20	6	20215
20	1,6	61	19,5	75	77	127	20	6	20216
20	2,0	61	19,5	75	77	127	20	6	20220
20	3,0	61	19,5	75	77	127	20	6	20230
20	4,0	61	19,5	75	77	127	20	6	20240

P	●
M	○
K	●
N	
S	○
H	
O	

→ v_c/f_z Page 366+367

CircularLine – End milling cutter with corner radius

The specialist for trochoidal machining

▲ Chip breaker 0.9 x DC

▲ Cutting depth: 4 x DC

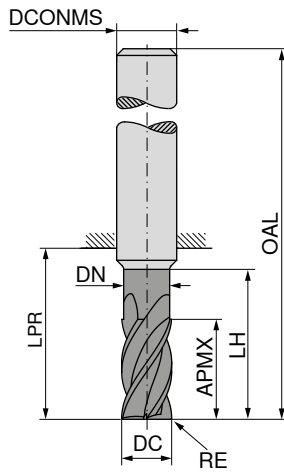
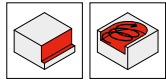
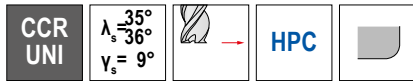

DPX72S

DRAGONSKIN



Factory standard



53 593 ...

DC _{e8} mm	RE _{±0.05} mm	APMX mm	DN mm	LH mm	LPR mm	OAL mm	DCONMS _{h6} mm	ZEFP	
6	0,2	25	5,8	29	31	67	6	5	06002
6	1,0	25	5,8	29	31	67	6	5	06010
6	1,5	25	5,8	29	31	67	6	5	06015
8	0,2	33	7,7	38	40	76	8	5	08002
8	1,0	33	7,7	38	40	76	8	5	08010
8	1,5	33	7,7	38	40	76	8	5	08015
8	2,0	33	7,7	38	40	76	8	5	08020
10	0,2	41	9,7	47	49	89	10	5	10002
10	1,0	41	9,7	47	49	89	10	5	10010
10	1,5	41	9,7	47	49	89	10	5	10015
10	1,6	41	9,7	47	49	89	10	5	10016
10	2,0	41	9,7	47	49	89	10	5	10020
12	0,2	49	11,6	55	57	102	12	5	12002
12	1,0	49	11,6	55	57	102	12	5	12010
12	1,5	49	11,6	55	57	102	12	5	12015
12	1,6	49	11,6	55	57	102	12	5	12016
12	2,0	49	11,6	55	57	102	12	5	12020
12	3,0	49	11,6	55	57	102	12	5	12030
14	0,2	57	13,6	64	68	113	14	5	14002
14	1,0	57	13,6	64	68	113	14	5	14010
14	1,5	57	13,6	64	68	113	14	5	14015
14	1,6	57	13,6	64	68	113	14	5	14016
14	2,0	57	13,6	64	68	113	14	5	14020
14	3,0	57	13,6	64	68	113	14	5	14030
16	0,2	65	15,5	73	75	123	16	5	16002
16	1,0	65	15,5	73	75	123	16	5	16010
16	1,5	65	15,5	73	75	123	16	5	16015
16	1,6	65	15,5	73	75	123	16	5	16016
16	2,0	65	15,5	73	75	123	16	5	16020
16	3,0	65	15,5	73	75	123	16	5	16030
16	4,0	65	15,5	73	75	123	16	5	16040
18	0,2	73	17,5	82	86	134	18	5	18002
18	1,0	73	17,5	82	86	134	18	5	18010
18	1,5	73	17,5	82	86	134	18	5	18015
18	1,6	73	17,5	82	86	134	18	5	18016
18	2,0	73	17,5	82	86	134	18	5	18020

P	●
M	○
K	●
N	
S	○
H	
O	

→ v_c/f_z Page 368+369

CircularLine – End milling cutter with corner radius

The specialist for trochoidal machining

▲ Chip breaker 0.9 x DC

▲ Cutting depth: 4 x DC

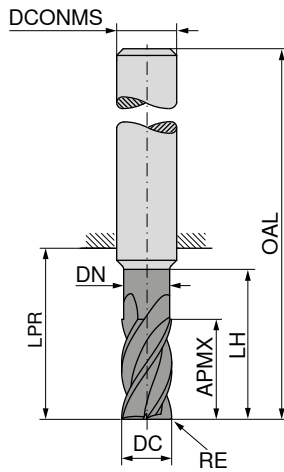
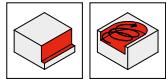
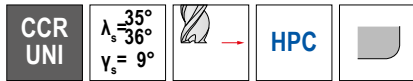

DPX72S

DRAGONSKIN



Factory standard



53 593 ...

DC _{es} mm	RE _{±0.05} mm	APMX mm	DN mm	LH mm	LPR mm	OAL mm	DCONMS _{h6} mm	ZEFP	
18	3,0	73	17,5	82	86	134	18	5	18030
18	4,0	73	17,5	82	86	134	18	5	18040
20	0,2	82	19,5	91	93	143	20	5	20002
20	1,0	82	19,5	91	93	143	20	5	20010
20	1,5	82	19,5	91	93	143	20	5	20015
20	1,6	82	19,5	91	93	143	20	5	20016
20	2,0	82	19,5	91	93	143	20	5	20020
20	3,0	82	19,5	91	93	143	20	5	20030
20	4,0	82	19,5	91	93	143	20	5	20040

P	●
M	○
K	●
N	
S	○
H	
O	

→ v_c/f_z Page 368+369

CircularLine – End milling cutter with corner radius

The specialist for trochoidal machining

▲ Chip breaker 0.9 x DC

▲ Cutting depth: 5 x DC

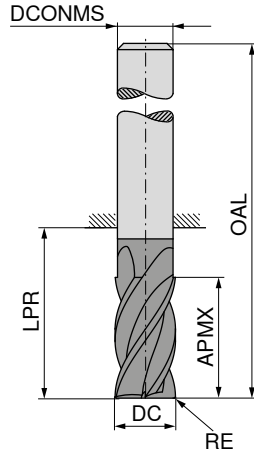
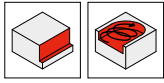
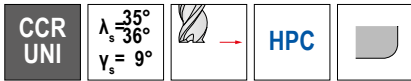

DPX72S

DRAGONSKIN



Factory standard



53 593 ...

DC _{e8} mm	RE _{±0.05} mm	APMX mm	LPR mm	OAL mm	DCONMS _{h6} mm	ZEFP	
6,0	0,2	31	39	75	6	5	06402
6,0	1,0	31	39	75	6	5	06410
6,0	1,5	31	39	75	6	5	06415
8,0	0,2	41	49	85	8	5	08402
8,0	1,0	41	49	85	8	5	08410
8,0	1,5	41	49	85	8	5	08415
8,0	2,0	41	49	85	8	5	08420
10,0	0,2	51	60	100	10	5	10402
10,0	1,0	51	60	100	10	5	10410
10,0	1,5	51	60	100	10	5	10415
10,0	1,6	51	60	100	10	5	10416
10,0	2,0	51	60	100	10	5	10420
12,0	0,2	61	70	115	12	5	12402
12,0	1,0	61	70	115	12	5	12410
12,0	1,5	61	70	115	12	5	12415
12,0	1,6	61	70	115	12	5	12416
12,0	2,0	61	70	115	12	5	12420
12,0	3,0	61	70	115	12	5	12430
14,0	0,2	71	81	126	14	5	14402
14,0	1,0	71	81	126	14	5	14410
14,0	1,5	71	81	126	14	5	14415
14,0	1,6	71	81	126	14	5	14416
14,0	2,0	71	81	126	14	5	14420
14,0	3,0	71	81	126	14	5	14430
16,0	0,2	81	92	140	16	5	16402
16,0	1,0	81	92	140	16	5	16410
16,0	1,5	81	92	140	16	5	16415
16,0	1,6	81	92	140	16	5	16416
16,0	2,0	81	92	140	16	5	16420
16,0	3,0	81	92	140	16	5	16430
16,0	4,0	81	92	140	16	5	16440
18,0	0,2	91	102	150	18	5	18402
18,0	1,0	91	102	150	18	5	18410
18,0	1,5	91	102	150	18	5	18415
18,0	1,6	91	102	150	18	5	18416
18,0	2,0	91	102	150	18	5	18420

P	●
M	○
K	●
N	
S	○
H	
O	

CircularLine – End milling cutter with corner radius

The specialist for trochoidal machining

▲ Chip breaker 0.9 x DC

▲ Cutting depth: 5 x DC

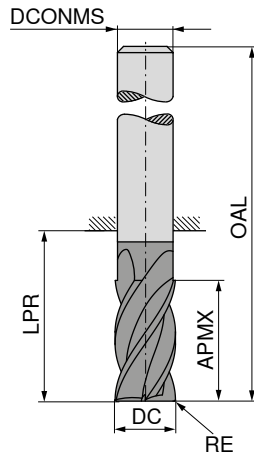
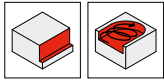
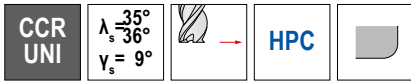

Factory standard



53 593 ...

DC _{e8} mm	RE _{±0.05} mm	APMX mm	LPR mm	OAL mm	DCONMS _{h6} mm	ZEFP	
18,0	3,0	91	102	150	18	5	18430
18,0	4,0	91	102	150	18	5	18440
20,0	0,2	102	113	163	20	5	20402
20,0	1,0	102	113	163	20	5	20410
20,0	1,5	102	113	163	20	5	20415
20,0	1,6	102	113	163	20	5	20416
20,0	2,0	102	113	163	20	5	20420
20,0	3,0	102	113	163	20	5	20430
20,0	4,0	102	113	163	20	5	20440

P	●
M	○
K	●
N	
S	○
H	
O	

→ v_c/f_z Page 368+369

CircularLine – End milling cutter with corner radius

The specialist for trochoidal machining

▲ Chip breaker 0.9 x DC

▲ Cutting depth: 3 x DC

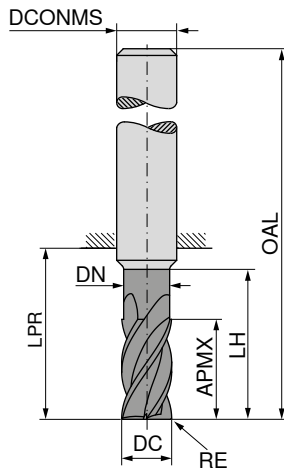
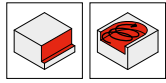
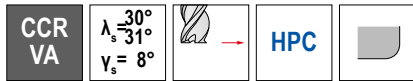

DPX22S

DRAGONSKIN



Factory standard



53 643 ...

DC _{e8}	RE _{±0.05}	APMX	DN	LH	LPR	OAL	DCONMS _{h6}	ZEFP	
mm	mm	mm	mm	mm	mm	mm	mm		
6	0,2	19	5,8	25	27	63	6	6	06202
6	1,0	19	5,8	25	27	63	6	6	06210
6	1,5	19	5,8	25	27	63	6	6	06215
8	0,2	25	7,7	33	35	71	8	6	08202
8	1,0	25	7,7	33	35	71	8	6	08210
8	1,5	25	7,7	33	35	71	8	6	08215
8	2,0	25	7,7	33	35	71	8	6	08220
10	0,2	31	9,7	41	43	83	10	6	10202
10	1,0	31	9,7	41	43	83	10	6	10210
10	1,5	31	9,7	41	43	83	10	6	10215
10	2,0	31	9,7	41	43	83	10	6	10220
12	0,2	37	11,6	47	49	94	12	6	12202
12	1,0	37	11,6	47	49	94	12	6	12210
12	1,5	37	11,6	47	49	94	12	6	12215
12	2,0	37	11,6	47	49	94	12	6	12220
12	3,0	37	11,6	47	49	94	12	6	12230
14	0,2	43	13,6	55	59	104	14	6	14202
14	1,0	43	13,6	55	59	104	14	6	14210
14	1,5	43	13,6	55	59	104	14	6	14215
14	2,0	43	13,6	55	59	104	14	6	14220
14	3,0	43	13,6	55	59	104	14	6	14230
16	0,2	49	15,5	61	63	111	16	6	16202
16	1,0	49	15,5	61	63	111	16	6	16210
16	1,5	49	15,5	61	63	111	16	6	16215
16	2,0	49	15,5	61	63	111	16	6	16220
16	3,0	49	15,5	61	63	111	16	6	16230
16	4,0	49	15,5	61	63	111	16	6	16240
18	0,2	55	17,5	69	73	121	18	6	18202
18	1,0	55	17,5	69	73	121	18	6	18210
18	1,5	55	17,5	69	73	121	18	6	18215
18	2,0	55	17,5	69	73	121	18	6	18220
18	3,0	55	17,5	69	73	121	18	6	18230
18	4,0	55	17,5	69	73	121	18	6	18240
20	0,2	61	19,5	75	77	127	20	6	20202
20	1,0	61	19,5	75	77	127	20	6	20210
20	1,5	61	19,5	75	77	127	20	6	20215
20	2,0	61	19,5	75	77	127	20	6	20220
20	3,0	61	19,5	75	77	127	20	6	20230
20	4,0	61	19,5	75	77	127	20	6	20040

P	○
M	●
K	
N	
S	●
H	
O	

→ v_c/f_z Page 370+371

CircularLine – End milling cutter with corner radius

The specialist for trochoidal machining

▲ Chip breaker 0.9 x DC

▲ Cutting depth: 4 x DC

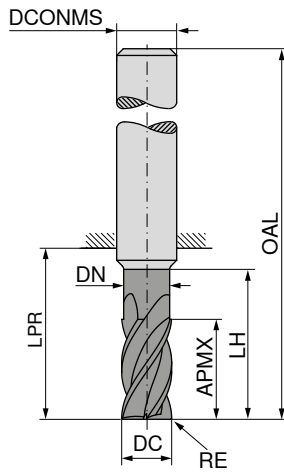
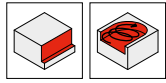
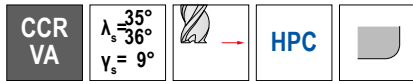

DPX22S

DRAGONSKIN



Factory standard



53 644 ...

DC _{e8} mm	RE _{±0.05} mm	APMX mm	DN mm	LH mm	LPR mm	OAL mm	DCONMS _{h6} mm	ZEFP	
6	0,2	25	5,8	29	31	67	6	5	06002
6	1,0	25	5,8	29	31	67	6	5	06010
6	1,5	25	5,8	29	31	67	6	5	06015
8	0,2	33	7,7	38	40	76	8	5	08002
8	1,0	33	7,7	38	40	76	8	5	08010
8	1,5	33	7,7	38	40	76	8	5	08015
8	2,0	33	7,7	38	40	76	8	5	08020
10	0,2	41	9,7	47	49	89	10	5	10002
10	1,0	41	9,7	47	49	89	10	5	10010
10	1,5	41	9,7	47	49	89	10	5	10015
10	2,0	41	9,7	47	49	89	10	5	10020
12	0,2	49	11,6	55	57	102	12	5	12002
12	1,0	49	11,6	55	57	102	12	5	12010
12	1,5	49	11,6	55	57	102	12	5	12015
12	2,0	49	11,6	55	57	102	12	5	12020
12	3,0	49	11,6	55	57	102	12	5	12030
14	0,2	57	13,6	64	68	113	14	5	14002
14	1,0	57	13,6	64	68	113	14	5	14010
14	1,5	57	13,6	64	68	113	14	5	14015
14	2,0	57	13,6	64	68	113	14	5	14020
14	3,0	57	13,6	64	68	113	14	5	14030
16	0,2	65	15,5	73	75	123	16	5	16002
16	1,0	65	15,5	73	75	123	16	5	16010
16	1,5	65	15,5	73	75	123	16	5	16015
16	2,0	65	15,5	73	75	123	16	5	16020
16	3,0	65	15,5	73	75	123	16	5	16030
16	4,0	65	15,5	73	75	123	16	5	16040
18	0,2	73	17,5	82	86	134	18	5	18002
18	1,0	73	17,5	82	86	134	18	5	18010
18	1,5	73	17,5	82	86	134	18	5	18015
18	2,0	73	17,5	82	86	134	18	5	18020
18	3,0	73	17,5	82	86	134	18	5	18030
18	4,0	73	17,5	82	86	134	18	5	18040
20	0,2	82	19,5	91	93	143	20	5	20002
20	1,0	82	19,5	91	93	143	20	5	20010
20	1,5	82	19,5	91	93	143	20	5	20015
20	2,0	82	19,5	91	93	143	20	5	20020
20	3,0	82	19,5	91	93	143	20	5	20030
20	4,0	82	19,5	91	93	143	20	5	20040

P	○
M	●
K	
N	
S	
H	●
O	

→ v_c/f_z Page 372+373

CircularLine – End milling cutter

The specialist for trochoidal machining

- ▲ Chip breaker 1.8 x DC
- ▲ 53 590 ... Cutting depth: 3 x DC
- ▲ 53 591 ... Cutting depth: 4 x DC

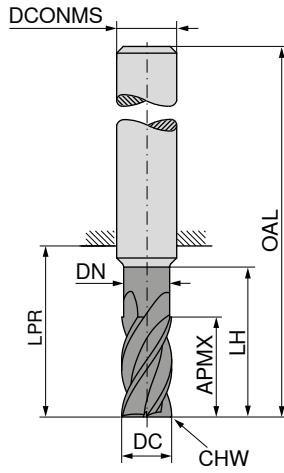
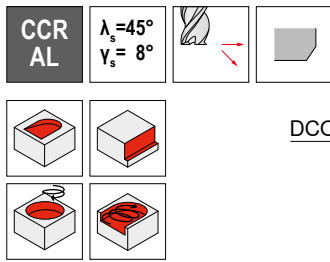

DC ₈₈ mm	APMX mm	DN mm	LH mm	LPR mm	OAL mm	DCONMS ₁₆ mm	CHW mm	ZEFP
6	19	5,8	24	30	66	6	0,2	4
6	25	5,8	30	35	71	6	0,2	4
8	25	7,7	32	37	73	8	0,2	4
8	33	7,7	40	44	80	8	0,2	4
10	31	9,7	40	49	89	10	0,2	4
10	41	9,7	50	55	95	10	0,2	4
12	37	11,6	48	56	101	12	0,2	4
12	49	11,6	60	64	109	12	0,2	4
14	43	13,0	56	60	105	14	0,2	4
14	57	13,0	70	74	119	14	0,2	4
16	49	15,5	64	72	120	16	0,2	4
16	65	15,5	80	84	132	16	0,2	4
18	56	17,0	72	76	124	18	0,2	4
18	74	17,0	90	94	142	18	0,2	4
20	62	19,5	80	84	134	20	0,2	4
20	82	19,5	100	104	154	20	0,2	4

	53 590 ...	53 591 ...
P		
M		
K		
N	●	●
S		
H		
O		

→ v_c/f_z Page 374+375

CircularLine – End milling cutter with corner radius

The specialist for trochoidal machining

▲ Chip breaker 1.8 x DC

▲ Cutting depth: 3 x DC

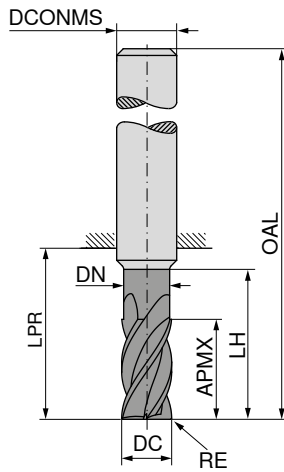
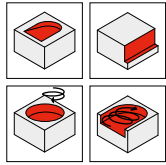
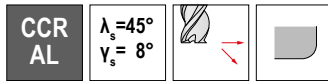

Factory standard



53 594 ...

DC _{e8} mm	RE _{±0.05} mm	APMX mm	DN mm	LH mm	LPR mm	OAL mm	DCONMS _{h6} mm	ZEFP	
6	0,2	19	5,8	24	30	66	6	4	06002
6	1,0	19	5,8	24	30	66	6	4	06010
6	1,5	19	5,8	24	30	66	6	4	06015
8	0,2	25	7,7	32	37	73	8	4	08002
8	1,0	25	7,7	32	37	73	8	4	08010
8	1,5	25	7,7	32	37	73	8	4	08015
8	2,0	25	7,7	32	37	73	8	4	08020
10	0,2	31	9,7	40	49	89	10	4	10002
10	1,0	31	9,7	40	49	89	10	4	10010
10	1,5	31	9,7	40	49	89	10	4	10015
10	1,6	31	9,7	40	49	89	10	4	10016
10	2,0	31	9,7	40	49	89	10	4	10020
12	0,2	37	11,6	48	56	101	12	4	12002
12	1,0	37	11,6	48	56	101	12	4	12010
12	1,5	37	11,6	48	56	101	12	4	12015
12	1,6	37	11,6	48	56	101	12	4	12016
12	2,0	37	11,6	48	56	101	12	4	12020
12	3,0	37	11,6	48	56	101	12	4	12030
14	0,2	43	13,0	56	60	105	14	4	14002
14	1,0	43	13,0	56	60	105	14	4	14010
14	1,5	43	13,0	56	60	105	14	4	14015
14	1,6	43	13,0	56	60	105	14	4	14016
14	2,0	43	13,0	56	60	105	14	4	14020
14	3,0	43	13,0	56	60	105	14	4	14030
16	0,2	49	15,5	64	72	120	16	4	16002
16	1,0	49	15,5	64	72	120	16	4	16010
16	1,5	49	15,5	64	72	120	16	4	16015
16	1,6	49	15,5	64	72	120	16	4	16016
16	2,0	49	15,5	64	72	120	16	4	16020
16	3,0	49	15,5	64	72	120	16	4	16030
16	4,0	49	15,5	64	72	120	16	4	16040
18	0,2	56	17,0	72	76	124	18	4	18002
18	1,0	56	17,0	72	76	124	18	4	18010
18	1,5	56	17,0	72	76	124	18	4	18015
18	1,6	56	17,0	72	76	124	18	4	18016
18	2,0	56	17,0	72	76	124	18	4	18020

P
M
K
N
S
H
O

CircularLine – End milling cutter with corner radius

The specialist for trochoidal machining

▲ Chip breaker 1.8 x DC

▲ Cutting depth: 3 x DC

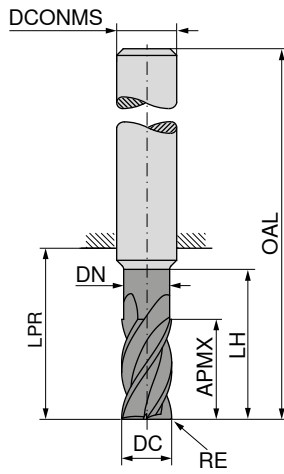
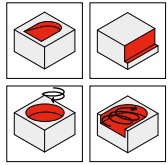
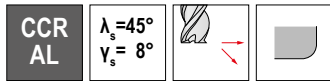

DLC

DRAGONSKIN



Factory standard



53 594 ...

DC _{e8} mm	RE _{±0.05} mm	APMX mm	DN mm	LH mm	LPR mm	OAL mm	DCONMS _{h6} mm	ZEFP	
18	3,0	56	17,0	72	76	124	18	4	18030
18	4,0	56	17,0	72	76	124	18	4	18040
20	0,2	62	19,5	80	84	134	20	4	20002
20	1,0	62	19,5	80	84	134	20	4	20010
20	1,5	62	19,5	80	84	134	20	4	20015
20	1,6	62	19,5	80	84	134	20	4	20016
20	2,0	62	19,5	80	84	134	20	4	20020
20	3,0	62	19,5	80	84	134	20	4	20030
20	4,0	62	19,5	80	84	134	20	4	20040

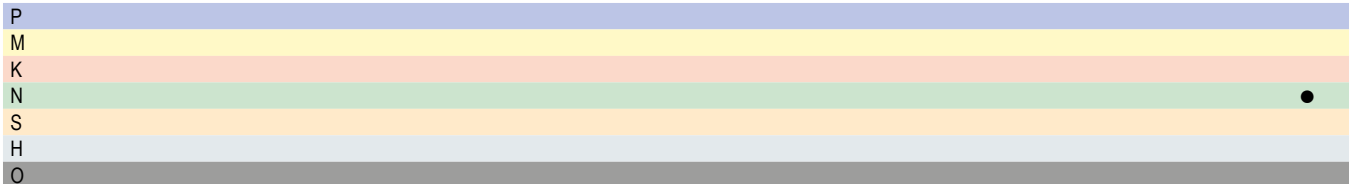

→ v_c/f_z Page 374+375

CircularLine – End milling cutter with corner radius

The specialist for trochoidal machining

▲ Chip breaker 1.8 x DC

▲ Cutting depth: 4 x DC

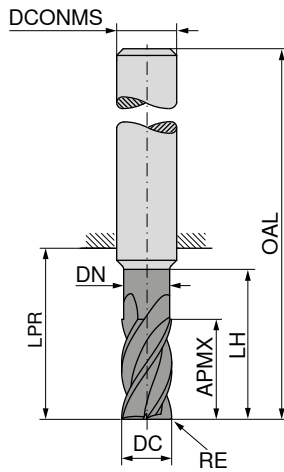
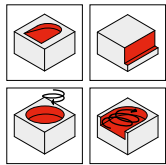
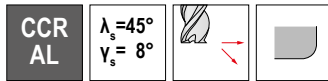

Factory standard



53 595 ...

DC _{e8} mm	RE _{±0.05} mm	APMX mm	DN mm	LH mm	LPR mm	OAL mm	DCONMS _{h6} mm	ZEFP	
6	0,2	25	5,8	30	35	71	6	4	06002
6	1,0	25	5,8	30	35	71	6	4	06010
6	1,5	25	5,8	30	35	71	6	4	06015
8	0,2	33	7,7	40	44	80	8	4	08002
8	1,0	33	7,7	40	44	80	8	4	08010
8	1,5	33	7,7	40	44	80	8	4	08015
8	2,0	33	7,7	40	44	80	8	4	08020
10	0,2	41	9,7	50	55	95	10	4	10002
10	1,0	41	9,7	50	55	95	10	4	10010
10	1,5	41	9,7	50	55	95	10	4	10015
10	1,6	41	9,7	50	55	95	10	4	10016
10	2,0	41	9,7	50	55	95	10	4	10020
12	0,2	49	11,6	60	64	109	12	4	12002
12	1,0	49	11,6	60	64	109	12	4	12010
12	1,5	49	11,6	60	64	109	12	4	12015
12	1,6	49	11,6	60	64	109	12	4	12016
12	2,0	49	11,6	60	64	109	12	4	12020
12	3,0	49	11,6	60	64	109	12	4	12030
14	0,2	57	13,0	70	74	119	14	4	14002
14	1,0	57	13,0	70	74	119	14	4	14010
14	1,5	57	13,0	70	74	119	14	4	14015
14	1,6	57	13,0	70	74	119	14	4	14016
14	2,0	57	13,0	70	74	119	14	4	14020
14	3,0	57	13,0	70	74	119	14	4	14030
16	0,2	65	15,5	80	84	132	16	4	16002
16	1,0	65	15,5	80	84	132	16	4	16010
16	1,5	65	15,5	80	84	132	16	4	16015
16	1,6	65	15,5	80	84	132	16	4	16016
16	2,0	65	15,5	80	84	132	16	4	16020
16	3,0	65	15,5	80	84	132	16	4	16030
16	4,0	65	15,5	80	84	132	16	4	16040
18	0,2	74	17,0	90	94	142	18	4	18002
18	1,0	74	17,0	90	94	142	18	4	18010
18	1,5	74	17,0	90	94	142	18	4	18015
18	1,6	74	17,0	90	94	142	18	4	18016
18	2,0	74	17,0	90	94	142	18	4	18020

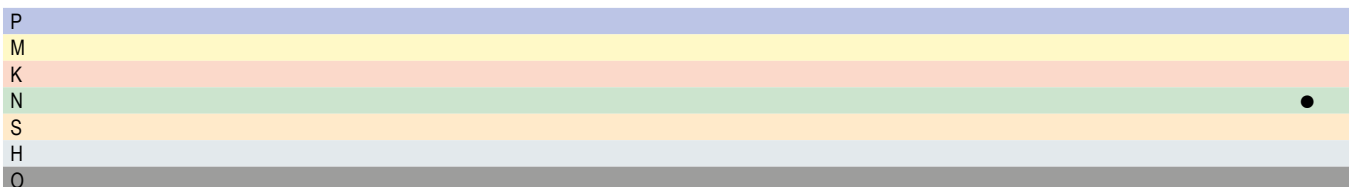

CircularLine – End milling cutter with corner radius

The specialist for trochoidal machining

▲ Chip breaker 1.8 x DC

▲ Cutting depth: 4 x DC

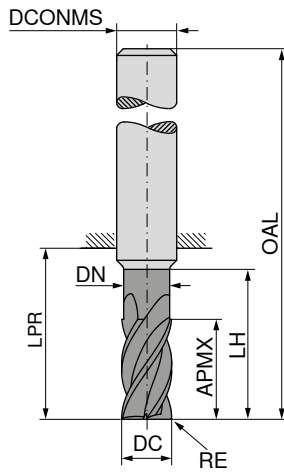
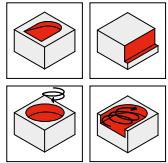
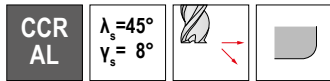

DLC

DRAGONSKIN



Factory standard



53 595 ...

DC _{e8} mm	RE _{±0.05} mm	APMX mm	DN mm	LH mm	LPR mm	OAL mm	DCONMS _{H6} mm	ZEFP	
18	3,0	74	17,0	90	94	142	18	4	18030
18	4,0	74	17,0	90	94	142	18	4	18040
20	0,2	82	19,5	100	104	154	20	4	20002
20	1,0	82	19,5	100	104	154	20	4	20010
20	1,5	82	19,5	100	104	154	20	4	20015
20	1,6	82	19,5	100	104	154	20	4	20016
20	2,0	82	19,5	100	104	154	20	4	20020
20	3,0	82	19,5	100	104	154	20	4	20030
20	4,0	82	19,5	100	104	154	20	4	20040

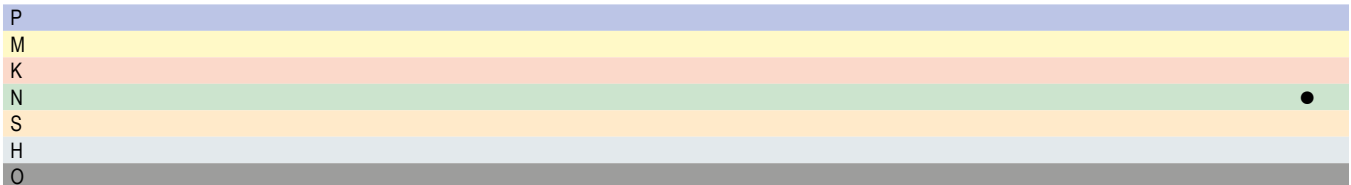

→ v_c/f_z Page 374+375

CircularLine – End milling cutter with corner radius

The specialist for trochoidal machining

▲ Chip breaker 1.8 x DC

▲ Cutting depth: 5 x DC

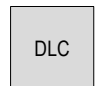
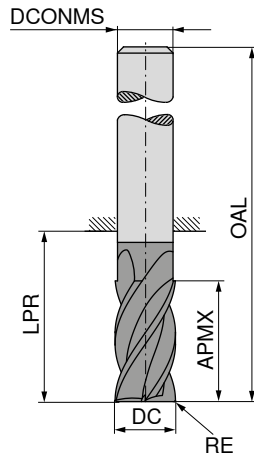
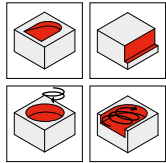
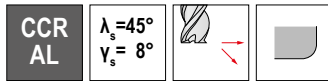

Factory standard



53 641 ...

DC _{h8} mm	RE _{±0.05} mm	APMX mm	LPR mm	OAL mm	DCONMS _{h6} mm	ZEFP	
6	0,2	31	40	76	6	4	06002
6	1,0	31	40	76	6	4	06010
6	1,5	31	40	76	6	4	06015
8	0,2	41	50	86	8	4	08002
8	1,0	41	50	86	8	4	08010
8	1,5	41	50	86	8	4	08015
8	2,0	41	50	86	8	4	08020
10	0,2	51	61	101	10	4	10002
10	1,0	51	61	101	10	4	10010
10	1,5	51	61	101	10	4	10015
10	2,0	51	61	101	10	4	10020
12	0,2	61	71	116	12	4	12002
12	1,0	61	71	116	12	4	12010
12	1,5	61	71	116	12	4	12015
12	2,0	61	71	116	12	4	12020
14	0,2	71	82	127	14	4	14002
14	1,0	71	82	127	14	4	14010
14	1,5	71	82	127	14	4	14015
14	2,0	71	82	127	14	4	14020
16	0,2	81	93	141	16	4	16002
16	1,0	81	93	141	16	4	16010
16	1,5	81	93	141	16	4	16015
16	2,0	81	93	141	16	4	16020
18	0,2	91	103	151	18	4	18002
18	1,0	91	103	151	18	4	18010
18	1,5	91	103	151	18	4	18015
18	2,0	91	103	151	18	4	18020
20	0,2	102	114	164	20	4	20002
20	1,0	102	114	164	20	4	20010
20	1,5	102	114	164	20	4	20015
20	2,0	102	114	164	20	4	20020

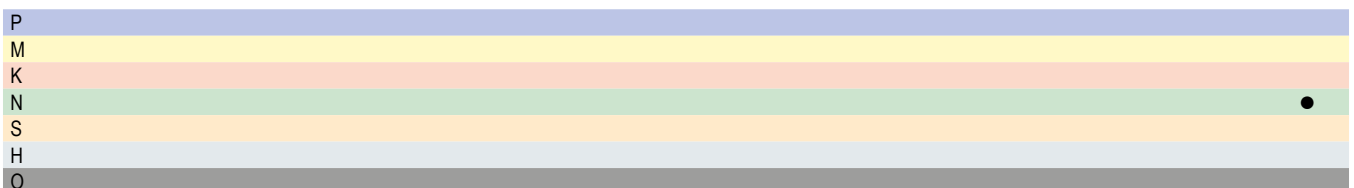

→ v_c/f_z Page 374+375

CircularLine – End milling cutter with corner radius

The specialist for machining titanium and titanium alloys

- ▲ Chip breaker 0.9 x DC
- ▲ Long cutting depth version: 3 x DC
- ▲ Extra-long cutting depth version: 4 x DC

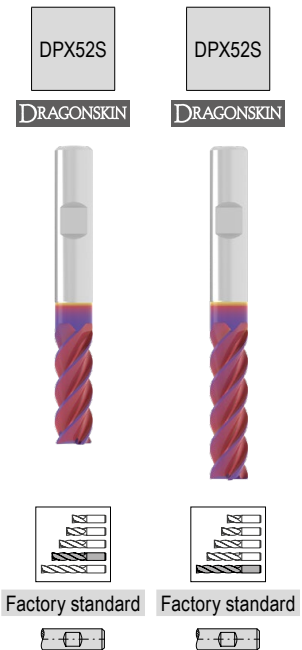
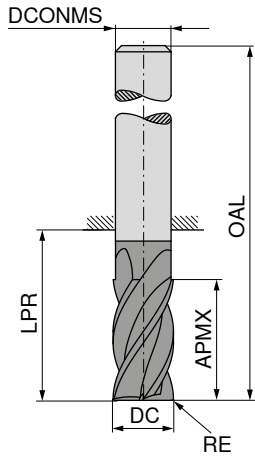
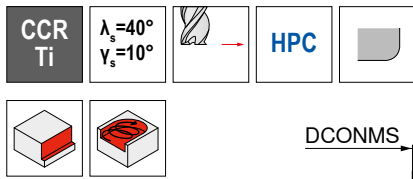

DC _{e8} mm	RE _{±0.01} mm	APMX mm	LPR mm	OAL mm	DCONMS _{h5} mm	ZFP
6	0,1	18	29	65	6	5
6	0,1	24	31	67	6	5
8	0,2	24	34	70	8	5
8	0,2	32	44	80	8	5
10	0,2	30	40	80	10	5
10	0,2	40	50	90	10	5
12	0,2	36	50	95	12	5
12	0,2	48	55	100	12	5
16	0,2	48	62	110	16	5
16	0,3	64	72	120	16	5
20	0,3	60	75	125	20	5
20	0,3	80	90	140	20	5

	52 510 ...	52 510 ...
P	○	○
M	○	○
K		
N		
S	●	●
H		
O		

→ v_c/f_z Page 376+377

CircularLine – End milling cutter with corner radius

The specialist for trochoidal machining

▲ Chip breaker 0.9 x DC

▲ Cutting depth: 3 x DC

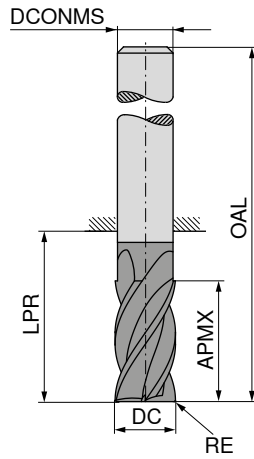
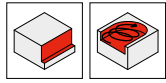
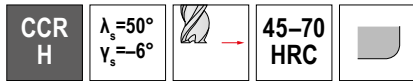

DPX62S

DRAGONSKIN



Factory standard



53 596 ...

DC _{e8} mm	RE _{±0.05} mm	APMX mm	LPR mm	OAL mm	DCONMS _{h6} mm	ZFP	
6	0,2	19	24	60	6	6	06002
6	1,0	19	24	60	6	6	06010
8	0,2	25	31	67	8	6	08002
8	1,0	25	31	67	8	6	08010
10	0,2	31	37	77	10	6	10002
10	1,0	31	37	77	10	6	10010
10	1,5	31	37	77	10	6	10015
12	0,2	37	43	88	12	6	12002
12	1,0	37	43	88	12	6	12010
12	1,5	37	43	88	12	6	12015
12	2,0	37	43	88	12	6	12020
12	3,0	37	43	88	12	6	12030
16	0,2	49	56	104	16	6	16002
16	1,0	49	56	104	16	6	16010
16	1,5	49	56	104	16	6	16015
16	2,0	49	56	104	16	6	16020
16	3,0	49	56	104	16	6	16030
20	0,2	61	68	118	20	6	20002
20	1,0	61	68	118	20	6	20010
20	1,5	61	68	118	20	6	20015
20	2,0	61	68	118	20	6	20020
20	3,0	61	68	118	20	6	20030

P
M
K
N
S
H
O

→ v_c/f_z Page 378

AluLine – End milling cutter

The specialist for machining non-ferrous metals

▲ With polished chip flutes

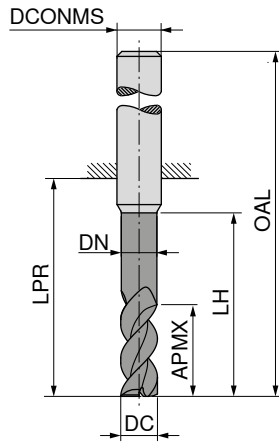
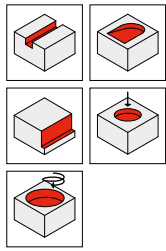
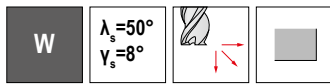

DRAGONSKIN



DRAGONSKIN

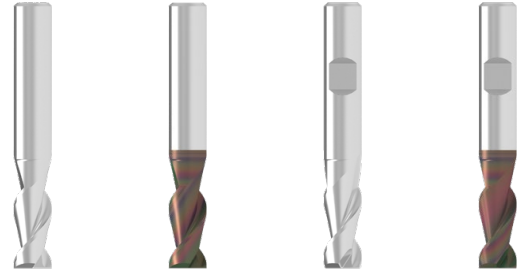

Factory standard



Factory standard



Factory standard



Factory standard



53 623 ...



53 625 ...



53 624 ...



53 626 ...

DC _{h6} mm	APMX mm	DN mm	LH mm	LPR mm	OAL mm	DCONMS _{h6} mm	ZEFP
5,0	10,5	4,8	15	22	58	6	2
5,5	13,0	5,3	18	22	58	6	2
6,0	13,0	5,8	18	22	58	6	2
6,5	17,0	6,2	24	28	64	8	2
7,0	17,0	6,7	24	28	64	8	2
7,5	17,0	7,2	24	28	64	8	2
8,0	17,0	7,7	24	28	64	8	2
8,5	21,0	8,2	30	34	74	10	2
9,0	21,0	8,7	30	34	74	10	2
9,5	21,0	9,2	30	34	74	10	2
10,0	21,0	9,7	30	34	74	10	2
10,5	25,0	10,1	36	40	85	12	2
11,0	25,0	10,6	36	40	85	12	2
11,5	25,0	11,1	36	40	85	12	2
12,0	25,0	11,6	36	40	85	12	2
12,5	29,0	12,1	42	46	91	14	2
13,0	29,0	12,6	42	46	91	14	2
13,5	29,0	13,1	42	46	91	14	2
14,0	29,0	13,6	42	46	91	14	2
14,5	33,0	14,0	48	52	100	16	2
15,0	33,0	14,5	48	52	100	16	2
15,5	33,0	15,0	48	52	100	16	2
16,0	33,0	15,5	48	52	100	16	2
16,5	38,0	16,0	54	58	106	18	2
17,0	38,0	16,5	54	58	106	18	2
17,5	38,0	17,0	54	58	106	18	2
18,0	38,0	17,5	54	58	106	18	2
18,5	42,0	18,0	60	64	114	20	2
19,0	42,0	18,5	60	64	114	20	2
19,5	42,0	19,0	60	64	114	20	2
20,0	42,0	19,5	60	64	114	20	2

P				
M				
K				
N				
S				
H				
O				

→ v_c/f_z Page 414+415

AluLine – End milling cutter

The specialist for machining non-ferrous metals

▲ With polished chip flutes

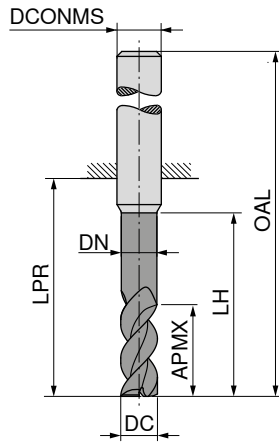
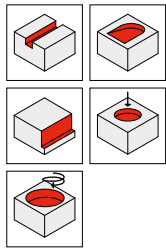

DRAGONSKIN



DRAGONSKIN

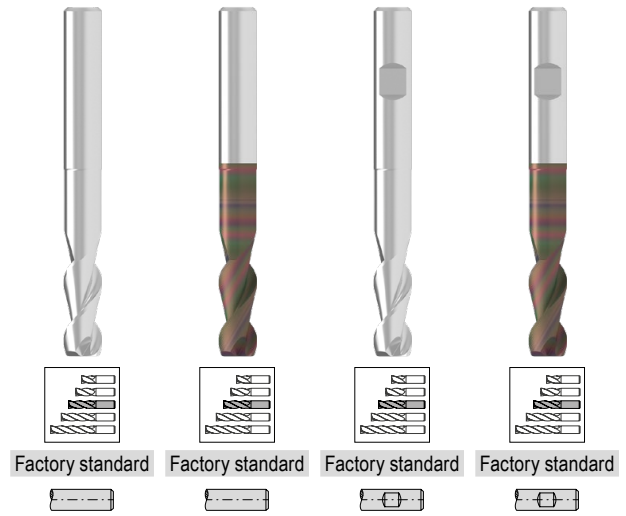

53 633 ... 53 635 ... 53 634 ... 53 636 ...

DC _{h6}	APMX	DN	LH	LPR	OAL	DCONMS _{h6}	ZEFP					
mm	mm	mm	mm	mm	mm	mm						
2,0	5,5	1,8	10,0	19	55	6	2		02300	02300	02300	02300
2,5	6,5	2,3	12,5	22	58	6	2		02800	02800	02800	02800
3,0	8,0	2,8	15,0	22	58	6	2		03300	03300	03300	03300
3,5	10,5	3,3	20,0	26	62	6	2		03800	03800	03800	03800
4,0	10,5	3,8	20,0	26	62	6	2		04300	04300	04300	04300
4,5	13,0	4,3	25,0	34	70	6	2		04800	04800	04800	04800
5,0	13,0	4,8	25,0	34	70	6	2		05300	05300	05300	05300
5,5	16,0	5,3	30,0	34	70	6	2		05800	05800	05800	05800
6,0	16,0	5,8	30,0	34	70	6	2		06300	06300	06300	06300
6,5	21,0	6,2	40,0	44	80	8	2		06800	06800	06800	06800
7,0	21,0	6,7	40,0	44	80	8	2		07300	07300	07300	07300
7,5	21,0	7,2	40,0	44	80	8	2		07800	07800	07800	07800
8,0	21,0	7,7	40,0	44	80	8	2		08300	08300	08300	08300
8,5	26,0	8,2	50,0	54	94	10	2		08800	08800	08800	08800
9,0	26,0	8,7	50,0	54	94	10	2		09300	09300	09300	09300
9,5	26,0	9,2	50,0	54	94	10	2		09800	09800	09800	09800
10,0	26,0	9,7	50,0	54	94	10	2		10300	10300	10300	10300
10,5	31,0	10,1	60,0	64	109	12	2		10800	10800	10800	10800
11,0	31,0	10,6	60,0	64	109	12	2		11300	11300	11300	11300
11,5	31,0	11,1	60,0	64	109	12	2		11800	11800	11800	11800
12,0	31,0	11,6	60,0	64	109	12	2		12300	12300	12300	12300
12,5	36,0	12,1	70,0	74	119	14	2			12800	12800	12800
13,0	36,0	12,6	70,0	74	119	14	2			13300	13300	13300
13,5	36,0	13,1	70,0	74	119	14	2			13800	13800	13800
14,0	36,0	13,6	70,0	74	119	14	2			14300	14300	14300
14,5	41,0	14,0	80,0	84	132	16	2			14800	14800	14800
15,0	41,0	14,5	80,0	84	132	16	2			15300	15300	15300
15,5	41,0	15,0	80,0	84	132	16	2			15800	15800	15800
16,0	41,0	15,5	80,0	84	132	16	2			16300	16300	16300
16,5	47,0	16,0	90,0	94	142	18	2			16800	16800	16800
17,0	47,0	16,5	90,0	94	142	18	2			17300	17300	17300
17,5	47,0	17,0	90,0	94	142	18	2			17800	17800	17800
18,0	47,0	17,5	90,0	94	142	18	2			18300	18300	18300
18,5	52,0	18,0	100,0	104	154	20	2			18800	18800	18800
19,0	52,0	18,5	100,0	104	154	20	2			19300	19300	19300
19,5	52,0	19,0	100,0	104	154	20	2			19800	19800	19800
20,0	52,0	19,5	100,0	104	154	20	2			20300	20300	20300

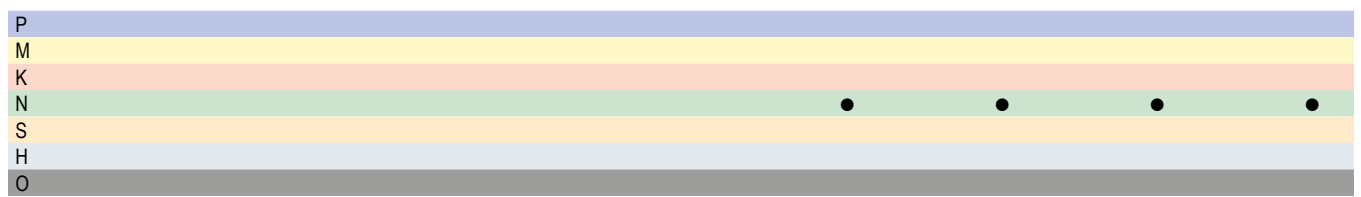

AluLine – End milling cutter

The specialist for machining non-ferrous metals

▲ With polished chip flutes

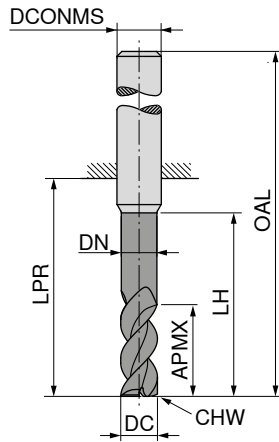
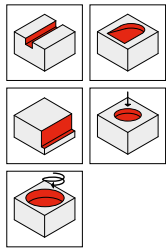
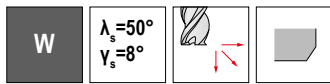

DRAGONSKIN



DRAGONSKIN

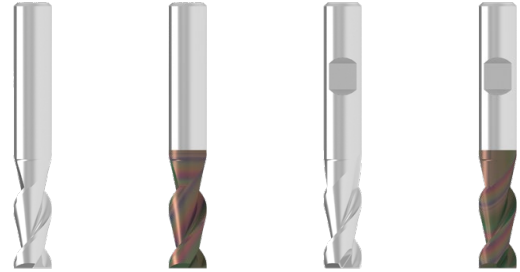

Factory standard



Factory standard



Factory standard



Factory standard



53 619 ...

53 621 ...

53 620 ...

53 622 ...

DC _{h6} mm	APMX mm	DN mm	LH mm	LPR mm	OAL mm	DCONMS _{h6} mm	CHW mm	ZEFP	53 619 ...	53 621 ...	53 620 ...	53 622 ...
5,0	10,5	4,8	15	22	58	6	0,1	2	05100	05100	05100	05100
5,5	13,0	5,3	18	22	58	6	0,1	2	05600	05600	05600	05600
6,0	13,0	5,8	18	22	58	6	0,1	2	06100	06100	06100	06100
6,5	17,0	6,2	24	28	64	8	0,1	2	06600	06600	06600	06600
7,0	17,0	6,7	24	28	64	8	0,1	2	07100	07100	07100	07100
7,5	17,0	7,2	24	28	64	8	0,1	2	07600	07600	07600	07600
8,0	17,0	7,7	24	28	64	8	0,1	2	08100	08100	08100	08100
8,5	21,0	8,2	30	34	74	10	0,1	2	08600	08600	08600	08600
9,0	21,0	8,7	30	34	74	10	0,1	2	09100	09100	09100	09100
9,5	21,0	9,2	30	34	74	10	0,1	2	09600	09600	09600	09600
10,0	21,0	9,7	30	34	74	10	0,1	2	10100	10100	10100	10100
10,5	25,0	10,1	36	40	85	12	0,1	2	10600	10600	10600	10600
11,0	25,0	10,6	36	40	85	12	0,1	2	11100	11100	11100	11100
11,5	25,0	11,1	36	40	85	12	0,1	2	11600	11600	11600	11600
12,0	25,0	11,6	36	40	85	12	0,1	2	12100	12100	12100	12100
12,5	29,0	12,1	42	46	91	14	0,1	2			12600	12600
13,0	29,0	12,6	42	46	91	14	0,1	2			13100	13100
13,5	29,0	13,1	42	46	91	14	0,1	2			13600	13600
14,0	29,0	13,6	42	46	91	14	0,1	2			14100	14100
14,5	33,0	14,0	48	52	100	16	0,1	2			14600	14600
15,0	33,0	14,5	48	52	100	16	0,1	2			15100	15100
15,5	33,0	15,0	48	52	100	16	0,1	2			15600	15600
16,0	33,0	15,5	48	52	100	16	0,1	2			16100	16100
16,5	38,0	16,0	54	58	106	18	0,1	2			16600	16600
17,0	38,0	16,5	54	58	106	18	0,1	2			17100	17100
17,5	38,0	17,0	54	58	106	18	0,1	2			17600	17600
18,0	38,0	17,5	54	58	106	18	0,1	2			18100	18100
18,5	42,0	18,0	60	64	114	20	0,1	2			18600	18600
19,0	42,0	18,5	60	64	114	20	0,1	2			19100	19100
19,5	42,0	19,0	60	64	114	20	0,1	2			19600	19600
20,0	42,0	19,5	60	64	114	20	0,1	2			20100	20100

P												
M												
K												
N												
S												
H												
O												

→ v_c/f_z Page 414+415

AluLine – End milling cutter

The specialist for machining non-ferrous metals

▲ With polished chip flutes

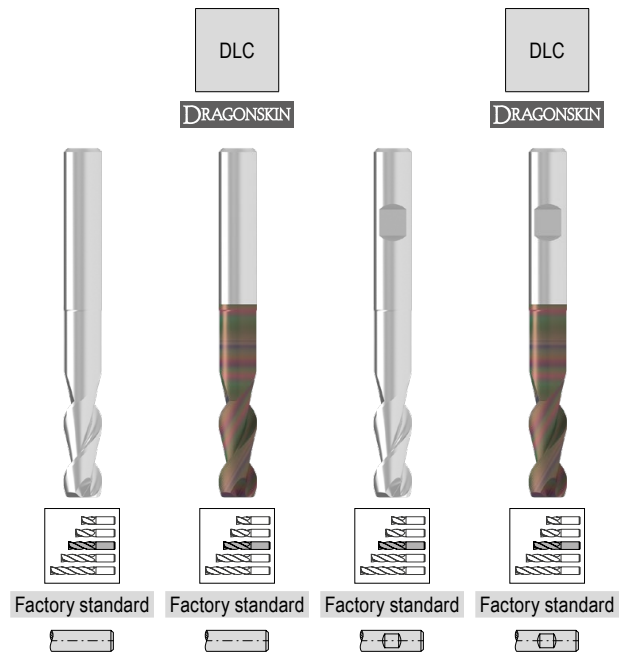
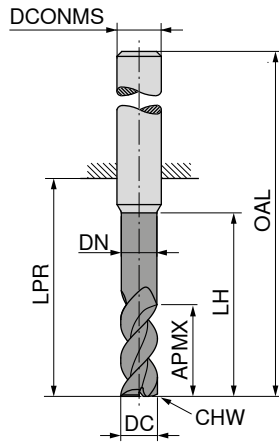
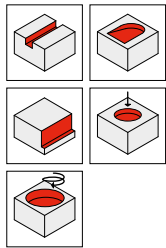

DC _{h6}	APMX	DN	LH	LPR	OAL	DCONMS _{h6}	CHW	ZEFP
mm	mm	mm	mm	mm	mm	mm	mm	
2,0	5,5	1,8	10,0	19	55	6	0,05	2
2,5	6,5	2,3	12,5	22	58	6	0,05	2
3,0	8,0	2,8	15,0	22	58	6	0,10	2
3,5	10,5	3,3	20,0	26	62	6	0,10	2
4,0	10,5	3,8	20,0	26	62	6	0,10	2
4,5	13,0	4,3	25,0	34	70	6	0,10	2
5,0	13,0	4,8	25,0	34	70	6	0,10	2
5,5	16,0	5,3	30,0	34	70	6	0,10	2
6,0	16,0	5,8	30,0	34	70	6	0,10	2
6,5	21,0	6,2	40,0	44	80	8	0,10	2
7,0	21,0	6,7	40,0	44	80	8	0,10	2
7,5	21,0	7,2	40,0	44	80	8	0,10	2
8,0	21,0	7,7	40,0	44	80	8	0,10	2
8,5	26,0	8,2	50,0	54	94	10	0,10	2
9,0	26,0	8,7	50,0	54	94	10	0,10	2
9,5	26,0	9,2	50,0	54	94	10	0,10	2
10,0	26,0	9,7	50,0	54	94	10	0,10	2
10,5	31,0	10,1	60,0	64	109	12	0,10	2
11,0	31,0	10,6	60,0	64	109	12	0,10	2
11,5	31,0	11,1	60,0	64	109	12	0,10	2
12,0	31,0	11,6	60,0	64	109	12	0,10	2
12,5	36,0	12,1	70,0	74	119	14	0,10	2
13,0	36,0	12,6	70,0	74	119	14	0,10	2
13,5	36,0	13,1	70,0	74	119	14	0,10	2
14,0	36,0	13,6	70,0	74	119	14	0,10	2
14,5	41,0	14,0	80,0	84	132	16	0,10	2
15,0	41,0	14,5	80,0	84	132	16	0,10	2
15,5	41,0	15,0	80,0	84	132	16	0,10	2
16,0	41,0	15,5	80,0	84	132	16	0,10	2
16,5	47,0	16,0	90,0	94	142	18	0,10	2
17,0	47,0	16,5	90,0	94	142	18	0,10	2
17,5	47,0	17,0	90,0	94	142	18	0,10	2
18,0	47,0	17,5	90,0	94	142	18	0,10	2
18,5	52,0	18,0	100,0	104	154	20	0,10	2
19,0	52,0	18,5	100,0	104	154	20	0,10	2
19,5	52,0	19,0	100,0	104	154	20	0,10	2
20,0	52,0	19,5	100,0	104	154	20	0,10	2

53 629 ...	53 631 ...	53 630 ...	53 632 ...
02300	02300	02300	02300
02800	02800	02800	02800
03300	03300	03300	03300
03800	03800	03800	03800
04300	04300	04300	04300
04800	04800	04800	04800
05300	05300	05300	05300
05800	05800	05800	05800
06300	06300	06300	06300
06800	06800	06800	06800
07300	07300	07300	07300
07800	07800	07800	07800
08300	08300	08300	08300
08800	08800	08800	08800
09300	09300	09300	09300
09800	09800	09800	09800
10300	10300	10300	10300
10800	10800	10800	10800
11300	11300	11300	11300
11800	11800	11800	11800
12300	12300	12300	12300
		12800	12800
		13300	13300
		13800	13800
		14300	14300
		14800	14800
		15300	15300
		15800	15800
		16300	16300
		16800	16800
		17300	17300
		17800	17800
		18300	18300
		18800	18800
		19300	19300
		19800	19800
		20300	20300

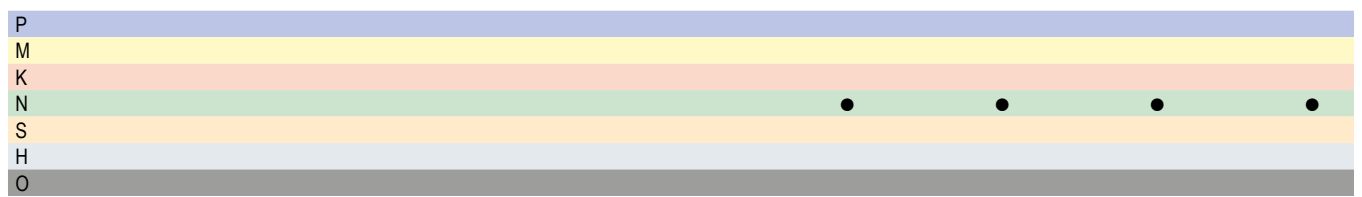

AluLine – End milling cutter

The specialist for machining non-ferrous metals

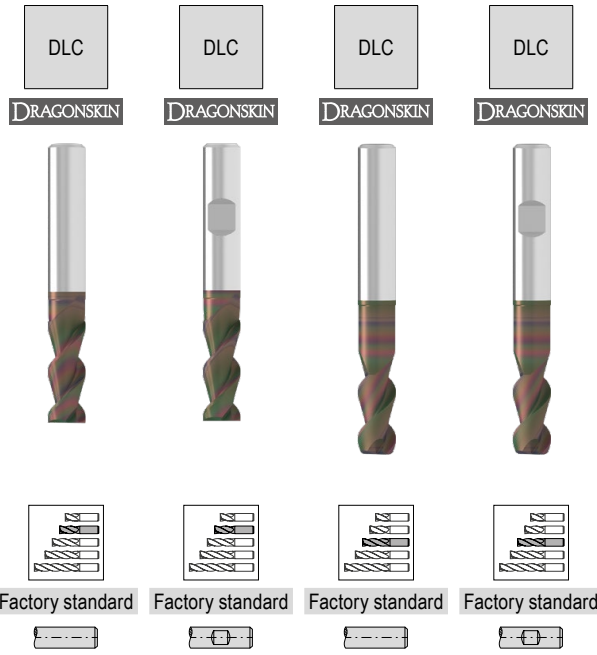
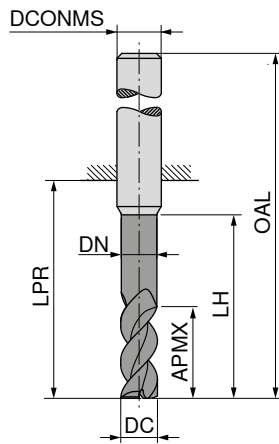
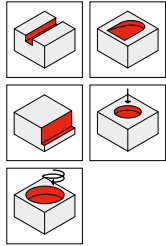
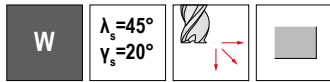

DC _{h6}	APMX	DN	LH	LPR	OAL	DCONMS _{h6}	ZEFP
mm	mm	mm	mm	mm	mm	mm	
2,0	5,5	1,8	10,0	19	55	6	2
2,5	6,5	2,3	12,5	22	58	6	2
3,0	8,0	2,8	15,0	22	58	6	2
3,5	10,5	3,3	20,0	26	62	6	2
4,0	10,5	3,8	20,0	26	62	6	2
4,5	13,0	4,3	25,0	34	70	6	2
5,0	10,5	4,8	15,0	22	58	6	2
5,0	13,0	4,8	25,0	34	70	6	2
5,5	13,0	5,3	18,0	22	58	6	2
5,5	16,0	5,3	30,0	34	70	6	2
6,0	13,0	5,8	18,0	22	58	6	2
6,0	16,0	5,8	30,0	34	70	6	2
6,5	17,0	6,2	24,0	28	64	8	2
6,5	21,0	6,2	40,0	44	80	8	2
7,0	17,0	6,7	24,0	28	64	8	2
7,0	21,0	6,7	40,0	44	80	8	2
7,5	17,0	7,2	24,0	28	64	8	2
7,5	21,0	7,2	40,0	44	80	8	2
8,0	17,0	7,7	24,0	28	64	8	2
8,0	21,0	7,7	40,0	44	80	8	2
8,5	21,0	8,2	30,0	34	74	10	2
8,5	26,0	8,2	50,0	54	94	10	2
9,0	21,0	8,7	30,0	34	74	10	2
9,0	26,0	8,7	50,0	54	94	10	2
9,5	21,0	9,2	30,0	34	74	10	2
9,5	26,0	9,2	50,0	54	94	10	2
10,0	21,0	9,7	30,0	34	74	10	2
10,0	26,0	9,7	50,0	54	94	10	2
10,5	25,0	10,1	36,0	40	85	12	2
10,5	31,0	10,1	60,0	64	109	12	2
11,0	25,0	10,6	36,0	40	85	12	2
11,0	31,0	10,6	60,0	64	109	12	2
11,5	25,0	11,1	36,0	40	85	12	2
11,5	31,0	11,1	60,0	64	109	12	2
12,0	25,0	11,6	36,0	40	85	12	2
12,0	31,0	11,6	60,0	64	109	12	2
12,5	29,0	12,1	42,0	46	91	14	2
12,5	36,0	12,1	70,0	74	119	14	2

53 627 ...	53 628 ...	53 637 ...	53 638 ...
		02300	02300
		02800	02800
		03300	03300
		03800	03800
		04300	04300
		04800	04800
05100	05100	05300	05300
05600	05600	05800	05800
06100	06100	06300	06300
06600	06600	06800	06800
07100	07100	07300	07300
07600	07600	07800	07800
08100	08100	08300	08300
08600	08600	08800	08800
09100	09100	09300	09300
09600	09600	09800	09800
10100	10100	10300	10300
10600	10600	10800	10800
11100	11100	11300	11300
11600	11600	11800	11800
12100	12100	12300	12300
	12600		12800

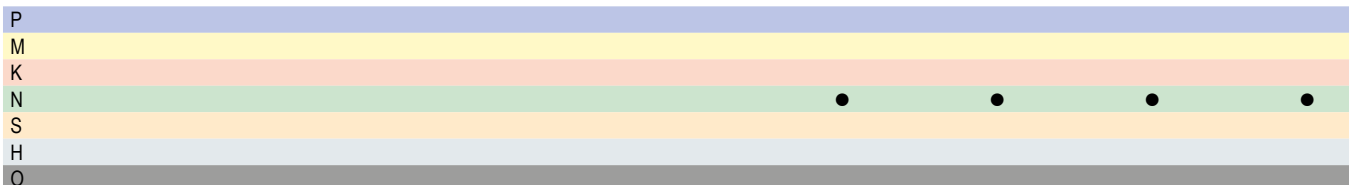

→ v_c/f_z Page 414+415

AluLine – End milling cutter

The specialist for machining non-ferrous metals

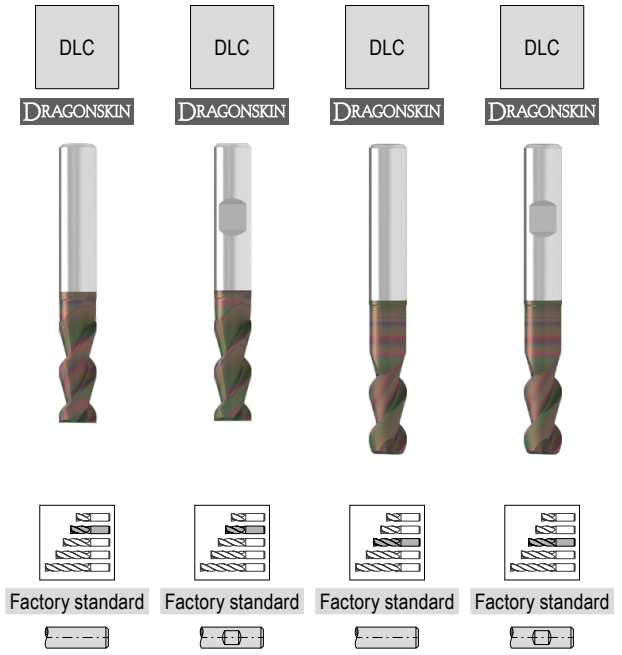
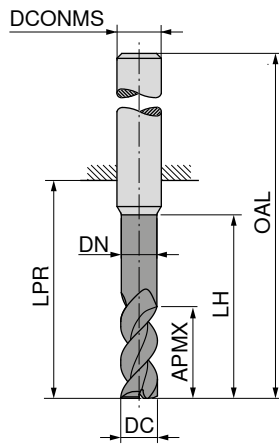
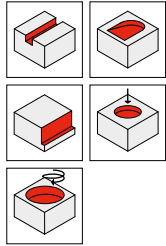

DC _{h6} mm	APMX mm	DN mm	LH mm	LPR mm	OAL mm	DCONMS _{h6} mm	ZEFP
13,0	29,0	12,6	42,0	46	91	14	2
13,0	36,0	12,6	70,0	74	119	14	2
13,5	29,0	13,1	42,0	46	91	14	2
13,5	36,0	13,1	70,0	74	119	14	2
14,0	29,0	13,6	42,0	46	91	14	2
14,0	36,0	13,6	70,0	74	119	14	2
14,5	33,0	14,0	48,0	52	100	16	2
14,5	41,0	14,0	80,0	84	132	16	2
15,0	33,0	14,5	48,0	52	100	16	2
15,0	41,0	14,5	80,0	84	132	16	2
15,5	33,0	15,0	48,0	52	100	16	2
15,5	41,0	15,0	80,0	84	132	16	2
16,0	33,0	15,5	48,0	52	100	16	2
16,0	41,0	15,5	80,0	84	132	16	2
16,5	38,0	16,0	54,0	58	106	18	2
16,5	47,0	16,0	90,0	94	142	18	2
17,0	38,0	16,5	54,0	58	106	18	2
17,0	47,0	16,5	90,0	94	142	18	2
17,5	38,0	17,0	54,0	58	106	18	2
17,5	47,0	17,0	90,0	94	142	18	2
18,0	38,0	17,5	54,0	58	106	18	2
18,0	47,0	17,5	90,0	94	142	18	2
18,5	42,0	18,0	60,0	64	114	20	2
18,5	52,0	18,0	100,0	104	154	20	2
19,0	42,0	18,5	60,0	64	114	20	2
19,0	52,0	18,5	100,0	104	154	20	2
19,5	42,0	19,0	60,0	64	114	20	2
19,5	52,0	19,0	100,0	104	154	20	2
20,0	42,0	19,5	60,0	64	114	20	2
20,0	52,0	19,5	100,0	104	154	20	2

53 627 ...	53 628 ...	53 637 ...	53 638 ...
	13100		
	13600		13300
	14100		13800
	14600		14300
	15100		14800
	15600		15300
	16100		15800
	16600		16300
	17100		16800
	17600		17300
	18100		17800
	18600		18300
	19100		18800
	19600		19300
	20100		19800
			20300

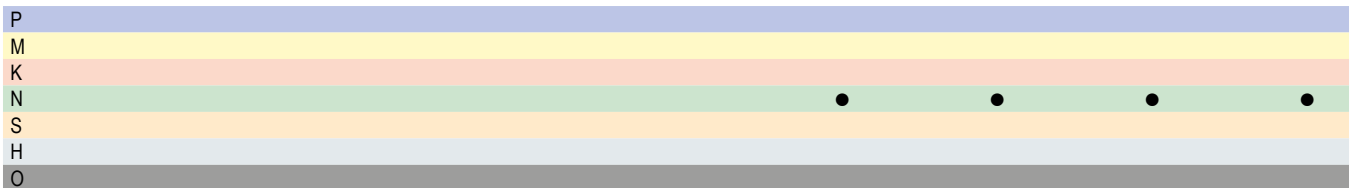

→ v_c/f_z Page 414+415

AluLine – End milling cutter

The specialist for machining non-ferrous metals

▲ With polished chip flutes

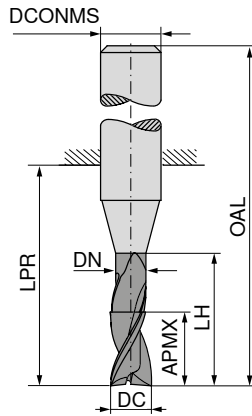
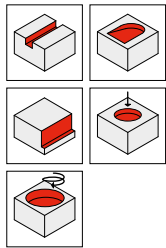
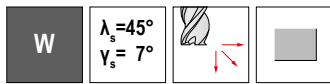

DRAGONSKIN

DRAGONSKIN

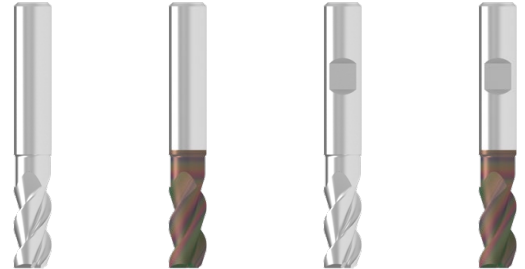

Factory standard

Factory standard

Factory standard

Factory standard



53 615 ...

53 617 ...

53 616 ...

53 618 ...

DC _{h6} mm	APMX mm	DN mm	LH mm	LPR mm	OAL mm	DCONMS _{h6} mm	ZEFP					
2,0	4,5	1,8	6,0	14	50	6	3		02100	02100	02100	02100
2,5	5,5	2,3	7,5	19	55	6	3		02600	02600	02600	02600
3,0	6,5	2,8	9,0	19	55	6	3		03100	03100	03100	03100
3,5	8,5	3,3	12,0	19	55	6	3		03600	03600	03600	03600
4,0	8,5	3,8	12,0	19	55	6	3		04100	04100	04100	04100
4,5	10,5	4,3	15,0	22	58	6	3		04600	04600	04600	04600
5,0	10,5	4,8	15,0	22	58	6	3		05100	05100	05100	05100
5,5	13,0	5,3	18,0	22	58	6	3		05600	05600	05600	05600
6,0	13,0	5,8	18,0	22	58	6	3		06100	06100	06100	06100
6,5	17,0	6,2	24,0	28	64	8	3		06600	06600	06600	06600
7,0	17,0	6,7	24,0	28	64	8	3		07100	07100	07100	07100
7,5	17,0	7,2	24,0	28	64	8	3		07600	07600	07600	07600
8,0	17,0	7,7	24,0	28	64	8	3		08100	08100	08100	08100
8,5	21,0	8,2	30,0	34	74	10	3		08600	08600	08600	08600
9,0	21,0	8,7	30,0	34	74	10	3		09100	09100	09100	09100
9,5	21,0	9,2	30,0	34	74	10	3		09600	09600	09600	09600
10,0	21,0	9,7	30,0	34	74	10	3		10100	10100	10100	10100
10,5	25,0	10,1	36,0	40	85	12	3		10600	10600	10600	10600
11,0	25,0	10,6	36,0	40	85	12	3		11100	11100	11100	11100
11,5	25,0	11,1	36,0	40	85	12	3		11600	11600	11600	11600
12,0	25,0	11,6	36,0	40	85	12	3		12100	12100	12100	12100
12,5	29,0	12,1	42,0	46	91	14	3			12600	12600	12600
13,0	29,0	12,6	42,0	46	91	14	3			13100	13100	13100
13,5	29,0	13,1	42,0	46	91	14	3			13600	13600	13600
14,0	29,0	13,6	42,0	46	91	14	3			14100	14100	14100
14,5	33,0	14,0	48,0	52	100	16	3			14600	14600	14600
15,0	33,0	14,5	48,0	52	100	16	3			15100	15100	15100
15,5	33,0	15,0	48,0	52	100	16	3			15600	15600	15600
16,0	33,0	15,5	48,0	52	100	16	3			16100	16100	16100
16,5	38,0	16,0	54,0	58	106	18	3			16600	16600	16600
17,0	38,0	16,5	54,0	58	106	18	3			17100	17100	17100
17,5	38,0	17,0	54,0	58	106	18	3			17600	17600	17600
18,0	38,0	17,5	54,0	58	106	18	3			18100	18100	18100
18,5	42,0	18,0	60,0	64	114	20	3			18600	18600	18600
19,0	42,0	18,5	60,0	64	114	20	3			19100	19100	19100
19,5	42,0	19,0	60,0	64	114	20	3			19600	19600	19600
20,0	42,0	19,5	60,0	64	114	20	3			20100	20100	20100

P												
M												
K												
N												
S												
H												
O												

→ v_f/f_z Page 414+415

AluLine – End milling cutter

The specialist for machining non-ferrous metals

▲ With polished chip flutes

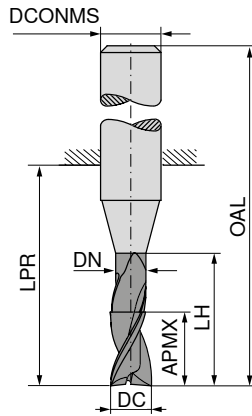
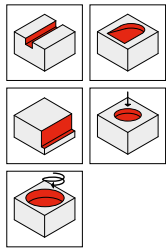
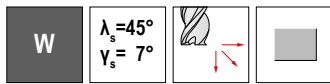

DRAGONSKIN



DRAGONSKIN

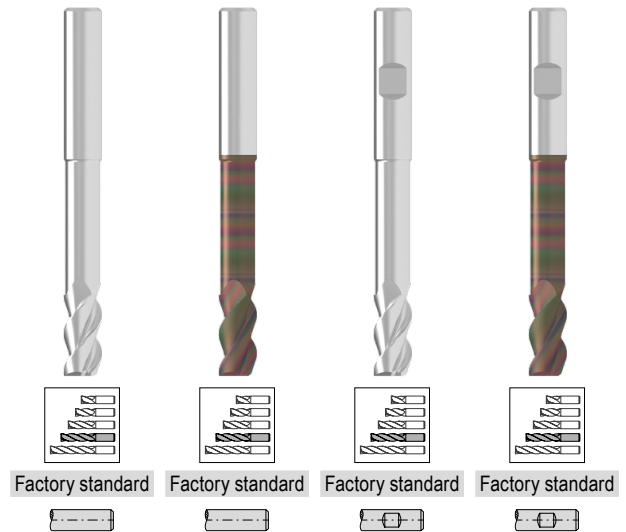

Factory standard Factory standard Factory standard Factory standard

53 615 ... 53 617 ... 53 616 ... 53 618 ...

DC _{h6} mm	APMX mm	DN mm	LH mm	LPR mm	OAL mm	DCONMS _{h6} mm	ZEPF
2,0	5,5	1,8	10,0	19	55	6	3
2,5	6,5	2,3	12,5	22	58	6	3
3,0	8,0	2,8	15,0	22	58	6	3
3,5	10,5	3,3	20,0	26	62	6	3
4,0	10,5	3,8	20,0	26	62	6	3
4,5	13,0	4,3	25,0	34	70	6	3
5,0	13,0	4,8	25,0	34	70	6	3
5,5	16,0	5,3	30,0	34	70	6	3
6,0	16,0	5,8	30,0	34	70	6	3
6,5	21,0	6,2	40,0	44	80	8	3
7,0	21,0	6,7	40,0	44	80	8	3
7,5	21,0	7,2	40,0	44	80	8	3
8,0	21,0	7,7	40,0	44	80	8	3
8,5	26,0	8,2	50,0	54	94	10	3
9,0	26,0	8,7	50,0	54	94	10	3
9,5	26,0	9,2	50,0	54	94	10	3
10,0	26,0	9,7	50,0	54	94	10	3
10,5	31,0	10,1	60,0	64	109	12	3
11,0	31,0	10,6	60,0	64	109	12	3
11,5	31,0	11,1	60,0	64	109	12	3
12,0	31,0	11,6	60,0	64	109	12	3
12,5	36,0	12,1	70,0	74	119	14	3
13,0	36,0	12,6	70,0	74	119	14	3
13,5	36,0	13,1	70,0	74	119	14	3
14,0	36,0	13,6	70,0	74	119	14	3
14,5	41,0	14,0	80,0	84	132	16	3
15,0	41,0	14,5	80,0	84	132	16	3
15,5	41,0	15,0	80,0	84	132	16	3
16,0	41,0	15,5	80,0	84	132	16	3
16,5	47,0	16,0	90,0	94	142	18	3
17,0	47,0	16,5	90,0	94	142	18	3
17,5	47,0	17,0	90,0	94	142	18	3
18,0	47,0	17,5	90,0	94	142	18	3
18,5	52,0	18,0	100,0	104	154	20	3
19,0	52,0	18,5	100,0	104	154	20	3
19,5	52,0	19,0	100,0	104	154	20	3
20,0	52,0	19,5	100,0	104	154	20	3

02200	02200	02200	02200
02700	02700	02700	02700
03200	03200	03200	03200
03700	03700	03700	03700
04200	04200	04200	04200
04700	04700	04700	04700
05200	05200	05200	05200
05700	05700	05700	05700
06200	06200	06200	06200
06700	06700	06700	06700
07200	07200	07200	07200
07700	07700	07700	07700
08200	08200	08200	08200
08700	08700	08700	08700
09200	09200	09200	09200
09700	09700	09700	09700
10200	10200	10200	10200
10700	10700	10700	10700
11200	11200	11200	11200
11700	11700	11700	11700
12200	12200	12200	12200
		12700	12700
		13200	13200
		13700	13700
		14200	14200
		14700	14700
		15200	15200
		15700	15700
		16200	16200
		16700	16700
		17200	17200
		17700	17700
		18200	18200
		18700	18700
		19200	19200
		19700	19700
		20200	20200

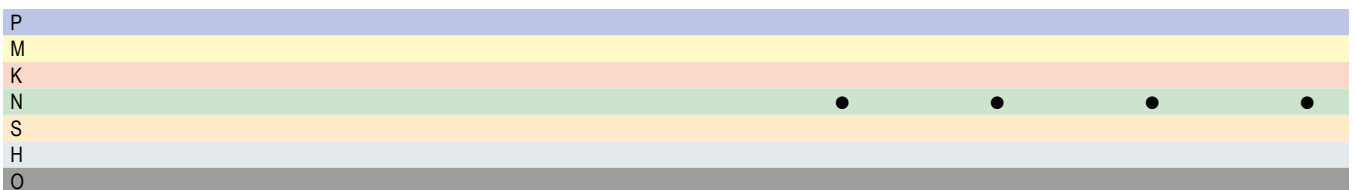

→ v_c/f_z Page 414+415

AluLine – End milling cutter

The specialist for machining non-ferrous metals

▲ With polished chip flutes

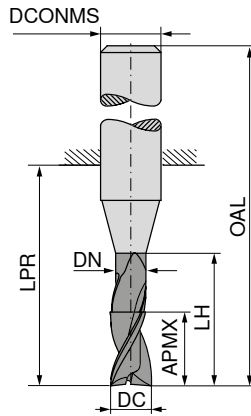
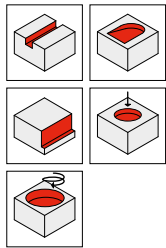
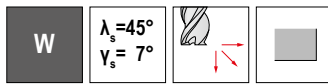

DRAGONSKIN



DRAGONSKIN

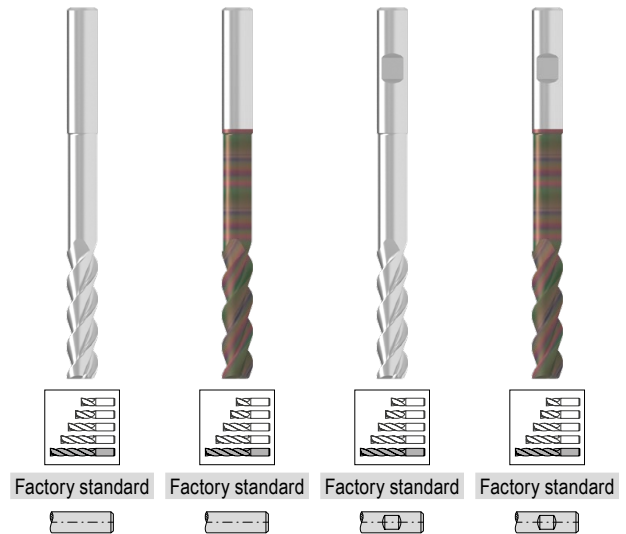

53 615 ... 53 617 ... 53 616 ... 53 618 ...

DC _{h6} mm	APMX mm	DN mm	LH mm	LPR mm	OAL mm	DCONMS _{h6} mm	ZFP
2,0	8,5	1,8	16	26	62	6	3
2,5	10,5	2,3	20	31	67	6	3
3,0	12,5	2,8	24	31	67	6	3
3,5	16,5	3,3	32	38	74	6	3
4,0	16,5	3,8	32	38	74	6	3
4,5	20,5	4,3	40	52	88	6	3
5,0	20,5	4,8	40	52	88	6	3
5,5	25,0	5,3	48	52	88	6	3
6,0	25,0	5,8	48	52	88	6	3
6,5	33,0	6,2	64	68	104	8	3
7,0	33,0	6,7	64	68	104	8	3
7,5	33,0	7,2	64	68	104	8	3
8,0	33,0	7,7	64	68	104	8	3
8,5	41,0	8,2	80	84	124	10	3
9,0	41,0	8,7	80	84	124	10	3
9,5	41,0	9,2	80	84	124	10	3
10,0	41,0	9,7	80	84	124	10	3
10,5	49,0	10,1	96	100	145	12	3
11,0	49,0	10,6	96	100	145	12	3
11,5	49,0	11,1	96	100	145	12	3
12,0	49,0	11,6	96	100	145	12	3
12,5	57,0	12,1	112	116	161	14	3
13,0	57,0	12,6	112	116	161	14	3
13,5	57,0	13,1	112	116	161	14	3
14,0	57,0	13,6	112	116	161	14	3
14,5	65,0	14,0	128	132	180	16	3
15,0	65,0	14,5	128	132	180	16	3
15,5	65,0	15,0	128	132	180	16	3
16,0	65,0	15,5	128	132	180	16	3
16,5	74,0	16,0	144	148	196	18	3
17,0	74,0	16,5	144	148	196	18	3
17,5	74,0	17,0	144	148	196	18	3
18,0	74,0	17,5	144	148	196	18	3
18,5	82,0	18,0	160	164	214	20	3
19,0	82,0	18,5	160	164	214	20	3
19,5	82,0	19,0	160	164	214	20	3
20,0	82,0	19,5	160	164	214	20	3

53 615 ...	53 617 ...	53 616 ...	53 618 ...
02400	02400	02400	02400
02900	02900	02900	02900
03400	03400	03400	03400
03900	03900	03900	03900
04400	04400	04400	04400
04900	04900	04900	04900
05400	05400	05400	05400
05900	05900	05900	05900
06400	06400	06400	06400
06900	06900	06900	06900
07400	07400	07400	07400
07900	07900	07900	07900
08400	08400	08400	08400
08900	08900	08900	08900
09400	09400	09400	09400
09900	09900	09900	09900
10400	10400	10400	10400
10900	10900	10900	10900
11400	11400	11400	11400
11900	11900	11900	11900
12400	12400	12400	12400
		12900	12900
		13400	13400
		13900	13900
		14400	14400
		14900	14900
		15400	15400
		15900	15900
		16400	16400
		16900	16900
		17400	17400
		17900	17900
		18400	18400
		18900	18900
		19400	19400
		19900	19900
		20400	20400

P				
M				
K				
N		•	•	•
S				
H				
O				

→ v_c/f_z Page 414+415

AluLine – End milling cutter

The specialist for machining non-ferrous metals

▲ With polished chip flutes

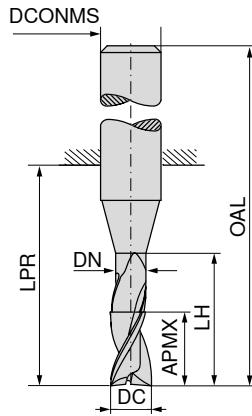
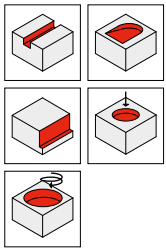
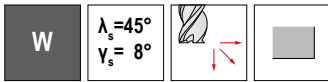

Factory standard Factory standard Factory standard Factory standard



53 517 ...	53 518 ...	53 519 ...	53 520 ...
			030
			040
		050	
		060	060
	080		
	100	080	
	120	100	
		120	
140			
160		160	
180			
200		200	

DC _{h6} mm	APMX mm	DN mm	LH mm	LPR mm	OAL mm	DCONMS _{h5} mm	ZEFP
3	8	2,7	13	21	57	6	3
4	11	3,7	17	21	57	6	3
5	13	4,7	19	21	57	6	3
6	13	5,7	19	21	57	6	3
6	18	5,7	24	26	62	6	3
8	21	7,4	25	27	63	8	3
8	24	7,4	30	32	68	8	3
10	22	9,2	30	32	72	10	3
10	30	9,2	38	40	80	10	3
12	26	11,0	36	38	83	12	3
12	36	11,0	46	48	93	12	3
14	26	13,0	36	38	83	14	3
16	36	15,0	42	44	92	16	3
16	48	15,0	58	60	108	16	3
18	36	17,0	42	44	92	18	3
20	41	19,0	52	54	104	20	3
20	60	19,0	74	76	126	20	3

P							
M							
K							
N						•	•
S							
H							
O							

→ v_c/f_z Page 414+415

AluLine – End milling cutter

The specialist for machining non-ferrous metals

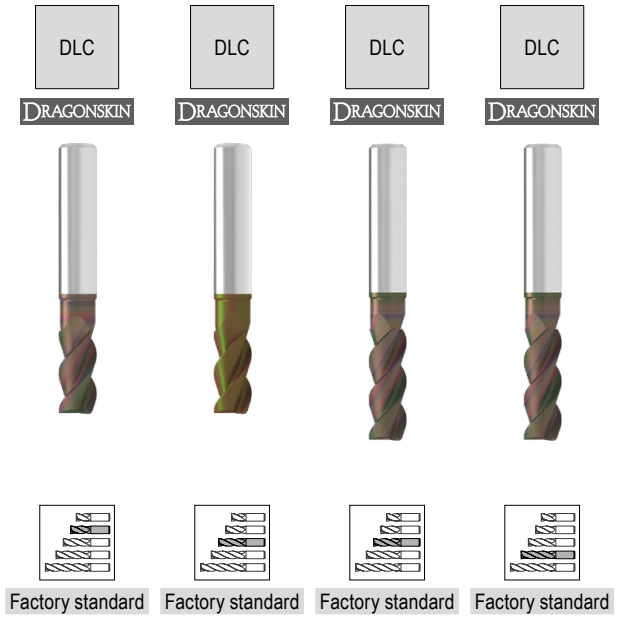
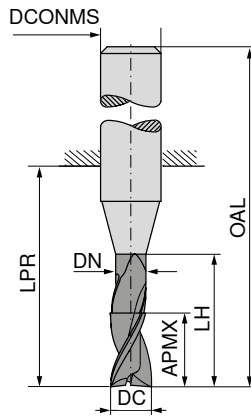
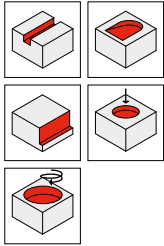
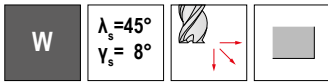

53 521 ...	53 522 ...	53 523 ...	53 524 ...
			030
			040
		050	
		060	
	080		060
	100	080	
	120	100	
		120	
140			
160			
180			
200			

DC _{h5} mm	APMX mm	DN mm	LH mm	LPR mm	OAL mm	DCONMS _{h5} mm	ZEFP
3	8	2,7	13	21	57	6	3
4	11	3,7	17	21	57	6	3
5	13	4,7	19	21	57	6	3
6	13	5,7	19	21	57	6	3
6	18	5,7	24	26	62	6	3
8	21	7,4	25	27	63	8	3
8	24	7,4	30	32	68	8	3
10	22	9,2	30	32	72	10	3
10	30	9,2	38	40	80	10	3
12	26	11,0	36	38	83	12	3
12	36	11,0	46	48	93	12	3
14	26	13,0	36	38	83	14	3
16	36	15,0	42	44	92	16	3
18	36	17,0	42	44	92	18	3
20	41	19,0	52	54	104	20	3

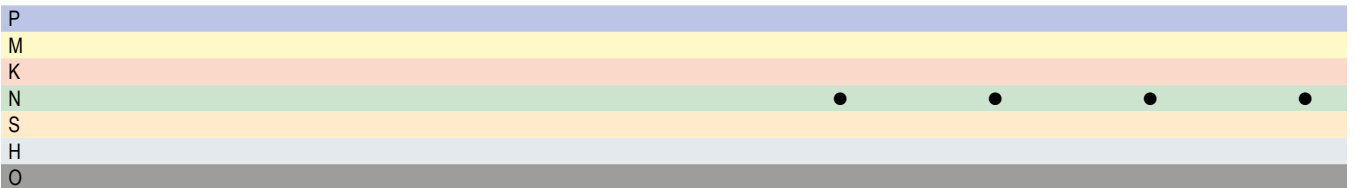

→ v_d/f_z Page 414+415

AluLine – End milling cutter

The specialist for machining non-ferrous metals

▲ With polished chip flutes

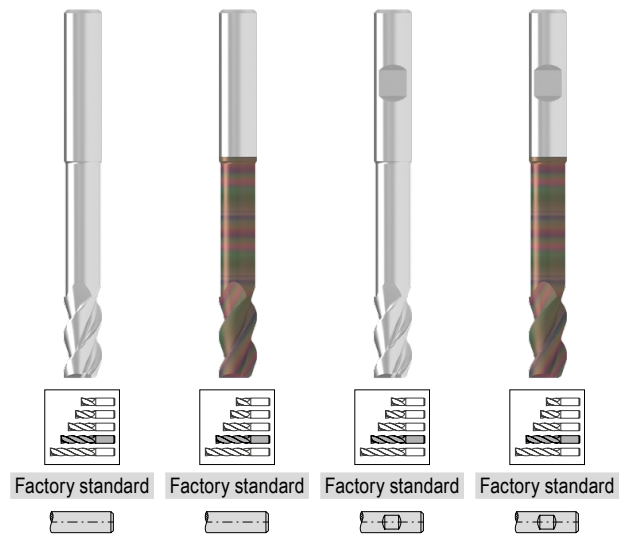
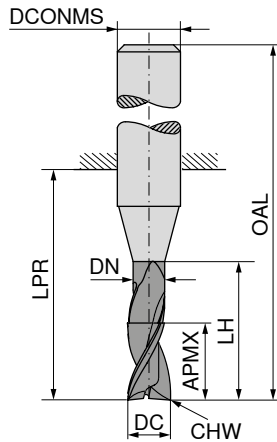
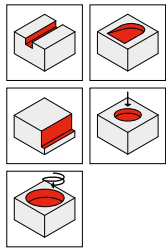
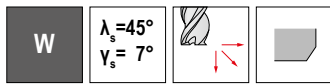

Factory standard Factory standard Factory standard Factory standard

DC _{h6}	APMX	DN	LH	LPR	OAL	DCONMS _{h6}	CHW	ZEFP
mm	mm	mm	mm	mm	mm	mm	mm	
2,0	5,5	1,8	10,0	19	55	6	0,05	3
2,5	6,5	2,3	12,5	22	58	6	0,05	3
3,0	8,0	2,8	15,0	22	58	6	0,10	3
3,5	10,5	3,3	20,0	26	62	6	0,10	3
4,0	10,5	3,8	20,0	26	62	6	0,10	3
4,5	13,0	4,3	25,0	34	70	6	0,10	3
5,0	13,0	4,8	25,0	34	70	6	0,10	3
5,5	16,0	5,3	30,0	34	70	6	0,10	3
6,0	16,0	5,8	30,0	34	70	6	0,20	3
6,5	21,0	6,2	40,0	44	80	8	0,20	3
7,0	21,0	6,7	40,0	44	80	8	0,20	3
7,5	21,0	7,2	40,0	44	80	8	0,20	3
8,0	21,0	7,7	40,0	44	80	8	0,20	3
8,5	26,0	8,2	50,0	54	94	10	0,20	3
9,0	26,0	8,7	50,0	54	94	10	0,20	3
9,5	26,0	9,2	50,0	54	94	10	0,20	3
10,0	26,0	9,7	50,0	54	94	10	0,20	3
10,5	31,0	10,1	60,0	64	109	12	0,20	3
11,0	31,0	10,6	60,0	64	109	12	0,20	3
11,5	31,0	11,1	60,0	64	109	12	0,20	3
12,0	31,0	11,6	60,0	64	109	12	0,20	3
12,5	36,0	12,1	70,0	74	119	14	0,20	3
13,0	36,0	12,6	70,0	74	119	14	0,20	3
13,5	36,0	13,1	70,0	74	119	14	0,20	3
14,0	36,0	13,6	70,0	74	119	14	0,20	3
14,5	41,0	14,0	80,0	84	132	16	0,20	3
15,0	41,0	14,5	80,0	84	132	16	0,20	3
15,5	41,0	15,0	80,0	84	132	16	0,20	3
16,0	41,0	15,5	80,0	84	132	16	0,20	3
16,5	47,0	16,0	90,0	94	142	18	0,20	3
17,0	47,0	16,5	90,0	94	142	18	0,20	3
17,5	47,0	17,0	90,0	94	142	18	0,20	3
18,0	47,0	17,5	90,0	94	142	18	0,20	3
18,5	52,0	18,0	100,0	104	154	20	0,20	3
19,0	52,0	18,5	100,0	104	154	20	0,20	3
19,5	52,0	19,0	100,0	104	154	20	0,20	3
20,0	52,0	19,5	100,0	104	154	20	0,20	3

53 611 ...	53 613 ...	53 612 ...	53 614 ...
02200	02200	02200	02200
02700	02700	02700	02700
03200	03200	03200	03200
03700	03700	03700	03700
04200	04200	04200	04200
04700	04700	04700	04700
05200	05200	05200	05200
05700	05700	05700	05700
06200	06200	06200	06200
06700	06700	06700	06700
07200	07200	07200	07200
07700	07700	07700	07700
08200	08200	08200	08200
08700	08700	08700	08700
09200	09200	09200	09200
09700	09700	09700	09700
10200	10200	10200	10200
10700	10700	10700	10700
11200	11200	11200	11200
11700	11700	11700	11700
12200	12200	12200	12200
		12700	12700
		13200	13200
		13700	13700
		14200	14200
		14700	14700
		15200	15200
		15700	15700
		16200	16200
		16700	16700
		17200	17200
		17700	17700
		18200	18200
		18700	18700
		19200	19200
		19700	19700
		20200	20200

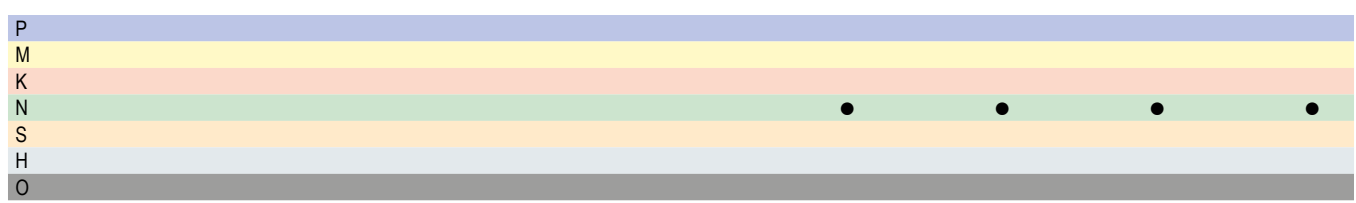

→ v_c/f_z Page 414+415

AluLine – End milling cutter

The specialist for machining non-ferrous metals

▲ With polished chip flutes

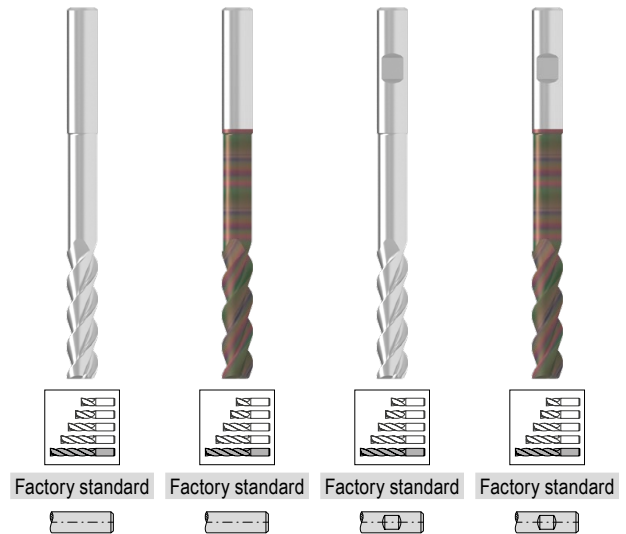
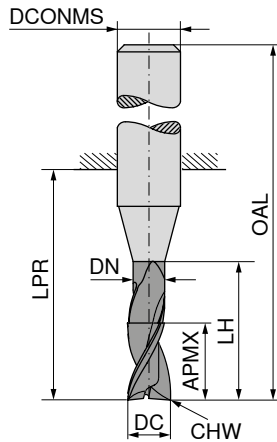
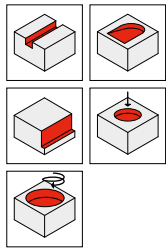
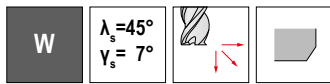

53 611 ... 53 613 ... 53 612 ... 53 614 ...

DC _{h6}	APMX	DN	LH	LPR	OAL	DCONMS _{h6}	CHW	ZEPF	53 611 ...	53 613 ...	53 612 ...	53 614 ...
mm	mm	mm	mm	mm	mm	mm	mm					
2,0	8,5	1,8	16	26	62	6	0,05	3	02400	02400	02400	02400
2,5	10,5	2,3	20	31	67	6	0,05	3	02900	02900	02900	02900
3,0	12,5	2,8	24	31	67	6	0,10	3	03400	03400	03400	03400
3,5	16,5	3,3	32	38	74	6	0,10	3	03900	03900	03900	03900
4,0	16,5	3,8	32	38	74	6	0,10	3	04400	04400	04400	04400
4,5	20,5	4,3	40	52	88	6	0,10	3	04900	04900	04900	04900
5,0	20,5	4,8	40	52	88	6	0,10	3	05400	05400	05400	05400
5,5	25,0	5,3	48	52	88	6	0,10	3	05900	05900	05900	05900
6,0	25,0	5,8	48	52	88	6	0,20	3	06400	06400	06400	06400
6,5	33,0	6,2	64	68	104	8	0,20	3	06900	06900	06900	06900
7,0	33,0	6,7	64	68	104	8	0,20	3	07400	07400	07400	07400
7,5	33,0	7,2	64	68	104	8	0,20	3	07900	07900	07900	07900
8,0	33,0	7,7	64	68	104	8	0,20	3	08400	08400	08400	08400
8,5	41,0	8,2	80	84	124	10	0,20	3	08900	08900	08900	08900
9,0	41,0	8,7	80	84	124	10	0,20	3	09400	09400	09400	09400
9,5	41,0	9,2	80	84	124	10	0,20	3	09900	09900	09900	09900
10,0	41,0	9,7	80	84	124	10	0,20	3	10400	10400	10400	10400
10,5	49,0	10,1	96	100	145	12	0,20	3	10900	10900	10900	10900
11,0	49,0	10,6	96	100	145	12	0,20	3	11400	11400	11400	11400
11,5	49,0	11,1	96	100	145	12	0,20	3	11900	11900	11900	11900
12,0	49,0	11,6	96	100	145	12	0,20	3	12400	12400	12400	12400
12,5	57,0	12,1	112	116	161	14	0,20	3			12900	12900
13,0	57,0	12,6	112	116	161	14	0,20	3			13400	13400
13,5	57,0	13,1	112	116	161	14	0,20	3			13900	13900
14,0	57,0	13,6	112	116	161	14	0,20	3			14400	14400
14,5	65,0	14,0	128	132	180	16	0,20	3			14900	14900
15,0	65,0	14,5	128	132	180	16	0,20	3			15400	15400
15,5	65,0	15,0	128	132	180	16	0,20	3			15900	15900
16,0	65,0	15,5	128	132	180	16	0,20	3			16400	16400
16,5	74,0	16,0	144	148	196	18	0,20	3			16900	16900
17,0	74,0	16,5	144	148	196	18	0,20	3			17400	17400
17,5	74,0	17,0	144	148	196	18	0,20	3			17900	17900
18,0	74,0	17,5	144	148	196	18	0,20	3			18400	18400
18,5	82,0	18,0	160	164	214	20	0,20	3			18900	18900
19,0	82,0	18,5	160	164	214	20	0,20	3			19400	19400
19,5	82,0	19,0	160	164	214	20	0,20	3			19900	19900
20,0	82,0	19,5	160	164	214	20	0,20	3			20400	20400

P												
M												
K												
N												
S												
H												
O												

AluLine – End milling cutter

The specialist for machining non-ferrous metals

▲ With graduated flute depth

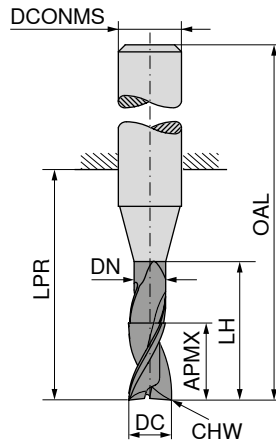
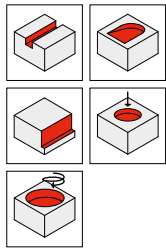
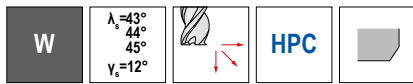

DRAGONSKIN

DRAGONSKIN

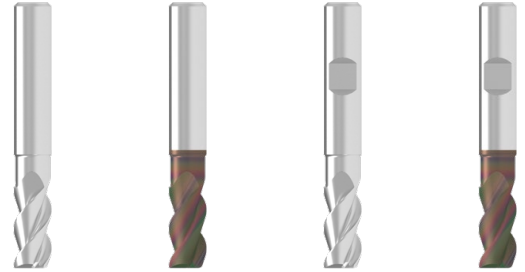

Factory standard

Factory standard

Factory standard

Factory standard



53 584 ...

53 598 ...

53 597 ...

53 599 ...

DC ₁₈ mm	APMX mm	DN mm	LH mm	LPR mm	OAL mm	DCONMS ₁₆ mm	CHW mm	ZEFP					
3,0	8	2,7	12	21	57	6	0,1	3		03000	03000	03000	03000
3,5	8	3,2	12	21	57	6	0,1	3		03600	03600	03600	03600
4,0	11	3,7	18	21	57	6	0,1	3		04000	04000	04000	04000
4,5	11	4,2	18	21	57	6	0,1	3		04600	04600	04600	04600
5,0	13	4,7	18	21	57	6	0,1	3		05000	05000	05000	05000
5,5	13	5,2	18	21	57	6	0,1	3		05600	05600	05600	05600
6,0	13	5,7	18	21	57	6	0,2	3		06000	06000	06000	06000
6,5	21	6,1	25	27	63	8	0,2	3		06600	06600	06600	06600
7,0	21	6,6	25	27	63	8	0,2	3		07000	07000	07000	07000
7,5	21	7,1	25	27	63	8	0,2	3		07600	07600	07600	07600
8,0	21	7,4	25	27	63	8	0,2	3		08000	08000	08000	08000
8,5	22	7,9	30	33	73	10	0,2	3		08600	08600	08600	08600
9,0	22	8,4	30	33	73	10	0,2	3		09000	09000	09000	09000
9,5	22	8,9	30	33	73	10	0,2	3		09600	09600	09600	09600
10,0	22	9,2	30	33	73	10	0,2	3		10000	10000	10000	10000
10,5	26	9,7	36	38	83	12	0,2	3		10600	10600	10600	10600
11,0	26	10,0	36	38	83	12	0,2	3		11000	11000	11000	11000
11,5	26	10,5	36	38	83	12	0,2	3		11600	11600	11600	11600
12,0	26	11,0	36	38	83	12	0,2	3		12000	12000	12000	12000
12,5	26	11,5	36	38	83	14	0,2	3				12600	12600
13,0	26	12,0	36	38	83	14	0,2	3				13000	13000
13,5	26	12,5	36	38	83	14	0,2	3				13600	13600
14,0	26	13,0	36	38	83	14	0,2	3				14000	14000
14,5	36	13,5	42	44	92	16	0,2	3				14600	14600
15,0	36	14,0	42	44	92	16	0,2	3				15000	15000
15,5	36	14,5	42	44	92	16	0,2	3				15600	15600
16,0	36	15,0	42	44	92	16	0,2	3				16000	16000
16,5	36	15,5	42	44	92	18	0,2	3				16600	16600
17,0	36	16,0	42	44	92	18	0,2	3				17000	17000
17,5	36	16,5	42	44	92	18	0,2	3				17600	17600
18,0	36	17,0	42	44	92	18	0,2	3				18000	18000
18,5	41	17,5	52	54	104	20	0,2	3				18600	18600
19,0	41	18,0	52	54	104	20	0,2	3				19000	19000
19,5	41	18,5	52	54	104	20	0,2	3				19600	19600
20,0	41	19,0	52	54	104	20	0,2	3				20000	20000

P	
M	
K	
N	•
S	
H	
O	

AluLine – End milling cutter with corner radius

The specialist for machining non-ferrous metals

▲ With polished chip flutes

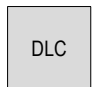
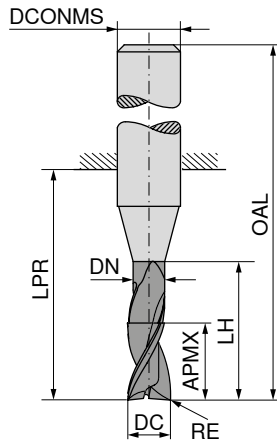
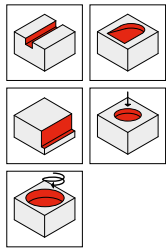
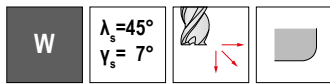

Factory standard

Factory standard

Factory standard

Factory standard



53 708 ...

53 710 ...

53 709 ...

53 711 ...

DC _{h6} mm	RE _{±0.05} mm	APMX mm	DN mm	LH mm	LPR mm	OAL mm	DCONMS _{h6} mm	ZEFP	53 708 ...	53 710 ...	53 709 ...	53 711 ...
2	0,3	4,5	1,8	6	14	50	6	3	02103	02103	02103	02103
2	0,5	4,5	1,8	6	14	50	6	3	02105	02105	02105	02105
3	0,3	6,5	2,7	9	19	55	6	3	03103	03103	03103	03103
3	0,5	6,5	2,7	9	19	55	6	3	03105	03105	03105	03105
3	1,0	6,5	2,7	9	19	55	6	3	03110	03110	03110	03110
4	0,3	8,5	3,7	12	19	55	6	3	04103	04103	04103	04103
4	0,5	8,5	3,7	12	19	55	6	3	04105	04105	04105	04105
4	1,0	8,5	3,7	12	19	55	6	3	04110	04110	04110	04110
5	0,3	10,5	4,7	15	22	58	6	3	05103	05103	05103	05103
5	0,5	10,5	4,7	15	22	58	6	3	05105	05105	05105	05105
5	1,0	10,5	4,7	15	22	58	6	3	05110	05110	05110	05110
6	0,3	13,0	5,7	18	22	58	6	3	06103	06103	06103	06103
6	0,5	13,0	5,7	18	22	58	6	3	06105	06105	06105	06105
6	1,0	13,0	5,7	18	22	58	6	3	06110	06110	06110	06110
6	1,5	13,0	5,7	18	22	58	6	3	06115	06115	06115	06115
8	0,3	17,0	7,4	24	28	64	8	3	08103	08103	08103	08103
8	0,5	17,0	7,4	24	28	64	8	3	08105	08105	08105	08105
8	1,0	17,0	7,4	24	28	64	8	3	08110	08110	08110	08110
8	1,5	17,0	7,4	24	28	64	8	3	08115	08115	08115	08115
8	2,0	17,0	7,4	24	28	64	8	3	08120	08120	08120	08120
10	0,3	21,0	9,2	30	34	74	10	3	10103	10103	10103	10103
10	0,5	21,0	9,2	30	34	74	10	3	10105	10105	10105	10105
10	1,0	21,0	9,2	30	34	74	10	3	10110	10110	10110	10110
10	1,5	21,0	9,2	30	34	74	10	3	10115	10115	10115	10115
10	2,0	21,0	9,2	30	34	74	10	3	10120	10120	10120	10120
10	3,0	21,0	9,2	30	34	74	10	3	10130	10130	10130	10130
12	0,3	25,0	11,0	36	40	85	12	3	12103	12103	12103	12103
12	0,5	25,0	11,0	36	40	85	12	3	12105	12105	12105	12105
12	1,0	25,0	11,0	36	40	85	12	3	12110	12110	12110	12110
12	1,5	25,0	11,0	36	40	85	12	3	12115	12115	12115	12115
12	2,0	25,0	11,0	36	40	85	12	3	12120	12120	12120	12120
12	3,0	25,0	11,0	36	40	85	12	3	12130	12130	12130	12130
12	4,0	25,0	11,0	36	40	85	12	3	12140	12140	12140	12140
16	0,3	33,0	15,0	48	52	100	16	3			16103	16103
16	0,5	33,0	15,0	48	52	100	16	3			16105	16105
16	1,0	33,0	15,0	48	52	100	16	3			16110	16110
16	1,5	33,0	15,0	48	52	100	16	3			16115	16115

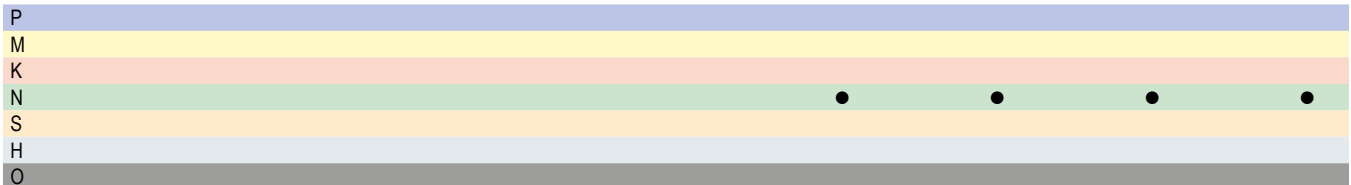

AluLine – End milling cutter with corner radius

The specialist for machining non-ferrous metals

▲ With polished chip flutes

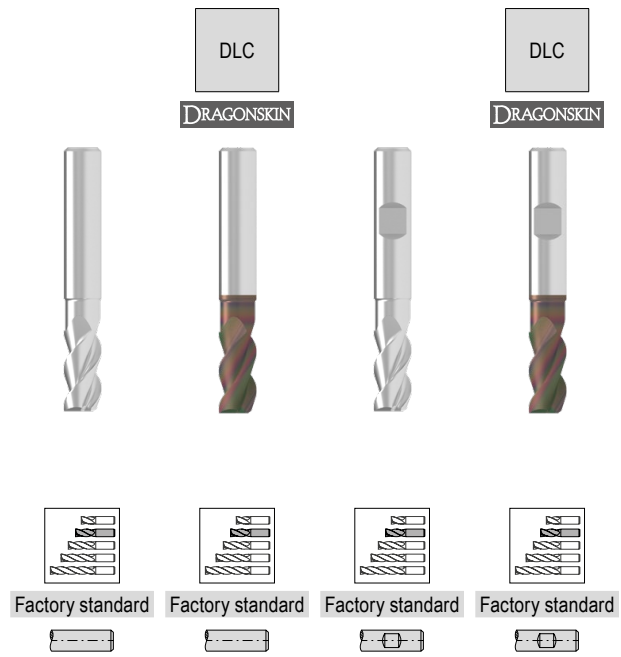
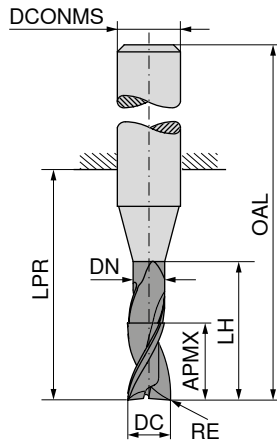
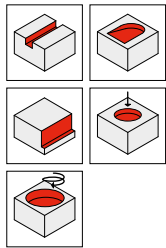
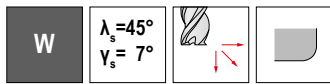

DC _{h6} mm	RE _{±0.05} mm	APMX mm	DN mm	LH mm	LPR mm	OAL mm	DCONMS _{h6} mm	ZEFP	53 708 ...	53 710 ...	53 709 ...	53 711 ...
16	2,0	33,0	15,0	48	52	100	16	3			16120	16120
16	3,0	33,0	15,0	48	52	100	16	3			16130	16130
16	4,0	33,0	15,0	48	52	100	16	3			16140	16140
20	0,5	42,0	19,0	60	64	114	20	3			20105	20105
20	1,0	42,0	19,0	60	64	114	20	3			20110	20110
20	1,5	42,0	19,0	60	64	114	20	3			20115	20115
20	2,0	42,0	19,0	60	64	114	20	3			20120	20120
20	3,0	42,0	19,0	60	64	114	20	3			20130	20130
20	4,0	42,0	19,0	60	64	114	20	3			20140	20140

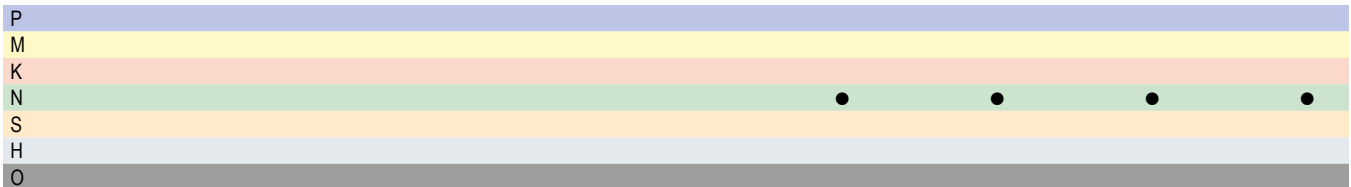

→ v_c/f_z Page 414+415

AluLine – End milling cutter with corner radius

The specialist for machining non-ferrous metals

▲ With polished chip flutes

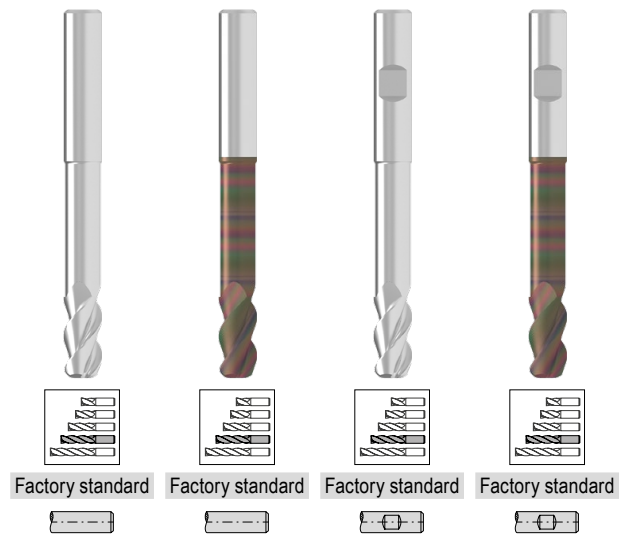
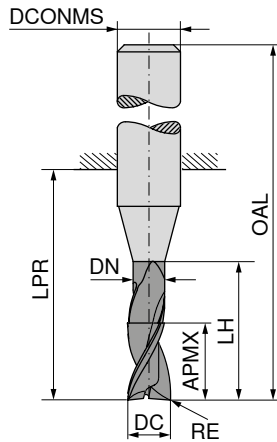
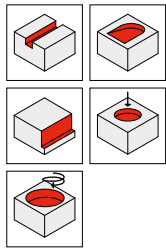
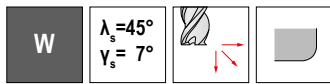

53 708 ... 53 710 ... 53 709 ... 53 711 ...

DC _{h6} mm	RE _{±0.05} mm	APMX mm	DN mm	LH mm	LPR mm	OAL mm	DCONMS _{h6} mm	ZEFP	53 708 ...	53 710 ...	53 709 ...	53 711 ...
2	0,3	5,5	1,8	10	19	55	6	3	02203	02203	02203	02203
2	0,5	5,5	1,8	10	19	55	6	3	02205	02205	02205	02205
3	0,3	8,0	2,7	15	22	58	6	3	03203	03203	03203	03203
3	0,5	8,0	2,7	15	22	58	6	3	03205	03205	03205	03205
3	1,0	8,0	2,7	15	22	58	6	3	03210	03210	03210	03210
4	0,3	10,5	3,7	20	26	62	6	3	04203	04203	04203	04203
4	0,5	10,5	3,7	20	26	62	6	3	04205	04205	04205	04205
4	1,0	10,5	3,7	20	26	62	6	3	04210	04210	04210	04210
5	0,3	13,0	4,7	25	34	70	6	3	05203	05203	05203	05203
5	0,5	13,0	4,7	25	34	70	6	3	05205	05205	05205	05205
5	1,0	13,0	4,7	25	34	70	6	3	05210	05210	05210	05210
6	0,3	16,0	5,7	30	34	70	6	3	06203	06203	06203	06203
6	0,5	16,0	5,7	30	34	70	6	3	06205	06205	06205	06205
6	1,0	16,0	5,7	30	34	70	6	3	06210	06210	06210	06210
6	1,5	16,0	5,7	30	34	70	6	3	06215	06215	06215	06215
8	0,3	21,0	7,4	40	44	80	8	3	08203	08203	08203	08203
8	0,5	21,0	7,4	40	44	80	8	3	08205	08205	08205	08205
8	1,0	21,0	7,4	40	44	80	8	3	08210	08210	08210	08210
8	1,5	21,0	7,4	40	44	80	8	3	08215	08215	08215	08215
8	2,0	21,0	7,4	40	44	80	8	3	08220	08220	08220	08220
10	0,3	26,0	9,2	50	54	94	10	3	10203	10203	10203	10203
10	0,5	26,0	9,2	50	54	94	10	3	10205	10205	10205	10205
10	1,0	26,0	9,2	50	54	94	10	3	10210	10210	10210	10210
10	1,5	26,0	9,2	50	54	94	10	3	10215	10215	10215	10215
10	2,0	26,0	9,2	50	54	94	10	3	10220	10220	10220	10220
10	3,0	26,0	9,2	50	54	94	10	3	10230	10230	10230	10230
12	0,3	31,0	11,0	60	64	109	12	3	12203	12203	12203	12203
12	0,5	31,0	11,0	60	64	109	12	3	12205	12205	12205	12205
12	1,0	31,0	11,0	60	64	109	12	3	12210	12210	12210	12210
12	1,5	31,0	11,0	60	64	109	12	3	12215	12215	12215	12215
12	2,0	31,0	11,0	60	64	109	12	3	12220	12220	12220	12220
12	3,0	31,0	11,0	60	64	109	12	3	12230	12230	12230	12230
12	4,0	31,0	11,0	60	64	109	12	3	12240	12240	12240	12240
16	0,3	41,0	15,0	80	84	132	16	3			16203	16203
16	0,5	41,0	15,0	80	84	132	16	3			16205	16205
16	1,0	41,0	15,0	80	84	132	16	3			16210	16210

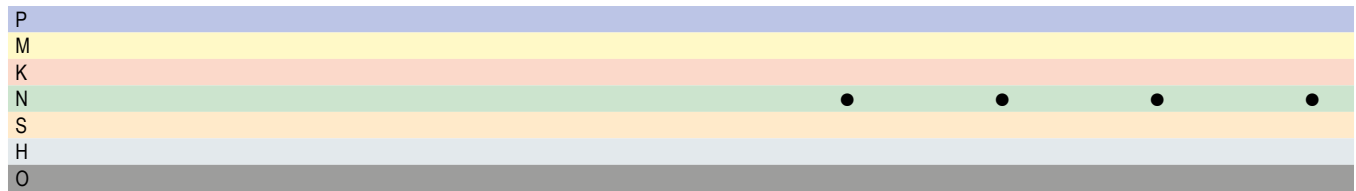

→ v_c/f_z Page 414+415

AluLine – End milling cutter with corner radius

The specialist for machining non-ferrous metals

▲ With polished chip flutes

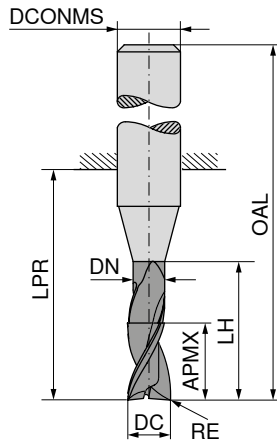
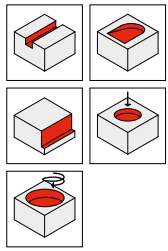
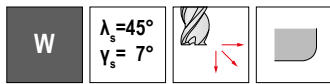

DRAGONSKIN



DRAGONSKIN

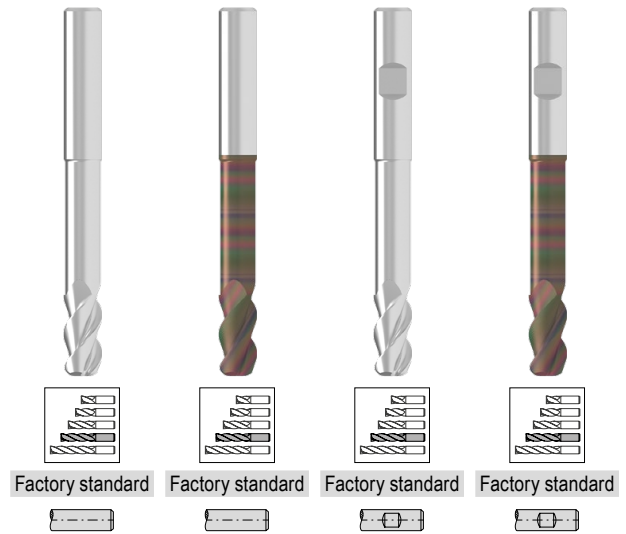

Factory standard Factory standard Factory standard Factory standard

	53 708 ...	53 710 ...	53 709 ...	53 711 ...
			16215	16215
			16220	16220
			16230	16230
			16240	16240
			20205	20205
			20210	20210
			20215	20215
			20220	20220
			20230	20230
			20240	20240

DC _{h6} mm	RE _{±0.05} mm	APMX mm	DN mm	LH mm	LPR mm	OAL mm	DCONMS _{h6} mm	ZEFP
16	1,5	41,0	15,0	80	84	132	16	3
16	2,0	41,0	15,0	80	84	132	16	3
16	3,0	41,0	15,0	80	84	132	16	3
16	4,0	41,0	15,0	80	84	132	16	3
20	0,5	52,0	19,0	100	104	154	20	3
20	1,0	52,0	19,0	100	104	154	20	3
20	1,5	52,0	19,0	100	104	154	20	3
20	2,0	52,0	19,0	100	104	154	20	3
20	3,0	52,0	19,0	100	104	154	20	3
20	4,0	52,0	19,0	100	104	154	20	3

P								
M								
K								
N								
S								
H								
O								

→ v_c/f_z Page 414+415

AluLine – End milling cutter with corner radius

The specialist for machining non-ferrous metals

▲ With polished chip flutes

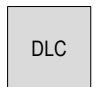
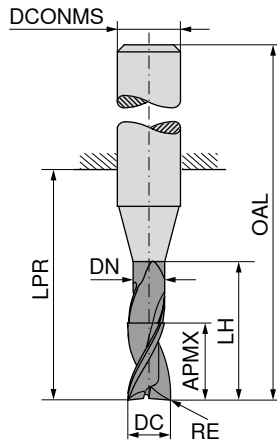
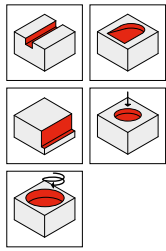
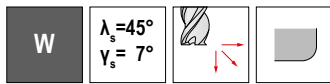

DRAGONSKIN

DRAGONSKIN

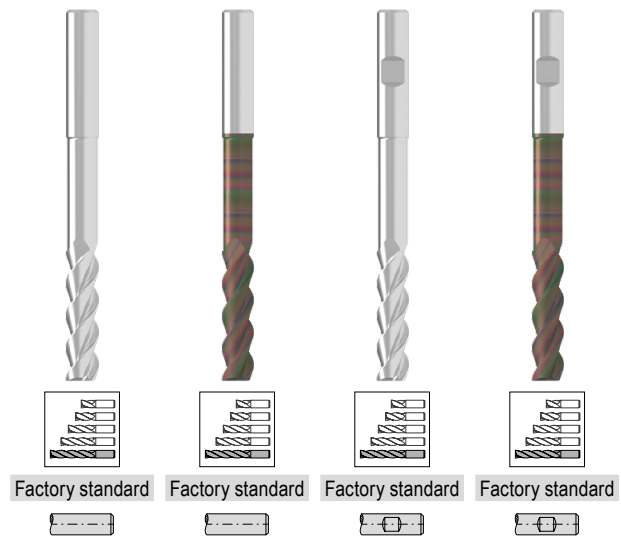

Factory standard Factory standard Factory standard Factory standard

53 708 ... 53 710 ... 53 709 ... 53 711 ...

DC _{h6}	RE _{±0.05}	APMX	DN	LH	LPR	OAL	DCONMS _{h6}	ZEFP				
mm	mm	mm	mm	mm	mm	mm	mm					
2	0,3	8,5	1,8	16	26	62	6	3				
2	0,5	8,5	1,8	16	26	62	6	3	02403	02403	02403	02403
3	0,3	12,5	2,7	24	31	67	6	3	03403	03403	03403	03403
3	0,5	12,5	2,7	24	31	67	6	3	03405	03405	03405	03405
3	1,0	12,5	2,7	24	31	67	6	3	03410	03410	03410	03410
4	0,3	16,5	3,7	32	38	74	6	3	04403	04403	04403	04403
4	0,5	16,5	3,7	32	38	74	6	3	04405	04405	04405	04405
4	1,0	16,5	3,7	32	38	74	6	3	04410	04410	04410	04410
5	0,3	20,5	4,7	40	52	88	6	3	05403	05403	05403	05403
5	0,5	20,5	4,7	40	52	88	6	3	05405	05405	05405	05405
5	1,0	20,5	4,7	40	52	88	6	3	05410	05410	05410	05410
6	0,3	25,0	5,7	48	52	88	6	3	06403	06403	06403	06403
6	0,5	25,0	5,7	48	52	88	6	3	06405	06405	06405	06405
6	1,0	25,0	5,7	48	52	88	6	3	06410	06410	06410	06410
6	1,5	25,0	5,7	48	52	88	6	3	06415	06415	06415	06415
8	0,3	33,0	7,4	64	68	104	8	3	08403	08403	08403	08403
8	0,5	33,0	7,4	64	68	104	8	3	08405	08405	08405	08405
8	1,0	33,0	7,4	64	68	104	8	3	08410	08410	08410	08410
8	1,5	33,0	7,4	64	68	104	8	3	08415	08415	08415	08415
8	2,0	33,0	7,4	64	68	104	8	3	08420	08420	08420	08420
10	0,3	41,0	9,2	80	84	124	10	3	10403	10403	10403	10403
10	0,5	41,0	9,2	80	84	124	10	3	10405	10405	10405	10405
10	1,0	41,0	9,2	80	84	124	10	3	10410	10410	10410	10410
10	1,5	41,0	9,2	80	84	124	10	3	10415	10415	10415	10415
10	2,0	41,0	9,2	80	84	124	10	3	10420	10420	10420	10420
10	3,0	41,0	9,2	80	84	124	10	3	10430	10430	10430	10430
12	0,3	49,0	11,0	96	100	145	12	3	12403	12403	12403	12403
12	0,5	49,0	11,0	96	100	145	12	3	12405	12405	12405	12405
12	1,0	49,0	11,0	96	100	145	12	3	12410	12410	12410	12410
12	1,5	49,0	11,0	96	100	145	12	3	12415	12415	12415	12415
12	2,0	49,0	11,0	96	100	145	12	3	12420	12420	12420	12420
12	3,0	49,0	11,0	96	100	145	12	3	12430	12430	12430	12430
12	4,0	49,0	11,0	96	100	145	12	3	12440	12440	12440	12440
16	0,3	65,0	15,0	128	132	180	16	3			16403	16403
16	0,5	65,0	15,0	128	132	180	16	3			16405	16405
16	1,0	65,0	15,0	128	132	180	16	3			16410	16410

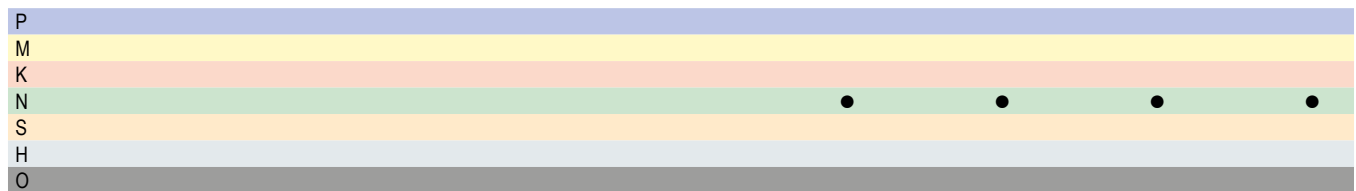

AluLine – End milling cutter with corner radius

The specialist for machining non-ferrous metals

▲ With polished chip flutes

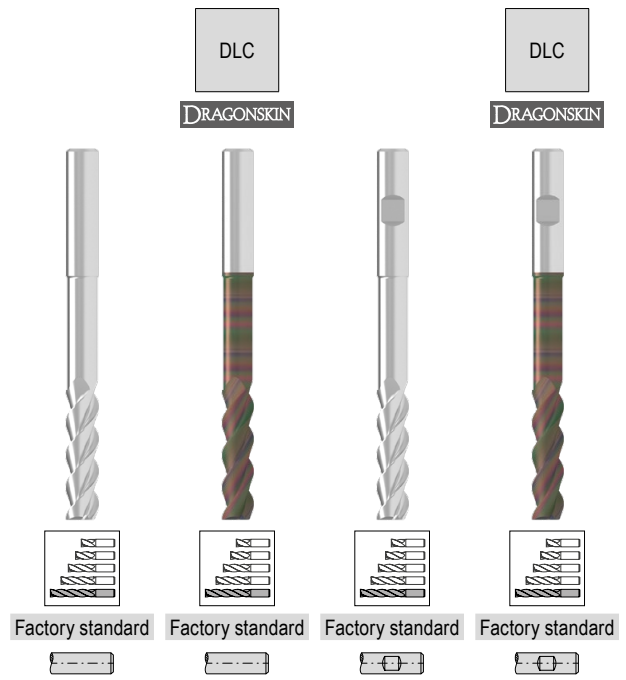
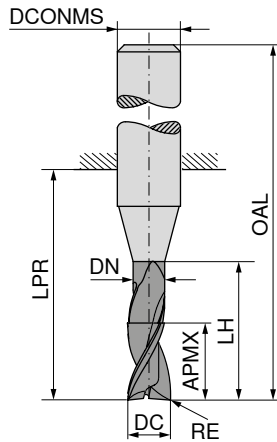
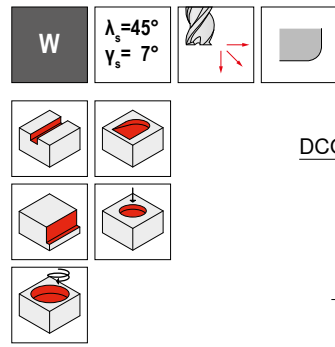

DC _{h6} mm	RE _{±0.05} mm	APMX mm	DN mm	LH mm	LPR mm	OAL mm	DCONMS _{h6} mm	ZEPF
16	1,5	65,0	15,0	128	132	180	16	3
16	2,0	65,0	15,0	128	132	180	16	3
16	3,0	65,0	15,0	128	132	180	16	3
16	4,0	65,0	15,0	128	132	180	16	3
20	0,5	82,0	19,0	160	164	214	20	3
20	1,0	82,0	19,0	160	164	214	20	3
20	1,5	82,0	19,0	160	164	214	20	3
20	2,0	82,0	19,0	160	164	214	20	3
20	3,0	82,0	19,0	160	164	214	20	3
20	4,0	82,0	19,0	160	164	214	20	3

53 708 ...	53 710 ...	53 709 ...	53 711 ...
		16415	16415
		16420	16420
		16430	16430
		16440	16440
		20405	20405
		20410	20410
		20415	20415
		20420	20420
		20430	20430
		20440	20440

P	
M	
K	
N	• • • •
S	
H	
O	

→ v_c/f_z Page 414+415

AluLine – End milling cutter with corner radius

The specialist for machining non-ferrous metals

▲ With polished chip flutes

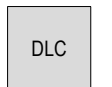
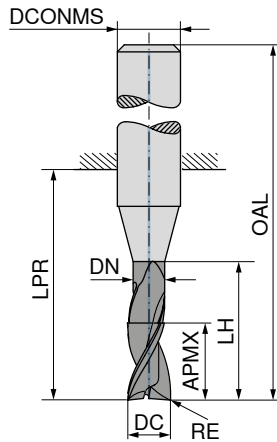
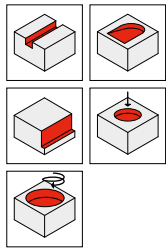
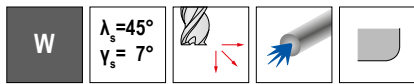

DRAGONSKIN

DRAGONSKIN

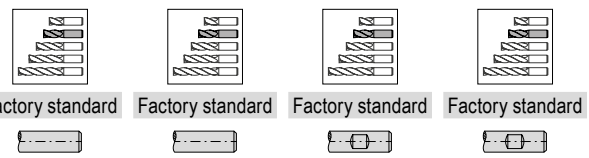
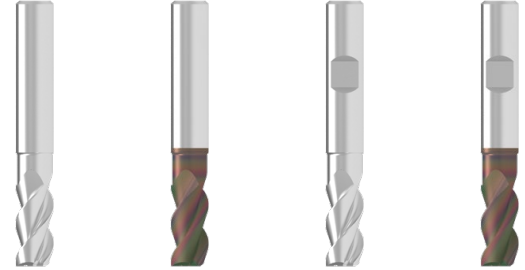

53 712 ... 53 714 ... 53 713 ... 53 715 ...

DC _{h6} mm	RE _{±0.05} mm	APMX mm	DN mm	LH mm	LPR mm	OAL mm	DCONMS _{h6} mm	ZEFP	53 712 ...	53 714 ...	53 713 ...	53 715 ...
6	0,3	13	5,7	18	22	58	6	3	06103	06103	06103	06103
6	0,5	13	5,7	18	22	58	6	3	06105	06105	06105	06105
6	1,0	13	5,7	18	22	58	6	3	06110	06110	06110	06110
6	1,5	13	5,7	18	22	58	6	3	06115	06115	06115	06115
8	0,3	17	7,4	24	28	64	8	3	08103	08103	08103	08103
8	0,5	17	7,4	24	28	64	8	3	08105	08105	08105	08105
8	1,0	17	7,4	24	28	64	8	3	08110	08110	08110	08110
8	1,5	17	7,4	24	28	64	8	3	08115	08115	08115	08115
8	2,0	17	7,4	24	28	64	8	3	08120	08120	08120	08120
10	0,3	21	9,2	30	34	74	10	3	10103	10103	10103	10103
10	0,5	21	9,2	30	34	74	10	3	10105	10105	10105	10105
10	1,0	21	9,2	30	34	74	10	3	10110	10110	10110	10110
10	1,5	21	9,2	30	34	74	10	3	10115	10115	10115	10115
10	2,0	21	9,2	30	34	74	10	3	10120	10120	10120	10120
10	3,0	21	9,2	30	34	74	10	3	10130	10130	10130	10130
12	0,3	25	11,0	36	40	85	12	3	12103	12103	12103	12103
12	0,5	25	11,0	36	40	85	12	3	12105	12105	12105	12105
12	1,0	25	11,0	36	40	85	12	3	12110	12110	12110	12110
12	1,5	25	11,0	36	40	85	12	3	12115	12115	12115	12115
12	2,0	25	11,0	36	40	85	12	3	12120	12120	12120	12120
12	3,0	25	11,0	36	40	85	12	3	12130	12130	12130	12130
12	4,0	25	11,0	36	40	85	12	3	12140	12140	12140	12140
16	0,3	33	15,0	48	52	100	16	3			16103	16103
16	0,5	33	15,0	48	52	100	16	3			16105	16105
16	1,0	33	15,0	48	52	100	16	3			16110	16110
16	1,5	33	15,0	48	52	100	16	3			16115	16115
16	2,0	33	15,0	48	52	100	16	3			16120	16120
16	3,0	33	15,0	48	52	100	16	3			16130	16130
16	4,0	33	15,0	48	52	100	16	3			16140	16140
20	0,5	42	19,0	60	64	114	20	3			20105	20105
20	1,0	42	19,0	60	64	114	20	3			20110	20110
20	1,5	42	19,0	60	64	114	20	3			20115	20115
20	2,0	42	19,0	60	64	114	20	3			20120	20120
20	3,0	42	19,0	60	64	114	20	3			20130	20130
20	4,0	42	19,0	60	64	114	20	3			20140	20140

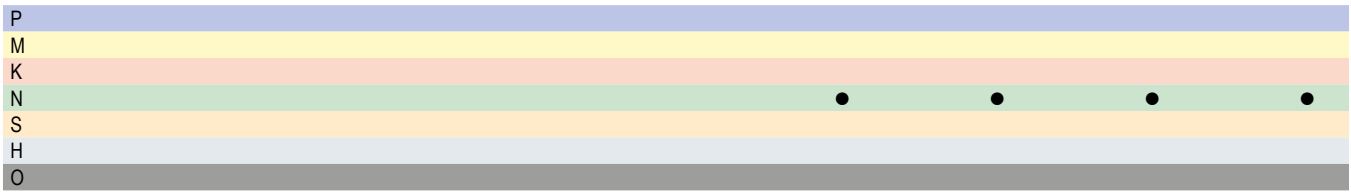

AluLine – End milling cutter with corner radius

The specialist for machining non-ferrous metals

▲ With polished chip flutes

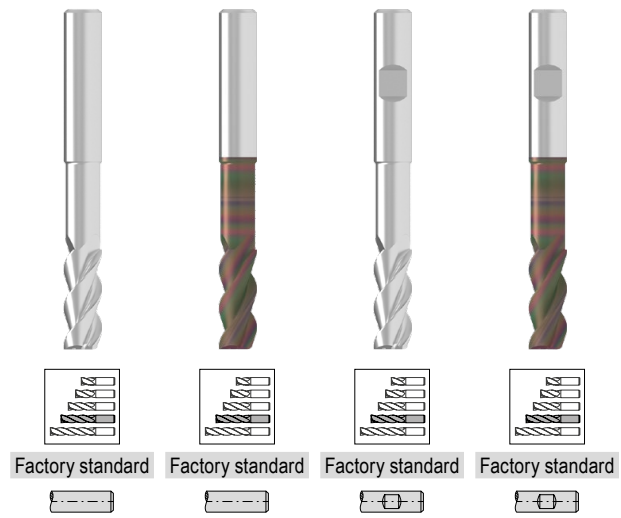
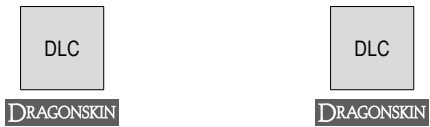
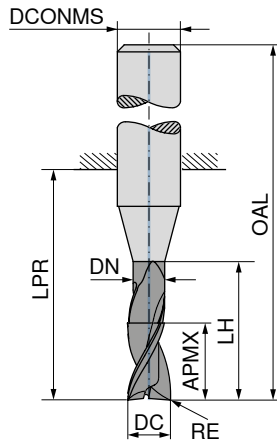
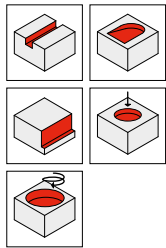
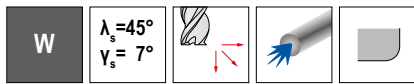

DC _{h6} mm	RE _{±0.01} mm	APMX mm	DN mm	LH mm	LPR mm	OAL mm	DCONMS _{h5} mm	ZEFP
6	0,3	16	5,7	30	34	70	6	3
6	0,5	16	5,7	30	34	70	6	3
6	1,0	16	5,7	30	34	70	6	3
6	1,5	16	5,7	30	34	70	6	3
8	0,3	21	7,4	40	44	80	8	3
8	0,5	21	7,4	40	44	80	8	3
8	1,0	21	7,4	40	44	80	8	3
8	1,5	21	7,4	40	44	80	8	3
8	2,0	21	7,4	40	44	80	8	3
10	0,3	26	9,2	50	54	94	10	3
10	0,5	26	9,2	50	54	94	10	3
10	1,0	26	9,2	50	54	94	10	3
10	1,5	26	9,2	50	54	94	10	3
10	2,0	26	9,2	50	54	94	10	3
10	3,0	26	9,2	50	54	94	10	3
12	0,3	31	11,0	60	64	109	12	3
12	0,5	31	11,0	60	64	109	12	3
12	1,0	31	11,0	60	64	109	12	3
12	1,5	31	11,0	60	64	109	12	3
12	2,0	31	11,0	60	64	109	12	3
12	3,0	31	11,0	60	64	109	12	3
12	4,0	31	11,0	60	64	109	12	3
16	0,3	41	15,0	80	84	132	16	3
16	0,5	41	15,0	80	84	132	16	3
16	1,0	41	15,0	80	84	132	16	3
16	1,5	41	15,0	80	84	132	16	3
16	2,0	41	15,0	80	84	132	16	3
16	3,0	41	15,0	80	84	132	16	3
16	4,0	41	15,0	80	84	132	16	3
20	0,5	52	19,0	100	104	154	20	3
20	1,0	52	19,0	100	104	154	20	3
20	1,5	52	19,0	100	104	154	20	3
20	2,0	52	19,0	100	104	154	20	3
20	3,0	52	19,0	100	104	154	20	3
20	4,0	52	19,0	100	104	154	20	3

53 712 ...	53 714 ...	53 713 ...	53 715 ...
06203	06203	06203	06203
06205	06205	06205	06205
06210	06210	06210	06210
06215	06215	06215	06215
08203	08203	08203	08203
08205	08205	08205	08205
08210	08210	08210	08210
08215	08215	08215	08215
08220	08220	08220	08220
10203	10203	10203	10203
10205	10205	10205	10205
10210	10210	10210	10210
10215	10215	10215	10215
10220	10220	10220	10220
10230	10230	10230	10230
12203	12203	12203	12203
12205	12205	12205	12205
12210	12210	12210	12210
12215	12215	12215	12215
12220	12220	12220	12220
12230	12230	12230	12230
12240	12240	12240	12240
		16203	16203
		16205	16205
		16210	16210
		16215	16215
		16220	16220
		16230	16230
		16240	16240
		20205	20205
		20210	20210
		20215	20215
		20220	20220
		20230	20230
		20240	20240

P				
M				
K				
N				
S				
H				
O				

AluLine – End milling cutter with corner radius

The specialist for machining non-ferrous metals

▲ With polished chip flutes

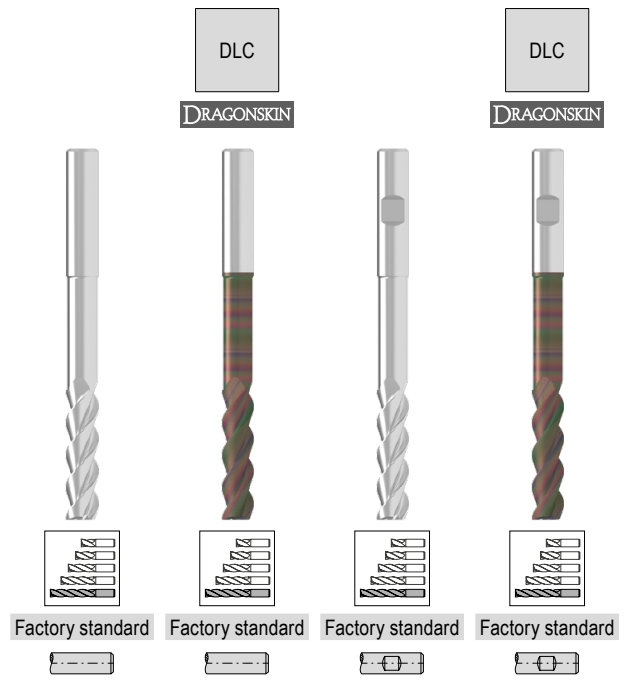
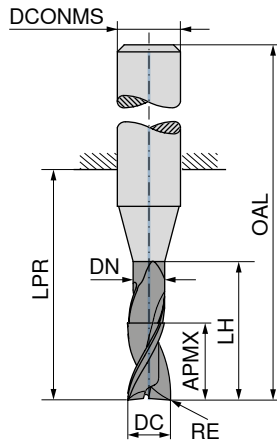
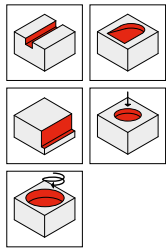
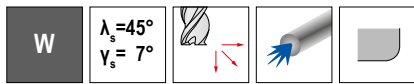

53 712 ... 53 714 ... 53 713 ... 53 715 ...

DC _{h6}	RE _{±0.01}	APMX	DN	LH	LPR	OAL	DCONMS _{h5}	ZEPF				
mm	mm	mm	mm	mm	mm	mm	mm					
6	0,3	25	5,7	48	52	88	6	3		06403		06403
6	0,5	25	5,7	48	52	88	6	3		06405		06405
6	1,0	25	5,7	48	52	88	6	3		06410		06410
6	1,5	25	5,7	48	52	88	6	3		06415		06415
8	0,3	33	7,4	64	68	104	8	3		08403		08403
8	0,5	33	7,4	64	68	104	8	3		08405		08405
8	1,0	33	7,4	64	68	104	8	3		08410		08410
8	1,5	33	7,4	64	68	104	8	3		08415		08415
8	2,0	33	7,4	64	68	104	8	3		08420		08420
10	0,3	41	9,2	80	84	124	10	3		10403		10403
10	0,5	41	9,2	80	84	124	10	3		10405		10405
10	1,0	41	9,2	80	84	124	10	3		10410		10410
10	1,5	41	9,2	80	84	124	10	3		10415		10415
10	2,0	41	9,2	80	84	124	10	3		10420		10420
10	3,0	41	9,2	80	84	124	10	3		10430		10430
12	0,3	49	11,0	96	100	145	12	3		12403		12403
12	0,5	49	11,0	96	100	145	12	3		12405		12405
12	1,0	49	11,0	96	100	145	12	3		12410		12410
12	1,5	49	11,0	96	100	145	12	3		12415		12415
12	2,0	49	11,0	96	100	145	12	3		12420		12420
12	3,0	49	11,0	96	100	145	12	3		12430		12430
12	4,0	49	11,0	96	100	145	12	3		12440		12440
16	0,3	65	15,0	128	132	180	16	3			16403	16403
16	0,5	65	15,0	128	132	180	16	3			16405	16405
16	1,0	65	15,0	128	132	180	16	3			16410	16410
16	1,5	65	15,0	128	132	180	16	3			16415	16415
16	2,0	65	15,0	128	132	180	16	3			16420	16420
16	3,0	65	15,0	128	132	180	16	3			16430	16430
16	4,0	65	15,0	128	132	180	16	3			16440	16440
20	0,5	82	19,0	160	164	214	20	3			20405	20405
20	1,0	82	19,0	160	164	214	20	3			20410	20410
20	1,5	82	19,0	160	164	214	20	3			20415	20415
20	2,0	82	19,0	160	164	214	20	3			20420	20420
20	3,0	82	19,0	160	164	214	20	3			20430	20430
20	4,0	82	19,0	160	164	214	20	3			20440	20440

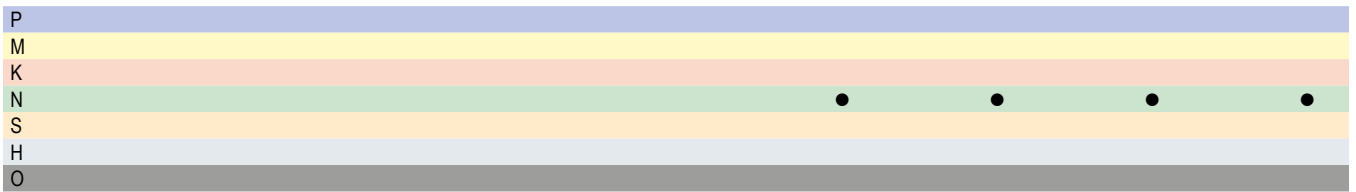

AluLine – End milling cutter

The specialist for machining non-ferrous metals

▲ With polished chip flutes

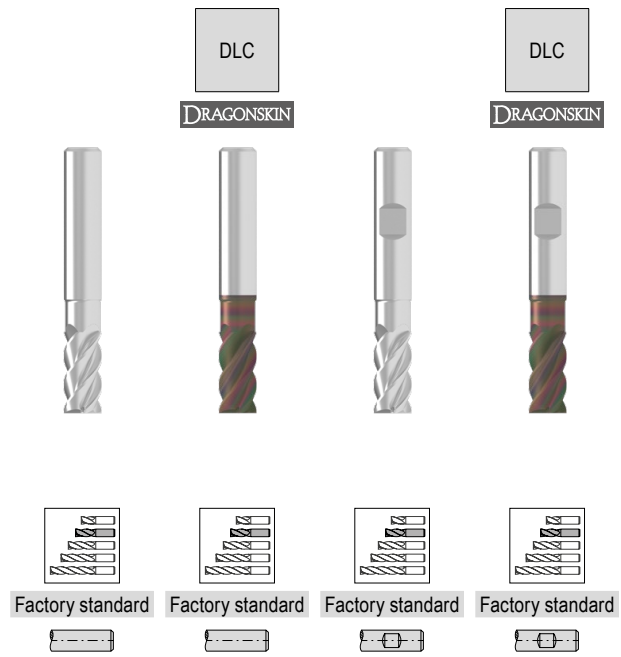
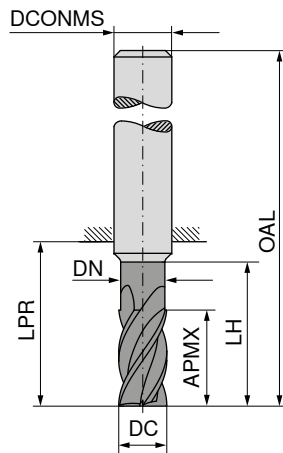
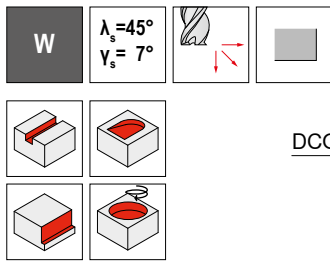

53 704 ...	53 706 ...	53 705 ...	53 707 ...
05100	05100	05100	05100
06100	06100	06100	06100
08100	08100	08100	08100
10100	10100	10100	10100
12100	12100	12100	12100
		14100	14100
		16100	16100
		18100	18100
		20100	20100

DC _{h6} mm	APMX mm	DN mm	LH mm	LPR mm	OAL mm	DCONMS _{h6} mm	ZEFP
5	10,5	4,8	15	22	58	6	4
6	13,0	5,8	18	22	58	6	4
8	17,0	7,7	24	28	64	8	4
10	21,0	9,7	30	34	74	10	4
12	25,0	11,6	36	40	85	12	4
14	29,0	13,6	42	46	91	14	4
16	33,0	15,5	48	52	100	16	4
18	38,0	17,5	54	58	106	18	4
20	42,0	19,5	60	64	114	20	4

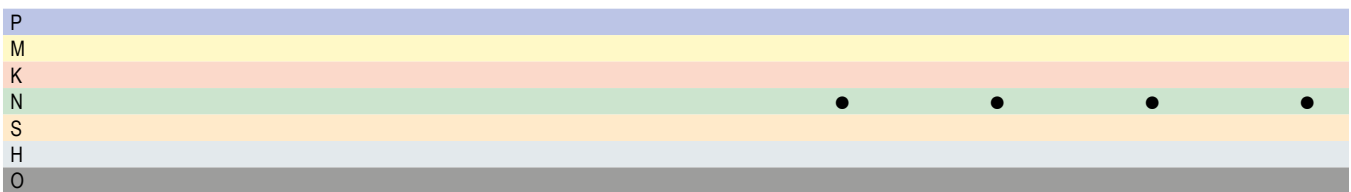

→ v_c/f_z Page 414+415

AluLine – End milling cutter

The specialist for machining non-ferrous metals

▲ With polished chip flutes

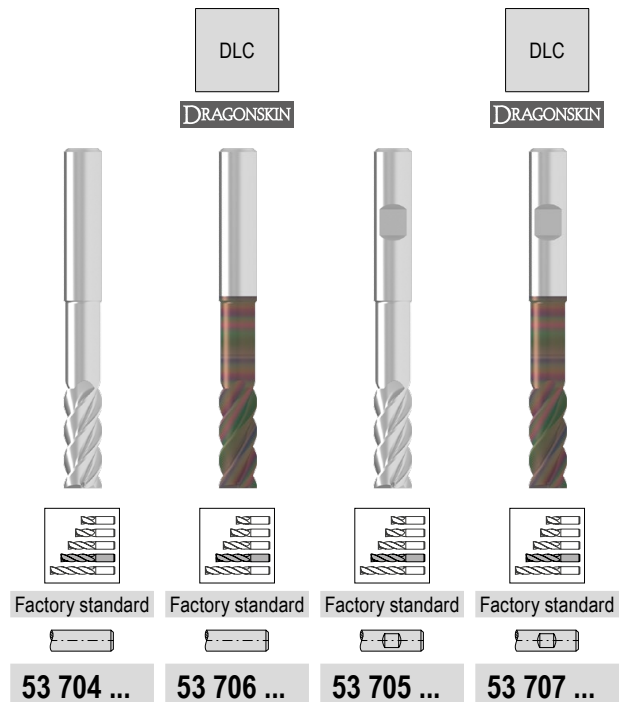
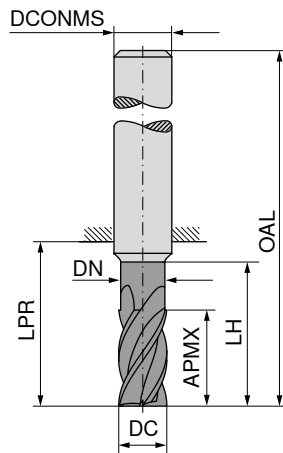
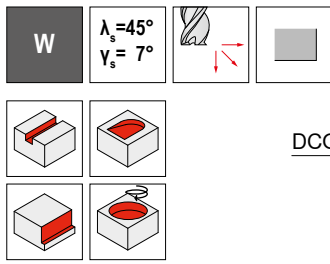

DC _{h6} mm	APMX mm	DN mm	LH mm	LPR mm	OAL mm	DCONMS _{h6} mm	ZEFP	53 704 ...	53 706 ...	53 705 ...	53 707 ...
2	5,5	1,8	10	19	55	6	4	02200	02200	02200	02200
3	8,0	2,8	15	22	58	6	4	03200	03200	03200	03200
4	10,5	3,8	20	26	62	6	4	04200	04200	04200	04200
5	13,0	4,8	25	34	70	6	4	05200	05200	05200	05200
6	16,0	5,8	30	34	70	6	4	06200	06200	06200	06200
8	21,0	7,7	40	44	80	8	4	08200	08200	08200	08200
10	26,0	9,7	50	54	94	10	4	10200	10200	10200	10200
12	31,0	11,6	60	64	109	12	4	12200	12200	12200	12200
14	36,0	13,6	70	74	119	14	4			14200	14200
16	41,0	15,5	80	84	132	16	4			16200	16200
18	47,0	17,5	90	94	142	18	4			18200	18200
20	52,0	19,5	100	104	154	20	4			20200	20200

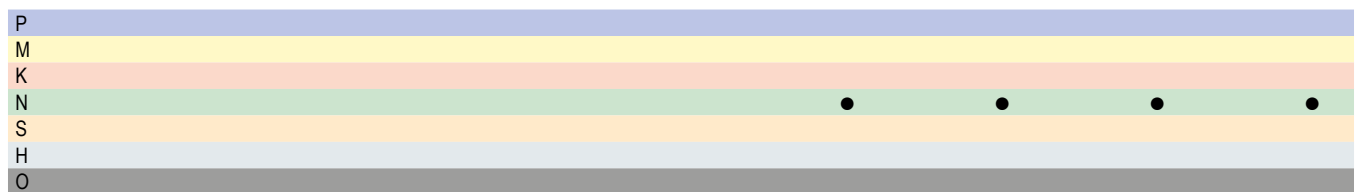

→ v_c/f_z Page 414+415

AluLine – End milling cutter

The specialist for machining non-ferrous metals

▲ With polished chip flutes

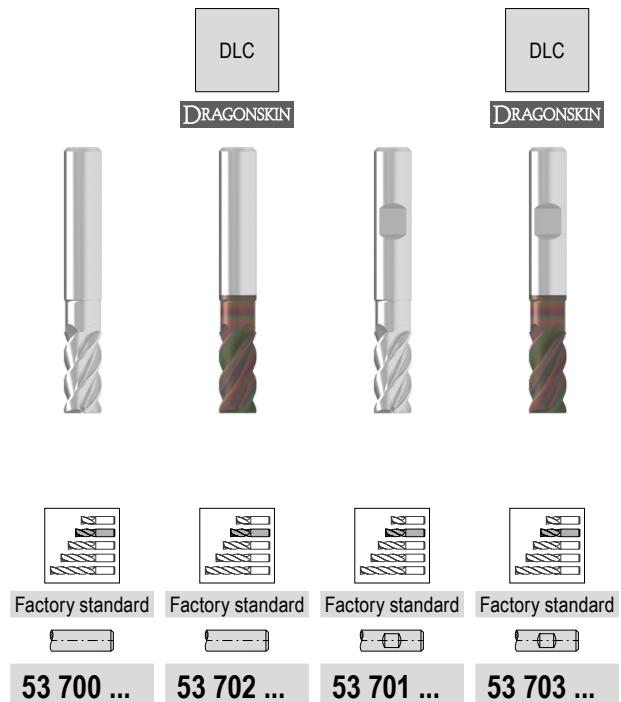
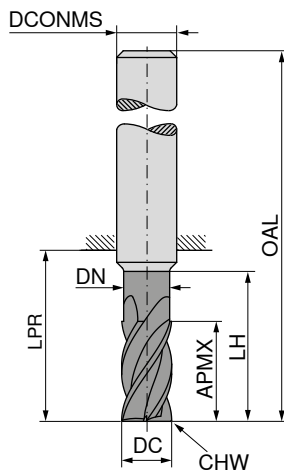
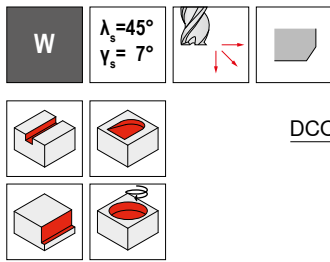

DC _{h6} mm	APMX mm	DN mm	LH mm	LPR mm	OAL mm	DCONMS _{h6} mm	CHW mm	ZEFP
5	10,5	4,8	15	22	58	6	0,1	4
6	13,0	5,8	18	22	58	6	0,2	4
8	17,0	7,7	24	28	64	8	0,2	4
10	21,0	9,7	30	34	74	10	0,2	4
12	25,0	11,6	36	40	85	12	0,2	4
14	29,0	13,6	42	46	91	14	0,2	4
16	33,0	15,5	48	52	100	16	0,2	4
18	38,0	17,5	54	58	106	18	0,2	4
20	42,0	19,5	60	64	114	20	0,2	4

Factory standard	Factory standard	Factory standard	Factory standard
53 700 ...	53 702 ...	53 701 ...	53 703 ...
05100	05100	05100	05100
06100	06100	06100	06100
08100	08100	08100	08100
10100	10100	10100	10100
12100	12100	12100	12100
		14100	14100
		16100	16100
		18100	18100
		20100	20100

P								
M								
K								
N						•	•	•
S								
H								
O								

→ v_c/f_z Page 414+415

AluLine – End milling cutter

The specialist for machining non-ferrous metals

▲ With polished chip flutes

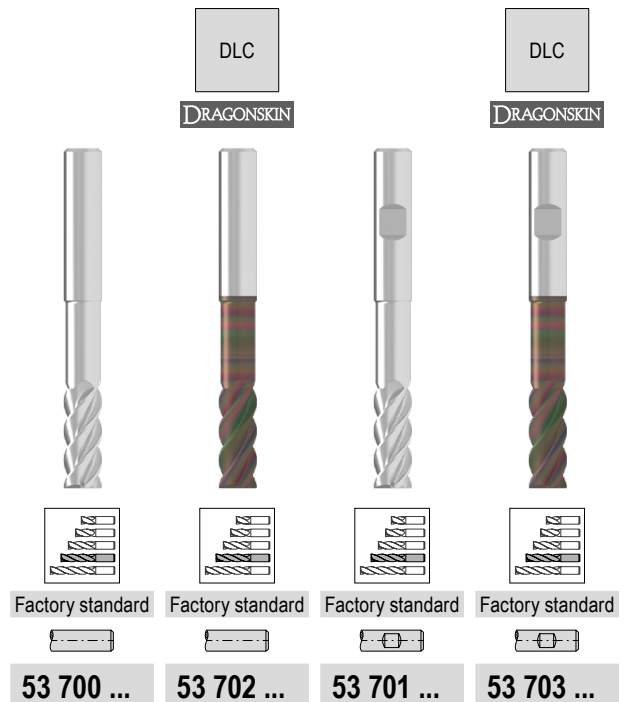
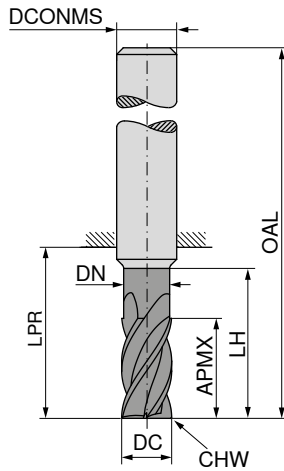
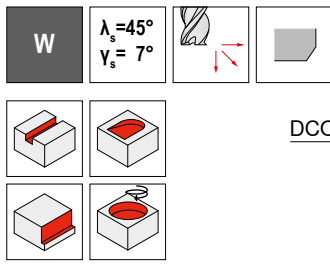

DC _{h6} mm	APMX mm	DN mm	LH mm	LPR mm	OAL mm	DCONMS _{h6} mm	CHW mm	ZEFP	53 700 ...	53 702 ...	53 701 ...	53 703 ...
2	5,5	1,8	10	19	55	6	0,05	4	02200	02200	02200	02200
3	8,0	2,8	15	22	58	6	0,10	4	03200	03200	03200	03200
4	10,5	3,8	20	26	62	6	0,10	4	04200	04200	04200	04200
5	13,0	4,8	25	34	70	6	0,10	4	05200	05200	05200	05200
6	16,0	5,8	30	34	70	6	0,20	4	06200	06200	06200	06200
8	21,0	7,7	40	44	80	8	0,20	4	08200	08200	08200	08200
10	26,0	9,7	50	54	94	10	0,20	4	10200	10200	10200	10200
12	31,0	11,6	60	64	109	12	0,20	4	12200	12200	12200	12200
14	36,0	13,6	70	74	119	14	0,20	4			14200	14200
16	41,0	15,5	80	84	132	16	0,20	4			16200	16200
18	47,0	17,5	90	94	142	18	0,20	4			18200	18200
20	52,0	19,5	100	104	154	20	0,20	4			20200	20200

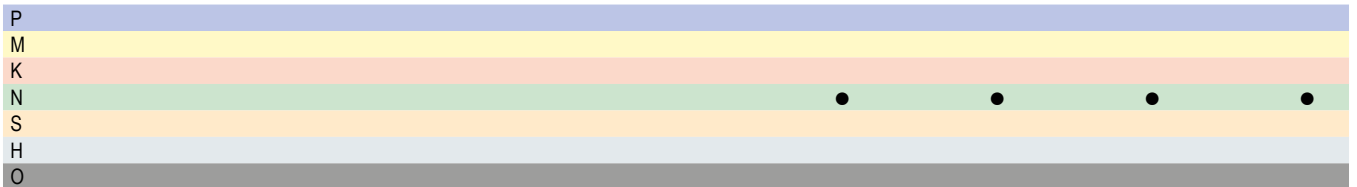

→ v_c/f_z Page 414+415

AluLine – End milling cutter

The specialist for machining non-ferrous metals

▲ With polished chip flutes

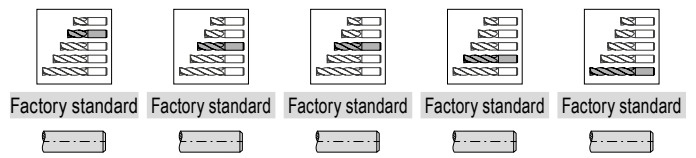
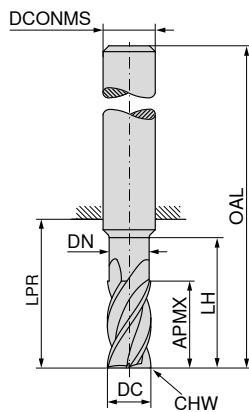
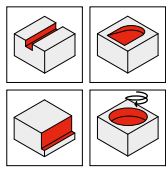
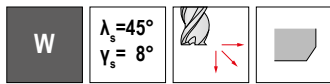

DC _{h10}	APMX	DN	LH	LPR	OAL	DCONMS _{h6}	CHW	ZEPF
mm	mm	mm	mm	mm	mm	mm	mm	
3,0	8	2,7	13	21	57	6	0,1	4
3,5	11	3,2	17	21	57	6	0,1	4
4,0	11	3,7	17	21	57	6	0,1	4
4,5	13	4,2	19	21	57	6	0,1	4
5,0	13	4,7	19	21	57	6	0,1	4
5,5	13	5,2	19	21	57	6	0,1	4
6,0	10	5,7	42	44	80	6	0,2	4
6,0	13	5,7	19	21	57	6	0,2	4
6,0	18	5,7	24	26	62	6	0,2	4
6,5	21	6,1	25	27	63	8	0,2	4
8,0	13	7,4	62	64	100	8	0,2	4
8,0	21	7,4	25	27	63	8	0,2	4
8,0	24	7,4	30	32	68	8	0,2	4
8,5	22	7,9	30	32	72	10	0,2	4
10,0	16	9,2	58	60	100	10	0,2	4
10,0	22	9,2	30	32	72	10	0,2	4
10,0	30	9,2	38	40	80	10	0,2	4
12,0	19	11,0	73	75	120	12	0,2	4
12,0	26	11,0	36	38	83	12	0,2	4
12,0	36	11,0	46	48	93	12	0,2	4
14,0	26	13,0	36	38	83	14	0,2	4
16,0	25	15,0	100	102	150	16	0,2	4
16,0	36	15,0	42	44	92	16	0,2	4
16,0	48	15,0	58	60	108	16	0,2	4
18,0	36	17,0	42	44	92	18	0,2	4
20,0	32	19,0	98	100	150	20	0,2	4
20,0	41	19,0	52	54	104	20	0,2	4
20,0	60	19,0	74	76	126	20	0,2	4
25,0	52	24,0	62	65	121	25	0,3	4

53 560 ...	53 561 ...	53 562 ...	53 563 ...	53 564 ...
			030	
			035	
			040	
			045	
		050		
		055		
		060		060
		065	060	
	080	080		080
		085		
	100	100	100	
		100		120
	120	120		
		120		160
140				
160				
		160		
180				
			200	
200				
		200		
250				



→ v_c/f_z Page 414+415

AluLine – Roughing-Finishing Cutter

The specialist for machining non-ferrous metals

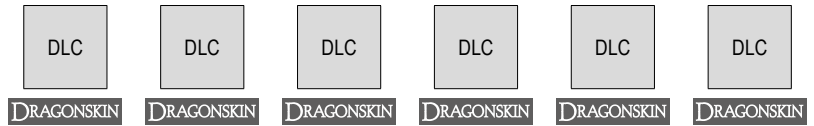
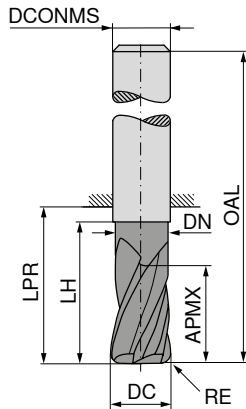
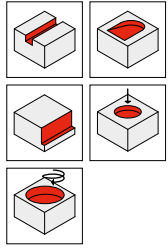
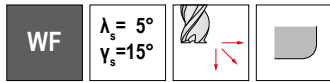

Factory standard Factory standard Factory standard Factory standard Factory standard Factory standard



53 582 ... 53 583 ... 53 582 ... 53 583 ... 53 582 ... 53 583 ...

DC _{a8} mm	RE _{±0.05} mm	APMX mm	DN mm	LH mm	LPR mm	OAL mm	DCONMS _{h6} mm	ZEFP	53 582 ...	53 583 ...	53 582 ...	53 583 ...	53 582 ...	53 583 ...	
3	0,10	5	2,7	18	44	80	6	3				03301	03301		
4	0,10	7	3,7	24	44	80	6	3				04301	04301		
5	0,15	8	4,7	16	18	54	6	3	05101	05101		05301	05301		
5	0,15	8	4,7	30	44	80	6	3						05201	05201
5	0,15	13	4,7	18	21	57	6	3							
6	0,20	10	5,7	17	18	54	6	3	06102	06102		06302	06302		
6	0,20	10	5,7	42	44	80	6	3							
6	0,20	13	5,7	18	21	57	6	3						06202	06202
8	0,25	13	7,4	20	22	58	8	3	08103	08103					
8	0,25	13	7,4	62	64	100	8	3							
8	0,25	21	7,4	25	27	63	8	3						08203	08203
10	0,30	16	9,2	24	26	66	10	3	10103	10103					
10	0,30	16	9,2	58	60	100	10	3							
10	0,30	22	9,2	30	32	72	10	3						10203	10203
12	0,35	19	11,0	26	28	73	12	3	12104	12104					
12	0,35	19	11,0	73	75	120	12	3							
12	0,35	26	11,0	36	38	83	12	3							
16	0,50	25	15,0	32	34	82	16	3		16105				12204	12204
16	0,50	25	15,0	100	102	150	16	3					16305		
16	0,50	36	15,0	42	44	92	16	3							16205
20	0,60	32	19,0	40	42	92	20	3							
20	0,60	32	19,0	100	100	150	20	3					20306		
20	0,60	41	19,0	52	54	104	20	3							20206

P																
M																
K																
N																
S																
H																
O																

→ v_c/f_z Page 416+417

AluLine – Rough milling cutter

The specialist for machining non-ferrous metals

▲ With polished chip flutes

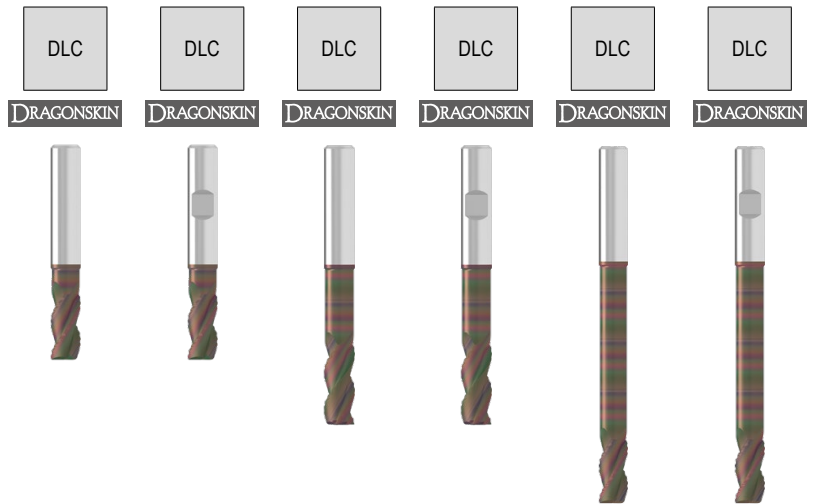
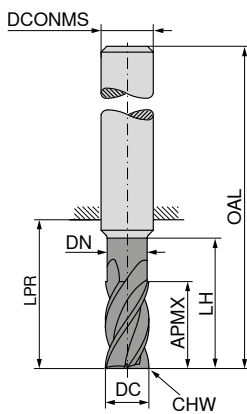
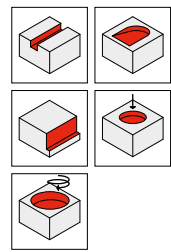
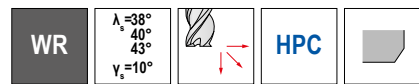

Factory standard Factory standard Factory standard Factory standard Factory standard Factory standard

DC _{drill}	APMX	DN	LH	LPR	OAL	DCONMS _{h6}	CHW	ZEFP	53 578 ...	53 579 ...	53 578 ...	53 579 ...	53 578 ...	53 579 ...
mm	mm	mm	mm	mm	mm	mm	mm							
6	13	5,8	18	22	58	6	0,4	3	06100	06100				
6	16	5,8	30	34	70	6	0,4	3			06200	06200		
6	13	5,8	48	52	88	6	0,4	3					06400	06400
8	17	7,7	24	28	64	8	0,4	3	08100	08100				
8	21	7,7	40	44	80	8	0,4	3			08200	08200		
8	17	7,7	65	68	104	8	0,4	3					08400	08400
10	21	9,7	30	34	74	10	0,4	3	10100	10100				
10	26	9,7	50	54	94	10	0,4	3			10200	10200		
10	21	9,7	80	84	124	10	0,4	3					10400	10400
12	25	11,6	36	40	85	12	0,4	3	12100	12100				
12	31	11,6	60	64	109	12	0,4	3			12200	12200		
12	25	11,6	96	100	145	12	0,4	3					12400	12400
16	33	15,5	48	52	100	16	0,4	3			16100			
16	41	15,5	80	84	132	16	0,4	3				16200		
16	33	15,5	128	132	180	16	0,4	3						16400
20	42	19,5	60	64	114	20	0,4	3			20100			
20	52	19,5	100	104	154	20	0,4	3				20200		
20	42	19,5	160	164	214	20	0,4	3						20400

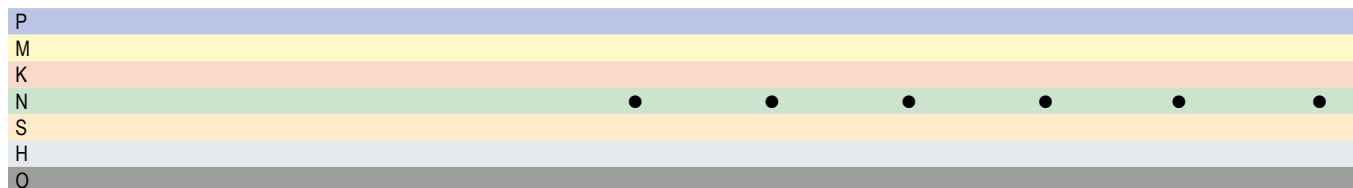

→ v_c/f_z Page 414+415

AluLine – Rough milling cutter

The specialist for machining non-ferrous metals

▲ With polished chip flutes

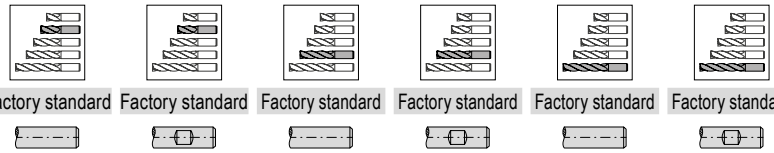
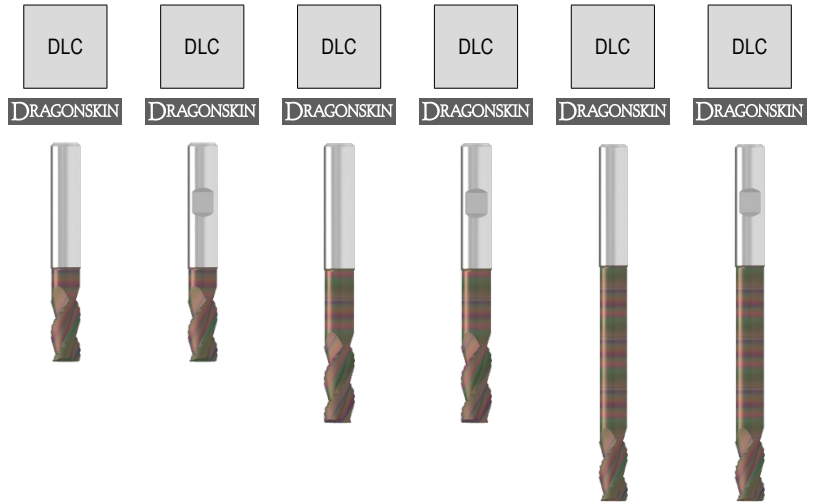
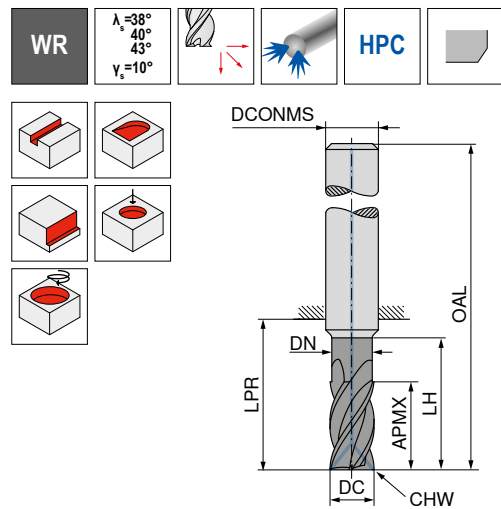

DC_{011} mm	$APMX$ mm	DN mm	LH mm	LPR mm	OAL mm	$DCONMS_{h6}$ mm	CHW mm	$ZEFP$	53 580 ...	53 581 ...	53 580 ...	53 581 ...	53 580 ...	53 581 ...	
6	13	5,8	18	22	58	6	0,4	3	06100	06100					
6	16	5,8	30	34	70	6	0,4	3			06200	06200			
6	13	5,8	48	52	88	6	0,4	3					06400	06400	
8	17	7,7	24	28	64	8	0,4	3	08100	08100					
8	21	7,7	40	44	80	8	0,4	3			08200	08200			
8	17	7,7	64	68	104	8	0,4	3					08400	08400	
10	21	9,7	30	34	74	10	0,4	3	10100	10100					
10	26	9,7	50	54	94	10	0,4	3			10200	10200			
10	21	9,7	80	84	124	10	0,4	3					10400	10400	
12	25	11,6	36	40	85	12	0,4	3	12100	12100					
12	31	11,6	60	64	109	12	0,4	3					12400	12400	
12	25	11,6	96	100	145	12	0,4	3					12400	12400	
16	33	15,5	48	52	100	16	0,4	3							
16	41	15,5	80	84	132	16	0,4	3					16100		
16	33	15,5	128	132	180	16	0,4	3					16200		
20	42	19,5	60	64	114	20	0,4	3						16400	
20	52	19,5	100	104	154	20	0,4	3					20100		
20	42	19,5	160	164	214	20	0,4	3					20200		
															20400

P															
M															
K															
N									•	•	•	•	•	•	•
S															
H															
O															

→ v_c/f_z Page 414+415

AluLine – High Accuracy Finish Milling Cutter

The specialist for machining non-ferrous metals

▲ max. taper of 0.003 mm for high precision and parallelism of vertical walls

▲ Tool with cutting edge correction

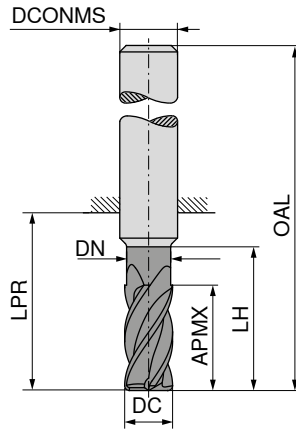
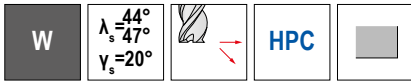

DC ₁₈ mm	APMX mm	DN mm	LH mm	LPR mm	OAL mm	DCONMS _{n6} mm	ZEFP
6	16	5,7	20	22	58	6	6
6	16	5,7	42	44	80	6	6
8	19	7,4	26	28	64	8	6
8	19	7,4	62	64	100	8	6
10	25	9,2	32	34	74	10	6
10	25	9,2	58	60	100	10	6
12	30	11,0	37	39	84	12	6
12	30	11,0	73	75	120	12	6
12	45			75	120	12	6
16	40	15,0	44	45	93	16	6
16	40	15,0	100	102	150	16	6
16	65			102	150	16	6
20	50	19,0	53	54	104	20	6
20	50	19,0	98	100	150	20	6
20	75			100	150	20	6

53 639 ...	53 639 ...	53 639 ...
06100		06400
08100		08400
10100		10400
12100		12400
16100	12200	16400
20100	16200	20400
	20200	

P			
M			
K			
N		•	•
S			
H			
O			

→ v_c/f_z Page 416+417

AluLine – Ball Nosed Cutter

The specialist for machining non-ferrous metals

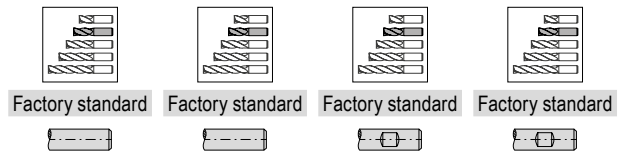
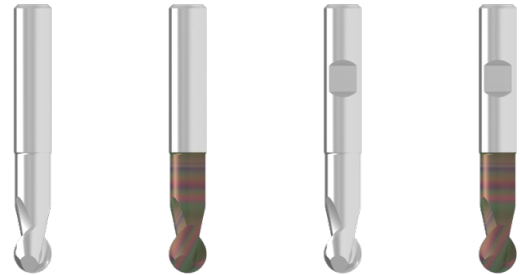
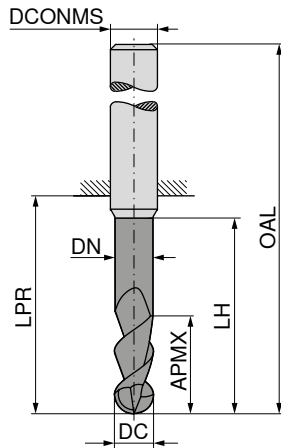
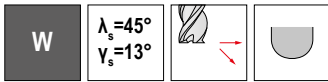

53 607 ... 53 608 ... 53 609 ... 53 610 ...

DC ₁₈ mm	APMX mm	DN mm	LH mm	LPR mm	OAL mm	DCONMS _{n6} mm	ZEFP	53 607 ...	53 608 ...	53 609 ...	53 610 ...
3	6	2,7	16	22	50	3	2	03100	03100		
4	7	3,7	17	26	54	4	2	04100	04100		
5	8	4,6	18	26	54	5	2	05100	05100		
6	10	5,5	21	26	62	6	2	06100	06100	06100	06100
8	12	7,5	27	31	67	8	2	08100	08100	08100	08100
10	13	9,4	32	34	74	10	2	10100	10100	10100	10100
12	16	11,4	38	48	93	12	2	12100	12100	12100	12100
14	16	13,2	38	55	100	14	2	14100	14100	14100	14100
16	20	15,0	44	52	100	16	2	16100	16100	16100	16100
20	25	19,0	50	54	104	20	2	20100	20100	20100	20100

P											
M											
K											
N								●	●	●	●
S											
H											
O								○	○	○	○

→ v_c/f_z Page 416+417

AluLine – Ball Nosed Cutter

The specialist for machining non-ferrous metals

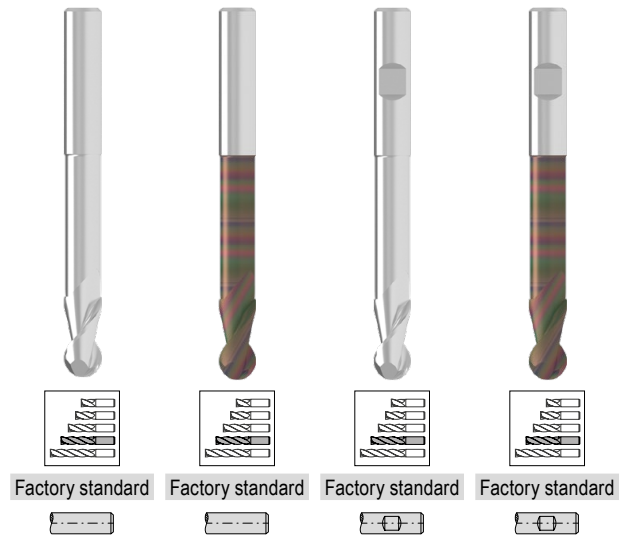
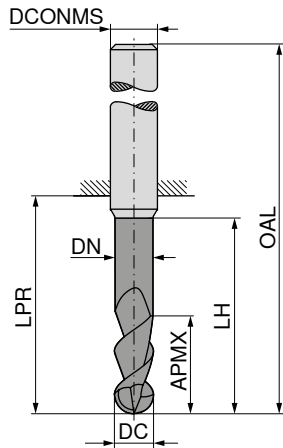

	53 607 ...	53 608 ...	53 609 ...	53 610 ...
DC ₁₈ mm				
APMX mm				
DN mm				
LH mm				
LPR mm				
OAL mm				
DCONMS ₁₆ mm				
ZEFP				
	03200	03200		
	04200	04200		
	05200	05200		
	06200	06200	06200	06200
	08200	08200	08200	08200
	10200	10200	10200	10200
	12200	12200	12200	12200
	14200	14200	14200	14200
	16200	16200	16200	16200
	20200	20200	20200	20200

P								
M								
K								
N		•	•	•	•			
S								
H								
O		○	○	○	○			

→ v_c/f_z Page 416+417

AluLine – Ball Nosed Cutter

The specialist for machining non-ferrous metals

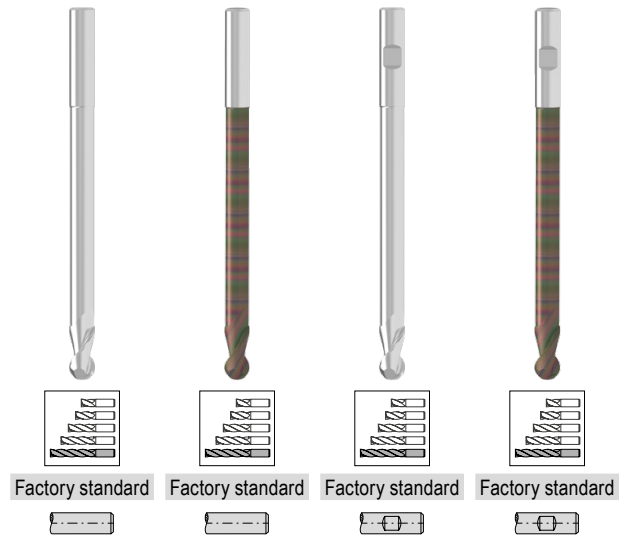
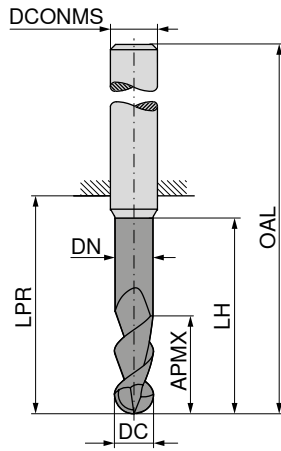

DC ₁₈ mm	APMX mm	DN mm	LH mm	LPR mm	OAL mm	DCONMS ₁₆ mm	ZEFP
3	10	2,7	82	97	125	3	2
4	13	3,7	86	97	125	4	2
6	16	5,5	94	114	150	6	2
8	22	7,5	104	114	150	8	2
10	25	9,4	110	111	151	10	2
12	26	11,4	105	106	151	12	2
16	30	15,0	192	202	250	16	2

53 607 ...	53 608 ...	53 609 ...	53 610 ...
03400	03400		
04400	04400		
06400	06400	06400	06400
08400	08400	08400	08400
10400	10400	10400	10400
12400	12400	12400	12400
16400	16400	16400	16400

P				
M				
K				
N		•	•	•
S				
H				
O		○	○	○

→ v_c/f_z Page 416+417

AluLine – NC deburring cutter

The specialist for machining non-ferrous metals

▲ Point angle $\alpha = 60^\circ$

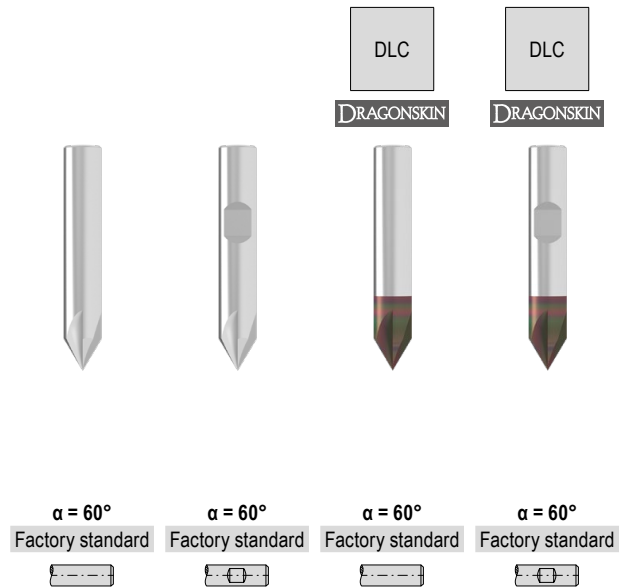
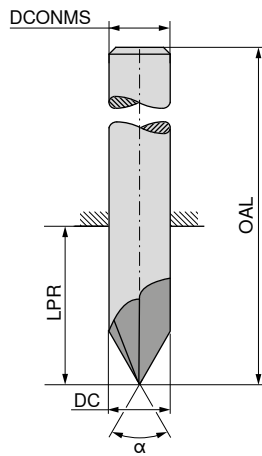
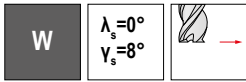

$\alpha = 60^\circ$ Factory standard $\alpha = 60^\circ$ Factory standard $\alpha = 60^\circ$ Factory standard $\alpha = 60^\circ$ Factory standard

53 666 ...	53 667 ...	53 662 ...	53 663 ...
04000	06000	04000	06000
08000	08000	08000	08000
10000	10000	10000	10000
12000	12000	12000	12000
16000	16000	16000	16000

DC mm	OAL mm	LPR mm	DCONMS mm	ZEFP
4	50	22	4	4
6	55	19	6	4
8	58	22	8	4
10	60	20	10	4
12	70	25	12	4
16	80	32	16	4

P				
M				
K				
N	•	•	•	•
S				
H				
O	•	•	•	•

→ v_c/f_z Page 419

AluLine – NC deburring cutter

The specialist for machining non-ferrous metals

▲ Point angle $\alpha = 90^\circ$

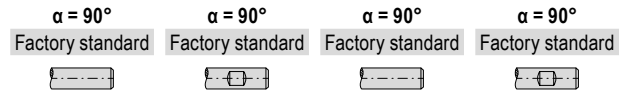
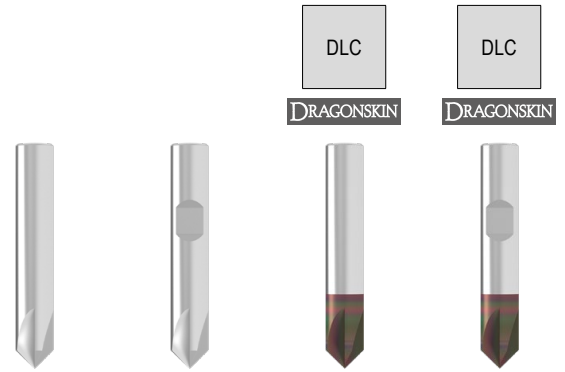
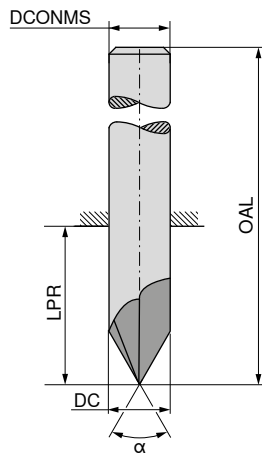
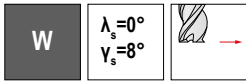

$\alpha = 90^\circ$	$\alpha = 90^\circ$	$\alpha = 90^\circ$	$\alpha = 90^\circ$
Factory standard	Factory standard	Factory standard	Factory standard
53 664 ...	53 665 ...	53 660 ...	53 661 ...
04000	06000	04000	06000
08000	08000	08000	08000
10000	10000	10000	10000
12000	12000	12000	12000
16000	16000	16000	16000

DC	OAL	LPR	DCONMS	ZEFP
mm	mm	mm	mm	
4	50	22	4	4
6	55	19	6	4
8	58	22	8	4
10	60	20	10	4
12	70	25	12	4
16	80	32	16	4

P				
M				
K				
N		•	•	•
S				
H				
O		•	•	•

→ v_c/f_z Page 419

PCD end mill

The tool with the highest cutting parameters and longest service lives for machining non-ferrous metals and plastics

▲ Transition angle $\alpha = 45^\circ$

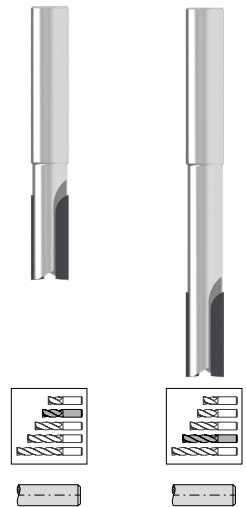
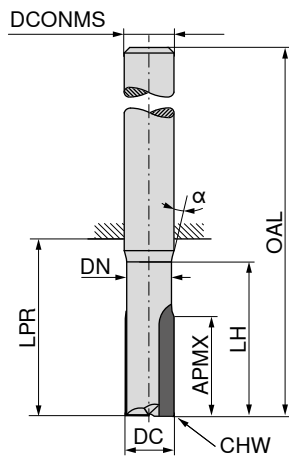
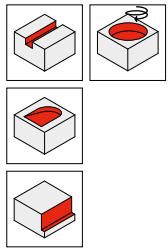
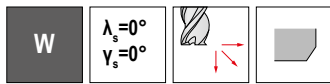

DC _{h7} mm	APMX mm	DN mm	LH mm	LPR mm	OAL mm	DCONMS _{h6} mm	CHW mm	ZEFP
3	6	2,8	11	21	57	6	0,15	2
3	6	2,8	22	64	100	6	0,15	2
4	8	3,5	13	21	57	6	0,15	2
4	8	3,5	26	64	100	6	0,15	2
5	10	4,4	15	21	57	6	0,15	2
5	10	4,4	30	64	100	6	0,15	2
6	12	5,4	19	21	57	6	0,15	2
6	12	5,4	38	64	100	6	0,15	2
8	16	7,2	26	28	64	8	0,15	2
8	16	7,2	52	64	100	8	0,15	2
10	20	9,0	31	34	74	10	0,15	2
10	20	9,0	60	60	100	10	0,15	2

50 010 ...	50 010 ...
03100	03300
04100	04300
05100	05300
06100	06300
08100	08300
10100	10300

P		
M		
K		
N	●	●
S		
H		
O	●	●

→ v_c/f_z Page 412+413

PCD end mill

The tool with the highest cutting parameters and longest service lives for machining non-ferrous metals and plastics

▲ Transition angle $\alpha = 15^\circ$

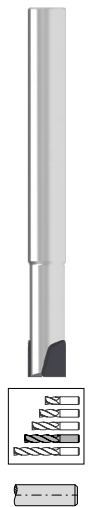
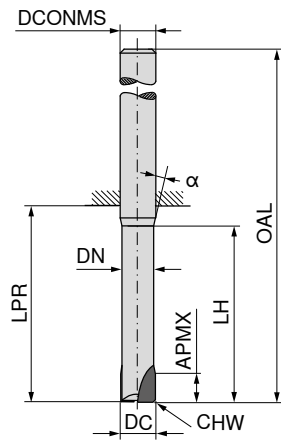
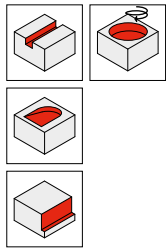
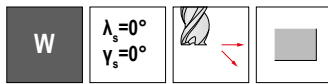

50 011 ...

DC _{nr} mm	APMX mm	DN mm	LH mm	LPR mm	OAL mm	DCONMS _{nr} mm	CHW mm	ZEFP	
2	2,0	1,7	6	39	75	6	0,1	1	02100
2	2,0	1,7	10	39	75	6	0,1	1	02300
2	2,0	1,7	14	39	75	6	0,1	1	02200
3	2,5	2,5	9	39	75	6	0,2	2	03100
3	2,5	2,5	15	39	75	6	0,2	2	03300
3	2,5	2,5	21	39	75	6	0,2	2	03200
4	2,5	3,5	12	39	75	6	0,2	2	04100
4	2,5	3,5	20	39	75	6	0,2	2	04300
4	2,5	3,5	28	39	75	6	0,2	2	04200
5	3,0	4,4	15	39	75	6	0,2	2	05100
5	3,0	4,4	25	39	75	6	0,2	2	05300
5	3,0	4,4	35	39	75	6	0,2	2	05200
6	6,0	5,4	18	64	100	6	0,2	2	06100
6	6,0	5,4	30	64	100	6	0,2	2	06300
6	6,0	5,4	42	64	100	6	0,2	2	06200
8	7,0	7,2	24	64	100	8	0,2	2	08100
8	7,0	7,2	40	64	100	8	0,2	2	08300
10	8,0	9,0	30	60	100	10	0,2	2	10100
10	8,0	9,0	50	60	100	10	0,2	2	10300
12	9,0	11,0	36	60	105	12	0,2	2	12100
12	9,0	11,0	58	60	105	12	0,2	2	12300

P	
M	
K	
N	●
S	
H	
O	●

→ v_c/f_z Page 412+413

PCD end mill

The tool with the highest cutting parameters and longest service lives for machining non-ferrous metals and plastics

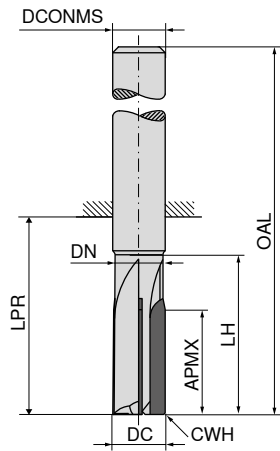
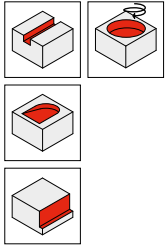
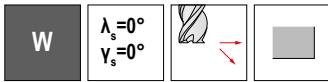

DC _{h7} mm	APMX mm	DN mm	LH mm	LPR mm	OAL mm	DCONMS _{h6} mm	CHW mm	ZEFP
6	12	5,4	19	21	57	6	0,05	4
6	12	5,4	38	64	100	6	0,05	4
8	16	7,2	26	28	64	8	0,05	4
8	16	7,2	52	64	100	8	0,05	4
10	20	9,0	31	34	74	10	0,10	4
10	20	9,0	62	60	100	10	0,10	4
12	24	11,0	37	39	84	12	0,10	4
12	24	11,0	73	70	115	12	0,10	4
16	32	15,0	44	45	93	16	0,20	4
16	32	15,0	88	90	130	16	0,20	4
20	38	19,0	53	54	104	20	0,20	4
20	38	19,0	105	110	160	20	0,20	4

50 013 ...	50 013 ...
06100	06200
08100	08200
10100	10200
12100	12200
16100	16200
20100	20200

P		
M		
K		
N	•	•
S		
H		
O	•	•

→ v_c/f_z Page 412+413

PCD radius cutter

The tool with the highest cutting parameters and longest service lives for machining non-ferrous metals and plastics

▲ Transition angle $\alpha = 15^\circ$

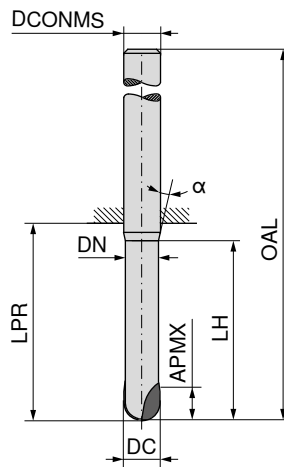
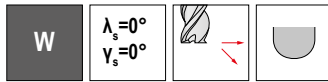

50 014 ...
02100
02200
02300
02400
03100
03200
03300
03400
04100
04200
04300
04400
05100
05200
05400
06100
06200
06300
06400
08100
08300
08900
10100
10200
10300
12100
12200
12400
16200
16300
20400

DC _{nr} mm	APMX mm	DN mm	LH mm	LPR mm	OAL mm	DCONMS _{nr6} mm	ZFP
2	2,0	1,7	6	39	75	6	1
2	2,0	1,7	10	39	75	6	1
2	2,0	1,7	14	39	75	6	1
2	2,0	1,7	35	39	75	6	1
3	2,5	2,5	9	39	75	6	2
3	2,5	2,5	15	39	75	6	2
3	2,5	2,5	21	39	75	6	2
3	2,5	2,5	35	39	75	6	2
4	2,5	3,5	12	39	75	6	2
4	2,5	3,5	20	39	75	6	2
4	2,5	3,5	28	39	75	6	2
4	2,5	3,5	35	39	75	6	2
5	3,0	4,4	15	39	75	6	2
5	3,0	4,4	25	39	75	6	2
5	3,0	4,4	35	39	75	6	2
6	6,0	5,4	18	64	100	6	2
6	6,0	5,4	30	64	100	6	2
6	6,0	5,4	40	64	100	8	2
6	6,0	5,4	42	64	100	6	2
8	7,0	7,2	24	64	100	8	2
8	7,0	7,2	40	64	100	8	2
8	7,0	7,2	40	60	100	10	2
10	8,0	9,0	30	60	100	10	2
10	8,0	9,0	40	55	100	12	2
10	8,0	9,0	50	60	100	10	2
12	9,0	11,0	36	60	105	12	2
12	9,0	11,0	40	55	100	16	2
12	9,0	11,0	58	60	105	12	2
16	11,0	15,0	45	82	130	16	2
16	11,0	15,0	50	82	130	16	2
20	13,0	19,0	60	110	160	20	2

P
M
K
N
S
H
O

→ v_c/f_z Page 412+413

PCD torus cutter

The tool with the highest cutting parameters and longest service lives for machining non-ferrous metals and plastics

▲ Transition angle $\alpha = 15^\circ$

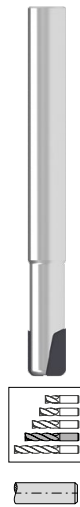
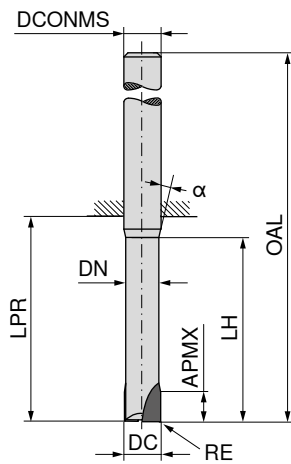
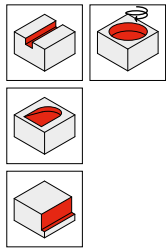
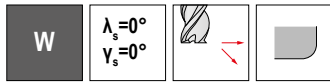

50 012 ...

DC _{h7} mm	RE mm	APMX mm	DN mm	LH mm	LPR mm	OAL mm	DCONMS _{h6} mm	ZFP	
2	0,3	2,0	1,7	6	39	75	6	1	02103
2	0,3	2,0	1,7	10	39	75	6	1	02203
2	0,3	2,0	1,7	14	39	75	6	1	02303
2	0,3	2,0	1,7	35	39	75	6	1	02403
3	0,3	2,5	2,5	9	39	75	6	2	03103
3	0,3	2,5	2,5	15	39	75	6	2	03203
3	0,3	2,5	2,5	21	39	75	6	2	03303
3	0,3	2,5	2,5	35	39	75	6	2	03403
4	0,3	2,5	3,5	12	39	75	6	2	04103
4	0,3	2,5	3,5	20	39	75	6	2	04203
4	0,3	2,5	3,5	28	39	75	6	2	04303
4	0,3	2,5	3,5	35	39	75	6	2	04403
5	0,3	3,0	4,4	15	39	75	6	2	05103
5	0,3	3,0	4,4	25	39	75	6	2	05203
5	0,3	3,0	4,4	35	39	75	6	2	05303
6	0,3	6,0	5,4	18	64	100	6	2	06103
6	0,3	6,0	5,4	30	64	100	6	2	06203
6	0,3	6,0	5,4	42	64	100	6	2	06403
6	0,5	6,0	5,4	18	64	100	6	2	06105
6	0,5	6,0	5,4	30	64	100	6	2	06205
6	0,5	6,0	5,4	42	64	100	6	2	06405
6	1,0	6,0	5,4	18	64	100	6	2	06110
6	1,0	6,0	5,4	40	64	100	8	2	06310
6	1,0	6,0	5,4	42	64	100	6	2	06410
8	0,3	7,0	7,2	24	64	100	8	2	08103
8	0,3	7,0	7,2	40	64	100	8	2	08203
8	0,5	7,0	7,2	24	64	100	8	2	08105
8	0,5	7,0	7,2	40	64	100	8	2	08205
8	1,0	7,0	7,2	24	64	100	8	2	08110
8	1,0	7,0	7,2	40	64	100	8	2	08210
8	2,0	7,0	7,2	24	64	100	8	2	08120
8	2,0	7,0	7,2	40	60	100	10	2	08920
8	2,0	7,0	7,2	40	64	100	8	2	08220
10	0,5	8,0	9,0	30	60	100	10	2	10105
10	0,5	8,0	9,0	50	60	100	10	2	10305
10	1,0	8,0	9,0	30	60	100	10	2	10110
10	1,0	8,0	9,0	50	60	100	10	2	10310
10	1,5	8,0	9,0	30	60	100	10	2	10115

P	
M	
K	
N	●
S	
H	
O	●

→ v_c/f_z Page 412+413

PCD torus cutter

The tool with the highest cutting parameters and longest service lives for machining non-ferrous metals and plastics

▲ Transition angle $\alpha = 15^\circ$

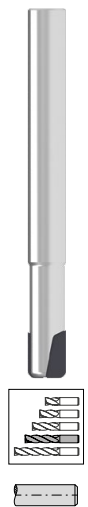
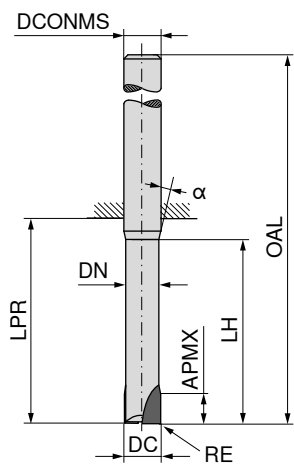
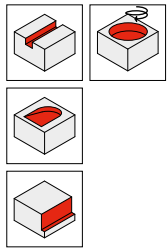
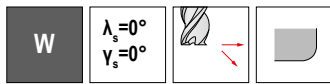

50 012 ...

DC _{h7} mm	RE mm	APMX mm	DN mm	LH mm	LPR mm	OAL mm	DCONMS _{h6} mm	ZFP	
10	1,5	8,0	9,0	50	60	100	10	2	10315
10	2,0	8,0	9,0	30	60	100	10	2	10120
10	2,0	8,0	9,0	50	60	100	10	2	10320
10	3,0	8,0	9,0	30	60	100	10	2	10130
10	3,0	8,0	9,0	40	55	100	12	2	10230
10	3,0	8,0	9,0	50	60	100	10	2	10330
12	0,5	9,0	11,0	36	60	105	12	2	12105
12	0,5	9,0	11,0	58	60	105	12	2	12305
12	1,0	9,0	11,0	36	60	105	12	2	12110
12	1,0	9,0	11,0	58	60	105	12	2	12310
12	1,5	9,0	11,0	36	60	105	12	2	12115
12	1,5	9,0	11,0	58	60	105	12	2	12315
12	4,0	9,0	11,0	40	52	100	16	2	12240
16	3,0	11,0	15,0	45	82	130	16	2	16130
16	5,0	11,0	15,0	50	82	130	16	2	16250
20	6,0	13,0	19,0	60	140	160	20	2	20260

P	
M	
K	
N	●
S	
H	
O	●

→ v_c/f_z Page 412+413

PCD end mill

The tool with the highest cutting parameters and longest service lives for machining non-ferrous metals and plastics

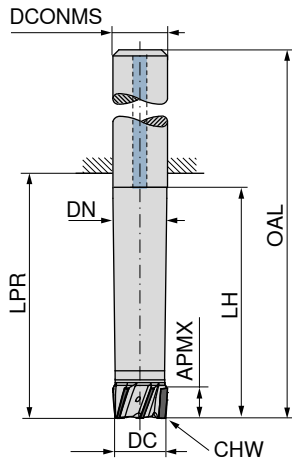
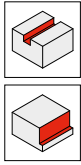
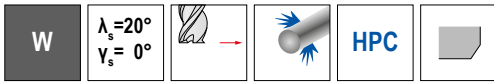

50 015 ...

DC mm	APMX mm	DN mm	LH mm	LPR mm	OAL mm	DCONMS mm	CHW mm	ZEFP	KOMET no.	
10	5	9,6	25,0	27	67	10	0,2	4	38320001001000	10200
12	5	11,6	30,0	33	78	12	0,2	4	38320001001200	12200
16	11	15,6	40,0	43	91	16	0,2	5	38320001001600	16200
20	11	19,6	50,0	54	104	20	0,2	6	38320001002000	20200
25	11	24,6	62,5	68	124	25	0,2	8	38320001002500	25200
32	11	31,6	80,0	87	147	32	0,2	10	38320001003200	32200

P	
M	
K	
N	●
S	
H	
O	●

→ v_c/f_z Page 412+413

PCD face and shoulder mill

The tool with the highest cutting parameters and longest service lives for machining non-ferrous metals and plastics

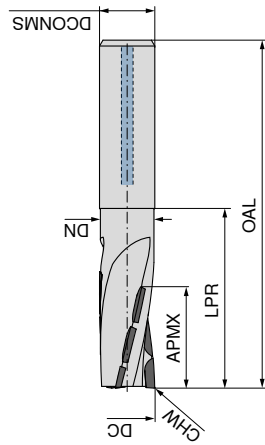
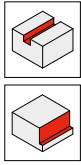
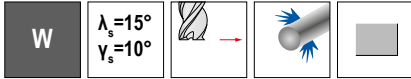

50 020 ...

DC _{h7} mm	APMX mm	DN mm	LPR mm	OAL mm	DCONMS _{h6} mm	ZEFP	KOMET no.	
16	30	15,5	45	93	16	3	38170099001600	01600
20	30	19,5	50	100	20	3	38170099002000	02000
25	30	24,5	54	110	25	3	38170099002500	02500

P	
M	
K	
N	●
S	
H	
O	●

→ v_c/f_z Page 412+413

PCD drilling slot screw-in cutter

The tool with the highest cutting parameters and longest service lives for machining non-ferrous metals and plastics

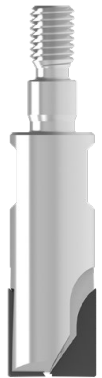
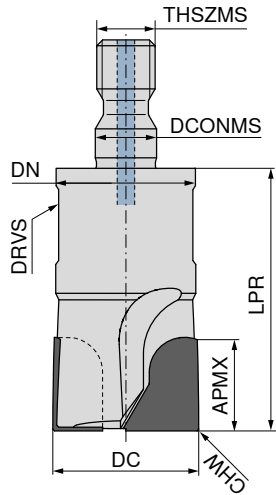
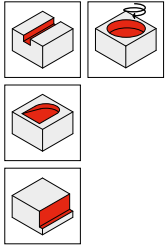
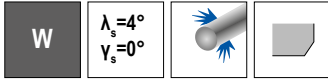

50 016 ...

DC	APMX	DN	LPR	DCONMS	CHW	DRVS	ZEFP	THSZMS	KOMET no.	
mm	mm	mm	mm	mm	mm	mm	mm			
10	10	9,6	28	5,5	0,2	8	2	M5	37340099001000	01000
12	12	9,6	28	5,5	0,2	8	2	M5	37340099001200	01200
16	16	13,8	32	8,5	0,2	13	3	M8	37340099001600	01600
20	20	18,0	45	10,5	0,2	16	3	M10	37340099002000	02000
25	20	21,0	45	12,6	0,2	18	3	M12	37340099002500	02500

P
M
K
N
S
H
O

→ v_c/f_z Page 412+413

PCD face screw-in cutter

The tool with the highest cutting parameters and longest service lives for machining non-ferrous metals and plastics

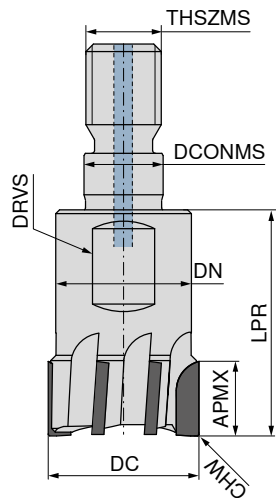
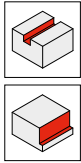
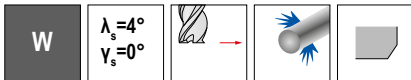

50 018 ...

DC mm	APMX mm	DN mm	LPR mm	DCONMS mm	CHW mm	DRVS mm	ZEFP	THSZMS	KOMET no.	
10	5	9,6	22	5,5	0,2	8	2	M5	37341099001000	01000
12	5	9,6	28	5,5	0,2	8	2	M5	37341099001200	01200
16	10	13,8	28	8,5	0,2	13	3	M8	37341099001600	01600
20	10	18,0	30	10,5	0,2	16	4	M10	37341099002000	02000
25	10	21,0	35	12,5	0,2	18	5	M12	37341099002500	02500
32	10	29,0	35	17,0	0,2	27	6	M16	37341099003200	03200

P	
M	
K	
N	●
S	
H	
O	●

→ v_c/f_z Page 412+413

PCD screw-in cutter

The tool with the highest cutting parameters and longest service lives for machining non-ferrous metals and plastics

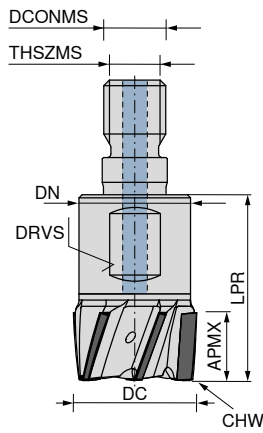
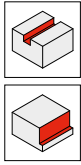
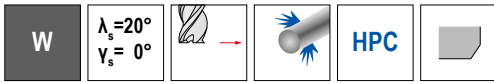

50 015 ...

DC mm	APMX mm	DN mm	LPR mm	DCONMS mm	CHW mm	DRVS mm	ZEPF	THSZMS	KOMET no.	
10	5	9,6	22	5,5	0,2	8	4	M5	37310001001000	10100
12	5	11,5	22	6,5	0,2	10	4	M6	37310099001200	12100
16	11	13,8	28	8,5	0,2	13	5	M8	37310001001600	16100
20	11	18,0	30	10,5	0,2	16	6	M10	37310001002000	20100
25	11	21,0	35	12,5	0,2	18	8	M12	37310001002500	25100
32	11	29,0	35	17,0	0,2	27	10	M16	37310001003200	32100

P	
M	
K	
N	●
S	
H	
O	●

→ v_c/f_z Page 412+413

PCD radius screw-in cutter

The tool with the highest cutting parameters and longest service lives for machining non-ferrous metals and plastics

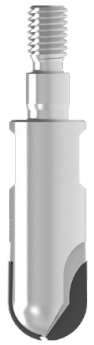
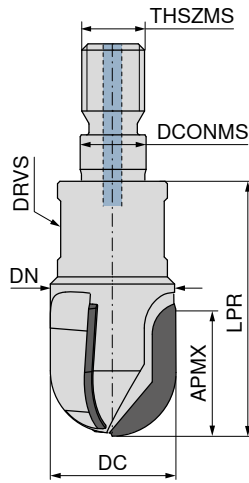
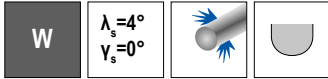

50 017 ...

DC mm	APMX mm	DN mm	LPR mm	DCONMS mm	DRVS mm	ZEFP	THSZMS	KOMET no.	
10	10	9,6	28	5,5	8	2	M5	37340098001000	01000
12	12	9,6	28	5,5	8	2	M5	37340098001200	01200
16	16	13,8	32	8,5	13	3	M8	37340098001600	01600

P	
M	
K	
N	●
S	
H	
O	●

→ v_c/f_z Page 412+413

PCD face mill

The tool with the highest cutting parameters and longest service lives for machining non-ferrous metals and plastics

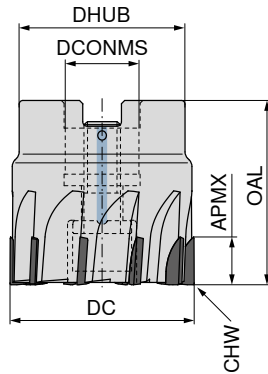
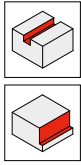
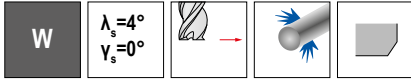

50 019 ...

DC mm	OAL mm	DHUB mm	APMX mm	DCONMS _{H6} mm	CHW mm	ZNF	KOMET no.	
40	40	36	10	16	0,2	10	37155099004000	04000
50	40	41	10	22	0,2	12	37155099005000	05000
63	40	48	10	22	0,2	14	37155099006300	06300
80	50	60	10	27	0,2	16	37155099008000	08000
100	50	78	10	32	0,2	18	37155099010000	10000
125	63	100	10	40	0,2	22	37155099012500	12500

P	
M	
K	
N	●
S	
H	
O	●

→ v_c/f_z Page 412

Spare parts can be found in our online shop at cuttingtools.ceratizit.com.

SilverLine – End milling cutter

The all-rounder for universal application

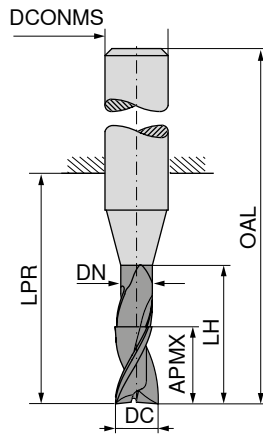
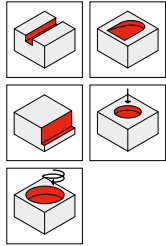
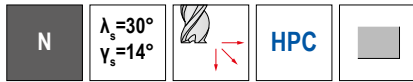

≈DIN 6527



50 558 ...

DC _{e8} mm	APMX mm	DN mm	LH mm	LPR mm	OAL mm	DCONMS _{n6} mm	ZEFP	
3,0	8	2,8	15	21	57	6	2	03200
3,5	11	3,3	15	21	57	6	2	03700
4,0	11	3,8	15	21	57	6	2	04200
4,5	13	4,3	21	21	57	6	2	04700
5,0	13	4,8	21	21	57	6	2	05200
5,5	13	5,3	21	21	57	6	2	05700
6,0	13	5,8	21	21	57	6	2	06200
7,0	16	6,8	27	27	63	8	2	07200
8,0	19	7,8	27	27	63	8	2	08200
9,0	19	8,8	32	32	72	10	2	09200
10,0	22	9,8	32	32	72	10	2	10200
11,0	26	10,8	38	38	83	12	2	11200
12,0	26	11,8	38	38	83	12	2	12200
14,0	26	13,8	38	38	83	14	2	14200
15,0	32	14,7	44	44	92	16	2	15200
16,0	32	15,7	44	44	92	16	2	16200
17,0	32	16,7	44	44	92	18	2	17200
18,0	32	17,7	44	44	92	18	2	18200
19,0	38	18,7	54	54	104	20	2	19200
20,0	38	19,7	54	54	104	20	2	20200

P	●
M	●
K	●
N	○
S	●
H	
O	

→ v_c/f_z Page 384+385

SilverLine – End milling cutter

The all-rounder for universal application

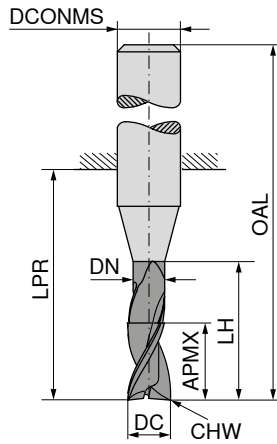
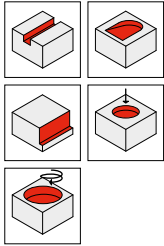

≈DIN 6527



50 958 ...

DC _{e8} mm	APMX mm	DN mm	LH mm	LPR mm	OAL mm	DCONMS _{n6} mm	CHW mm	ZEFP	
3,0	8	2,8	15	21	57	6	0,1	2	03200
3,5	11	3,3	15	21	57	6	0,1	2	03700
4,0	11	3,8	15	21	57	6	0,1	2	04200
4,5	13	4,3	21	21	57	6	0,1	2	04700
5,0	13	4,8	21	21	57	6	0,1	2	05200
5,5	13	5,3	21	21	57	6	0,1	2	05700
6,0	13	5,8	21	21	57	6	0,1	2	06200
7,0	16	6,8	27	27	63	8	0,1	2	07200
8,0	19	7,8	27	27	63	8	0,1	2	08200
9,0	19	8,8	32	32	72	10	0,1	2	09200
10,0	22	9,8	32	32	72	10	0,1	2	10200
11,0	26	10,8	38	38	83	12	0,1	2	11200
12,0	26	11,8	38	38	83	12	0,1	2	12200
14,0	26	13,8	38	38	83	14	0,1	2	14200
15,0	32	14,7	44	44	92	16	0,1	2	15200
16,0	32	15,7	44	44	92	16	0,1	2	16200
17,0	32	16,7	44	44	92	18	0,1	2	17200
18,0	32	17,7	44	44	92	18	0,1	2	18200
19,0	38	18,7	54	54	104	20	0,1	2	19200
20,0	38	19,7	54	54	104	20	0,1	2	20200

P	●
M	●
K	●
N	○
S	●
H	
O	

→ v_c/f_z Page 384+385

SilverLine – End milling cutter

The all-rounder for universal application

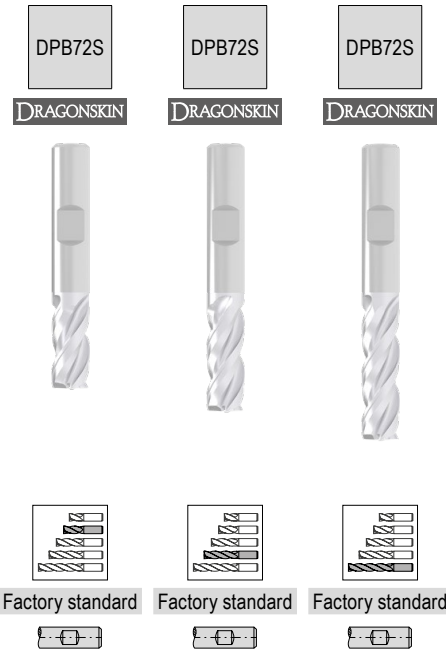
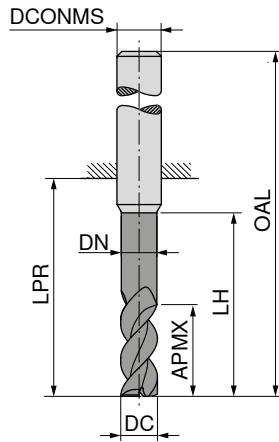
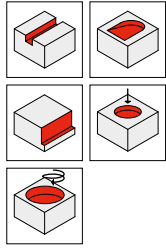
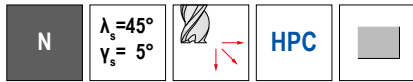

DC ₁₈	APMX	DN	LH	LPR	OAL	DCONMS _{n6}	ZEFP
mm	mm	mm	mm	mm	mm	mm	
3,0	8	2,9	15	21	57	6	3
3,5	11	3,4	16	21	57	6	3
4,0	8	3,9	15	18	54	6	3
4,0	11	3,9	16	21	57	6	3
4,0	16			26	62	6	3
4,5	13	4,4	19	21	57	6	3
5,0	9	4,9	16	18	54	6	3
5,0	13	4,9	19	21	57	6	3
5,0	17			26	62	6	3
5,5	13	5,4	19	21	57	6	3
6,0	10	5,9	17	18	54	6	3
6,0	13	5,9	19	21	57	6	3
6,0	18			26	62	6	3
6,5	19	6,3	25	27	63	8	3
7,0	19	6,8	25	27	63	8	3
7,5	19	7,3	25	27	63	8	3
8,0	12		20	22	58	8	3
8,0	19	7,8	25	27	63	8	3
8,0	24			32	68	8	3
8,5	22	8,2	30	32	72	10	3
9,0	22	8,7	30	32	72	10	3
9,5	22	9,2	30	32	72	10	3
10,0	14	9,7	24	26	66	10	3
10,0	22	9,7	30	32	72	10	3
10,0	30			40	80	10	3
12,0	16	11,7	26	28	73	12	3
12,0	26	11,7	36	38	83	12	3
12,0	36			48	93	12	3
14,0	18	13,7	28	30	75	14	3
14,0	26	13,7	36	38	83	14	3
14,0	42			54	99	14	3
16,0	22	15,5	32	34	82	16	3
16,0	32	15,5	42	44	92	16	3
16,0	48			60	108	16	3
18,0	24	17,5	34	36	84	18	3
18,0	32	17,5	42	44	92	18	3
18,0	54			66	114	18	3
20,0	26	19,5	40	42	92	20	3
20,0	38	19,5	52	54	104	20	3
20,0	60			76	126	20	3

50 992 ...	50 992 ...	50 992 ...
	03200	
	03700	
04100	04200	
	04700	04400
05100	05200	
	05700	05400
06100	06200	
	06700	06400
	07200	
	07700	
08100	08200	
	08700	08400
	09200	
	09700	
10100	10200	
	10700	10400
12100	12200	
	12700	12400
14100	14200	
	14700	14400
16100	16200	
	16700	16400
18100	18200	
	18700	18400
20100	20200	
	20700	20400

P	●	●	●
M	●	●	●
K	●	●	●
N	○	○	○
S	●	●	●
H			
O			

→ v_c/f_z Page 386+387

SilverLine – End milling cutter

The all-rounder for universal application

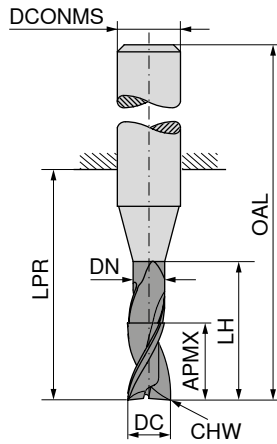
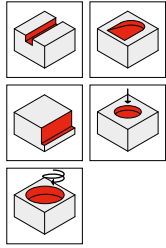
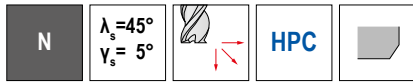

DC ₁₈	APMX	DN	LH	LPR	OAL	DCONMS _{n6}	CHW	ZEFP
mm	mm	mm	mm	mm	mm	mm	mm	
3,0	8	2,9	15	21	57	6	0,1	3
3,5	11	3,4	16	21	57	6	0,1	3
4,0	8	3,9	15	18	54	6	0,1	3
4,0	11	3,9	16	21	57	6	0,1	3
4,0	16			26	62	6	0,1	3
4,5	13	4,4	19	21	57	6	0,1	3
5,0	9	4,9	16	18	54	6	0,1	3
5,0	13	4,9	19	21	57	6	0,1	3
5,0	17			26	62	6	0,1	3
5,5	13	5,4	19	21	57	6	0,1	3
6,0	10	5,9	17	18	54	6	0,2	3
6,0	13	5,9	19	21	57	6	0,2	3
6,0	18			26	62	6	0,2	3
6,5	19	6,3	25	27	63	8	0,2	3
7,0	19	6,8	25	27	63	8	0,2	3
7,5	19	7,3	25	27	63	8	0,2	3
8,0	12	7,8	20	22	58	8	0,2	3
8,0	19	7,8	25	27	63	8	0,2	3
8,0	24			32	68	8	0,2	3
8,5	22	8,2	30	32	72	10	0,2	3
9,0	22	8,7	30	32	72	10	0,2	3
9,5	22	9,2	30	32	72	10	0,2	3
10,0	14	9,7	24	26	66	10	0,2	3
10,0	22	9,7	30	32	72	10	0,2	3
10,0	30			40	80	10	0,2	3
12,0	16	11,7	26	28	73	12	0,2	3
12,0	26	11,7	36	38	83	12	0,2	3
12,0	36			48	93	12	0,2	3
14,0	18	13,7	28	30	75	14	0,2	3
14,0	26	13,7	36	38	83	14	0,2	3
14,0	42			54	99	14	0,2	3
16,0	22	15,5	32	34	82	16	0,2	3
16,0	32	15,5	42	44	92	16	0,2	3
16,0	48			60	108	16	0,2	3
18,0	24	17,5	34	36	84	18	0,2	3
18,0	32	17,5	42	44	92	18	0,2	3
18,0	54			66	114	18	0,2	3
20,0	26	19,5	40	42	92	20	0,2	3
20,0	38	19,5	52	54	104	20	0,2	3
20,0	60			76	126	20	0,2	3

50 966 ...	50 966 ...	50 966 ...
	03200	
	03700	
04100		
	04200	
		04400
	04700	
05100		
	05200	
		05400
	05700	
06100		
	06200	
		06400
	06700	
	07200	
	07700	
08100		
	08200	
		08400
	08700	
	09200	
	09700	
10100		
	10200	
		10400
12100		
	12200	
		12400
14100		
	14200	
		14400
16100		
	16200	
		16400
18100		
	18200	
		18400
20100		
	20200	
		20400

P	●	●	●
M	●	●	●
K	●	●	●
N	○	○	○
S	●	●	●
H			
O			

SilverLine – End milling cutter with corner radius

The all-rounder for universal application

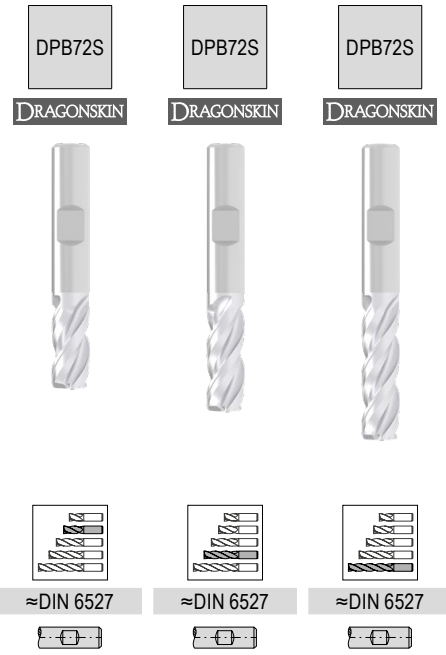
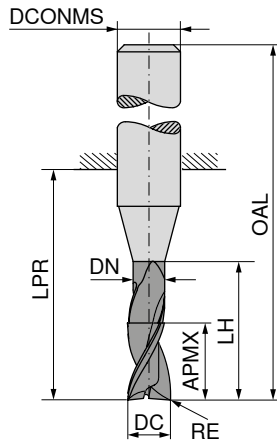
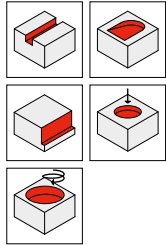
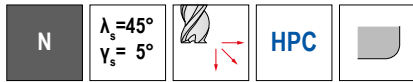

DC ₁₈ mm	RE _{±0.05} mm	APMX mm	DN mm	LH mm	LPR mm	OAL mm	DCONMS _{h6} mm	ZEFP
4,0	0,5	8	3,9	15	18	54	6	3
4,0	0,5	11	3,9	16	21	57	6	3
4,0	0,5	16			26	62	6	3
5,0	0,5	9	4,9	16	18	54	6	3
5,0	0,5	13	4,9	19	21	57	6	3
5,0	0,5	17			26	62	6	3
6,0	0,5	10	5,9	17	18	54	6	3
6,0	0,5	13	5,9	19	21	57	6	3
6,0	0,5	18			26	62	6	3
8,0	1,0	12	7,8	20	22	58	8	3
8,0	1,0	19	7,8	25	27	63	8	3
8,0	1,0	24			32	68	8	3
10,0	1,0	14	9,7	24	26	66	10	3
10,0	1,0	22	9,7	30	32	72	10	3
10,0	1,0	30			40	80	10	3
12,0	1,5	16	11,7	26	28	73	12	3
12,0	1,5	26	11,7	36	38	83	12	3
12,0	1,5	36			48	93	12	3
16,0	2,0	22	15,5	32	34	82	16	3
16,0	2,0	32	15,5	42	44	92	16	3
16,0	2,0	48			60	108	16	3
20,0	2,0	26	19,5	40	42	92	20	3
20,0	2,0	38	19,5	52	54	104	20	3
20,0	2,0	60			76	126	20	3

50 967 ...	50 967 ...	50 967 ...
04105		
	04205	
		04405
05105		
	05205	
		05405
06105		
	06205	
		06405
08110		
	08210	
		08410
10110		
	10210	
		10410
12115		
	12215	
		12415
16120		
	16220	
		16420
20120		
	20220	
		20420

P	●	●	●
M	●	●	●
K	●	●	●
N	○	○	○
S	●	●	●
H			
O			

→ v_c/f_z Page 386+387

SilverLine – End milling cutter

The all-rounder for universal application

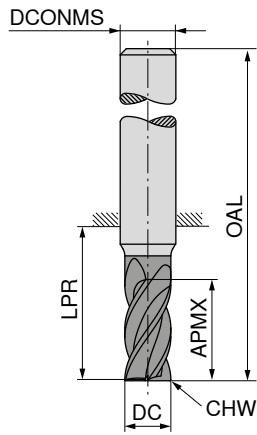
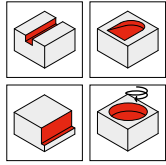
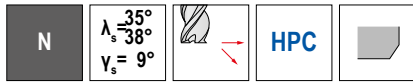

DC ₁₈ mm	APMX mm	LPR mm	OAL mm	DCONMS ₁₆ mm	CHW mm	ZEP	50 972 ...	50 973 ...	50 972 ...	50 973 ...
3,0	5	14	50	6	0,1	4				
3,0	8	21	57	6	0,1	4	03100	03100		
3,5	8	18	54	6	0,1	4	03600	03600	03200	03200
3,5	11	21	57	6	0,1	4			03700	03700
4,0	8	18	54	6	0,1	4	04100	04100		
4,0	11	21	57	6	0,1	4			04200	04200
4,5	9	18	54	6	0,1	4	04600	04600		
4,5	13	21	57	6	0,1	4			04700	04700
5,0	9	18	54	6	0,1	4	05100	05100		
5,0	13	21	57	6	0,1	4			05200	05200
5,5	10	18	54	6	0,1	4	05600	05600		
5,5	13	21	57	6	0,1	4			05700	05700
6,0	10	18	54	6	0,1	4	06100	06100		
6,0	13	21	57	6	0,1	4			06200	06200
7,0	12	22	58	8	0,2	4	07100	07100		
7,0	21	27	63	8	0,2	4			07200	07200
8,0	12	22	58	8	0,2	4	08100	08100		
8,0	21	27	63	8	0,2	4			08200	08200
9,0	14	26	66	10	0,2	4	09100	09100		
9,0	22	32	72	10	0,2	4			09200	09200
10,0	14	26	66	10	0,2	4	10100	10100		
10,0	22	32	72	10	0,2	4			10200	10200
11,0	16	28	73	12	0,3	4	11100	11100		
11,0	26	38	83	12	0,3	4			11200	11200
12,0	16	28	73	12	0,3	4	12100	12100		
12,0	26	38	83	12	0,3	4			12200	12200
14,0	16	28	73	14	0,3	4	14100	14100		
14,0	26	38	83	14	0,3	4			14200	14200
15,0	22	34	82	16	0,3	4	15100	15100		
15,0	36	44	92	16	0,3	4			15200	15200
16,0	22	34	82	16	0,3	4	16100	16100		
16,0	36	44	92	16	0,3	4			16200	16200
17,0	22	34	82	18	0,3	4	17100	17100		
17,0	36	44	92	18	0,3	4			17200	17200
18,0	22	34	82	18	0,3	4	18100	18100		
18,0	36	44	92	18	0,3	4			18200	18200
19,0	26	42	92	20	0,3	4	19100	19100		
19,0	41	54	104	20	0,3	4			19200	19200
20,0	26	42	92	20	0,3	4	20100	20100		
20,0	41	54	104	20	0,3	4			20200	20200

P	●	●	●	●
M	●	●	●	●
K	●	●	●	●
N	○	○	○	○
S	●	●	●	●
H				
O				

SilverLine – End milling cutter

The all-rounder for universal application

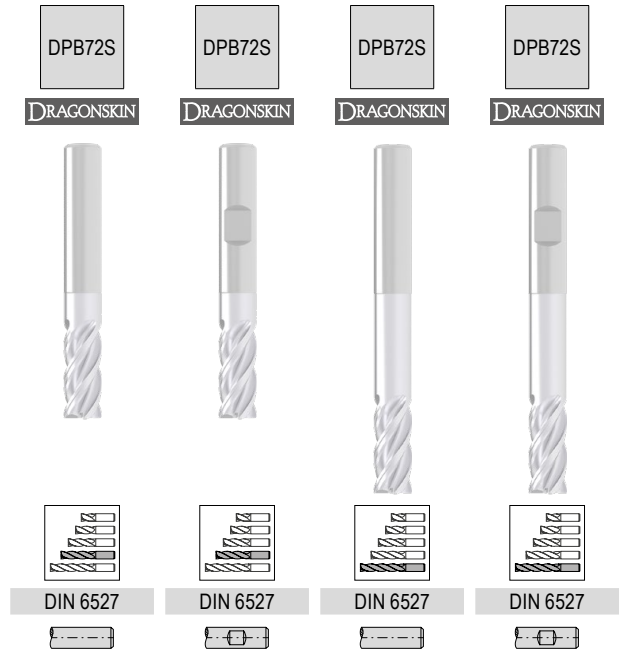
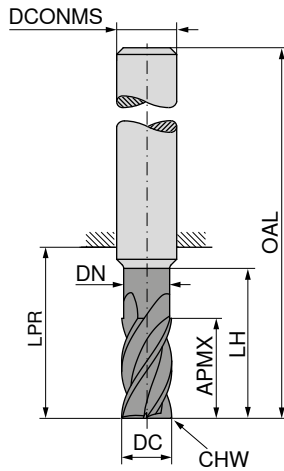
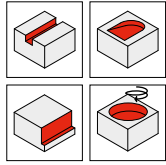
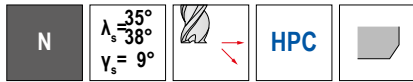

	50 974 ...	50 975 ...	50 974 ...	50 975 ...
	03200	03200	03400	03400
	04200	04200	04400	04400
	05200	05200	05400	05400
	06200	06200	06400	06400
	08200	08200	08400	08400
	10200	10200	10400	10400
	12200	12200	12400	12400
	14200	14200	14400	14400
	16200	16200	16400	16400
	18200	18200	18400	18400
	20200	20200	20400	20400

DC ₁₈	APMX	DN	LH	LPR	OAL	DCONMS _{n6}	CHW	ZEFP
mm	mm	mm	mm	mm	mm	mm	mm	
3,0	6,5	2,8	9	19	55	6	0,1	4
3,0	6,5	2,8	15	22	58	6	0,1	4
4,0	8,5	3,8	12	19	55	6	0,1	4
4,0	8,5	3,8	20	26	62	6	0,1	4
5,0	10,5	4,8	15	22	58	6	0,1	4
5,0	10,5	4,8	25	34	70	6	0,1	4
6,0	13,0	5,8	18	22	58	6	0,1	4
6,0	13,0	5,8	30	34	70	6	0,1	4
8,0	17,0	7,7	24	28	64	8	0,2	4
8,0	17,0	7,7	40	44	80	8	0,2	4
10,0	21,0	9,7	30	34	74	10	0,2	4
10,0	21,0	9,7	50	54	94	10	0,2	4
12,0	25,0	11,6	36	40	85	12	0,3	4
12,0	25,0	11,6	60	64	109	12	0,3	4
14,0	29,0	13,6	42	46	91	14	0,3	4
14,0	29,0	13,6	74	74	119	14	0,3	4
16,0	33,0	15,5	48	52	100	16	0,3	4
16,0	33,0	15,5	80	84	132	16	0,3	4
18,0	38,0	17,5	54	58	106	18	0,3	4
18,0	38,0	17,5	90	94	142	18	0,3	4
20,0	42,0	19,5	60	64	114	20	0,3	4
20,0	42,0	19,5	100	104	154	20	0,3	4

P	●	●	●	●
M	●	●	●	●
K	●	●	●	●
N	○	○	○	○
S	●	●	●	●
H				
O				

→ v_c/f_z Page 392–391

SilverLine – End milling cutter

The all-rounder for universal application

▲ Especially for high-volume milling

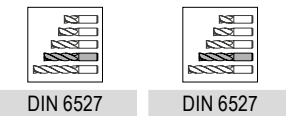
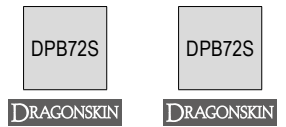
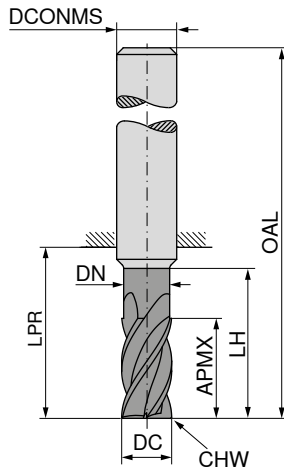
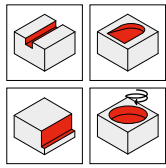
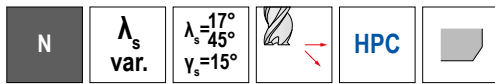

50 976 ... 50 977 ...

DC ₁₈ mm	APMX mm	DN mm	LH mm	LPR mm	OAL mm	DCONMS ₁₆ mm	CHW mm	ZEFP	50 976 ...	50 977 ...
3,0	8	2,8	13	21	57	6	0,1	4	03200	03200
4,0	11	3,8	17	21	57	6	0,1	4	04200	04200
5,0	13	4,8	19	21	57	6	0,1	4	05200	05200
6,0	13	5,8	19	21	57	6	0,1	4	06200	06200
8,0	21	7,7	25	27	63	8	0,2	4	08200	08200
10,0	22	9,7	30	32	72	10	0,2	4	10200	10200
12,0	26	11,6	36	38	83	12	0,3	4	12200	12200
14,0	26	13,6	36	38	83	14	0,3	4	14200	14200
16,0	36	15,5	42	44	92	16	0,3	4	16200	16200
18,0	36	17,5	42	44	92	18	0,3	4	18200	18200
20,0	41	19,5	52	54	104	20	0,3	4	20200	20200

P	●	●
M	●	●
K	●	●
N	○	○
S		
H		
O		

→ v_c/f_z Page 388+389

SilverLine – End milling cutter

The all-rounder for universal application

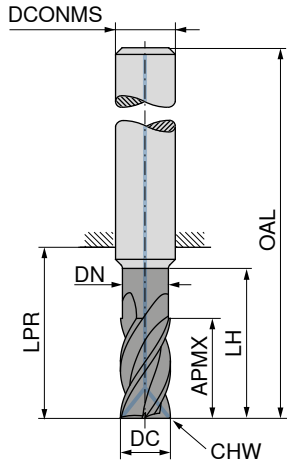
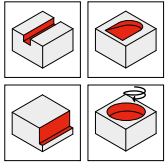
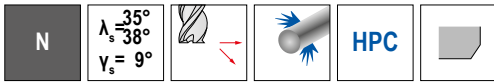

DPB72S
DRAGONSKIN



DIN 6527



50 978 ...

DC ₁₈ mm	APMX mm	DN mm	LH mm	LPR mm	OAL mm	DCONMS _{n6} mm	CHW mm	ZEFP	
6,0	13	5,8	19	21	57	6	0,1	4	06200
8,0	21	7,7	25	27	63	8	0,2	4	08200
10,0	22	9,7	30	32	72	10	0,2	4	10200
12,0	26	11,6	36	38	83	12	0,3	4	12200
14,0	26	13,6	36	38	83	14	0,3	4	14200
16,0	36	15,5	42	44	92	16	0,3	4	16200
18,0	36	17,5	42	44	92	18	0,3	4	18200
20,0	41	19,5	52	54	104	20	0,3	4	20200

P	●
M	●
K	●
N	○
S	●
H	
O	

→ v_c/f_z Page 392+393

SilverLine – End milling cutter with corner radius

The all-rounder for universal application

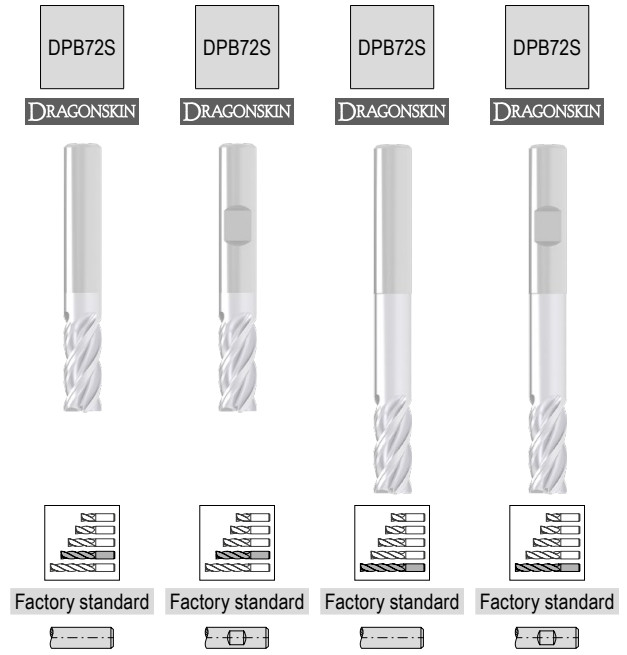
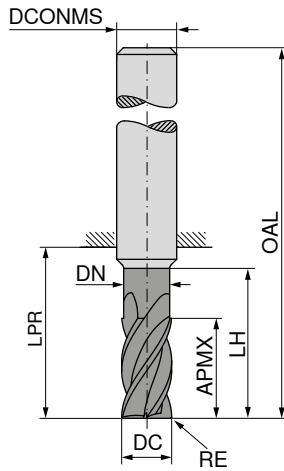
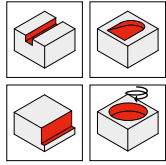
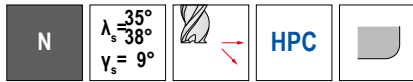

DC _{R8}	RE _{±0.05}	APMX	DN	LH	LPR	OAL	DCONMS _{h6}	ZEFP
mm	mm	mm	mm	mm	mm	mm	mm	
3,0	0,10	8,0	2,8	13	21	57	6	4
3,0	0,40	8,0	2,8	13	21	57	6	4
3,0	0,50	8,0	2,8	13	21	57	6	4
3,0	1,00	8,0	2,8	13	21	57	6	4
3,0	0,30	6,5	2,8	15	22	58	6	4
3,0	0,50	6,5	2,8	15	22	58	6	4
3,0	0,80	6,5	2,8	15	22	58	6	4
4,0	0,10	11,0	3,8	17	21	57	6	4
4,0	0,40	11,0	3,8	17	21	57	6	4
4,0	0,50	11,0	3,8	17	21	57	6	4
4,0	1,00	11,0	3,8	17	21	57	6	4
4,0	0,40	8,5	3,8	20	26	62	6	4
4,0	0,50	8,5	3,8	20	26	62	6	4
4,0	0,80	8,5	3,8	20	26	62	6	4
5,0	0,10	13,0	4,8	19	21	57	6	4
5,0	0,50	13,0	4,8	19	21	57	6	4
5,0	1,00	13,0	4,8	19	21	57	6	4
5,0	0,50	10,5	4,8	25	34	70	6	4
5,0	0,80	10,5	4,8	25	34	70	6	4
6,0	0,10	13,0	5,8	19	21	57	6	4
6,0	0,50	13,0	5,8	19	21	57	6	4
6,0	1,00	13,0	5,8	19	21	57	6	4
6,0	1,50	13,0	5,8	19	21	57	6	4
6,0	0,60	13,0	5,8	30	34	70	6	4
6,0	0,80	13,0	5,8	30	34	70	6	4
6,0	1,00	13,0	5,8	30	34	70	6	4
8,0	0,15	21,0	7,7	25	27	63	8	4
8,0	0,50	21,0	7,7	25	27	63	8	4
8,0	1,00	21,0	7,7	25	27	63	8	4
8,0	1,50	21,0	7,7	25	27	63	8	4
8,0	2,00	21,0	7,7	25	27	63	8	4
8,0	0,80	17,0	7,7	40	44	80	8	4
8,0	1,00	17,0	7,7	40	44	80	8	4
8,0	1,50	17,0	7,7	40	44	80	8	4
8,0	2,00	17,0	7,7	40	44	80	8	4
10,0	0,15	22,0	9,7	30	32	72	10	4
10,0	0,50	22,0	9,7	30	32	72	10	4
10,0	1,00	22,0	9,7	30	32	72	10	4
10,0	1,50	22,0	9,7	30	32	72	10	4
10,0	2,00	22,0	9,7	30	32	72	10	4
10,0	0,50	21,0	9,7	50	54	94	10	4
10,0	1,00	21,0	9,7	50	54	94	10	4
10,0	1,50	21,0	9,7	50	54	94	10	4
10,0	2,00	21,0	9,7	50	54	94	10	4
12,0	0,20	26,0	11,6	36	38	83	12	4
12,0	0,50	26,0	11,6	36	38	83	12	4
12,0	1,00	26,0	11,6	36	38	83	12	4

50 970 ...	50 971 ...	50 970 ...	50 971 ...
03201	03201		
03204	03204		
03205	03205		
03210	03210		
		03403	03403
		03405	03405
		03408	03408
04201	04201		
04204	04204		
04205	04205		
04210	04210		
		04404	04404
		04405	04405
		04408	04408
05201	05201		
05205	05205		
05210	05210		
		05405	05405
		05408	05408
06201	06201		
06205	06205		
06210	06210		
06215	06215		
		06406	06406
		06408	06408
		06410	06410
08202	08202		
08205	08205		
08210	08210		
08215	08215		
08220	08220		
		08408	08408
		08410	08410
		08415	08415
		08420	08420
10202	10202		
10205	10205		
10210	10210		
10215	10215		
10220	10220		
		10405	10405
		10410	10410
		10415	10415
		10420	10420
12202	12202		
12205	12205		
12210	12210		

P	●	●	●	●
M	●	●	●	●
K	●	●	●	●
N	○	○	○	○
S	●	●	●	●
H				
O				

SilverLine – End milling cutter with corner radius

The all-rounder for universal application

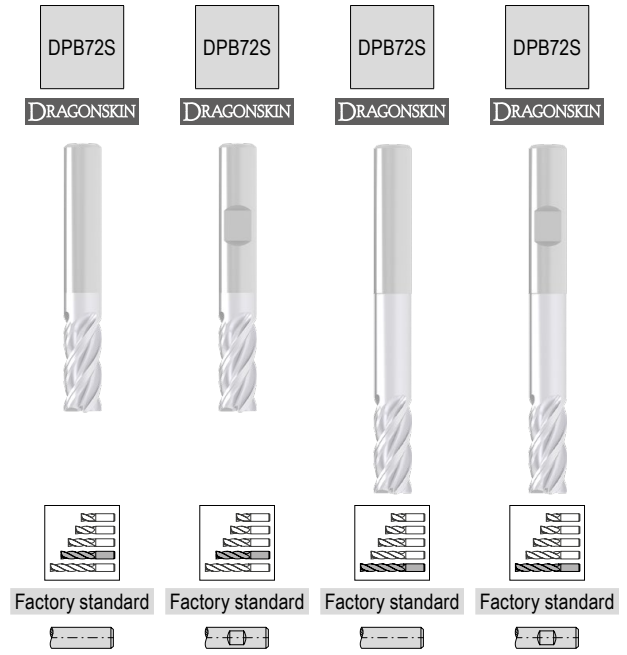
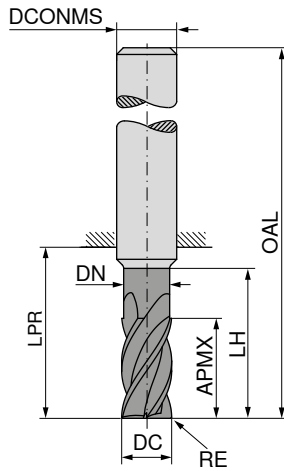
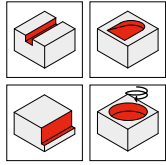
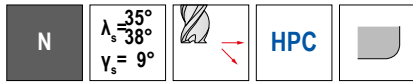

DC ₁₈	RE _{±0.05}	APMX	DN	LH	LPR	OAL	DCONMS _{h6}	ZEFP	50 970 ...	50 971 ...	50 970 ...	50 971 ...
mm	mm	mm	mm	mm	mm	mm	mm					
12,0	1,50	26,0	11,6	36	38	83	12	4	12215	12215		
12,0	2,00	26,0	11,6	36	38	83	12	4	12220	12220		
12,0	3,00	26,0	11,6	36	38	83	12	4	12230	12230		
12,0	4,00	26,0	11,6	36	38	83	12	4	12240	12240		
12,0	0,50	25,0	11,6	60	64	109	12	4			12405	12405
12,0	1,00	25,0	11,6	60	64	109	12	4			12410	12410
12,0	1,50	25,0	11,6	60	64	109	12	4			12415	12415
12,0	2,00	25,0	11,6	60	64	109	12	4			12420	12420
12,0	3,00	25,0	11,6	60	64	109	12	4			12430	12430
12,0	4,00	25,0	11,6	60	64	109	12	4			12440	12440
14,0	0,30	26,0	13,6	36	38	83	14	4	14203	14203		
14,0	1,00	26,0	13,6	36	38	83	14	4	14210	14210		
14,0	2,00	26,0	13,6	36	38	83	14	4	14220	14220		
14,0	3,00	26,0	13,6	36	38	83	14	4	14230	14230		
14,0	4,00	26,0	13,6	36	38	83	14	4	14240	14240		
14,0	1,00	29,0	13,6	70	74	119	14	4			14410	14410
14,0	2,00	29,0	13,6	70	74	119	14	4			14420	14420
14,0	3,00	29,0	13,6	70	74	119	14	4			14430	14430
14,0	4,00	29,0	13,6	70	74	119	14	4			14440	14440
16,0	0,30	36,0	15,5	42	44	92	16	4	16203	16203		
16,0	1,00	36,0	15,5	42	44	92	16	4	16210	16210		
16,0	2,00	36,0	15,5	42	44	92	16	4	16220	16220		
16,0	3,00	36,0	15,5	42	44	92	16	4	16230	16230		
16,0	4,00	36,0	15,5	42	44	92	16	4	16240	16240		
16,0	1,00	33,0	15,5	80	84	132	16	4			16410	16410
16,0	2,00	33,0	15,5	80	84	132	16	4			16420	16420
16,0	3,00	33,0	15,5	80	84	132	16	4			16430	16430
16,0	4,00	33,0	15,5	80	84	132	16	4			16440	16440
18,0	1,00	36,0	17,5	42	44	92	18	4	18210	18210		
18,0	2,00	36,0	17,5	42	44	92	18	4	18220	18220		
18,0	3,00	36,0	17,5	42	44	92	18	4	18230	18230		
18,0	4,00	36,0	17,5	42	44	92	18	4	18240	18240		
18,0	1,00	38,0	17,5	90	94	142	18	4			18410	18410
18,0	2,00	38,0	17,5	90	94	142	18	4			18420	18420
18,0	3,00	38,0	17,5	90	94	142	18	4			18430	18430
18,0	4,00	38,0	17,5	90	94	142	18	4			18440	18440
20,0	0,30	41,0	19,5	52	54	104	20	4	20203	20203		
20,0	1,00	41,0	19,5	52	54	104	20	4	20210	20210		
20,0	2,00	41,0	19,5	52	54	104	20	4	20220	20220		
20,0	3,00	41,0	19,5	52	54	104	20	4	20230	20230		
20,0	4,00	41,0	19,5	52	54	104	20	4	20240	20240		
20,0	1,00	42,0	19,5	100	104	154	20	4			20410	20410
20,0	2,00	42,0	19,5	100	104	154	20	4			20420	20420
20,0	3,00	42,0	19,5	100	104	154	20	4			20430	20430
20,0	4,00	42,0	19,5	100	104	154	20	4			20440	20440

P	●	●	●	●
M	●	●	●	●
K	●	●	●	●
N	○	○	○	○
S	●	●	●	●
H				
O				

→ v_c/f_z Page 392+393

SilverLine – End milling cutter

The all-rounder for universal application

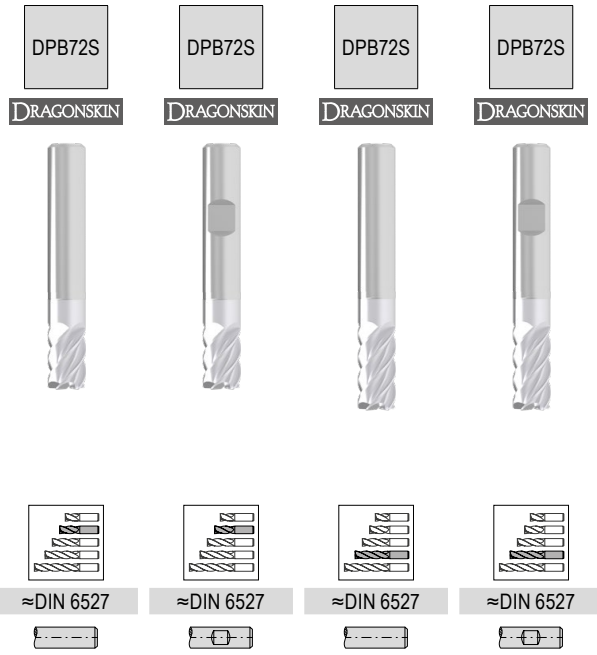
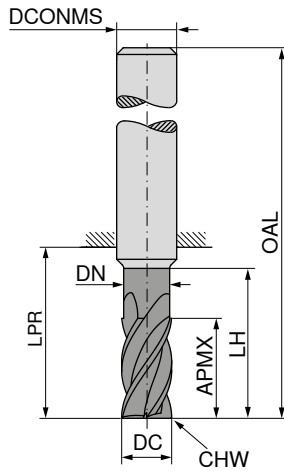
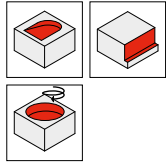
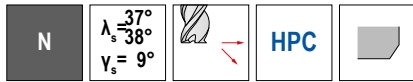

50 993 ... 50 995 ... 50 994 ... 50 996 ...

DC _{e8} mm	APMX mm	DN mm	LH mm	LPR mm	OAL mm	DCONMS _{n6} mm	CHW mm	ZEFP	50 993 ...	50 995 ...	50 994 ...	50 996 ...
6	10			18	54	6	0,1	5	06100	06100		
6	13	5,8	19	21	57	6	0,1	5			06200	06200
8	12			22	58	8	0,2	5	08100	08100		
8	21	7,7	25	27	63	8	0,2	5			08200	08200
10	14			26	66	10	0,2	5	10100	10100		
10	22	9,7	30	32	72	10	0,2	5			10200	10200
12	16			28	73	12	0,3	5	12100	12100		
12	26	11,6	36	38	83	12	0,3	5			12200	12200
16	22			34	82	16	0,3	5	16100	16100		
16	36	15,5	42	44	92	16	0,3	5			16200	16200
20	26			42	92	20	0,3	5	20100	20100		
20	41	19,5	52	54	104	20	0,3	5			20200	20200

P	●	●	●	●
M	●	●	●	●
K	●	●	●	●
N	○	○	○	○
S	●	●	●	●
H				
O				

→ v_c/f_z Page 380

SilverLine – End milling cutter

The all-rounder for universal application

▲ Cutting depth: 3 x DC

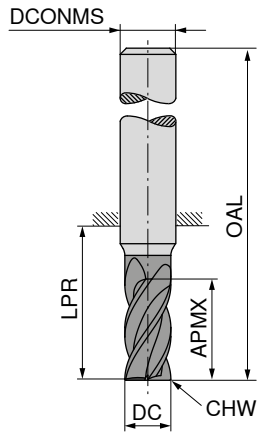
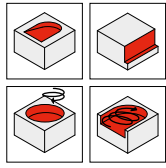
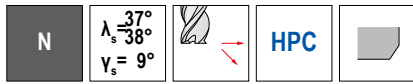

DC _{e8} mm	APMX mm	LPR mm	OAL mm	DCONMS _{H6} mm	CHW mm	ZEFP
6	19	26	62	6	0,1	5
8	25	32	68	8	0,2	5
10	31	40	80	10	0,2	5
12	37	48	93	12	0,3	5
16	49	60	108	16	0,3	5
20	61	76	126	20	0,3	5

50 999 ...	50 949 ...
06200	06200
08200	08200
10200	10200
12200	12200
16200	16200
20200	20200

P	●	●
M	●	●
K	●	●
N	○	○
S	●	●
H		
O		

→ v_c/f_z Page 381–383

SilverLine – End milling cutter with corner radius

The all-rounder for universal application

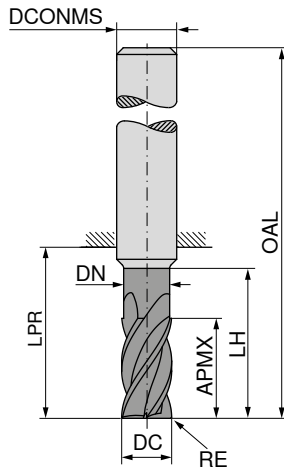
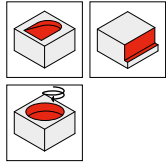
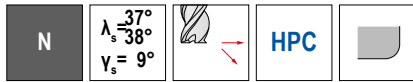

DC _{e8} mm	RE _{±0.05} mm	APMX mm	DN mm	LH mm	LPR mm	OAL mm	DCONMS _{h6} mm	ZEFP
6	0,2	13	5,8	19	21	57	6	5
6	0,5	13	5,8	19	21	57	6	5
6	1,0	13	5,8	19	21	57	6	5
8	0,2	21	7,7	25	27	63	8	5
8	0,5	21	7,7	25	27	63	8	5
8	1,0	21	7,7	25	27	63	8	5
8	1,5	21	7,7	25	27	63	8	5
10	0,2	22	9,7	30	32	72	10	5
10	0,5	22	9,7	30	32	72	10	5
10	1,0	22	9,7	30	32	72	10	5
10	1,5	22	9,7	30	32	72	10	5
10	1,6	22	9,7	30	32	72	10	5
10	2,0	22	9,7	30	32	72	10	5
12	0,3	26	11,6	36	38	83	12	5
12	0,5	26	11,6	36	38	83	12	5
12	1,0	26	11,6	36	38	83	12	5
12	1,5	26	11,6	36	38	83	12	5
12	1,6	26	11,6	36	38	83	12	5
12	2,0	26	11,6	36	38	83	12	5
12	2,5	26	11,6	36	38	83	12	5
16	0,3	36	15,5	42	44	92	16	5
16	0,5	36	15,5	42	44	92	16	5
16	1,0	36	15,5	42	44	92	16	5
16	1,5	36	15,5	42	44	92	16	5
16	1,6	36	15,5	42	44	92	16	5
16	2,0	36	15,5	42	44	92	16	5
16	2,5	36	15,5	42	44	92	16	5
16	3,0	36	15,5	42	44	92	16	5
20	0,3	41	19,5	52	54	104	20	5
20	0,5	41	19,5	52	54	104	20	5
20	1,0	41	19,5	52	54	104	20	5
20	1,5	41	19,5	52	54	104	20	5
20	1,6	41	19,5	52	54	104	20	5
20	2,0	41	19,5	52	54	104	20	5
20	2,5	41	19,5	52	54	104	20	5
20	3,0	41	19,5	52	54	104	20	5
20	4,0	41	19,5	52	54	104	20	5

P	●	●
M	●	●
K	●	●
N	○	○
S	●	●
H		
O		

50 997 ...	50 998 ...
06202	06202
06205	06205
06210	06210
08202	08202
08205	08205
08210	08210
08215	08215
10202	10202
10205	10205
10210	10210
10215	10215
10216	10216
10220	10220
12203	12203
12205	12205
12210	12210
12215	12215
12216	12216
12220	12220
12225	12225
16203	16203
16205	16205
16210	16210
16215	16215
16216	16216
16220	16220
16225	16225
16230	16230
20203	20203
20205	20205
20210	20210
20215	20215
20216	20216
20220	20220
20225	20225
20230	20230
20240	20240

SilverLine – Roughing-Finishing Cutter

The all-rounder for universal application

▲ With rough-finishing profile

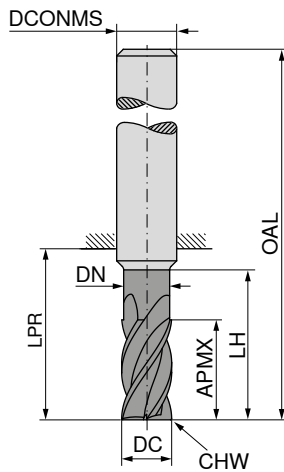
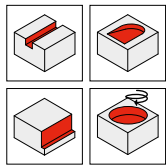
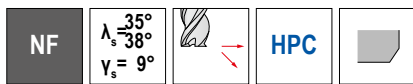

DPB72S
DRAGONSKIN



DIN 6527



50 969 ...

DC ₁₈ mm	APMX mm	DN mm	LH mm	LPR mm	OAL mm	DCONMS ₁₆ mm	CHW mm	ZEFP	
3,0	8	2,8	13	21	57	6	0,1	4	03200
3,5	11	3,3	17	21	57	6	0,1	4	03700
4,0	11	3,8	17	21	57	6	0,1	4	04200
4,5	13	4,3	19	21	57	6	0,1	4	04700
5,0	13	4,8	19	21	57	6	0,1	4	05200
5,5	13	5,3	19	21	57	6	0,1	4	05700
6,0	13	5,8	19	21	57	6	0,1	4	06200
7,0	21	6,7	25	27	63	8	0,2	4	07200
8,0	21	7,7	25	27	63	8	0,2	4	08200
9,0	22	8,7	30	32	72	10	0,2	4	09200
10,0	22	9,7	30	32	72	10	0,2	4	10200
11,0	26	10,6	36	38	83	12	0,3	4	11200
12,0	26	11,6	36	38	83	12	0,3	4	12200
14,0	26	13,6	36	38	83	14	0,3	4	14200
15,0	36	14,5	42	44	92	16	0,3	4	15200
16,0	36	15,5	42	44	92	16	0,3	4	16200
17,0	36	16,5	42	44	92	18	0,3	4	17200
18,0	36	17,5	42	44	92	18	0,3	4	18200
19,0	41	18,5	52	54	104	20	0,3	4	19200
20,0	41	19,5	52	54	104	20	0,3	4	20200

P	●
M	●
K	●
N	○
S	●
H	
O	

→ v_c/f_z Page 392+393

SilverLine – Rough milling cutter

The all-rounder for universal application

▲ With roughing profile

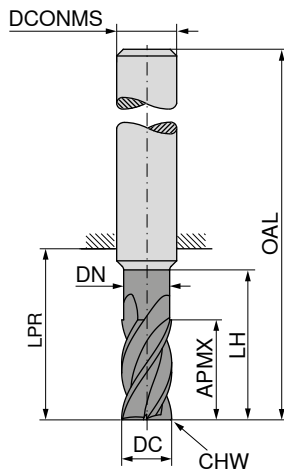
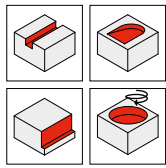
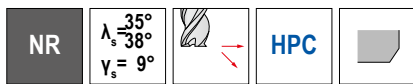

DPB72S

DRAGONSKIN



DIN 6527



50 979 ...

DC _{d11} mm	APMX mm	DN mm	LH mm	LPR mm	OAL mm	DCONMS _{n6} mm	CHW mm	ZEFP	
3,0	8	2,8	13	21	57	6	0,1	4	03200
3,5	11	3,3	17	21	57	6	0,1	4	03700
4,0	11	3,8	17	21	57	6	0,1	4	04200
4,5	13	4,3	19	21	57	6	0,1	4	04700
5,0	13	4,8	19	21	57	6	0,1	4	05200
5,5	13	5,3	19	21	57	6	0,1	4	05700
6,0	13	5,8	19	21	57	6	0,1	4	06200
7,0	21	6,7	25	27	63	8	0,2	4	07200
8,0	21	7,7	25	27	63	8	0,2	4	08200
9,0	22	8,7	30	32	72	10	0,2	4	09200
10,0	22	9,7	30	32	72	10	0,2	4	10200
11,0	26	10,6	36	38	83	12	0,3	4	11200
12,0	26	11,6	36	38	83	12	0,3	4	12200
14,0	26	13,6	36	38	83	14	0,3	4	14200
15,0	36	14,5	42	44	92	16	0,3	4	15200
16,0	36	15,5	42	44	92	16	0,3	4	16200
17,0	36	16,5	42	44	92	18	0,3	4	17200
18,0	36	17,5	42	44	92	18	0,3	4	18200
19,0	41	18,5	52	54	104	20	0,3	4	19200
20,0	41	19,5	52	54	104	20	0,3	4	20200

P	●
M	●
K	●
N	○
S	●
H	
O	

→ v_c/f_z Page 392+393

SilverLine – High Accuracy Finish Milling Cutter

The all-rounder for universal application

▲ max. taper of 0.008 mm for high precision and parallelism of vertical walls

▲ Tool with cutting edge correction

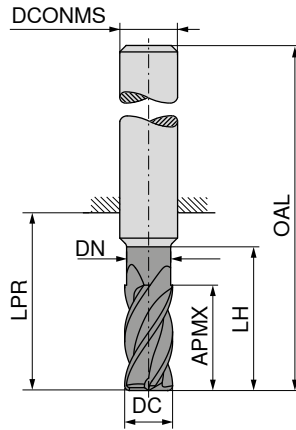
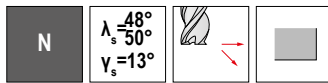

DC ₁₈ mm	APMX mm	DN mm	LH mm	LPR mm	OAL mm	DCONMS ₁₅ mm	ZEFP
6,0	10	5,8	18	22	58	6	6
6,0	13	5,6	19	21	57	6	6
6,0	13	5,8	27	31	67	6	6
6,0	13	5,8	36	40	76	6	6
6,0	15	5,6	42	44	80	6	6
8,0	13	7,7	24	28	64	8	6
8,0	17	7,7	36	40	76	8	6
8,0	17	7,7	48	53	89	8	6
8,0	19	7,6	25	27	63	8	6
8,0	20	7,6	62	64	100	8	6
10,0	16	9,7	30	34	74	10	6
10,0	21	9,7	45	49	89	10	6
10,0	21	9,7	60	64	104	10	6
10,0	22	9,6	30	32	72	10	6
10,0	25	9,6	58	60	100	10	6
12,0	19	11,6	36	40	85	12	6
12,0	25	11,6	54	58	103	12	6
12,0	25	11,6	72	76	121	12	6
12,0	26	11,5	36	38	83	12	6
12,0	30	11,5	73	75	120	12	6
16,0	25	15,5	48	52	100	16	6
16,0	32	15,0	42	44	92	16	6
16,0	33	15,5	72	76	124	16	6
16,0	33	15,5	96	100	148	16	6
16,0	40	15,0	100	102	150	16	6
20,0	32	19,5	60	64	114	20	6
20,0	38	19,0	52	54	104	20	6
20,0	42	19,5	90	94	144	20	6
20,0	42	19,5	120	124	174	20	6
20,0	50	19,0	98	100	150	20	6
25,0	40	24,5	75	80	136	25	6
25,0	52	24,5	113	118	174	25	6
25,0	52	24,5	150	154	210	25	6

50 991 ...	50 991 ...
06200	
06700	
	06400
	06900
	90000
08200	
	08400
	08900
08700	
	90100
10200	
	10400
	90200
10700	
	10900
12200	
	12400
	90300
12700	
	12900
16200	
16700	
	16400
	16900
	90400
20200	
20700	
	20400
	90500
	20900
25200	
	25400
	25900

P	●	●
M	●	●
K	○	○
N	○	○
S	●	●
H		
O		

→ v_c/f_z Page 394

SilverLine – Ball Nosed Cutter

The all-rounder for universal application

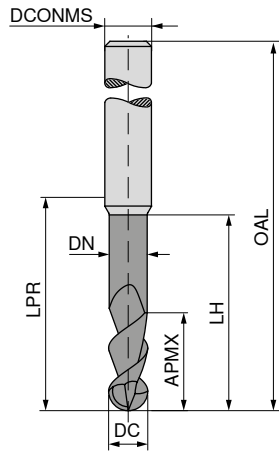
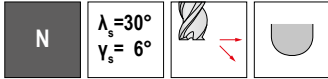

DC ₁₈ mm	APMX mm	DN mm	LH mm	LPR mm	OAL mm	DCONMS ₁₆ mm	ZEFP
3,0	4	2,8	10,0	14	50	6	2
3,0	7	3,0	8,8	24	60	6	2
4,0	8	3,8	12,0	18	54	6	2
4,0	10	4,0	12,5	39	75	6	2
5,0	9	4,8	16,0	18	54	6	2
5,0	12	5,0	15,0	39	75	6	2
6,0	10	5,7	16,0	18	54	6	2
6,0	12	6,0	15,0	64	100	6	2
7,0	11	6,6	20,0	22	58	8	2
8,0	12	7,6	20,0	22	58	8	2
8,0	14	8,0	17,5	64	100	8	2
10,0	14	9,6	24,0	26	66	10	2
10,0	18	10,0	22,5	60	100	10	2
12,0	16	11,5	26,0	28	73	12	2
12,0	22	12,0	27,5	55	100	12	2
14,0	18	13,3	28,0	30	75	14	2
14,0	26	14,0	32,5	75	120	14	2
16,0	22	15,2	32,0	34	82	16	2
16,0	30	16,0	37,5	102	150	16	2
18,0	24	17,1	34,0	36	84	18	2
20,0	26	19,0	40,0	42	92	20	2
20,0	38	20,0	47,5	100	150	20	2

	50 963 ...	50 963 ...
P	●	●
M		
K	●	●
N	○	○
S		
H	○	○
O		

→ v_c/f_z Page 398+399

SilverLine – Ball Nosed Cutter

The all-rounder for universal application

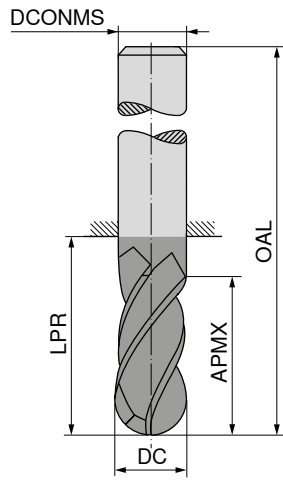
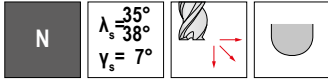

DPB72S

DRAGONSKIN



Factory standard



50 990 ...

DC _{h8} mm	APMX mm	LPR mm	OAL mm	DCONMS _{h6} mm	ZEPF	
4,0	11	21	57	6	4	04220
5,0	13	21	57	6	4	05225
6,0	13	21	57	6	4	06230
8,0	19	36	72	8	4	08280
10,0	22	32	72	10	4	10250
12,0	26	38	83	12	4	12260
16,0	32	44	92	16	4	16280
20,0	38	54	104	20	4	20210

P	●
M	○
K	●
N	○
S	
H	
O	

→ v_c/f_z Page 395–397

SilverLine – Torus Face Milling Cutter

The all-rounder for universal application

▲ APMX does not correspond to the maximum cutting depth

▲ r_{30} = corner radius to be programmed

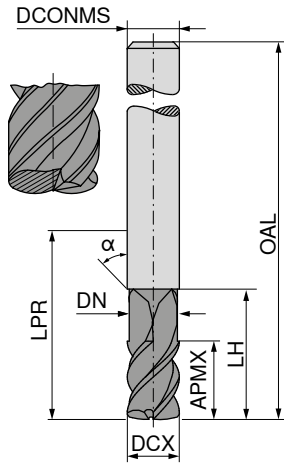
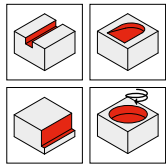

DCX _{fs} mm	r ₃₀ mm	APMX mm	DN mm	LH mm	LPR mm	OAL mm	α°	DCONMS _{h6} mm	ZEFP
6,00	1,12	6	5,5	21	21	57	45	6	4
6,00	1,12	6	5,5	64	64	100	45	6	4
8,00	1,23	8	7,4	27	27	63	45	8	4
8,00	1,23	8	7,4	64	64	100	45	8	4
10,00	1,17	10	9,2	32	32	72	45	10	4
10,00	1,17	10	9,2	60	60	100	45	10	4
12,00	1,86	12	11,0	32	38	83	45	12	4
12,00	1,86	12	11,0	65	65	110	45	12	4
16,00	2,47	16	15,0	38	44	92	45	16	4
16,00	2,47	16	15,0	65	102	150	45	16	4
20,00	2,61	20	18,5	40	42	92	45	20	4
20,00	2,61	20	18,5	65	100	150	45	20	4

50 989 ...	50 989 ...
06110	06410
08110	08410
10115	10415
12115	12415
16120	16420
20120	20420

P	●	●
M	○	○
K	●	●
N	○	○
S	○	○
H	○	○
O		

→ v_c/f_z Page 400+401

SilverLine – NC deburring cutter

The all-rounder for universal application

▲ Point angle $\alpha = 60^\circ$

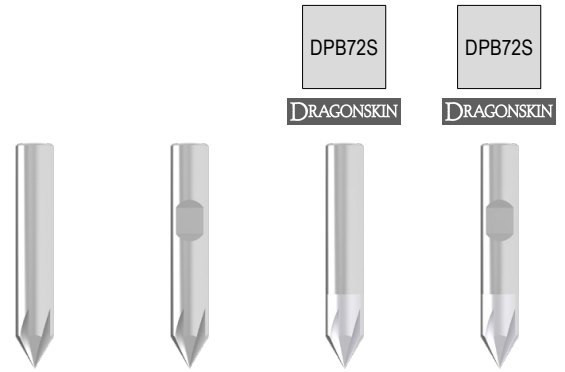
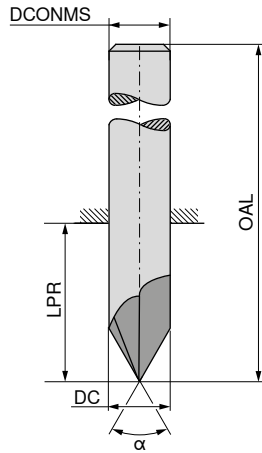
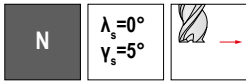

$\alpha = 60^\circ$ Factory standard $\alpha = 60^\circ$ Factory standard $\alpha = 60^\circ$ Factory standard $\alpha = 60^\circ$ Factory standard

50 566 ...	50 567 ...	50 562 ...	50 563 ...
04000	06000	04000	06000
08000	08000	08000	08000
10000	10000	10000	10000
12000	12000	12000	12000
16000	16000	16000	16000

DC mm	OAL mm	LPR mm	DCONMS mm	ZEFP mm
4	50	22	4	5
6	55	19	6	5
8	58	22	8	5
10	60	20	10	5
12	70	25	12	5
16	80	32	16	5

P	•	•	•	•
M	•	•	•	•
K	•	•	•	•
N	•	•	•	•
S	•	•	•	•
H				
O				

→ v_c/f_z Page 379

SilverLine – NC deburring cutter

The all-rounder for universal application

▲ High performance 5 flute chamfering tool

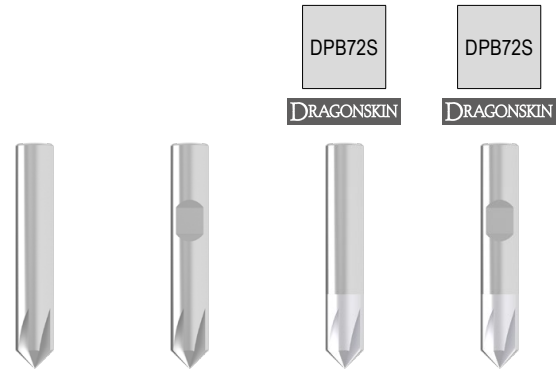
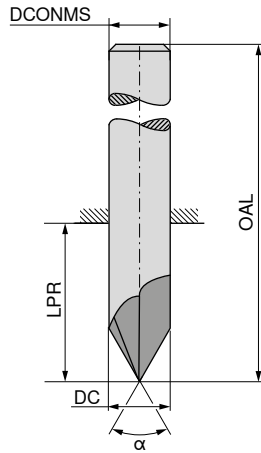
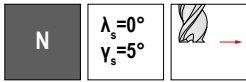

$\alpha = 90^\circ$ Factory standard $\alpha = 90^\circ$ Factory standard $\alpha = 90^\circ$ Factory standard $\alpha = 90^\circ$ Factory standard

50 564 ... 50 565 ... 50 560 ... 50 561 ...

DC mm	OAL mm	LPR mm	DCONMS mm	ZEFP				
4	50	22	4	5		04000		04000
6	55	19	6	5		06000	06000	06000
8	58	22	8	5		08000	08000	08000
10	60	20	10	5		10000	10000	10000
12	70	25	12	5		12000	12000	12000
16	80	32	16	5		16000	16000	16000
P					•	•	•	•
M					•	•	•	•
K					•	•	•	•
N								
S					•	•	•	•
H								
O								

→ v_c/f_z Page 379

S-Cut – End milling cutter

The all-rounder with soft cut and low power consumption

SC UNI λ_s var. $\lambda_s=28^\circ$
 $\lambda_s=36^\circ$
 $\gamma_s=10^\circ$ HPC

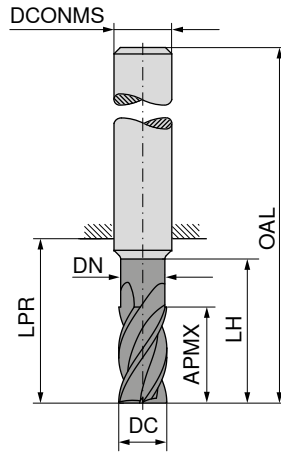
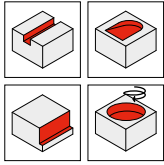

APX72S



≈DIN 6527



52 225 ...

DC ₁₈ mm	APMX mm	DN mm	LH mm	LPR mm	OAL mm	DCONMS ₁₆ mm	ZEFP
3	8	2,8	15,0	21	57	6	4
4	11	3,8	16,5	21	57	6	4
5	13	4,8	18,5	21	57	6	4
6	13	5,5	21,0	21	57	6	4
8	19	7,5	27,0	27	63	8	4
10	22	9,5	32,0	32	72	10	4
12	26	11,5	38,0	38	83	12	4
14	26	13,5	38,0	38	83	14	4
16	36	15,5	44,0	44	92	16	4
18	36	17,5	52,0	52	100	18	4
20	38	19,5	54,0	54	104	20	4
25	42	24,0	65,0	65	121	25	4

- 030
- 040
- 050
- 060
- 080
- 100
- 120
- 140
- 160
- 180
- 200
- 250

P	●
M	●
K	●
N	○
S	○
H	○
O	○

→ v_c/f_z Page 402+403

S-Cut – End milling cutter

The all-rounder with soft cut and low power consumption

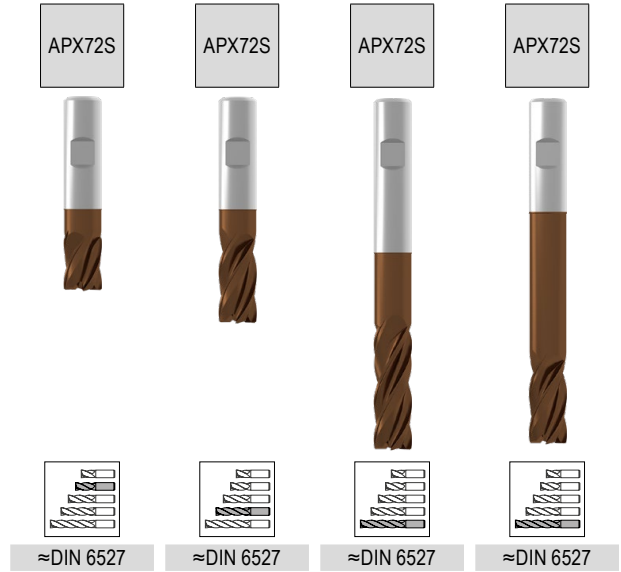
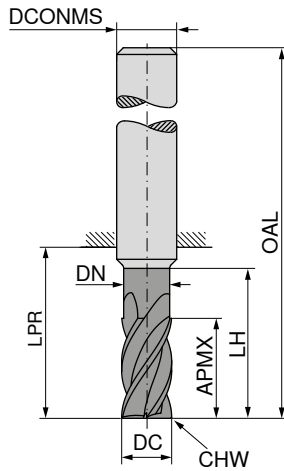
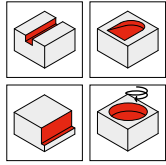
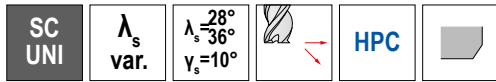

DC _{FB}	APMX	DN	LH	LPR	OAL	DCONMS _{h6}	CHW	ZEFP
mm	mm	mm	mm	mm	mm	mm	mm	
3	6	2,8	12,0	18	54	6	0,10	4
3	8	2,8	15,0	21	57	6	0,10	4
4	8	3,8	13,5	18	54	6	0,13	4
4	11	3,8	16,5	21	57	6	0,13	4
5	9	4,8	15,5	18	54	6	0,18	4
5	13	4,8	18,5	21	57	6	0,18	4
5	22	4,8	24,5	27	63	6	0,18	4
6	10	5,5	18,0	18	54	6	0,20	4
6	13	5,5	21,0	21	57	6	0,20	4
6	13	5,5	42,0	44	80	6	0,20	4
6	22	5,5	27,0	27	63	6	0,20	4
7	12	6,5	22,0	22	58	8	0,20	4
7	19	6,5	27,0	27	63	8	0,20	4
8	12	7,5	22,0	22	58	8	0,20	4
8	19	7,5	27,0	27	63	8	0,20	4
8	21	7,5	62,0	64	100	8	0,20	4
8	28	7,5	36,0	44	80	8	0,20	4
9	14	8,5	26,0	26	66	10	0,30	4
9	22	8,5	32,0	32	72	10	0,20	4
10	14	9,5	26,0	26	66	10	0,30	4
10	22	9,5	32,0	32	72	10	0,30	4
10	22	9,5	58,0	60	100	10	0,30	4
10	33	9,5	54,0	60	100	10	0,30	4
11	16	10,5	28,0	28	73	12	0,30	4
11	26	10,5	38,0	38	83	12	0,30	4
12	16	11,5	28,0	28	73	12	0,30	4
12	26	11,5	38,0	38	83	12	0,30	4
12	26	11,5	73,0	75	120	12	0,30	4
12	42	11,5	54,0	55	100	12	0,30	4
13	18	12,5	30,0	30	75	14	0,30	4
13	26	12,5	38,0	38	83	14	0,30	4
14	18	13,5	30,0	30	75	14	0,30	4
14	26	13,5	38,0	38	83	14	0,30	4
14	48	13,5	54,0	55	100	14	0,30	4
16	22	15,5	34,0	34	82	16	0,40	4
16	36	15,5	44,0	44	92	16	0,40	4
16	36	15,5	100,0	102	150	16	0,40	4
16	53	15,5	84,0	102	150	16	0,40	4
18	24	17,5	34,0	36	84	18	0,40	4
18	36	17,5	52,0	52	100	18	0,40	4
20	26	19,5	42,0	42	92	20	0,50	4
20	38	19,5	54,0	54	104	20	0,50	4
20	38	19,5	100,0	100	150	20	0,50	4
20	68	19,5	84,0	100	150	20	0,50	4
25	32	24,0	46,0	49	105	25	0,50	4
25	42	24,0	65,0	65	121	25	0,50	4
25	68	24,0	84,0	94	150	25	0,50	4

52 223 ...	52 224 ...	52 226 ...	52 227 ...
030			
040	030		
050	040		
060	050	050	
070	060	060	060
080	070	080	080
090	080	080	080
100	090	100	100
110	100	110	110
120	110	120	120
130	120	130	130
140	130	140	140
160	140	160	160
180	160	180	180
200	180	200	200
250	200	250	250

P	●	●	●	●
M	●	●	●	●
K	●	●	●	●
N	○	○	○	○
S	○	○	○	○
H	○	○	○	○
O				

→ v_c/f_z Page 402-405

S-Cut – End milling cutter with corner radius

The all-rounder with soft cut and low power consumption

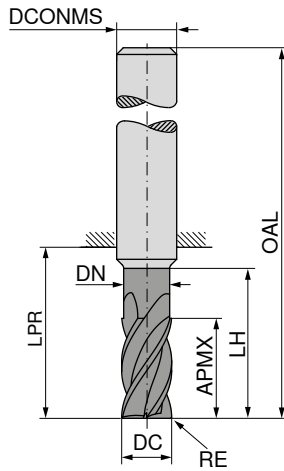
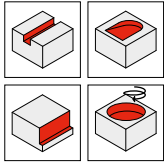
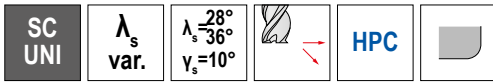

APX72S



≈DIN 6527



52 228 ...

DC _{FB}	RE	APMX	DN	LH	LPR	OAL	DCONMS _{FB}	ZEFP	
mm	mm	mm	mm	mm	mm	mm	mm		
3	0,25	8	2,8	15,0	21	57	6	4	03003
3	0,50	8	2,8	15,0	21	57	6	4	03005
3	1,00	8	2,8	15,0	21	57	6	4	03010
4	0,25	11	3,8	16,5	21	57	6	4	04003
4	0,50	11	3,8	16,5	21	57	6	4	04005
4	1,00	11	3,8	16,5	21	57	6	4	04010
5	0,50	13	4,8	18,5	21	57	6	4	05005
5	1,00	13	4,8	18,5	21	57	6	4	05010
5	1,50	13	4,8	18,5	21	57	6	4	05015
6	0,50	13	5,5	21,0	21	57	6	4	06005
6	0,80	13	5,5	21,0	21	57	6	4	06008
6	1,00	13	5,5	21,0	21	57	6	4	06010
6	1,50	13	5,5	21,0	21	57	6	4	06015
6	2,00	13	5,5	21,0	21	57	6	4	06020
8	0,50	19	7,5	27,0	27	63	8	4	08005
8	0,80	19	7,5	27,0	27	63	8	4	08008
8	1,00	19	7,5	27,0	27	63	8	4	08010
8	1,50	19	7,5	27,0	27	63	8	4	08015
8	2,00	19	7,5	27,0	27	63	8	4	08020
10	0,50	22	9,5	32,0	32	72	10	4	10005
10	1,00	22	9,5	32,0	32	72	10	4	10010
10	1,50	22	9,5	32,0	32	72	10	4	10015
10	1,60	22	9,5	32,0	32	72	10	4	10016
10	2,00	22	9,5	32,0	32	72	10	4	10020
12	0,50	26	11,5	38,0	38	83	12	4	12005
12	1,00	26	11,5	38,0	38	83	12	4	12010
12	1,50	26	11,5	38,0	38	83	12	4	12015
12	1,60	26	11,5	38,0	38	83	12	4	12016
12	2,00	26	11,5	38,0	38	83	12	4	12020
12	3,00	26	11,5	38,0	38	83	12	4	12030
16	1,00	36	15,5	44,0	44	92	16	4	16010
16	1,50	36	15,5	44,0	44	92	16	4	16015
16	1,60	36	15,5	44,0	44	92	16	4	16016
16	2,00	36	15,5	44,0	44	92	16	4	16020
16	2,50	36	15,5	44,0	44	92	16	4	16025
16	3,00	36	15,5	44,0	44	92	16	4	16030
20	1,00	38	19,5	54,0	54	104	20	4	20010
20	1,50	38	19,5	54,0	54	104	20	4	20015
20	2,00	38	19,5	54,0	54	104	20	4	20020
20	2,50	38	19,5	54,0	54	104	20	4	20025
20	3,00	38	19,5	54,0	54	104	20	4	20030
20	4,00	38	19,5	54,0	54	104	20	4	20040

P	●
M	●
K	●
N	○
S	○
H	○
O	○

→ v_c/f_z Page 402+403

S-Cut – End milling cutter

The all-rounder with soft cut and low power consumption

- ▲ Suitable for trochoidal milling
- ▲ With chip breaker

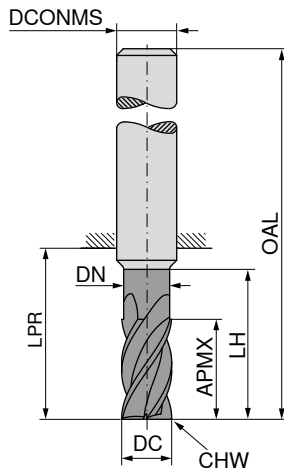
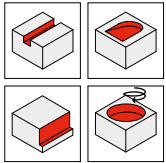
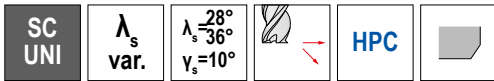

APX72S



≈DIN 6527



52 230 ...

DC ₁₈ mm	APMX mm	DN mm	LH mm	LPR mm	OAL mm	DCONMS _{h6} mm	CHW mm	ZEFP	
6	18	5,5	25	26	62	6	0,12	5	060
8	24	7,5	30	32	68	8	0,16	5	080
10	30	9,5	35	40	80	10	0,20	5	100
12	36	11,5	45	48	93	12	0,24	5	120
16	48	15,5	55	60	108	16	0,32	5	160
20	60	19,5	70	76	126	20	0,40	5	200

P	●
M	●
K	●
N	●
S	○
H	
O	

→ v_c/f_z Page 406+407

S-Cut – Rough milling cutter

The all-rounder with soft cut and low power consumption

▲ With roughing profile

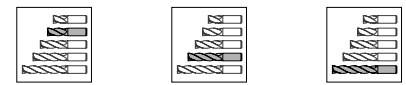
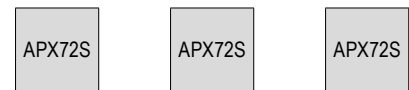
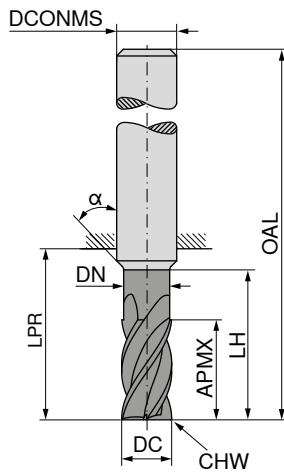
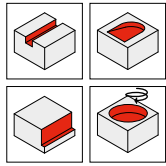
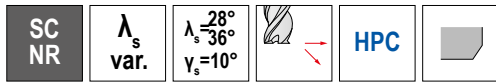

DC _{min} mm	APMX mm	DN mm	LH mm	LPR mm	OAL mm	DCONMS _{h6} mm	CHW mm	α°	ZEFP
3	6	2,8	12,0	18	54	6	0,18	15	4
3	8	2,8	14,0	21	57	6	0,18	15	4
3	8	2,8	19,0	26	62	6	0,18	15	4
4	8	3,8	13,5	18	54	6	0,20	15	4
4	11	3,8	18,0	21	57	6	0,20	15	4
4	11	3,8	23,0	26	62	6	0,20	15	4
5	9	4,8	15,5	18	54	6	0,25	15	4
5	13	4,8	19,0	21	57	6	0,25	15	4
5	13	4,8	24,0	26	62	6	0,25	15	4
6	10	5,5	18,0	18	54	6	0,25		4
6	13	5,5	20,0	21	57	6	0,25		4
6	13	5,5	25,0	26	62	6	0,25		4
8	12	7,5	22,0	22	58	8	0,30		4
8	19	7,5	25,0	27	63	8	0,30		4
8	19	7,5	30,0	32	68	8	0,30		4
10	14	9,5	26,0	26	66	10	0,30		4
10	22	9,5	30,0	32	72	10	0,30		4
10	22	9,5	35,0	40	80	10	0,30		4
12	16	11,5	28,0	28	73	12	0,45		4
12	26	11,5	35,0	38	83	12	0,45		4
12	26	11,5	45,0	48	93	12	0,45		4
14	18	13,5	30,0	30	75	14	0,50		4
14	26	13,5	35,0	38	83	14	0,50		4
14	26	13,5	50,0	54	99	14	0,50		4
16	22	15,5	34,0	34	82	16	0,60		4
16	32	15,5	40,0	44	92	16	0,60		4
16	32	15,5	55,0	60	108	16	0,60		4
20	26	19,5	42,0	42	92	20	0,60		4
20	38	19,5	50,0	54	104	20	0,60		4
20	38	19,5	70,0	76	126	20	0,60		4

52 205 ...	52 205 ...	52 205 ...
03100		
	03200	
04100		03400
	04200	
05100		04400
	05200	
06100		05400
	06200	
08100		06400
	08200	
10100		08400
	10200	
12100		10400
	12200	
14100		12400
	14200	
16100		14400
	16200	
20100		16400
	20200	
		20400

P	●	●	●
M	●	●	●
K	●	●	●
N	○	○	○
S	○	○	○
H	○	○	○
O			

→ v_c/f_z Page 402–405

3D Finish – Barrel shape

The specialist for 3D finish machining

▲ Geometrical tolerance ± 0.01 mm

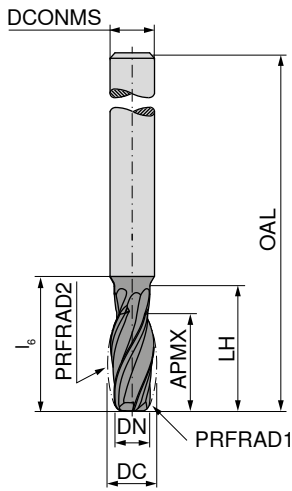
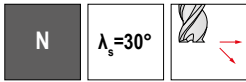

APB72S



DIN 6527



52 739 ...

DC	DCONMS _{h6}	DN	PRFRAD1	PRFRAD2	LH	APMX	i ₆	OAL	ZEFP
mm	mm	mm	mm	mm	mm	mm	mm	mm	
10	10	8	2	50	28	21	30	80	4

100

P	●
M	●
K	●
N	●
S	●
H	○
O	●

→ v_c/f_z Page 408



Information on applications and selecting the right product can be found in the Technical Information on → pages 491+492.

3D Finish – Oval shape

The specialist for 3D finish machining

▲ Geometrical tolerance ± 0.01 mm

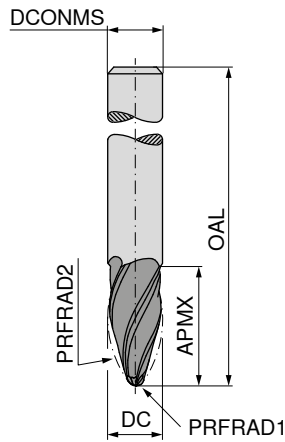
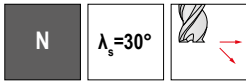

APB72S



DIN 6527



52 745 ...

DC mm	DCONMS _{h6} mm	PRFRAD1 mm	PRFRAD2 mm	APMX mm	OAL mm	ZEFP mm
6	6	1	95	22	62	3
8	8	1	90	25	68	3
10	10	2	85	26	72	4
12	12	2	80	28	83	4
16	16	3	75	31	92	4

060
080
100
120
160

P	●
M	●
K	●
N	●
S	●
H	○
O	●

→ v_c/f_z Page 409



Information on applications and selecting the right product can be found in the Technical Information on → pages 491+492.

3D Finish – Taper shape

The specialist for 3D finish machining

▲ Geometrical tolerance ± 0.01 mm

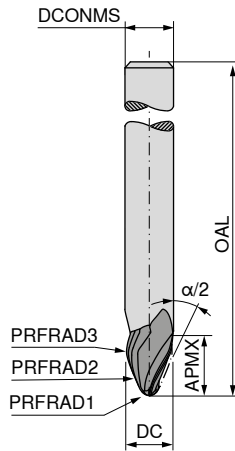
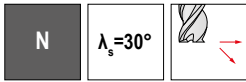

APB72S



DIN 6527



52 753 ...

DC mm	DCONMS _{h6} mm	PRFRAD1 mm	PRFRAD2 mm	PRFRAD3 mm	$\alpha/2$	APMX mm	OAL mm	ZFP	
6	6	1,0	250	3	17,5	9,5	62	3	060
8	8	1,5	250	4	20	10,5	68	3	080
10	10	2,0	250	5	20	12,5	80	3	100
12	12	1,0	200	1	42,5	8,0	93	3	120
12	12	3,0	250	6	20	13,5	93	3	121
16	16	2,0	1000	5	12,5	31,0	108	3	160
16	16	4,0	500	8	20	18,5	108	3	161
16	16	4,0	1000	5	12,5	24,0	108	3	162
16	16	4,0	1500	8	20	18,5	108	3	163

P	●
M	●
K	●
N	●
S	●
H	○
O	●

→ v_c/f_z Page 410



Information on applications and selecting the right product can be found in the Technical Information on → pages 491+492.

3D Finish – Taper shape

The specialist for 3D finish machining

▲ Geometrical tolerance ± 0.01 mm

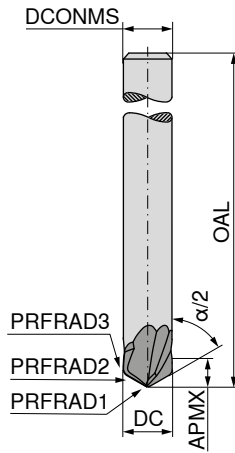
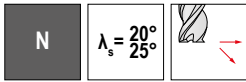

APB72S



DIN 6527



52 755 ...

DC mm	DCONMS _{h6} mm	PRFRAD1 mm	PRFRAD2 mm	PRFRAD3 mm	$\alpha/2$	APMX mm	OAL mm	ZFP	
10	10	1	200	1,5	60	6	80	2	100
10	10	1	200	2,0	70	6	80	2	101

P	●
M	●
K	●
N	●
S	●
H	○
O	●

→ v_c/f_z Page 410



Information on applications and selecting the right product can be found in the Technical Information on → pages 491+492.

3D Finish – Lens shape

The specialist for 3D finish machining

▲ Geometrical tolerance ± 0.01 mm

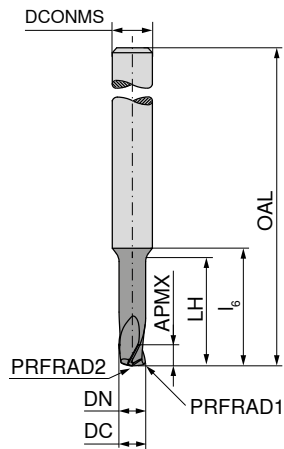
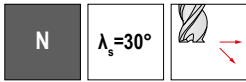

APB72S



DIN 6527



52 756 ...

DC	DCONMS _{h6}	DN	PRFRAD1	PRFRAD2	LH	APMX	l _b	OAL	ZEFP	
mm	mm	mm	mm	mm	mm	mm	mm	mm		
4	6	4	0,25	6	18	4	20	62	3	040
6	6		0,50	10		6		62	3	060
8	8		0,75	15		8		68	3	080
10	10		1,00	20		10		80	3	100
12	12		1,25	25		12		93	3	120

P	•
M	•
K	•
N	•
S	•
H	
O	

→ v_c/f_z Page 411



Information on applications and selecting the right product can be found in the Technical Information on → pages 491+492.

BlueLine – Micro-end milling cutter

The all-rounder for machining tempered steel

▲ T_x = maximum engagement depth

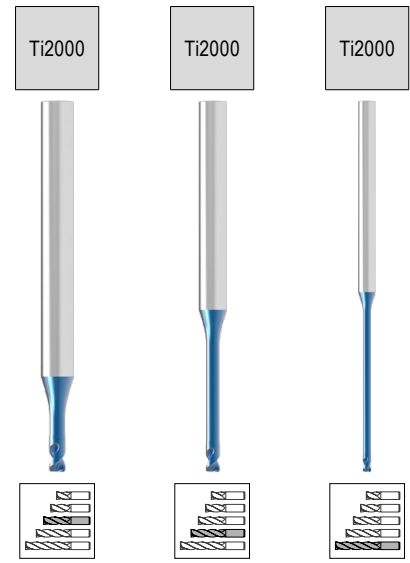
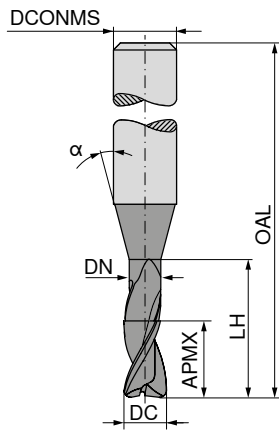
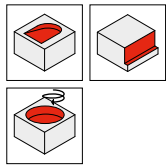
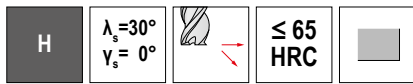

Factory standard Factory standard Factory standard

DC _{-0,01} mm	APMX mm	DN mm	LH mm	OAL mm	α°	DCONMS _{HS} mm	T_x	ZEFP
0,2	0,3	0,18	0,5	45	16	4	2,5 x DC	2
0,2	0,3	0,18	1,0	45	16	4	5 x DC	2
0,2	0,3	0,18	1,5	45	16	4	7,5 x DC	2
0,3	0,4	0,28	1,0	45	16	4	3,3 x DC	2
0,3	0,4	0,28	2,0	45	16	4	6,6 x DC	2
0,3	0,4	0,28	3,0	45	16	4	10 x DC	2
0,3	0,4	0,28	6,0	45	16	4	20 x DC	2
0,3	0,4	0,28	9,0	45	16	4	30 x DC	2
0,4	0,6	0,38	2,0	45	16	4	5 x DC	2
0,4	0,6	0,38	3,0	45	16	4	7,5 x DC	2
0,4	0,6	0,38	4,0	45	16	4	10 x DC	2
0,4	0,6	0,38	5,0	45	16	4	12,5 x DC	2
0,4	0,6	0,38	8,0	45	16	4	20 x DC	2
0,4	0,6	0,38	12,0	45	16	4	30 x DC	2
0,5	0,7	0,48	2,0	45	16	4	4 x DC	2
0,5	0,7	0,48	4,0	45	16	4	8 x DC	2
0,5	0,7	0,48	6,0	45	16	4	12 x DC	2
0,5	0,7	0,48	8,0	45	16	4	16 x DC	2
0,5	0,7	0,48	10,0	50	16	4	20 x DC	2
0,5	0,7	0,48	15,0	50	16	4	30 x DC	2
0,6	0,9	0,58	2,0	45	16	4	3,3 x DC	2
0,6	0,9	0,58	4,0	45	16	4	6,6 x DC	2
0,6	0,9	0,58	6,0	45	16	4	10 x DC	2
0,6	0,9	0,58	8,0	45	16	4	13,3 x DC	2
0,6	0,9	0,58	10,0	45	16	4	16,6 x DC	2
0,6	0,9	0,58	12,0	50	16	4	20 x DC	2
0,6	0,9	0,58	18,0	50	16	4	30 x DC	2
0,7	1,0	0,68	2,0	45	16	4	2,8 x DC	2
0,7	1,0	0,68	4,0	45	16	4	5,7 x DC	2
0,7	1,0	0,68	6,0	45	16	4	8,5 x DC	2
0,7	1,0	0,68	8,0	45	16	4	11,4 x DC	2
0,7	1,0	0,68	10,0	50	16	4	14,2 x DC	2
0,8	1,2	0,78	4,0	45	16	4	5 x DC	2
0,8	1,2	0,78	6,0	45	16	4	7,5 x DC	2
0,8	1,2	0,78	8,0	45	16	4	10 x DC	2
0,8	1,2	0,78	10,0	50	16	4	12,5 x DC	2
0,8	1,2	0,78	12,0	50	16	4	15 x DC	2
0,8	1,2	0,78	16,0	50	16	4	20 x DC	2
0,8	1,2	0,78	24,0	60	16	4	30 x DC	2
0,9	1,3	0,88	4,0	45	16	4	4,4 x DC	2
0,9	1,3	0,88	6,0	45	16	4	6,6 x DC	2
0,9	1,3	0,88	8,0	45	16	4	8,8 x DC	2
0,9	1,3	0,88	10,0	45	16	4	11 x DC	2
0,9	1,3	0,88	15,0	50	16	4	16,6 x DC	2
1,0	1,5	0,95	4,0	45	16	4	4 x DC	2

52 345 ...	52 346 ...	52 347 ...
302		
402		
502		
303		
403		
	303	
	403	
		303
304		
404		
	304	
	404	
		304
		404
305		
405		
	305	
	405	
		305
		405
306		
406		
	306	
	406	
	506	
		306
		406
307		
407		
507		
	307	
	407	
		308
308		
408		
	308	
	408	
	508	
		308
		408
309		
409		
509		
	309	
	409	
310		

P	●	●	●
M			
K			
N			
S			
H	●	●	●
O			

BlueLine – Micro-end milling cutter

The all-rounder for machining tempered steel

▲ T_x = maximum engagement depth

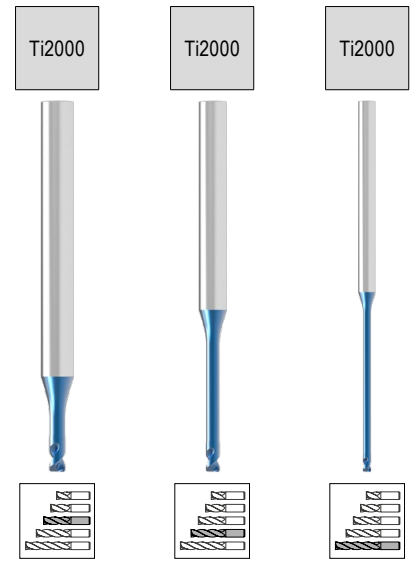
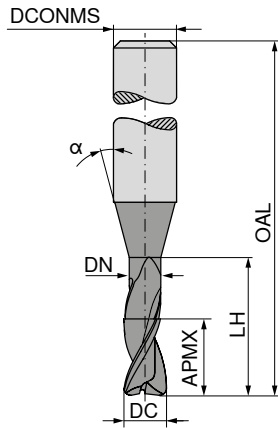
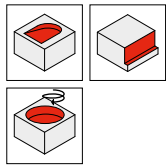
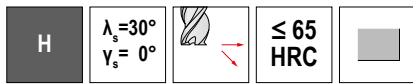

Factory standard Factory standard Factory standard

DC _{-0,01} mm	APMX mm	DN mm	LH mm	OAL mm	α°	DCONMS _{is} mm	T_x	ZEFP
1,0	1,5	0,95	6,0	45	16	4	6 x DC	2
1,0	1,5	0,95	8,0	45	16	4	8 x DC	2
1,0	1,5	0,95	10,0	45	16	4	10 x DC	2
1,0	1,5	0,95	12,0	45	16	4	12 x DC	2
1,0	1,5	0,95	14,0	45	16	4	14 x DC	2
1,0	1,5	0,95	16,0	50	16	4	16 x DC	2
1,0	1,5	0,95	20,0	54	16	4	20 x DC	2
1,0	1,5	0,95	25,0	70	16	4	25 x DC	2
1,0	1,5	0,95	30,0	70	16	4	30 x DC	2
1,2	1,8	1,14	6,0	45	16	4	5 x DC	2
1,2	1,8	1,14	8,0	45	16	4	6,6 x DC	2
1,2	1,8	1,14	10,0	45	16	4	8,3 x DC	2
1,2	1,8	1,14	12,0	45	16	4	10 x DC	2
1,2	1,8	1,14	16,0	50	16	4	13,3 x DC	2
1,2	1,8	1,14	20,0	60	16	4	16,6 x DC	2
1,4	2,1	1,34	6,0	45	16	4	4,2 x DC	2
1,4	2,1	1,34	8,0	45	16	4	5,7 x DC	2
1,4	2,1	1,34	10,0	45	16	4	7,1 x DC	2
1,4	2,1	1,34	12,0	45	16	4	8,5 x DC	2
1,4	2,1	1,34	14,0	45	16	4	10 x DC	2
1,4	2,1	1,34	16,0	50	16	4	11,4 x DC	2
1,4	2,1	1,34	22,0	54	16	4	15,7 x DC	2
1,5	2,3	1,44	6,0	45	16	4	4 x DC	2
1,5	2,3	1,44	8,0	45	16	4	5,3 x DC	2
1,5	2,3	1,44	10,0	45	16	4	6,6 x DC	2
1,5	2,3	1,44	12,0	45	16	4	8 x DC	2
1,5	2,3	1,44	14,0	50	16	4	9,3 x DC	2
1,5	2,3	1,44	16,0	50	16	4	10,6 x DC	2
1,5	2,3	1,44	18,0	54	16	4	12 x DC	2
1,5	2,3	1,44	20,0	54	16	4	13,3 x DC	2
1,5	2,3	1,44	25,0	70	16	4	16,6 x DC	2
1,5	2,3	1,44	30,0	70	16	4	20 x DC	2
1,5	2,3	1,44	35,0	70	16	4	23,3 x DC	2
1,5	2,3	1,44	40,0	80	16	4	26,6 x DC	2
1,5	2,3	1,44	45,0	80	16	4	30 x DC	2
1,6	2,4	1,51	6,0	45	16	4	3,7 x DC	2
1,6	2,4	1,51	8,0	45	16	4	5 x DC	2
1,6	2,4	1,51	10,0	45	16	4	6,2 x DC	2
1,6	2,4	1,51	12,0	45	16	4	7,5 x DC	2
1,6	2,4	1,51	14,0	50	16	4	8,75 x DC	2
1,6	2,4	1,51	16,0	50	16	4	10 x DC	2
1,6	2,4	1,51	18,0	54	16	4	11,25 x DC	2
1,6	2,4	1,51	20,0	54	16	4	12,5 x DC	2
1,6	2,4	1,51	26,0	60	16	4	16,2 x DC	2
1,8	2,7	1,71	6,0	45	16	4	3,3 x DC	2

52 345 ...	52 346 ...	52 347 ...
410		
510		
	310	
	410	
	510	
	610	
		310
		410
		510
312		
412		
512		
	312	
	412	
	512	
314		
414		
514		
614		
	314	
	414	
	514	
315		
415		
515		
615		
715		
	315	
	415	
	515	
	615	
	715	
		315
		415
		515
316		
416		
516		
616		
716		
	316	
	416	
	516	
	616	
318		

P	●	●	●
M			
K			
N			
S			
H	●	●	●
O			

BlueLine – Micro-end milling cutter

The all-rounder for machining tempered steel

▲ T_x = maximum engagement depth

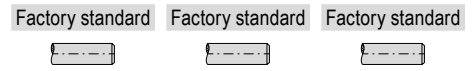
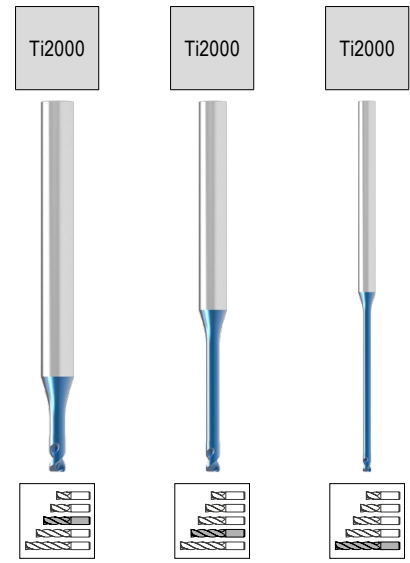
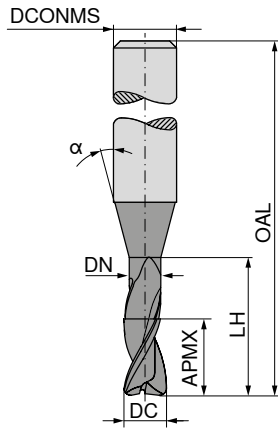
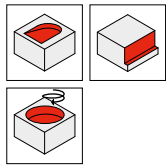
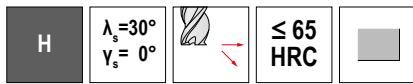

DC _{-0,01} mm	APMX mm	DN mm	LH mm	OAL mm	α°	DCONMS _{h5} mm	T _x	ZEFP
1,8	2,7	1,71	8,0	45	16	4	4,4 x DC	2
1,8	2,7	1,71	10,0	45	16	4	5,5 x DC	2
1,8	2,7	1,71	12,0	45	16	4	6,6 x DC	2
1,8	2,7	1,71	14,0	50	16	4	7,7 x DC	2
1,8	2,7	1,71	16,0	50	16	4	8,8 x DC	2
1,8	2,7	1,71	18,0	54	16	4	10 x DC	2
1,8	2,7	1,71	20,0	54	16	4	11 x DC	2
1,8	2,7	1,71	25,0	60	16	4	13,8 x DC	2
2,0	3,0	1,91	6,0	45	16	4	3 x DC	2
2,0	3,0	1,91	8,0	45	16	4	4 x DC	2
2,0	3,0	1,91	10,0	45	16	4	5 x DC	2
2,0	3,0	1,91	12,0	45	16	4	6 x DC	2
2,0	3,0	1,91	14,0	50	16	4	7 x DC	2
2,0	3,0	1,91	16,0	50	16	4	8 x DC	2
2,0	3,0	1,91	18,0	54	16	4	9 x DC	2
2,0	3,0	1,91	20,0	54	16	4	10 x DC	2
2,0	3,0	1,91	25,0	60	16	4	12,5 x DC	2
2,0	3,0	1,91	30,0	70	16	4	15 x DC	2
2,0	3,0	1,91	35,0	80	16	4	17,5 x DC	2
2,0	3,0	1,91	40,0	90	16	4	20 x DC	2
2,0	3,0	1,91	50,0	100	16	4	25 x DC	2
2,0	3,0	1,91	60,0	110	16	4	30 x DC	2
2,5	3,7	2,41	8,0	45	16	4	3,2 x DC	2
2,5	3,7	2,41	10,0	45	16	4	4 x DC	2
2,5	3,7	2,41	12,0	45	16	4	4,8 x DC	2
2,5	3,7	2,41	14,0	50	16	4	5,6 x DC	2
2,5	3,7	2,41	16,0	50	16	4	6,4 x DC	2
2,5	3,7	2,41	18,0	54	16	4	7,2 x DC	2
2,5	3,7	2,41	20,0	54	16	4	8 x DC	2
2,5	3,7	2,41	25,0	60	16	4	10 x DC	2
2,5	3,7	2,41	30,0	70	16	4	12 x DC	2
2,5	3,7	2,41	40,0	90	16	4	16 x DC	2
2,5	3,7	2,41	50,0	100	16	4	20 x DC	2
3,0	4,5	2,92	8,0	45	16	4	2,6 x DC	2
3,0	4,5	2,92	12,0	45	16	4	4 x DC	2
3,0	4,5	2,92	16,0	50	16	4	5,3 x DC	2
3,0	4,5	2,92	20,0	54	16	4	6,6 x DC	2

52 345 ...	52 346 ...	52 347 ...
418		
518		
618		
718		
818		
	318	
	418	
	518	
320		
420		
520		
620		
720		
820		
920		
	320	
	420	
	520	
	620	
		320
		420
		520
325		
425		
525		
625		
725		
825		
925		
	325	
	425	
	525	
		325
330		
430		
530		
630		

P	•	•	•
M			
K			
N			
S			
H	•	•	•
O			

→ v_c/f_z Page 420+421

BlueLine – Micro-ball nosed cutter

The all-rounder for machining tempered steel

▲ T_x = maximum engagement depth

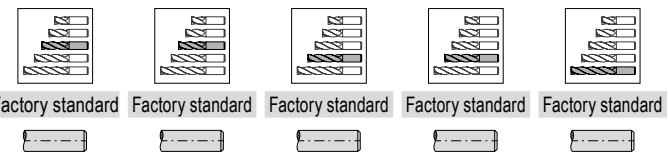
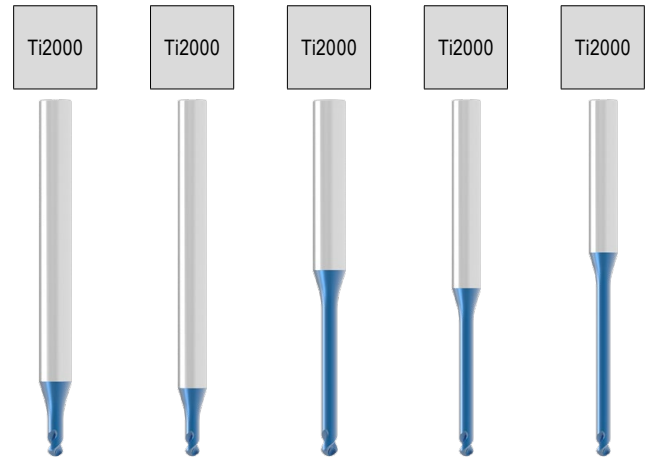
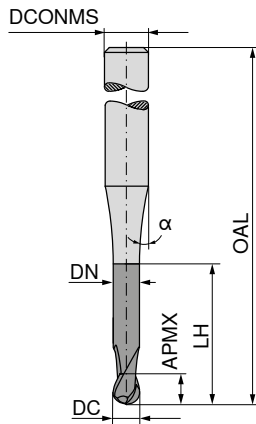
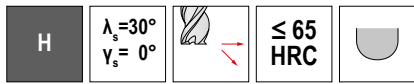

DC _{-0.01}	APMX	DN	LH	OAL	α°	DCONMS _{h5}	T_x	ZEFP
mm	mm	mm	mm	mm		mm		
0,2	0,16	0,17	0,30	45	16	4	1,5 x DC	2
0,2	0,16	0,17	0,50	45	16	4	2,5 x DC	2
0,2	0,16	0,17	0,75	45	16	4	3,75 x DC	2
0,2	0,16	0,17	1,00	45	16	4	5 x DC	2
0,2	0,16	0,17	1,25	45	16	4	6,2 x DC	2
0,2	0,16	0,17	1,50	45	16	4	7,5 x DC	2
0,2	0,16	0,17	1,75	45	16	4	8,7 x DC	2
0,2	0,16	0,17	2,00	45	16	4	10 x DC	2
0,2	0,16	0,17	2,50	45	16	4	12,5 x DC	2
0,2	0,16	0,17	3,00	45	16	4	15 x DC	2
0,3	0,24	0,27	0,50	45	16	4	1,6 x DC	2
0,3	0,24	0,27	0,75	45	16	4	2,5 x DC	2
0,3	0,24	0,27	1,00	45	16	4	3,3 x DC	2
0,3	0,24	0,27	1,25	45	16	4	4,1 x DC	2
0,3	0,24	0,27	1,50	45	16	4	5 x DC	2
0,3	0,24	0,27	1,75	50	16	4	5,8 x DC	2
0,3	0,24	0,27	2,00	50	16	4	6,6 x DC	2
0,3	0,24	0,27	2,25	50	16	4	7,5 x DC	2
0,3	0,24	0,27	2,50	50	16	4	8,3 x DC	2
0,3	0,24	0,27	2,75	50	16	4	9,1 x DC	2
0,3	0,24	0,27	3,00	50	16	4	10 x DC	2
0,3	0,24	0,27	3,50	50	16	4	11,6 x DC	2
0,3	0,24	0,27	4,00	50	16	4	13,3 x DC	2
0,3	0,24	0,27	4,50	50	16	4	15 x DC	2
0,4	0,32	0,34	0,50	45	16	4	1,2 x DC	2
0,4	0,32	0,34	1,00	45	16	4	2,5 x DC	2
0,4	0,32	0,34	1,50	45	16	4	3,75 x DC	2
0,4	0,32	0,34	2,00	45	16	4	5 x DC	2
0,4	0,32	0,34	2,50	45	16	4	6,2 x DC	2
0,4	0,32	0,34	3,00	45	16	4	7,5 x DC	2
0,4	0,32	0,34	3,50	45	16	4	8,7 x DC	2
0,4	0,32	0,34	4,00	45	16	4	10 x DC	2
0,4	0,32	0,34	4,50	45	16	4	11,2 x DC	2
0,4	0,32	0,34	5,00	45	16	4	12,5 x DC	2
0,4	0,32	0,34	5,50	45	16	4	13,7 x DC	2
0,4	0,32	0,34	6,00	45	16	4	15 x DC	2
0,5	0,40	0,47	1,50	45	16	4	3 x DC	2
0,5	0,40	0,47	2,00	45	16	4	4 x DC	2
0,5	0,40	0,47	2,50	45	16	4	5 x DC	2
0,5	0,40	0,47	3,00	45	16	4	6 x DC	2
0,5	0,40	0,47	3,50	45	16	4	7 x DC	2

52 356 ...	52 358 ...	52 357 ...	52 359 ...	52 360 ...
302				
402				
502				
602				
702				
802				
902				
			302	
			402	
			502	
303				
403				
503				
603				
703				
	303			
	403			
	503			
	603			
	703			
			303	
			403	
			503	
			603	
304				
404				
504				
604				
704				
804				
904				
			304	
			404	
			504	
			604	
			704	
305				
405				
505				
605				
705				

P	•	•	•	•	•
M					
K					
N					
S					
H	•	•	•	•	•
O					

BlueLine – Micro-ball nosed cutter

The all-rounder for machining tempered steel

▲ T_x = maximum engagement depth

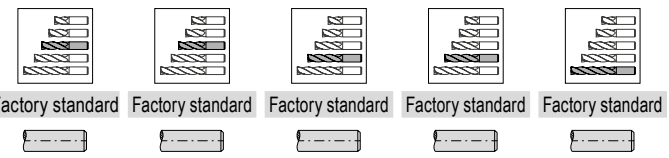
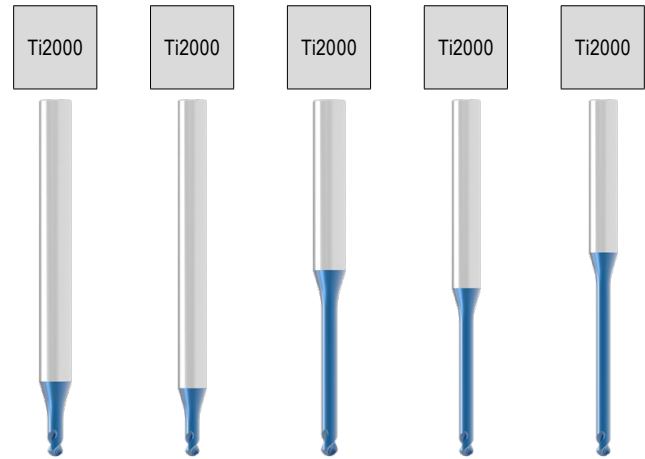
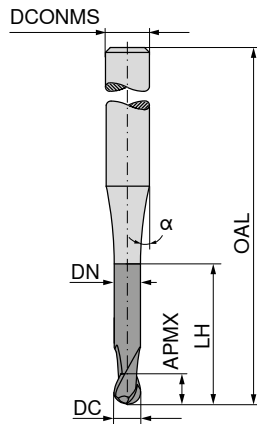
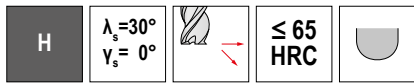

DC _{-0.01}	APMX	DN	LH	OAL	α°	DCONMS _{h5}	T_x	ZEFP
mm	mm	mm	mm	mm		mm		
0,5	0,40	0,47	4,00	45	16	4	8 x DC	2
0,5	0,40	0,47	4,50	45	16	4	9 x DC	2
0,5	0,40	0,47	5,00	45	16	4	10 x DC	2
0,5	0,40	0,47	5,50	45	16	4	11 x DC	2
0,5	0,40	0,47	6,00	45	16	4	12 x DC	2
0,5	0,40	0,47	7,00	45	16	4	14 x DC	2
0,5	0,40	0,47	8,00	45	16	4	16 x DC	2
0,5	0,40	0,47	9,00	45	16	4	18 x DC	2
0,5	0,40	0,47	10,00	50	16	4	20 x DC	2
0,6	0,40	0,57	12,00	50	16	4	20 x DC	2
0,6	0,48	0,57	1,00	45	16	4	1,6 x DC	2
0,6	0,48	0,57	2,00	45	16	4	3,3 x DC	2
0,6	0,48	0,57	3,00	45	16	4	5 x DC	2
0,6	0,48	0,57	4,00	45	16	4	6,6 x DC	2
0,6	0,48	0,57	5,00	45	16	4	8,3 x DC	2
0,6	0,48	0,57	6,00	45	16	4	10 x DC	2
0,6	0,48	0,57	8,00	45	16	4	13,3 x DC	2
0,6	0,48	0,57	10,00	50	16	4	16,6 x DC	2
0,8	0,64	0,77	2,00	45	16	4	2,5 x DC	2
0,8	0,64	0,77	3,00	45	16	4	3,75 x DC	2
0,8	0,64	0,77	4,00	45	16	4	5 x DC	2
0,8	0,64	0,77	5,00	45	16	4	6,2 x DC	2
0,8	0,64	0,77	6,00	45	16	4	7,5 x DC	2
0,8	0,64	0,77	7,00	45	16	4	8,7 x DC	2
0,8	0,64	0,77	8,00	45	16	4	10 x DC	2
0,8	0,64	0,77	9,00	45	16	4	11,2 x DC	2
0,8	0,64	0,77	10,00	50	16	4	12,5 x DC	2
1,0	0,80	0,96	3,00	45	16	4	3 x DC	2
1,0	0,80	0,96	4,00	45	16	4	4 x DC	2
1,0	0,80	0,96	5,00	45	16	4	5 x DC	2
1,0	0,80	0,96	6,00	45	16	4	6 x DC	2
1,0	0,80	0,96	7,00	45	16	4	7 x DC	2
1,0	0,80	0,96	8,00	45	16	4	8 x DC	2
1,0	0,80	0,96	9,00	45	16	4	9 x DC	2
1,0	0,80	0,96	10,00	45	16	4	10 x DC	2
1,0	0,80	0,96	12,00	45	16	4	12 x DC	2
1,0	0,80	0,96	14,00	50	16	4	14 x DC	2
1,0	0,80	0,96	16,00	50	16	4	16 x DC	2
1,2	0,96	1,16	6,00	45	16	4	5 x DC	2
1,2	0,96	1,16	8,00	45	16	4	6,6 x DC	2
1,2	0,96	1,16	10,00	45	16	4	8,3 x DC	2

52 356 ...	52 358 ...	52 357 ...	52 359 ...	52 360 ...
805				
905				
		305		
		405		
		505		
		605		
		705		
		805		
				305
				306
306				
406				
506				
606				
706				
		306		
		406		
			306	
308				
408				
508				
608				
708				
808				
		308		
		408		
			308	
310				
410				
510				
610				
710				
810				
910				
		310		
		410		
			310	
			410	
312				
412				
512				

P	•	•	•	•	•
M					
K					
N					
S					
H	•	•	•	•	•
O					

BlueLine – Micro-torus cutter

The all-rounder for machining tempered steel

▲ T_x = maximum engagement depth

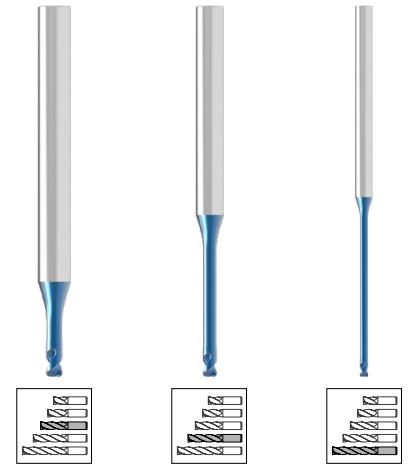
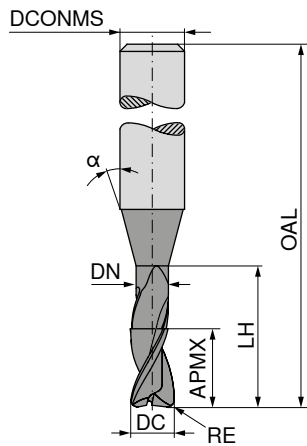
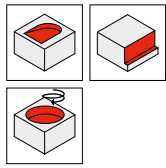
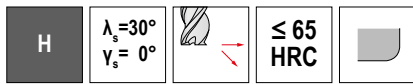

Factory standard Factory standard Factory standard

52 349 ... 52 350 ... 52 351 ...

DC mm	RE mm	APMX mm	DN mm	LH mm	OAL mm	α°	DCONMS _{HS} mm	T _x	ZEFP			
0,4	0,1	0,4	0,38	1,0	50	16	4	2,5 x DC	2			30401
0,4	0,1	0,4	0,38	1,5	50	16	4	3,75 x DC	2			40401
0,4	0,1	0,4	0,38	2,0	50	16	4	5 x DC	2			50401
0,4	0,1	0,4	0,38	3,0	50	16	4	7,5 x DC	2			60401
0,4	0,1	0,4	0,38	4,0	50	16	4	10 x DC	2			
0,5	0,1	0,5	0,48	1,0	50	16	4	2 x DC	2			30501
0,5	0,1	0,5	0,48	2,0	50	16	4	4 x DC	2			40501
0,5	0,1	0,5	0,48	3,0	50	16	4	6 x DC	2			50501
0,5	0,1	0,5	0,48	4,0	50	16	4	8 x DC	2			60501
0,5	0,1	0,5	0,48	5,0	50	16	4	10 x DC	2			
0,5	0,1	0,5	0,48	6,0	50	16	4	12 x DC	2			
0,6	0,1	0,6	0,58	2,0	50	16	4	3,3 x DC	2			30601
0,6	0,1	0,6	0,58	3,0	50	16	4	5 x DC	2			40601
0,6	0,1	0,6	0,58	4,0	50	16	4	6,6 x DC	2			50601
0,6	0,1	0,6	0,58	6,0	50	16	4	10 x DC	2			
0,6	0,1	0,6	0,58	8,0	50	16	4	13,3 x DC	2			
0,7	0,1	0,7	0,68	4,0	50	16	4	5,7 x DC	2			30701
0,7	0,1	0,7	0,68	6,0	50	16	4	8,5 x DC	2			40701
0,8	0,1	0,8	0,78	4,0	50	16	4	5 x DC	2			30801
0,8	0,1	0,8	0,78	6,0	50	16	4	7,5 x DC	2			40801
0,8	0,2	0,8	0,78	4,0	50	16	4	5 x DC	2			30802
0,8	0,2	0,8	0,78	6,0	50	16	4	7,5 x DC	2			40802
1,0	0,1	1,0	0,95	2,0	50	16	4	2 x DC	2			31001
1,0	0,1	1,0	0,95	4,0	50	16	4	4 x DC	2			41001
1,0	0,1	1,0	0,95	6,0	50	16	4	6 x DC	2			51001
1,0	0,1	1,0	0,95	8,0	50	16	4	8 x DC	2			61001
1,0	0,1	1,0	0,95	10,0	50	16	4	10 x DC	2			
1,0	0,1	1,0	0,95	12,0	54	16	4	12 x DC	2			
1,0	0,1	1,0	0,95	16,0	60	16	4	16 x DC	2			
1,0	0,1	1,0	0,95	20,0	60	16	4	20 x DC	2			
1,0	0,2	1,0	0,95	2,0	50	16	4	2 x DC	2			31002
1,0	0,2	1,0	0,95	4,0	50	16	4	4 x DC	2			41002
1,0	0,2	1,0	0,95	6,0	50	16	4	6 x DC	2			51002
1,0	0,2	1,0	0,95	8,0	50	16	4	8 x DC	2			61002
1,0	0,2	1,0	0,95	10,0	50	16	4	10 x DC	2			
1,0	0,2	1,0	0,95	12,0	54	16	4	12 x DC	2			
1,0	0,2	1,0	0,95	16,0	60	16	4	16 x DC	2			
1,0	0,2	1,0	0,95	20,0	60	16	4	20 x DC	2			
1,0	0,3	1,0	0,95	2,0	50	16	4	2 x DC	2			31003
1,0	0,3	1,0	0,95	4,0	50	16	4	4 x DC	2			41003
1,0	0,3	1,0	0,95	6,0	50	16	4	6 x DC	2			51003
1,0	0,3	1,0	0,95	8,0	50	16	4	8 x DC	2			61003
1,0	0,3	1,0	0,95	10,0	50	16	4	10 x DC	2			
1,0	0,3	1,0	0,95	12,0	54	16	4	12 x DC	2			31003
1,0	0,3	1,0	0,95	16,0	60	16	4	16 x DC	2			41003
												51003

P												
M												
K												
N												
S												
H												
O												

BlueLine – Micro-torus cutter

The all-rounder for machining tempered steel

▲ T_x = maximum engagement depth

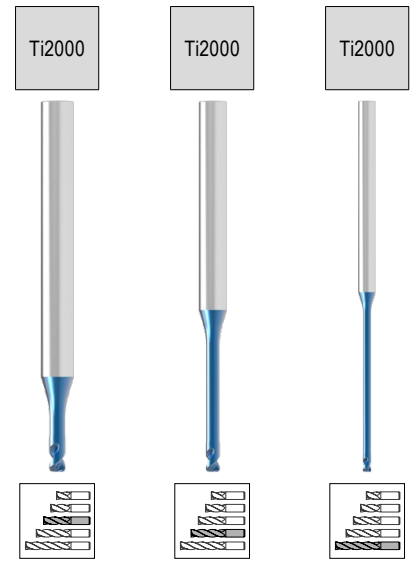
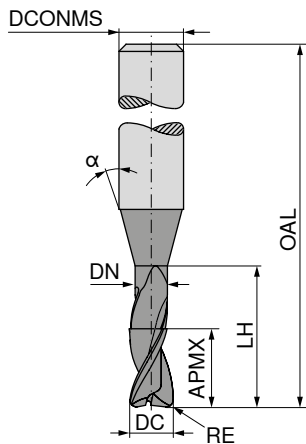
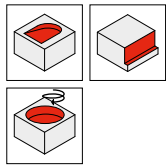
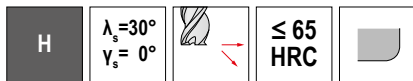

Factory standard Factory standard Factory standard

52 349 ... 52 350 ... 52 351 ...

DC _{-0,012}	RE _{±0,005}	APMX	DN	LH	OAL	α°	DCONMS _{HS}	T _x	ZEFP			
mm	mm	mm	mm	mm	mm		mm					
1,0	0,3	1,0	0,95	20,0	60	16	4	20 x DC	2			
1,2	0,2	1,2	1,14	6,0	50	16	4	5 x DC	2			
1,2	0,2	1,2	1,14	12,0	54	16	4	10 x DC	2		31202	
1,2	0,2	1,2	1,14	20,0	60	16	4	16,6 x DC	2			
1,2	0,3	1,2	1,14	6,0	50	16	4	5 x DC	2		31203	
1,2	0,3	1,2	1,14	12,0	54	16	4	10 x DC	2			31202
1,2	0,3	1,2	1,14	20,0	60	16	4	16,6 x DC	2			41202
1,5	0,2	1,5	1,44	4,0	50	16	4	2,6 x DC	2		31502	
1,5	0,2	1,5	1,44	6,0	50	16	4	4 x DC	2		41502	
1,5	0,2	1,5	1,44	8,0	50	16	4	5,3 x DC	2		51502	
1,5	0,2	1,5	1,44	10,0	50	16	4	6,6 x DC	2		61502	
1,5	0,2	1,5	1,44	12,0	54	16	4	8 x DC	2		71502	
1,5	0,2	1,5	1,44	16,0	54	16	4	10,6 x DC	2			31502
1,5	0,2	1,5	1,44	20,0	60	16	4	13,3 x DC	2			41502
1,5	0,3	1,5	1,44	4,0	50	16	4	2,6 x DC	2		31503	
1,5	0,3	1,5	1,44	6,0	50	16	4	4 x DC	2		41503	
1,5	0,3	1,5	1,44	8,0	50	16	4	5,3 x DC	2		51503	
1,5	0,3	1,5	1,44	10,0	50	16	4	6,6 x DC	2		61503	
1,5	0,3	1,5	1,44	12,0	54	16	4	8 x DC	2		71503	
1,5	0,3	1,5	1,44	16,0	54	16	4	10,6 x DC	2			31503
1,5	0,3	1,5	1,44	20,0	60	16	4	13,3 x DC	2			41503
1,5	0,5	1,5	1,44	4,0	50	16	4	2,6 x DC	2		31505	
1,5	0,5	1,5	1,44	6,0	50	16	4	4 x DC	2		41505	
1,5	0,5	1,5	1,44	8,0	50	16	4	5,3 x DC	2		51505	
1,5	0,5	1,5	1,44	10,0	50	16	4	6,6 x DC	2		61505	
1,5	0,5	1,5	1,44	12,0	54	16	4	8 x DC	2		71505	
1,5	0,5	1,5	1,44	16,0	54	16	4	10,6 x DC	2			31505
1,5	0,5	1,5	1,44	20,0	60	16	4	13,3 x DC	2			41505
2,0	0,1	2,0	1,91	4,0	50	16	4	2 x DC	2		32001	
2,0	0,1	2,0	1,91	6,0	50	16	4	3 x DC	2		42001	
2,0	0,1	2,0	1,91	8,0	50	16	4	4 x DC	2		52001	
2,0	0,1	2,0	1,91	10,0	50	16	4	5 x DC	2		62001	
2,0	0,1	2,0	1,91	12,0	54	16	4	6 x DC	2		72001	
2,0	0,1	2,0	1,91	16,0	54	16	4	8 x DC	2		82001	
2,0	0,1	2,0	1,91	20,0	60	16	4	10 x DC	2			32001
2,0	0,1	2,0	1,91	26,0	70	16	4	13 x DC	2			42001
2,0	0,2	2,0	1,91	4,0	50	16	4	2 x DC	2		32002	
2,0	0,2	2,0	1,91	6,0	50	16	4	3 x DC	2		42002	
2,0	0,2	2,0	1,91	8,0	50	16	4	4 x DC	2		52002	
2,0	0,2	2,0	1,91	10,0	50	16	4	5 x DC	2		62002	
2,0	0,2	2,0	1,91	12,0	54	16	4	6 x DC	2		72002	
2,0	0,2	2,0	1,91	16,0	54	16	4	8 x DC	2		82002	
2,0	0,2	2,0	1,91	20,0	60	16	4	10 x DC	2			32002
2,0	0,2	2,0	1,91	26,0	70	16	4	13 x DC	2			42002
2,0	0,3	2,0	1,91	4,0	50	16	4	2 x DC	2		32003	

P	•	•	•
M			
K			
N			
S			
H	•	•	•
O			

BlueLine – Micro-torus cutter

The all-rounder for machining tempered steel

▲ T_x = maximum engagement depth

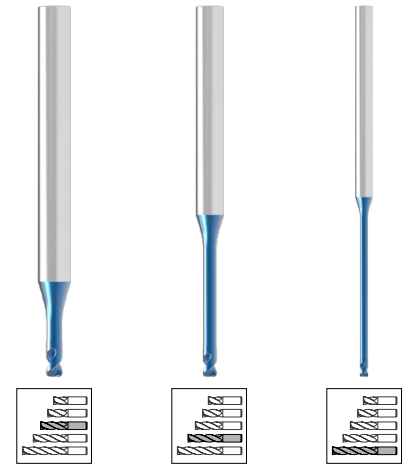
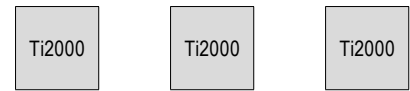
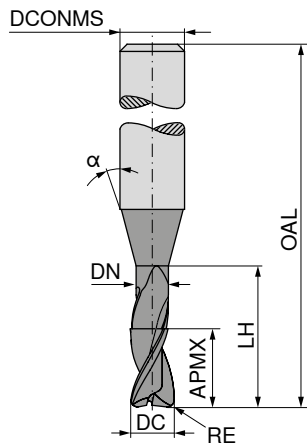
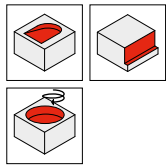
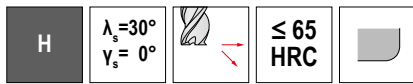

Factory standard Factory standard Factory standard



52 349 ... 52 350 ... 52 351 ...

DC mm	RE mm	APMX mm	DN mm	LH mm	OAL mm	α°	DCONMS _{HS} mm	T_x	ZEFP
2,0	0,3	2,0	1,91	6,0	50	16	4	3 x DC	2
2,0	0,3	2,0	1,91	8,0	50	16	4	4 x DC	2
2,0	0,3	2,0	1,91	10,0	50	16	4	5 x DC	2
2,0	0,3	2,0	1,91	12,0	54	16	4	6 x DC	2
2,0	0,3	2,0	1,91	16,0	54	16	4	8 x DC	2
2,0	0,3	2,0	1,91	20,0	60	16	4	10 x DC	2
2,0	0,3	2,0	1,91	26,0	70	16	4	13 x DC	2
2,0	0,5	2,0	1,91	4,0	50	16	4	2 x DC	2
2,0	0,5	2,0	1,91	6,0	50	16	4	3 x DC	2
2,0	0,5	2,0	1,91	8,0	50	16	4	4 x DC	2
2,0	0,5	2,0	1,91	10,0	50	16	4	5 x DC	2
2,0	0,5	2,0	1,91	12,0	54	16	4	6 x DC	2
2,0	0,5	2,0	1,91	16,0	54	16	4	8 x DC	2
2,0	0,5	2,0	1,91	20,0	60	16	4	10 x DC	2
2,0	0,5	2,0	1,91	26,0	70	16	4	13 x DC	2
2,5	0,3	2,5	2,41	10,0	50	16	4	4 x DC	2
2,5	0,3	2,5	2,41	12,0	60	16	4	4,8 x DC	2
2,5	0,3	2,5	2,41	30,0	70	16	4	12 x DC	2
2,5	0,5	2,5	2,41	10,0	50	16	4	4 x DC	2
2,5	0,5	2,5	2,41	12,0	60	16	4	4,8 x DC	2
2,5	0,5	2,5	2,41	30,0	70	16	4	12 x DC	2
3,0	0,3	3,0	2,92	10,0	50	16	4	3,3 x DC	2
3,0	0,3	3,0	2,92	12,0	50	16	4	4 x DC	2
3,0	0,3	3,0	2,92	30,0	70	16	4	10 x DC	2
3,0	0,5	3,0	2,92	10,0	50	16	4	3,3 x DC	2
3,0	0,5	3,0	2,92	12,0	50	16	4	4 x DC	2
3,0	0,5	3,0	2,92	30,0	70	16	4	10 x DC	2

P	•	•	•
M			
K			
N			
S			
H	•	•	•
O			

→ v_c/f_z Page 420+421

BlueLine – End milling cutter

The all-rounder for machining tempered steel

H
 $\lambda_s = 30^\circ$
 $\nu_s = 0^\circ$

 ≤ 65
HRC

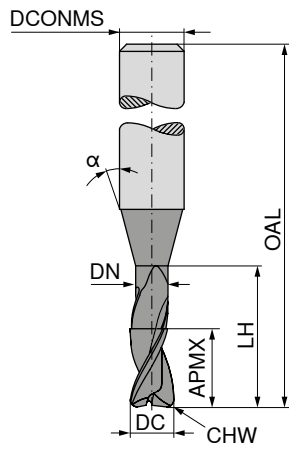
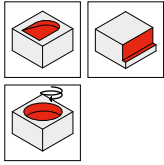

Ti2000



Factory standard



52 344 ...

DC _{es} mm	APMX mm	DN mm	LH mm	OAL mm	α°	DCONMS _{ts} mm	CHW mm	ZEFP
0,5	1,5			58	12	6	0,02	2
1,0	3,0			58	12	6	0,02	2
1,5	4,0			58	12	6	0,03	2
2,0	5,0	1,8	12	58	20	6	0,03	2
2,5	6,0	2,3	13	58	20	6	0,04	2
3,0	8,0	2,8	15	58	20	6	0,04	2
3,5	8,0	3,3	15	58	20	6	0,05	2
4,0	11,0	3,8	15	58	20	6	0,05	2
5,0	13,0	4,8	21	58	20	6	0,06	2
6,0	16,0	5,8	24	58		6	0,07	2
8,0	19,0	7,8	27	64		8	0,08	2
10,0	22,0	9,8	32	73		10	0,10	2
12,0	26,0	11,8	38	84		12	0,13	2
16,0	32,0	15,7	44	93		16	0,18	2
20,0	38,0	19,7	54	104		20	0,20	2

905
010
015
020
025
030
035
040
050
060
080
100
120
160
200

P	•
M	
K	
N	
S	
H	•
O	

→ v_c/f_z Page 424+425

BlueLine – End milling cutter with corner radius

The all-rounder for machining tempered steel

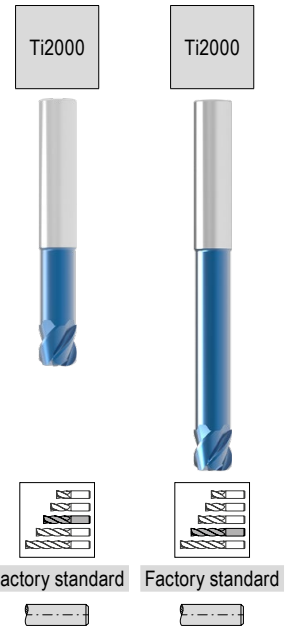
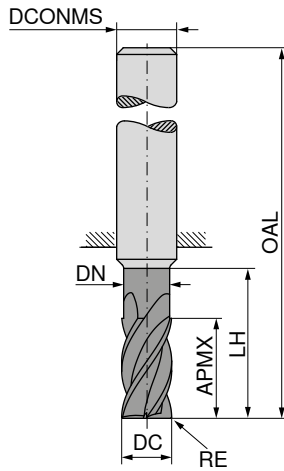
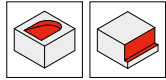
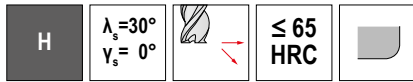

DC _{es} mm	RE _{±0,005} mm	APMX mm	DN mm	LH mm	OAL mm	DCONMS _{h5} mm	ZEFP
1	0,10	1,5	0,85	10	50	3	4
1	0,10	1,5	0,85	20	75	3	4
1	0,20	1,5	0,85	10	50	3	4
1	0,20	1,5	0,85	20	75	3	4
2	0,20	2,5	1,80	12	50	3	4
2	0,20	2,5	1,80	25	75	3	4
2	0,30	2,5	1,80	12	50	3	4
2	0,30	2,5	1,80	25	75	3	4
2	0,50	2,5	1,80	12	50	3	4
2	0,50	2,5	1,80	25	75	3	4
3	0,25	4,0	2,70	14	50	3	4
3	0,25	4,0	2,70	32	75	3	4
3	0,30	4,0	2,70	14	50	3	4
3	0,30	4,0	2,70	32	75	3	4
3	0,50	4,0	2,70	14	50	3	4
3	0,50	4,0	2,70	32	75	3	4
3	1,00	4,0	2,70	14	50	3	4
3	1,00	4,0	2,70	32	75	3	4
4	0,20	5,0	3,70	16	50	4	4
4	0,20	5,0	3,70	36	75	4	4
4	0,25	5,0	3,70	16	50	4	4
4	0,25	5,0	3,70	36	75	4	4
4	0,40	5,0	3,70	16	50	4	4
4	0,40	5,0	3,70	36	75	4	4
4	0,50	5,0	3,70	16	50	4	4
4	0,50	5,0	3,70	36	75	4	4
4	1,00	5,0	3,70	16	50	4	4
4	1,00	5,0	3,70	36	75	4	4
5	0,25	6,0	4,60	18	54	5	4
5	0,25	6,0	4,60	40	75	5	4
5	0,50	6,0	4,60	18	54	5	4
5	0,50	6,0	4,60	40	75	5	4
5	1,00	6,0	4,60	18	54	5	4
5	1,00	6,0	4,60	40	75	5	4
6	0,25	7,0	5,50	21	58	6	4
6	0,25	7,0	5,50	44	80	6	4
6	0,50	7,0	5,50	21	58	6	4
6	0,50	7,0	5,50	44	80	6	4
6	0,80	7,0	5,50	21	58	6	4
6	1,00	7,0	5,50	21	58	6	4
6	1,00	7,0	5,50	44	80	6	4
6	1,50	7,0	5,50	21	58	6	4
6	1,50	7,0	5,50	44	80	6	4
6	2,00	7,0	5,50	21	58	6	4
8	0,25	9,0	7,40	27	64	8	4

	52 353 ...	52 354 ...
P	•	•
M		
K		
N		
S		
H	•	•
O		

BlueLine – End milling cutter with corner radius

The all-rounder for machining tempered steel

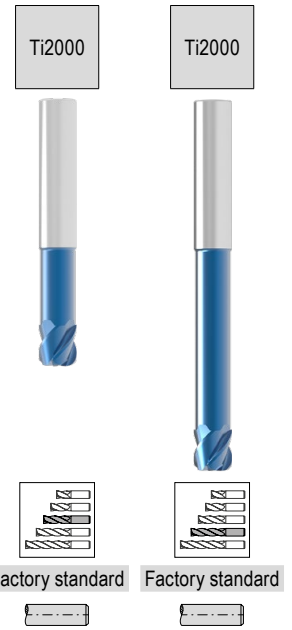
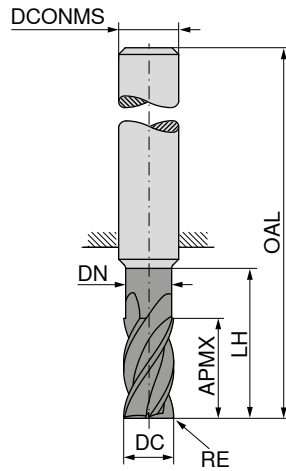
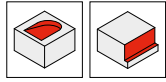
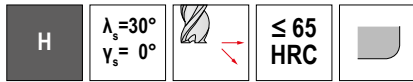

DC _{es}	RE _{±0,005}	APMX	DN	LH	OAL	DCONMS _{h5}	ZEFP	52 353 ...	52 354 ...
mm	mm	mm	mm	mm	mm	mm			
8	0,25	9,0	7,40	54	100	8	4		08002
8	0,50	9,0	7,40	27	64	8	4	08005	08005
8	0,50	9,0	7,40	54	100	8	4	08008	08008
8	0,80	9,0	7,40	27	64	8	4	08010	08010
8	0,80	9,0	7,40	54	100	8	4	08015	08015
8	1,00	9,0	7,40	27	64	8	4	08020	08020
8	1,00	9,0	7,40	54	100	8	4	08025	08025
8	1,50	9,0	7,40	27	64	8	4	08030	08030
8	1,50	9,0	7,40	54	100	8	4	10002	10002
8	2,00	9,0	7,40	27	64	8	4	10005	10005
8	2,00	9,0	7,40	54	100	8	4	10008	10008
8	2,50	9,0	7,40	27	64	8	4	10010	10010
8	2,50	9,0	7,40	54	100	8	4	10015	10015
8	3,00	9,0	7,40	27	64	8	4	10020	10020
8	3,00	9,0	7,40	54	100	8	4	10030	10030
10	0,25	11,0	9,20	32	73	10	4	10035	10035
10	0,25	11,0	9,20	60	100	10	4	12005	12005
10	0,50	11,0	9,20	32	73	10	4	12010	12010
10	0,50	11,0	9,20	60	100	10	4	12015	12015
10	0,80	11,0	9,20	32	73	10	4	12020	12020
10	0,80	11,0	9,20	60	100	10	4	12030	12030
10	1,00	11,0	9,20	32	73	10	4	16020	16020
10	1,00	11,0	9,20	60	100	10	4	16030	16030
10	1,50	11,0	9,20	32	73	10	4		16030
10	1,50	11,0	9,20	60	100	10	4		16030
10	2,00	11,0	9,20	32	73	10	4		16030
10	2,00	11,0	9,20	60	100	10	4		16030
10	3,00	11,0	9,20	32	73	10	4		16030
10	3,00	11,0	9,20	60	100	10	4		16030
10	3,50	11,0	9,20	32	73	10	4		16030
12	0,50	12,0	11,00	38	84	12	4		16030
12	0,50	12,0	11,00	75	120	12	4		16030
12	1,00	12,0	11,00	38	84	12	4		16030
12	1,00	12,0	11,00	75	120	12	4		16030
12	1,50	12,0	11,00	38	84	12	4		16030
12	1,50	12,0	11,00	75	120	12	4		16030
12	2,00	12,0	11,00	38	84	12	4		16030
12	2,00	12,0	11,00	75	120	12	4		16030
12	3,00	12,0	11,00	38	84	12	4		16030
12	3,00	12,0	11,00	75	120	12	4		16030
16	2,00	16,0	15,00	44	93	16	4		16030
16	2,00	16,0	15,00	92	150	16	4		16030
16	3,00	16,0	15,00	44	93	16	4		16030
16	3,00	16,0	15,00	92	150	16	4		16030

P	●	●
M		
K		
N		
S		
H	●	●
O		

→ v_c/f_z Page 426+427

BlueLine – End milling cutter with corner radius

The all-rounder for machining tempered steel

▲ With decreasing helix angle for reduced machining noise & vibration

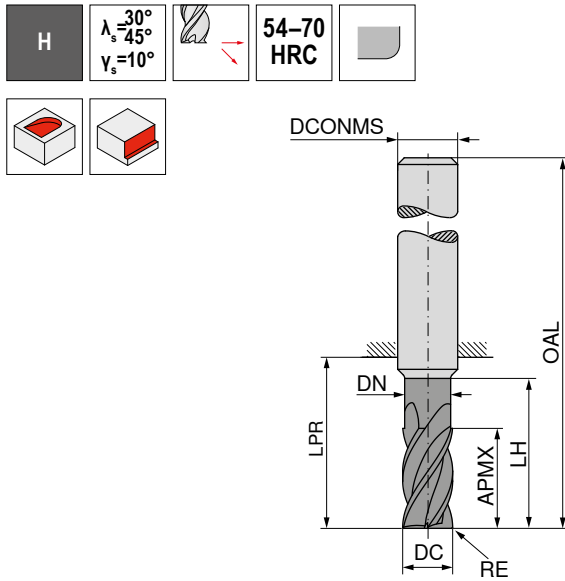

DC _{e8} mm	RE _{±0.01} mm	APMX mm	DN mm	LH mm	LPR mm	OAL mm	DCONMS _{h6} mm	ZEFP
3	0,3	4	2,7	14	22	50	3	4
3	0,5	4	2,7	14	22	50	3	4
3	1,0	4	2,7	14	22	50	3	4
4	0,4	5	3,7	16	22	50	4	4
4	0,5	5	3,7	16	22	50	4	4
4	1,0	5	3,7	16	22	50	4	4
5	0,5	6	4,6	18	26	54	5	4
5	1,0	6	4,6	18	26	54	5	4
6	0,5	7	5,5	21	21	57	6	6
6	1,0	7	5,5	21	21	57	6	6
6	1,5	7	5,5	21	21	57	6	6
8	0,5	9	7,4	27	27	63	8	6
8	1,0	9	7,4	27	27	63	8	6
8	1,5	9	7,4	27	27	63	8	6
8	2,0	9	7,4	27	27	63	8	6
10	0,5	11	9,2	32	32	72	10	6
10	1,0	11	9,2	32	32	72	10	6
10	1,5	11	9,2	32	32	72	10	6
10	2,0	11	9,2	32	32	72	10	6
12	0,5	12	11,0	38	38	83	12	6
12	1,0	12	11,0	38	38	83	12	6
12	1,5	12	11,0	38	38	83	12	6
12	2,0	12	11,0	38	38	83	12	6
16	1,0	16	15,0	44	45	93	16	6
16	2,0	16	15,0	44	45	93	16	6
20	1,0	20	18,5	50	54	104	20	6
20	2,5	20	18,5	50	54	104	20	6

52 140 ...	52 141 ...
031	
033	
034	
042	
043	
044	
053	
054	
063	063
064	064
065	065
083	083
084	084
085	085
086	086
103	103
104	104
105	105
106	106
123	123
124	124
125	125
126	126
161	161
163	163
201	201
204	204

P	○	○
M		
K		
N		
S		
H	●	●
O		

→ v_c/f_z Page 424+425

BlueLine – Finish milling cutter

The all-rounder for machining tempered steel

▲ With decreasing helix angle for reduced machining noise & vibration

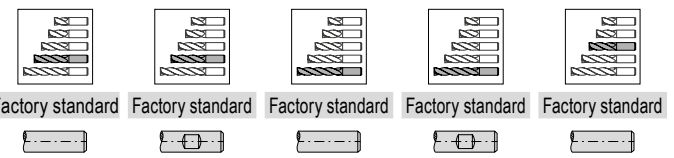
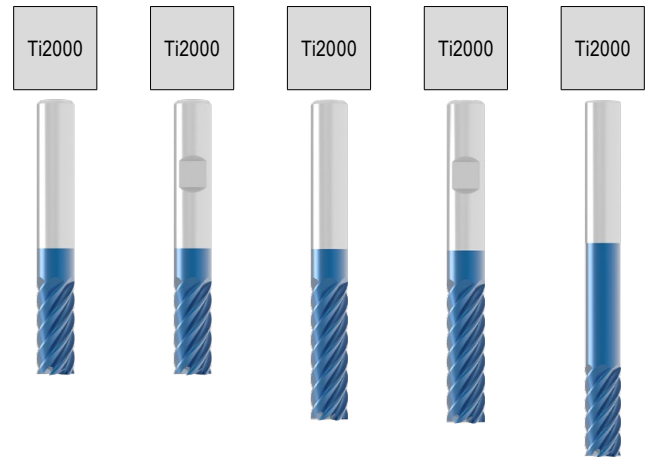
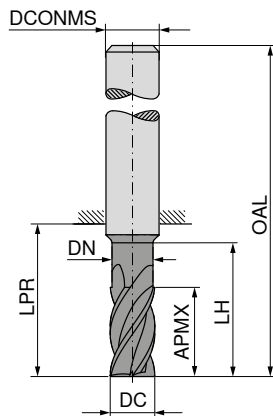
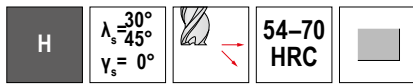

DC _{ø8} mm	APMX mm	LPR mm	DN mm	LH mm	OAL mm	DCONMS _{h6} mm	ZEFP
2	8	22			58	6	4
2	8	22	2,0	10	58	6	4
3	12	22			58	6	4
3	12	22	3,0	14	58	6	4
4	13	22			58	6	4
4	13	22	4,0	15	58	6	4
5	15	22			58	6	6
5	15	22	5,0	17	58	6	6
6	16	22			58	6	6
6	16	44	5,8	40	80	6	6
6	21	29			65	6	6
8	19	64	7,7	50	100	8	6
8	22	34			70	8	6
8	28	39			75	8	6
10	25	33			73	10	6
10	25	60	9,7	60	100	10	6
10	35	45			85	10	6
12	28	39			84	12	6
12	30	75	11,6	60	120	12	6
12	45	55			100	12	6
14	30	39			84	14	6
14	45	55			100	14	6
16	35	45			93	16	8
16	40	102	15,6	100	150	16	8
16	50	62			110	16	8
16	65	77			125	16	8
18	35	45			93	18	10
18	54	66			114	18	10
20	40	54			104	20	10
20	50	100	19,6	100	150	20	10
20	55	76			126	20	10
20	70	85			135	20	10

52 133 ...	52 134 ...	52 135 ...	52 136 ...	52 348 ...
	020	020		
	030	030		
	040	040		
	050	050		
	060	060		
			060	060
				080
	080	080		
			080	080
	100	100		
			100	100
	120	120		
			120	120
	140	140		
			140	140
	160	160		
			160	160
			161	161
	180	180		
			180	180
	200	200		
			200	200
			201	201
P	○	○	○	○
M				
K				
N				
S				
H	●	●	●	●
O				

→ v_c/f_z Page 424–426

BlueLine – Finish milling cutter with corner radius

The all-rounder for machining tempered steel

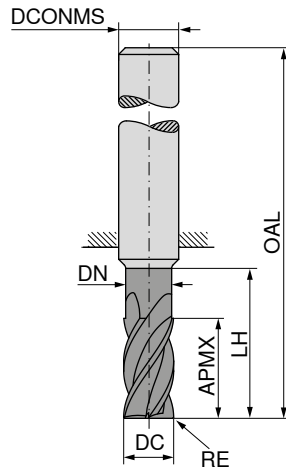
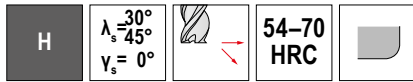

DC _{es} mm	RE _{+/-0,005} mm	APMX mm	DN mm	LH mm	OAL mm	DCONMS _{h6} mm	ZEPF
5	0,5	15	4,8	19	58	6	6
5	1,0	15	4,8	19	58	6	6
6	0,5	16	5,8	20	58	6	6
6	0,5	21	5,8	29	65	6	6
6	1,0	16	5,8	20	58	6	6
6	1,0	21	5,8	29	65	6	6
8	0,5	22	7,8	26	70	8	6
8	0,5	28	7,8	39	75	8	6
8	1,0	22	7,8	26	70	8	6
8	1,0	28	7,8	39	75	8	6
10	0,5	25	9,8	31	73	10	6
10	0,5	35	9,8	45	85	10	6
10	1,0	25	9,8	31	73	10	6
10	1,0	35	9,8	45	85	10	6
10	1,5	25	9,8	31	73	10	6
10	1,5	35	9,8	45	85	10	6
12	0,5	28	11,8	37	84	12	6
12	0,5	45	11,8	55	100	12	6
12	1,0	28	11,8	37	84	12	6
12	1,0	45	11,8	55	100	12	6
12	1,5	28	11,8	37	84	12	6
12	1,5	45	11,8	55	100	12	6
14	1,0	30	13,8	37	84	14	6
14	1,0	45	13,8	55	100	14	6
16	1,0	35	15,8	43	93	16	8
16	1,0	50	15,8	62	110	16	8
16	2,0	35	15,8	43	93	16	8
16	2,0	50	15,8	62	110	16	8
18	1,0	35	17,8	43	93	18	10
18	1,0	54	17,8	66	114	18	10
20	1,0	40	19,8	52	104	20	10
20	1,0	55	19,8	76	126	20	10
20	2,0	40	19,8	52	104	20	10
20	2,0	55	19,8	76	126	20	10

52 324 ...	52 325 ...
052	
053	
062	
	062
063	
	063
082	
	082
083	
	083
102	
	102
103	
	103
104	
	104
122	
	122
123	
	123
124	
	124
143	
	143
163	
	163
165	
	165
183	
	183
203	
	203
205	
	205

P	○	○
M		
K		
N		
S		
H	●	●
O		

→ v_c/f_z Page 424+425

BlueLine – Ball Nosed Cutter

The all-rounder for machining tempered steel

▲ Radius accuracy: ± 0,005 mm

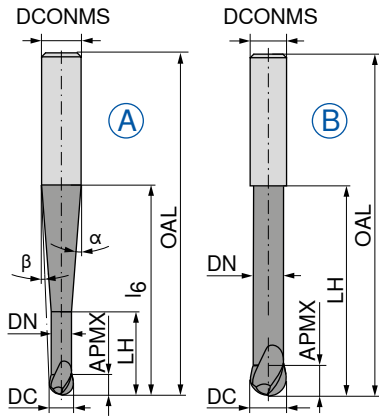
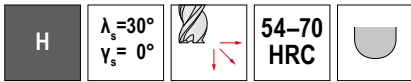

Ti2000



Factory standard



52 302 ...

DC mm	APMX mm	DN mm	LH mm	l ₆ mm	OAL mm	α°	β°	DCONMS _{HS} mm	ZEFP	Fig.	
1,0	1,00	0,95	10	16,5	57	15	9	6	2	A	010
1,5	1,25	1,40	12	18,0	57	15	7,5	6	2	A	015
2,0	1,50	1,90	16	20,0	57	15	6	6	2	A	020
3,0	2,00	2,90	20	34,5	80	15	2,5	6	2	A	030
4,0	2,50	3,90	22	35,0	80	15	2	6	2	A	040
5,0	3,00	4,90	25	35,0	80	15	1	6	2	A	050
6,0	3,50	5,90	29	80	80			6	2	B	060

P	○
M	
K	
N	
S	
H	●
O	

→ v_c/f_z Page 428+429

BlueLine – Ball Nosed Cutter

The all-rounder for machining tempered steel

- ▲ Radius accuracy: ± 0.005 mm for $\varnothing \leq 6.0$ mm / ± 0.01 mm for $\varnothing > 6.0$ mm
- ▲ for $\varnothing \leq 5.0$ mm, angle tolerance α and β : $\pm 0.5^\circ$

H

$\lambda_s = 30^\circ$
 $\nu_s = 0^\circ$

54-70
HRC

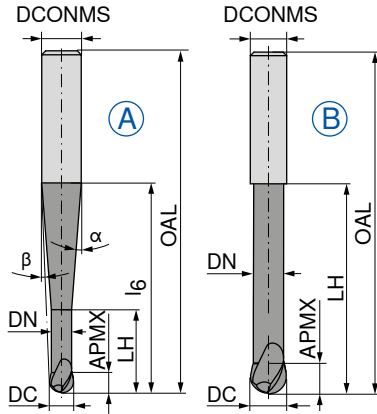

Ti2000



Factory standard



52 303 ...

DC mm	DC Tol.	APMX mm	DN mm	LH mm	l ₆ mm	OAL mm	α°	β°	DCONMS _{h5} mm	ZEFP	Fig.	
0,5	$\pm 0,01$	1,0	0,45	2,0	20	57	10	8,5	6	2	A	005
1,0	$\pm 0,01$	2,0	0,95	4,0	20	57	10	8	6	2	A	010
1,5	$\pm 0,01$	2,5	1,40	7,5	20	57	12,5	7	6	2	A	015
2,0	$\pm 0,01$	3,0	1,80	8,0	20	57	12	6,5	6	2	A	020
3,0	$\pm 0,01$	3,5	2,80	10,0	20	57	11,5	5	6	2	A	030
4,0	$\pm 0,01$	4,0	3,80	12,0	20	57	11	3,5	6	2	A	040
5,0	$\pm 0,01$	5,0	4,70	14,0	20	57	10	2	6	2	A	050
6,0	$\pm 0,01$	6,0	5,60	20,0		57			6	2	B	060
8,0	$\pm 0,02$	7,0	7,60	25,0		63			8	2	B	080
10,0	$\pm 0,02$	8,0	9,60	30,0		72			10	2	B	100
12,0	$\pm 0,02$	10,0	11,50	35,0		83			12	2	B	120
12,0	$\pm 0,02$	10,0	11,50	35,0	40	92	35	3,5	16	2	A	121
16,0	$\pm 0,02$	12,0	15,50	40,0		92			16	2	B	160

P

M

K

N

S

H

O

○

●

→ v_c/f_z Page 428+429

BlueLine – Ball Nosed Cutter

The all-rounder for machining tempered steel

▲ Radius accuracy: ± 0,005 mm

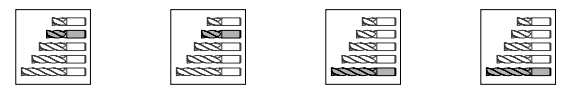
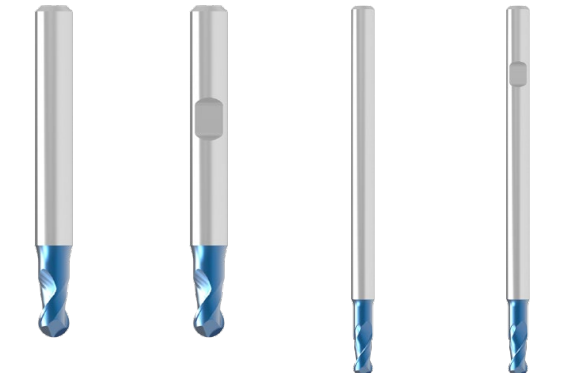
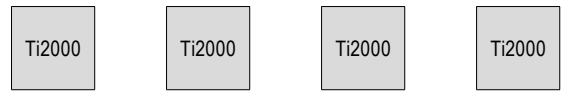
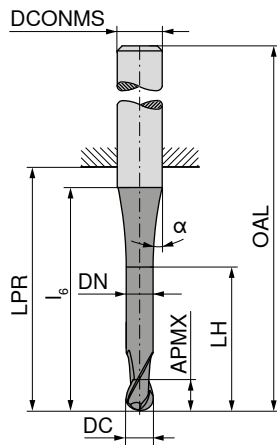
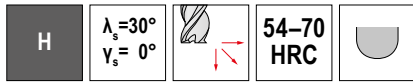

Factory standard Factory standard Factory standard Factory standard

DC _{FB} mm	APMX mm	DN mm	LH mm	l ₆ mm	LPR mm	OAL mm	DCONMS _{h6} mm	α° _{±0,5}	ZEFP
0,10	0,2			11	10	38	3	8	2
0,15	0,3			12	10	38	3	7,5	2
0,20	0,4			12	10	38	3	7	2
0,25	0,5	0,20	0,8	12	10	38	3	7	2
0,30	1,0	0,25	1,3	12	10	38	3	7	2
0,35	1,0	0,30	1,3	12	10	38	3	7	2
0,40	1,0	0,35	1,3	12	10	38	3	7	2
0,50	1,5	0,40	2,0	12	10	38	3	7,5	2
0,50	1,5	0,40	2,0	17	18	54	6	10,5	2
0,50	1,5	0,40	2,0	13	47	75	3	7	2
0,50	1,5	0,40	2,0	17	44	80	6	10,5	2
0,60	1,5	0,50	2,0	12	10	38	3	7	2
0,70	2,0	0,60	2,5	12	10	38	3	7,5	2
0,80	2,0	0,70	2,5	13	10	38	3	7,5	2
0,90	2,5	0,80	3,5	13	10	38	3	7	2
1,00	2,0	0,90	3,0	13	22	50	3	6	2
1,00	2,0	0,90	3,0	18	18	54	6	9,5	2
1,00	3,0	0,90	4,0	14	47	75	3	6	2
1,00	3,0	0,90	4,0	19	44	80	6	9,5	2
1,10	3,0	1,00	4,0	13	22	50	3	7	2
1,20	3,0	1,10	4,0	13	22	50	3	7	2
1,40	3,0	1,30	4,0	14	22	50	3	5	2
1,50	3,0	1,40	4,0	13	22	50	3	5,5	2
1,50	3,0	1,40	4,0	18	18	54	6	9	2
1,50	4,0	1,40	6,0	13	47	75	3	7	2
1,50	4,0	1,40	6,0	19	44	80	6	10	2
1,60	4,0	1,50	5,0	13	22	50	3	5	2
1,80	4,0	1,70	5,0	13	22	50	3	5	2
2,00	4,0	1,90	5,5	12	22	50	3	5	2
2,00	4,0	1,90	5,5	18	18	54	6	9	2
2,00	6,0	1,90	8,0	12	47	75	3	8	2
2,00	6,0	1,90	8,0	20	44	80	6	11	2
2,50	5,0	2,30	6,5	10	22	50	3	7	2
2,50	5,0	2,30	6,5	17	18	54	6	10	2
2,50	8,0	2,30	10,0	14	47	75	3	5,5	2
2,50	8,0	2,30	10,0	20	44	80	6	10	2
3,00	6,0	2,80	8,0		22	50	3		2
3,00	6,0	2,80	8,0	18	18	54	6	9	2

52 256 ...	52 257 ...	52 258 ...	52 259 ...
910			
915			
920			
925			
930			
935			
940			
950			
005	005		
		950	
		005	005
960			
970			
980			
990			
011			
106	010		
		011	
		010	010
911			
012			
014			
016			
156	015		
		016	
		015	015
916			
018			
021			
206	020		
		021	
		020	020
025			
026	026		
		026	
		025	025
031			
306	030		

P	○	○	○	○
M				
K				
N				
S				
H	●	●	●	●
O				

BlueLine – Ball Nosed Cutter

The all-rounder for machining tempered steel

▲ Radius accuracy: ± 0,005 mm

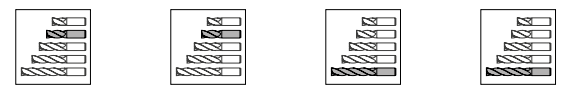
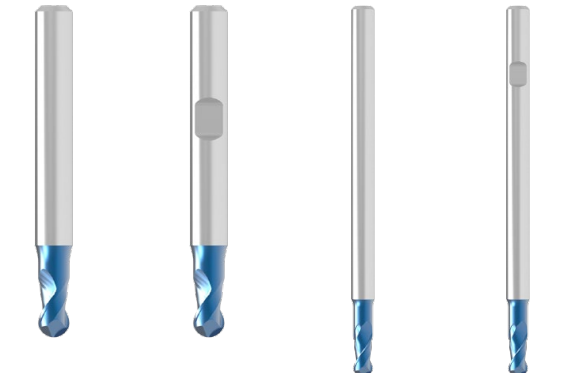
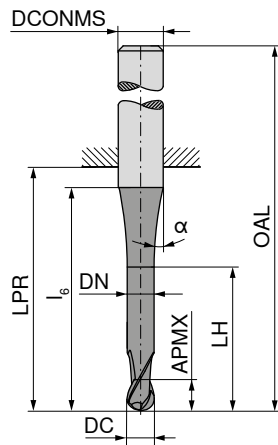
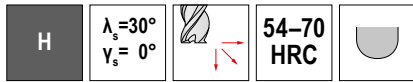

Factory standard Factory standard Factory standard Factory standard



52 256 ... 52 257 ... 52 258 ... 52 259 ...

DC _{FB} mm	APMX mm	DN mm	LH mm	l ₆ mm	LPR mm	OAL mm	DCONMS _{FB} mm	α° _{±0.5}	ZEFP
3,00	10,0	2,80	13,0		47	75	3		2
3,00	10,0	2,80	15,0	23	44	80	6	11	2
4,00	7,0	3,80	10,0	18	18	54	6	11	2
4,00	7,0	3,80	10,0		26	54	4		2
4,00	13,0	3,80	20,0		47	75	4		2
4,00	13,0	3,80	18,0	23	44	80	6	12,5	2
5,00	8,0	4,80	11,0	15	18	54	6	8	2
5,00	8,0	4,80	11,0		26	54	5		2
5,00	14,0	4,80	19,0		47	75	5		2
5,00	14,0	4,80	19,0	21	64	100	6	13	2
6,00	10,0	5,80	15,0		18	54	6		2
6,00	16,0	5,80	25,0		64	100	6		2
8,00	12,0	7,80	17,0		23	59	8		2
8,00	22,0	7,80	35,0		64	100	8		2
10,00	13,0	9,80	18,0		27	67	10		2
10,00	25,0	9,80	40,0		60	100	10		2
12,00	16,0	11,90	21,0		28	73	12		2
12,00	26,0	11,80	40,0		55	100	12		2
14,00	16,0	13,80	21,0		30	75	14		2
14,00	26,0	13,80	40,0		55	100	14		2
16,00	20,0	15,80	25,0		35	83	16		2
16,00	30,0	15,80	50,0		102	150	16		2
20,00	25,0	19,80	30,0		43	93	20		2
20,00	40,0	19,80	60,0		100	150	20		2

P	○	○	○	○
M				
K				
N				
S				
H	●	●	●	●
O				

→ v_c/f_z Page 428+429

BlueLine – Ball Nosed Cutter

The all-rounder for machining tempered steel

▲ Radius accuracy: ± 0,005 mm

H

$\lambda_s = 30^\circ$
 $\gamma_s = 0^\circ$

≤ 65
HRC

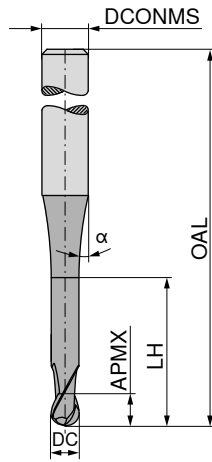

Ti2000



Factory standard



52 355 ...

DC _{FB} mm	APMX mm	LH mm	OAL mm	α°	DCONMS ₁₅ mm	ZEFP
3	8	11	65	12	6	3
4	8	11	75	12	6	3
5	10	13	75	12	6	3
6	12		100		6	3
8	14		100		8	3
10	18		100		10	3
12	22		120		12	3

030
040
050
060
080
100
120

P		●
M		
K		
N		
S		
H		●
O		

→ v_c/f_z Page 428

BlueLine – Ball Nosed Cutter

The all-rounder for machining tempered steel

▲ Radius accuracy: ± 0,005 mm

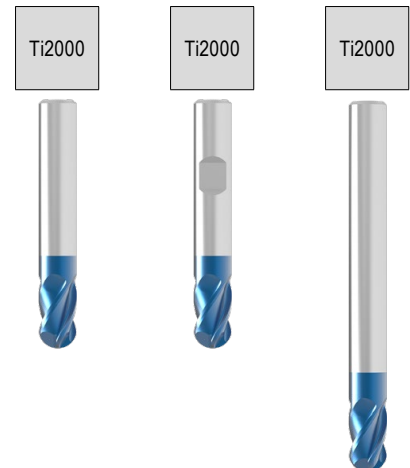
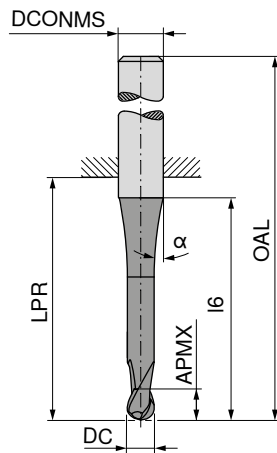
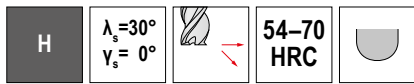

Factory standard



Factory standard



Factory standard



DC _{R8} mm	APMX mm	l ₆ mm	LPR mm	OAL mm	α° ±1	DCONMS _{H6} mm	ZEFP
2,0	4	10,0	22	50	8	3	4
2,0	4	16,0	18	54	12	6	4
2,0	4	10,0	47	75	8	3	4
2,0	4	16,0	44	80	12	6	4
2,5	5	16,0	18	54	12	6	4
2,5	5	16,0	44	80	12	6	4
3,0	5		22	50		3	4
3,0	5	14,0	18	54	12	6	4
3,0	5		47	75		3	4
3,0	5	14,0	44	80	12	6	4
4,0	8	15,0	18	54	12	6	4
4,0	8		26	54		4	4
4,0	8		47	75		4	4
4,0	8	15,0	44	80	12	6	4
5,0	9	13,5	18	54	12	6	4
5,0	9		26	54		5	4
5,0	9		47	75		5	4
5,0	9	13,5	64	100	12	6	4
6,0	10		18	54		6	4
6,0	10		64	100		6	4
7,0	12	15,0	23	59	12	8	4
8,0	12		23	59		8	4
8,0	12		64	100		8	4
9,0	14	17,0	27	67	12	10	4
10,0	14	16,0	27	67		10	4
10,0	14		60	100		10	4
12,0	16		29	74		12	4
12,0	16		55	100		12	4
14,0	18		30	75		14	4
14,0	18	20,0	55	100		14	4
16,0	22	24,0	35	83		16	4
16,0	22	24,0	102	150		16	4
20,0	26	28,0	43	93		20	4
20,0	26	28,0	100	150		20	4

52 404 ...	52 405 ...	52 404 ...
020		
021	021	
		022
		023
025	025	
		026
030		
031	031	
		032
		033
041	041	
040		
		042
		043
051	051	
050		
		052
		053
060	060	
		062
070	070	
080	080	
		082
090	090	
100	100	
		102
120	120	
		122
140	140	
		142
160	160	
		162
200	200	
		202

P	○	○	○
M			
K			
N			
S			
H	●	●	●
O			

→ v_c/f_z Page 428+429

BlueLine – Torus Cutter

The all-rounder for machining tempered steel

▲ Radius accuracy: ± 0,005 mm for Ø ≤ 6,0 mm / ± 0,01 mm for Ø > 6,0 mm

▲ or Ø ≤ 5.0 mm, angle tolerance α and β: ± 0.5 °

H

$\lambda_s = 30^\circ$
 $\gamma_s = 0^\circ$

54-70
HRC

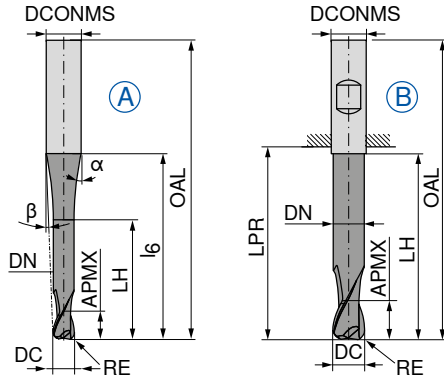

LPR with Shank DIN 6535 HB

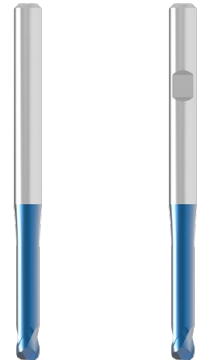
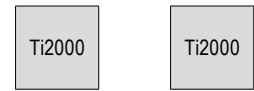

Factory standard



Factory standard



52 305 ...

52 305 ...

DC ±0,01 mm	RE mm	APMX mm	DN mm	LH mm	LPR mm	l ₆ mm	OAL mm	α° ±0,5	β°	DCONMS _{HS} mm	ZEFP	Fig.
1,0	0,2	1,00	0,95	10	21	16,5	57	23	9	6	2	A
1,5	0,3	1,25	1,40	12	21	18,0	57	21	7,5	6	2	A
2,0	0,4	1,50	1,90	16	21	20,0	57	25	6	6	2	A
3,0	0,5	2,00	2,90	20	44	34,5	80	6	2,5	6	2	A
4,0	0,6	2,50	3,90	22	44	35,0	80	4,5	2	6	2	A
5,0	0,8	3,00	4,90	25	44	35,0	80	3,5	1	6	2	A
6,0	1,0	3,50	5,90	29	44		80			6	2	B

010	
015	
020	
030	
040	
050	
	060

P		○	○
M			
K			
N			
S			
H		●	●
O			

→ v_c/f_z Page 430+431

BlueLine – Torus Cutter

The all-rounder for machining tempered steel

H

$\lambda_s = 30^\circ$
 $\gamma_s = 0^\circ$

≤ 65
HRC

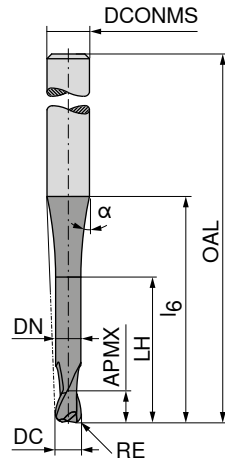

Ti2000



Factory standard



52 361 ...

DC _{e8} mm	RE _{±0.01} mm	APMX mm	DN mm	LH mm	l ₆ mm	OAL mm	α°	DCONMS _{h5} mm	ZEFP	
0,8	0,08	1,0	0,75	1,6	27	75	1,5	3	2	90801
1,0	0,10	1,2	0,95	2,0	27	75	1,5	3	2	31001
1,0	0,25	2,0	0,85	4,0	40	80	1,5	6	2	01002
1,2	0,12	1,4	1,15	2,4	27	75	1,5	3	2	31201
1,5	0,15	1,8	1,45	3,0	27	75	1,5	3	2	31501
2,0	0,20	2,4	1,95	4,0	27	75	1,5	3	2	32002
2,0	0,50	2,0	1,80	8,0	40	80	1,5	6	2	02005
3,0	0,30	3,6	2,95	6,0	27	75	1,5	4	2	43003
3,0	0,50	2,0	2,80	12,0	40	80	1,5	6	2	03005
3,0	1,00	2,0	2,80	12,0	40	80	1,5	6	2	03010
4,0	1,00	3,0	3,80	16,0	40	80	1,5	6	2	04010
6,0	1,00	4,0	5,80	25,0	50	100	1,5	8	2	06010
6,0	2,00	4,0	5,80	25,0	50	100	1,5	8	2	06020
8,0	1,00	4,0	7,80	32,0	60	120	1,5	10	2	08010
8,0	2,00	4,0	7,80	32,0	60	120	1,5	10	2	08020
10,0	1,50	6,0	9,80	40,0	80	160	1,5	12	2	10015
12,0	1,50	8,0	11,80	50,0	100	200	1,5	16	2	12015

P	○
M	
K	
N	
S	
H	●
O	

→ v_c/f_z Page 430+431

BlueLine – NC deburring cutter

The all-rounder for machining tempered steel

▲ 52 562 ... / 52 563 ... – Point angle $\alpha = 60^\circ$

▲ 52 560 ... / 52 561 ... – Point angle $\alpha = 90^\circ$

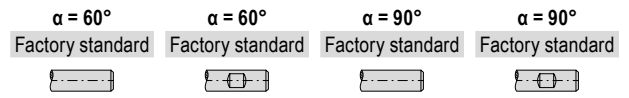
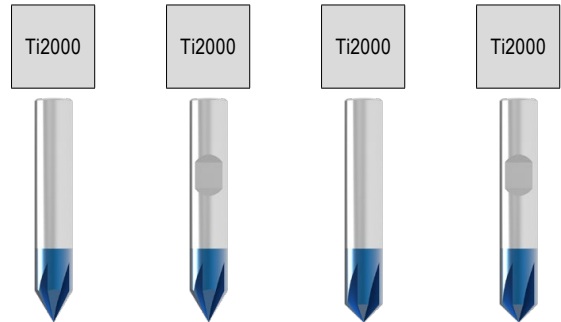
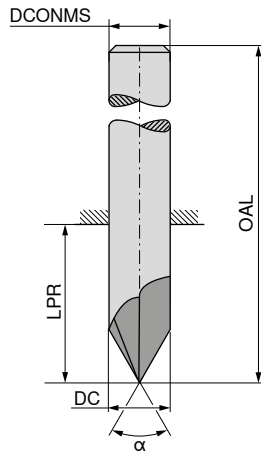
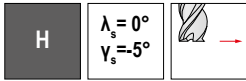

DC mm	OAL mm	LPR mm	DCONMS mm	ZEFP	52 562 ...	52 563 ...	52 560 ...	52 561 ...
4	50	22	4	5	04000		04000	
6	57	21	6	6	06000	06000	06000	06000
8	63	27	8	6	08000	08000	08000	08000
10	72	32	10	6	10000	10000	10000	10000
12	83	38	12	6	12000	12000	12000	12000
16	92	44	16	8	16000	16000	16000	16000

P	•	•	•	•
M				
K				
N				
S				
H	•	•	•	•
O				

→ v_c/f_z Page 419

Micro-end milling cutter

The universal milling cutter for micro-cutting

▲ T_x = maximum engagement depth

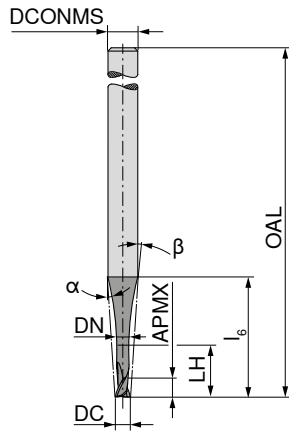
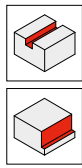
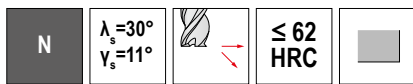

DC	APMX	DN	LH	l ₆	OAL	α°	β°	DCONMS _{HS}	T _x	ZEFP	52 802 ...	52 802 ...
mm	mm	mm	mm	mm	mm			mm				
0,2	0,12	0,16	0,44	5,7	38	15	14	3	2,2 x DC	2	021	
0,2	0,20	0,16	1,00	6,4	38	15	13	3	5 x DC	2	023	
0,2	0,20	0,16	2,00	9,2	38	15	9	3	10 x DC	2	025	
0,2	0,20	0,16	0,44	5,7	43	15	14	3	2,2 x DC	2		022
0,2	0,20	0,16	1,00	6,4	43	15	13	3	5 x DC	2		024
0,2	0,20	0,16	2,00	9,2	43	15	9	3	10 x DC	2		026
0,3	0,18	0,24	0,66	5,8	38	16,5	14	3	2,2 x DC	2	03100	
0,3	0,30	0,24	1,50	6,9	38	16	11,5	3	5 x DC	2	03300	
0,3	0,30	0,24	3,00	9,7	38	13,5	8,5	3	10 x DC	2	03500	
0,4	0,24	0,32	0,88	5,8	38	16,5	13,5	3	2,2 x DC	2	04100	
0,4	0,40	0,32	2,00	7,4	38	15,5	10,5	3	5 x DC	2	04300	
0,4	0,40	0,32	4,00	10,2	38	14	8	3	10 x DC	2	04500	
0,5	0,30	0,40	1,10	5,8	38	15	13	3	2,2 x DC	2	051	
0,5	0,50	0,40	2,50	7,8	38	15	10	3	5 x DC	2	053	
0,5	0,50	0,40	5,00	10,7	38	13	7	3	10 x DC	2	055	
0,5	0,50	0,40	1,10	5,8	43	15	13	3	2,2 x DC	2		052
0,5	0,50	0,40	2,50	7,8	43	15	10	3	5 x DC	2		054
0,5	0,50	0,40	5,00	14,5	43	13	5	3	10 x DC	2		056
0,6	0,36	0,48	1,32	5,9	38	16,5	12	3	2,2 x DC	2	06100	
0,6	0,60	0,48	3,00	8,3	38	15	9	3	5 x DC	2	06300	
0,6	0,60	0,48	6,00	11,6	38	14	6,5	3	10 x DC	2	06500	
0,7	0,42	0,56	1,54	5,9	38	16,5	11,5	3	2,2 x DC	2	07100	
0,7	0,70	0,56	3,50	8,8	38	14,5	8	3	5 x DC	2	07300	
0,7	0,70	0,56	7,00	12,5	38	14	6	3	10 x DC	2	07500	
0,8	0,48	0,64	1,76	5,9	38	15	11	3	2,2 x DC	2	081	
0,8	0,80	0,64	4,00	9,0	38	15	7	3	5 x DC	2	083	
0,8	0,80	0,64	8,00	13,5	38	12	5	3	10 x DC	2	085	
0,8	0,80	0,64	1,76	5,9	43	15	11	3	2,2 x DC	2		082
0,8	0,80	0,64	4,00	9,0	43	15	7	3	5 x DC	2		084
0,8	0,80	0,64	8,00	15,5	43	9,8	5	3	10 x DC	2		086
0,9	0,54	0,72	1,98	5,9	38	17	10,5	3	2,2 x DC	2	09100	
0,9	0,90	0,72	4,50	9,5	38	14	7	3	5 x DC	2	09300	
0,9	0,90	0,72	9,00	14,4	38	13	5	3	10 x DC	2	09500	
1,0	0,60	0,80	2,20	5,9	38	15	10	3	2,2 x DC	2	101	
1,0	1,00	0,80	2,20	5,9	43	15	10	3	2,2 x DC	2		102
1,0	1,00	0,80	5,00	9,7	43	15	6	3	5 x DC	2	103	
1,0	1,00	0,80	10,00	15,3	43	11	4	3	10 x DC	2	105	
1,0	1,00	0,80	5,00	9,7	50	15	6	3	5 x DC	2		104
1,0	1,00	0,80	10,00	20,6	50	8,5	3	3	10 x DC	2		106
1,1	0,66	0,88	2,42	6,0	38	17	9,5	3	2,2 x DC	2	11100	
1,1	1,10	0,88	5,50	10,0	43	14	6	3	5 x DC	2	11300	
P											●	●
M											●	●
K											●	●
N											●	●
S											●	●
H											○	○
O											○	○

Micro-end milling cutter

The universal milling cutter for micro-cutting

▲ T_x = maximum engagement depth

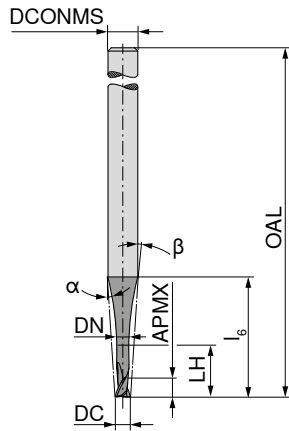
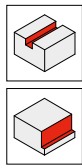
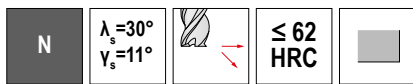

DC	APMX	DN	LH	l ₆	OAL	α°	β°	DCONMS _{HS}	T _x	ZEFP	52 802 ...	52 802 ...
mm	mm	mm	mm	mm	mm			mm				
1,1	1,10	0,88	11,00	15,9	43	13	4	3	10 x DC	2	11500	
1,2	0,72	0,96	2,64	6,0	38	17	9	3	2,2 x DC	2	12100	
1,2	1,20	0,96	6,00	10,5	43	13,5	5,5	3	5 x DC	2	12300	
1,2	1,20	0,96	12,00	16,5	43	13,5	4	3	10 x DC	2	12500	
1,3	0,78	1,04	2,86	6,0	38	17	8,5	3	2,2 x DC	2	13100	
1,3	1,30	1,04	6,50	11,0	43	12,5	5	3	5 x DC	2	13300	
1,3	1,30	1,04	13,00	17,1	43	14	3,5	3	10 x DC	2	13500	
1,4	0,84	1,12	3,08	6,1	38	17	8	3	2,2 x DC	2	14100	
1,4	1,40	1,12	7,00	11,5	43	12	4,5	3	5 x DC	2	14300	
1,4	1,40	1,12	14,00	17,6	43	15	3,5	3	10 x DC	2	14500	
1,5	0,90	1,20	3,30	6,1	38	15	8	3	2,2 x DC	2	151	
1,5	1,50	1,20	3,30	6,1	43	15	8	3	2,2 x DC	2		152
1,5	1,50	1,20	7,50	11,8	43	14	4	3	5 x DC	2	153	
1,5	1,50	1,20	15,00	18,1	43	14,6	3	3	10 x DC	2	155	
1,5	1,50	1,20	7,50	11,8	50	14	4	3	5 x DC	2		154
1,5	1,50	1,20	15,00	22,0	50	6,2	2	3	10 x DC	2		156
1,6	0,96	1,28	3,52	6,2	38	16,5	7	3	2,2 x DC	2	16100	
1,6	1,60	1,28	8,00	12,0	43	12	4	3	5 x DC	2	16300	
1,6	1,60	1,28	16,00	18,7	43	17	3	3	10 x DC	2	16500	
1,7	1,02	1,36	3,74	6,2	38	17	6,5	3	2,2 x DC	2	17100	
1,7	1,70	1,36	8,50	12,5	43	11	3,5	3	5 x DC	2	17300	
1,7	1,70	1,36	17,00	19,3	43	18,5	2,5	3	10 x DC	2	17500	
1,8	1,08	1,44	3,96	6,2	38	15	6	3	2,2 x DC	2	181	
1,8	1,80	1,44	3,96	6,2	43	15	6	3	2,2 x DC	2		182
1,8	1,80	1,44	9,00	12,9	43	12	3	3	5 x DC	2	183	
1,8	1,80	1,44	18,00	20,0	43	19,8	2	3	10 x DC	2	185	
1,8	1,80	1,44	9,00	12,9	50	12	3	3	5 x DC	2		184
1,8	1,80	1,44	18,00	22,0	50	5,3	2	3	10 x DC	2		186
1,9	1,14	1,52	4,18	6,2	38	17,5	5,5	3	2,2 x DC	2	19100	
1,9	1,90	1,52	9,50	13,2	43	10	3	3	5 x DC	2	19300	
1,9	1,90	1,52	19,00	20,5	43	23,5	2,5	3	10 x DC	2	19500	
2,0	1,20	1,60	4,40	11,9	50	15	10	6	2,2 x DC	2	201	
2,0	2,00	1,60	10,00	19,7	50	15	6	6	5 x DC	2	203	
2,0	2,00	1,60	20,00	25,0	50	22,1	5	6	10 x DC	2	205	
2,0	2,00	1,60	4,40	11,9	57	15	10	6	2,2 x DC	2		202
2,0	2,00	1,60	10,00	19,7	57	15	6	6	5 x DC	2		204
2,0	2,00	1,60	20,00	29,0	57	7,8	4	6	10 x DC	2		206

P	●	●
M	●	●
K	●	●
N	●	●
S	●	●
H	○	○
O	○	○

→ v_c/f_z Page 432–439

Micro-ball nosed cutter

The universal milling cutter for micro-cutting

▲ T_x = maximum engagement depth

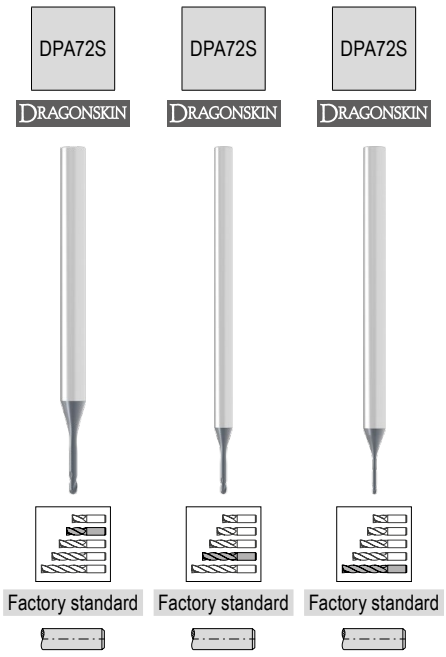
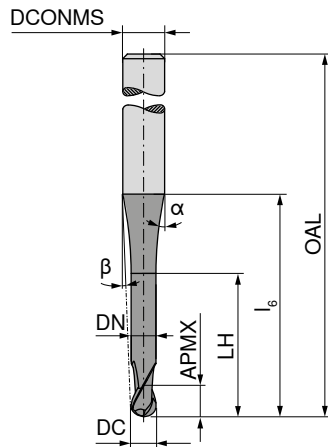
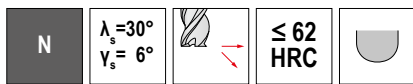

DC $\pm 0,01$ mm	APMX mm	DN mm	LH mm	l_6 mm	OAL mm	α°	β°	DCONMS n_5 mm	T_x	ZEFP
0,2	0,12	0,16	0,44	5,7	38	15	14	3	2,2 x DC	2
0,2	0,20	0,16	1,00	6,4	38	15	13	3	5 x DC	2
0,2	0,20	0,16	2,00	9,2	38	15	9	3	10 x DC	2
0,2	0,12	0,16	0,44	5,7	50	15	14	3	2,2 x DC	2
0,2	0,20	0,16	1,00	6,4	50	15	13	3	5 x DC	2
0,2	0,20	0,16	2,00	9,2	50	15	9	3	10 x DC	2
0,2	0,12	0,16	0,44	11,3	80	15	15	6	2,2 x DC	2
0,2	0,20	0,16	1,00	12,0	80	15	14	6	5 x DC	2
0,2	0,20	0,16	2,00	14,8	80	15	12	6	10 x DC	2
0,3	0,18	0,24	0,66	5,8	38	16,5	14	3	2,2 x DC	2
0,3	0,30	0,24	1,50	6,9	38	16	11,5	3	5 x DC	2
0,3	0,30	0,24	3,00	9,7	38	13,5	8,5	3	10 x DC	2
0,4	0,24	0,32	0,88	5,8	38	16,5	13	3	2,2 x DC	2
0,4	0,40	0,32	2,00	7,4	38	15,5	10,5	3	5 x DC	2
0,4	0,40	0,32	4,00	10,2	38	14	8	3	10 x DC	2
0,5	0,30	0,40	1,10	5,8	38	15	13	3	2,2 x DC	2
0,5	0,50	0,40	2,50	7,8	38	15	10	3	5 x DC	2
0,5	0,50	0,40	5,00	10,7	38	13	7	3	10 x DC	2
0,5	0,30	0,40	1,10	5,8	50	15	13	3	2,2 x DC	2
0,5	0,50	0,40	2,50	7,8	50	15	10	3	5 x DC	2
0,5	0,50	0,40	5,00	14,5	50	13	5	3	10 x DC	2
0,5	0,30	0,40	1,10	11,4	80	15	14	6	2,2 x DC	2
0,5	0,50	0,40	2,50	13,4	80	15	12	6	5 x DC	2
0,5	0,50	0,40	5,00	20,2	80	15	8	6	10 x DC	2
0,6	0,36	0,48	1,32	5,9	38	16,5	12	3	2,2 x DC	2
0,6	0,60	0,48	3,00	8,3	38	15	9	3	5 x DC	2
0,6	0,60	0,48	6,00	10,6	38	17	7	3	10 x DC	2
0,7	0,42	0,56	1,54	5,9	38	16,5	11,5	3	2,2 x DC	2
0,7	0,70	0,56	3,50	8,8	38	14	8	3	5 x DC	2
0,7	0,70	0,56	7,00	10,6	38	20,5	7	3	10 x DC	2
0,8	0,48	0,64	1,76	5,9	38	15	11	3	2,2 x DC	2
0,8	0,80	0,64	4,00	9,0	38	15	7	3	5 x DC	2
0,8	0,80	0,64	8,00	10,5	38	8,2	6	3	10 x DC	2
0,8	0,48	0,64	1,76	5,9	50	15	11	3	2,2 x DC	2
0,8	0,80	0,64	4,00	9,0	50	15	7	3	5 x DC	2
0,8	0,80	0,64	8,00	18,7	50	9,8	4	3	10 x DC	2
0,8	0,48	0,64	1,76	11,5	80	15	13	6	2,2 x DC	2

52 804 ...	52 804 ...	52 804 ...
021		
024		
027		
	022	
	025	
	028	
		023
		026
		029
03100		
03400		
03700		
04100		
04400		
04700		
051		
054		
057		
	052	
	055	
	058	
		053
		056
		059
06100		
06400		
06700		
07100		
07400		
07700		
081		
084		
087		
	082	
	085	
	088	
		083

P	●	●	●
M	●	●	●
K	●	●	●
N	●	●	●
S	●	●	●
H	○	○	○
O	○	○	○

Micro-ball nosed cutter

The universal milling cutter for micro-cutting

▲ T_x = maximum engagement depth

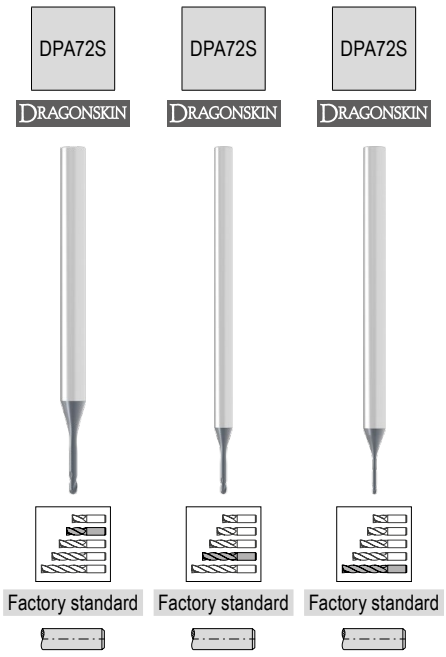
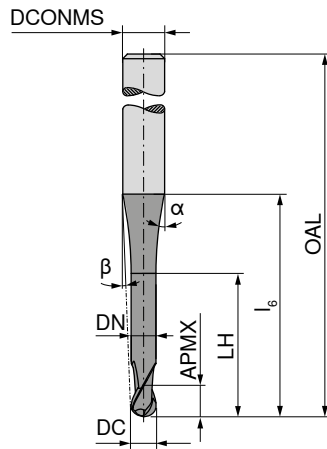

DC _{±0,01}	APMX	DN	LH	l ₆	OAL	α°	β°	DCONMS _{ns}	T _x	ZEFP	52 804 ...	52 804 ...	52 804 ...
0,8	0,80	0,64	4,00	14,6	80	15	11	6	5 x DC	2			086
0,8	0,80	0,64	8,00	25,9	80	14,8	6	6	10 x DC	2			089
0,9	0,54	0,72	1,98	5,9	38	17	10,5	3	2,2 x DC	2	09100		
0,9	0,90	0,72	4,50	9,5	38	14	7	3	5 x DC	2	09400		
0,9	0,90	0,72	9,00	10,5	38	39,5	6,5	3	10 x DC	2	09700		
1,0	0,60	0,80	2,20	7,8	43	15	11	4	2,2 x DC	2	101		
1,0	1,00	0,80	5,00	11,6	43	15	8	4	5 x DC	2	104		
1,0	1,00	0,80	10,00	18,3	43	8	5	4	10 x DC	2	107		
1,0	0,60	0,80	2,20	7,8	60	15	11	4	2,2 x DC	2		102	
1,0	1,00	0,80	5,00	11,6	60	15	8	4	5 x DC	2		105	
1,0	1,00	0,80	10,00	23,7	60	10,2	4	4	10 x DC	2		108	
1,0	0,60	0,80	2,20	11,5	80	15	13	6	2,2 x DC	2			103
1,0	1,00	0,80	5,00	15,3	80	15	10	6	5 x DC	2			106
1,0	1,00	0,80	10,00	28,7	80	13	5	6	10 x DC	2			109
1,1	0,66	0,88	2,42	7,9	43	16,5	11	4	2,2 x DC	2	11100		
1,1	1,10	0,88	5,50	12,0	43	14,5	7,5	4	5 x DC	2	11400		
1,1	1,10	0,88	11,00	18,3	43	13,5	5,5	4	10 x DC	2	11700		
1,2	0,72	0,96	2,64	7,9	43	15	11	4	2,2 x DC	2	121		
1,2	1,20	0,96	6,00	12,4	43	15	7	4	5 x DC	2	124		
1,2	1,20	0,96	12,00	18,2	43	9,3	5	4	10 x DC	2	127		
1,2	0,72	0,96	2,64	7,9	60	15	11	4	2,2 x DC	2		122	
1,2	1,20	0,96	6,00	12,4	60	15	7	4	5 x DC	2		125	
1,2	1,20	0,96	12,00	26,1	60	9,1	4	4	10 x DC	2		128	
1,2	0,72	0,96	2,64	11,6	80	15	12	6	2,2 x DC	2			123
1,2	1,20	0,96	6,00	16,2	80	15	9	6	5 x DC	2			126
1,2	1,20	0,96	12,00	31,8	80	11,7	5	6	10 x DC	2			129
1,3	0,78	1,04	2,86	8,0	43	16,5	10,5	4	2,2 x DC	2	13100		
1,3	1,30	1,04	6,50	12,8	43	14	6,5	4	5 x DC	2	13400		
1,3	1,30	1,04	13,00	18,2	43	17	5	4	10 x DC	2	13700		
1,4	0,84	1,12	3,08	8,0	43	16,5	10	4	2,2 x DC	2	14100		
1,4	1,40	1,12	7,00	13,2	43	14	6,5	4	5 x DC	2	14400		
1,4	1,40	1,12	14,00	18,1	43	20,5	5	4	10 x DC	2	14700		
1,5	0,90	1,20	3,30	8,0	43	15	9	4	2,2 x DC	2	151		
1,5	1,50	1,20	7,50	13,7	43	15	6	4	5 x DC	2	154		
1,5	1,50	1,20	15,00	18,1	43	13,5	4	4	10 x DC	2	157		
1,5	0,90	1,20	3,30	8,0	60	15	9	4	2,2 x DC	2		152	
1,5	1,50	1,20	7,50	13,7	60	15	6	4	5 x DC	2		155	

P	●	●	●
M	●	●	●
K	●	●	●
N	●	●	●
S	●	●	●
H	○	○	○
O	○	○	○

→ v_c/f_z Page 432-439

Micro-ball nosed cutter

The universal milling cutter for micro-cutting

▲ T_x = maximum engagement depth

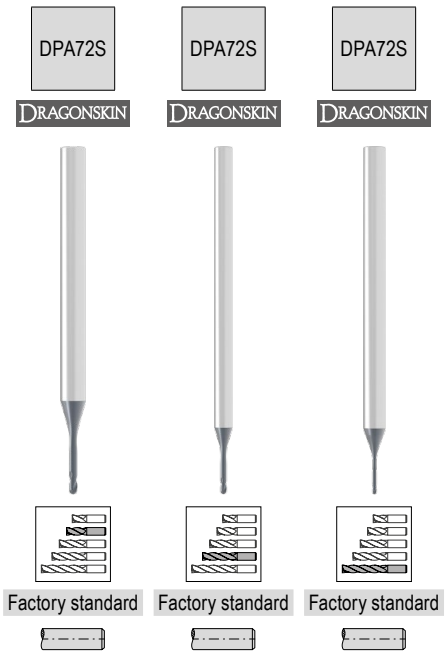
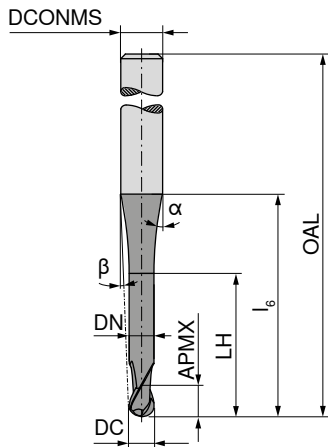

DC $\pm 0,01$ mm	APMX mm	DN mm	LH mm	l_6 mm	OAL mm	α°	β°	DCONMS n_5 mm	T_x	ZEFP
1,5	1,50	1,20	15,00	28,0	60	7,8	3	4	10 x DC	2
1,5	0,90	1,20	3,30	11,7	80	15	11	6	2,2 x DC	2
1,5	1,50	1,20	7,50	17,4	80	15	8	6	5 x DC	2
1,5	1,50	1,20	15,00	35,8	80	10,2	4	6	10 x DC	2
1,6	0,96	1,28	3,52	8,1	43	16,5	9	4	2,2 x DC	2
1,6	1,60	1,28	8,00	14,1	43	13	5,5	4	5 x DC	2
1,6	1,60	1,28	16,00	18,5	43	29,5	4,5	4	10 x DC	2
1,7	1,02	1,36	3,74	8,1	43	16,5	9	4	2,2 x DC	2
1,7	1,70	1,36	8,50	14,5	43	12,5	5	4	5 x DC	2
1,7	1,70	1,36	17,00	18,9	43	35,5	4	4	10 x DC	2
1,8	1,08	1,44	3,96	8,1	43	15	8	4	2,2 x DC	2
1,8	1,80	1,44	9,00	15,0	43	15	5	4	5 x DC	2
1,8	1,80	1,44	18,00	19,5	43	31,1	4	4	10 x DC	2
1,8	1,08	1,44	3,96	8,1	60	15	8	4	2,2 x DC	2
1,8	1,80	1,44	9,00	15,0	60	15	5	4	5 x DC	2
1,8	1,80	1,44	18,00	31,9	60	6,8	2	4	10 x DC	2
1,8	1,08	1,44	3,96	11,8	80	15	11	6	2,2 x DC	2
1,8	1,80	1,44	9,00	18,7	80	15	7	6	5 x DC	2
1,8	1,80	1,44	18,00	39,3	80	9,1	4	6	10 x DC	2
1,9	1,14	1,52	4,18	8,2	43	16,5	8	4	2,2 x DC	2
1,9	1,90	1,52	9,50	15,5	43	11,5	4,5	4	5 x DC	2
1,9	1,90	1,52	19,00	19,9	43	54,5	3,5	4	10 x DC	2
2,0	1,20	1,60	4,40	11,9	57	15	10	6	2,2 x DC	2
2,0	2,00	1,60	10,00	19,7	57	15	6	6	5 x DC	2
2,0	2,00	1,60	20,00	32,0	57	9,5	4	6	10 x DC	2
2,0	1,20	1,60	4,40	11,9	70	15	10	6	2,2 x DC	2
2,0	2,00	1,60	10,00	19,7	70	15	6	6	5 x DC	2
2,0	2,00	1,60	20,00	41,4	70	8,5	3	6	10 x DC	2
2,0	1,20	1,60	4,40	11,9	80	15	10	6	2,2 x DC	2
2,0	2,00	1,60	10,00	19,7	80	15	6	6	5 x DC	2
2,0	2,00	1,60	20,00	41,4	80	8,5	3	6	10 x DC	2

52 804 ...	52 804 ...	52 804 ...
	158	
16100		153
16400		156
16700		159
17100		
17400		
17700		
181		
184		
187		
	182	
	185	
	188	
		183
		186
		189
19100		
19400		
19700		
201		
204		
207		
	202	
	205	
	208	
		203
		206
		209

P	●	●	●
M	●	●	●
K	●	●	●
N	●	●	●
S	●	●	●
H	○	○	○
O	○	○	○

→ v_c/f_z Page 432-439

Micro-torus cutter

The universal milling cutter for micro-cutting

▲ T_x = maximum engagement depth

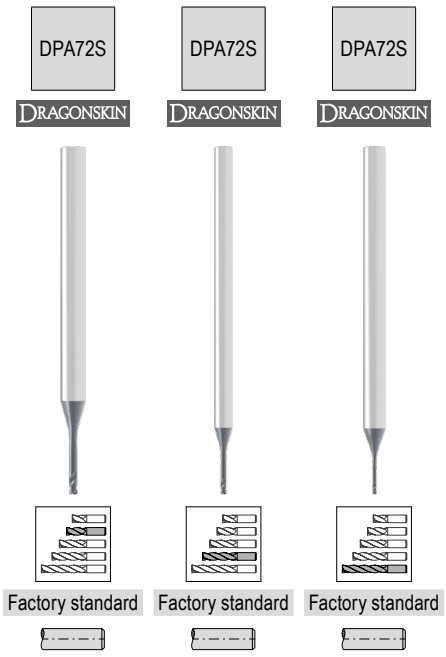
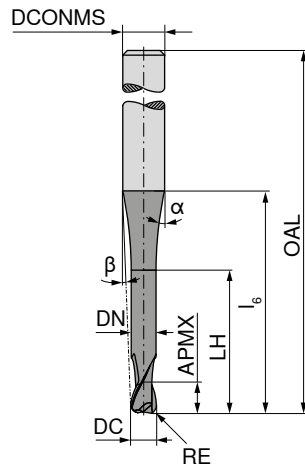
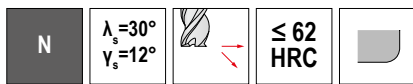

DC $\pm 0,01$ mm	RE $\pm 0,005$ mm	APMX mm	DN mm	LH mm	l_0 mm	OAL mm	α°	β°	DCONMS h_5 mm	T_x	ZEFP
0,5	0,1	0,30	0,40	1,10	5,8	38	15	13	3	2,2 x DC	2
0,5	0,1	0,50	0,40	2,50	7,8	38	15	10	3	5 x DC	2
0,5	0,1	0,50	0,40	5,00	10,7	38	13	7	3	10 x DC	2
0,5	0,1	0,30	0,40	1,10	5,8	50	15	13	3	2,2 x DC	2
0,5	0,1	0,50	0,40	2,50	7,8	50	15	10	3	5 x DC	2
0,5	0,1	0,50	0,40	5,00	14,5	50	13	5	3	10 x DC	2
0,5	0,1	0,30	0,40	1,10	11,4	80	15	14	6	2,2 x DC	2
0,5	0,1	0,50	0,40	2,50	13,4	80	15	12	6	5 x DC	2
0,5	0,1	0,50	0,40	5,00	20,2	80	15	8	6	10 x DC	2
0,6	0,1	0,36	0,48	1,32	5,9	38	16,5	12	3	2,2 x DC	2
0,6	0,1	0,60	0,48	3,00	8,3	38	15	9	3	5 x DC	2
0,6	0,1	0,60	0,48	6,00	10,6	38	17	7	3	10 x DC	2
0,8	0,2	0,48	0,64	1,76	5,9	38	16,5	11	3	2,2 x DC	2
0,8	0,2	0,80	0,64	4,00	9,0	38	14,5	7,5	3	5 x DC	2
0,8	0,2	0,80	0,64	8,00	10,5	38	27	6,5	3	10 x DC	2
1,0	0,2	0,60	0,80	2,20	7,8	43	15	11	4	2,2 x DC	2
1,0	0,2	1,00	0,80	5,00	11,6	43	15	8	4	5 x DC	2
1,0	0,2	1,00	0,80	10,00	18,3	43	8	5	4	10 x DC	2
1,0	0,2	0,60	0,80	2,20	7,8	60	15	11	4	2,2 x DC	2
1,0	0,2	1,00	0,80	5,00	11,6	60	15	8	4	5 x DC	2
1,0	0,2	1,00	0,80	10,00	23,7	60	10,2	4	4	10 x DC	2
1,0	0,2	0,60	0,80	2,20	11,5	80	15	13	6	2,2 x DC	2
1,0	0,2	1,00	0,80	5,00	15,3	80	15	10	6	5 x DC	2
1,0	0,2	1,00	0,80	10,00	28,7	80	13	5	6	10 x DC	2
1,2	0,2	0,72	0,96	2,64	7,9	43	16,5	10,5	4	2,2 x DC	2
1,2	0,2	1,20	0,96	6,00	12,4	43	14,5	7	4	5 x DC	2
1,2	0,2	1,20	0,96	12,00	18,2	43	15	5	4	10 x DC	2
1,5	0,3	0,90	1,20	3,30	8,0	43	15	9	4	2,2 x DC	2
1,5	0,3	1,50	1,20	7,50	13,7	43	15	6	4	5 x DC	2
1,5	0,3	1,50	1,20	15,00	18,1	43	24	4	4	10 x DC	2
1,5	0,3	0,90	1,20	3,30	8,0	60	15	9	4	2,2 x DC	2
1,5	0,3	1,50	1,20	7,50	13,7	60	15	6	4	5 x DC	2
1,5	0,3	1,50	1,20	15,00	29,2	60	7,8	3	4	10 x DC	2
1,5	0,3	0,90	1,20	3,30	11,7	80	15	11	6	2,2 x DC	2
1,5	0,3	1,50	1,20	7,50	17,4	80	15	8	6	5 x DC	2
1,5	0,3	1,50	1,20	15,00	35,8	80	10,2	4	6	10 x DC	2
1,6	0,3	0,96	1,28	3,52	8,1	43	16,5	9	4	2,2 x DC	2

52 806 ...	52 806 ...	52 806 ...
051		
054		
057		
	052	
	055	
	058	
		053
		056
		059
06101		
06401		
06701		
08102		
08402		
08702		
101		
104		
107		
	102	
	105	
	108	
		103
		106
		109
12102		
12402		
12702		
151		
154		
157		
	152	
	155	
	158	
		153
		156
		159
16103		

P	●	●	●
M	●	●	●
K	●	●	●
N	●	●	●
S	●	●	●
H	○	○	○
O	○	○	○

→ v_c/f_z Page 432-439

Micro-torus cutter

The universal milling cutter for micro-cutting

▲ T_x = maximum engagement depth

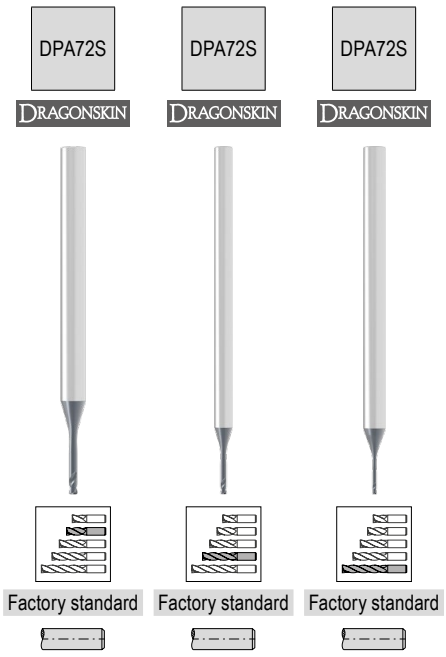
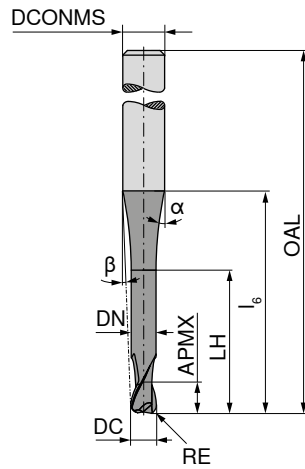
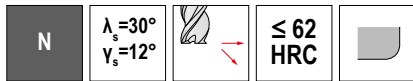

DC $\pm 0,01$ mm	RE $\pm 0,005$ mm	APMX mm	DN mm	LH mm	l_0 mm	OAL mm	α°	β°	DCONMS h_5 mm	T_x	ZEPF
1,6	0,3	1,60	1,28	8,00	14,1	43	13	5,5	4	5 x DC	2
1,6	0,3	1,60	1,28	16,00	18,5	43	29,5	4,5	4	10 x DC	2
1,8	0,4	1,08	1,44	3,96	8,1	43	16,5	8,5	4	2,2 x DC	2
1,8	0,4	1,80	1,44	9,00	15,0	43	12	5	4	5 x DC	2
1,8	0,4	1,80	1,44	18,00	19,5	43	41	4	4	10 x DC	2
2,0	0,5	1,20	1,60	4,40	11,9	57	15	10	6	2,2 x DC	2
2,0	0,5	2,00	1,60	10,00	19,7	57	15	6	6	5 x DC	2
2,0	0,5	2,00	1,60	20,00	32,0	57	9,5	4	6	10 x DC	2
2,0	0,5	1,20	1,60	4,40	11,9	70	15	10	6	2,2 x DC	2
2,0	0,5	2,00	1,60	10,00	19,7	70	15	6	6	5 x DC	2
2,0	0,5	2,00	1,60	20,00	41,4	70	8,5	3	6	10 x DC	2
2,0	0,5	1,20	1,60	4,40	11,9	80	15	10	6	2,2 x DC	2
2,0	0,5	2,00	1,60	10,00	19,7	80	15	6	6	5 x DC	2
2,0	0,5	2,00	1,60	20,00	41,4	80	8,5	3	6	10 x DC	2

52 806 ...	52 806 ...	52 806 ...
16403		
16703		
18104		
18404		
18704		
201		
204		
207		
	202	
	205	
	208	
		203
		206
		209

P	●	●	●
M	●	●	●
K	●	●	●
N	●	●	●
S	●	●	●
H	○	○	○
O	○	○	○

→ v_c/f_z Page 432-439

MultiLock – Ball Nosed Cutter

The sustainable exchangeable head system

▲ KLG = Coupling Size

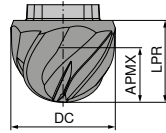
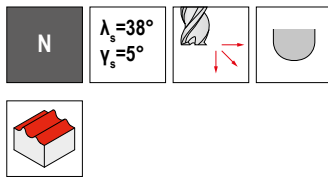

DC mm	KLG	APMX mm	LPR mm	ZEFP
12	EL12	7,0	9	4
16	EL16	9,5	12	4
20	EL20	12,0	15	4
25	EL25	16,0	19	4

Factory standard	Factory standard
53 803 ...	53 804 ...
01200	01200
01600	01600
02000	02000
02500	02500

P	●
M	○
K	●
N	○
S	●
H	
O	

→ v_c/f_z Page 440

MultiLock – Torus Cutter

The sustainable exchangeable head system

▲ KLG = Coupling Size

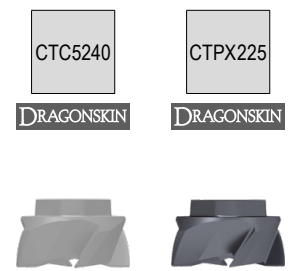
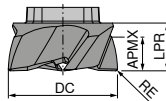
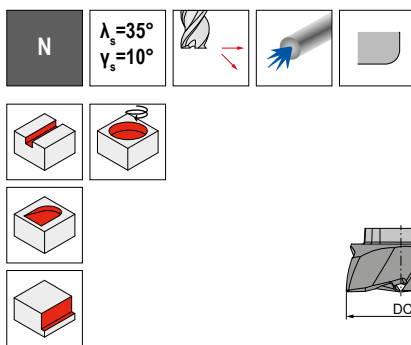

DC mm	RE mm	KLG	APMX mm	LPR mm	ZEFP
12	0,2	EL12	3,0	5	4
16	0,3	EL16	4,5	7	4
20	0,3	EL20	6,0	8	5
25	0,5	EL25	8,0	10	6

Factory standard	Factory standard
53 805 ...	53 806 ...
01205	01205
01607	01607
02008	02008
02510	02510

P	●
M	○
K	●
N	○
S	●
H	
O	

→ v_c/f_z Page 441

MultiLock – High Feed Cutter

The sustainable exchangeable head system

- ▲ KLG = Coupling size
- ▲ r_{3d} = programmed corner radius
- ▲ APMX does not correspond to the maximum depth of cut

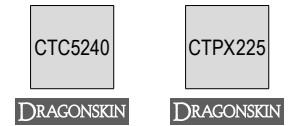
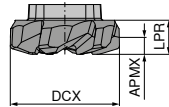
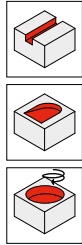

DCX mm	KLG	r_{3d} mm	APMX mm	LPR mm	ZEFP	Factory standard	
						53 801 ...	53 802 ...
12	EL12	0,7	3,18	4	5	01202	01202
16	EL16	1,2	3,73	5	6	01605	01605
20	EL20	1,2	4,31	6	6	02005	02005
25	EL25	1,2	5,32	7	6	02505	02505

P	●
M	○
K	●
N	
S	●
H	
O	

→ v_c/f_z Page 442

MultiLock – Deburring Cutter

The sustainable exchangeable head system

- ▲ KLG = Coupling Size

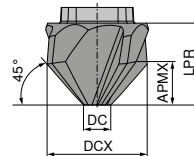
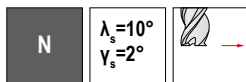

DCX mm	KLG	APMX mm	DC mm	LPR mm	ZEFP	Factory standard	
						53 800 ...	
12	EL12	4	4	8	4	01200	
16	EL16	6	4	12	4	01600	

P	●
M	○
K	●
N	○
S	
H	
O	

→ v_c/f_z Page 443

MultiLock – Holders

▲ KLG = Coupling Size

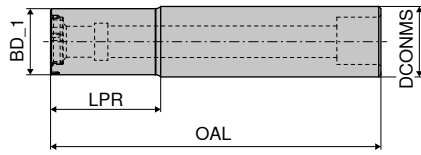

KLG	BD_1 mm	DCONMS mm	OAL mm	LPR mm
EL12	11	12	66	20
EL16	15	16	75	25
EL20	19	20	77	25
EL25	24	25	87	30

84 050 ...	84 051 ...
01200	01200
01600	01600
02000	02000
02500	02500

Spare parts
for Article no.

Article no.	Cylindrical screw	TORX® blade	Key D	Molykote	Clamping screw	Threaded bush	Torque screwdriver	Bit
84 051 01200 / 84 050 01200	42000	054	120	303	41900	42100	193	03500
84 051 01600 / 84 050 01600	42300	055	121	303	42200	42400	193	04500
84 051 02000 / 84 050 02000	42300	055	121	303	42200	42400	193	04500
84 051 02500 / 84 050 02500	42600	055	121	303	42500	42700	193	06000



MultiLock – Screw-in adapter, type A

▲ KLG = Coupling size

▲ For high-feed and torus cutters

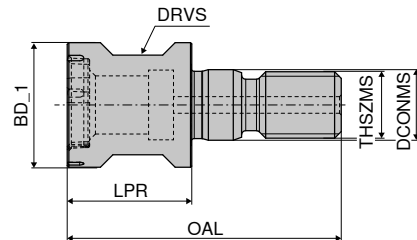

KLG	BD_1 mm	THSZMS	OAL mm	LPR mm	DCONMS mm	DRVS mm
EL12	11	M6	28	13	6,5	9
EL16	15	M8	33	14	8,5	12
EL20	19	M10	37	18	10,5	15
EL25	24	M12	42	20	12,5	17

84 052 ...
01200
01600
02000
02500

Spare parts
for Article no.

Article no.	TORX® blade	Key D	Molykote	Clamping screw	Threaded bush	Torque screwdriver	Bit
84 052 01200	054	120	303	41900	42100	193	03500
84 052 01600	055	121	303	42200	42400	193	04500
84 052 02000	055	121	303	42200	42400	193	04500
84 052 02500	055	121	303	42500	42700	193	06000

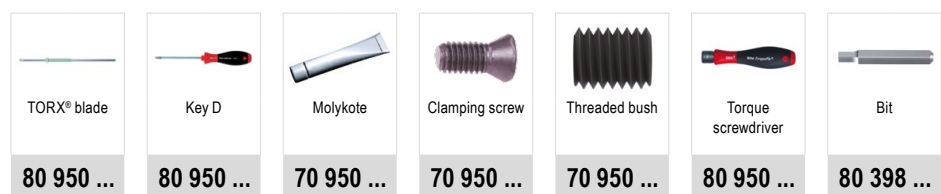

MultiLock – Screw-in adapter, type B

- ▲ KLG = Coupling size
- ▲ For radius milling and deburring cutters

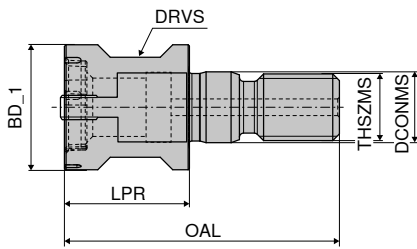

84 053 ...

KLG	BD_1 mm	THSZMS	OAL mm	LPR mm	DCONMS mm	DRVS mm	
EL12	11	M6	28	13	6,5	9	01200
EL16	15	M8	33	14	8,5	12	01600
EL20	20	M10	37	18	10,5	15	02000
EL25	25	M12	42	20	12,5	17	02500

**Spare parts
for Article no.**

Article no.	TORX® blade	Clamping screw	Key D	Molykote	Torque screwdriver	Mounting bush
84 053 01200	054	18600	120	303	193	18000
84 053 01600	055	18800	121	303	193	18100
84 053 02000	055	18700	121	303	193	18200
84 053 02500	055	18900	121	303	193	18300



Information on how to correctly assemble the MultiLock adapters can be found on → [page 490](#).

MultiChange – Programme Overview

The "MultiChange" interchangeable head system enables an extremely fast and problem free tool change. Provides quick changeover and concentricity with the highest stability at the same time. For a multitude of applications, the suitable interchangeable heads are available in the following chapters.

Exchangeable heads	
<p>→ Chapter 2, Solid carbide drilling</p> <p>Solid Carbide NC Spot Drills</p> <p>Ø 8, 10, 12, 16, 20 mm NOF 2</p> <p>SIG 90° SIG 120° SIG 142°</p>	<p>Page No. 2 107</p>
<p>→ Chapter 4, Reaming and countersinking</p> <p>Replaceable reaming heads</p> <p>Ø 8,00 – 30,20 mm</p> <p>Through hole</p> <p>Ø 12,20 – 30,20 mm</p> <p>Blind hole</p>	<p>Page No. 4 18 + 4 19</p>
<p>→ Chapter 14, Solid carbide milling cutters</p> <p>Solid carbide shoulder mills</p> <p>Ø 8, 10, 12, 16, 20 mm / ZEFP 3+4</p> <p>Type PCR-UNI Type PCR-ALU Type N</p> <p>Solid carbide torus bull nose milling cutters</p> <p>Ø 8, 10, 12, 16, 20 mm / ZEFP 3+4</p> <p>Type W Type N</p> <p>Solid carbide rough and finish milling cutters</p> <p>Ø 8, 10, 12, 16, 20 mm / ZEFP 4+6</p> <p>Type NF</p> <p>Solid carbide finish milling cutters</p> <p>Ø 8, 10, 12, 16, 20 mm / ZEFP 6</p> <p>Type N</p> <p>Solid carbide ball-nosed end mills</p> <p>Ø 10, 12, 16, 20 mm / ZEFP 4</p> <p>Type N</p> <p>Solid carbide high-feed cutters</p> <p>Ø 8, 10, 12, 16, 20 mm / ZEFP 6</p> <p>Type N</p> <p>Solid carbide quarter round cutter</p> <p>Ø 8, 10, 12, 16, 20 mm / ZEFP 6</p> <p>Type N</p> <p>Solid carbide deburring cutters</p> <p>Ø 10, 12, 16, 20 mm / ZEFP 4+6</p> <p>Type N Type N</p>	<p>Page No. 14 198 – 14 202</p>

NOF / ZEFP = Number of cutting edges

Tool holder	
<p>→ Catalogue – Clamping technology, Chapter 16 Accessories</p> <p>Page No. 16 259 – 16 261</p> <p>OAL 60 – 90 mm</p> <p>Tapered 87° / Steel Cylindrical* / Steel</p> <p>OAL 85 – 120 mm</p> <p>Tapered 87° / Steel Cylindrical* / Steel</p> <p>Tapered 87° / Solid carbide Cylindrical* / Solid carbide</p> <p>OAL 110 – 150 mm</p> <p>Tapered 87° / Solid carbide Cylindrical* / Solid carbide</p> <p>OAL 150 – 200 mm</p> <p>Tapered 87° / Solid carbide Cylindrical* / Steel</p> <p>Cylindrical* / Solid carbide</p> <p>OAL 200 – 250 mm</p> <p>Cylindrical* / Steel Cylindrical* / Solid carbide</p>	

* only conditionally suitable for milling

MultiChange – End Mill

The exchangeable head system for the highest demands and a wide range of applications

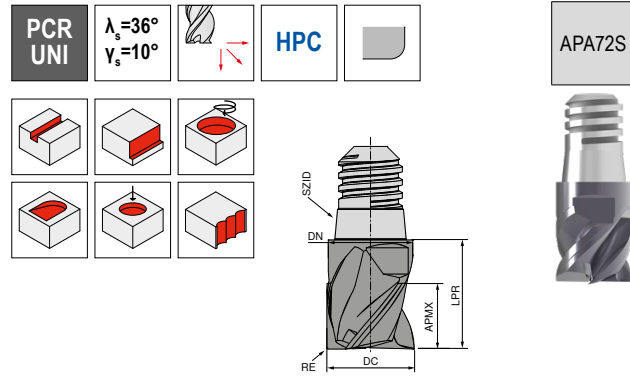

Factory standard

52 871 ...

DC mm	RE mm	SZID mm	APMX mm	DN mm	LPR ±0.02 mm	ZEFP mm	
10	0,32	08	7,5	9,8	13	4	10000
12	0,32	10	9,0	11,8	16	4	12000
16	0,32	12	12,0	15,8	20	4	16000
20	0,50	16	15,0	19,8	25	4	20000

P	●
M	○
K	●
N	
S	
H	
O	

→ v_c/f_z Page 444+445

MultiChange – Torus Cutter

The exchangeable head system for the highest demands and a wide range of applications

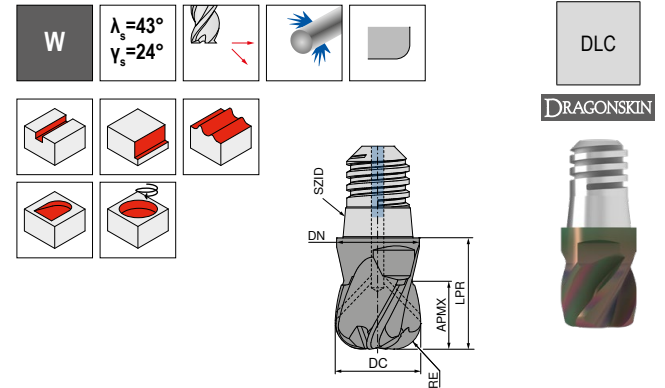

Factory standard

52 870 ...

DC mm	RE mm	SZID mm	APMX mm	DN mm	LPR mm	ZEFP mm	
10	0,5	08	7,5	9,8	13	3	10005
10	1,0	08	7,5	9,8	13	3	10010
12	0,5	10	9,0	11,8	16	3	12005
12	1,0	10	9,0	11,8	16	3	12010
12	2,0	10	9,0	11,8	16	3	12020
16	2,0	12	12,0	15,8	20	3	16020
16	4,0	12	12,0	15,8	20	3	16040
20	2,0	16	15,0	19,8	25	3	20020
20	3,0	16	15,0	19,8	25	3	20030
20	4,0	16	15,0	19,8	25	3	20040

P	
M	
K	
N	●
S	
H	
O	

→ v_c/f_z Page 452

MultiChange – End Mill

The exchangeable head system for the highest demands and a wide range of applications

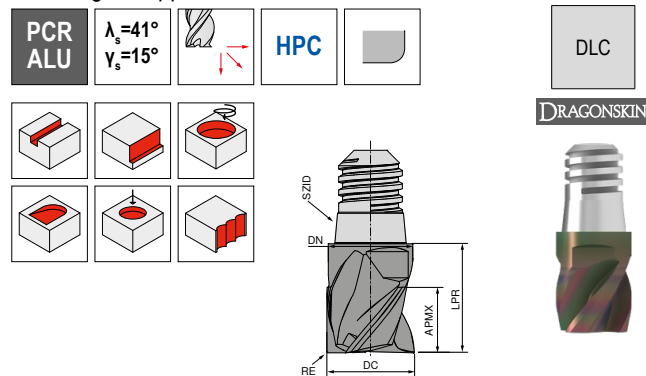

Factory standard

52 872 ...

DC mm	RE mm	SZID mm	APMX mm	DN mm	LPR ±0.02 mm	ZEFP mm	
10	0,32	08	7,5	9,8	13	4	10000
12	0,32	10	9,0	11,8	16	4	12000
16	0,32	12	12,0	15,8	20	4	16000
20	0,50	16	15,0	19,8	25	4	20000

P	
M	
K	
N	●
S	
H	
O	

→ v_c/f_z Page 444+445

Assembly instructions

- ▲ SZID = Coupling Size
- ▲ SW = Across Flats Size
- ▲ M = Torque moment

SZID	SW mm	M Nm
06	6	5
08	8	12,5
10	10	15
12	13	20
16	16	25

- ▲ A torque wrench should be used when mounting coupling sizes 06 and 08. It is recommended to use one for all sizes
- ▲ In unstable applications, the cutting data should be reduced.

Holders and accessories can be found in → **chapter 16, adapters and accessories in the clamping technology catalogue.**

Application Tips

- ▲ APMX does not correspond to the maximum cutting depth

MultiChange – End Mill

The exchangeable head system for the highest demands and a wide range of applications

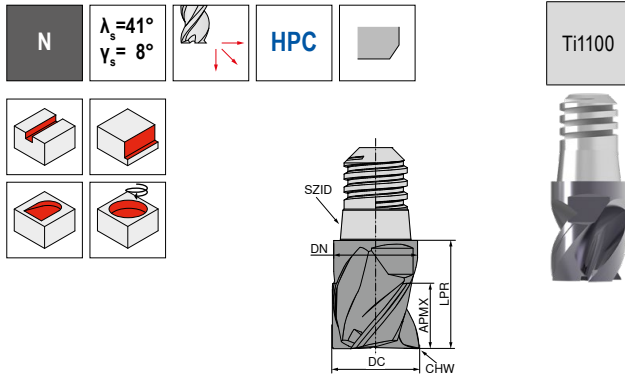

Factory standard

52 861 ...

DC mm	SZID	APMX mm	DN mm	LPR _{±0.02} mm	CHW mm	ZEFP	
8	06	6,0	7,8	11	0,16	3	080
10	08	7,5	9,8	13	0,20	3	100
12	10	9,0	11,8	16	0,24	3	120
16	12	12,0	15,8	20	0,32	3	160
20	16	15,0	19,8	25	0,40	3	200

P	●
M	○
K	●
N	●
S	○
H	○
O	○

→ v_c/f_z Page 446

MultiChange – Roughing-Finishing Cutter

The exchangeable head system for the highest demands and a wide range of applications

▲ With flat cord profile

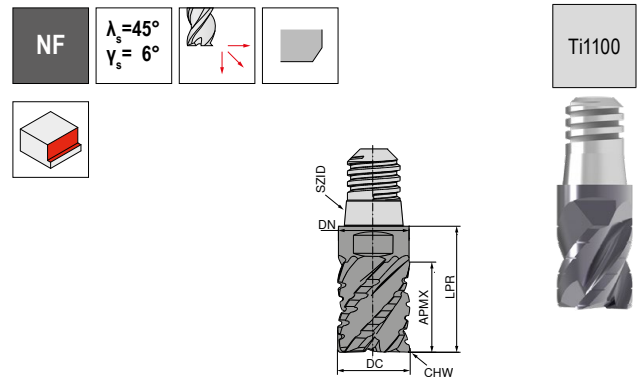

Factory standard

52 862 ...

DC mm	SZID	APMX mm	DN mm	LPR _{±0.02} mm	CHW mm	ZEFP	
8	06	10,0	7,8	15	0,16	4	080
10	08	12,5	9,8	18	0,20	4	100
12	10	15,0	11,8	22	0,24	4	120
16	12	20,0	15,8	28	0,32	5	160
20	16	25,0	19,8	35	0,40	6	200

P	●
M	○
K	●
N	●
S	○
H	○
O	○

→ v_c/f_z Page 447

MultiChange – End Mill

The exchangeable head system for the highest demands and a wide range of applications

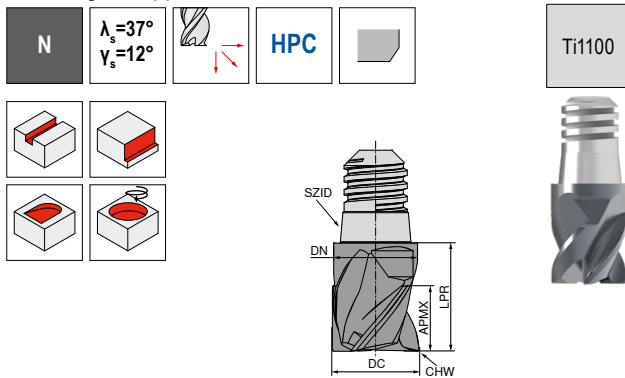

Factory standard

52 860 ...

DC mm	SZID	APMX mm	DN mm	LPR _{±0.02} mm	CHW mm	ZEFP	
8	06	6,0	7,8	11	0,16	4	080
10	08	7,5	9,8	13	0,20	4	100
12	10	9,0	11,8	16	0,24	4	120
16	12	12,0	15,8	20	0,32	4	160
20	16	15,0	19,8	25	0,40	4	200

P	●
M	○
K	●
N	●
S	○
H	○
O	○

→ v_c/f_z Page 446

Assembly instructions

- ▲ SZID = Coupling Size
- ▲ SW = Across Flats Size
- ▲ M = Torque moment

SZID	SW mm	M Nm
06	6	5
08	8	12,5
10	10	15
12	13	20
16	16	25

- ▲ A torque wrench should be used when mounting coupling sizes 06 and 08. It is recommended to use one for all sizes
- ▲ In unstable applications, the cutting data should be reduced.

HOLDERS AND ACCESSORIES CAN BE FOUND IN → CHAPTER 16, ADAPTERS AND ACCESSORIES IN THE CLAMPING TECHNOLOGY CATALOGUE.

Application Tips

- ▲ APMX does not correspond to the maximum cutting depth

MultiChange – Finish milling cutter

The exchangeable head system for the highest demands and a wide range of applications

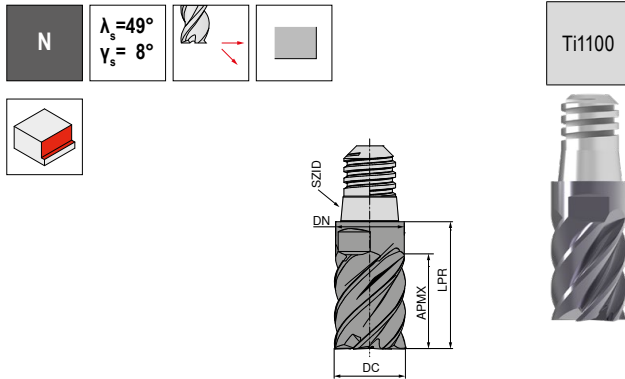

Factory standard
52 863 ...

DC mm	SZID	APMX mm	DN mm	LPR ±0.02 mm	ZEFP	
8	06	10,0	7,8	15	6	080
10	08	12,5	9,8	18	6	100
12	10	15,0	11,8	22	6	120
16	12	20,0	15,8	28	6	160
20	16	25,0	19,8	35	6	200

P	●
M	○
K	●
N	●
S	●
H	●
O	○

→ v_c/f_z Page 449

MultiChange – Torus Cutter

The exchangeable head system for the highest demands and a wide range of applications

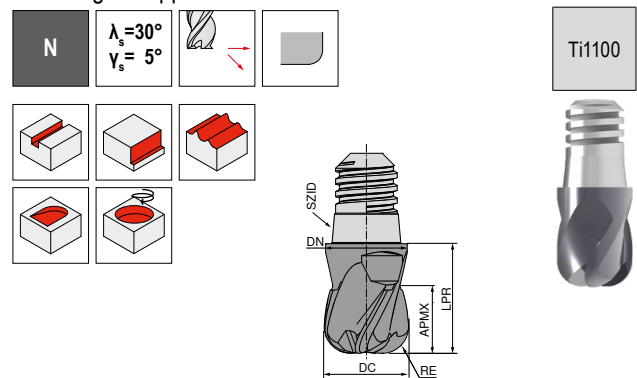

Factory standard
52 865 ...

DC mm	SZID	APMX mm	DN mm	LPR ±0.02 mm	RE mm	ZEFP	
8	06	6,0	7,8	11	1,0	4	081
8	06	6,0	7,8	11	2,0	4	082
10	08	7,5	9,8	13	1,5	4	101
10	08	7,5	9,8	13	3,0	4	103
12	10	9,0	11,8	16	1,5	4	121
12	10	9,0	11,8	16	4,0	4	124
16	12	12,0	15,8	20	2,0	4	162
16	12	12,0	15,8	20	5,0	4	165
20	16	15,0	19,8	25	2,0	4	202
20	16	15,0	19,8	25	6,0	4	206

P	●
M	○
K	●
N	●
S	●
H	●
O	○

→ v_c/f_z Page 450+451

MultiChange – Ball Nosed Cutter

The exchangeable head system for the highest demands and a wide range of applications

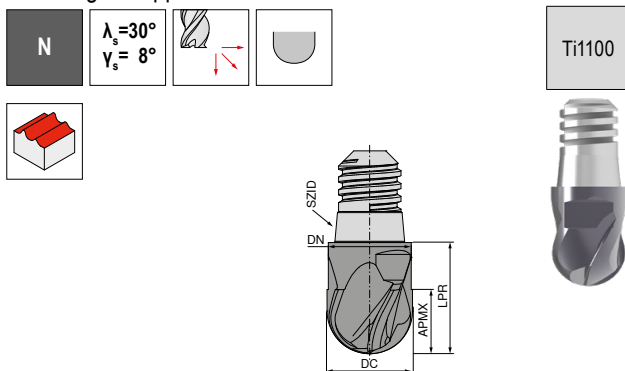

Factory standard
52 866 ...

DC mm	SZID	APMX mm	DN mm	LPR ±0.02 mm	ZEFP	
10	08	7,5	9,8	13	4	100
12	10	9,0	11,8	16	4	120
16	12	12,0	15,8	20	4	160
20	16	15,0	19,8	25	4	200

P	●
M	○
K	●
N	●
S	●
H	●
O	○

→ v_c/f_z Page 450+451

Assembly instructions

- ▲ SZID = Coupling Size
- ▲ SW = Across Flats Size
- ▲ M = Torque moment

SZID	SW mm	M Nm
06	6	5
08	8	12,5
10	10	15
12	13	20
16	16	25

- ▲ A torque wrench should be used when mounting coupling sizes 06 and 08. It is recommended to use one for all sizes
- ▲ In unstable applications, the cutting data should be reduced.

Holders and accessories can be found in → chapter 16, adapters and accessories in the clamping technology catalogue.

Application Tips

- APMX does not correspond to the maximum cutting depth

MultiChange – High Feed Cutter

The exchangeable head system for the highest demands and a wide range of applications

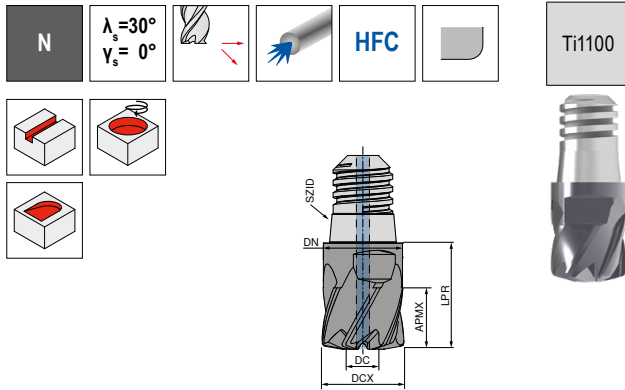

Factory standard

52 864 ...

DCX mm	SZID	r _{3D} mm	APMX mm	LPR _{±0.02} mm	ZEFP	
8	06	0,7	6,0	11	6	080
10	08	0,9	7,5	13	6	100
12	10	1,0	9,0	16	6	120
16	12	1,4	12,0	20	6	160
20	16	1,7	15,0	25	6	200
P						●
M						○
K						●
N						●
S						●
H						●
O						●

→ v_c/f_z Page 448



- ▲ r_{3D} = corner radius to be programmed
- ▲ Ø DCX tapered by 0.2 mm, resulting in Ø DN
- ▲ Ø DCX halved, resulting in Ø DC

MultiChange – Quarter-round milling cutter

The exchangeable head system for the highest demands and a wide range of applications

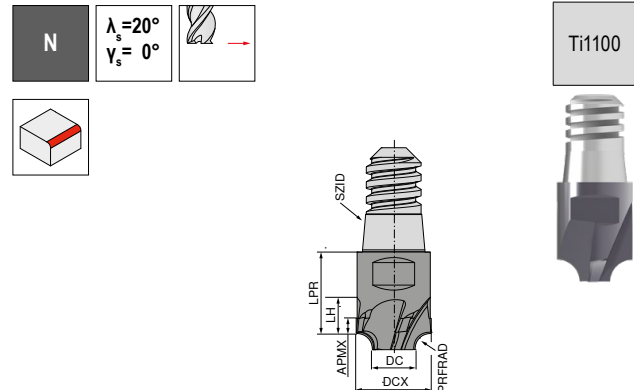

Factory standard

52 869 ...

DCX mm	SZID	PRFRAD _{±0.03} mm	APMX mm	DC mm	LPR _{±0.02} mm	LH mm	ZEFP	
8	06	0,5	2,0	6,63	11	4,5	4	080
8	06	1,0	3,0	5,69	11	5,0	4	081
10	08	1,5	4,0	6,63	13	6,5	4	100
10	08	2,0	4,5	5,69	13	7,0	4	101
12	10	2,5	5,5	6,65	16	8,5	4	120
12	10	3,0	6,0	5,70	16	9,0	4	121
12	10	3,5	6,5	4,76	16	9,5	4	122
16	12	4,0	8,0	7,60	20	12,0	4	160
16	12	4,5	8,5	6,68	20	12,5	4	161
16	12	5,0	9,0	5,74	20	13,0	4	162
20	16	5,0	10,0	9,53	25	15,0	4	200
20	16	6,0	11,0	7,64	25	16,0	4	201
P								●
M								○
K								●
N								●
S								●
H								●
O								●

→ v_c/f_z Page 453

Assembly instructions

- ▲ SZID = Coupling Size
- ▲ SW = Across Flats Size
- ▲ M = Torque moment

SZID	SW mm	M Nm
06	6	5
08	8	12,5
10	10	15
12	13	20
16	16	25



- ▲ A torque wrench should be used when mounting coupling sizes 06 and 08. It is recommended to use one for all sizes
- ▲ In unstable applications, the cutting data should be reduced.

Holders and accessories can be found in → **chapter 16, adapters and accessories in the clamping technology catalogue.**

Application Tips



APMX does not correspond to the maximum cutting depth

MultiChange – Deburring Cutter

The exchangeable head system for the highest demands and a wide range of applications

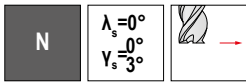

Ti1050

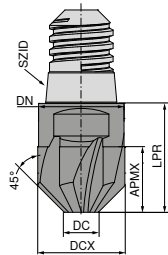

Factory standard

52 867 ...

DCX mm	SZID	APMX mm	DC mm	DN mm	LPR ± 0.02 mm	ZEFP	
10	08	7,5	0,02	9,8	13	4	100
12	10	9,0	0,02	11,8	16	4	120
16	12	12,0	6,40	15,8	20	6	160
20	16	15,0	8,00	19,8	25	6	200

P	●
M	○
K	●
N	●
S	●
H	●
O	●

→ v_c/f_z Page 454

Assembly instructions

- ▲ SZID = Coupling Size
- ▲ SW = Across Flats Size
- ▲ M = Torque moment

SZID	SW mm	M Nm
06	6	5
08	8	12,5
10	10	15
12	13	20
16	16	25

- 1 A torque wrench should be used when mounting coupling sizes 06 and 08. It is recommended to use one for all sizes
- ▲ In unstable applications, the cutting data should be reduced.

Holders and accessories can be found in → chapter 16, adapters and accessories in the clamping technology catalogue.

Application Tips

- 1 APMX does not correspond to the maximum cutting depth

MultiChange – Deburring Cutter

The exchangeable head system for the highest demands and a wide range of applications

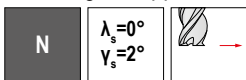

Ti1100

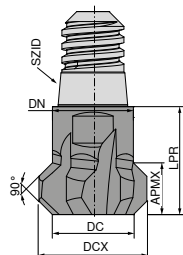

Factory standard

52 868 ...

DCX mm	SZID	APMX mm	DC mm	DN mm	LPR ± 0.02 mm	ZEFP	
10	06	4,8	7,5	8	11	6	100
12	08	5,5	9,0	10	13	6	120
16	10	8,0	12,0	12	16	6	160
20	12	9,5	15,0	16	20	6	200

P	●
M	○
K	●
N	●
S	●
H	●
O	●

→ v_c/f_z Page 454

End milling cutter

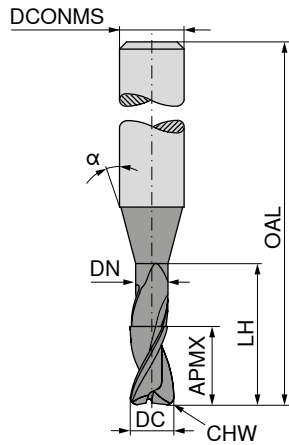
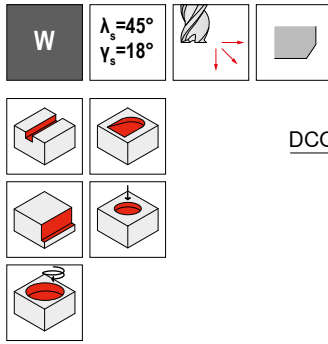

DC _{FB}	APMX	DN	LH	OAL	α°	DCONMS _{HS}	CHW	ZEFP
mm	mm	mm	mm	mm		mm	mm	
0,2	0,2	0,18	0,6	55	15	3	0,02	2
0,2	0,2	0,18	1,0	55	15	3	0,02	2
0,2	0,2	0,18	1,6	55	15	3	0,02	2
0,2	0,2	0,18	2,0	55	15	3	0,02	2
0,3	0,3	0,28	0,9	55	15	3	0,03	2
0,3	0,3	0,28	1,5	55	15	3	0,03	2
0,3	0,3	0,28	2,4	55	15	3	0,03	2
0,3	0,3	0,28	3,0	55	15	3	0,03	2
0,4	0,4	0,37	1,2	55	15	3	0,04	2
0,4	0,4	0,37	2,0	55	15	3	0,04	2
0,4	0,4	0,37	3,2	55	15	3	0,04	2
0,4	0,4	0,37	4,0	55	15	3	0,04	2
0,5	0,5	0,45	1,5	55	15	3	0,05	2
0,5	0,5	0,45	2,5	55	15	3	0,05	2
0,5	0,5	0,45	4,0	55	15	3	0,05	2
0,5	0,5	0,45	5,0	55	15	3	0,05	2
0,6	0,6	0,58	2,0	55	15	3	0,06	2
0,6	0,6	0,58	3,0	55	15	3	0,06	2
0,6	0,6	0,58	5,0	65	15	3	0,06	2
0,6	0,6	0,58	6,0	65	15	3	0,06	2
0,8	0,8	0,77	2,5	55	15	3	0,08	2
0,8	0,8	0,77	4,0	55	15	3	0,08	2
0,8	0,8	0,77	6,5	65	15	3	0,08	2
0,8	0,8	0,77	8,0	65	15	3	0,08	2
1,0	1,0	0,95	3,0	55	15	3	0,10	2
1,0	1,0	0,95	5,0	55	15	3	0,10	2
1,0	1,0	0,95	8,0	65	15	3	0,10	2
1,0	1,0	0,95	10,0	65	15	3	0,10	2
1,0	1,0	0,95	12,0	65	15	3	0,10	2
1,2	1,2	1,15	3,0	55	15	3	0,10	2
1,2	1,2	1,15	6,0	55	15	3	0,10	2
1,2	1,2	1,15	10,0	65	15	3	0,10	2
1,2	1,2	1,15	12,0	65	15	3	0,10	2
1,3	1,3	1,25	4,0	55	15	3	0,10	2
1,3	1,3	1,25	7,0	55	15	3	0,10	2
1,3	1,3	1,25	11,0	65	15	3	0,10	2
1,3	1,3	1,25	13,0	65	15	3	0,10	2
1,5	1,5	1,44	5,0	55	15	3	0,10	2
1,5	1,5	1,44	7,5	55	15	3	0,10	2
1,5	1,5	1,44	12,0	65	15	3	0,10	2

P		
M		
K		
N	•	•
S		
H		
O		

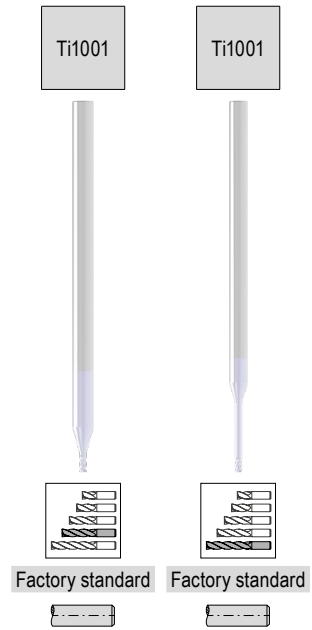

50 900 ...	50 900 ...
021	
022	
023	
024	
031	
032	
033	
034	
041	
042	
043	
044	
051	
052	
053	
054	
061	
062	
	063
	064
081	
082	
	083
	084
101	
102	
	103
	104
	105
121	
122	
	123
	124
131	
132	
	133
	134
151	
152	
	153

End milling cutter

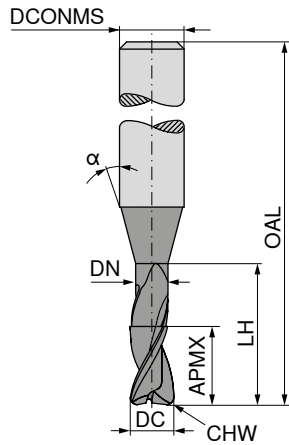
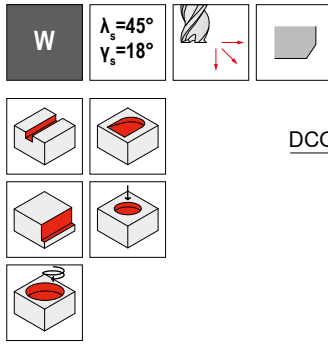

DC _{FB} mm	APMX mm	DN mm	LH mm	OAL mm	α°	DCONMS _{HS} mm	CHW mm	ZEFP
1,5	1,5	1,44	15,0	65	15	3	0,10	2
1,6	1,6	1,52	5,0	55	15	3	0,10	2
1,6	1,6	1,52	8,0	55	15	3	0,10	2
1,6	1,6	1,52	13,0	65	15	3	0,10	2
1,6	1,6	1,52	16,0	65	15	3	0,10	2
1,8	1,8	1,72	5,5	55	15	3	0,10	2
1,8	1,8	1,72	9,0	55	15	3	0,10	2
1,8	1,8	1,72	14,5	65	15	3	0,10	2
1,8	1,8	1,72	18,0	65	15	3	0,10	2
2,0	2,0	1,92	6,0	55	15	3	0,10	2
2,0	2,0	1,92	10,0	55	15	3	0,10	2
2,0	2,0	1,92	14,0	55	15	3	0,10	2
2,0	2,0	1,92	16,0	65	15	3	0,10	2
2,0	2,0	1,92	20,0	65	15	3	0,10	2
2,3	2,3	2,22	7,0	55	15	3	0,10	2
2,3	2,3	2,22	11,5	55	15	3	0,10	2
2,3	2,3	2,22	18,5	65	15	3	0,10	2
2,3	2,3	2,22	20,0	65	15	3	0,10	2
2,3	2,3	2,22	23,0	65	15	3	0,10	2
3,0	3,0	2,90	9,0	65	15	6	0,10	2
3,0	3,0	2,90	15,0	65	15	6	0,10	2
3,0	3,0	2,90	24,0	100	15	6	0,10	2
3,0	3,0	2,90	30,0	100	15	6	0,10	2
4,0	4,0	3,90	12,0	65	15	6	0,10	2
4,0	4,0	3,90	20,0	65	15	6	0,10	2
4,0	4,0	3,90	32,0	100	15	6	0,10	2
4,0	4,0	3,90	40,0	100	15	6	0,10	2
5,0	5,0	4,90	15,0	65	15	6	0,10	2
5,0	5,0	4,90	25,0	65	15	6	0,10	2
5,0	5,0	4,90	40,0	100	15	6	0,10	2
5,0	5,0	4,90	50,0	100	15	6	0,10	2
6,0	6,0	5,90	18,0	65	15	6	0,10	2
6,0	6,0	5,90	30,0	100	15	6	0,10	2
6,0	6,0	5,90	48,0	100	15	6	0,10	2
6,0	6,0	5,90	60,0	100	15	6	0,10	2

P		
M		
K		
N	•	•
S		
H		
O		

Ti1000

Factory standard

50 900 ...

161

162

181

182

201

202

203

231

232

301

302

401

402

501

502

601

154

163

164

183

184

204

205

233

234

235

303

304

403

404

503

504

602

603

604

→ v_c/f_z Page 480–485

End milling cutter

W $\lambda_s = 55^\circ$ $\gamma_s = 5^\circ$ HPC

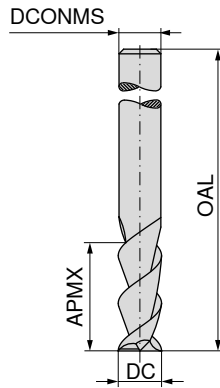
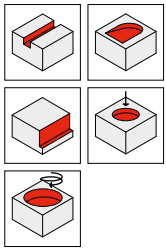

≈DIN 6527



50 960 ...



DC _{h6} mm	APMX mm	OAL mm	DCONMS _{h6} mm	ZEFP
3	12	50	3	2
4	15	50	4	2
5	20	50	5	2
6	20	57	6	2
8	20	63	8	2
10	25	73	10	2
12	25	83	12	2
14	30	83	14	2
16	30	92	16	2
20	38	104	20	2

- 030
- 040
- 050
- 060
- 080
- 100
- 120
- 140
- 160
- 200

P
M
K
N
S
H
O

→ v_c/f_z Page 460+461

End milling cutter

W
 $\lambda_s = 55^\circ$
 $\gamma_s = 7^\circ$

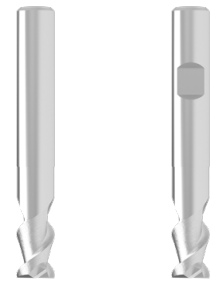
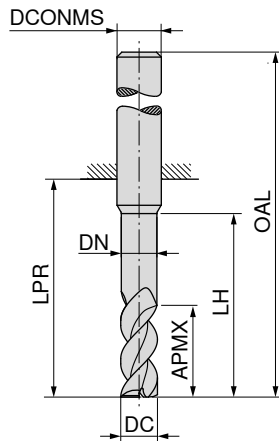
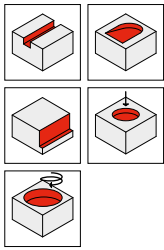
HPC



Factory standard



Factory standard



54 590 ...

54 591 ...

DC _{h6}	APMX	DN	LH	LPR	OAL	DCONMS _{h5}	ZEFP
mm	mm	mm	mm	mm	mm	mm	
2,7	5,0	2,5	12	19	55	6	2
3,0	3,5	2,8	12	19	55	6	2
3,0	5,0	2,8	12	19	55	6	2
3,7	6,5	3,5	12	19	55	6	2
4,0	4,5	3,8	12	19	55	6	2
4,0	6,5	3,8	12	19	55	6	2
4,7	8,0	4,5	15	22	58	6	2
5,0	5,5	4,8	15	22	58	6	2
5,0	8,0	4,8	15	22	58	6	2
5,7	10,0	5,5	18	22	58	6	2
6,0	7,0	5,8	18	22	58	6	2
6,0	10,0	5,8	18	22	58	6	2
6,7	13,0	6,4	24	28	64	8	2
7,0	13,0	6,7	24	28	64	8	2
7,7	13,0	7,4	24	28	64	8	2
8,0	9,0	7,7	24	28	64	8	2
8,0	13,0	7,7	24	28	64	8	2
8,7	16,0	8,4	30	34	74	10	2
9,0	16,0	8,7	30	34	74	10	2
9,7	16,0	9,4	30	34	74	10	2
10,0	11,0	9,7	30	34	74	10	2
10,0	16,0	9,7	30	34	74	10	2
10,7	19,0	10,3	36	40	85	12	2
11,0	19,0	10,6	36	40	85	12	2
11,7	19,0	11,3	36	40	85	12	2
12,0	13,0	11,6	36	40	85	12	2
12,0	19,0	11,6	36	40	85	12	2
13,0	22,0	12,6	42	46	91	14	2
13,7	22,0	13,3	42	46	91	14	2
14,0	15,0	13,6	42	46	91	14	2
14,0	22,0	13,6	42	46	91	14	2
15,0	25,0	14,5	48	52	100	16	2
15,7	25,0	15,2	48	52	100	16	2
16,0	17,0	15,5	48	52	100	16	2
16,0	25,0	15,5	48	52	100	16	2
18,0	20,0	17,5	54	58	106	18	2
18,0	29,0	17,5	54	58	106	18	2
19,7	32,0	19,2	60	64	114	20	2
20,0	22,0	19,5	60	64	114	20	2
20,0	32,0	19,5	60	64	114	20	2
24,7	40,0	24,2	75	80	136	25	2
25,0	27,0	24,5	75	80	136	25	2
25,0	40,0	24,5	75	80	136	25	2

027	027
033	
031	031
037	037
043	
041	041
047	047
053	
051	051
057	057
063	
061	061
067	067
071	071
077	077
083	
081	081
087	087
091	091
097	097
103	
101	101
107	107
111	111
117	117
123	
121	121
131	131
137	137
143	
141	141
151	151
157	157
163	
161	161
183	
181	181
197	197
203	
201	201
247	247
253	
251	251

P	
M	
K	
N	•
S	
H	
O	

End milling cutter

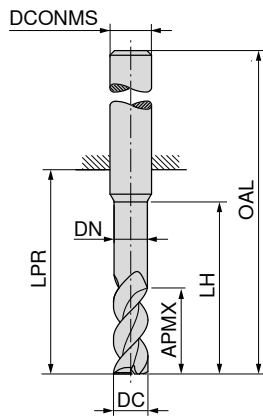
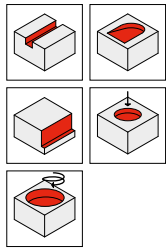
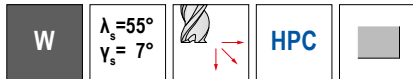

LPR with Shank DIN 6535 HB

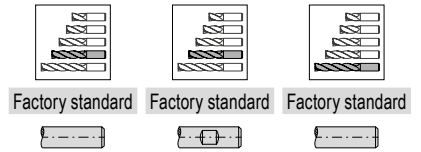
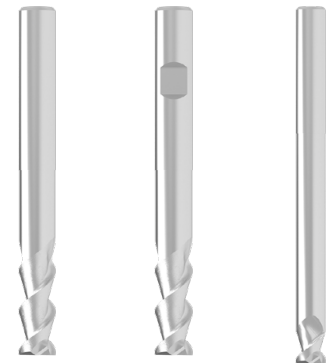

DC _{h6}	APMX	DN	LH	LPR	OAL	DCONMS _{h5}	ZEFP
mm	mm	mm	mm	mm	mm	mm	
2,7	8,0	2,5	15	22	58	6	2
3,0	3,5	2,8	15	22	58	6	2
3,0	8,0	2,8	15	22	58	6	2
3,0	3,5	2,8	24	31	67	6	2
3,7	10,5	3,5	20	26	62	6	2
4,0	4,5	3,8	20	26	62	6	2
4,0	10,5	3,8	20	26	62	6	2
4,0	4,5	3,8	32	38	74	6	2
4,7	13,0	4,5	25	34	70	6	2
5,0	5,5	4,8	25	34	70	6	2
5,0	13,0	4,8	25	34	70	6	2
5,0	5,5	4,8	40	52	88	6	2
5,7	16,0	5,5	30	34	70	6	2
6,0	7,0	5,8	30	34	70	6	2
6,0	16,0	5,8	30	34	70	6	2
6,0	7,0	5,8	48	52	88	6	2
6,7	21,0	6,4	40	44	80	8	2
7,0	21,0	6,7	40	44	80	8	2
7,7	21,0	7,4	40	44	80	8	2
8,0	9,0	7,7	40	44	80	8	2
8,0	21,0	7,7	40	44	80	8	2
8,0	9,0	7,7	64	68	104	8	2
8,7	26,0	8,4	50	54	94	10	2
9,0	26,0	8,7	50	54	94	10	2
9,7	26,0	9,4	50	54	94	10	2
10,0	11,0	9,7	50	54	94	10	2
10,0	26,0	9,7	50	54	94	10	2
10,0	11,0	9,7	80	84	124	10	2
10,7	31,0	10,3	60	64	109	12	2
11,0	31,0	10,6	60	64	109	12	2
11,7	31,0	11,3	60	64	109	12	2
12,0	13,0	11,6	60	64	109	12	2
12,0	31,0	11,6	60	64	109	12	2
12,0	13,0	11,6	96	100	145	12	2
13,0	36,0	12,6	70	74	119	14	2
13,7	36,0	13,3	70	74	119	14	2
14,0	15,0	13,6	70	74	119	14	2
14,0	36,0	13,6	70	74	119	14	2
14,0	15,0	13,6	112	116	161	14	2
15,0	41,0	14,5	80	84	132	16	2

54 590 ...	54 591 ...	54 590 ...
028	028	
034		
032	032	
		035
038	038	
044		
042	042	
		045
048	048	
054		
052	052	
		055
058	058	
064		
062	062	
		065
068	068	
072	072	
078	078	
084		
082	082	
		085
088	088	
092	092	
098	098	
104		
102	102	
		105
108	108	
112	112	
118	118	
124		
122	122	
		125
132	132	
138	138	
144		
142	142	
		145
152	152	

P			
M			
K			
N		•	•
S			
H			
O			

End milling cutter

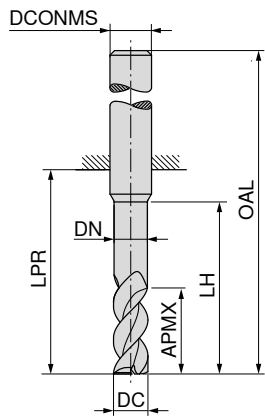
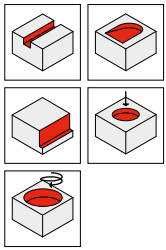

LPR with Shank DIN 6535 HB

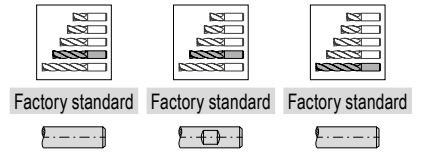
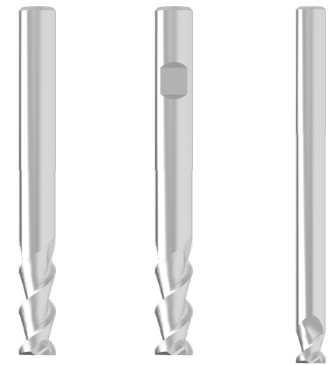

DC _{h6}	APMX	DN	LH	LPR	OAL	DCONMS _{h5}	ZEFP
mm	mm	mm	mm	mm	mm	mm	
15,7	41,0	15,2	80	84	132	16	2
16,0	17,0	15,5	80	84	132	16	2
16,0	41,0	15,5	80	84	132	16	2
16,0	17,0	15,5	128	132	180	16	2
18,0	20,0	17,5	90	94	142	18	2
18,0	47,0	17,5	90	94	142	18	2
18,0	20,0	17,5	144	148	196	18	2
19,7	52,0	19,2	100	104	154	20	2
20,0	22,0	19,5	100	104	154	20	2
20,0	52,0	19,5	100	104	154	20	2
20,0	22,0	19,5	160	164	214	20	2

54 590 ...	54 591 ...	54 590 ...
158	158	
164		
162	162	
		165
184		
182	182	
		185
198	198	
204		
202	202	
		205

P			
M			
K			
N	•	•	•
S			
H			
O			

→ v_c/f_z Page 460+461

End milling cutter with corner radius

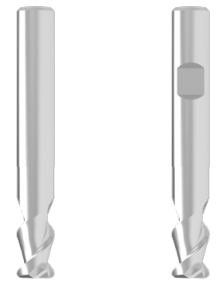
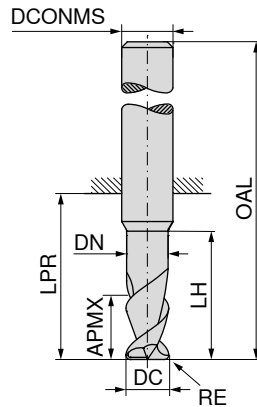
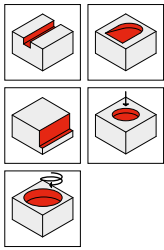

Factory standard



Factory standard



54 594 ...



54 595 ...

DC _{h6} mm	RE _{±0,01} mm	APMX mm	DN mm	LH mm	LPR mm	OAL mm	DCNMS _{h5} mm	ZEFP
3	0,2	5,0	2,8	12	19	55	6	2
3	0,3	5,0	2,8	12	19	55	6	2
3	0,5	5,0	2,8	12	19	55	6	2
4	0,3	6,5	3,8	12	19	55	6	2
4	0,5	6,5	3,8	12	19	55	6	2
4	1,0	6,5	3,8	12	19	55	6	2
5	0,3	8,0	4,8	15	22	58	6	2
5	0,5	8,0	4,8	15	22	58	6	2
5	1,0	8,0	4,8	15	22	58	6	2
6	0,3	10,0	5,8	18	22	58	6	2
6	0,5	10,0	5,8	18	22	58	6	2
6	1,0	10,0	5,8	18	22	58	6	2
8	0,3	13,0	7,7	24	28	64	8	2
8	0,5	13,0	7,7	24	28	64	8	2
8	1,0	13,0	7,7	24	28	64	8	2
10	0,3	16,0	9,7	30	34	74	10	2
10	1,0	16,0	9,7	30	34	74	10	2
10	1,5	16,0	9,7	30	34	74	10	2
12	1,0	19,0	11,6	36	40	85	12	2
12	1,5	19,0	11,6	36	40	85	12	2
12	2,0	19,0	11,6	36	40	85	12	2
16	2,0	25,0	15,5	48	52	100	16	2
16	2,5	25,0	15,5	48	52	100	16	2
16	3,0	25,0	15,5	48	52	100	16	2
20	2,0	32,0	19,5	60	64	114	20	2
20	2,5	32,0	19,5	60	64	114	20	2
20	3,0	32,0	19,5	60	64	114	20	2
20	4,0	32,0	19,5	60	64	114	20	2
25	2,0	40,0	24,5	75	80	136	25	2
25	4,0	40,0	24,5	75	80	136	25	2

P	
M	
K	
N	•
S	•
H	
O	

→ v_c/f_z Page 460+461

End milling cutter with corner radius

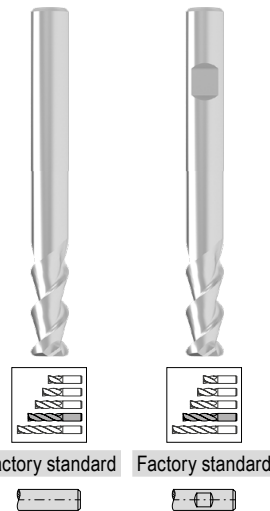
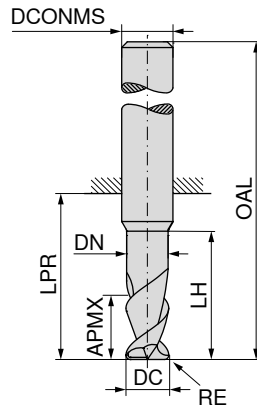
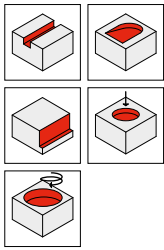
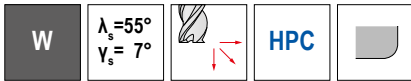

Factory standard Factory standard

54 594 ...	54 595 ...
	032
	034
	036
	042
	044
	046
	052
	054
	056
	062
	064
	066
	082
	084
	086
	102
	104
	106
	122
	124
	126
	162
	164
	166
	202
	204
	207
	252
	254

DC _{h6} mm	RE _{±0.01} mm	APMX mm	DN mm	LH mm	LPR mm	OAL mm	DCONMS _{h5} mm	ZEFP
3	0,2	8,0	2,8	15	22	58	6	2
3	0,3	8,0	2,8	15	22	58	6	2
3	0,5	8,0	2,8	15	22	58	6	2
4	0,3	10,5	3,8	20	26	62	6	2
4	0,5	10,5	3,8	20	26	62	6	2
4	1,0	10,5	3,8	20	26	62	6	2
5	0,3	13,0	4,8	25	34	70	6	2
5	0,5	13,0	4,8	25	34	70	6	2
5	1,0	13,0	4,8	25	34	70	6	2
6	0,3	16,0	5,8	30	34	70	6	2
6	0,5	16,0	5,8	30	34	70	6	2
6	1,0	16,0	5,8	30	34	70	6	2
8	0,3	21,0	7,7	40	44	80	8	2
8	0,5	21,0	7,7	40	44	80	8	2
8	1,0	21,0	7,7	40	44	80	8	2
10	0,5	26,0	9,7	50	54	94	10	2
10	1,0	26,0	9,7	50	54	94	10	2
10	1,5	26,0	9,7	50	54	94	10	2
12	1,0	31,0	11,6	60	64	109	12	2
12	1,5	31,0	11,6	60	64	109	12	2
12	2,0	31,0	11,6	60	64	109	12	2
16	2,0	41,0	15,5	80	84	132	16	2
16	2,5	41,0	15,5	80	84	132	16	2
16	4,0	41,0	15,5	80	84	132	16	2
20	2,0	52,0	19,5	100	104	154	20	2
20	2,5	52,0	19,5	100	104	154	20	2
20	4,0	52,0	19,5	100	104	154	20	2
25	2,0	65,0	24,5	125	130	186	25	2
25	4,0	65,0	24,5	125	130	186	25	2

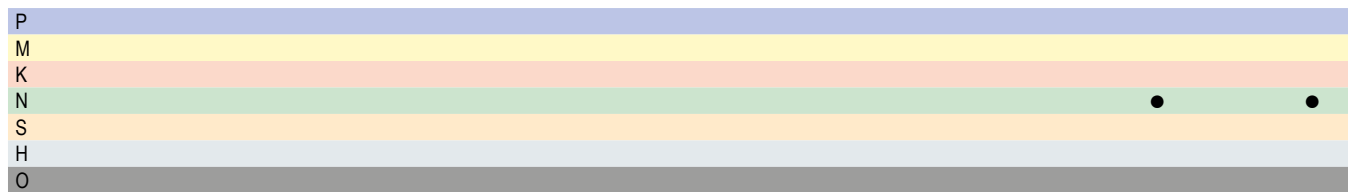

→ v_c/f_z Page 460+461

Slot milling cutter

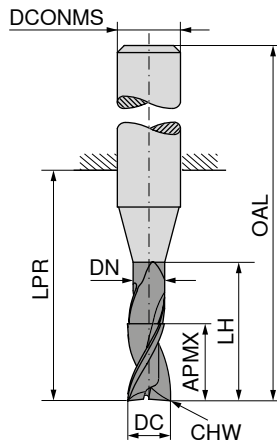
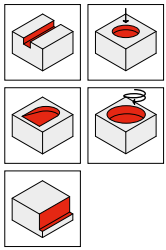
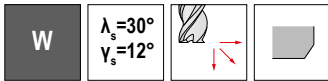

DIAMOND



Factory standard



52 762 ...

DC mm	DC Tol.	APMX mm	DN mm	LH mm	LPR mm	OAL mm	DCONMS _{h6} mm	CHW mm	ZEFP	
2	h10	8	1,8	31	32	60	2	0,04	2	020
3	h10	12	2,8	41	42	70	3	0,07	2	030
4	h10	15	3,8	51	52	80	4	0,07	2	040
5	h10	20	4,8	71	72	100	5	0,12	2	050
6	h10	20	5,8	63	64	100	6	0,12	2	060
8	h10	20	7,8	83	84	120	8	0,12	2	080
10	h10	25	9,8	99	100	140	10	0,20	2	100
12	h10	25	11,8	104	105	150	12	0,20	2	120

P
M
K
N
S
H
O

→ v_c/f_z Page 418

End milling cutter

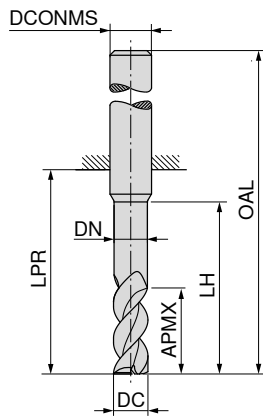
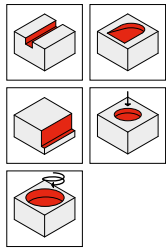
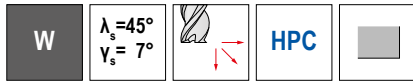

LPR with Shank DIN 6535 HB

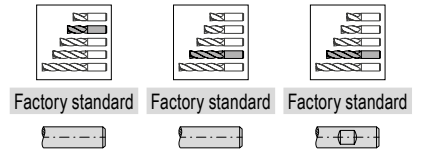
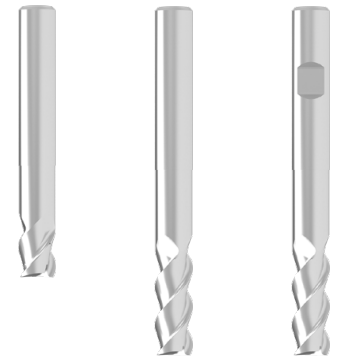

DC _{h6}	APMX	DN	LH	LPR	OAL	DCONMS _{h5}	ZEFP
mm	mm	mm	mm	mm	mm	mm	
3	3,5	2,8	12	19	55	6	3
3	3,5	2,8	15	22	58	6	3
3	8,0	2,8	15	22	58	6	3
4	4,5	3,8	12	19	55	6	3
4	4,5	3,8	20	26	62	6	3
4	10,5	3,8	20	26	62	6	3
5	5,5	4,8	15	22	58	6	3
5	5,5	4,8	25	34	70	6	3
5	13,0	4,8	25	34	70	6	3
6	7,0	5,8	18	22	58	6	3
6	7,0	5,8	30	34	70	6	3
6	16,0	5,8	30	34	70	6	3
7	21,0	6,7	40	44	80	8	3
8	9,0	7,7	24	28	64	8	3
8	9,0	7,7	40	44	80	8	3
8	21,0	7,7	40	44	80	8	3
9	26,0	8,7	50	54	94	10	3
10	11,0	9,7	30	34	74	10	3
10	11,0	9,7	50	54	94	10	3
10	26,0	9,7	50	54	94	10	3
11	31,0	10,6	60	64	109	12	3
12	13,0	11,6	36	40	85	12	3
12	13,0	11,6	60	64	109	12	3
12	31,0	11,6	60	64	109	12	3
13	36,0	12,6	70	74	119	14	3
14	15,0	13,6	42	46	91	14	3
14	15,0	13,6	70	74	119	14	3
14	36,0	13,6	70	74	119	14	3
15	17,0	14,5	48	52	100	16	3
15	17,0	14,5	80	84	132	16	3
15	41,0	14,5	80	84	132	16	3
16	17,0	15,5	48	52	100	16	3
16	17,0	15,5	80	84	132	16	3
16	41,0	15,5	80	84	132	16	3
18	20,0	17,5	54	58	106	18	3
18	20,0	17,5	90	94	142	18	3
18	47,0	17,5	90	94	142	18	3
20	22,0	19,5	60	64	114	20	3
20	22,0	19,5	100	104	154	20	3
20	52,0	19,5	100	104	154	20	3
25	27,0	24,5	75	80	136	25	3
25	27,0	24,5	125	130	186	25	3

54 610 ...	54 610 ...	54 611 ...
033	034	
	032	032
043	044	
	042	042
053	054	
	052	052
063	064	
	062	062
	072	072
083	084	
	082	082
	092	092
103	104	
	102	102
	112	112
123	124	
	122	122
	132	132
143	144	
	142	142
153	154	
	152	152
163	164	
	162	162
183	184	
	182	182
203	204	
	202	202
253	254	

P			
M			
K			
N		•	•
S			
H			
O			

End milling cutter

W $\lambda_s = 45^\circ$ $\gamma_s = 7^\circ$ HPC

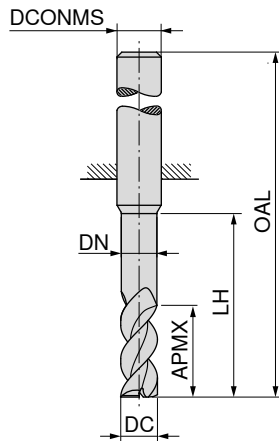
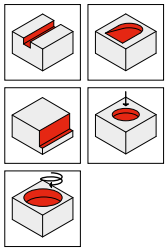

Factory standard



54 610 ...

DC _{h6} mm	APMX mm	DN mm	LH mm	OAL mm	DCONMS _{h5} mm	ZEFP
3	3,5	2,8	24	67	6	3
4	4,5	3,8	32	74	6	3
5	5,5	4,8	40	88	6	3
6	7,0	5,8	48	88	6	3
8	9,0	7,7	64	104	8	3
10	11,0	9,7	80	124	10	3
12	13,0	11,6	96	145	12	3
14	15,0	13,6	112	161	14	3
16	17,0	15,5	128	180	16	3
18	20,0	17,5	144	196	18	3
20	22,0	19,5	160	214	20	3

- 035
- 045
- 055
- 065
- 085
- 105
- 125
- 145
- 165
- 185
- 205

P

M

K

N

S

H

O

→ v_c/f_z Page 460+461

End milling cutter with corner radius

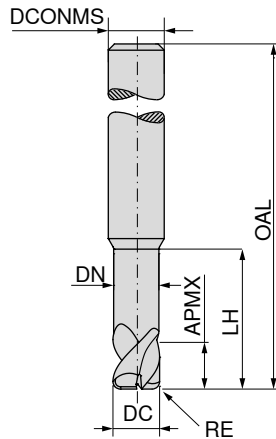
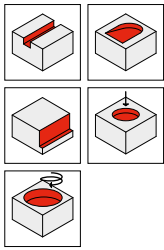
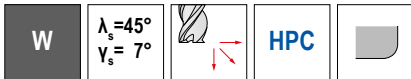

Factory standard



54 620 ...

DC _{h6} mm	RE _{±0.01} mm	APMX mm	DN mm	LH mm	OAL mm	DCONMS _{h5} mm	ZEFP	
3	0,4	3,5	2,8	12	55	6	3	034
3	0,6	3,5	2,8	12	55	6	3	035
4	0,4	4,5	3,8	12	55	6	3	044
4	0,6	4,5	3,8	12	55	6	3	046
5	0,4	5,5	4,8	15	58	6	3	054
5	0,6	5,5	4,8	15	58	6	3	056
6	0,4	7,0	5,8	18	58	6	3	064
6	0,6	7,0	5,8	18	58	6	3	066
8	0,4	9,0	7,7	24	64	8	3	084
8	0,6	9,0	7,7	24	64	8	3	086
8	0,8	9,0	7,7	24	64	8	3	087
10	1,6	11,0	9,7	30	74	10	3	103
12	2,0	13,0	11,6	36	85	12	3	124
14	0,6	15,0	13,6	42	91	14	3	146
14	0,8	15,0	13,6	42	91	14	3	147
16	1,6	17,0	15,5	48	100	16	3	163
16	3,2	17,0	15,5	48	100	16	3	167
18	1,6	20,0	17,5	54	106	18	3	183
20	3,2	22,0	19,5	60	114	20	3	207
20	5,0	22,0	19,5	60	114	20	3	209

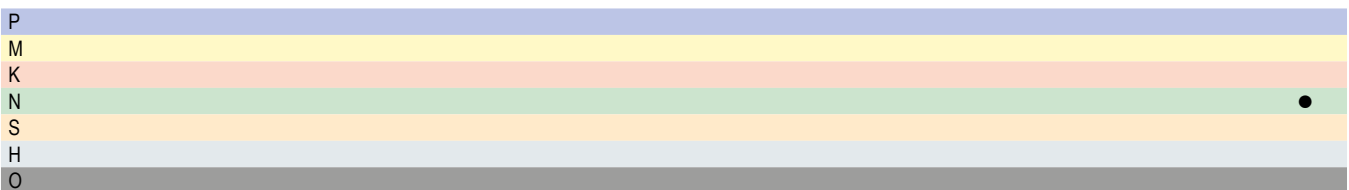

→ v_c/f_z Page 460+461

End milling cutter

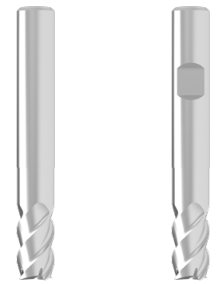
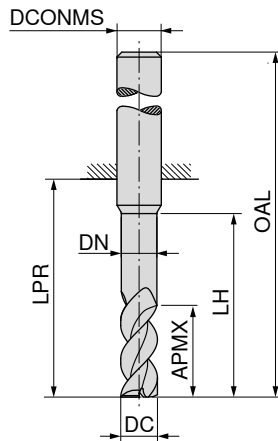
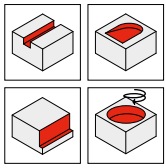

Factory standard



Factory standard



DC _{h6} mm	APMX mm	DN mm	LH mm	LPR mm	OAL mm	DCONMS _{h5} mm	ZEFP
6	10	5,8	18	22	58	6	4
7	13	6,7	24	28	64	8	4
8	13	7,7	24	28	64	8	4
9	16	8,7	30	34	74	10	4
10	16	9,7	30	34	74	10	4
11	19	10,6	36	40	85	12	4
12	19	11,6	36	40	85	12	4
13	22	12,6	42	46	91	14	4
14	22	13,6	42	46	91	14	4
15	25	14,5	48	52	100	16	4
16	25	15,5	48	52	100	16	4
18	29	17,5	54	58	106	18	4
20	32	19,5	60	64	114	20	4

54 630 ...	54 631 ...
061	061
071	071
081	081
091	091
101	101
111	111
121	121
131	131
141	141
151	151
161	161
181	181
201	201

P	
M	
K	
N	
S	•
H	
O	

→ v_c/f_z Page 460+461

End milling cutter

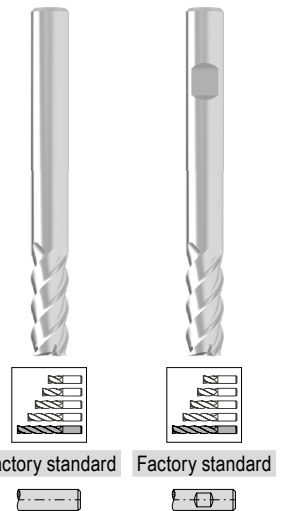
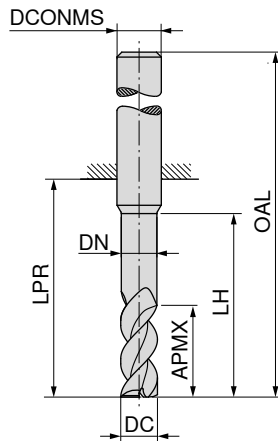
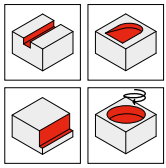
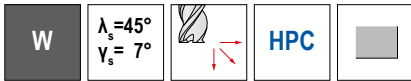

Factory standard Factory standard

54 630 ...	54 631 ...
062	062
072	072
082	082
092	092
102	102
112	112
122	122
132	132
142	142
152	152
162	162
182	182
202	202

DC _{h6} mm	APMX mm	DN mm	LH mm	LPR mm	OAL mm	DCONMS _{h5} mm	ZEFP
6	16	5,8	30	34	70	6	4
7	21	6,7	40	44	80	8	4
8	21	7,7	40	44	80	8	4
9	26	8,7	50	54	94	10	4
10	26	9,7	50	54	94	10	4
11	31	10,6	60	64	109	12	4
12	31	11,6	60	64	109	12	4
13	36	12,6	70	74	119	14	4
14	36	13,6	70	74	119	14	4
15	41	14,5	80	84	132	16	4
16	41	15,5	80	84	132	16	4
18	47	17,5	90	94	142	18	4
20	52	19,5	100	104	154	20	4

P
M
K
N
S
H
O

→ v_c/f_z Page 460+461

End milling cutter

W
 $\lambda_s=38^\circ$
 $\gamma_s=17^\circ$
HPC

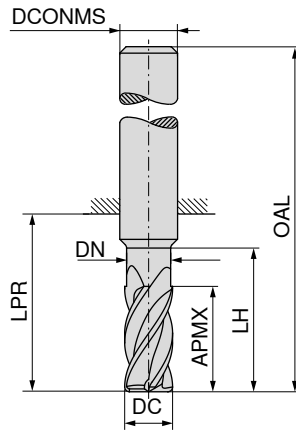

Factory standard



54 650 ...

DC _{h6} mm	APMX mm	DN mm	LH mm	LPR mm	OAL mm	DCONMS _{h5} mm	ZEFP	
6	19	5,8	30	34	70	6	5	062
8	25	7,7	40	44	80	8	5	082
10	31	9,7	50	54	94	10	5	102
12	37	11,6	60	64	109	12	5	122
14	43	13,6	70	74	119	14	5	142
16	49	15,5	80	84	132	16	7	162
18	56	17,5	90	94	142	18	7	182
20	62	19,5	100	104	154	20	7	202

P
M
K
N
S
H
O

→ v_c/f_z Page 460+461

End milling cutter

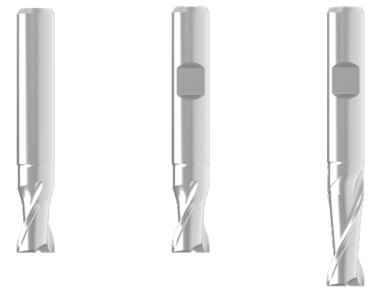
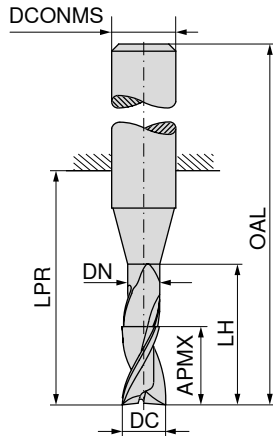
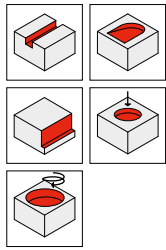

Factory standard

Factory standard

Factory standard



52 942 ...

52 941 ...

52 948 ...

DC _{es} mm	APMX mm	DN mm	LH mm	LPR mm	OAL mm	DCONMS _{h6} mm	ZEPF			
0,20	0,4			10	38	3	2			92000
0,25	0,5			10	38	3	2			92500
0,30	1,0			10	38	3	2			93000
0,35	1,0			10	38	3	2			93500
0,40	1,0			10	38	3	2			94000
0,50	1,5			10	38	3	2			95000
0,60	1,5			10	38	3	2			96000
0,70	2,0			10	38	3	2			97000
0,80	2,0			10	38	3	2			98000
0,90	2,5			10	38	3	2			99000
1,00	3,0			10	38	3	2			31000
1,00	4,0	0,90	6	22	58	6	2			01000
1,10	3,0			10	38	3	2			31100
1,20	4,0			10	38	3	2			31200
1,30	4,0			10	38	3	2			31300
1,40	4,0			10	38	3	2			31400
1,50	3,0	1,40	6	18	54	6	2			01500
1,50	4,0			10	38	3	2		01500	
1,50	6,0	1,40	8	22	58	6	2			01500
1,60	4,0			10	38	3	2			31600
1,80	5,0			10	38	3	2			31800
2,00	4,0	1,90	8	18	54	6	2			02000
2,00	7,0	1,90	10	22	58	6	2			02000
2,50	4,0	2,40	8	18	54	6	2			02500
2,50	6,0			10	38	3	2			32500
2,80	4,0	2,70	9	18	54	6	2			02800
2,80	7,0	2,70	12	22	58	6	2			02800
3,00	6,0	2,90	9	18	54	6	2			03000
3,00	10,0	2,90	14	22	58	6	2			03000
3,50	6,0	3,30	9	18	54	6	2			03500
3,80	7,0	3,60	12	18	54	6	2			03800
3,80	10,0	3,60	18	22	58	6	2			03800
4,00	7,0	3,80	12	18	54	6	2			04000
4,00	13,0	3,80	18	22	58	6	2			04000
4,50	7,0	4,30	12	18	54	6	2			04500
4,80	8,0	4,60	16	18	54	6	2			04800
4,80	13,0	4,60	18	22	58	6	2			04800
5,00	8,0	4,80	16	18	54	6	2			05000
5,00	15,0	4,80	18	22	58	6	2			05000
5,50	8,0	5,30	16	18	54	6	2			05500
5,75	10,0	5,55	16	18	54	6	2			05700

P	●	●	●
M	○	○	○
K	●	●	●
N	○	○	○
S	○	○	○
H			
O	○	○	○

→ v_c/f_z Page 480–483

End milling cutter

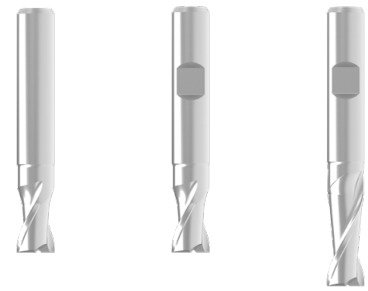
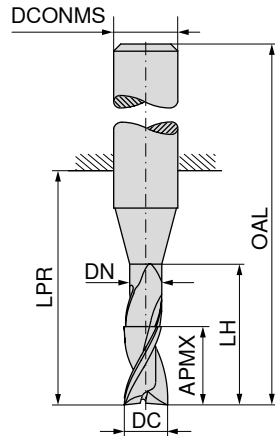
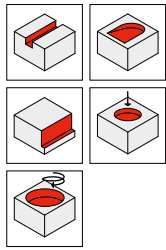

Factory standard

Factory standard

Factory standard



52 942 ...

52 941 ...

52 948 ...

DC _{es} mm	APMX mm	DN mm	LH mm	LPR mm	OAL mm	DCONMS _{h6} mm	ZEPF
5,75	15,0	5,55	18	22	58	6	2
6,00	10,0	5,80	16	18	54	6	2
6,00	16,0	5,80	20	22	58	6	2
6,75	10,0	6,45	16	23	59	8	2
6,75	16,0	6,45	23	34	70	8	2
7,00	12,0	6,70	18	23	59	8	2
7,00	16,0	6,70	23	34	70	8	2
7,75	12,0	7,45	18	23	59	8	2
7,75	16,0	7,45	23	34	70	8	2
8,00	12,0	7,70	20	23	59	8	2
8,00	22,0	7,70	25	34	70	8	2
8,70	12,0	8,40	12	27	67	10	2
9,70	13,0	9,40	13	27	67	10	2
9,70	22,0	9,40	22	33	73	10	2
10,00	13,0	9,70	13	27	67	10	2
10,00	25,0	9,70	25	33	73	10	2
11,00	25,0	10,60	25	39	84	12	2
12,00	16,0	11,60	16	28	73	12	2
12,00	26,0	11,60	26	39	84	12	2
13,70	16,0	13,30	26	30	75	14	2
13,70	26,0	13,30	35	39	84	14	2
14,00	16,0	13,60	28	30	75	14	2
14,00	26,0	13,60	35	39	84	14	2
16,00	20,0	15,50	32	35	83	16	2
16,00	30,0	15,50	40	45	93	16	2
20,00	25,0	19,50	40	43	93	20	2
20,00	40,0	19,50	50	54	104	20	2

P	●	●	●
M	○	○	○
K	●	●	●
N	○	○	○
S	○	○	○
H			
O	○	○	○

→ v_c/f_z Page 480-483

End milling cutter

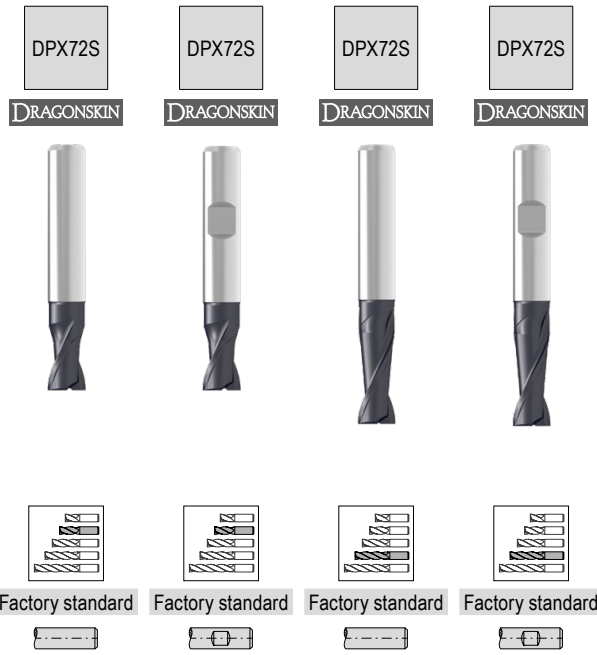
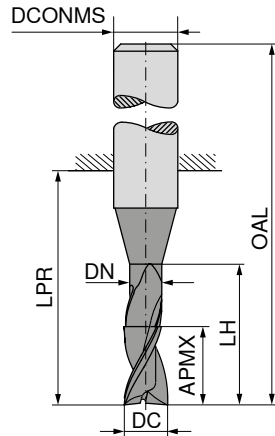
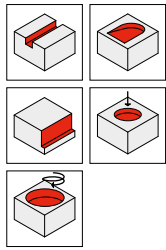

52 943 ... 52 944 ... 52 947 ... 52 949 ...

DC _{es} mm	APMX mm	DN mm	LH mm	LPR mm	OAL mm	DCONMS _{h6} mm	ZEFP	52 943 ...	52 944 ...	52 947 ...	52 949 ...
0,20	0,4			10	38	3	2	92000			
0,25	0,5			10	38	3	2	92500			
0,30	1,0			10	38	3	2	93000			
0,35	1,0			10	38	3	2	93500			
0,40	1,0			10	38	3	2	94000			
0,50	1,5			10	38	3	2	95000			
0,60	1,5			10	38	3	2	96000			
0,70	2,0			10	38	3	2	97000			
0,80	2,0			10	38	3	2	98000			
0,90	2,5			10	38	3	2	99000			
1,00	3,0			10	38	3	2	31000			
1,00	4,0	0,90	6	22	58	6	2			01000	01000
1,10	3,0			10	38	3	2	31100			
1,20	4,0			10	38	3	2	31200			
1,30	4,0			10	38	3	2	31300			
1,40	4,0			10	38	3	2	31400			
1,50	4,0			10	38	3	2	31500			
1,50	6,0	1,40	8	22	58	6	2			01500	01500
1,50	3,0	1,40	6	18	54	6	2	01500	01500		
1,60	4,0			10	38	3	2	31600			
1,80	5,0			10	38	3	2	31800			
2,00	4,0	1,90	8	18	54	6	2	02000	02000		
2,00	7,0	1,90	10	22	58	6	2			02000	02000
2,00	5,0			10	38	3	2	32000			
2,50	4,0	2,40	8	18	54	6	2	02500	02500		
2,50	6,0			10	38	3	2	32500			
2,80	4,0	2,70	9	18	54	6	2	02800	02800		
2,80	7,0	2,70	12	22	58	6	2			02800	02800
3,00	6,0	2,90	9	18	54	6	2	03000	03000		
3,00	10,0	2,90	14	22	58	6	2			03000	03000
3,00	6,0			10	38	3	2	33000			
3,50	6,0	3,30	9	18	54	6	2	03500	03500		
3,80	7,0	3,60	12	18	54	6	2	03800	03800		
3,80	10,0	3,60	18	22	58	6	2			03800	03800
4,00	7,0	3,80	12	18	54	6	2	04000	04000		
4,00	13,0	3,80	18	22	58	6	2			04000	04000
4,50	7,0	4,30	12	18	54	6	2	04500	04500		
4,80	8,0	4,60	16	18	54	6	2	04800	04800		
4,80	13,0	4,60	18	22	58	6	2			04800	04800
5,00	8,0	4,80	16	18	54	6	2	05000	05000		

P	●	●	●	●
M	○	○	○	○
K	●	●	●	●
N	○	○	○	○
S	○	○	○	○
H	○	○	○	○
O	○	○	○	○

End milling cutter

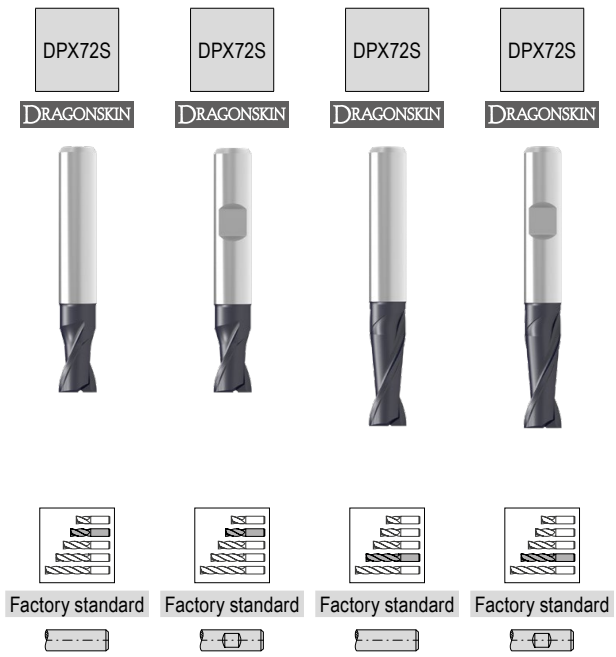
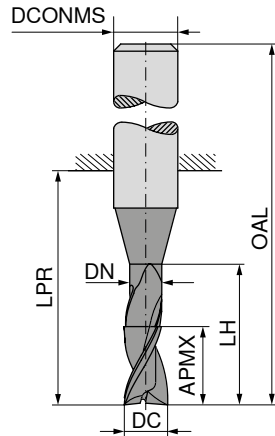
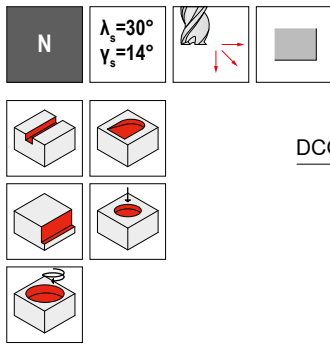

DC _{es} mm	APMX mm	DN mm	LH mm	LPR mm	OAL mm	DCONMS _{h6} mm	ZEFP
5,00	15,0	4,80	18	22	58	6	2
5,50	8,0	5,30	16	18	54	6	2
5,75	10,0	5,55	16	18	54	6	2
5,75	15,0	5,55	18	22	58	6	2
6,00	10,0	5,80	16	18	54	6	2
6,00	16,0	5,80	20	22	58	6	2
6,75	10,0	6,45	16	23	59	8	2
6,75	16,0	6,45	23	34	70	8	2
7,00	12,0	6,70	18	23	59	8	2
7,00	16,0	6,70	23	34	70	8	2
7,75	12,0	7,45	18	23	59	8	2
7,75	16,0	7,45	23	34	70	8	2
8,00	12,0	7,70	20	23	59	8	2
8,00	22,0	7,70	25	34	70	8	2
8,70	12,0	8,40	12	27	67	10	2
9,00	13,0	8,70	13	27	67	10	2
9,00	22,0	8,70	22	33	73	10	2
9,70	13,0	9,40	13	27	67	10	2
9,70	22,0	9,40	22	33	73	10	2
10,00	13,0	9,70	13	27	67	10	2
10,00	25,0	9,70	25	33	73	10	2
11,00	25,0	10,60	25	39	84	12	2
11,70	16,0	11,30	16	28	73	12	2
12,00	16,0	11,60	16	28	73	12	2
12,00	26,0	11,60	26	39	84	12	2
13,70	16,0	13,30	26	30	75	14	2
14,00	16,0	13,60	28	30	75	14	2
16,00	20,0	15,50	32	35	83	16	2
16,00	30,0	15,50	40	45	93	16	2
18,00	20,0	17,50	34	37	85	18	2
20,00	25,0	19,50	40	43	93	20	2
20,00	40,0	19,50	50	54	104	20	2

52 943 ...	52 944 ...	52 947 ...	52 949 ...
		05000	05000
05500	05500		
05700	05700		
		05700	05700
06000	06000		
	06700	06000	06000
		06700	06700
07000	07000		
07700	07700		
		07700	07700
08000	08000		
	08700	08000	08000
09000	09000		
09700	09700	09000	09000
		09700	09700
10000	10000		
		10000	10000
		11000	11000
11700	11700		
12000	12000		
		12000	12000
	13700		
14000	14000		
16000	16000		
		16000	16000
18000	18000		
20000	20000		
		20000	20000

P	●	●	●	●
M	○	○	○	○
K	●	●	●	●
N	○	○	○	○
S	○	○	○	○
H	○	○	○	○
O	○	○	○	○

→ v_c/f_z Page 480-483

End milling cutter

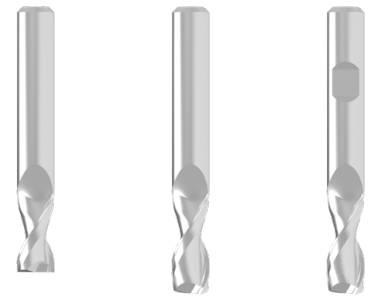
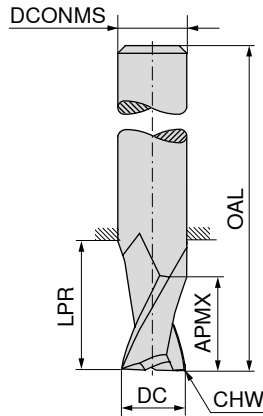
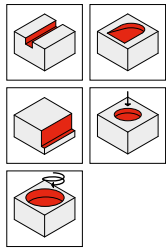
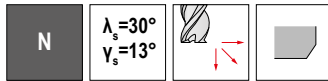

Factory standard



≈DIN 6527



≈DIN 6527



50 593 ...

50 594 ...

50 594 ...

DC _{es} mm	APMX mm	LPR mm	OAL mm	DCONMS _{h5} mm	CHW mm	ZEFP
0,25	0,5	10	38	3,0		2
0,30	1,0	10	38	3,0		2
0,35	1,0	10	38	3,0		2
0,40	1,0	10	38	3,0		2
0,50	1,5	10	38	3,0		2
0,60	1,5	10	38	3,0		2
0,70	2,0	10	38	3,0		2
0,80	2,0	10	38	3,0		2
0,90	2,5	10	38	3,0		2
1,00	3,0	22	50	3,0		2
1,10	3,0	22	50	3,0		2
1,20	4,0	22	50	3,0		2
1,40	4,0	22	50	3,0		2
1,50	4,0	22	50	3,0		2
1,60	4,0	22	50	3,0		2
1,80	5,0	22	50	3,0		2
2,00	5,0	22	50	3,0	0,07	2
2,00	8,0	8	32	2,0	0,07	2
2,50	6,0	22	50	3,0	0,07	2
2,50	8,0	8	32	2,5	0,07	2
2,80	8,0	21	57	6,0	0,07	2
3,00	8,0	21	57	6,0	0,15	2
3,00	12,0	12	32	3,0	0,15	2
3,50	12,0	12	32	3,5	0,15	2
3,80	11,0	21	57	6,0	0,15	2
4,00	11,0	21	57	6,0	0,15	2
4,00	12,0	12	40	4,0	0,15	2
4,50	14,0	22	50	4,5	0,15	2
4,80	13,0	21	57	6,0	0,15	2
5,00	13,0	21	57	6,0	0,15	2
5,00	14,0	22	50	5,0	0,15	2
5,50	16,0	22	50	5,5	0,15	2
5,80	13,0	21	57	6,0	0,15	2
6,00	13,0	21	57	6,0	0,15	2
6,50	16,0	16	50	6,5	0,15	2
6,80	16,0	27	63	8,0	0,15	2
7,00	16,0	27	63	8,0	0,15	2
7,00	20,0	24	60	7,0	0,15	2
7,50	20,0	24	60	7,5	0,15	2
7,80	19,0	27	63	8,0	0,15	2

P	●	●	●
M	○	○	○
K	●	●	●
N	○	○	○
S	○	○	○
H			
O	○	○	○

End milling cutter

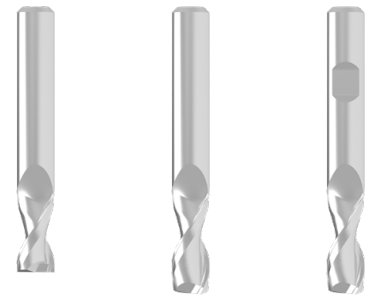
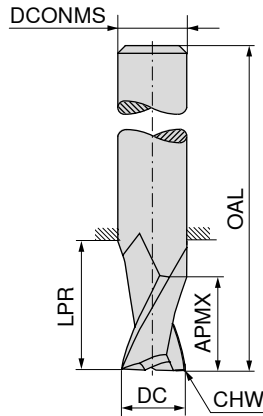
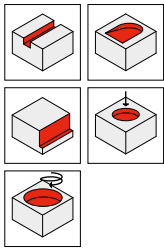
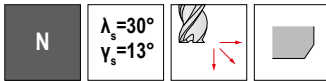

Factory standard

≈DIN 6527

≈DIN 6527



DC _{ø8} mm	APMX mm	LPR mm	OAL mm	DCONMS _{h5} mm	CHW mm	ZEP
8,00	19,0	27	63	8,0	0,15	2
8,50	20,0	24	60	8,5	0,15	2
8,70	19,0	32	72	10,0	0,15	2
9,00	19,0	32	72	10,0	0,15	2
9,00	20,0	24	60	9,0	0,15	2
9,50	22,0	34	70	9,5	0,15	2
9,70	22,0	32	72	10,0	0,15	2
10,00	22,0	32	72	10,0	0,15	2
10,70	26,0	38	83	12,0	0,15	2
11,00	22,0	30	70	11,0	0,15	2
11,00	26,0	38	83	12,0	0,15	2
11,70	26,0	38	83	12,0	0,15	2
12,00	26,0	38	83	12,0	0,15	2
13,00	25,0	30	75	13,0	0,15	2
13,70	26,0	38	83	14,0	0,15	2
14,00	22,0	30	75	14,0	0,15	2
14,00	26,0	38	83	14,0	0,15	2
15,00	25,0	30	75	15,0	0,15	2
15,70	32,0	44	92	16,0	0,15	2
16,00	32,0	44	92	16,0	0,15	2
17,70	32,0	44	92	18,0	0,15	2
18,00	32,0	44	92	18,0	0,15	2
19,70	38,0	54	104	20,0	0,15	2
20,00	38,0	54	104	20,0	0,15	2

50 593 ...	50 594 ...	50 594 ...
		080
085		
		087
		090
090		
095		
		097
		100
		107
110		
		110
		117
		120
130		
		137
140		
		140
150		
		157
		160
		177
		180
		197
		200

P	●	●	●
M	○	○	○
K	●	●	●
N	○	○	○
S	○	○	○
H			
O	○	○	○

→ v_c/f_z Page 480-483

End milling cutter

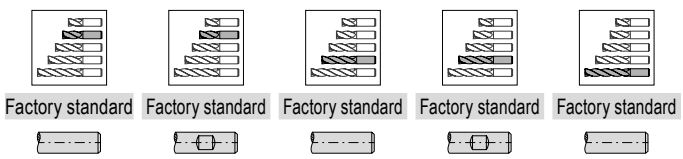
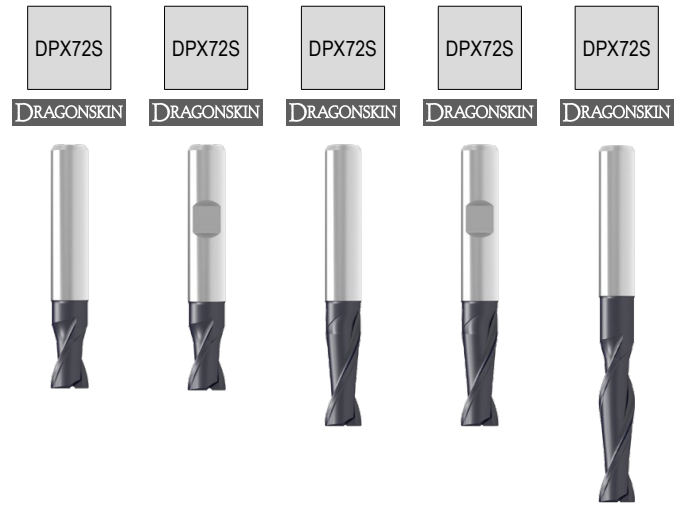
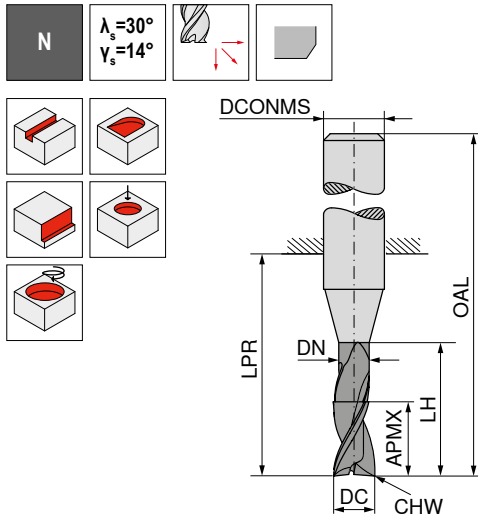

DC _{es}	APMX	DN	LH	LPR	OAL	DCONMS _{h6}	CHW	ZEFP	52 939 ...	52 940 ...	52 945 ...	52 946 ...	52 950 ...
mm	mm	mm	mm	mm	mm	mm	mm						
2,00	4	1,90	8	18	54	6	0,04	2	02000	02000			
2,00	5			10	38	3	0,04	2	32000				
2,00	6			10	38	2	0,04	2			22000		
2,00	7	1,90	10	22	58	6	0,04	2				02000	
2,50	4	2,40	8	18	54	6	0,07	2	02500	02500			
2,50	6			10	38	3	0,07	2	32500				
2,80	4	2,70	9	18	54	6	0,07	2	02800	02800			
2,80	7			10	38	3	0,07	2			32800		
2,80	7	2,70	12	22	58	6	0,07	2				02800	
3,00	6	2,90	9	18	54	6	0,07	2	03000	03000			
3,00	6			10	38	3	0,07	2	33000				
3,00	7			10	38	3	0,07	2			33000		
3,00	10	2,90	14	22	58	6	0,07	2				03000	
3,00	20	2,90	24	32	60	3	0,07	2					33000
3,50	6	3,30	9	18	54	6	0,07	2	03500	03500			
3,80	7	3,60	12	18	54	6	0,07	2	03800	03800			
3,80	8	3,60	20	22	50	4	0,07	2			43800		
3,80	10	3,60	18	22	58	6	0,07	2				03800	
4,00	7	3,80	12	18	54	6	0,07	2	04000	04000			
4,00	8	3,80	20	22	50	4	0,07	2			44000		
4,00	13	3,80	18	22	58	6	0,07	2				04000	
4,00	30	3,80	35	47	75	4	0,07	2					44000
4,50	7	4,30	12	18	54	6	0,12	2	04500	04500			
4,80	8	4,60	16	18	54	6	0,12	2	04800	04800			
4,80	10	4,60	20	22	50	5	0,12	2			54800		
4,80	13	4,60	18	22	58	6	0,12	2				04800	
5,00	8	4,80	16	18	54	6	0,12	2	05000	05000			
5,00	10	4,80	20	22	50	5	0,12	2			55000		
5,00	15	4,80	18	22	58	6	0,12	2				05000	
5,00	30	4,80	35	47	75	5	0,12	2					55000
5,50	8	5,30	16	18	54	6	0,12	2	05500	05500			
5,75	10	5,55	16	18	54	6	0,12	2	05700	05700			
5,75	15	5,55	18	22	58	6	0,12	2			05700	05700	
6,00	10	5,80	16	18	54	6	0,12	2	06000	06000			
6,00	16	5,80	20	22	58	6	0,12	2			06000	06000	
6,00	40	5,80	60	64	100	6	0,12	2					06000
6,75	16	6,45	23	34	70	8	0,12	2			06700	06700	
7,00	12	6,70	18	23	59	8	0,12	2	07000	07000			

P	●	●	●	●	●
M	○	○	○	○	○
K	●	●	●	●	●
N	○	○	○	○	○
S	○	○	○	○	○
H	○	○	○	○	○
O	○	○	○	○	○

End milling cutter

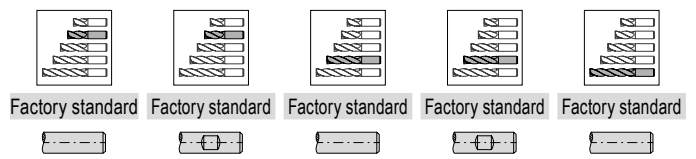
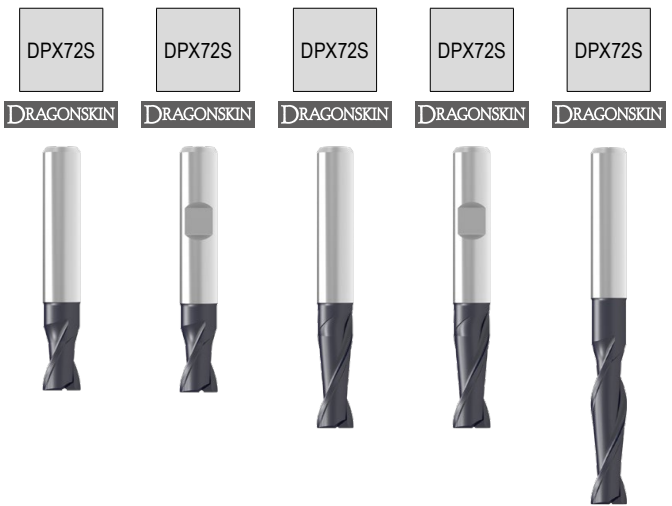
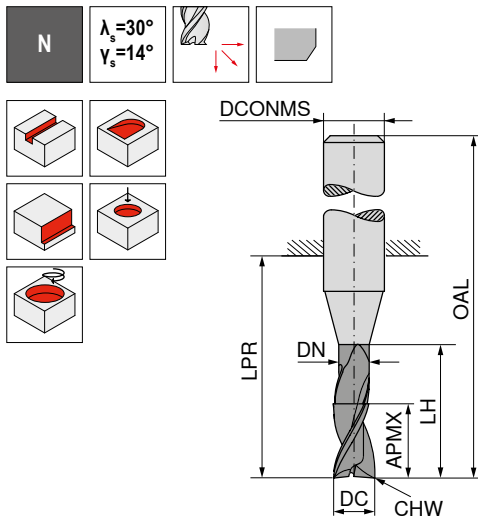

DC _{es} mm	APMX mm	DN mm	LH mm	LPR mm	OAL mm	DCONMS _{h6} mm	CHW mm	ZEFP
7,00	16	6,70	23	34	70	8	0,12	2
7,75	12	7,45	18	23	59	8	0,12	2
7,75	16	7,45	23	34	70	8	0,12	2
8,00	12	7,70	20	23	59	8	0,12	2
8,00	22	7,70	25	34	70	8	0,12	2
8,00	40	7,70	60	64	100	8	0,12	2
9,00	13	8,70	22	27	67	10	0,20	2
9,00	22	8,70	28	33	73	10	0,20	2
9,70	13	9,40	22	27	67	10	0,20	2
9,70	22	9,40	28	33	73	10	0,20	2
10,00	13	9,70	24	27	67	10	0,20	2
10,00	25	9,70	30	33	73	10	0,20	2
10,00	40	9,70	55	60	100	10	0,20	2
11,00	25	10,60	32	39	84	12	0,20	2
12,00	16	11,60	26	28	73	12	0,20	2
12,00	26	11,60	35	39	84	12	0,20	2
12,00	45	11,60	50	55	100	12	0,20	2
13,70	26	13,30	35	39	84	14	0,20	2
14,00	16	13,60	28	30	75	14	0,20	2
14,00	26	13,60	35	39	84	14	0,20	2
16,00	20	15,50	32	35	83	16	0,20	2
16,00	30	15,50	40	45	93	16	0,20	2
16,00	65	15,50	90	102	150	16	0,20	2
20,00	25	19,50	40	43	93	20	0,30	2
20,00	40	19,50	50	54	104	20	0,30	2
20,00	65	19,50	90	100	150	20	0,30	2

52 939 ...	52 940 ...	52 945 ...	52 946 ...	52 950 ...
			07000	07000
	07700	07700		
	08000	08000	07700	07700
			08000	08000
				08000
	09000	09000		
	09700	09700	09000	09000
			09700	09700
	10000	10000	10000	10000
				10000
	12000	12000	11000	11000
			12000	12000
			13700	13700
	14000	14000	14000	14000
	16000	16000	16000	16000
				16000
	20000	20000		
			20000	20000
				20000

P	●	●	●	●	●
M	○	○	○	○	○
K	●	●	●	●	●
N	○	○	○	○	○
S	○	○	○	○	○
H	○	○	○	○	○
O	○	○	○	○	○

→ v_c/f_z Page 480-485

End milling cutter

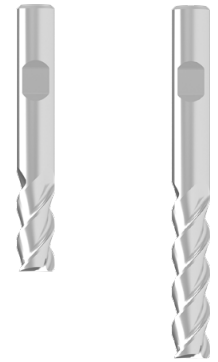
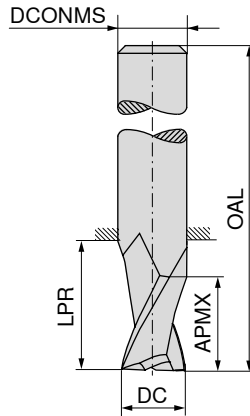
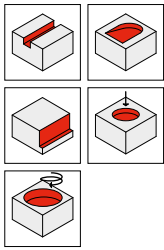
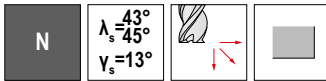

≈DIN 6527



≈DIN 6527



50 614 ...

50 614 ...

DC _{ø8} mm	APMX mm	LPR mm	OAL mm	DCONMS _{h5} mm	ZEFP
3,0	8	21	57	6	3
3,5	11	21	57	6	3
3,5	15	23	59	6	3
4,0	11	21	57	6	3
4,0	19	27	63	6	3
4,5	13	21	57	6	3
4,5	19	27	63	6	3
5,0	13	21	57	6	3
5,0	24	32	68	6	3
5,5	13	21	57	6	3
5,5	24	32	68	6	3
6,0	13	21	57	6	3
6,0	24	32	68	6	3
6,5	16	27	63	8	3
6,5	30	44	80	8	3
7,0	16	27	63	8	3
7,0	30	44	80	8	3
7,5	19	27	63	8	3
7,5	30	44	80	8	3
8,0	19	27	63	8	3
8,0	38	52	88	8	3
8,5	19	32	72	10	3
8,5	38	48	88	10	3
9,0	19	32	72	10	3
9,0	38	48	88	10	3
9,5	22	32	72	10	3
9,5	38	48	88	10	3
10,0	22	32	72	10	3
10,0	45	55	95	10	3
11,0	26	38	83	12	3
11,0	45	57	102	12	3
12,0	26	38	83	12	3
12,0	53	65	110	12	3
14,0	26	38	83	14	3
14,0	53	65	110	14	3
16,0	32	44	92	16	3
16,0	63	75	123	16	3
18,0	32	44	92	18	3
18,0	63	75	123	18	3
20,0	38	54	104	20	3
20,0	75	91	141	20	3

030	
035	
040	036
045	041
050	046
055	051
060	056
065	061
070	066
075	071
080	076
085	081
090	086
095	091
100	096
110	101
120	111
140	121
160	141
180	161
200	181
	201

P	○	○
M	●	●
K	○	○
N	○	○
S	●	●
H		
O	○	○

→ v_c/f_z Page 480–485

End milling cutter

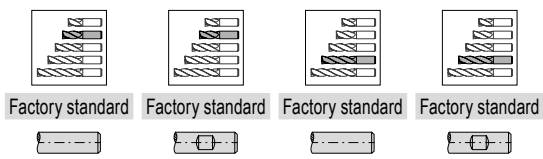
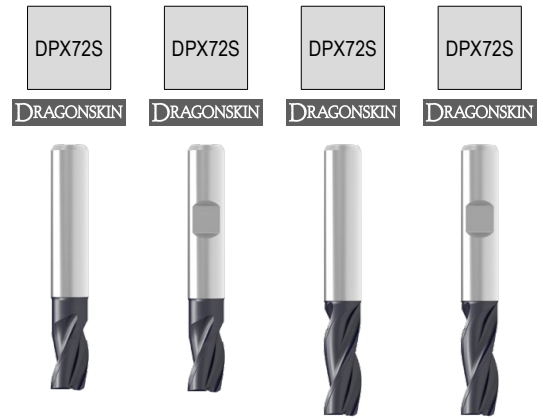
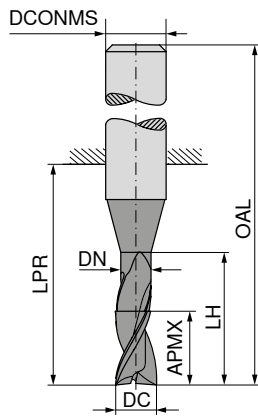
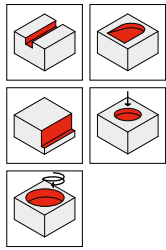
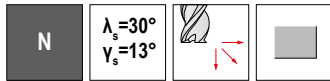

DC _{es}	APMX	DN	LH	LPR	OAL	DCONMS _{h6}	ZEFP
mm	mm	mm	mm	mm	mm	mm	
1,00	4	0,90	5	22	58	6	3
1,00	4			22	58	6	3
1,50	3	1,40	6	18	54	6	3
1,50	3	1,40	6	10	38	3	3
1,50	6	1,40	7	22	58	6	3
1,50	6			22	58	6	3
2,00	4	1,90	8	18	54	6	3
2,00	4	1,90	8	10	38	3	3
2,00	7	1,90	8	22	58	6	3
2,00	7			22	58	6	3
2,50	4	2,40	8	18	54	6	3
2,50	4	2,40	8	10	38	3	3
2,80	6	2,70	9	18	54	6	3
3,00	6	2,90	9	18	54	6	3
3,00	6	2,90	9	10	38	3	3
3,00	10	2,90	14	22	58	6	3
3,50	6	3,30	9	18	54	6	3
3,80	6	3,60	12	18	54	6	3
4,00	7	3,80	12	18	54	6	3
4,00	13	3,80	17	22	58	6	3
4,50	7	4,30	12	18	54	6	3
4,80	8	4,60	16	18	54	6	3
5,00	8	4,80	16	18	54	6	3
5,00	15	4,80	19	22	58	6	3
5,50	8	5,30	16	18	54	6	3
5,75	8	5,55	16	18	54	6	3
6,00	10	5,80	16	18	54	6	3
6,00	16	5,80	20	22	58	6	3
7,00	19	6,70	23	28	64	8	3
7,75	10	7,45	18	22	58	8	3
8,00	12	7,70	20	23	59	8	3
8,00	22	7,70	26	34	70	8	3
9,00	23	8,70	28	32	72	10	3
9,70	12	9,40	18	19	59	10	3
10,00	13	9,70	24	27	67	10	3
10,00	25	9,70	31	33	73	10	3
11,00	25	10,60	34	38	83	12	3
11,70	16	11,30	20	22	67	12	3

52 921 ...	52 922 ...	52 926 ...	52 927 ...
		01000	
	01500	01500	01000
	31500		
		01500	01500
	02000	02000	
	32000		
		02000	02000
	02500	02500	
	32500		
	02800	02800	
	03000	03000	
	33000		
	03500	03500	03000
	03800	03800	03000
	04000	04000	
	04500	04500	04000
	04800	04800	
	05000	05000	
	05500	05500	05000
	05700	05700	
	06000	06000	
		06000	06000
		07000	07000
	07700	07700	
	08000	08000	
		08000	08000
		09000	09000
	09700	09700	
	10000	10000	
		10000	10000
		11000	11000
	11700	11700	

P	●	●	●	●
M	○	○	○	○
K	●	●	●	●
N	○	○	○	○
S	○	○	○	○
H	○	○	○	○
O	○	○	○	○

End milling cutter

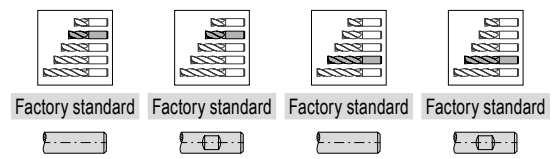
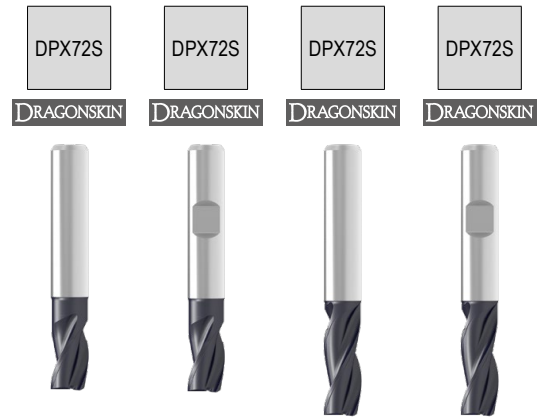
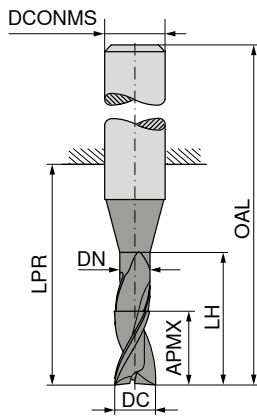
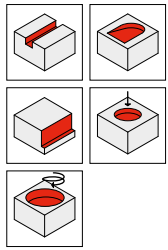
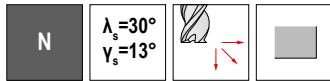

DC _{es} mm	APMX mm	DN mm	LH mm	LPR mm	OAL mm	DCONMS _{h6} mm	ZEFP
12,00	16	11,60	26	28	73	12	3
12,00	26	11,60	37	39	84	12	3
14,00	16	13,60	28	30	75	14	3
14,00	26	13,60	37	39	84	14	3
16,00	20	15,50	32	35	83	16	3
16,00	32	15,50	43	45	93	16	3
20,00	25	19,50	40	43	93	20	3
20,00	40	19,50	52	54	104	20	3

	52 921 ...	52 922 ...	52 926 ...	52 927 ...
	12000	12000	12000	12000
	14000	14000	14000	14000
	16000	16000	16000	16000
	20000	20000	20000	20000
P	●	●	●	●
M	○	○	○	○
K	●	●	●	●
N	○	○	○	○
S	○	○	○	○
H	○	○	○	○
O	○	○	○	○

→ v_c/f_z Page 480-483

End milling cutter

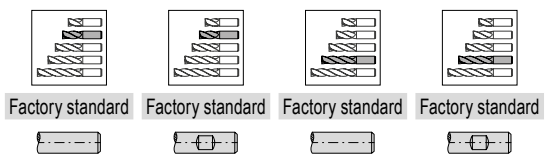
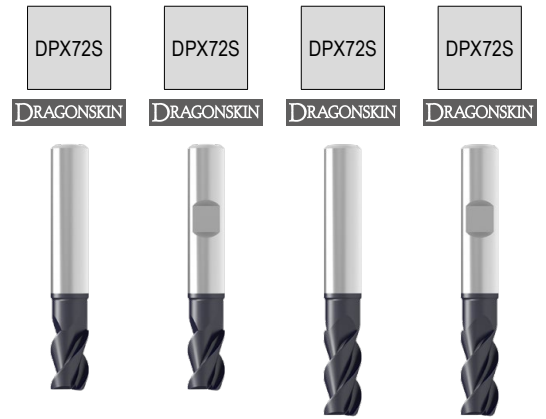
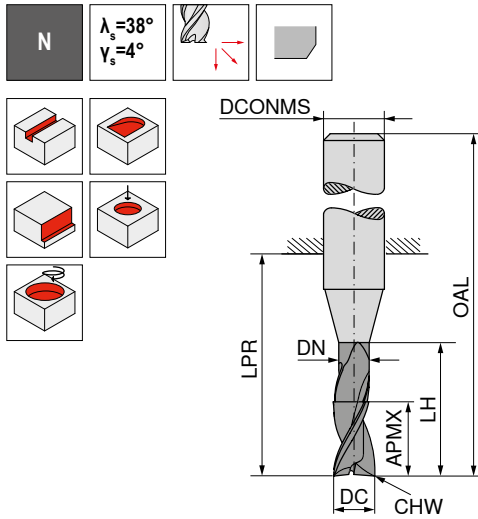

DC _{es} mm	APMX mm	DN mm	LH mm	LPR mm	OAL mm	CHW mm	DCONMS _{h6} mm	ZEFP
2,0	4	1,9	8	18	54	0,04	6	3
2,0	7	1,9	10	22	58	0,04	6	3
2,5	5	2,4	8	18	54	0,07	6	3
3,0	6	2,9	9	18	54	0,07	6	3
3,0	10	2,9	14	22	58	0,07	6	3
4,0	7	3,8	12	18	54	0,07	6	3
4,0	13	3,8	17	22	58	0,07	6	3
5,0	8	4,8	16	18	54	0,12	6	3
5,0	15	4,8	19	22	58	0,07	6	3
6,0	10	5,8	16	18	54	0,12	6	3
6,0	16	5,8	20	22	58	0,12	6	3
7,0	11	6,7	18	23	59	0,12	8	3
7,0	19	6,7	23	34	70	0,12	8	3
8,0	12	7,7	20	23	59	0,12	8	3
8,0	22	7,7	26	34	70	0,12	8	3
9,0	13	8,7	22	27	67	0,20	10	3
9,0	23	8,7	28	33	73	0,12	10	3
10,0	14	9,7	24	27	67	0,20	10	3
10,0	25	9,7	31	33	73	0,20	10	3
12,0	16	11,6	26	28	73	0,20	12	3
12,0	28	11,6	37	39	84	0,20	12	3
14,0	18	13,6	28	30	75	0,20	14	3
14,0	30	13,6	37	39	84	0,20	14	3
16,0	20	15,5	32	35	83	0,20	16	3
16,0	35	15,5	43	45	93	0,20	16	3
20,0	25	19,5	40	43	93	0,30	20	3
20,0	40	19,5	52	54	104	0,20	20	3

52 929 ...	52 930 ...	52 932 ...	52 933 ...
02000	02000		
02500	02500	02000	02000
03000	03000		03000
04000	04000	04000	04000
05000	05000	05000	05000
06000	06000	06000	06000
07000	07000	07000	07000
08000	08000	08000	08000
09000	09000	09000	09000
10000	10000	10000	10000
12000	12000	12000	12000
14000	14000	14000	14000
16000	16000	16000	16000
20000	20000	20000	20000

P	○	○	○	○
M	●	●	●	●
K	○	○	○	○
N	●	●	●	●
S	●	●	●	●
H				
O	●	●	●	●

→ v_c/f_z Page 480-483

End milling cutter

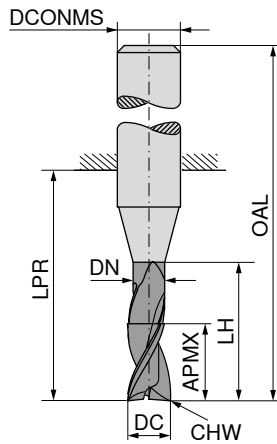
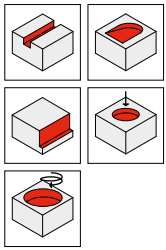
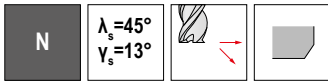

DPX72S

DRAGONSKIN



Factory standard



52 935 ...

DC _{es} mm	DN mm	APMX mm	LH mm	LPR mm	OAL mm	DCONMS ₁₆ mm	CHW mm	ZEFP	
3	3,0	20	20	24	60	6	0,07	3	03000
4	3,8	30	35	39	75	6	0,07	3	04000
5	4,8	30	35	39	75	6	0,12	3	05000
6	5,8	40	60	64	100	6	0,12	3	06000
8	7,7	40	60	64	100	8	0,12	3	08000
10	9,7	40	55	60	100	10	0,20	3	10000
12	11,6	45	50	55	100	12	0,20	3	12000
14	13,6	45	50	55	100	14	0,20	3	14000
16	15,5	65	90	102	150	16	0,20	3	16000
20	19,5	65	90	100	150	20	0,30	3	20000

P	○
M	●
K	○
N	●
S	●
H	○
O	●

→ v_c/f_z Page 480-485

Mini milling cutter

▲ Shank similar to DIN 6535

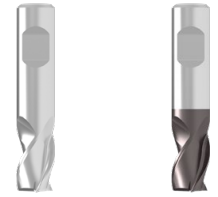
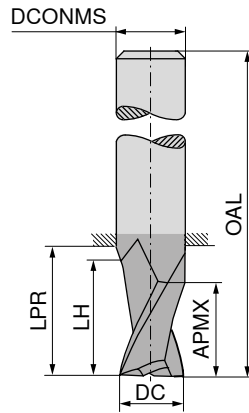
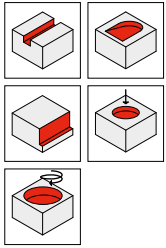

Ti1000



Factory standard



Factory standard



50 598 ...

50 599 ...

DC _{es} mm	APMX mm	LH mm	LPR mm	OAL mm	DCONMS _{h5} mm	ZFP
2,00	4	4,0	10	35	6	3
2,50	4	4,0	10	35	6	3
3,00	5	5,0	10	36	6	3
3,50	5	5,0	10	36	6	3
4,00	7	7,0	12	38	6	3
4,50	7	7,0	12	38	6	3
5,00	8	8,0	13	39	6	3
5,50	8	8,0	13	39	6	3
5,75	8	8,0	13	39	6	3
6,00	8	8,5	13	39	6	3
6,75	11	11,5	16	43	8	3
7,00	11	11,5	16	43	8	3
7,75	11	11,5	16	43	8	3
8,00	11	11,5	16	43	8	3
8,70	13	13,5	18	50	10	3
9,00	13	13,5	18	50	10	3
9,70	13	13,5	18	50	10	3
10,00	13	13,5	18	50	10	3
12,00	15	15,5	24	55	12	3
14,00	15	15,5	26	58	14	3
16,00	18	18,5	28	62	16	3
18,00	20	20,5	35	70	18	3
20,00	22	22,5	40	75	20	3

50 598 ...	50 599 ...
020	020
025	025
030	030
035	035
040	040
045	045
050	050
055	055
057	057
060	060
067	067
070	070
077	077
080	080
087	087
090	090
097	097
100	100
120	120
140	140
160	160
180	180
200	200

P	○	●
M	○	○
K	○	●
N	●	○
S	○	○
H		○
O	●	○

→ v_c/f_z Page 480-483

Mini milling cutter

▲ Shank similar to DIN 6535

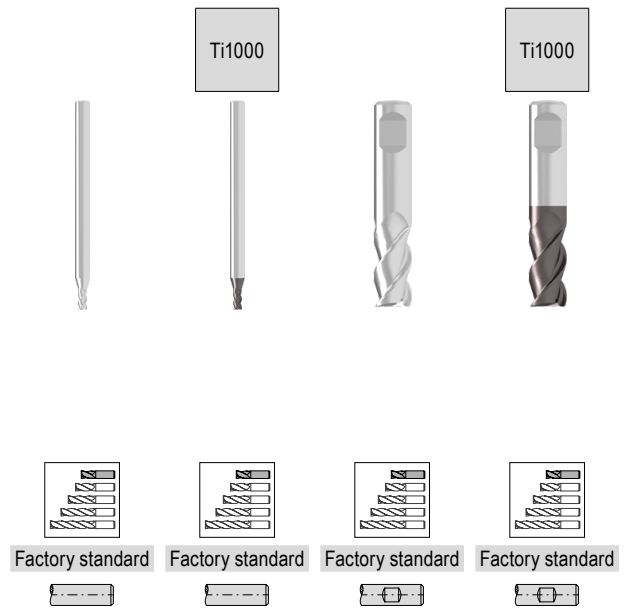
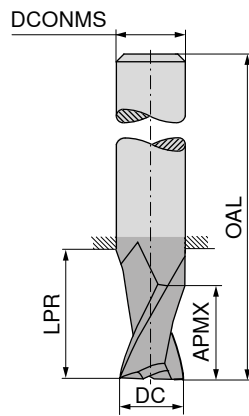
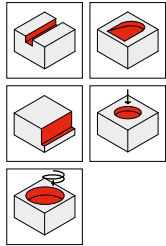
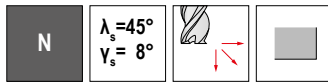

DC _{es} mm	APMX mm	LPR mm	OAL mm	DCONMS _{ns} mm	ZEFP	50 664 ...	50 691 ...	50 664 ...	50 691 ...
0,50	1,5	17	45	3	3	30500	30500		
1,00	2,0	12	45	6	3			01000	01000
1,00	2,0	17	45	3	3	31000	31000		
1,20	2,0	12	45	6	3			01200	01200
1,20	3,0	17	45	3	3	31200	31200		
1,50	3,0	12	45	6	3			01500	01500
1,50	3,0	17	45	3	3	31500	31500		
1,80	3,0	12	45	6	3			01800	01800
1,80	3,0	17	45	3	3	31800	31800		
2,00	4,0	13	45	6	3			02000	02000
2,50	6,0	13	45	6	3			02500	02500
2,80	6,0	13	45	6	3			02800	02800
3,00	6,0	13	45	6	3			03000	03000
3,50	7,0	13	45	6	3			03500	03500
3,80	7,0	13	45	6	3			03800	03800
4,00	7,0	12	45	6	3			04000	04000
4,50	8,0	11	45	6	3			04500	04500
4,80	8,0	11	45	6	3			04800	04800
5,00	8,0	11	45	6	3			05000	05000
5,50	8,0	9	45	6	3			05500	05500
5,75	8,0	9	45	6	3			05700	05700
6,00	8,0	9	45	6	3			06000	06000
6,70	10,0	19	55	8	3			06700	06700
7,00	12,0	19	55	8	3			07000	07000
7,70	12,0	19	55	8	3			07700	07700
8,00	13,0	19	55	8	3			08000	08000
8,70	14,0	17	55	10	3			08700	08700
9,00	16,0	17	55	10	3			09000	09000
9,70	16,0	17	55	10	3			09700	09700
10,00	16,0	17	55	10	3			10000	10000

P		●		●
M		●		●
K		●		●
N	●	○	●	○
S	○	●	○	●
H				
O				

→ v_c/f_z Page 456–459

Mini milling cutter

▲ Shank similar to DIN 6535

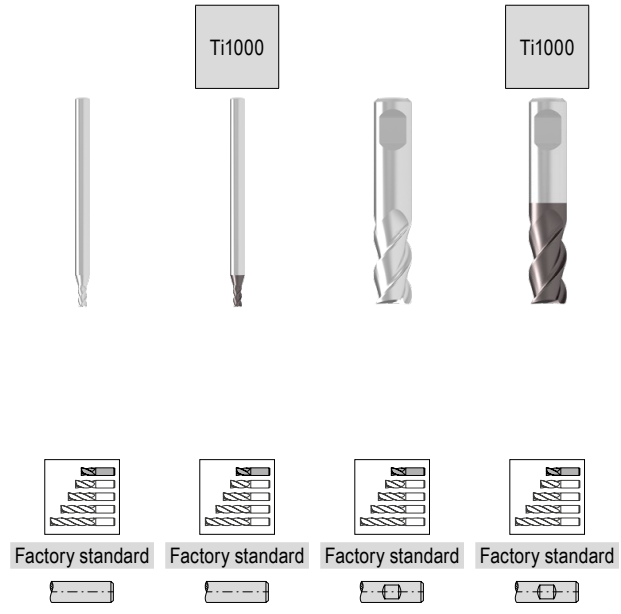
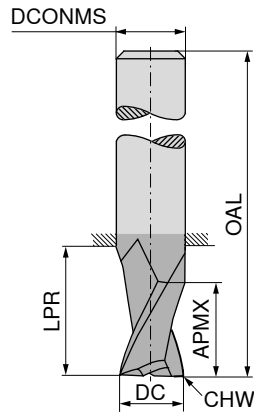
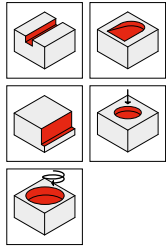
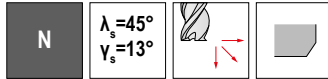

DC _{es} mm	CHW mm	APMX mm	LPR mm	OAL mm	DCONMS _{h5} mm	ZEFP
0,50	0,05	1,5	17	45	3	3
1,00	0,05	2,0	12	45	6	3
1,00	0,05	2,0	17	45	3	3
1,20	0,05	2,0	12	45	6	3
1,20	0,05	3,0	17	45	3	3
1,50	0,05	3,0	12	45	6	3
1,50	0,05	3,0	17	45	3	3
1,80	0,05	3,0	12	45	6	3
1,80	0,05	3,0	17	45	3	3
2,00	0,05	4,0	13	45	6	3
2,50	0,05	6,0	13	45	6	3
2,80	0,05	6,0	13	45	6	3
3,00	0,10	6,0	13	45	6	3
3,50	0,10	7,0	13	45	6	3
3,80	0,10	7,0	13	45	6	3
4,00	0,10	7,0	12	45	6	3
4,50	0,10	8,0	11	45	6	3
4,80	0,10	8,0	11	45	6	3
5,00	0,10	8,0	11	45	6	3
5,50	0,10	8,0	9	45	6	3
5,75	0,10	8,0	9	45	6	3
6,00	0,10	8,0	9	45	6	3
6,70	0,10	10,0	19	55	8	3
7,00	0,10	12,0	19	55	8	3
7,70	0,10	12,0	19	55	8	3
8,00	0,10	13,0	19	55	8	3
8,70	0,10	14,0	17	55	10	3
9,00	0,10	16,0	17	55	10	3
9,70	0,10	16,0	17	55	10	3
10,00	0,10	16,0	17	55	10	3

50 608 ...	50 609 ...	50 608 ...	50 609 ...
30500	30500		
31000	31000	01000	01000
31200	31200	01200	01200
31500	31500	01500	01500
31800	31800	01800	01800
		020	02000
		025	02500
		02800	02800
		030	03000
		03500	03500
		03800	03800
		040	04000
		04500	04500
		04800	04800
		050	05000
		05500	05500
		05700	05700
		060	06000
		06700	06700
		070	07000
		07700	07700
		080	08000
		08700	08700
		09000	09000
		09700	09700
		100	10000

P		●		●
M		●		●
K		●		●
N	●	○	●	○
S	○	●	○	●
H				
O				

→ v_c/f_z Page 456–459

End milling cutter

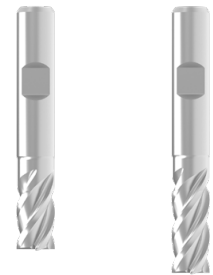
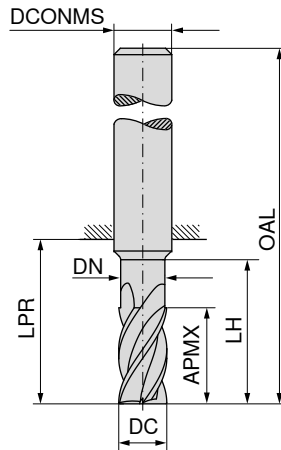
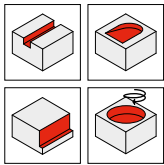

Factory standard



Factory standard



52 209 ...

52 213 ...

DC _{es} mm	APMX mm	DN mm	LH mm	LPR mm	OAL mm	DCONMS ₁₆ mm	ZEFP
2	4	1,9	8	18	54	6	4
2	7			22	58	6	4
3	6	2,9	9	18	54	6	4
3	10	2,8	14	22	58	6	4
4	7	3,8	12	18	54	6	4
4	13	3,8	17	22	58	6	4
5	8	4,8	16	18	54	6	4
5	15	4,8	19	22	58	6	4
6	10	5,8	16	18	54	6	4
6	16	5,7	20	22	58	6	4
8	12	7,7	20	22	58	8	4
8	22	7,7	26	34	70	8	4
10	14	9,7	24	26	66	10	4
10	25	9,6	31	33	73	10	4
12	16	11,6	26	28	73	12	4
12	28	11,6	37	39	84	12	4
14	18	13,6	28	30	75	14	4
16	22	15,5	32	34	82	16	4
16	35	15,6	43	45	93	16	4
18	20	17,5	34	32	80	18	4
20	25	19,5	40	42	92	20	4
20	40	19,6	52	54	104	20	4

P	●	●
M	○	○
K	●	●
N	○	○
S	○	○
H		
O	○	○

→ v_c/f_z Page 480-483

End milling cutter

▲ Cutting edges with irregular pitch

N
 $\lambda_s=30^\circ$
 $\gamma_s=12^\circ$

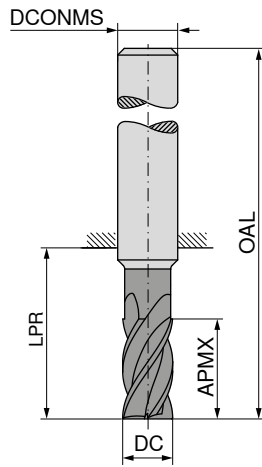
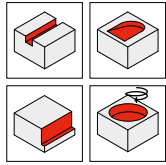
HPC

Ti1000 Ti1000 Ti1000 Ti1000

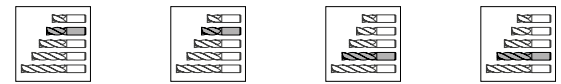

DIN 6527 DIN 6527 DIN 6527 ≈DIN 6527



52 121 ... 52 131 ... 52 126 ... 52 132 ...

DC _{es} mm	APMX mm	LPR mm	OAL mm	DCONMS ₁₆ mm	ZEPF	52 121 ...	52 131 ...	52 126 ...	52 132 ...
3,0	6	18	54	6	4	030	030		
3,0	10	22	58	6	4				030
3,5	7	18	54	6	4	035	035		
3,5	13	22	58	6	4			035	035
4,0	7	18	54	6	4	040	040		
4,0	13	22	58	6	4			040	040
4,5	8	18	54	6	4	045	045		
4,5	15	22	58	6	4			045	045
5,0	8	18	54	6	4	050	050		
5,0	15	22	58	6	4			050	050
6,0	10	18	54	6	4	060	060		
6,0	16	22	58	6	4			060	060
8,0	12	23	59	8	4	080	080		
8,0	22	34	70	8	4			080	080
10,0	14	27	67	10	4	100	100		
10,0	25	33	73	10	4			100	100
12,0	16	28	73	12	4	120	120		
12,0	28	39	84	12	4			120	120
14,0	16	30	75	14	4	140	140		
14,0	30	39	84	14	4			140	140
16,0	20	35	83	16	4	160	160		
16,0	35	45	93	16	4			160	160
18,0	20	32	80	18	4	180	180		
18,0	35	45	93	18	4			180	180
20,0	25	43	93	20	4	200	200		
20,0	40	54	104	20	4			200	200
P						●	●	●	●
M						○	○	○	○
K						●	●	●	●
N						○	○	○	○
S						○	○	○	○
H						○	○	○	○
O						○	○	○	○

→ v_c/f_z Page 480-483

End milling cutter

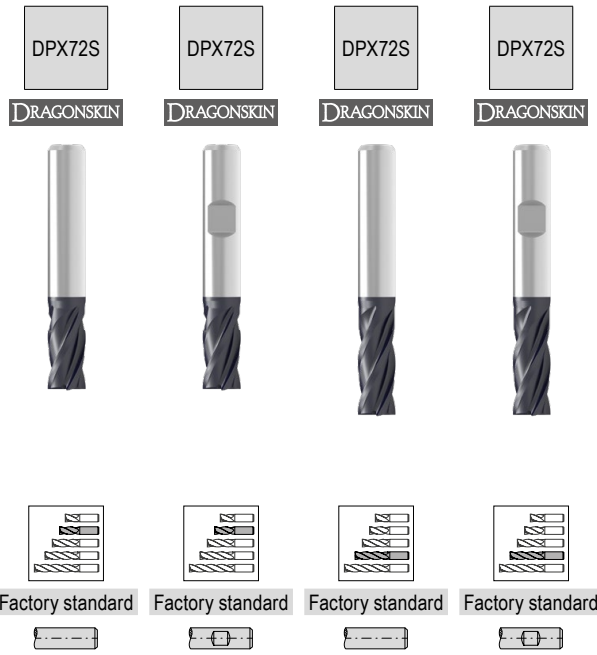
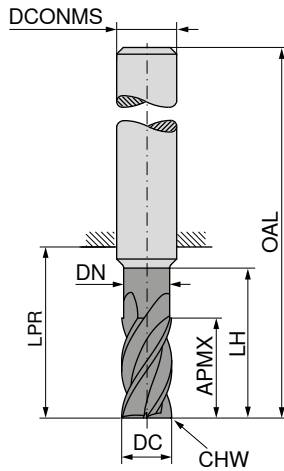
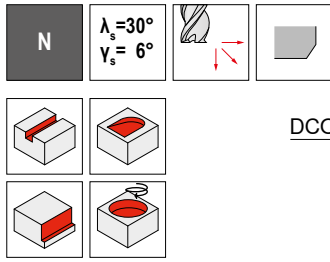

DC _{es} mm	APMX mm	DN mm	LH mm	LPR mm	OAL mm	DCONMS _{h6} mm	CHW mm	ZEFP
1,5	3	1,4	6	10	38	3	0,02	4
2,0	4	1,9	8	10	38	3	0,03	4
2,0	4	1,9	8	18	54	6	0,03	4
2,0	7			10	38	2	0,03	4
2,5	4	2,4	8	10	38	3	0,04	4
3,0	6	2,9	9	10	38	3	0,04	4
3,0	6	2,9	9	18	54	6	0,04	4
3,0	10	2,8	14	14	38	3	0,03	4
4,0	7	3,8	12	18	54	6	0,05	4
4,0	13	3,8	17	22	50	4	0,04	4
5,0	8	4,8	16	18	54	6	0,06	4
5,0	15	4,8	19	22	50	5	0,04	4
6,0	10	5,8	16	18	54	6	0,07	4
6,0	16	5,7	20	22	58	6	0,04	4
7,0	19	6,7	23	27	63	8	0,05	4
8,0	12	7,7	20	22	58	8	0,08	4
8,0	22	7,7	26	34	70	8	0,06	4
9,0	23	8,7	28	33	73	10	0,07	4
10,0	14	9,7	24	26	66	10	0,10	4
10,0	25	9,6	31	33	73	10	0,08	4
11,0	26	10,6	34	39	84	12	0,10	4
12,0	16	11,6	26	28	73	12	0,13	4
12,0	28	11,6	37	39	84	12	0,13	4
14,0	18	13,6	28	30	75	14	0,15	4
14,0	30	13,6	37	39	84	14	0,15	4
16,0	22	15,5	32	34	82	16	0,18	4
16,0	35	15,6	43	45	93	16	0,18	4
20,0	25	19,5	40	42	92	20	0,20	4
20,0	40	19,6	52	54	104	20	0,20	4

52 206 ...	52 207 ...	52 210 ...	52 211 ...
31500			
32000			
02000	02000		
		22000	
32500			
33000			
03000	03000		
		33000	
04000	04000		
		44000	
05000	05000		
		55000	
06000	06000		
		06000	06000
		07000	
08000	08000		
		08000	08000
		09000	
10000	10000		
		10000	10000
		11000	
12000	12000		
		12000	12000
14000	14000		
		14000	
16000	16000		
		16000	16000
20000	20000		
		20000	20000

P	●	●	●	●
M	○	○	○	○
K	●	●	●	●
N	○	○	○	○
S	○	○	○	○
H	○	○	○	○
O	○	○	○	○

→ v_c/f_z Page 480-483

End milling cutter

▲ Transition angle $\alpha = 30^\circ$

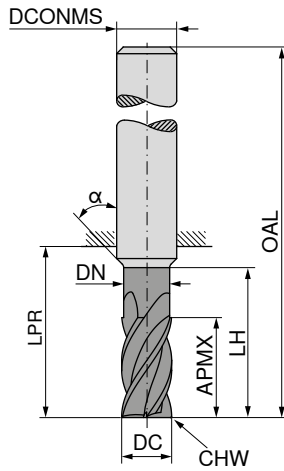
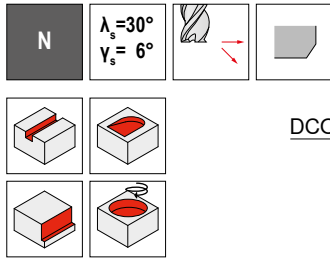

DC _{es} mm	APMX mm	DN mm	LH mm	LPR mm	OAL mm	DCONMS _{h6} mm	CHW mm	ZEFP
3	16	2,8	32	47	75	3	0,04	4
4	16	3,8	32	47	75	4	0,05	4
4	20	3,8	48	72	100	4	0,05	4
5	20	4,8	35	47	75	5	0,06	4
5	25	4,8	55	72	100	5	0,06	4
6	24	5,8	42	44	80	6	0,07	4
6	30	5,8	62	64	100	6	0,07	4
8	32	7,8	60	64	100	8	0,08	4
8	40	7,8	75	84	120	8	0,08	4
10	40	9,8	58	60	100	10	0,10	4
10	50	9,8	78	80	120	10	0,10	4
12	48	11,8	60	75	120	12	0,13	4
12	60	11,8	90	105	150	12	0,13	4
14	45	13,8	50	55	100	14	0,15	4
14	56	13,8	95	105	150	14	0,15	4
16	50	15,8	70	77	125	16	0,18	4
16	65	15,8	95	102	150	16	0,18	4
18	72	17,8	95	102	150	18	0,18	4
20	60	19,8	80	85	135	20	0,20	4
20	80	19,8	95	100	150	20	0,20	4
25	75	24,5	90	94	150	25	0,25	4

52 219 ...	52 214 ...	52 222 ...
	33000	
	44000	
	44100	
	55000	
	55100	
06000		
08000		06000
		08000
10000		
12000		12000
14000		
16000		14000
		16000
20000		18000
25000		20000

P	●	●	●
M	○	○	○
K	●	●	●
N	○	○	○
S	○	○	○
H	○	○	○
O	○	○	○

→ v_c/f_z Page 480–485

End milling cutter with corner radius

▲ optimal quiet running with irregular helix

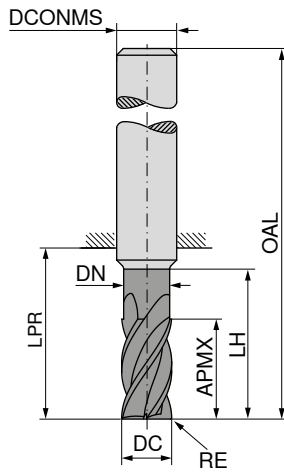
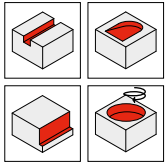
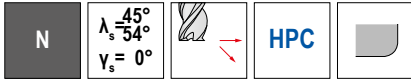

Ti1000



Factory standard



52 102 ...

DC _{e8} mm	RE _{±0.01} mm	APMX mm	DN mm	LH mm	OAL mm	DCONMS _{H6} mm	ZEFP	
2	0,2	7	1,8	11	58	6	4	022
3	0,3	8	2,8	13	58	6	4	033
4	0,4	11	3,8	16	58	6	4	044
5	0,5	13	4,8	18	58	6	4	055
6	0,5	16	5,8	26	58	6	4	065
6	1,0	16	5,8	26	58	6	4	066
8	0,5	22	7,8	32	64	8	4	085
8	1,0	22	7,8	32	64	8	4	086
8	1,5	22	7,8	32	64	8	4	087
10	0,5	25	9,8	35	73	10	4	105
10	1,0	25	9,8	35	73	10	4	106
10	1,5	25	9,8	35	73	10	4	107
12	0,5	28	11,8	38	84	12	4	125
12	1,0	28	11,8	38	84	12	4	126
12	1,5	28	11,8	38	84	12	4	127

P	○
M	●
K	○
N	●
S	●
H	
O	●

→ v_c/f_z Page 480-483

End milling cutter with corner radius

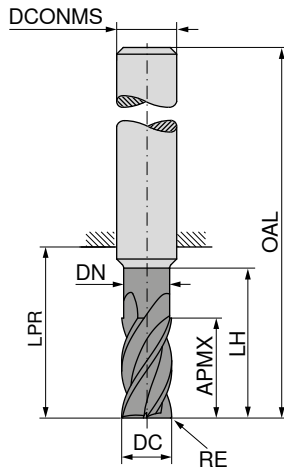
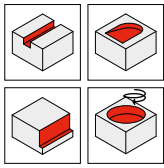

DPX72S

DRAGONSKIN



Factory standard





52 231 ...

DC _{e8} mm	RE _{±0.01} mm	APMX mm	DN mm	LH mm	LPR mm	OAL mm	DCONMS _{h6} mm	ZEFP	
3	0,3	8	2,8	13	21	57	6	4	03003
3	0,5	8	2,8	13	21	57	6	4	03005
4	0,3	11	3,8	16	21	57	6	4	04003
4	0,5	11	3,8	16	21	57	6	4	04005
5	0,3	13	4,8	18	21	57	6	4	05003
5	0,5	13	4,8	18	21	57	6	4	05005
6	0,5	13	5,8	26	21	57	6	4	06005
6	1,0	13	5,8	26	21	57	6	4	06010
6	1,5	13	5,8	26	21	57	6	4	06015
8	0,5	19	7,8	32	27	63	8	4	08005
8	1,0	19	7,8	32	27	63	8	4	08010
8	1,5	19	7,8	32	27	63	8	4	08015
8	2,0	19	7,8	32	27	63	8	4	08020
10	1,0	22	9,8	35	32	72	10	4	10010
10	1,5	22	9,8	35	32	72	10	4	10015
10	2,0	22	9,8	35	32	72	10	4	10020
12	1,0	26	11,8	38	38	83	12	4	12010
12	1,5	26	11,8	38	38	83	12	4	12015
12	2,0	26	11,8	38	38	83	12	4	12020
12	3,0	26	11,8	38	38	83	12	4	12030
16	1,0	32	15,8	44	44	92	16	4	16010
16	1,5	32	15,8	44	44	92	16	4	16015
16	2,0	32	15,8	44	44	92	16	4	16020
16	3,0	32	15,8	44	44	92	16	4	16030
20	1,5	38	19,8	52	54	104	20	4	20015
20	2,0	38	19,8	52	54	104	20	4	20020
20	3,0	38	19,8	52	54	104	20	4	20030

P	●
M	○
K	●
N	○
S	○
H	○
O	○

→ v_c/f_z Page 480–483

End milling cutter

N
 $\lambda_s = 35^\circ$
 $\gamma_s = 38^\circ$
 $\nu_s = 9^\circ$

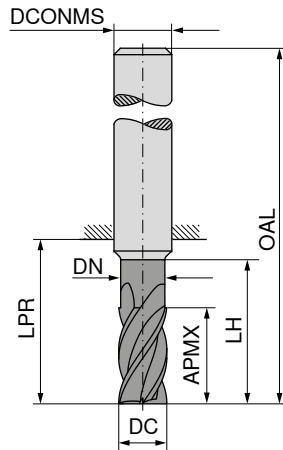
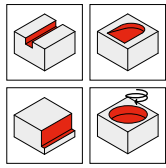
HPC



Ti1000 Ti1000 Ti1000



≈DIN 6527



≈DIN 6527



≈DIN 6527



DC _{h10} mm	APMX mm	DN mm	LH mm	LPR mm	OAL mm	DCONMS _{h6} mm	ZEFP
3	5			14	50	6	4
3	8	2,8	13	21	57	6	4
3	8	2,8	15	22	69	6	4
4	8			18	54	6	4
4	11	3,8	17	21	57	6	4
4	11	3,8	20	26	69	6	4
5	9			18	54	6	4
5	13	4,8	19	21	57	6	4
5	13	4,8	25	34	69	6	4
6	10			18	54	6	4
6	13	5,8	19	21	57	6	4
6	13	5,8	30	34	69	6	4
8	12			22	58	8	4
8	17	7,7	40	44	79	8	4
8	21	7,7	25	27	63	8	4
10	14			26	66	10	4
10	21	9,7	50	54	93	10	4
10	22	9,7	30	32	72	10	4
12	16			28	73	12	4
12	25	11,6	60	64	108	12	4
12	26	11,6	36	38	83	12	4
16	22			34	82	16	4
16	32	15,5	42	44	92	16	4
16	33	15,5	80	84	132	16	4
20	26			42	92	20	4
20	38	19,5	52	54	104	20	4
20	42	19,5	100	104	154	20	4

54 070 ...	54 070 ...	54 070 ...
03100		
	03200	
		03400
04100		
	04200	
		04400
05100		
	05200	
		05400
06100		
	06200	
		06400
08100		
	08200	
		08400
10100		
	10200	
		10400
12100		
	12200	
		12400
16100		
	16200	
		16400
20100		
	20200	
		20400

P	●	●	●
M	●	●	○
K	●	●	●
N	○	○	
S	○	○	
H			
O			

→ v_c/f_z Page 462–467

End milling cutter

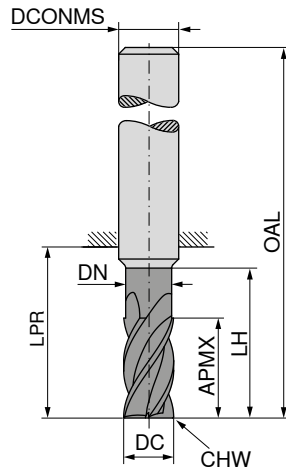
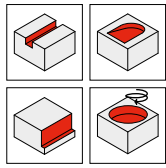
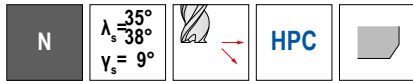

≈DIN 6527

≈DIN 6527

≈DIN 6527



54 071 ...

54 071 ...

54 071 ...

DC _{h10} mm	APMX mm	DN mm	LH mm	LPR mm	OAL mm	DCONMS _{h6} mm	CHW mm	ZEFP
3	5			14	50	6	0,1	4
3	8	2,8	13	21	57	6	0,1	4
3	8	2,8	15	22	69	6	0,1	4
4	8			18	54	6	0,1	4
4	11	3,8	17	21	57	6	0,1	4
4	11	3,8	20	26	69	6	0,1	4
5	9			18	54	6	0,1	4
5	13	4,8	19	21	57	6	0,1	4
5	13	4,8	25	34	69	6	0,1	4
6	10			18	54	6	0,1	4
6	13	5,8	19	21	57	6	0,1	4
6	13	5,8	30	34	69	6	0,1	4
8	12			22	58	8	0,2	4
8	17	7,7	40	44	79	8	0,2	4
8	21	7,7	25	27	63	8	0,2	4
10	14			26	66	10	0,2	4
10	21	9,7	50	54	93	10	0,2	4
10	22	9,7	30	32	72	10	0,2	4
12	16			28	73	12	0,3	4
12	25	11,6	60	64	108	12	0,3	4
12	26	11,6	36	38	83	12	0,3	4
16	22			34	82	16	0,3	4
16	33	15,5	80	84	132	16	0,3	4
16	36	15,5	42	44	92	16	0,3	4
20	26			42	92	20	0,3	4
20	41	19,5	52	54	104	20	0,3	4
20	42	19,5	100	104	154	20	0,3	4

03100	03200	03400
04100	04200	04400
05100	05200	05400
06100	06200	06400
08100	08200	08400
10100	10200	10400
12100	12200	12400
16100	16200	16400
20100	20200	20400

P	●	●	●
M	●	●	○
K	●	●	●
N	○	○	○
S	○	○	○
H			
O			

→ v_c/f_z Page 462-467

End milling cutter

▲ Cutting depth: 3 x DC

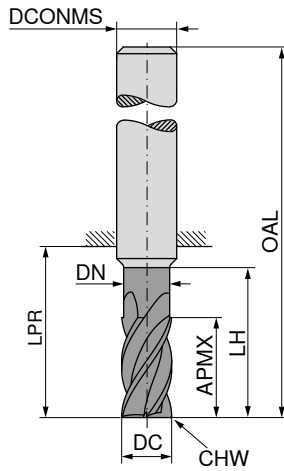
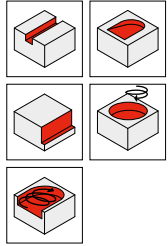
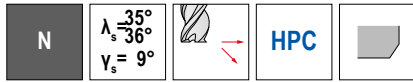

NEW
Ti1000



≈DIN 6527



54 078 ...

DC _{rs} mm	APMX mm	DN mm	LH mm	LPR mm	OAL mm	DCONMS _{h6} mm	CHW mm	ZEFP	
6	19	5,8	24	26	62	6	0,1	4	06200
8	25	7,7	30	32	68	8	0,2	4	08200
10	31	9,7	38	40	80	10	0,2	4	10200
12	37	11,6	46	48	93	12	0,2	4	12200
16	49	15,5	58	60	108	16	0,3	4	16200
20	61	19,5	74	76	126	20	0,3	4	20200

P	•
M	•
K	•
N	
S	
H	
O	

→ v_c/f_z Page 464+465

End milling cutter with corner radius

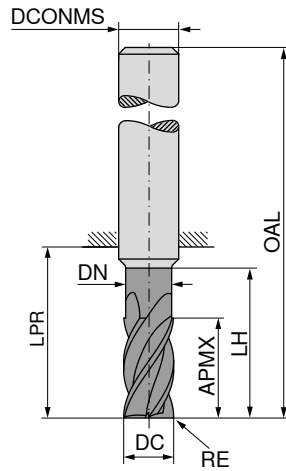
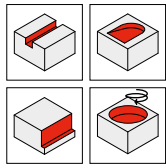
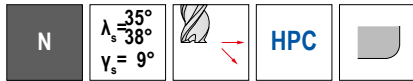

DC _{h10} mm	RE _{±0.05} mm	APMX mm	DN mm	LH mm	LPR mm	OAL mm	DCONMS _{h6} mm	ZEFP
3	0,1	8	2,8	13	21	57	6	4
3	0,3	8	2,8	13	21	57	6	4
3	0,5	8	2,8	13	21	57	6	4
3	1,0	8	2,8	13	21	57	6	4
3	0,5	8	2,8	15	22	69	6	4
3	0,3	8	2,8	15	22	69	6	4
3	1,0	8	2,8	15	22	69	6	4
4	0,1	11	3,8	17	21	57	6	4
4	0,3	11	3,8	17	21	57	6	4
4	0,5	11	3,8	17	21	57	6	4
4	1,0	11	3,8	17	21	57	6	4
4	0,5	11	3,8	20	26	69	6	4
4	0,3	11	3,8	20	26	69	6	4
4	1,0	11	3,8	20	26	69	6	4
5	0,5	13	4,8	19	21	57	6	4
5	0,1	13	4,8	19	21	57	6	4
5	0,3	13	4,8	19	21	57	6	4
5	1,0	13	4,8	19	21	57	6	4
5	0,5	13	4,8	25	34	69	6	4
5	0,3	13	4,8	25	34	69	6	4
5	1,0	13	4,8	25	34	69	6	4
6	0,3	13	5,8	19	21	57	6	4
6	0,1	13	5,8	19	21	57	6	4
6	0,5	13	5,8	19	21	57	6	4
6	1,0	13	5,8	19	21	57	6	4
6	1,5	13	5,8	19	21	57	6	4
6	2,0	13	5,8	19	21	57	6	4
6	1,0	13	5,8	30	34	69	6	4
6	0,3	13	5,8	30	34	69	6	4
6	0,5	13	5,8	30	34	69	6	4
6	1,5	13	5,8	30	34	69	6	4
6	2,0	13	5,8	30	34	69	6	4
8	0,5	17	7,7	40	44	79	8	4
8	0,3	17	7,7	40	44	79	8	4
8	1,0	17	7,7	40	44	79	8	4
8	1,5	17	7,7	40	44	79	8	4
8	2,0	17	7,7	40	44	79	8	4
8	0,1	21	7,7	25	27	63	8	4
8	0,3	21	7,7	25	27	63	8	4
8	0,5	21	7,7	25	27	63	8	4
8	1,0	21	7,7	25	27	63	8	4

	54 072 ...	54 072 ...
P	●	●
M	●	○
K	●	●
N	○	
S	○	
H		
O		

54 072 ...	54 072 ...
03201	
03203	
03205	
03210	
	03405
	03403
	03410
04201	
04203	
04205	
04210	
	04405
	04403
	04410
05205	
05201	
05203	
05210	
	05405
	05403
	05410
06203	
06201	
06205	
06210	
06215	
06220	
	06410
	06403
	06405
	06415
	06420
	08405
	08403
	08410
	08415
	08420
08201	
08203	
08205	
08210	

End milling cutter with corner radius

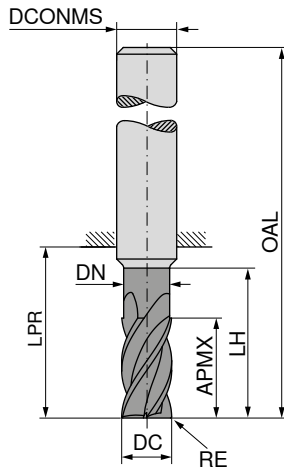
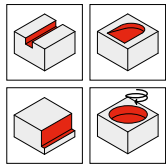
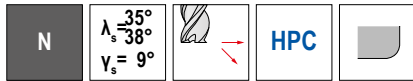

DC _{h10}	RE _{±0.05}	APMX	DN	LH	LPR	OAL	DCONMS _{h6}	ZEFP
mm	mm	mm	mm	mm	mm	mm	mm	
8	1,5	21	7,7	25	27	63	8	4
8	2,0	21	7,7	25	27	63	8	4
10	1,0	21	9,7	50	54	93	10	4
10	0,3	21	9,7	50	54	93	10	4
10	0,5	21	9,7	50	54	93	10	4
10	1,5	21	9,7	50	54	93	10	4
10	2,0	21	9,7	50	54	93	10	4
10	0,5	22	9,7	30	32	72	10	4
10	0,1	22	9,7	30	32	72	10	4
10	0,3	22	9,7	30	32	72	10	4
10	1,0	22	9,7	30	32	72	10	4
10	1,5	22	9,7	30	32	72	10	4
10	2,0	22	9,7	30	32	72	10	4
12	1,5	25	11,6	60	64	108	12	4
12	0,3	25	11,6	60	64	108	12	4
12	0,5	25	11,6	60	64	108	12	4
12	1,0	25	11,6	60	64	108	12	4
12	2,0	25	11,6	60	64	108	12	4
12	3,0	25	11,6	60	64	108	12	4
12	0,3	26	11,6	36	38	83	12	4
12	0,1	26	11,6	36	38	83	12	4
12	0,5	26	11,6	36	38	83	12	4
12	1,0	26	11,6	36	38	83	12	4
12	1,5	26	11,6	36	38	83	12	4
12	2,0	26	11,6	36	38	83	12	4
12	3,0	26	11,6	36	38	83	12	4
16	1,5	33	15,5	80	84	132	16	4
16	0,3	33	15,5	80	84	132	16	4
16	0,5	33	15,5	80	84	132	16	4
16	1,0	33	15,5	80	84	132	16	4
16	2,0	33	15,5	80	84	132	16	4
16	3,0	33	15,5	80	84	132	16	4
16	4,0	33	15,5	80	84	132	16	4
16	0,3	36	15,5	42	44	92	16	4
16	0,1	36	15,5	42	44	92	16	4
16	0,5	36	15,5	42	44	92	16	4
16	1,0	36	15,5	42	44	92	16	4
16	1,5	36	15,5	42	44	92	16	4
16	2,0	36	15,5	42	44	92	16	4
16	3,0	36	15,5	42	44	92	16	4
16	4,0	36	15,5	42	44	92	16	4

54 072 ...	54 072 ...
08215	
08220	
	10410
	10403
	10405
	10415
	10420
10205	
10201	
10203	
10210	
10215	
10220	
	12415
	12403
	12405
	12410
	12420
	12430
12203	
12201	
12205	
12210	
12215	
12220	
12230	
	16415
	16403
	16405
	16410
	16420
	16430
	16440
16203	
16201	
16205	
16210	
16215	
16220	
16230	
16240	

P	●	●
M	●	○
K	●	●
N	○	
S	○	
H		
O		

End milling cutter with corner radius

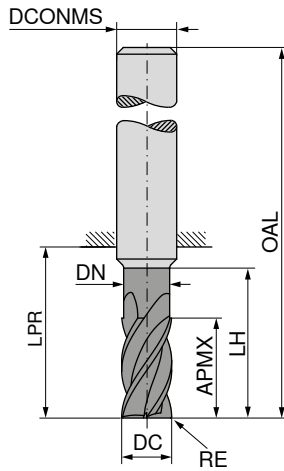
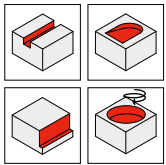

54 072 ...	54 072 ...
20201	
20203	
20205	
20210	
20215	
20220	
20230	
20240	
	20415
	20403
	20405
	20410
	20420
	20430
	20440

DC _{h10}	RE _{±0.05}	APMX	DN	LH	LPR	OAL	DCONMS _{h6}	ZEFP
mm	mm	mm	mm	mm	mm	mm	mm	
20	0,1	41	19,5	52	54	104	20	4
20	0,3	41	19,5	52	54	104	20	4
20	0,5	41	19,5	52	54	104	20	4
20	1,0	41	19,5	52	54	104	20	4
20	1,5	41	19,5	52	54	104	20	4
20	2,0	41	19,5	52	54	104	20	4
20	3,0	41	19,5	52	54	104	20	4
20	4,0	41	19,5	52	54	104	20	4
20	1,5	42	19,5	100	104	154	20	4
20	0,3	42	19,5	100	104	154	20	4
20	0,5	42	19,5	100	104	154	20	4
20	1,0	42	19,5	100	104	154	20	4
20	2,0	42	19,5	100	104	154	20	4
20	3,0	42	19,5	100	104	154	20	4
20	4,0	42	19,5	100	104	154	20	4

P	●	●
M	●	○
K	●	●
N	○	
S	○	
H		
O		

→ v_c/f_z Page 462-467

Finish milling cutter

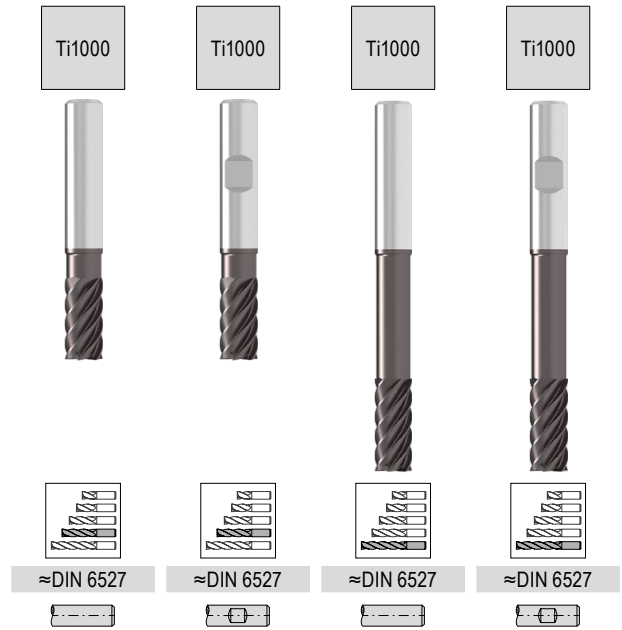
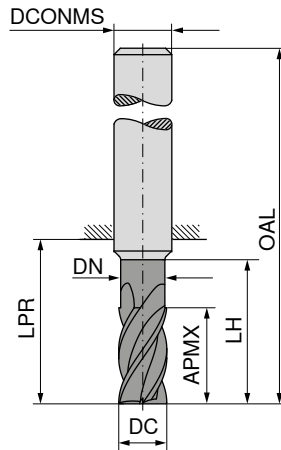
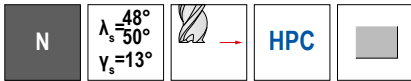

DC _{h10} mm	APMX mm	DN mm	LH mm	LPR mm	OAL mm	DCONMS _{h6} mm	ZEFP
6	13	5,6	19	21	57	6	6
6	15	5,6	42	44	80	6	6
8	19	7,6	25	27	63	8	6
8	20	7,6	62	64	100	8	6
10	22	9,6	30	32	72	10	6
10	25	9,6	58	60	100	10	6
12	26	11,5	36	38	83	12	6
12	30	11,5	73	75	120	12	6
16	32	15,0	42	44	92	16	6
16	40	15,0	100	102	150	16	6
20	38	19,0	52	54	104	20	6
20	50	19,0	98	100	150	20	6

54 076 ...	54 075 ...	54 076 ...	54 075 ...
06200	06200	06400	06400
08200	08200	08400	08400
10200	10200	10400	10400
12200	12200	12400	12400
16200	16200	16400	16400
20200	20200	20400	20400

P	●	●	●	●
M	●	●	●	●
K	○	○	○	○
N	○	○	○	○
S	○	○	○	○
H				
O				

→ v_c/f_z Page 468

Finish milling cutter

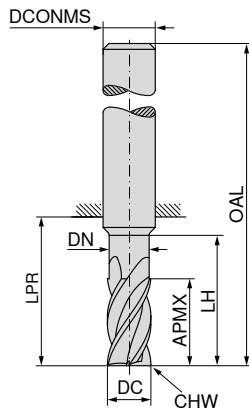
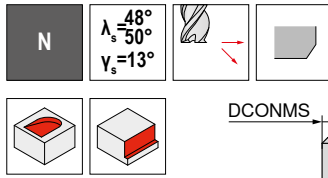

LPR with Shank DIN 6535 HB

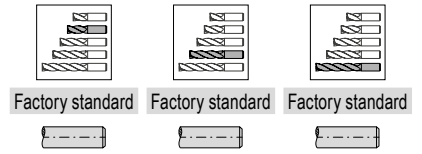

DC _{as}	APMX	DN	LH	LPR	OAL	DCONMS _{hg}	CHW	ZEFP	52 010 ...	52 015 ...	52 018 ...
mm	mm	mm	mm	mm	mm	mm	mm				
5	8	4,8	13	18	54	6	0,02	6	05000		
5	13	4,8	18	22	58	6	0,02	6		05000	
6	10	5,8	15	18	54	6	0,03	6	06000	06000	
6	16	5,8	20	22	58	6	0,03	6		06000	
6	21			29	65	6	0,03	6			06000
7	12	6,8	17	23	59	8	0,04	6	07000		
7	22	6,8	30	34	70	8	0,04	6		07000	
7	25			39	75	8	0,04	6			07000
8	12	7,8	17	23	59	8	0,04	6	08000		
8	22	7,8	32	34	70	8	0,04	6		08000	
8	28			39	75	8	0,04	6			08000
9	14	8,8	19	20	60	10	0,04	6	09000		
9	25	8,8	33	33	73	10	0,04	6		09000	
9	30			45	85	10	0,04	6			09000
10	14	9,8	19	20	60	10	0,05	6	10000		
10	25	9,8	33	33	73	10	0,05	6		10000	
10	35			45	85	10	0,05	6			10000
12	16	11,8	21	25	70	12	0,05	6	12000		
12	28	11,8	38	39	84	12	0,05	6		12000	
12	45			55	100	12	0,05	6			12000
14	18	13,8	23	25	70	14	0,06	6	14000		
14	30	13,8	38	39	84	14	0,06	6		14000	
16	20	15,8	28	32	80	16	0,06	8	16000		
16	35	15,8	43	45	93	16	0,06	8		16000	
16	50			62	110	16	0,06	8			16000
16	65			77	125	16	0,06	8			16100
20	25	19,8	33	35	85	20	0,07	8	20000		
20	40	19,8	45	50	100	20	0,07	8		20000	
20	55			65	115	20	0,07	8			20000
20	70			80	130	20	0,07	8			20100
25	55	24,8	63	69	125	25	0,08	8		25000	
25	75			94	150	25	0,08	8			25000
P									○	○	○
M									●	●	●
K									○	○	○
N									●	●	●
S									●	●	●
H											
O									●	●	●

→ v_c/f_z Page 480-485

Finish milling cutter

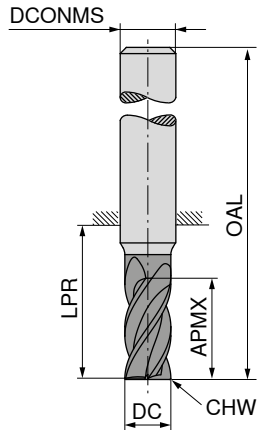
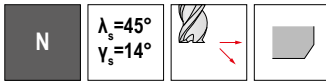

≈DIN 6527 Factory standard



50 633 ... **50 633 ...**

DC _{FB} mm	APMX mm	LPR mm	OAL mm	DCONMS _{hg} mm	CHW mm	ZEFP
4	11	21	57	6	0,15	6
4	16	26	62	6	0,15	6
5	13	21	57	6	0,15	6
5	18	26	62	6	0,15	6
6	13	21	57	6	0,15	6
6	18	26	62	6	0,15	6
7	16	27	63	8	0,15	6
7	21	32	68	8	0,15	6
8	19	27	63	8	0,15	6
8	24	32	68	8	0,15	6
9	19	32	72	10	0,15	6
9	27	40	80	10	0,15	6
10	22	32	72	10	0,15	6
10	30	40	80	10	0,15	6
12	26	38	83	12	0,15	6
12	36	48	93	12	0,15	6
14	26	38	83	14	0,15	6
14	42	54	99	14	0,15	6
16	32	44	92	16	0,15	6
16	48	60	108	16	0,15	6
16	65	77	125	16	0,15	6
16	75	102	150	16	0,15	6
16	95	102	150	16	0,15	6
18	32	44	92	18	0,15	8
18	54	66	114	18	0,15	8
20	38	54	104	20	0,15	8
20	60	76	126	20	0,15	8
20	75	85	135	20	0,15	8
20	95	100	150	20	0,15	8
25	75	94	150	25	0,15	8
25	95	104	160	25	0,15	8
32	75	90	150	32	0,15	8
32	95	100	160	32	0,15	8

50 633 ...	50 633 ...
040	041
050	051
060	061
070	071
080	081
090	091
100	101
120	121
140	141
160	161
	162
	163
	164
180	181
200	201
	202
	203
	250
320	251
	321

P	○	○
M	●	●
K	●	●
N		
S	○	○
H		
O		

→ v_c/f_z Page 480–485

Finish milling cutter with corner radius

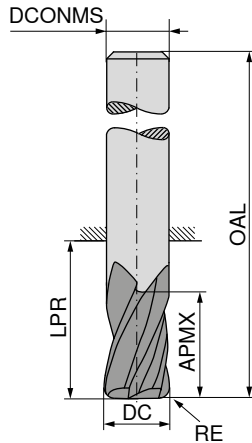
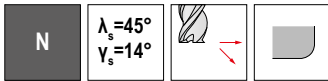

Ti1000



Factory standard



50 634 ...

DC ₁₈ mm	RE _{±0.05} mm	APMX mm	LPR mm	OAL mm	DCONMS ₁₆ mm	ZEFP	
6	0,5	18	26	62	6	6	060
6	1,0	18	26	62	6	6	061
8	0,5	24	32	68	8	6	080
8	1,0	24	32	68	8	6	081
8	2,0	24	32	68	8	6	082
10	0,5	30	40	80	10	6	100
10	1,0	30	40	80	10	6	101
10	2,0	30	40	80	10	6	102
12	0,5	36	48	93	12	6	120
12	1,0	36	48	93	12	6	121
12	2,0	36	48	93	12	6	122
12	3,0	36	48	93	12	6	123
16	0,5	48	60	108	16	6	160
16	1,0	48	60	108	16	6	161
16	2,0	48	60	108	16	6	162
16	3,0	48	60	108	16	6	163
20	0,5	60	76	126	20	8	200
20	1,0	60	76	126	20	8	201
20	2,0	60	76	126	20	8	202
20	3,0	60	76	126	20	8	203

P	○
M	●
K	●
N	
S	○
H	
O	

→ v_c/f_z Page 480-485

Finish milling cutter

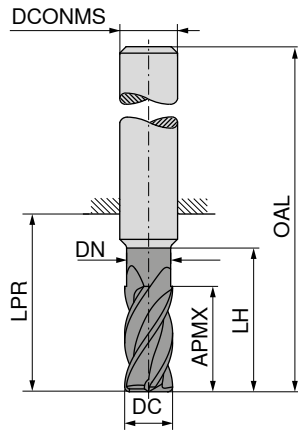
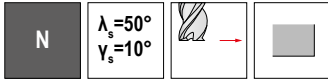

Ti1000



Factory standard



52 109 ...

DC _{es} mm	APMX mm	DN mm	LH mm	LPR mm	OAL mm	DCONMS ₁₆ mm	ZEFP	
6	16	5,8	26	26	58	6	8	060
8	22	7,8	32	32	64	8	10	080
10	25	9,8	35	35	73	10	12	100
12	28	11,8	38	39	84	12	12	120
16	35	15,8	43	45	93	16	16	160
20	40	19,8	50	54	104	20	16	200

P	○
M	●
K	○
N	●
S	●
H	○
O	●

→ v_c/f_z Page 480-483

End milling cutter

▲ With graduated flute depth

H

$\lambda_s = 52^\circ$
 $\gamma_s = -11^\circ$

≤ 54
HRC

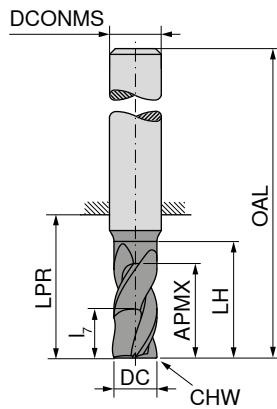
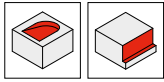

Ti1000 Ti1000



DIN 6527 DIN 6527

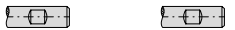

50 907 ...	50 907 ...
041	042
051	052
061	062
081	082
101	102
121	122
161	162
201	202

DC _{r8}	APMX	LH	l ₇	LPR	OAL	DCONMS _{h5}	CHW	ZEFP
mm	mm	mm	mm	mm	mm	mm	mm	
4	11	18	4,4	21	57	6	0,15	4
4	16	19	6,4	26	62	6	0,15	4
5	13	19	4,8	21	57	6	0,15	4
5	17	20	6,8	26	62	6	0,15	4
6	13	19	5,2	21	57	6	0,15	4
6	18	21	7,2	26	62	6	0,15	4
8	19	25	7,6	27	63	8	0,15	4
8	24	27	9,6	32	68	8	0,15	4
10	22	30	8,8	32	72	10	0,15	4
10	30	33	12,0	40	80	10	0,15	4
12	26	36	10,4	38	83	12	0,15	4
12	36	39	14,4	48	93	12	0,15	4
16	32	42	12,8	44	92	16	0,15	4
16	48	51	19,2	60	108	16	0,15	4
20	38	52	15,2	54	104	20	0,15	4
20	60	63	24,0	76	126	20	0,15	4

P	●	●
M		
K		
N		
S		
H	●	●
O		

→ v_c/f_z Page 480–485

Finish milling cutter

H
 $\lambda_s = 50^\circ$
 $\gamma_s = -5^\circ$

 ≤ 68
HRC

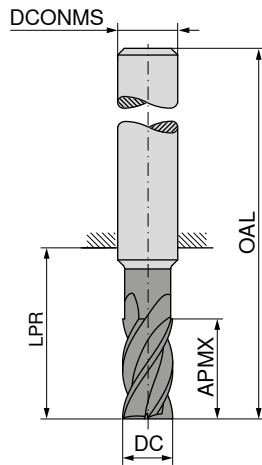

Ti1000 Ti1000



DIN 6527 Factory standard

DC _{FB} mm	APMX mm	OAL mm	DCONMS _{h5} mm	ZEFP
4	11	57	6	6
4	16	62	6	6
5	13	57	6	6
5	18	62	6	6
6	13	57	6	6
6	18	62	6	6
8	19	63	8	6
8	24	68	8	6
10	22	72	10	6
10	30	80	10	6
12	26	83	12	6
12	36	93	12	6
16	32	92	16	8
16	48	108	16	8
16	90	150	16	8
20	38	104	20	8
20	60	126	20	8
20	75	135	20	8
20	95	150	20	8
25	75	150	25	8
25	95	160	25	8

50 635 ...	50 635 ...
040	041
050	051
060	061
080	081
100	101
120	121
160	161
160	162
200	201
200	202
200	203
250	251

P	●	●
M	●	●
K	○	○
N	○	○
S	●	●
H	●	●
O	●	●

→ v_c/f_z Page 480–485

Finish milling cutter

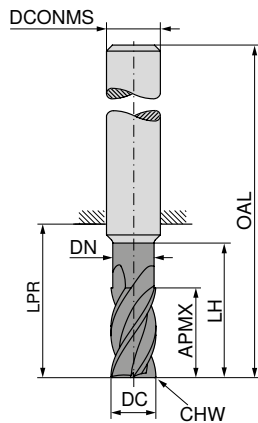
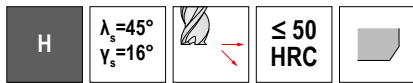

LPR with Shank DIN 6535 HB

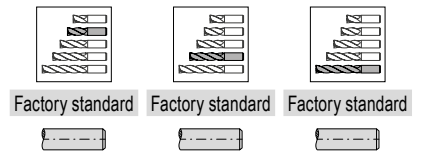
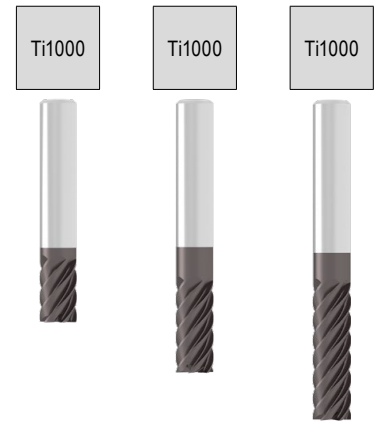

DC _{as} mm	APMX mm	DN mm	LH mm	LPR mm	OAL mm	DCONMS _{h6} mm	CHW mm	ZEFP
5	8	4,8	13	18	54	6	0,02	6
5	13	4,8	18	22	58	6	0,02	6
6	10	5,8	15	18	54	6	0,03	6
6	16	5,8	20	22	58	6	0,03	6
6	21			29	65	6	0,03	6
8	12	7,8	17	23	59	8	0,04	6
8	22	7,8	32	34	70	8	0,04	6
8	28			39	75	8	0,04	6
10	14	9,8	19	20	60	10	0,05	6
10	25	9,8	33	33	73	10	0,05	6
10	35			45	85	10	0,05	6
12	16	11,8	21	25	70	12	0,05	6
12	28	11,8	38	39	84	12	0,05	6
12	45			55	100	12	0,05	6
16	20	15,8	28	32	80	16	0,06	6
16	35	15,8	43	45	93	16	0,06	6
16	50			62	110	16	0,06	6
16	65			77	125	16	0,06	6
20	25	19,8	33	35	85	20	0,07	8
20	40	19,8	45	50	100	20	0,07	8
20	55			65	115	20	0,07	8
20	70			80	130	20	0,07	8
25	55	24,8	63	69	125	25	0,08	8
25	75			94	150	25	0,08	8

52 112 ...	52 122 ...	52 123 ...
051		
061	051	
	061	
081		061
	081	
101		081
	101	
121		101
	121	
161		121
	161	
201		162
	201	163
	251	
		202
		203
		251

P	○	○	○
M	●	●	●
K	○	○	○
N	●	●	●
S	●	●	●
H			
O	●	●	●

→ v_c/f_z Page 480-485

Roughing-Finishing Cutter

▲ With rough-finishing profile

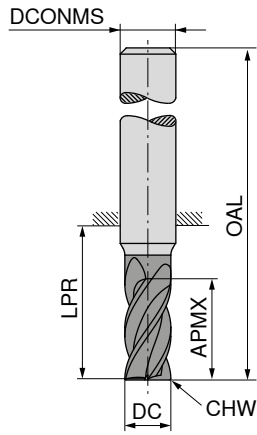
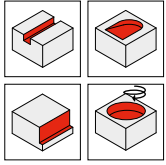
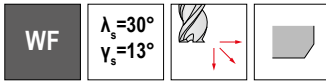

Ti400



DIN 6527



50 628 ...

DC _{dft} mm	APMX mm	LPR mm	OAL mm	DCONMS _{h5} mm	CHW mm	ZEFP
5	15	21	57	6	0,25	4
6	16	21	57	6	0,25	4
8	22	27	63	8	0,25	4
10	25	32	72	10	0,25	4
12	28	38	83	12	0,25	4
16	35	44	92	16	0,25	4
20	40	54	104	20	0,25	4

- 050
- 060
- 080
- 100
- 120
- 160
- 200

P	
M	
K	
N	●
S	○
H	
O	●

→ v_c/f_z Page 480–483

Roughing-Finishing Cutter

▲ With trapezoidal cord profile

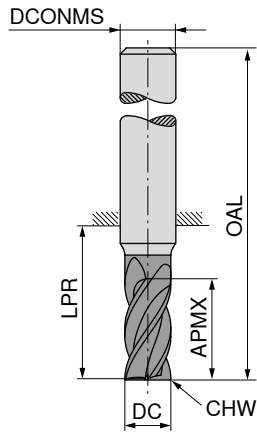
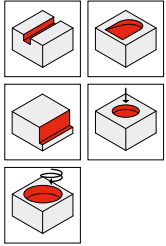
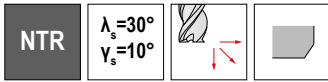

APA72S



DIN 6527



52 318 ...

DC _{h10} mm	APMX mm	LPR mm	OAL mm	DCONMS _{h6} mm	CHW mm	ZEFP	
6	13	21	57	6		3	06000
8	19	27	63	8	0,08	3	08000
10	22	32	72	10	0,12	4	10000
12	26	38	83	12	0,15	4	12000
14	26	38	83	14	0,17	4	14000
16	32	44	92	16	0,20	4	16000
18	32	48	92	18	0,22	4	18000
20	38	54	104	20	0,25	4	20000
P							●
M							○
K							●
N							○
S							
H							
O							

→ v_c/f_z Page 470+471

Rough milling cutter

▲ With roughing profile

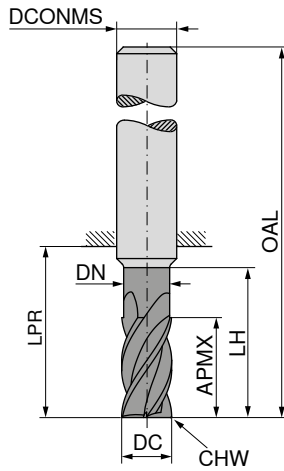
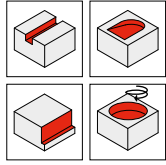
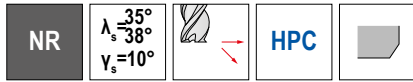

Ti1000



≈DIN 6527



54 077 ...

DC ₁₈	APMX	DN	LH	LPR	OAL	DCONMS ₁₆	CHW	ZEFP	
mm	mm	mm	mm	mm	mm	mm	mm		
4	11	3,8	17	21	57	6	0,1	4	00400
5	13	4,8	19	21	57	6	0,1	4	00500
6	13	5,8	19	21	57	6	0,1	4	00600
8	21	7,7	25	27	63	8	0,2	4	00800
10	22	9,7	30	32	72	10	0,2	4	01000
12	26	11,6	36	38	83	12	0,3	4	01200
16	36	15,5	42	44	92	16	0,3	4	01600
20	41	19,5	52	54	104	20	0,3	4	02000

P	●
M	●
K	●
N	○
S	○
H	
O	

→ v_c/f_z Page 472+473

Rough milling cutter

▲ With roughing profile

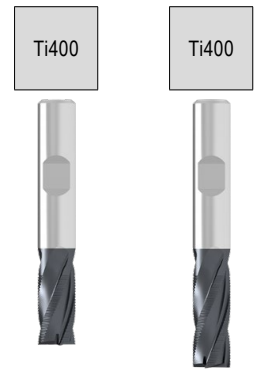
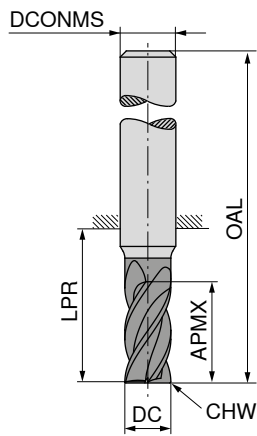
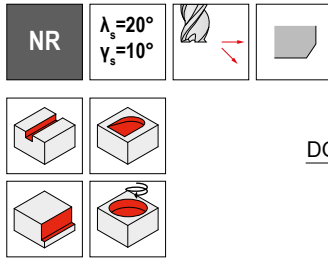

DC _{d11} mm	APMX mm	LPR mm	OAL mm	DCONMS _{h5} mm	CHW mm	ZEFP
4	8	21	57	6	0,6	4
5	8	18	54	6	0,6	4
5	13	21	57	6	0,6	4
6	8	18	54	6	0,6	4
6	13	21	57	6	0,6	4
7	11	22	58	8	0,6	4
7	19	27	63	8	0,6	4
8	11	22	58	8	0,6	4
8	19	27	63	8	0,6	4
9	13	26	66	10	0,6	4
9	22	32	72	10	0,6	4
10	13	26	66	10	0,6	4
10	22	32	72	10	0,6	4
11	26	38	83	12	0,6	4
12	16	28	73	12	0,6	4
12	26	38	83	12	0,6	4
13	26	38	83	14	0,6	4
14	16	31	76	14	0,6	4
14	26	38	83	14	0,6	4
16	19	34	82	16	0,6	4
16	32	44	92	16	0,6	4
18	19	36	84	18	0,6	4
18	32	44	92	18	0,6	4
20	19	42	92	20	0,6	4
20	38	54	104	20	0,6	4
25	45	65	121	25	0,6	5

	50 618 ...	50 624 ...
P	●	●
M	○	○
K	●	●
N	○	○
S	○	○
H		
O	○	○

→ v_c/f_z Page 480-483

Rough milling cutter

▲ With roughing profile

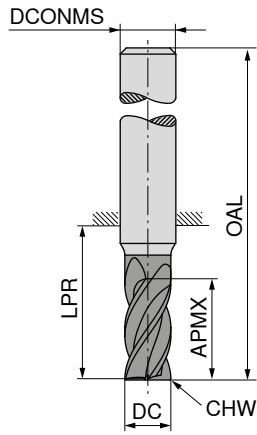
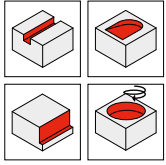

Ti400



DIN 6527



50 637 ...

DC _{dft} mm	APMX mm	LPR mm	OAL mm	DCONMS _{h5} mm	CHW mm	ZEFP	
6	13	21	57	6	0,5	4	060
8	19	27	63	8	0,5	4	080
10	22	32	72	10	0,5	4	100
12	26	38	83	12	0,5	4	120
14	26	38	83	14	0,5	4	140
16	32	44	92	16	0,5	5	160
18	32	44	92	18	0,5	5	180
20	38	54	104	20	0,5	6	200
25	45	65	121	25	0,5	6	250
P							○
M							●
K							○
N							○
S							●
H							
O							○

→ v_c/f_z Page 480–483

Rough milling cutter

- ▲ With round cord profile
- ▲ With integrated chip breakers in the flutes

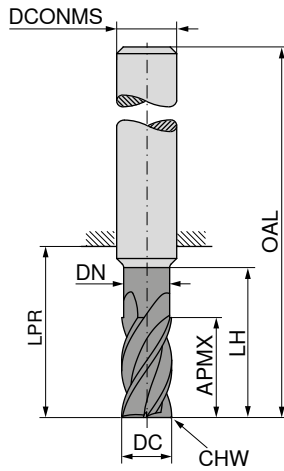
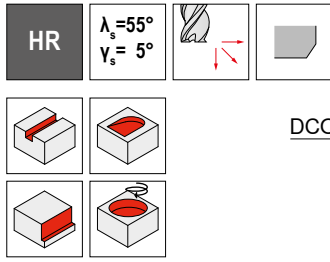

Ti1000



Factory standard



52 341 ...

DC _{h11} mm	APMX mm	DN mm	LH mm	LPR mm	OAL mm	DCONMS _{n6} mm	CHW mm	ZEFP	
6	16	5,8	21	22	58	6	0,15	4	060
8	22	7,7	27	34	70	8	0,20	4	080
10	25	9,7	30	33	73	10	0,20	4	100
12	28	11,6	38	39	84	12	0,25	4	120
14	30	13,6	40	39	84	14	0,30	4	140
16	35	15,5	45	45	93	16	0,35	5	160
18	35	17,5	45	45	93	18	0,40	5	180
20	40	19,5	55	54	104	20	0,40	5	200

P	○
M	●
K	○
N	
S	
H	
O	

→ v_c/f_z Page 474+475

Rough milling cutter

▲ With round cord profile

▲ With integrated chip breakers in the flutes

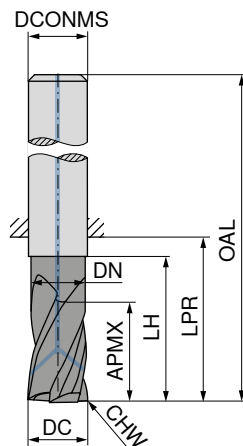
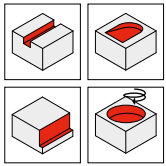
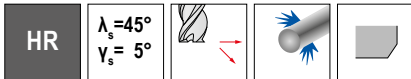

DC _{h11} mm	APMX mm	DN mm	LH mm	LPR mm	OAL mm	DCONMS _{h6} mm	CHW mm	ZEFP
6	16	5,8	21	22	58	6	0,15	4
8	22	7,7	27	34	70	8	0,20	4
10	25	9,7	30	33	73	10	0,20	4
12	28	11,6	38	39	84	12	0,25	4
16	35	15,5	45	45	93	16	0,35	5
20	40	19,5	55	54	104	20	0,40	5

	52 338 ...	52 339 ...
P	●	●
M	●	●
K	●	●
N		
S		
H		
O		

→ v_c/f_z Page 474+475

Rough milling cutter

- ▲ With round cord profile
- ▲ With integrated chip breakers in the flutes

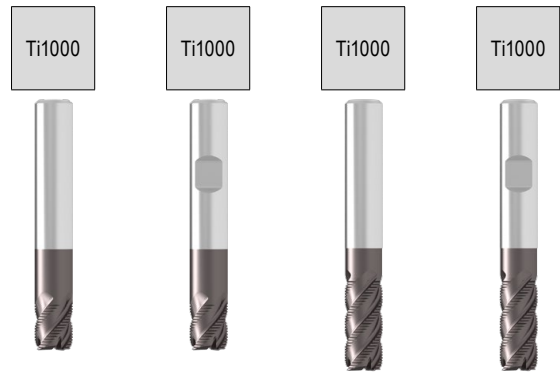
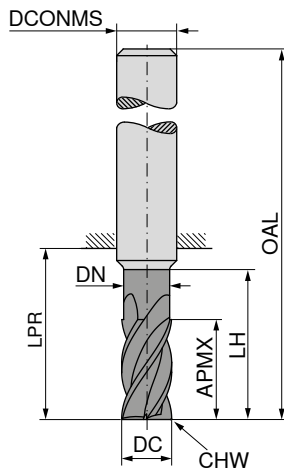
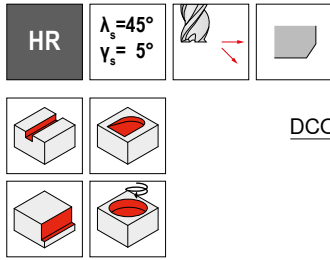

Factory standard Factory standard Factory standard Factory standard



DC _{h11} mm	APMX mm	DN mm	LH mm	LPR mm	OAL mm	DCONMS _{h6} mm	CHW mm	ZEFP
6	8	6,0		18	54	6	0,15	4
6	16	5,8	21	22	58	6	0,15	4
8	11	8,0		23	59	8	0,20	4
8	22	7,7	27	34	70	8	0,20	4
10	13	10,0		27	67	10	0,20	4
10	25	9,7	30	33	73	10	0,20	4
12	16	12,0		29	74	12	0,25	4
12	28	11,6	38	39	84	12	0,25	4
14	16	14,0		30	75	14	0,25	4
14	30	13,5	40	39	84	14	0,25	4
16	19	16,0		36	84	16	0,35	5
16	35	15,5	45	45	93	16	0,35	5
20	19	20,0		43	93	20	0,40	5
20	40	19,5	55	54	104	20	0,40	5
25	50	24,0	65	69	125	25	0,50	5

52 342 ...	52 343 ...	52 342 ...	52 343 ...
060	060		
080	080	061	061
100	100	081	081
120	120	101	101
140	140	121	121
160	160	141	141
200	200	161	161
		201	201
		251	251

P	●	●	●	●
M	○	○	○	○
K	●	●	●	●
N				
S				
H				
O				

→ v_c/f_z Page 474+475

Ball Nosed Cutter

- ▲ Radius accuracy: ± 0.005 mm
- ▲ For $\varnothing DC \leq 5.0$ mm, angle tolerance α and β : $\pm 0.5^\circ$

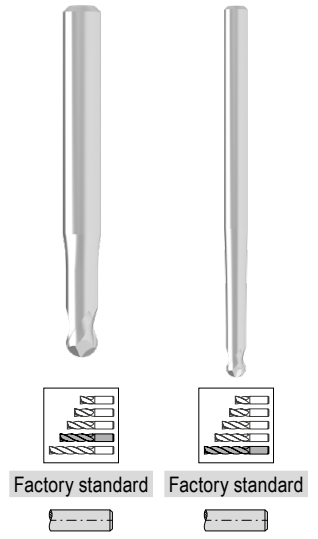
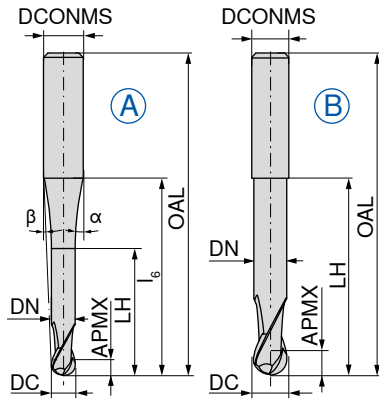

DC ± 0.01 mm	APMX mm	DN mm	LH mm	l ₆ mm	OAL mm	α°	β°	DCONMS _{HS} mm	ZEPF	Fig.
0,5	1,0	0,45	2,0	9	38	10	8	3	2	A
1,0	2,0	0,95	4,0	9	38	12,5	6,5	3	2	A
1,5	2,5	1,40	7,5	9	38	32	5	3	2	A
2,0	3,0	1,80	8,0	9	38	31	3,5	3	2	A
3,0	3,5	2,80	10,0	20	57	11,5	5	6	2	A
3,0	3,5	2,80	12,0	40	80	3,5	2,5	6	2	A
4,0	4,0	3,80	12,0	20	57	11	3,5	6	2	A
4,0	4,0	3,80	20,0	40	80	4	1,5	6	2	A
5,0	5,0	4,70	10,0	40	100	1,5	1	6	2	A
5,0	5,0	4,70	14,0	20	57	10	2	6	2	A
6,0	6,0	5,60	20,0		57			6	2	B
6,0	6,0	5,60	40,0		100			6	2	B
8,0	7,0	7,60	25,0		63			8	2	B
8,0	7,0	7,60	60,0		120			8	2	B
10,0	8,0	9,60	30,0		72			10	2	B
10,0	8,0	9,60	60,0		120			10	2	B
12,0	8,0	11,50	40,0		83			12	2	B
12,0	10,0	11,50	70,0		160			12	2	B

52 718 ...	52 720 ...
005	
010	
015	
020	
030	
040	030
050	040
060	050
080	060
100	080
120	100
	120

P		
M		
K		
N	●	●
S	○	○
H		
O	●	●

→ v_c/f_z Page 480–486

Ball Nosed Cutter

▲ Radius accuracy: ± 0,01 mm

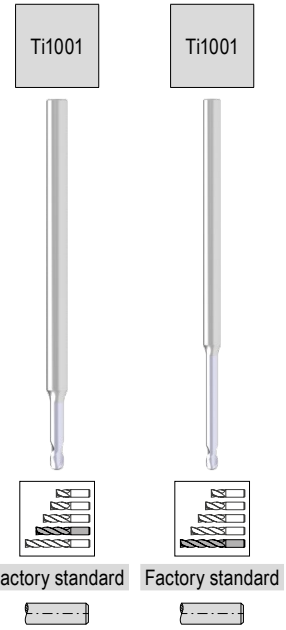
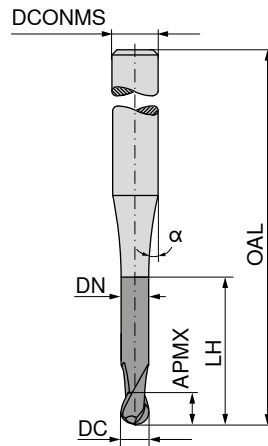
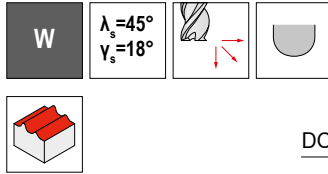

DC ₁₈ mm	APMX mm	DN mm	LH mm	OAL mm	α°	DCONMS ₁₈ mm	ZEFP
0,2	0,2	0,18	0,6	55	15	3	2
0,2	0,2	0,18	1,0	55	15	3	2
0,2	0,2	0,18	1,6	55	15	3	2
0,2	0,2	0,18	2,0	55	15	3	2
0,3	0,3	0,28	0,9	55	15	3	2
0,3	0,3	0,28	1,5	55	15	3	2
0,3	0,3	0,28	2,4	55	15	3	2
0,3	0,3	0,28	3,0	55	15	3	2
0,4	0,4	0,37	1,2	55	15	3	2
0,4	0,4	0,37	2,0	55	15	3	2
0,4	0,4	0,37	3,2	55	15	3	2
0,4	0,4	0,37	4,0	55	15	3	2
0,5	0,5	0,45	1,5	55	15	3	2
0,5	0,5	0,45	2,5	55	15	3	2
0,5	0,5	0,45	4,0	55	15	3	2
0,5	0,5	0,45	5,0	55	15	3	2
0,6	0,6	0,58	2,0	55	15	3	2
0,6	0,6	0,58	3,0	55	15	3	2
0,6	0,6	0,58	5,0	65	15	3	2
0,6	0,6	0,58	6,0	65	15	3	2
0,8	0,8	0,77	2,5	55	15	3	2
0,8	0,8	0,77	4,0	55	15	3	2
0,8	0,8	0,77	6,5	65	15	3	2
0,8	0,8	0,77	8,0	65	15	3	2
1,0	1,0	0,95	3,0	55	15	3	2
1,0	1,0	0,95	5,0	55	15	3	2
1,0	1,0	0,95	8,0	65	15	3	2
1,0	1,0	0,95	10,0	65	15	3	2
1,0	1,0	0,95	12,0	65	15	3	2
1,2	1,2	1,15	3,0	55	15	3	2
1,2	1,2	1,15	6,0	55	15	3	2
1,2	1,2	1,15	10,0	65	15	3	2
1,2	1,2	1,15	12,0	65	15	3	2
1,3	1,3	1,25	4,0	55	15	3	2
1,3	1,3	1,25	7,0	55	15	3	2
1,3	1,3	1,25	11,0	65	15	3	2
1,3	1,3	1,25	13,0	65	15	3	2
1,5	1,5	1,44	5,0	55	15	3	2
1,5	1,5	1,44	7,5	55	15	3	2

50 903 ...	50 903 ...
021	
022	
023	
024	
031	
032	
033	
034	
041	
042	
043	
044	
051	
052	
053	
054	
061	
062	
	063
	064
081	
082	
	083
	084
101	
102	
	103
	104
	105
121	
122	
	123
	124
131	
132	
	133
	134
151	
152	

P	
M	
K	
N	●
S	
H	
O	

Ball Nosed Cutter

▲ Radius accuracy: ± 0,01 mm

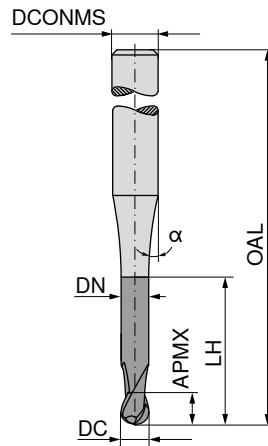
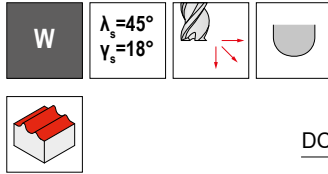

DC ₁₈ mm	APMX mm	DN mm	LH mm	OAL mm	α°	DCONMS ₁₈ mm	ZEFP
1,5	1,5	1,44	12,0	65	15	3	2
1,5	1,5	1,44	15,0	65	15	3	2
1,6	1,6	1,52	5,0	55	15	3	2
1,6	1,6	1,52	8,0	55	15	3	2
1,6	1,6	1,52	13,0	65	15	3	2
1,6	1,6	1,52	16,0	65	15	3	2
1,8	1,8	1,72	5,5	55	15	3	2
1,8	1,8	1,72	9,0	55	15	3	2
1,8	1,8	1,72	14,5	65	15	3	2
1,8	1,8	1,72	18,0	65	15	3	2
2,0	2,0	1,92	6,0	55	15	3	2
2,0	2,0	1,92	10,0	55	15	3	2
2,0	2,0	1,92	14,0	55	15	3	2
2,0	2,0	1,92	16,0	65	15	3	2
2,0	2,0	1,92	20,0	65	15	3	2
2,3	2,3	2,22	7,0	55	15	3	2
2,3	2,3	2,22	11,5	55	15	3	2
2,3	2,3	2,22	18,5	65	15	3	2
2,3	2,3	2,22	20,0	65	15	3	2
2,3	2,3	2,22	23,0	65	15	3	2
3,0	3,0	2,90	9,0	65	15	6	2
3,0	3,0	2,90	15,0	65	15	6	2
3,0	3,0	2,90	24,0	100	15	6	2
3,0	3,0	2,90	30,0	100	15	6	2
4,0	4,0	3,90	12,0	65	15	6	2
4,0	4,0	3,90	20,0	65	15	6	2
4,0	4,0	3,90	32,0	100	15	6	2
4,0	4,0	3,90	40,0	100	15	6	2
5,0	5,0	4,90	15,0	65	15	6	2
5,0	5,0	4,90	25,0	65	15	6	2
5,0	5,0	4,90	40,0	100	15	6	2
5,0	5,0	4,90	50,0	100	15	6	2
6,0	6,0	5,90	18,0	65	15	6	2
6,0	6,0	5,90	30,0	100	15	6	2
6,0	6,0	5,90	48,0	100	15	6	2
6,0	6,0	5,90	60,0	100	15	6	2

P	
M	
K	
N	●
S	
H	
O	

Ti1001

Factory standard

50 903 ...

Ti1001

Factory standard

50 903 ...

154	
153	
161	
162	
163	
164	
181	
182	
183	
184	
201	
202	
203	
204	
205	
231	
232	
233	
234	
235	
301	
302	
303	
304	
401	
402	
403	
404	
501	
502	
503	
504	
601	
602	
603	
604	

Ball Nosed Cutter

▲ Radius accuracy: ± 0,01 mm

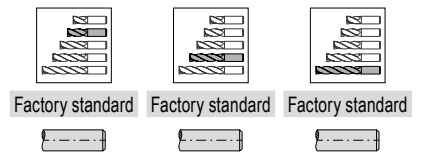
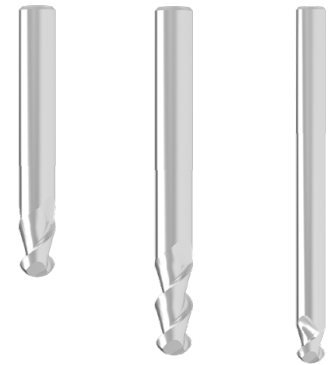
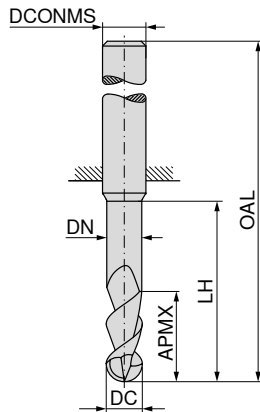
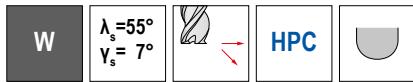

DC _{h6}	APMX	DN	LH	OAL	DCONMS _{h5}	ZEFP	54 640 ...	54 640 ...	54 640 ...
mm	mm	mm	mm	mm	mm				
3	5,0	2,8	12	55	6	2			
3	3,5	2,8	15	58	6	2	031		
3	8,0	2,8	15	58	6	2		034	
3	3,5	2,8	24	67	6	2		032	
4	6,5	3,8	12	55	6	2	041		035
4	4,5	3,8	20	62	6	2		044	
4	10,5	3,8	20	62	6	2		042	
4	4,5	3,8	32	74	6	2			045
5	8,0	4,8	15	58	6	2	051		
5	5,5	4,8	25	70	6	2		054	
5	13,0	4,8	25	70	6	2		052	
5	5,5	4,8	40	88	6	2			055
6	10,0	5,8	18	58	6	2	061		
6	7,0	5,8	30	70	6	2		064	
6	16,0	5,8	30	70	6	2		062	
6	7,0	5,8	48	88	6	2			065
8	13,0	7,7	24	64	8	2	081		
8	9,0	7,7	40	80	8	2		084	
8	21,0	7,7	40	80	8	2		082	
8	9,0	7,7	64	104	8	2			085
10	16,0	9,7	30	74	10	2	101		
10	11,0	9,7	50	94	10	2		104	
10	26,0	9,7	50	94	10	2		102	
10	11,0	9,7	80	124	10	2			105
12	19,0	11,6	36	85	12	2	121		
12	13,0	11,6	60	109	12	2		124	
12	31,0	11,6	60	109	12	2		122	
12	13,0	11,6	96	145	12	2			125
14	22,0	13,6	42	91	14	2	141		
14	15,0	13,6	70	119	14	2		144	
14	36,0	13,6	70	119	14	2		142	
14	15,0	13,6	112	161	14	2			145
16	25,0	15,5	48	100	16	2	161		
16	17,0	15,5	80	132	16	2		164	
16	41,0	15,5	80	132	16	2		162	
16	17,0	15,5	128	180	16	2			165
18	29,0	17,5	54	106	18	2	181		
18	20,0	17,5	90	142	18	2		184	
18	47,0	17,5	90	142	18	2		182	
18	20,0	17,5	144	196	18	2			185
20	32,0	19,5	60	114	20	2	201		
20	52,0	19,5	100	154	20	2		202	
20	22,0	19,5	100	154	20	2		204	
20	22,0	19,5	160	214	20	2			205

P			
M			
K			
N	•	•	•
S			
H			
O			

→ v_c/f_z Page 460+461

Ball Nosed Cutter

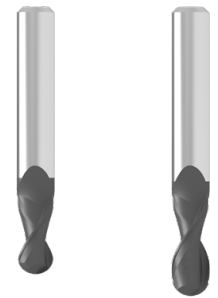
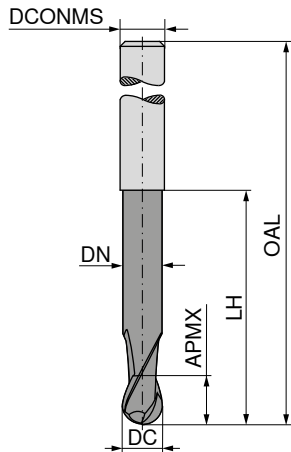
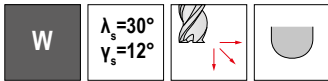

Factory standard Factory standard

DC _{h10} mm	APMX mm	LH mm	DN mm	OAL mm	DCONMS _{h6} mm	ZEFP
0,5	1,5			38	3	2
1,0	2,0			38	3	2
2,0	3,0			38	3	2
2,0	3,0			50	6	2
2,0	8,0	31	1,8	60	2	2
3,0	5,0			38	3	2
3,0	5,0			50	6	2
3,0	12,0	41	2,8	70	3	2
4,0	8,0			54	6	2
4,0	15,0	51	3,8	80	4	2
5,0	9,0			54	6	2
5,0	20,0	71	4,8	100	5	2
6,0	10,0			54	6	2
6,0	20,0	63	5,8	100	6	2
8,0	12,0			58	8	2
8,0	20,0	83	7,8	120	8	2
10,0	14,0			66	10	2
10,0	25,0	99	9,8	140	10	2
12,0	25,0	104	11,8	150	12	2

52 766 ...	52 768 ...
005	
010	
020	
021	
	020
030	
031	
	030
040	
	040
050	
	050
060	
	060
080	
	080
100	
	100
	120

P		
M		
K		
N	•	•
S		
H		
O	•	•

→ v_c/f_z Page 418

Micro-ball nosed cutter

▲ Radius accuracy: ± 0,01 mm

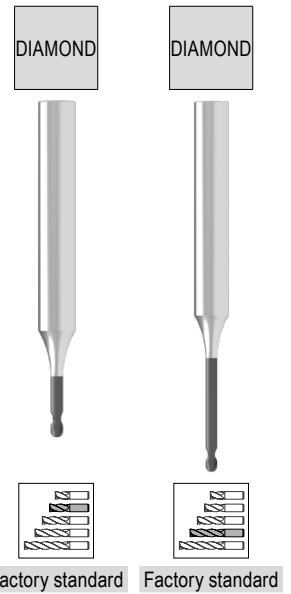
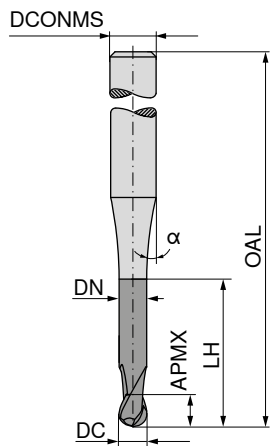
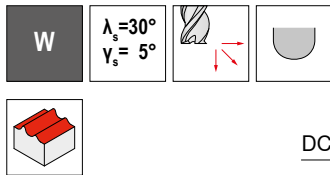

DC ₁₈ mm	APMX mm	LH mm	DN mm	OAL mm	α°	DCONMS ₁₈ mm	ZEFP
0,6	1,2	3,0	0,58	55	15	6	2
0,6	1,2	6,0	0,58	65	15	6	2
0,8	1,2	4,0	0,77	55	15	6	2
0,8	1,2	8,0	0,77	65	15	6	2
1,0	1,5	5,0	0,95	55	15	6	2
1,0	1,5	12,0	0,95	65	15	6	2
1,2	1,6	6,0	1,15	55	15	6	2
1,2	1,6	12,0	1,15	65	15	6	2
1,5	1,8	7,5	1,44	55	15	6	2
1,5	1,8	15,0	1,44	65	15	6	2
2,0	2,0	10,0	1,92	55	15	6	2
2,0	2,0	20,0	1,92	65	15	6	2

	50 912 ...	50 912 ...
P		
M		
K		
N	●	●
S		
H		
O	●	●

→ v_c/f_z Page 418

Ball Nosed Cutter

▲ Radius accuracy: ± 0,01 mm

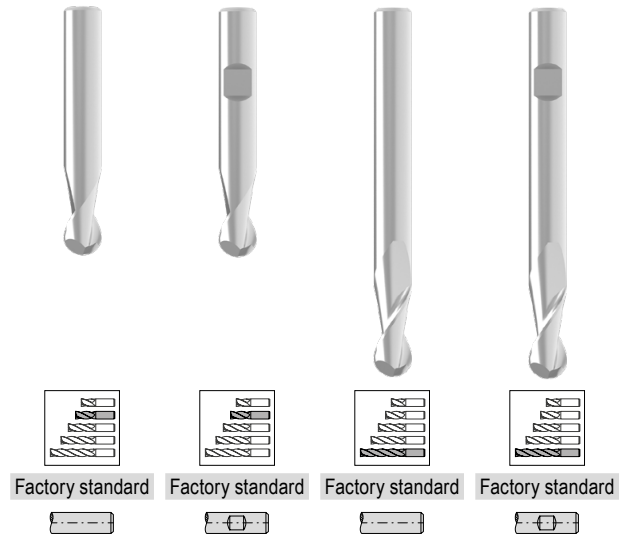
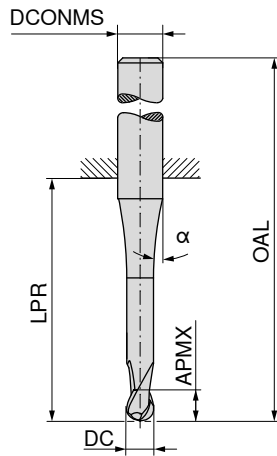
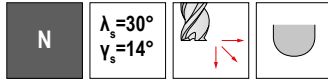

DC _{rs} mm	APMX mm	LPR mm	OAL mm	α°	DCONMS _{rs} mm	ZEFP	52 050 ...	52 052 ...	52 051 ...	52 053 ...
0,10	0,2	12,5	38	8	3	2	91000			
0,15	0,3	11,5	38	8	3	2	91500			
0,20	0,4	12,0	38	8	3	2	92000			
0,25	0,5	12,5	38	8	3	2	92500			
0,30	1,0	11,3	38	8	3	2	93000			
0,35	1,0	11,1	38	8	3	2	93500			
0,40	1,0	10,9	38	8	3	2	94000			
0,50	1,5	11,7	38	7	3	2	95000			
0,50	1,5	18,0	54	11	6	2	95100			
0,50	1,5	47,0	75	7	3	2			95000	
0,50	1,5	44,0	80	11	6	2			95100	
0,60	1,5	11,3	38	7	3	2	96000			
0,70	2,0	11,4	38	7	3	2	97000			
0,80	2,0	11,7	38	7	3	2	98000			
0,90	2,5	11,7	38	7	3	2	99000			
1,00	2,0	22,0	50	7	3	2	31000			
1,00	2,0	18,0	54	10	6	2	01000			
1,00	3,0	47,0	75	7	3	2				
1,00	3,0	44,0	80	10	6	2				
1,10	3,0	22,0	50	6	3	2	31100			
1,20	3,0	22,0	50	5	3	2	31200			
1,40	3,0	22,0	50	5	3	2	31400			
1,50	3,0	22,0	50	6	3	2	31500			
1,50	3,0	18,0	54	10	6	2	01500			
1,50	4,0	47,0	75	5	3	2				
1,50	4,0	44,0	80	10	6	2				
1,60	4,0	22,0	50	6	3	2	31600			
1,80	4,0	22,0	50	6	3	2	31800			
2,00	4,0	22,0	50	5	3	2	32000			
2,00	4,0	18,0	54	9	6	2	02000			
2,00	6,0	47,0	75	5	3	2				
2,00	6,0	44,0	80	10	6	2				
2,50	5,0	22,0	50	3	3	2	32500			
2,50	5,0	18,0	54	9	6	2	02500			
2,50	8,0	47,0	75	3	3	2				
2,50	8,0	44,0	80	10	6	2				
3,00	6,0	22,0	50	3	3	2	33000			
3,00	6,0	18,0	54	9	6	2	03000			
3,00	10,0	47,0	75	3	3	2				
3,00	10,0	44,0	80	9	6	2				

P	●	●	●	●
M	○	○	○	○
K	●	●	●	●
N	○	○	○	○
S	○	○	○	○
H				
O	○	○	○	○

Ball Nosed Cutter

▲ Radius accuracy: ± 0,01 mm

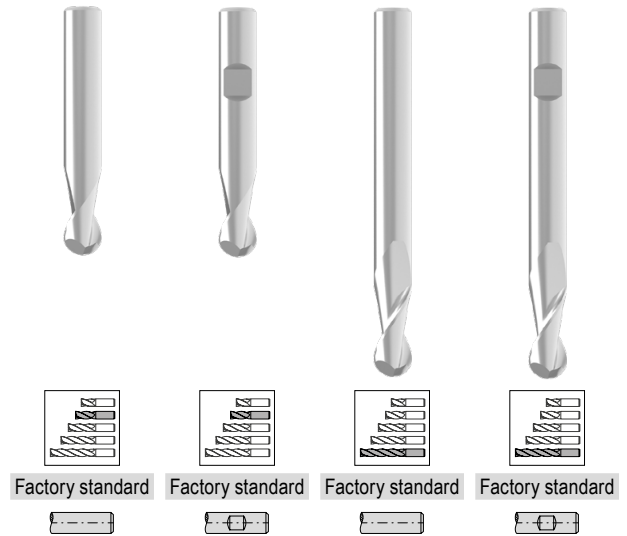
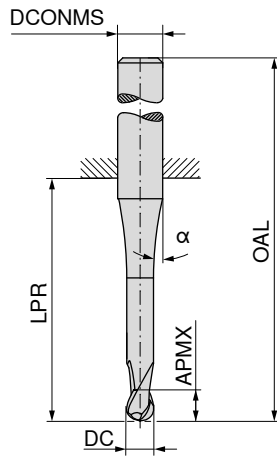
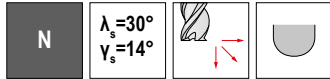

Factory standard Factory standard Factory standard Factory standard

DC _{rs} mm	APMX mm	LPR mm	OAL mm	α°	DCONMS _{rs} mm	ZEFP	52 050 ...	52 052 ...	52 051 ...	52 053 ...
4,00	7,0	18,0	54	7	6	2	04000	04000		
4,00	7,0	26,0	54		4	2	44000			
4,00	13,0	47,0	75		4	2			44000	
4,00	13,0	44,0	80	8	6	2			04000	04000
5,00	8,0	18,0	54	6	6	2	05000	05000		
5,00	8,0	26,0	54		5	2	55000			
5,00	14,0	47,0	75		5	2			55000	
5,00	14,0	64,0	100	5	6	2			05000	05000
6,00	10,0	18,0	54		6	2	06000	06000		
6,00	16,0	64,0	100		6	2			06000	06000
8,00	12,0	23,0	59		8	2	08000	08000		
8,00	22,0	64,0	100		8	2			08000	08000
10,00	13,0	27,0	67		10	2	10000	10000		
10,00	25,0	60,0	100		10	2			10000	10000
12,00	16,0	28,0	73		12	2	12000	12000		
12,00	26,0	55,0	100		12	2			12000	12000
14,00	16,0	30,0	75		14	2	14000	14000		
14,00	26,0	55,0	100		14	2			14000	14000
16,00	20,0	35,0	83		16	2	16000	16000		
16,00	30,0	102,0	150		16	2			16000	16000
20,00	25,0	43,0	93		20	2	20000	20000		
20,00	40,0	100,0	150		20	2			20000	20000

P	●	●	●	●
M	○	○	○	○
K	●	●	●	●
N	○	○	○	○
S	○	○	○	○
H				
O	○	○	○	○

→ v_c/f_z Page 480-486

Ball Nosed Cutter

▲ Radius accuracy: ± 0,01 mm

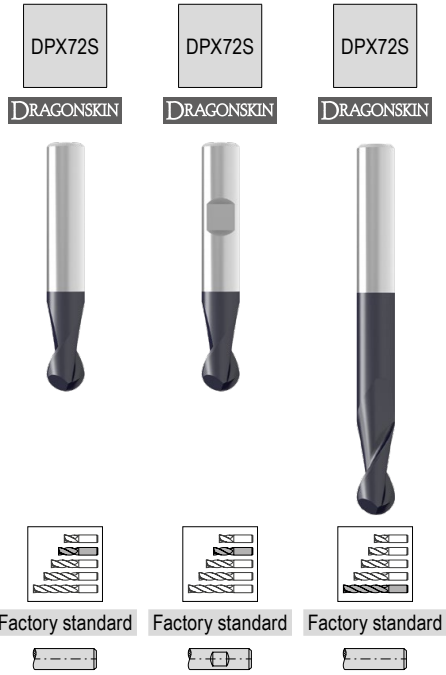
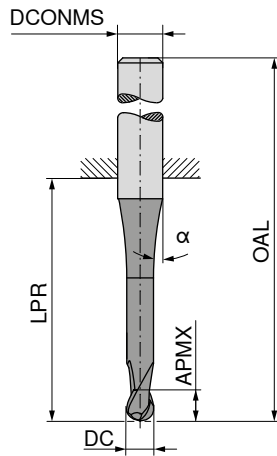
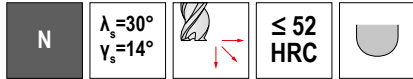

DC _{FB} mm	APMX mm	LPR mm	OAL mm	α°	DCONMS _{HS} mm	ZEFP
0,10	0,2	12,5	38	8	3	2
0,15	0,3	11,5	38	8	3	2
0,20	0,4	12,0	38	8	3	2
0,25	0,5	12,5	38	8	3	2
0,30	1,0	11,3	38	8	3	2
0,35	1,0	11,1	38	8	3	2
0,40	1,0	10,9	38	8	3	2
0,50	1,5	11,7	38	7	3	2
0,50	1,5	47,0	75	7	3	2
0,50	1,5	44,0	80	11	6	2
0,50	1,5	18,0	54	11	6	2
0,60	1,5	11,3	38	7	3	2
0,70	2,0	11,4	38	7	3	2
0,80	2,0	11,7	38	7	3	2
0,90	2,5	11,7	38	7	3	2
1,00	2,0	22,0	50	7	3	2
1,00	2,0	18,0	54	10	6	2
1,00	3,0	44,0	80	10	6	2
1,00	3,0	47,0	75	7	3	2
1,10	3,0	22,0	50	6	3	2
1,20	3,0	22,0	50	5	3	2
1,40	3,0	22,0	50	5	3	2
1,50	3,0	22,0	50	6	3	2
1,50	3,0	18,0	54	10	6	2
1,50	4,0	44,0	80	10	6	2
1,50	4,0	47,0	75	5	3	2
1,60	4,0	22,0	50	6	3	2
1,80	4,0	22,0	50	6	3	2
2,00	4,0	18,0	54	9	6	2
2,00	4,0	22,0	50	5	3	2
2,00	6,0	44,0	80	10	6	2
2,00	6,0	47,0	75	5	3	2
2,50	5,0	18,0	54	9	6	2
2,50	5,0	22,0	50	3	3	2
2,50	8,0	44,0	80	10	6	2
2,50	8,0	47,0	75	3	3	2
3,00	6,0	18,0	54	9	6	2

52 054 ...	52 056 ...	52 055 ...
91000		
91500		
92000		
92500		
93000		
93500		
94000		
95000		
		95000
		95100
95100		
96000		
97000		
98000		
99000		
31000		
01000	01000	
		01000
		31000
31100		
31200		
31400		
31500		
01500	01500	
		01500
		31500
31600		
31800		
02000	02000	
32000		
		02000
		32000
02500	02500	
32500		
		02500
		32500
03000	03000	

P	●	●	●
M	○	○	○
K	●	●	●
N	○	○	○
S	○	○	○
H	○	○	○
O	○	○	○

→ v_c/f_z Page 480-486

Ball Nosed Cutter

▲ Radius accuracy: ± 0,01 mm

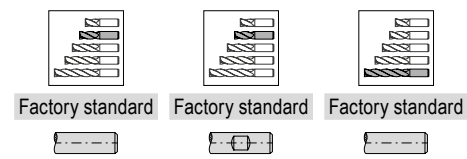
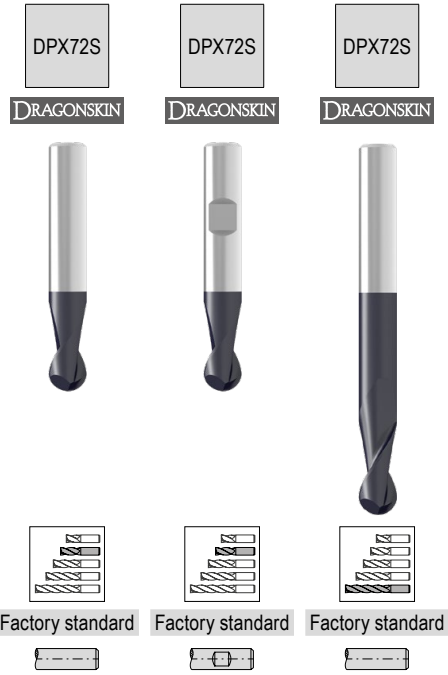
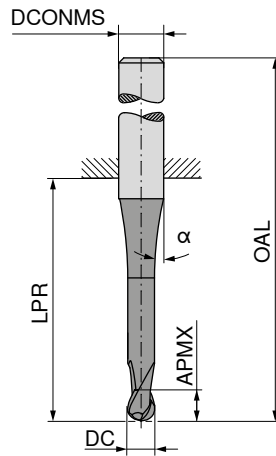
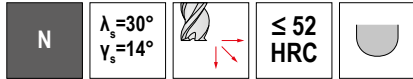

DC _{FB} mm	APMX mm	LPR mm	OAL mm	α°	DCONMS _{FB} mm	ZEFP
3,00	6,0	22,0	50		3	2
3,00	10,0	47,0	75		3	2
3,00	10,0	44,0	80	9	6	2
4,00	7,0	18,0	54	10	6	2
4,00	7,0	26,0	54		4	2
4,00	13,0	47,0	75		4	2
4,00	13,0	44,0	80	8	6	2
5,00	8,0	18,0	54	6	6	2
5,00	8,0	26,0	54		5	2
5,00	14,0	47,0	75		5	2
5,00	14,0	64,0	100	5	6	2
6,00	10,0	18,0	54		6	2
6,00	16,0	64,0	100		6	2
8,00	12,0	23,0	59		8	2
8,00	22,0	64,0	100		8	2
10,00	13,0	27,0	67		10	2
10,00	25,0	60,0	100		10	2
12,00	16,0	28,0	73		12	2
12,00	26,0	55,0	100		12	2
14,00	16,0	30,0	75		14	2
14,00	26,0	55,0	100		14	2
16,00	20,0	35,0	83		16	2
16,00	30,0	102,0	150		16	2
18,00	22,0	45,0	93		18	2
20,00	25,0	43,0	93		20	2
20,00	40,0	100,0	150		20	2

52 054 ...	52 056 ...	52 055 ...
33000		
		33000
		03000
04000	04000	
44000		
		44000
		04000
05000	05000	
55000		
		55000
		05000
06000	06000	
		06000
08000	08000	
		08000
10000	10000	
		10000
12000	12000	
		12000
14000	14000	
		14000
16000	16000	
		16000
18000	18000	
20000	20000	
		20000

P	●	●	●
M	○	○	○
K	●	●	●
N	○	○	○
S	○	○	○
H	○	○	○
O	○	○	○

→ v_c/f_z Page 480-486

Ball Nosed Cutter

▲ Radius accuracy: ± 0.005 mm
▲ For Ø DC ≤ 5.0 mm, angle tolerance α and β: ± 0.5°

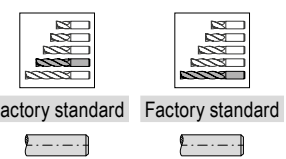
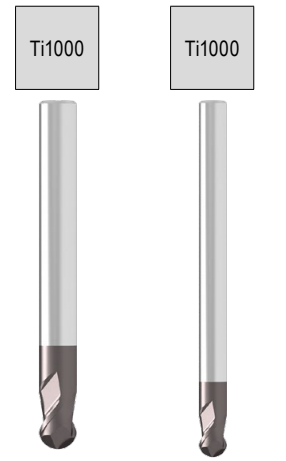
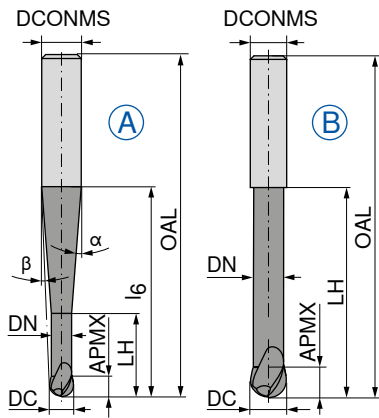

DC ±0,01 mm	APMX mm	DN mm	LH mm	l ₆ mm	OAL mm	α°	β°	DCONMS _{ns} mm	ZEFP	Fig.
0,5	1,0	0,45	2,0	20	57	10	8,5	6	2	A
1,0	2,0	0,95	4,0	20	57	10	8	6	2	A
1,0	2,0	0,95	4,0	40	80	4,5	4	6	2	A
1,5	2,5	1,40	7,5	20	57	12,5	7	6	2	A
1,5	2,5	1,40	7,5	40	80	4,5	3,5	6	2	A
2,0	3,0	1,80	8,0	20	57	12	6,5	6	2	A
2,0	3,0	1,80	8,0	40	80	4	3	6	2	A
3,0	3,5	2,80	10,0	20	57	11,5	5	6	2	A
3,0	3,5	2,80	12,0	40	80	3,5	2,5	6	2	A
4,0	4,0	3,80	12,0	20	57	11	3,5	6	2	A
4,0	4,0	3,80	20,0	40	80	4	1,5	6	2	A
5,0	5,0	4,70	14,0	20	57	10	2	6	2	A
5,0	5,0	4,70	25,0	40	80	3	1	6	2	A
6,0	6,0	5,60	20,0		57			6	2	B
6,0	6,0	5,60	40,0		80			6	2	B
6,0	6,0	5,60	25,0	60	100	2	1	8	2	A
8,0	7,0	7,60	25,0		63			8	2	B
8,0	7,0	7,60	60,0		100			8	2	B
8,0	7,0	7,60	30,0	75	120	2	1	10	2	A
10,0	8,0	9,60	30,0		72			10	2	B
10,0	8,0	9,60	50,0		100			10	2	B
10,0	8,0	9,60	75,0		120			10	2	B
10,0	8,0	9,60	40,0	110	160	1	1	12	2	A
12,0	10,0	11,50	35,0		83			12	2	B
12,0	10,0	11,50	35,0	40	92	35	3,5	16	2	A
12,0	10,0	11,50	70,0		120			12	2	B
12,0	10,0	11,50	70,0		160			12	2	B
12,0	10,0	11,50	50,0	150	200	1,5	1	16	2	A
16,0	12,0	15,50	40,0		92			16	2	B
16,0	12,0	15,50	80,0		200			16	2	B

	52 714 ...	52 717 ...
P	●	●
M	○	○
K	●	●
N	○	○
S	○	○
H	○	○
O	○	○

→ v_c/f_z Page 480–486

Ball Nosed Cutter

▲ Radius accuracy: $\pm 0,01$ mm

▲ for $\varnothing \leq 5.0$ mm, angle tolerance α and β : $\pm 0.5^\circ$

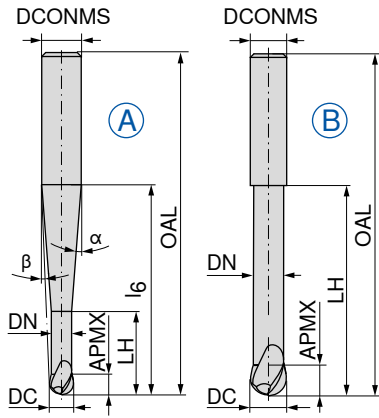

Factory standard



52 320 ...

DC _{es} mm	APMX mm	DN mm	LH mm	l ₆ mm	OAL mm	α°	β°	DCONMS _{h6} mm	ZEFP	Fig.	
2	3	1,8	8	40	100	3,6	3	6	2	A	020
3	4	2,8	12	40	100	3,1	2,1	6	2	A	030
4	5	3,8	16	40	100	2,4	1,2	6	2	A	040
5	6	4,7	20	40	100	1,4	0,7	6	2	A	050
6	6	5,7	25	50	100	2,3	1,2	8	2	A	061
6	6	5,7	25		100			6	2	B	060
8	7	7,7	32		100			8	2	B	080
8	7	7,7	32	60	120	2	1	10	2	A	081
10	9	9,6	40	81	160	1,4	0,7	12	2	A	101
10	9	9,6	40		120			10	2	B	100
12	11	11,6	50		160			12	2	B	120
12	11	11,6	50	101	200	2,3	1,2	16	2	A	121
16	14	15,6	60		200			16	2	B	160

P	●
M	○
K	●
N	○
S	○
H	○
O	○

→ v_c/f_z Page 480–486

Ball Nosed Cutter 220°

▲ Radius accuracy: ± 0,005 mm

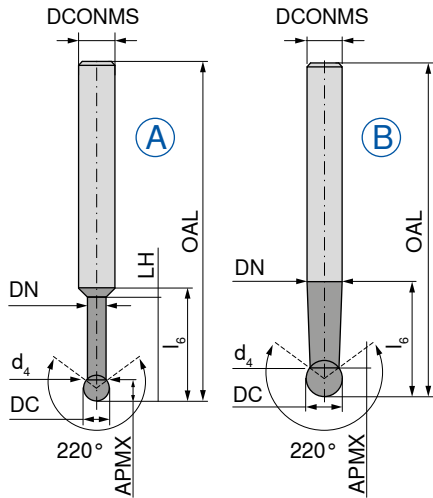

Ti1000



Factory standard



52 323 ...

DC _{FB} mm	APMX mm	DN mm	d ₄ mm	LH mm	l ₆ mm	OAL mm	DCONMS _{h6} mm	ZEFP	Fig.	
1,0	0,7	0,80	0,8	5	17	58	6	2	A	010
1,5	1,2	1,20	1,2	8	20	58	6	2	A	015
2,0	1,5	1,40	1,4	10	21	58	6	2	A	020
3,0	2,3	2,40	2,4	15	22	65	6	2	A	030
4,0	3,0	3,40	3,4	20	25	70	6	2	A	040
5,0	3,5	4,30	4,3	25	28	80	6	2	A	050
6,0	4,0	5,90	5,3	30	30	100	6	2	A	060
8,0	6,5	7,90	6,2		40	100	8	2	B	080
10,0	8,2	9,90	7,6		50	100	10	2	B	100
12,0	9,9	11,90	9,2		110	160	12	2	B	121
12,0	9,9	11,90	9,2		70	120	12	2	B	120

P	●
M	○
K	●
N	○
S	○
H	○
O	○

→ v_c/f_z Page 480-486

Ball Nosed Cutter

▲ Radius accuracy: ± 0,01 mm

N
 $\lambda_s=30^\circ$
 $\gamma_s=13^\circ$

HPC

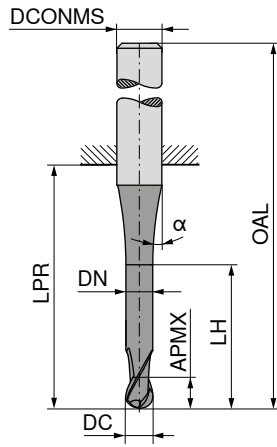
Ti1000



≈DIN 6527



54 073 ...

DC _{h10} mm	APMX mm	DN mm	LH mm	LPR mm	OAL mm	DCONMS _{h6} mm	α°	ZEFP	
3	5	2,9	9	14	50	6	15	2	03115
4	8	3,9	12	18	54	6	45	2	04120
5	9	4,9	15	18	54	6	45	2	05125
6	10	5,9	17	18	54	6	45	2	06130
8	12	7,8	20	22	58	8	45	2	08140
10	14	9,8	26	26	66	10	45	2	10150
12	16	11,8	28	28	73	12	45	2	12160
16	22	15,7	32	34	82	16	45	2	16180
20	26	19,7	40	42	92	20	45	2	20110

P	●
M	○
K	●
N	●
S	○
H	
O	

→ v_c/f_z Page 476+477

Ball Nosed Cutter

▲ Radius accuracy: ± 0,005 mm

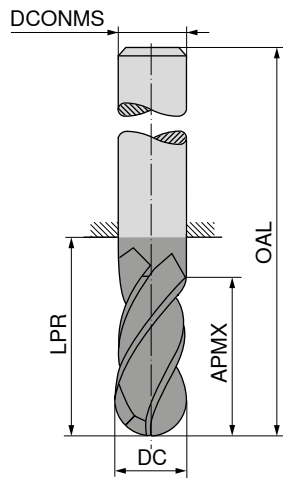
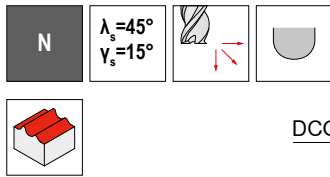

DC ₁₈ mm	APMX mm	LPR mm	OAL mm	DCONMS _{h6} mm	ZEFP
3	5	22	50	3	4
3	5	47	75	3	4
4	8	26	54	4	4
4	8	47	75	4	4
5	9	26	54	5	4
5	9	47	75	5	4
6	10	18	54	6	4
6	10	64	100	6	4
8	12	23	59	8	4
8	12	64	100	8	4
10	14	27	67	10	4
10	14	60	100	10	4
12	16	29	74	12	4
12	16	55	100	12	4
14	18	30	75	14	4
14	18	55	100	14	4
16	22	35	83	16	4
16	22	102	150	16	4
20	26	43	93	20	4
20	26	100	150	20	4

	52 400 ...	52 402 ...
P	○	○
M	●	●
K	○	○
N	●	●
S	●	●
H		
O	●	●

→ v_c/f_z Page 480–486

Ball Nosed Cutter

▲ Radius accuracy: ± 0,01 mm

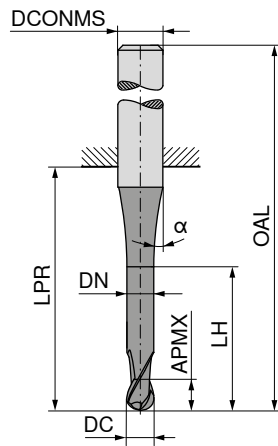
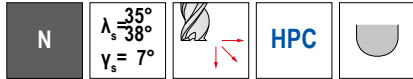

≈DIN 6527 ≈DIN 6527



54 074 ...	54 074 ...
03115	03215
04120	04220
05125	05225
06130	06430
08140	08440
10150	10450
12160	12460
16180	16480
20110	20410

DC _{h10} mm	APMX mm	DN mm	LH mm	LPR mm	OAL mm	DCONMS _{h6} mm	α°	ZEFP
3	8			21	57	6	30	4
3	8	2,9	15	21	57	6	45	4
4	11			21	57	6	30	4
4	11	3,9	16	21	57	6	45	4
5	13			21	57	6	30	4
5	13	4,9	19	21	57	6	45	4
6	13			21	57	6	30	4
6	13	5,9	19	21	57	6	45	4
8	19			36	72	8	30	4
8	19	7,8	25	27	72	8	45	4
10	22			32	72	10	30	4
10	22	9,7	30	32	72	10	45	4
12	26			38	83	12	30	4
12	26	11,7	36	38	83	12	45	4
16	32			44	92	16	30	4
16	32	15,5	42	44	92	16	45	4
20	38			54	104	20	30	4
20	38	19,5	52	54	104	20	45	4

P	●	●
M	●	●
K	●	●
N	○	○
S		
H		
O		

→ v_c/f_z Page 478+479

Ball Nosed Cutter

▲ Radius accuracy: ± 0,01 mm

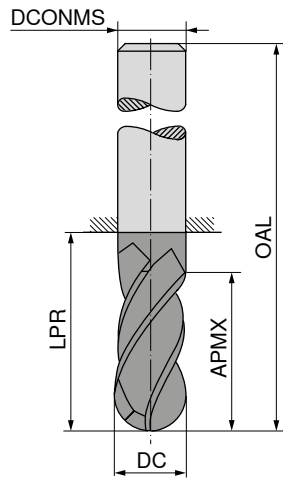

DC ₁₈ mm	APMX mm	LPR mm	OAL mm	DCONMS _{h5} mm	ZEFP
3	8	21	57	6	4
4	11	21	57	6	4
6	13	21	57	6	4
6	40	64	100	6	4
8	19	27	63	8	4
8	40	64	100	8	4
10	22	32	72	10	4
10	40	60	100	10	4
12	26	38	83	12	4
12	45	55	100	12	4
12	75	105	150	12	4
14	26	38	83	14	4
14	45	55	100	14	4
16	32	44	92	16	4
16	75	102	150	16	4
20	38	54	104	20	4
20	75	100	150	20	4

	50 643 ...	50 643 ...
P	●	●
M	○	○
K	●	●
N	○	○
S	○	○
H	○	○
O	○	○

50 643 ...	50 643 ...
030	
040	
060	
080	061
100	081
120	101
140	121
160	141
200	161
	201

→ v_c/f_z Page 480-486

Ball Nosed Cutter

▲ Radius accuracy: ± 0.005 mm

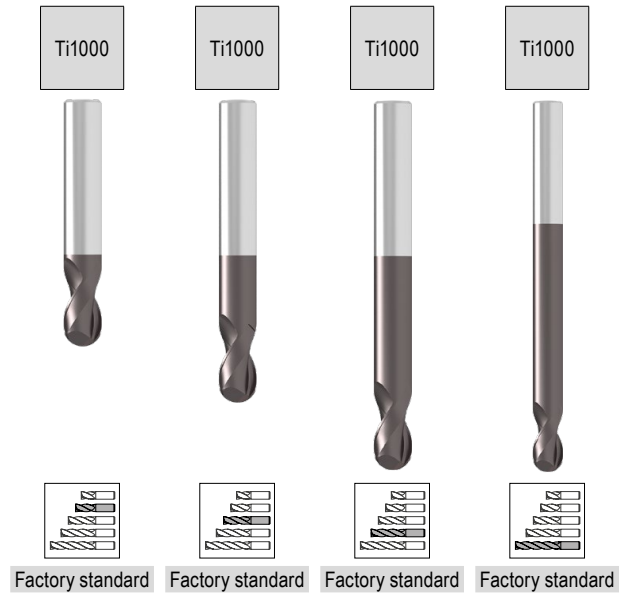
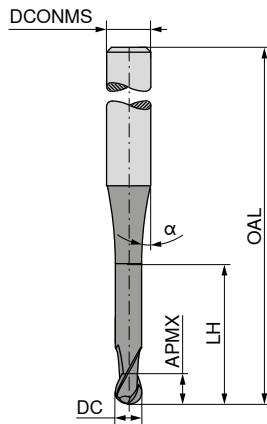

DC mm	DC Tol.	APMX mm	LH mm	OAL mm	α°	DCONMS _{HS} mm	ZEFP
0,20	0/-0,015	0,3	0,6	40	15	4	2
0,25	0/-0,015	0,3	0,6	40	15	4	2
0,30	0/-0,015	0,3	0,6	40	15	4	2
0,35	0/-0,015	0,4	0,7	40	15	4	2
0,40	0/-0,015	0,4	0,7	40	15	4	2
0,50	0/-0,015	0,5	0,8	40	15	4	2
0,50	0/-0,015	0,5	0,8	54	15	6	2
0,60	0/-0,015	0,6	0,9	40	15	4	2
0,70	0/-0,015	0,8	1,1	40	15	4	2
0,80	0/-0,015	0,8	1,1	40	15	4	2
0,90	0/-0,015	0,9	1,2	40	15	4	2
1,00	0/-0,015	1,0	1,3	54		4	2
1,00	0/-0,015	1,0	1,3	54	15	6	2
1,00	0/-0,015	1,0	1,3	64		6	2
1,00	0/-0,015	1,0	1,3	80		6	2
1,00	0/-0,015	1,0	1,3	100		6	2
1,20	0/-0,015	1,2	1,5	54		4	2
1,40	0/-0,015	1,4	1,8	54		4	2
1,50	0/-0,015	1,5	1,9	54		4	2
1,50	0/-0,015	1,5	1,9	54	15	6	2
1,50	0/-0,015	1,5	1,9	80		6	2
1,60	0/-0,015	1,8	2,3	54		4	2
1,80	0/-0,015	1,8	2,3	54		4	2
2,00	0/-0,015	2,0	2,5	54		4	2
2,00	0/-0,015	4,0	5,0	54		6	2
2,00	0/-0,015	4,0	5,0	64		6	2
2,00	0/-0,015	4,0	5,0	82		6	2
2,00	0/-0,015	4,0	5,0	100		6	2
2,50	0/-0,02	5,0	6,6	54		4	2
2,50	0/-0,02	5,0	6,3	54	15	6	2
2,50	0/-0,02	5,0	6,3	64		6	2
2,50	0/-0,02	5,0	6,3	82		6	2
2,50	0/-0,02	5,0	6,3	100		6	2
3,00	0/-0,02	5,0	6,3	54		4	2
3,00	0/-0,02	5,0	6,3	82		4	2
3,00	0/-0,02	5,0	6,3	100		4	2
3,00	0/-0,02	5,0	6,3	54	15	6	2
3,00	0/-0,02	5,0	6,3	64		6	2
3,00	0/-0,02	5,0	6,3	82		6	2
3,00	0/-0,02	8,0	10,0	100		6	2
4,00	0/-0,02	8,0	10,0	54	15	4	2
4,00	0/-0,02	8,0	10,0	82	15	4	2
4,00	0/-0,02	8,0	10,0	100	15	4	2

50 906 ...	50 906 ...	50 906 ...	50 906 ...
002			
925			
003			
935			
004			
005			
951			
006			
007			
008			
009			
011		010	
		012	
			013
			014
		112	
		114	
		115	
215			
		116	
		118	
		206	
		202	
		207	
			204
			205
		251	
252			
		253	
			254
			255
		030	
			032
			033
035		036	
			037
			038
		040	
			042
			043

P	●	●	●	●
M	○	○	○	○
K	●	●	●	●
N	○	○	○	○
S	○	○	○	○
H	○	○	○	○
O	○	○	○	○

Ball Nosed Cutter

▲ Radius accuracy: ± 0.005 mm

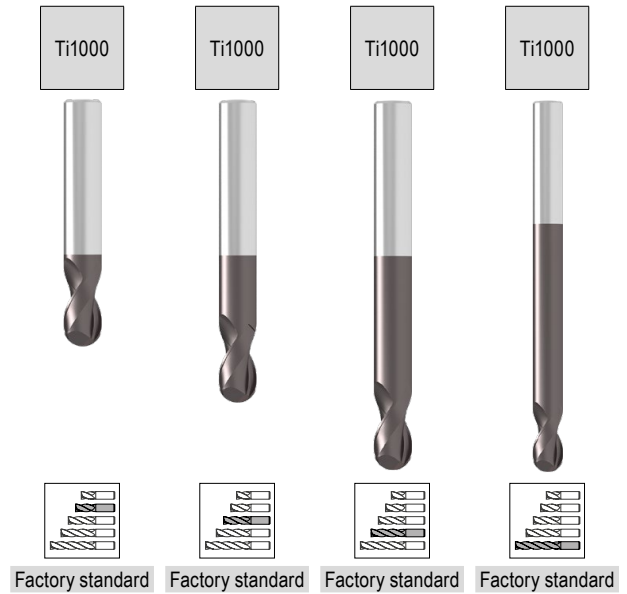
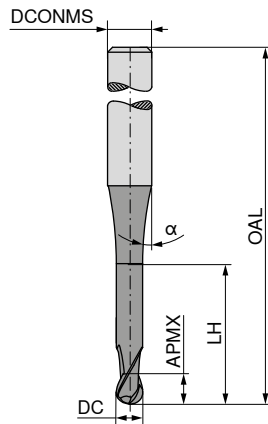

DC mm	DC Tol.	APMX mm	LH mm	OAL mm	α°	DCONMS _{h5} mm	ZEFP
4,00	0/-0,02	8,0	10,0	54	15	6	2
4,00	0/-0,02	8,0	10,0	64		6	2
4,00	0/-0,02	8,0	10,0	82		6	2
4,00	0/-0,02	8,0	10,0	100		6	2
5,00	0/-0,02	9,0		54	15	5	2
5,00	0/-0,02	9,0		64	15	5	2
5,00	0/-0,02	9,0	11,3	82	15	5	2
5,00	0/-0,02	9,0	11,3	100	15	5	2
5,00	0/-0,02	9,0	11,3	54	15	6	2
5,00	0/-0,02	9,0	11,3	64		6	2
5,00	0/-0,02	9,0	11,3	82		6	2
5,00	0/-0,02	9,0	11,3	100		6	2
6,00	0/-0,02	10,0		54	15	6	2
6,00	0/-0,02	10,0		64	15	6	2
6,00	0/-0,02	10,0		82	15	6	2
6,00	0/-0,02	10,0		100	15	6	2
6,00	0/-0,02	10,0		120	15	6	2
8,00	0/-0,025	12,0		64	15	8	2
8,00	0/-0,025	12,0		82	15	8	2
8,00	0/-0,025	12,0		100	15	8	2
8,00	0/-0,025	12,0		120	15	8	2
10,00	0/-0,025	14,0		67	15	10	2
10,00	0/-0,025	14,0		82	15	10	2
10,00	0/-0,025	14,0		100	15	10	2
10,00	0/-0,025	14,0		127	15	10	2
12,00	0/-0,025	16,0		75	15	12	2
12,00	0/-0,025	16,0		100	15	12	2
12,00	0/-0,025	16,0		150	15	12	2
14,00	0/-0,025	18,0		80	15	14	2
14,00	0/-0,025	18,0		100	15	14	2
14,00	0/-0,025	18,0		150	15	14	2
16,00	0/-0,025	22,0		85	15	16	2
16,00	0/-0,025	22,0		150	15	16	2
20,00	0/-0,025	26,0		90	15	20	2
20,00	0/-0,025	26,0		150	15	20	2

50 906 ...	50 906 ...	50 906 ...	50 906 ...
045			
		046	
			047
			048
		050	
		051	
			052
			053
055			
		056	
			057
			058
060			
		061	
			062
			063
			064
		081	
			083
			084
101			
	082		
			103
			104
121			
	122		
			123
141			
	142		
			143
161			
			163
201			
			203

P	●	●	●	●
M	○	○	○	○
K	●	●	●	●
N	○	○	○	○
S	○	○	○	○
H	○	○	○	○
O	○	○	○	○

→ v_c/f_z Page 480-486

Torus Cutter

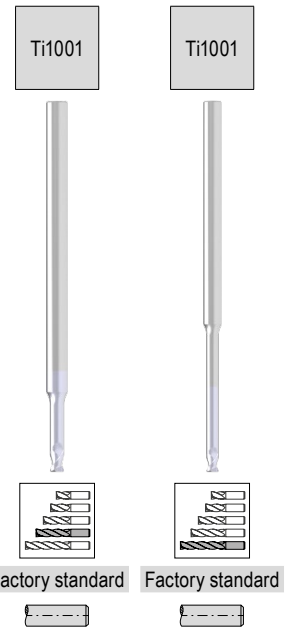
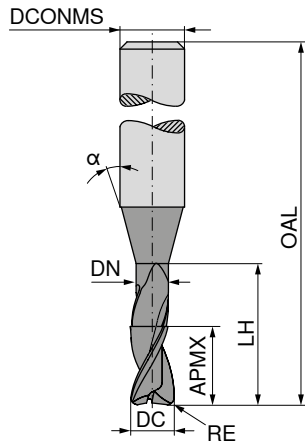

DC _{FB}	RE _{0.015}	APMX	DN	LH	OAL	α°	DCONMS _{h5}	ZEFP
mm	mm	mm	mm	mm	mm		mm	
0,2	0,02	0,2	0,18	0,6	55	15	3	2
0,2	0,02	0,2	0,18	1,0	55	15	3	2
0,2	0,02	0,2	0,18	1,6	55	15	3	2
0,2	0,02	0,2	0,18	2,0	55	15	3	2
0,3	0,03	0,3	0,28	0,9	55	15	3	2
0,3	0,03	0,3	0,28	1,5	55	15	3	2
0,3	0,03	0,3	0,28	2,4	55	15	3	2
0,3	0,03	0,3	0,28	3,0	55	15	3	2
0,4	0,04	0,4	0,37	1,2	55	15	3	2
0,4	0,04	0,4	0,37	2,0	55	15	3	2
0,4	0,04	0,4	0,37	3,2	55	15	3	2
0,4	0,04	0,4	0,37	4,0	55	15	3	2
0,5	0,05	0,5	0,45	1,5	55	15	3	2
0,5	0,05	0,5	0,45	2,5	55	15	3	2
0,5	0,05	0,5	0,45	4,0	55	15	3	2
0,5	0,05	0,5	0,45	5,0	55	15	3	2
0,6	0,06	0,6	0,58	2,0	55	15	3	2
0,6	0,06	0,6	0,58	3,0	55	15	3	2
0,6	0,06	0,6	0,58	4,2	55	15	3	2
0,6	0,06	0,6	0,58	5,0	65	15	3	2
0,6	0,06	0,6	0,58	6,0	65	15	3	2
0,8	0,08	0,8	0,77	2,5	55	15	3	2
0,8	0,08	0,8	0,77	4,0	55	15	3	2
0,8	0,08	0,8	0,77	6,5	65	15	3	2
0,8	0,08	0,8	0,77	8,0	65	15	3	2
1,0	0,10	1,0	0,95	3,0	55	15	3	2
1,0	0,10	1,0	0,95	5,0	55	15	3	2
1,0	0,10	1,0	0,95	8,0	65	15	3	2
1,0	0,10	1,0	0,95	10,0	65	15	3	2
1,0	0,10	1,0	0,95	12,0	65	15	3	2
1,2	0,12	1,2	1,15	3,0	55	15	3	2
1,2	0,12	1,2	1,15	6,0	55	15	3	2
1,2	0,12	1,2	1,15	10,0	65	15	3	2
1,2	0,12	1,2	1,15	12,0	65	15	3	2
1,3	0,13	1,3	1,25	4,0	55	15	3	2
1,3	0,13	1,3	1,25	7,0	55	15	3	2
1,3	0,13	1,3	1,25	11,0	65	15	3	2
1,3	0,13	1,3	1,25	13,0	65	15	3	2
1,5	0,15	1,5	1,44	5,0	55	15	3	2
1,5	0,15	1,5	1,44	7,5	55	15	3	2
1,5	0,15	1,5	1,44	12,0	65	15	3	2
1,5	0,15	1,5	1,44	15,0	65	15	3	2
1,6	0,16	1,6	1,52	5,0	55	15	3	2
1,6	0,16	1,6	1,52	8,0	55	15	3	2
1,6	0,16	1,6	1,52	13,0	65	15	3	2

50 901 ...	50 901 ...
021	
022	
023	
024	
031	
032	
033	
034	
041	
042	
043	
044	
051	
052	
053	
054	
061	
062	
063	
	064
	065
081	
082	
	083
	084
101	
102	
	103
	104
	105
121	
122	
	123
	124
131	
132	
	133
	134
151	
152	
	153
	154
161	
162	
	163

P	
M	
K	
N	•
S	
H	
O	

Torus Cutter

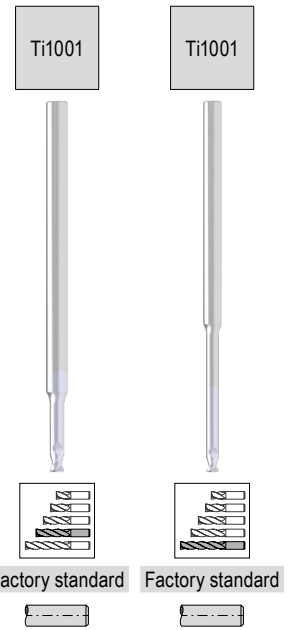
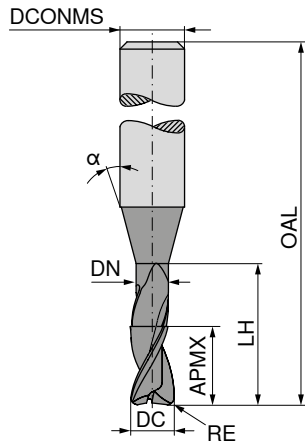

DC _{FB}	RE _{0,015}	APMX	DN	LH	OAL	α°	DCONMS _{h5}	ZEFP
mm	mm	mm	mm	mm	mm		mm	
1,6	0,16	1,6	1,52	16,0	65	15	3	2
1,8	0,18	1,8	1,72	5,5	55	15	3	2
1,8	0,18	1,8	1,72	9,0	55	15	3	2
1,8	0,18	1,8	1,72	14,5	65	15	3	2
1,8	0,18	1,8	1,72	18,0	65	15	3	2
2,0	0,20	2,0	1,92	6,0	55	15	3	2
2,0	0,20	2,0	1,92	10,0	55	15	3	2
2,0	0,20	2,0	1,92	14,0	55	15	3	2
2,0	0,20	2,0	1,92	16,0	65	15	3	2
2,0	0,20	2,0	1,92	20,0	65	15	3	2
2,3	0,23	2,3	2,22	7,0	55	15	3	2
2,3	0,23	2,3	2,22	11,5	55	15	3	2
2,3	0,23	2,3	2,22	14,0	55	15	3	2
2,3	0,23	2,3	2,22	18,5	65	15	3	2
2,3	0,23	2,3	2,22	20,0	65	15	3	2
2,3	0,23	2,3	2,22	23,0	65	15	3	2
3,0	0,30	3,0	2,90	9,0	65	15	6	2
3,0	0,30	3,0	2,90	15,0	65	15	6	2
3,0	0,30	3,0	2,90	24,0	100	15	6	2
3,0	0,30	3,0	2,90	30,0	100	15	6	2
4,0	0,40	4,0	3,90	12,0	65	15	6	2
4,0	0,40	4,0	3,90	20,0	65	15	6	2
4,0	0,40	4,0	3,90	32,0	100	15	6	2
4,0	0,40	4,0	3,90	40,0	100	15	6	2
5,0	0,50	5,0	4,90	15,0	65	15	6	2
5,0	0,50	5,0	4,90	25,0	65	15	6	2
5,0	0,50	5,0	4,90	40,0	100	15	6	2
5,0	0,50	5,0	4,90	50,0	100	15	6	2
6,0	0,60	6,0	5,90	18,0	65	15	6	2
6,0	0,60	6,0	5,90	30,0	100	15	6	2
6,0	0,60	6,0	5,90	48,0	100	15	6	2
6,0	0,60	6,0	5,90	60,0	100	15	6	2

50 901 ...	50 901 ...
	164
181	
182	
	183
	184
201	
202	
203	
	204
	205
231	
232	
233	
	234
	235
	236
301	
302	
	303
	304
401	
402	
	403
	404
501	
502	
	503
	504
601	
	602
	603
	604

P
M
K
N
S
H
O

→ v_c/f_z Page 480-486

Torus Cutter

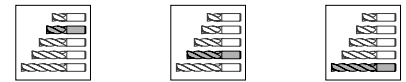
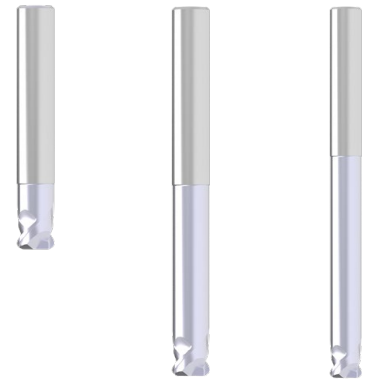
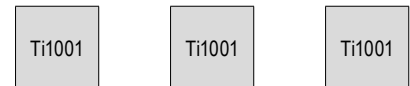
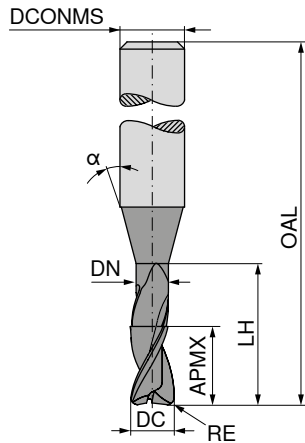

Factory standard Factory standard Factory standard

DC _{FB} mm	RE _{±0.05} mm	APMX mm	DN mm	LH mm	OAL mm	α°	DCONMS _{h5} mm	ZEFP
2	0,3	2	1,8	12	50	45	6	2
2	0,5	2	1,8	12	50	45	6	2
2	0,3	2	1,8	22	60	45	6	2
2	0,5	2	1,8	22	60	45	6	2
2	0,3	2	1,8	47	85	45	6	2
2	0,5	2	1,8	47	85	45	6	2
3	0,3	2	2,8	12	50	45	6	2
3	0,5	2	2,8	12	50	45	6	2
3	0,3	2	2,8	22	60	45	6	2
3	0,5	2	2,8	22	60	45	6	2
3	0,3	2	2,8	47	85	45	6	2
3	0,5	2	2,8	47	85	45	6	2
4	0,3	3	3,8	16	54	45	6	2
4	0,5	3	3,8	16	54	45	6	2
4	1,0	3	3,8	16	54	45	6	2
4	0,3	3	3,8	37	75	45	6	2
4	0,5	3	3,8	37	75	45	6	2
4	1,0	3	3,8	37	75	45	6	2
4	0,3	3	3,8	47	85	45	6	2
4	0,5	3	3,8	47	85	45	6	2
4	1,0	3	3,8	47	85	45	6	2
5	0,5	3	4,6	16	54	45	6	2
5	1,0	3	4,6	16	54	45	6	2
5	1,5	3	4,6	16	54	45	6	2
5	0,5	3	4,6	37	75	45	6	2
5	1,0	2	4,6	37	75	45	6	2
5	1,5	3	4,6	37	75	45	6	2
6	0,5	4	5,6	16	54	45	6	2
6	1,0	4	5,6	16	54	45	6	2
6	2,0	4	5,6	16	54	45	6	2
6	0,5	4	5,6	47	85	45	6	2
6	1,0	4	5,6	47	85	45	6	2
6	2,0	4	5,6	47	85	45	6	2
6	0,5	4	5,6	47	85	45	8	2
6	1,0	4	5,6	47	85	45	8	2
6	2,0	4	5,6	47	85	45	8	2
6	0,5	4	5,6	62	100	45	6	2
6	1,0	4	5,6	62	100	45	6	2
6	2,0	4	5,6	62	100	45	6	2
8	0,5	4	7,6	20	58	45	8	2

50 902 ...	50 902 ...	50 902 ...
020		
023		
	021	
	024	
		022
		025
030		
033		
	031	
	034	
		032
		035
040		
043		
046		
	041	
	044	
	047	
		042
		045
		048
050		
052		
054		
	051	
	053	
	055	
060		
063		
066		
	061	
	064	
	067	
	069	
	070	
	071	
		062
		065
		068
080		

P			
M			
K			
N	•	•	•
S			
H			
O			

→ v_c/f_z Page 480-486

Torus Cutter

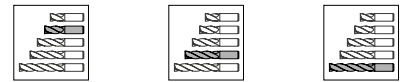
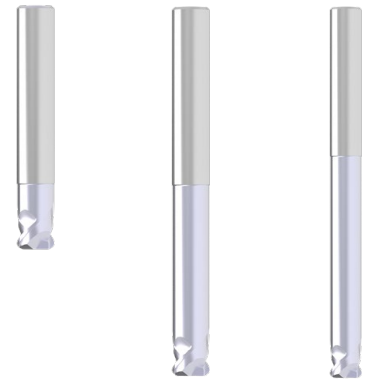
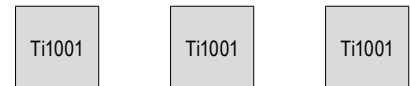
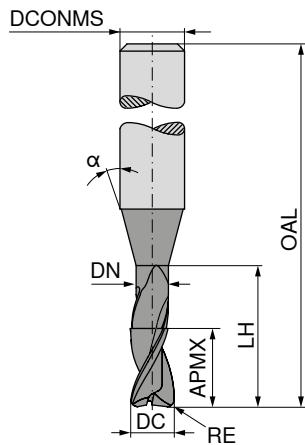

Factory standard Factory standard Factory standard

50 902 ...	50 902 ...	50 902 ...
082		
084		
		081
		083
		085
		086
100		
103		
106		
	101	
	104	
	107	
		102
		105
		108
		109
		110
		111
120		
123		
126		
	121	
	124	
	127	
		122
		125
		128
		131
		132
		133
		134

DC _{FB} mm	RE _{±0.05} mm	APMX mm	DN mm	LH mm	OAL mm	α°	DCONMS _{h5} mm	ZEFP
8	1,0	4	7,6	20	58	45	8	2
8	2,0	4	7,6	20	58	45	8	2
8	0,5	4	7,6	62	100	45	8	2
8	1,0	4	7,6	62	100	45	8	2
8	2,0	4	7,6	62	100	45	8	2
8	2,0	4	7,6	62	100	45	10	2
10	1,0	6	9,6	18	66	45	10	2
10	2,0	6	9,6	18	66	45	10	2
10	3,0	6	9,6	18	66	45	10	2
10	1,0	6	9,6	58	100	45	10	2
10	2,0	6	9,6	58	100	45	10	2
10	3,0	6	9,6	58	100	45	10	2
10	1,0	6	9,6	78	120	45	10	2
10	2,0	6	9,6	78	120	45	10	2
10	3,0	6	9,6	78	120	45	10	2
10	1,0	6	9,6	78	120	45	12	2
10	2,0	6	9,6	78	120	45	12	2
10	3,0	6	9,6	78	120	45	12	2
12	1,0	8	11,5	26	73	45	12	2
12	2,0	8	11,5	26	73	45	12	2
12	3,0	8	11,5	26	73	45	12	2
12	1,0	8	11,5	53	100	45	12	2
12	2,0	8	11,5	53	100	45	12	2
12	3,0	8	11,5	53	100	45	12	2
12	1,0	8	11,5	73	120	45	12	2
12	2,0	8	11,5	73	120	45	12	2
12	3,0	8	11,5	73	120	45	12	2
12	4,0	8	11,5	73	120	45	12	2
12	1,0	8	11,5	103	150	45	16	2
12	2,0	8	11,5	103	150	45	16	2
12	3,0	8	11,5	103	150	45	16	2

P								
M								
K								
N						•	•	•
S								
H								
O								

→ v_c/f_z Page 480-486

Torus Cutter

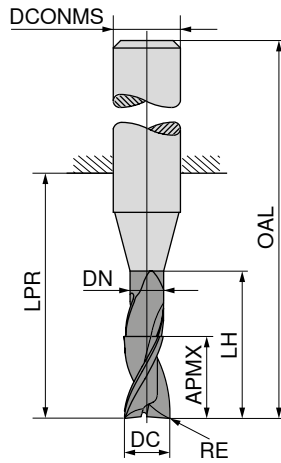
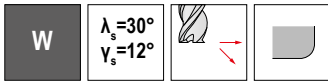

DIAMOND



Factory standard



52 765 ...

DC _{h10} mm	RE mm	APMX mm	DN mm	LH mm	LPR mm	OAL mm	DCONMS _{h6} mm	ZEFP	
2	0,3	8	1,8	31	32	60	2	2	021
3	0,5	12	2,8	41	42	70	3	2	032
4	0,5	15	3,8	51	52	80	4	2	042
5	0,5	20	4,8	71	72	100	5	2	052
6	0,8	20	5,8	63	64	100	6	2	063
8	1,0	20	7,8	83	84	120	8	2	084
10	1,0	25	9,8	99	100	140	10	2	104
12	1,5	25	11,8	104	105	150	12	2	125

P
M
K
N
S
H
O

→ v_c/f_z Page 418

Torus Cutter

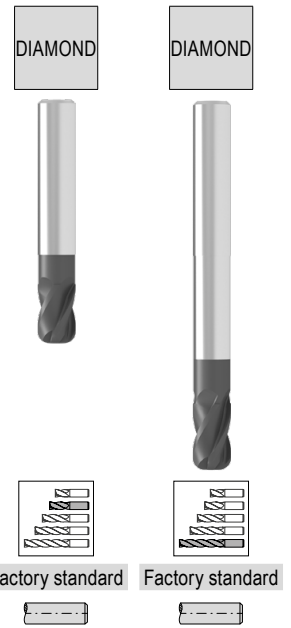
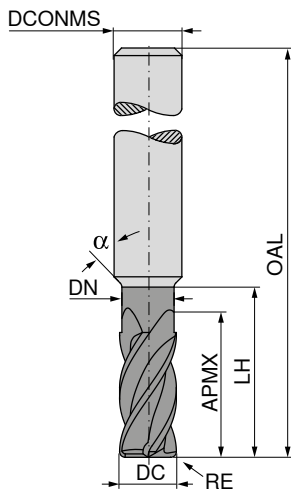
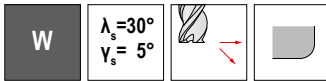

DC ₁₈ mm	RE _{±0.05} mm	APMX mm	DN mm	LH mm	OAL mm	α°	DCONMS _{±5} mm	ZEFP
4	0,5	8	3,8	12	54	45	6	4
4	1,0	8	3,8	12	54	45	6	4
4	0,5	10	3,8	37	75	45	6	4
4	1,0	10	3,8	37	75	45	6	4
5	0,5	9	4,8	16	54	45	6	4
5	1,0	9	4,8	16	54	45	6	4
5	1,5	9	4,8	16	54	45	6	4
5	0,5	12	4,8	37	75	45	6	4
5	1,0	12	4,8	37	75	45	6	4
5	1,5	12	4,8	37	75	45	6	4
6	0,5	10	5,6	16	54	45	6	4
6	1,0	10	5,6	16	54	45	6	4
6	1,5	10	5,6	16	54	45	6	4
6	2,0	10	5,6	16	54	45	6	4
6	0,5	12	5,6	62	100	45	6	4
6	1,0	12	5,6	62	100	45	6	4
6	1,5	12	5,6	62	100	45	6	4
6	2,0	12	5,6	62	100	45	6	4
7	0,5	11	6,6	20	58	45	8	4
7	1,0	11	6,6	20	58	45	8	4
7	1,5	11	6,6	20	58	45	8	4
7	2,0	11	6,6	20	58	45	8	4
7	0,5	14	6,6	62	100	45	8	4
7	1,0	14	6,6	62	100	45	8	4
7	1,5	14	6,6	62	100	45	8	4
7	2,0	14	6,6	62	100	45	8	4
8	0,5	12	7,6	20	58	45	8	4
8	1,0	12	7,6	20	58	45	8	4
8	1,5	12	7,6	20	58	45	8	4
8	2,0	12	7,6	20	58	45	8	4
8	0,5	14	7,6	62	100	45	8	4
8	1,0	14	7,6	62	100	45	8	4
8	1,5	14	7,6	62	100	45	8	4
8	2,0	14	7,6	62	100	45	8	4
10	0,5	14	9,6	24	66	45	10	4
10	1,0	14	9,6	24	66	45	10	4
10	1,5	14	9,6	24	66	45	10	4
10	2,0	14	9,6	24	66	45	10	4
10	3,0	14	9,6	24	66	45	10	4
10	0,5	18	9,6	58	100	45	10	4
10	1,0	18	9,6	58	100	45	10	4

50 911 ...	50 911 ...
040	
041	
	042
	043
050	
051	
052	
	053
	054
	055
060	
061	
062	
063	
	064
	065
	066
	067
070	
071	
072	
073	
	074
	075
	076
	077
080	
081	
086	
083	
	084
	085
	082
	087
100	
101	
107	
103	
104	
	105
	106

P	
M	
K	
N	•
S	
H	
O	•

Torus Cutter

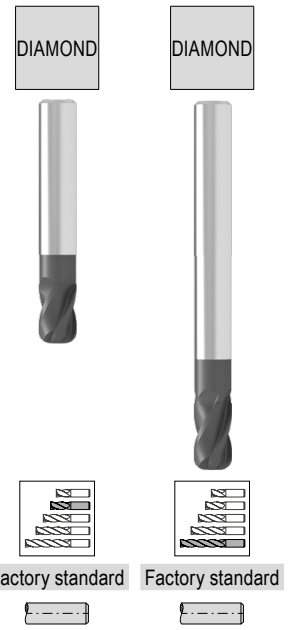
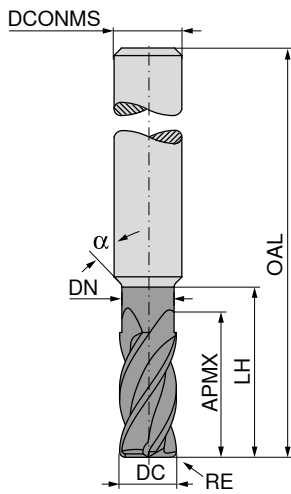
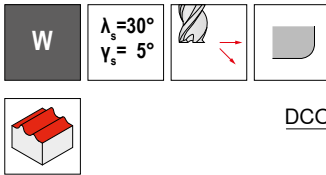

DC ₁₈	RE _{±0.05}	APMX	DN	LH	OAL	α°	DCONMS _{h5}	ZEFP
mm	mm	mm	mm	mm	mm		mm	
10	1,5	18	9,6	58	100	45	10	4
10	2,0	18	9,6	58	100	45	10	4
10	3,0	18	9,6	58	100	45	10	4
12	0,5	16	11,5	26	73	45	12	4
12	1,0	16	11,5	26	73	45	12	4
12	1,5	16	11,5	26	73	45	12	4
12	2,0	16	11,5	26	73	45	12	4
12	4,0	16	11,5	26	73	45	12	4
12	0,5	22	11,5	53	100	45	12	4
12	1,0	22	11,5	53	100	45	12	4
12	1,5	22	11,5	53	100	45	12	4
12	2,0	22	11,5	53	100	45	12	4
12	4,0	22	11,5	53	100	45	12	4

	50 911 ...	50 911 ...
P		
M		
K		
N	•	•
S		
H		
O	•	•

→ v_c/f_z Page 418

Torus Cutter

- ▲ Radius accuracy: $\pm 0,005$ mm
- ▲ for $\varnothing \leq 5.0$ mm, angle tolerance α and β : $\pm 0.5^\circ$

N
 $\lambda_s = 30^\circ$
 $\nu_s = 3^\circ$

 ≤ 56
HRC

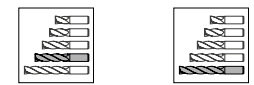
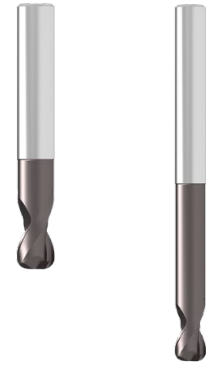
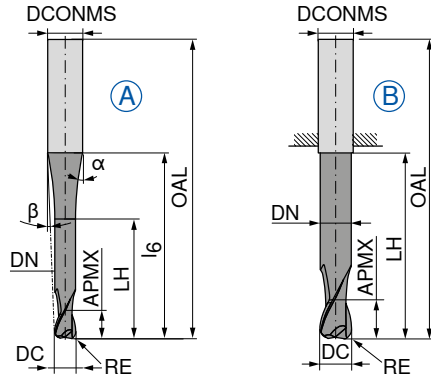

Factory standard Factory standard

DC $\pm 0,01$	RE $\pm 0,005$	APMX	DN	LH	l ₆	OAL	α°	β°	DCONMS _{h5}	ZEFP	Fig.
mm	mm	mm	mm	mm	mm	mm			mm		
0,5	0,10	1,0	0,45	2,0	20	57	10	8,5	6	2	A
1,0	0,25	2,0	0,95	4,0	20	57	10	8	6	2	A
1,0	0,25	2,0	0,95	4,0	40	80	4,5	4	6	2	A
1,5	0,30	2,5	1,40	7,5	20	57	12,5	7	6	2	A
1,5	0,30	2,5	1,40	7,5	40	80	4,5	3,5	6	2	A
2,0	0,50	3,0	1,80	8,0	20	57	12	6,5	6	2	A
2,0	0,50	3,0	1,80	8,0	40	80	4	3	6	2	A
3,0	0,50	3,5	2,80	10,0	20	57	11,5	5	6	2	A
3,0	0,50	3,5	2,80	12,0	40	80	3,5	2,5	6	2	A
4,0	0,50	4,0	3,80	12,0	20	57	11	3,5	6	2	A
4,0	0,50	4,0	3,80	20,0	40	80	4	1,5	6	2	A
4,0	1,00	4,0	3,80	12,0	20	57	11	3,5	6	2	A
4,0	1,00	4,0	3,80	20,0	40	80	4	1,5	6	2	A
5,0	1,00	5,0	4,70	14,0	20	57	10	2	6	2	A
5,0	1,00	5,0	4,70	25,0	40	80	3	1	6	2	A
5,0	1,50	5,0	4,70	14,0	20	57	10	2	6	2	A
5,0	1,50	5,0	4,70	25,0	40	80	3	1	6	2	A
6,0	1,00	6,0	5,60	20,0		57			6	2	B
6,0	1,00	6,0	5,60	40,0		80			6	2	B
6,0	2,00	6,0	5,60	20,0		57			6	2	B
6,0	2,00	6,0	5,60	40,0		80			6	2	B
6,0	2,00	6,0	5,60	25,0	60	100	2	1	8	2	A
8,0	1,00	7,0	7,60	25,0		63			8	2	B
8,0	1,00	7,0	7,60	60,0		100			8	2	B
8,0	2,00	7,0	7,60	25,0		63			8	2	B
8,0	2,00	7,0	7,60	60,0		100			8	2	B
8,0	2,00	7,0	7,60	30,0	75	120	2	1	10	2	A
8,0	2,50	7,0	7,60	60,0		100			8	2	B
10,0	1,50	8,0	9,60	30,0		72			10	2	B
10,0	1,50	8,0	9,60	75,0		120			10	2	B
10,0	2,50	8,0	9,60	75,0		120			10	2	B
10,0	3,00	8,0	9,60	30,0		72			10	2	B
10,0	3,00	8,0	9,60	50,0		100			10	2	B
10,0	3,00	8,0	9,60	75,0		120			10	2	B
10,0	3,00	8,0	9,60	40,0	110	160	1	0,5	12	2	A
12,0	1,50	10,0	11,50	35,0		83			12	2	B
12,0	1,50	10,0	11,50	70,0		160			12	2	B
12,0	4,00	10,0	11,50	35,0		83			12	2	B
12,0	4,00	10,0	11,50	35,0	40	92	37	3,5	16	2	A
12,0	4,00	10,0	11,50	70,0		160			12	2	B
12,0	4,00	10,0	11,50	50,0	150	200	1,5	1	16	2	A
16,0	5,00	12,0	15,50	40,0		92			16	2	B
16,0	5,00	12,0	15,50	80,0		200			16	2	B

52 730 ...	52 734 ...
005	
010	
015	010
020	015
030	020
041	030
040	041
040	040
051	051
050	050
961	050
060	961
060	060
082	061
080	082
080	080
102	080
100	081
100	083
100	102
100	104
100	103
100	100
122	101
120	120
121	121
160	120
	121
	160

P	●	●
M	○	○
K	●	●
N	○	○
S	○	○
H	○	○
O	○	○

Torus Cutter

H
 $\lambda_s = 30^\circ$
 $\nu_s = 3^\circ$

 ≤ 54
HRC

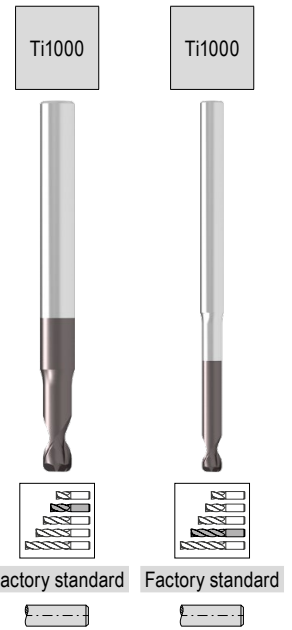
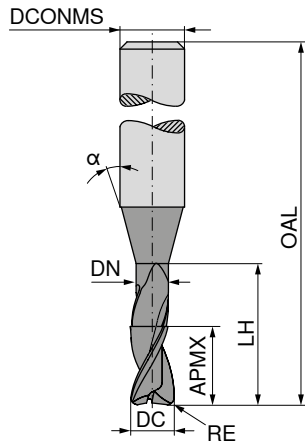

DC _{FB}	RE _{0.015}	APMX	DN	LH	OAL	α°	DCONMS ₁₅	ZEFP
mm	mm	mm	mm	mm	mm		mm	
0,4	0,04	0,4	0,37	1,2	55	15	6	2
0,4	0,04	0,4	0,37	2,0	55	15	6	2
0,4	0,04	0,4	0,37	3,2	55	15	6	2
0,4	0,04	0,4	0,45	4,0	55	15	6	2
0,5	0,05	0,5	0,45	1,5	55	15	6	2
0,5	0,05	0,5	0,45	2,5	55	15	6	2
0,5	0,05	0,5	0,45	4,0	55	15	6	2
0,5	0,05	0,5	0,45	5,0	55	15	6	2
0,6	0,06	0,6	0,58	2,0	55	15	6	2
0,6	0,06	0,6	0,58	3,0	55	15	6	2
0,6	0,06	0,6	0,58	5,0	65	15	6	2
0,6	0,06	0,6	0,58	6,0	65	15	6	2
0,8	0,08	0,8	0,77	2,5	55	15	6	2
0,8	0,08	0,8	0,77	4,0	55	15	6	2
0,8	0,08	0,8	0,77	6,5	65	15	6	2
0,8	0,08	0,8	0,77	8,0	65	15	6	2
1,0	0,10	1,0	0,95	3,0	55	15	6	2
1,0	0,10	1,0	0,95	5,0	55	15	6	2
1,0	0,10	1,0	0,95	8,0	65	15	6	2
1,0	0,10	1,0	0,95	10,0	65	15	6	2
1,0	0,10	1,0	0,95	12,0	65	15	6	2
1,2	0,12	1,2	1,15	3,0	55	15	6	2
1,2	0,12	1,2	1,15	6,0	55	15	6	2
1,2	0,12	1,2	1,15	10,0	65	15	6	2
1,2	0,12	1,2	1,15	12,0	65	15	6	2
1,3	0,13	1,3	1,25	4,0	55	15	6	2
1,3	0,13	1,3	1,25	7,0	55	15	6	2
1,3	0,13	1,3	1,25	11,0	65	15	6	2
1,3	0,13	1,3	1,25	13,0	65	15	6	2
1,5	0,15	1,5	1,44	5,0	55	15	6	2
1,5	0,15	1,5	1,44	7,5	55	15	6	2
1,5	0,15	1,5	1,44	12,0	65	15	6	2
1,5	0,15	1,5	1,44	15,0	65	15	6	2
1,6	0,16	1,6	1,52	5,0	55	15	6	2
1,6	0,16	1,6	1,52	8,0	55	15	6	2
1,6	0,16	1,6	1,52	13,0	65	15	6	2
1,6	0,16	1,6	1,52	16,0	65	15	6	2
1,8	0,18	1,8	1,72	5,5	55	15	6	2
1,8	0,18	1,8	1,72	9,0	55	15	6	2
1,8	0,18	1,8	1,72	14,5	65	15	6	2

P	●	●
M	○	○
K	●	●
N	○	○
S	○	○
H	○	○
O	○	○

50 649 ...	50 649 ...
041	
042	
043	
044	
051	
052	
053	
054	
061	
960	
961	063
081	
980	
981	083
101	
010	
	103
	011
	105
121	
012	
123	
	013
131	
132	
	133
	134
151	
015	
	153
	016
161	
162	
	163
	164
181	
182	
	183

Torus Cutter

H
 $\lambda_s = 30^\circ$
 $\nu_s = 3^\circ$

 ≤ 54
HRC

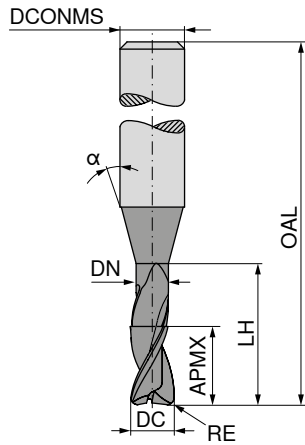

DC _{FB} mm	RE _{0.015} mm	APMX mm	DN mm	LH mm	OAL mm	α°	DCONMS ₁₅ mm	ZEFP
1,8	0,18	1,8	1,72	18,0	65	15	6	2
2,0	0,20	2,0	1,92	6,0	55	15	6	2
2,0	0,20	2,0	1,92	10,0	55	15	6	2
2,0	0,20	2,0	1,92	14,0	55	15	6	2
2,0	0,20	2,0	1,92	16,0	65	15	6	2
2,0	0,20	2,0	1,92	20,0	65	15	6	2
2,3	0,23	2,3	2,22	7,0	55	15	6	2
2,3	0,23	2,3	2,22	11,5	55	15	6	2
2,3	0,23	2,3	2,22	18,5	65	15	6	2
2,3	0,23	2,3	2,22	23,0	65	15	6	2
3,0	0,30	3,0	2,90	9,0	65	15	6	2
3,0	0,30	3,0	2,90	15,0	65	15	6	2
3,0	0,30	3,0	2,90	24,0	100	15	6	2
3,0	0,30	3,0	2,90	30,0	100	15	6	2
4,0	0,40	4,0	3,90	12,0	65	15	6	2
4,0	0,40	4,0	3,90	20,0	65	15	6	2
4,0	0,40	4,0	3,90	32,0	100	15	6	2
4,0	0,40	4,0	3,90	40,0	100	15	6	2
5,0	0,50	5,0	4,90	15,0	65	15	6	2
5,0	0,50	5,0	4,90	25,0	65	15	6	2
5,0	0,50	5,0	4,90	40,0	100	15	6	2
5,0	0,50	5,0	4,90	50,0	100	15	6	2
6,0	0,60	6,0	5,90	18,0	65	15	6	2
6,0	0,60	6,0	5,90	30,0	100	15	6	2
6,0	0,60	6,0	5,90	48,0	100	15	6	2
6,0	0,60	6,0	5,90	60,0	100	15	6	2

	50 649 ...	50 649 ...
P	●	●
M	○	○
K	●	●
N	○	○
S	○	○
H	○	○
O	○	○

→ v_c/f_z Page 480-486

Torus Cutter

H

$\lambda_s = 30^\circ$
 $\nu_s = 3^\circ$

≤ 68
HRC

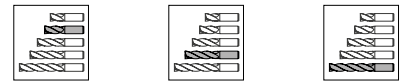
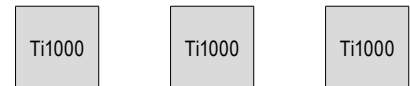
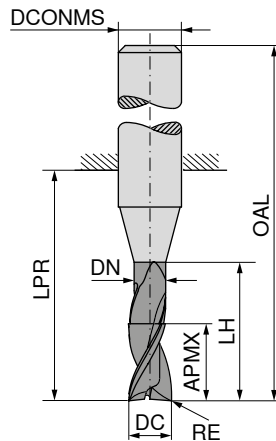

Factory standard Factory standard Factory standard

DC _{FB}	RE _{±0.05}	APMX	DN	LH	LPR	OAL	DCONMS _{±5}	ZEFP
mm	mm	mm	mm	mm	mm	mm	mm	
2	0,3	2	1,8	7	14	50	6	2
2	0,5	2	1,8	7	14	50	6	2
2	0,3	2	1,8	7	24	60	6	2
2	0,5	2	1,8	7	24	60	6	2
2	0,3	2	1,8	7	49	85	6	2
2	0,5	2	1,8	7	49	85	6	2
3	0,3	2	2,8	7	14	50	6	2
3	0,5	2	2,8	7	14	50	6	2
3	0,3	2	2,8	12	24	60	6	2
3	0,5	2	2,8	12	24	60	6	2
3	0,3	2	2,8	12	49	85	6	2
3	0,5	2	2,8	12	49	85	6	2
4	0,3	3	3,8	13	18	54	6	2
4	0,5	3	3,8	13	18	54	6	2
4	1,0	3	3,8	13	18	54	6	2
4	0,3	3	3,8	20	39	75	6	2
4	0,5	3	3,8	20	39	75	6	2
4	1,0	3	3,8	20	39	75	6	2
4	0,3	3	3,8	20	49	85	6	2
4	0,5	3	3,8	20	49	85	6	2
4	1,0	3	3,8	20	49	85	6	2
5	0,5	3	4,6	13	18	54	6	2
5	1,0	3	4,6	13	18	54	6	2
5	1,5	3	4,6	13	18	54	6	2
5	1,0	3	4,6	20	39	75	6	2
5	1,5	3	4,6	20	39	75	6	2
6	0,5	4	5,6	14	18	54	6	2
6	1,0	4	5,6	14	18	54	6	2
6	2,0	4	5,6	14	18	54	6	2
6	0,5	4	5,6	45	49	85	6	2
6	1,0	4	5,6	45	49	85	6	2
6	2,0	4	5,6	45	49	85	6	2
6	0,5	4	5,6	25	64	100	6	2
6	1,0	4	5,6	25	64	100	6	2
6	2,0	4	5,6	25	64	100	6	2
6	0,5	4	5,6	25	49	85	8	2
6	1,0	4	5,6	25	49	85	8	2
6	2,0	4	5,6	25	49	85	8	2
8	0,5	4	7,6	16	22	58	8	2
8	1,0	4	7,6	16	22	58	8	2

50 651 ...	50 651 ...	50 651 ...
020		
021		
	022	
	023	
		024
		025
030		
031		
	032	
	033	
		034
		035
040		
041		
042		
	043	
	044	
	045	
		046
		047
		048
050		
051		
052		
	053	
	054	
060		
061		
062		
	066	
	067	
	068	
		069
		070
		071
	063	
	064	
	065	
080		
081		

P	●	●	●
M	○	○	○
K	●	●	●
N	○	○	○
S	○	○	○
H	○	○	○
O	○	○	○

→ v_c/f_z Page 480-486

Torus Cutter

H

$\lambda_s = 30^\circ$
 $\nu_s = 3^\circ$

≤ 68
HRC

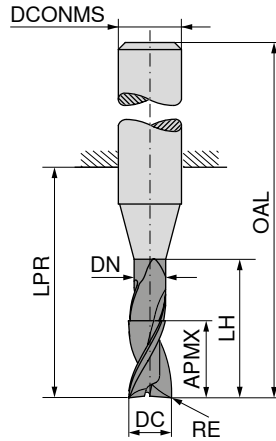

Ti1000 Ti1000 Ti1000

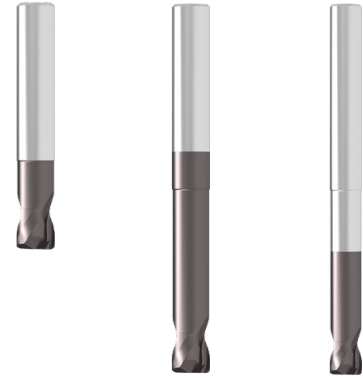

Factory standard Factory standard Factory standard



DC _{FB}	RE _{±0.05}	APMX	DN	LH	LPR	OAL	DCONMS _{±5}	ZEFP
mm	mm	mm	mm	mm	mm	mm	mm	
8	2,0	4	7,6	16	22	58	8	2
8	0,5	4	7,6	50	64	100	8	2
8	2,0	4	7,6	50	64	100	8	2
8	1,0	4	7,6	30	60	100	10	2
8	2,0	4	7,6	30	60	100	10	2
10	1,0	6	9,6	18	26	66	10	2
10	3,0	6	9,6	18	26	66	10	2
10	1,0	6	9,6	50	60	100	10	2
10	2,0	6	9,6	50	60	100	10	2
10	3,0	6	9,6	50	60	100	10	2
10	1,0	6	9,6	60	80	120	10	2
10	2,0	6	9,6	60	80	120	10	2
10	3,0	6	9,6	60	80	120	10	2
10	1,0	6	9,6	30	75	120	12	2
10	2,0	6	9,6	30	75	120	12	2
10	3,0	6	9,6	30	75	120	12	2
12	1,0	8	11,5	18	28	73	12	2
12	2,0	8	11,5	18	28	73	12	2
12	3,0	8	11,5	18	28	73	12	2
12	4,0	8	11,5	18	28	73	12	2
12	1,0	8	11,5	45	55	100	12	2
12	2,0	8	11,5	45	55	100	12	2
12	3,0	8	11,5	45	55	100	12	2
12	4,0	8	11,5	45	55	100	12	2
12	1,0	8	11,5	70	75	120	12	2
12	2,0	8	11,5	70	75	120	12	2
12	3,0	8	11,5	70	75	120	12	2
12	4,0	8	11,5	70	75	120	12	2
12	1,0	8	11,5	35	102	150	16	2
12	2,0	8	11,5	35	102	150	16	2
12	3,0	8	11,5	35	102	150	16	2
12	4,0	8	11,5	35	102	150	16	2

50 651 ...	50 651 ...	50 651 ...
082		
		083
		084
		085
		086
100		
101		
	102	
	103	
	104	
		105
		106
		107
		108
		109
		110
120		
121		
122		
123		
	124	
	125	
	126	
	127	
		128
		129
		130
		131
		132
		133
		134
		135

P	●	●	●
M	○	○	○
K	●	●	●
N	○	○	○
S	○	○	○
H	○	○	○
O	○	○	○

→ v_c/f_z Page 480–486

Torus Cutter

- ▲ Radius accuracy: $\pm 0,005$ mm
- ▲ High-performance tool for clearing
- ▲ for $\varnothing \leq 5.0$ mm, angle tolerance α and β : $\pm 0.5^\circ$

H

$\lambda_s = 0^\circ$
 $\gamma_s = -2^\circ$

≤ 66
HRC

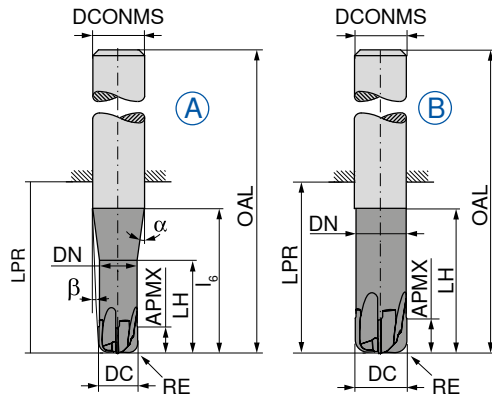

Ti1000



Factory standard



52 732 ...

DC $\pm 0,01$ mm	RE $\pm 0,005$ mm	APMX mm	DN mm	LH mm	l_6 mm	LPR mm	OAL mm	α°	β°	DCONMS n_5 mm	ZEFP	Fig.	
3	0,75	2,0	2,8	10	20	21	57	11,5	5	6	4	A	033
4	1,00	2,5	3,8	12	20	21	57	11	3,5	6	4	A	044
5	1,25	3,0	4,7	14	20	21	57	10	2	6	4	A	055
6	1,50	4,0	5,6	20		21	57			6	4	B	065
8	1,00	5,0	7,6	25		27	63			8	4	B	084
8	2,00	5,0	7,6	25		27	63			8	4	B	086
10	1,00	6,0	9,6	30		32	72			10	4	B	104
10	1,00	6,0	9,6	30		32	72			10	6	B	105
10	2,50	6,0	9,6	30		32	72			10	4	B	107
10	2,50	6,0	9,6	30		32	72			10	6	B	108
12	1,00	7,0	11,5	35		38	83			12	4	B	124
12	1,00	7,0	11,5	35		38	83			12	8	B	125
12	3,00	7,0	11,5	35		38	83			12	4	B	128
12	3,00	7,0	11,5	35		38	83			12	8	B	129
16	4,00	8,0	15,5	40		44	92			16	4	B	169

P	●
M	
K	○
N	
S	
H	●
O	

→ v_c/f_z Page 480–486

Intermediate Size Torus Cutter

▲ Reduced shank Ø for flexible application in various overhang lengths!

H

$\lambda_s = 45^\circ$
 $\gamma_s = 12^\circ$

≤ 56
HRC

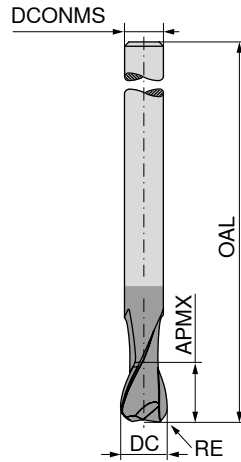

Ti1000



Factory standard



52 107 ...

DC _{e8} mm	RE _{±0.01} mm	APMX mm	OAL mm	DCONMS _{h6} mm	ZEFP
7	0,5	9	120	6	4
7	1,0	9	120	6	4
7	1,5	9	120	6	4
9	0,5	12	135	8	4
9	1,0	12	135	8	4
9	1,5	12	135	8	4
11	1,0	15	150	10	4
11	1,5	15	150	10	4
11	2,0	15	150	10	4
13	1,0	18	160	12	4
13	1,5	18	160	12	4
13	2,0	18	160	12	4
15	1,0	21	160	14	4
15	1,5	21	160	14	4
15	2,0	21	160	14	4
17	1,0	24	180	16	4
17	1,5	24	180	16	4
17	2,0	24	180	16	4
17	3,0	24	180	16	4

- 075
- 076
- 077
- 095
- 096
- 097
- 115
- 116
- 117
- 135
- 136
- 137
- 156
- 157
- 158
- 176
- 177
- 178
- 179

P	○
M	●
K	○
N	●
S	●
H	
O	●

→ v_c/f_z Page 480–486

Engraving cutter 60°

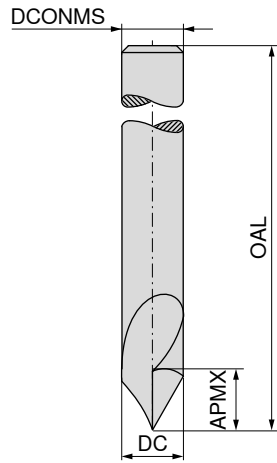
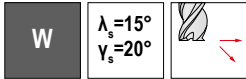

Factory standard



52 195 ...

DC _{h6} mm	APMX mm	OAL mm	DCONMS _{h6} mm	ZEFP
3	15	50	3	1
4	18	50	4	1
6	20	54	6	1

030
040
060

P	○
M	○
K	○
N	●
S	○
H	
O	●

→ v_c/f_z Page 480-483

NC deburring cutter

- ▲ 50 940 ... / 50 943 ... Point angle $\alpha = 60^\circ$
- ▲ 50 941 ... / 50 944 ... Point angle $\alpha = 90^\circ$
- ▲ 50 942 ... / 50 945 ... Point angle $\alpha = 120^\circ$

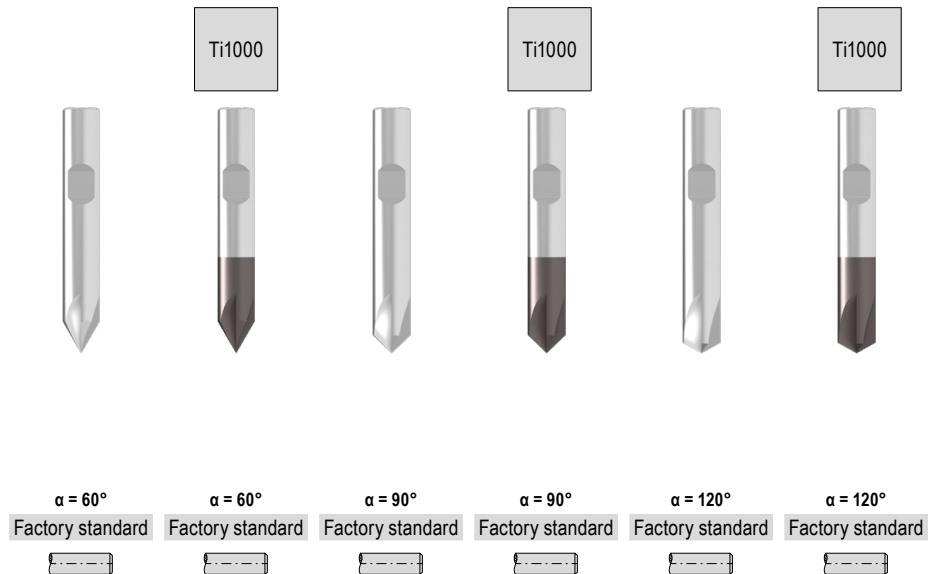
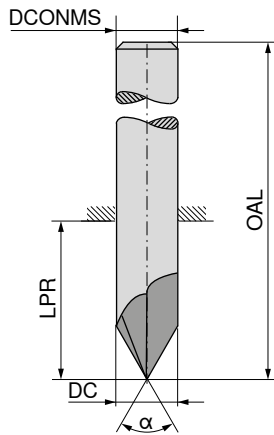
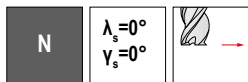

DC _{h6} mm	OAL mm	LPR mm	DCONMS _{h6} mm	ZEFP	$\alpha = 60^\circ$		$\alpha = 90^\circ$		$\alpha = 120^\circ$	
					50 940 ...	50 943 ...	50 941 ...	50 944 ...	50 942 ...	50 945 ...
4	54	26	4	4	040 ¹⁾	040 ¹⁾	040 ¹⁾	040 ¹⁾	040 ¹⁾	040 ¹⁾
6	54	18	6	4	060	060	060	060	060	060
8	58	22	8	4	080	080	080	080	080	080
10	66	26	10	4	100	100	100	100	100	100
12	73	28	12	4	120	120	120	120	120	120
P					●	●	●	●	●	●
M					○	○	○	○	○	○
K					●	●	●	●	●	●
N					○	○	○	○	○	○
S					○	○	○	○	○	○
H					○	○	○	○	○	○
O					●	●	●	●	●	●

1) DIN 6535 HA Shank

NC front and rear chamfer milling cutter

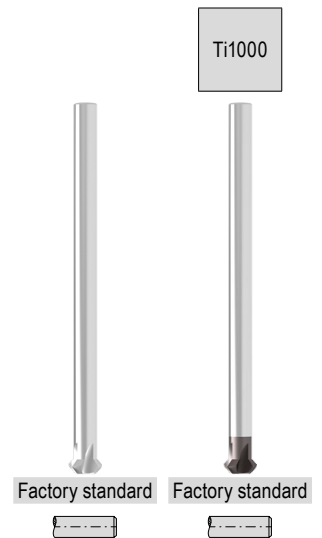
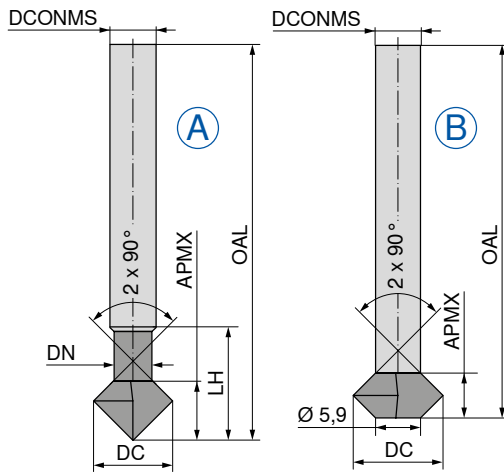
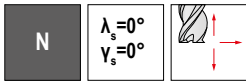

DC mm	APMX mm	DN mm	LH mm	OAL mm	DCONMS _{h5} mm	ZEFP	Fig.
3	2,0	2,2	12,0	75	4	4	A
4	2,7	2,9	17,7	75	4	4	A
5	3,0	3,9	18,0	75	5	4	A
6	4,0	3,9	19,0	100	6	4	A
8	2,0			100	6	4	B
10	4,0			100	6	4	B
12	6,0			100	6	4	B

52 158 ...	52 159 ...
030	030
040	040
050	050
060	060
080	080
100	100
120	120

P	●	●
M	○	○
K	●	●
N	○	○
S	○	○
H		○
O	●	●

→ v_c/f_z Page 480-483

Quarter-round profile milling cutter, concave

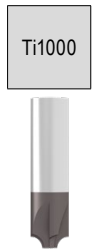
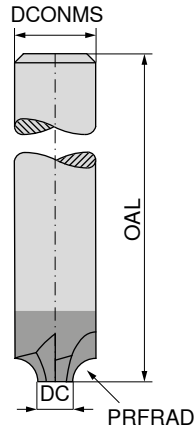
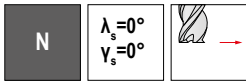

Factory standard



52 249 ...

PRFRAD ^{+/-0,02} mm	DC mm	OAL mm	DCONMS _{h6} mm	ZEFP	
0,50	7,0	70	8	4	005
1,00	6,0	70	8	4	010
1,25	7,5	75	10	4	012
1,50	7,0	75	10	4	015
2,00	6,0	75	10	4	020
2,50	7,0	73	12	4	025
3,00	6,0	73	12	4	030
3,50	9,0	80	16	4	035
4,00	8,0	80	16	4	040
4,50	7,0	80	16	4	045
5,00	10,0	80	20	4	050
6,00	8,0	80	20	4	060

P	●
M	○
K	●
N	○
S	○
H	○
O	●

→ v_c/f_z Page 480–483

T-slot milling cutters

- ▲ Solid carbide cutting head with soldered steel shank
- ▲ For slots according to DIN 650
- ▲ until the tool is fully in use, the feed rate fz must be reduced by 50%

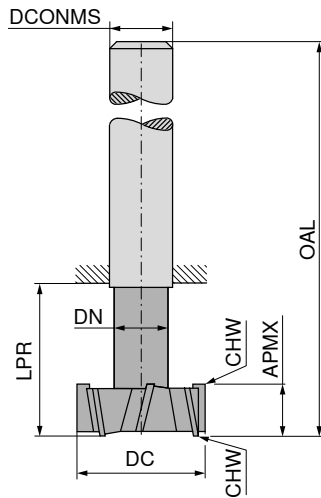

DIN 851 A



54 065 ...

DC _{e9} mm	APMX _{d11} mm	DN mm	LPR mm	OAL mm	DCONMS _{h6} mm	CHW mm	ZEPF	
11,0	4	4	13,5	53,5	10	0,10	6	11000
12,5	6	5	17,0	57,0	10	0,10	6	12500
16,0	8	7	22,0	62,0	10	0,20	6	16000
18,0	8	8	25,0	70,0	12	0,20	6	18000
19,0	9	8	26,0	71,0	12	0,20	6	19000
21,0	9	10	29,0	74,0	12	0,25	6	21000
22,0	10	10	30,0	75,0	12	0,25	6	22000
25,0	11	12	34,0	82,0	16	0,30	8	25000
28,0	12	13	37,0	85,0	16	0,30	8	28000
32,0	14	15	42,0	90,0	16	0,35	8	32000
36,0	16	17	47,0	103,0	25	0,40	8	36000
40,0	18	19	52,0	108,0	25	0,40	10	40000



P	●
M	○
K	●
N	●
S	●
H	●
O	●

→ v_c/f_z Page 455



Information on applications can be found in the Technical Information on → page 488.

Carbide burrs, similar to DIN 8033

 Teeth Z3: Application "medium"
 Teeth Z6: Application "medium"

 v_c in min = 300–600

KSJ

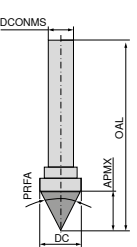
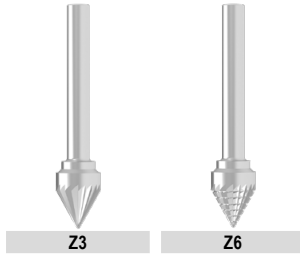
DC	APMX	OAL	DCONMS	PRFA	50 928 ...	50 928 ...
mm	mm	mm	mm			
6	5	52	6	60°	606	706
12	10	60	6	60°	612 ¹⁾	712 ¹⁾

1) Steel shank / carbide head – shank tolerance h9

KSK

DC	APMX	OAL	DCONMS	PRFA	50 927 ...	50 927 ...
mm	mm	mm	mm			
6	3	52	6	90°	606	706
12	6	56	6	90°	612 ¹⁾	712 ¹⁾

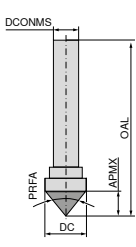
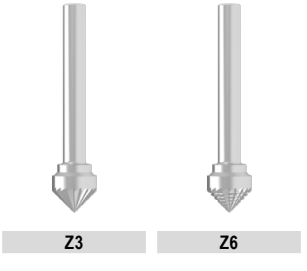
1) Steel shank / carbide head – shank tolerance h9

ZYA

DC	APMX	OAL	DCONMS	50 921 ...	50 921 ...
mm	mm	mm	mm		
3	13	40	3	303	403
6	13	48	3	306 ¹⁾	406 ¹⁾
6	16	55	6	606	706
8	20	65	6	608 ¹⁾	708 ¹⁾
10	20	65	6	610 ¹⁾	710 ¹⁾
12	25	70	6	612 ¹⁾	712 ²⁾

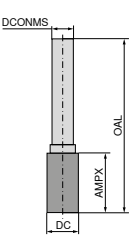
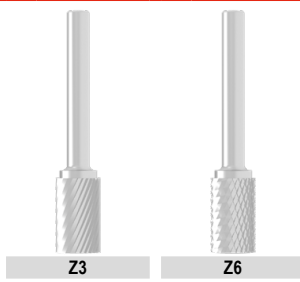
1) Steel shank / carbide head – shank tolerance h9
 2) Steel shank / carbide head – shank tolerance h7

WRC

DC	APMX	OAL	DCONMS	50 922 ...	50 922 ...
mm	mm	mm	mm		
3	13	40	3	303	403
6	13	48	3	306 ¹⁾	406 ¹⁾
6	16	50	6	606	706
8	18	63	6	608 ¹⁾	708 ¹⁾
10	20	65	6	610 ¹⁾	710 ¹⁾
12	25	70	6	612 ¹⁾	712 ¹⁾
16	25	70	6	616 ¹⁾	716 ¹⁾

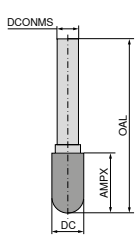
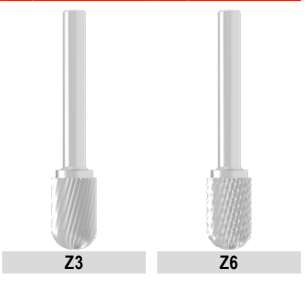
1) Steel shank / carbide head – shank tolerance h9

SKM

DC	APMX	OAL	DCONMS	PRFA	50 926 ...	50 926 ...
mm	mm	mm	mm			
3	14	40	3	9,5°	303	403
6	13	48	3	23,0°	306 ¹⁾	406 ¹⁾
6	18	50	6	16,0°	606	706
8	20	65	6	20,0°	608 ¹⁾	708 ¹⁾
10	20	65	6	25,0°	610 ¹⁾	710 ¹⁾
12	25	70	6	25,0°	612 ¹⁾	712 ¹⁾

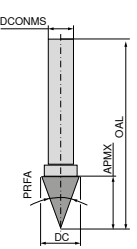
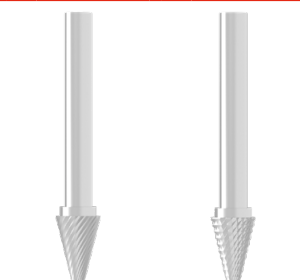
1) Steel shank / carbide head – shank tolerance h9

KEL

DC	APMX	OAL	DCONMS	PRFA	50 923 ...	50 923 ...
mm	mm	mm	mm			
3	14	40	3	6°	303	403
6	20	55	3	12°	306 ¹⁾	406 ¹⁾
6	20	50	6	10°	606	706
8	20	65	6	14°	608 ¹⁾	708 ¹⁾
10	20	65	6	14°	610 ¹⁾	710 ¹⁾
12	30	75	6	14°	612 ¹⁾	712 ¹⁾

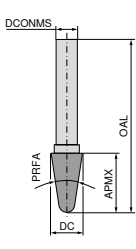
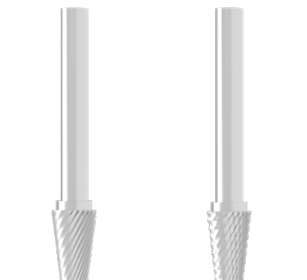
1) Steel shank / carbide head – shank tolerance h9

Carbide burrs, similar to DIN 8033

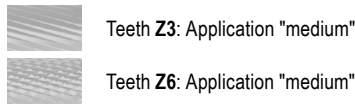

v_c in min = 300–600

SPG

Z3 Z6

50 925 ... 50 925 ...

DC mm	APMX mm	OAL mm	DCONMS mm		
3	13	40	3	303	403
6	13	48	3	306 ¹⁾	406 ¹⁾
6	18	50	6	606	706
8	20	65	6	608 ¹⁾	708 ¹⁾
10	20	65	6	610 ¹⁾	710 ¹⁾
12	25	70	6	612 ²⁾	712 ¹⁾

- 1) Steel shank / carbide head – shank tolerance h9
- 2) Steel shank / carbide head – shank tolerance h7

RBF

Z3 Z6

50 924 ... 50 924 ...

DC mm	APMX mm	OAL mm	DCONMS mm		
3	13	40	3	303	403
6	13	48	3	306 ¹⁾	406 ¹⁾
6	18	50	6	606	706
8	20	65	6	608 ¹⁾	708 ¹⁾
10	20	65	6	610 ¹⁾	710 ¹⁾
12	25	70	6	612 ¹⁾	712 ¹⁾
16	30	75	6	616 ¹⁾	716 ¹⁾

- 1) Steel shank / carbide head – shank tolerance h9

TRE

Z3 Z6

50 929 ... 50 929 ...

DC mm	APMX mm	OAL mm	DCONMS mm		
3	7	40	3	303	403
6	10	45	3	306 ¹⁾	406 ¹⁾
6	10	50	6	606	706
8	13	58	6	608 ¹⁾	708 ¹⁾
10	16	61	6	610 ¹⁾	710 ¹⁾
12	20	65	6	612 ¹⁾	712 ¹⁾

- 1) Steel shank / carbide head – shank tolerance h9

KUD

Z3 Z6

50 930 ... 50 930 ...

DC mm	APMX mm	OAL mm	DCONMS mm		
3	2,7	40,0	3	303	403
6	5,4	40,4	3	306 ¹⁾	406 ¹⁾
6	5,0	50,0	6	606	706
8	7,2	52,2	6	608 ¹⁾	708 ¹⁾
10	9,0	54,0	6	610 ¹⁾	710 ¹⁾
12	10,8	55,8	6	612 ¹⁾	712 ¹⁾
16	14,4	59,4	6	616 ¹⁾	716 ¹⁾

- 1) Steel shank / carbide head – shank tolerance h9

WKN

Z3 Z6

50 931 ... 50 931 ...

DC mm	APMX mm	OAL mm	DCONMS mm	PRFA		
3	7	40	3	10°	303	403
6	7	50	6	10°	606	706
12	13	58	6	20°	612 ¹⁾	712 ¹⁾

- 1) Steel shank / carbide head – shank tolerance h9

Solid carbide circular saw blades, fine-toothed, DIN 1837A

▲ fine-straight-cut

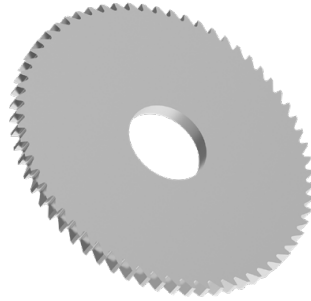
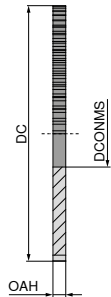
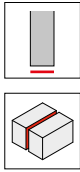

DIN 1837 A

54 700 ...

DC _{js15} mm	OAH _{±0.01} mm	DCONMS _{H6} mm	ZEPF	
15	0,20	5	64	102
15	0,25	5	64	103
15	0,30	5	64	104
15	0,35	5	64	105
15	0,40	5	64	106
15	0,50	5	48	107
15	0,60	5	48	108
15	0,70	5	48	109
15	0,80	5	40	110
15	0,90	5	40	111
15	1,00	5	40	112
15	1,10	5	40	113
15	1,20	5	40	114
15	1,30	5	40	115
15	1,40	5	40	116
15	1,50	5	40	117
15	1,60	5	40	118
15	1,70	5	40	119
15	1,80	5	40	120
15	1,90	5	40	121
15	2,00	5	40	122
15	2,50	5	40	123
15	3,00	5	40	124
15	3,50	5	40	125
15	4,00	5	40	126
15	4,50	5	40	127
15	5,00	5	40	128
15	5,50	5	40	129
15	6,00	5	40	130
20	0,20	5	80	152
20	0,25	5	64	153
20	0,30	5	64	154
20	0,35	5	64	155
20	0,40	5	64	156
20	0,50	5	48	157
20	0,60	5	48	158
20	0,70	5	48	159
20	0,80	5	48	160
20	0,90	5	40	161
20	1,00	5	40	162
20	1,10	5	40	163
20	1,20	5	40	164
20	1,30	5	40	165
20	1,40	5	40	166
20	1,50	5	40	167
20	1,60	5	40	168
20	1,70	5	40	169
20	1,80	5	32	170
20	1,90	5	32	171
20	2,00	5	32	172
20	2,50	5	32	173
20	3,00	5	32	174
20	3,50	5	24	175
20	4,00	5	24	176
20	4,50	5	24	177

54 700 ...

DC _{js15} mm	OAH _{±0.01} mm	DCONMS _{H6} mm	ZEPF	
20	5,00	5	24	178
20	5,50	5	24	179
20	6,00	5	24	180
25	0,20	8	80	202
25	0,25	8	80	203
25	0,30	8	80	204
25	0,35	8	64	205
25	0,40	8	64	206
25	0,50	8	64	207
25	0,60	8	64	208
25	0,70	8	48	209
25	0,80	8	48	210
25	0,90	8	48	211
25	1,00	8	48	212
25	1,10	8	48	213
25	1,20	8	48	214
25	1,30	8	40	215
25	1,40	8	40	216
25	1,50	8	40	217
25	1,60	8	40	218
25	1,70	8	40	219
25	1,80	8	40	220
25	1,90	8	40	221
25	2,00	8	40	222
25	2,50	8	40	223
25	3,00	8	32	224
25	3,50	8	32	225
25	4,00	8	32	226
25	4,50	8	32	227
25	5,00	8	32	228
25	5,50	8	24	229
25	6,00	8	24	230
30	0,20	8	100	252
30	0,25	8	100	253
30	0,30	8	80	254
30	0,35	8	80	255
30	0,40	8	80	256
30	0,50	8	80	257
30	0,60	8	64	258
30	0,70	8	64	259
30	0,80	8	64	260
30	0,90	8	64	261
30	1,00	8	64	262
30	1,10	8	64	263
30	1,20	8	48	264
30	1,30	8	48	265
30	1,40	8	48	266
30	1,50	8	48	267
30	1,60	8	48	268
30	1,70	8	48	269
30	1,80	8	48	270
30	1,90	8	48	271
30	2,00	8	48	272
30	2,50	8	40	273
30	3,00	8	40	274
30	3,50	8	40	275
30	4,00	8	40	276
30	4,50	8	32	277
30	5,00	8	32	278
30	5,50	8	32	279
30	6,00	8	32	280

P	●
M	●
K	●
N	●
S	●
H	
O	●

→ v_c/f_z Page 469

Solid carbide circular saw blades, fine-toothed, DIN 1837A

▲ fine-straight-cut

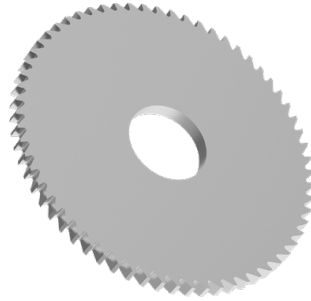
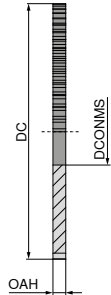
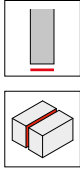

DIN 1837 A

54 700 ...

DC _{js15} mm	OAH _{±0.01} mm	DCONMS _{H6} mm	ZEFP	
40	0,20	10	128	302
40	0,25	10	100	303
40	0,30	10	100	304
40	0,35	10	100	305
40	0,40	10	100	306
40	0,50	10	80	307
40	0,60	10	80	308
40	0,70	10	80	309
40	0,80	10	80	310
40	0,90	10	64	311
40	1,00	10	64	312
40	1,10	10	64	313
40	1,20	10	64	314
40	1,30	10	64	315
40	1,40	10	64	316
40	1,50	10	64	317
40	1,60	10	64	318
40	1,70	10	48	319
40	1,80	10	48	320
40	1,90	10	48	321
40	2,00	10	48	322
40	2,50	10	48	323
40	3,00	10	48	324
40	3,50	10	48	325
40	4,00	10	40	326
40	4,50	10	40	327
40	5,00	10	40	328
40	5,50	10	40	329
40	6,00	10	40	330
50	0,20	13	128	352
50	0,25	13	128	353
50	0,30	13	128	354
50	0,35	13	100	355
50	0,40	13	100	356
50	0,50	13	100	357
50	0,60	13	100	358
50	0,70	13	80	359
50	0,80	13	80	360
50	0,90	13	80	361
50	1,00	13	80	362
50	1,10	13	80	363
50	1,20	13	80	364
50	1,30	13	64	365
50	1,40	13	64	366
50	1,50	13	64	367
50	1,60	13	64	368
50	1,70	13	64	369
50	1,80	13	64	370
50	1,90	13	64	371
50	2,00	13	64	372
50	2,50	13	64	373
50	3,00	13	48	374
50	3,50	13	48	375
50	4,00	13	48	376
50	4,50	13	48	377

54 700 ...

DC _{js15} mm	OAH _{±0.01} mm	DCONMS _{H6} mm	ZEFP	
50	5,00	13	48	378
50	5,50	13	40	379
50	6,00	13	40	380
63	0,20	16	160	402
63	0,25	16	160	403
63	0,30	16	128	404
63	0,35	16	128	405
63	0,40	16	128	406
63	0,50	16	128	407
63	0,60	16	100	408
63	0,70	16	100	409
63	0,80	16	100	410
63	0,90	16	100	411
63	1,00	16	100	412
63	1,10	16	80	413
63	1,20	16	80	414
63	1,30	16	80	415
63	1,40	16	80	416
63	1,50	16	80	417
63	1,60	16	80	418
63	1,70	16	80	419
63	1,80	16	80	420
63	1,90	16	80	421
63	2,00	16	80	422
63	2,50	16	64	423
63	3,00	16	64	424
63	3,50	16	64	425
63	4,00	16	64	426
63	4,50	16	64	427
63	5,00	16	48	428
63	5,50	16	48	429
80	0,30	22	160	45400
80	0,35	22	160	45500
80	0,40	22	160	45600
80	0,50	22	128	45700
80	0,60	22	128	45800
80	0,70	22	128	45900
80	0,80	22	128	46000
80	0,90	22	100	46100
80	1,00	22	100	46200
80	1,10	22	100	46300
80	1,20	22	100	46400
80	1,30	22	100	46500
80	1,40	22	100	46600
80	1,50	22	100	46700
80	1,60	22	100	46800
80	1,70	22	80	46900
80	1,80	22	80	47000
80	1,90	22	80	47100
80	2,00	22	80	47200
80	2,50	22	80	47300
80	3,00	22	80	47400
80	3,50	22	64	47500
80	4,00	22	64	47600
80	4,50	22	64	47700
80	5,00	22	64	47800
80	5,50	22	64	47900
80	6,00	22	64	48000

P	●
M	●
K	●
N	●
S	●
H	
O	●

→ v_c/f_z Page 469

Solid carbide circular saw blades, fine-toothed, DIN 1837A

▲ fine-straight-cut

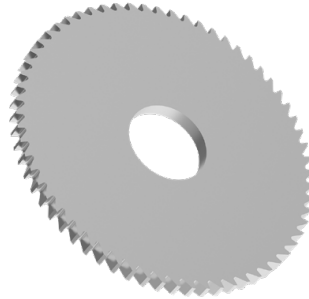
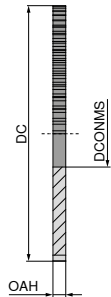

54 700 ...

DC _{js15} mm	OAH _{±0.01} mm	DCONMS _{H6} mm	ZEFP	
200	1,5	32	160	71700
200	1,6	32	160	71800
200	2,0	32	160	72200
200	2,5	32	160	72300
200	3,0	32	128	72400
200	4,0	32	128	72600

P	●
M	●
K	●
N	●
S	●
H	●
O	●

→ v_c/f_z Page 469

DIN 1837 A

54 700 ...

DC _{js15} mm	OAH _{±0.01} mm	DCONMS _{H6} mm	ZEFP	
100	0,5	22	160	50700
100	0,6	22	160	50800
100	0,7	22	128	50900
100	0,8	22	128	51000
100	0,9	22	128	51100
100	1,0	22	128	51200
100	1,1	22	128	51300
100	1,2	22	128	51400
100	1,3	22	100	51500
100	1,4	22	100	51600
100	1,5	22	100	51700
100	1,6	22	100	51800
100	1,7	22	100	51900
100	1,8	22	100	52000
100	1,9	22	100	52100
100	2,0	22	100	52200
100	2,5	22	100	52300
100	3,0	22	80	52400
100	3,5	22	80	52500
100	4,0	22	80	52600
100	4,5	22	80	52700
100	5,0	22	80	52800
100	5,5	22	64	52900
100	6,0	22	64	53000
125	0,6	22	160	55800
125	0,7	22	160	55900
125	0,8	22	160	56000
125	0,9	22	160	56100
125	1,0	22	160	56200
125	1,1	22	128	56300
125	1,2	22	128	56400
125	1,3	22	128	56500
125	1,4	22	128	56600
125	1,5	22	128	56700
125	1,6	22	128	56800
125	1,7	22	128	56900
125	1,8	22	128	57000
125	1,9	22	128	57100
125	2,0	22	128	57200
125	2,5	22	100	57300
125	3,0	22	100	57400
125	3,5	22	100	57500
125	4,0	22	100	57600
125	4,5	22	100	57700
125	5,0	22	80	57800
125	5,5	22	80	57900
125	6,0	22	80	58000
160	1,0	32	160	66200
160	1,2	32	160	66400
160	1,5	32	160	66700
160	1,6	32	160	66800
160	2,0	32	128	67200
160	2,5	32	128	67300
160	3,0	32	128	67400
160	4,0	32	128	67600

Solid carbide circular saw blades, coarse-toothed, DIN 1838B

▲ coarse straight-cut

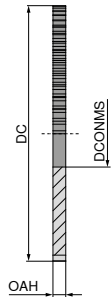
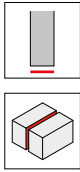

DIN 1838 B

54 701 ...

DC _{js15} mm	OAH _{±0.01} mm	DCONMS _{H6} mm	ZEPF	
15	0,20	5	20	10200
15	0,25	5	20	10300
15	0,30	5	20	10400
15	0,35	5	20	10500
15	0,40	5	20	10600
15	0,50	5	20	10700
15	0,60	5	20	10800
15	0,70	5	20	10900
15	0,80	5	20	11000
15	0,90	5	20	11100
15	1,00	5	20	11200
15	1,10	5	20	11300
15	1,20	5	20	11400
15	1,30	5	20	11500
15	1,40	5	20	11600
15	1,50	5	20	11700
15	1,60	5	20	11800
15	1,70	5	20	11900
15	1,80	5	20	12000
15	1,90	5	20	12100
15	2,00	5	20	12200
15	2,50	5	20	12300
15	3,00	5	20	12400
15	3,50	5	20	12500
15	4,00	5	20	12600
15	4,50	5	20	12700
15	5,00	5	20	12800
15	5,50	5	20	12900
15	6,00	5	20	13000
20	0,20	5	20	15200
20	0,25	5	20	15300
20	0,30	5	20	15400
20	0,35	5	20	15500
20	0,40	5	20	15600
20	0,50	5	20	15700
20	0,60	5	20	15800
20	0,70	5	20	15900
20	0,80	5	20	16000
20	0,90	5	20	16100
20	1,00	5	20	16200
20	1,10	5	20	16300
20	1,20	5	20	16400
20	1,30	5	20	16500
20	1,40	5	20	16600
20	1,50	5	20	16700
20	1,60	5	20	16800
20	1,70	5	20	16900
20	1,80	5	20	17000
20	1,90	5	20	17100
20	2,00	5	20	17200
20	2,50	5	20	17300
20	3,00	5	20	17400
20	3,50	5	20	17500
20	4,00	5	20	17600
20	4,50	5	20	17700

54 701 ...

DC _{js15} mm	OAH _{±0.01} mm	DCONMS _{H6} mm	ZEPF	
20	5,00	5	20	17800
20	5,50	5	20	17900
20	6,00	5	20	18000
25	0,20	8	20	20200
25	0,25	8	20	20300
25	0,30	8	20	20400
25	0,35	8	20	20500
25	0,40	8	20	20600
25	0,50	8	20	20700
25	0,60	8	20	20800
25	0,70	8	20	20900
25	0,80	8	20	21000
25	0,90	8	20	21100
25	1,00	8	20	21200
25	1,10	8	20	21300
25	1,20	8	20	21400
25	1,30	8	20	21500
25	1,40	8	20	21600
25	1,50	8	20	21700
25	1,60	8	20	21800
25	1,70	8	20	21900
25	1,80	8	20	22000
25	1,90	8	20	22100
25	2,00	8	20	22200
25	2,50	8	20	22300
25	3,00	8	20	22400
25	3,50	8	20	22500
25	4,00	8	20	22600
25	4,50	8	20	22700
25	5,00	8	20	22800
25	5,50	8	20	22900
25	6,00	8	20	23000
30	0,20	8	30	25200
30	0,25	8	30	25300
30	0,30	8	30	25400
30	0,35	8	30	25500
30	0,40	8	30	25600
30	0,50	8	30	25700
30	0,60	8	30	25800
30	0,70	8	30	25900
30	0,80	8	24	26000
30	0,90	8	24	26100
30	1,00	8	24	26200
30	1,10	8	24	26300
30	1,20	8	24	26400
30	1,30	8	24	26500
30	1,40	8	24	26600
30	1,50	8	24	26700
30	1,60	8	24	26800
30	1,70	8	24	26900
30	1,80	8	24	27000
30	1,90	8	24	27100
30	2,00	8	24	27200
30	2,50	8	24	27300
30	3,00	8	24	27400
30	3,50	8	24	27500
30	4,00	8	24	27600
30	4,50	8	24	27700
30	5,00	8	24	27800
30	5,50	8	24	27900
30	6,00	8	24	28000

P	●
M	●
K	●
N	●
S	●
H	
O	●

→ v./f_z Page 469

Solid carbide circular saw blades, coarse-toothed, DIN 1838B

▲ coarse straight-cut

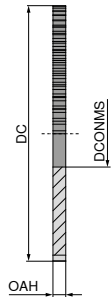
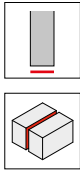

DIN 1838 B

54 701 ...

DC _{js15} mm	OAH _{±0.01} mm	DCONMS _{H6} mm	ZEFP	
40	0,20	10	40	30200
40	0,25	10	40	30300
40	0,30	10	40	30400
40	0,35	10	40	30500
40	0,40	10	40	30600
40	0,50	10	40	30700
40	0,60	10	40	30800
40	0,70	10	40	30900
40	0,80	10	32	31000
40	0,90	10	32	31100
40	1,00	10	32	31200
40	1,10	10	32	31300
40	1,20	10	32	31400
40	1,30	10	32	31500
40	1,40	10	32	31600
40	1,50	10	32	31700
40	1,60	10	32	31800
40	1,70	10	32	31900
40	1,80	10	32	32000
40	1,90	10	32	32100
40	2,00	10	32	32200
40	2,50	10	32	32300
40	3,00	10	32	32400
40	3,50	10	32	32500
40	4,00	10	32	32600
40	4,50	10	32	32700
40	5,00	10	32	32800
40	5,50	10	32	32900
40	6,00	10	32	33000
50	0,20	13	48	35200
50	0,25	13	48	35300
50	0,30	13	48	35400
50	0,35	13	48	35500
50	0,40	13	48	35600
50	0,50	13	48	35700
50	0,60	13	48	35800
50	0,70	13	40	35900
50	0,80	13	40	36000
50	0,90	13	40	36100
50	1,00	13	40	36200
50	1,10	13	40	36300
50	1,20	13	40	36400
50	1,30	13	32	36500
50	1,40	13	32	36600
50	1,50	13	32	36700
50	1,60	13	32	36800
50	1,70	13	32	36900
50	1,80	13	32	37000
50	1,90	13	32	37100
50	2,00	13	32	37200
50	2,50	13	32	37300
50	3,00	13	24	37400
50	3,50	13	24	37500
50	4,00	13	24	37600
50	4,50	13	24	37700

54 701 ...

DC _{js15} mm	OAH _{±0.01} mm	DCONMS _{H6} mm	ZEFP	
50	5,00	13	24	37800
50	5,50	13	20	37900
50	6,00	13	20	38000
63	0,30	16	64	40400
63	0,35	16	64	40500
63	0,40	16	64	40600
63	0,50	16	64	40700
63	0,60	16	48	40800
63	0,70	16	48	40900
63	0,80	16	48	41000
63	0,90	16	48	41100
63	1,00	16	48	41200
63	1,10	16	40	41300
63	1,20	16	40	41400
63	1,30	16	40	41500
63	1,40	16	40	41600
63	1,50	16	40	41700
63	1,60	16	40	41800
63	1,70	16	40	41900
63	1,80	16	40	42000
63	1,90	16	40	42100
63	2,00	16	40	42200
63	2,50	16	32	42300
63	3,00	16	32	42400
63	3,50	16	32	42500
63	4,00	16	32	42600
63	4,50	16	32	42700
63	5,00	16	24	42800
63	5,50	16	24	42900
63	6,00	16	24	43000
80	0,30	22	64	45400
80	0,35	22	64	45500
80	0,40	22	64	45600
80	0,50	22	64	45700
80	0,60	22	64	45800
80	0,70	22	64	45900
80	0,80	22	64	46000
80	0,90	22	48	46100
80	1,00	22	48	46200
80	1,10	22	48	46300
80	1,20	22	48	46400
80	1,30	22	48	46500
80	1,40	22	48	46600
80	1,50	22	48	46700
80	1,60	22	48	46800
80	1,70	22	40	46900
80	1,80	22	40	47000
80	1,90	22	40	47100
80	2,00	22	40	47200
80	2,50	22	40	47300
80	3,00	22	40	47400
80	3,50	22	32	47500
80	4,00	22	32	47600
80	4,50	22	32	47700
80	5,00	22	32	47800
80	5,50	22	32	47900
80	6,00	22	32	48000

P	●
M	●
K	●
N	●
S	●
H	●
O	●

→ v_c/f_z Page 469

Solid carbide circular saw blades, coarse-toothed, DIN 1838B

▲ coarse straight-cut

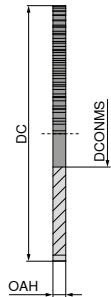
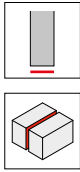

54 701 ...

DC _{js15} mm	OAH _{±0.01} mm	DCONMS _{H6} mm	ZEFP	
200	1,5	32	80	71700
200	1,6	32	80	71800
200	2,0	32	80	72200
200	2,5	32	80	72300
200	3,0	32	64	72400
200	4,0	32	64	72600

P	●
M	●
K	●
N	●
S	●
H	●
O	●

→ v_c/f_z Page 469

DIN 1838 B

54 701 ...

DC _{js15} mm	OAH _{±0.01} mm	DCONMS _{H6} mm	ZEFP	
100	0,5	22	80	50700
100	0,6	22	80	50800
100	0,7	22	80	50900
100	0,8	22	64	51000
100	0,9	22	64	51100
100	1,0	22	64	51200
100	1,1	22	64	51300
100	1,2	22	64	51400
100	1,3	22	48	51500
100	1,4	22	48	51600
100	1,5	22	48	51700
100	1,6	22	48	51800
100	1,7	22	48	51900
100	1,8	22	48	52000
100	1,9	22	48	52100
100	2,0	22	48	52200
100	2,5	22	48	52300
100	3,0	22	40	52400
100	3,5	22	40	52500
100	4,0	22	40	52600
100	4,5	22	40	52700
100	5,0	22	40	52800
100	5,5	22	32	52900
100	6,0	22	32	53000
125	0,6	22	80	55800
125	0,7	22	80	55900
125	0,8	22	80	56000
125	0,9	22	80	56100
125	1,0	22	80	56200
125	1,1	22	64	56300
125	1,2	22	64	56400
125	1,3	22	64	56500
125	1,4	22	64	56600
125	1,5	22	64	56700
125	1,6	22	64	56800
125	1,7	22	64	56900
125	1,8	22	64	57000
125	1,9	22	64	57100
125	2,0	22	64	57200
125	2,5	22	48	57300
125	3,0	22	48	57400
125	3,5	22	48	57500
125	4,0	22	48	57600
125	4,5	22	40	57700
125	5,0	22	40	57800
125	5,5	22	40	57900
125	6,0	22	40	58000
160	1,0	32	80	66200
160	1,2	32	80	66400
160	1,5	32	80	66700
160	1,6	32	80	66800
160	2,0	32	64	67200
160	2,5	32	64	67300
160	3,0	32	64	67400
160	4,0	32	48	67600

Cylindrical shank adapter for circular saw blades

▲ DCONWS = circular saw blade bore diameter

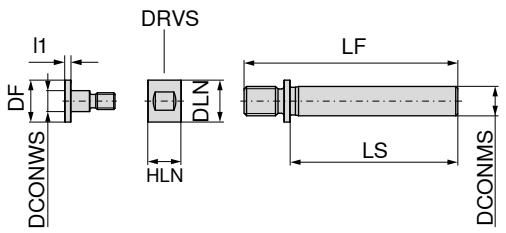

DCONWS _{H7} mm	DCONMS _{H7} mm	DLN mm	DF mm	LF mm	LS mm	HLN mm	I ₁ mm	DRVS mm	72 900 ...
5	7	10	10	51	40	8	3	9	005
5	10	10	10	61	50	8	3	9	105
8	7	15	15	51	40	8	3	14	008
8	10	15	15	61	50	8	3	14	108
10	7	17	17	53	40	10	3	16	010
10	10	17	17	63	50	10	3	16	110
10	16	17	17	74	55	10	3	16	210
13	10	20	20	66	50	10	3	18	113
13	16	20	20	77	55	10	3	18	213
16	10	24	24	66	50	14	3	22	116
16	16	24	24	79	55	14	3	22	216

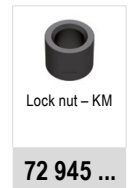
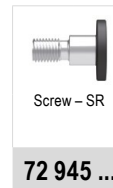

**Spare parts
for Article no.**

72 900 005	000	005
72 900 105	000	005
72 900 008	001	006
72 900 108	001	006
72 900 010	002	007
72 900 110	002	007
72 900 210	010	012
72 900 113	003	008
72 900 213	003	008
72 900 116	004	009
72 900 216	011	013

Application data for plastics cutters

Material	Strength N/mm ² – HB	50 983 ...	50 984 ...	50 985 ...	50 986 ...	50 992 ...	50 937 ...	50 936 ...	50 938 ...	50 610 ...	50 611 ...	50 946 ...	50 948 ...	50 947 ...
Aluminium (non alloyed, low alloyed)	< 350 N/mm ²									●				
Aluminium	< 500 N/mm ²									●				
Aluminium alloy 0,5–10% Si	< 400 N/mm ²									●				
Aluminium alloy 10 - 15% Si	< 400 N/mm ²								●			●	●	●
Aluminium	< 400 N/mm ²								●			●	●	
Copper (non alloyed, low alloyed)	< 350 N/mm ²									●				
Copper wrought alloys	< 700 N/mm ²								●			●	●	●
Special copper alloys	< 200 HB								●			●	●	●
Special copper alloys	< 300 HB								●			●	●	●
Special copper alloys	< 300 HB								●			●	●	●
Short-chipping brass, bronze, red bronze	< 600 N/mm ²									●				
Long-chipping brass	< 600 N/mm ²									●				
Magnesium and Magnesium Alloys	< 850 N/mm ²								●			●	●	●
Tungsten and tungsten alloys													●	●
Molybdenum and molybdenum alloys													●	●
Thermoplastics										●				
Duroplastics			●		●	●				●				
Fibre-reinforced plastics			●		●	●	●	●	●			●	●	●
Graphite			●		●	●	●	●	●			●		●

Machining direction



Tips

- ①



▲ Very sharp cutting edges for GFK and CFK and to prevent delamination of the component.
- ②



▲ For excellent tool life when machining AFK, CFK and Graphite.
- ③



▲ Specialist for machining honeycomb materials; Milling of pockets not fully through the workpiece.
- ④



▲ Specialist for machining honeycomb materials.
- ⑤



▲ Milling of recesses that pass through the material, the lower deck is pushed and upper deck pulled therefore the workpiece material is stabilized.
- ⑥



▲ For machining non fibre-reinforced plastics and non-ferrous metals with low silicon content. (PE, PA, PVC, acrylic glass)
- ⑦



▲ For machining fibre-reinforced plastics and non-ferrous metals with high silicon content.
- ⑧



▲ For machining fibre-reinforced plastics and non-ferrous metals with high silicon content.
- ⑨



▲ For machining fibre-reinforced plastics and non-ferrous metals with high silicon content.

Cutter for plastics

- ▲ right hand cutting
- ▲ cross-pitched
- ▲ Downward chip evacuation
- ▲ 50 983 ... = fine pitch
- ▲ 50 984 ... = medium pitch

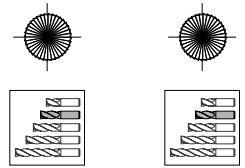
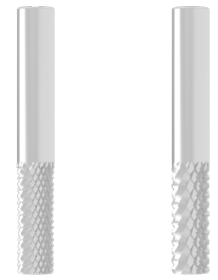
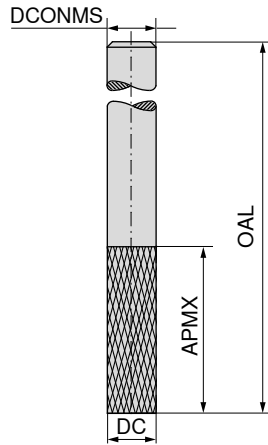

Factory standard Factory standard

DC _{h10} mm	APMX mm	OAL mm	DCONMS _{h6} mm
2,0	7	40	2,0
2,0	7	50	6,0
3,0	10	40	3,0
3,0	12	50	6,0
3,5	12	40	3,5
4,0	15	40	4,0
4,0	20	50	6,0
4,5	15	50	4,5
5,0	16	50	5,0
5,0	25	75	6,0
6,0	18	50	6,0
6,0	35	75	6,0
7,0	22	60	7,0
8,0	25	63	8,0
8,0	40	100	8,0
9,0	25	63	9,0
10,0	30	72	10,0
12,0	32	83	12,0
14,0	32	83	14,0
16,0	36	92	16,0
18,0	40	92	18,0
20,0	45	104	20,0

50 983 ...	50 984 ...
020	020
021	021
030	030
031	031
035	035
040	040
041	041
045	045
050	050
051	051
060	060
061	061
070	070
080	080
081	081
090	090
100	100
120	120
140	140
160	160
180	180
200	200

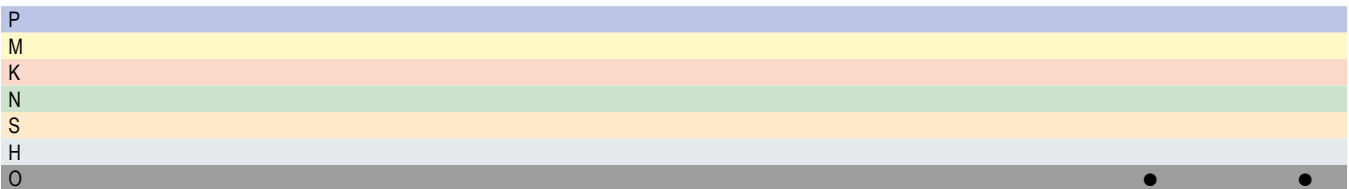

→ v_c/f_z Page 418

Cutter for plastics

- ▲ right hand cutting
- ▲ cross-pitched
- ▲ Downward chip evacuation
- ▲ 50 985 ... = fine pitch
- ▲ 50 986 ... = medium pitch

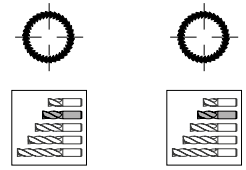
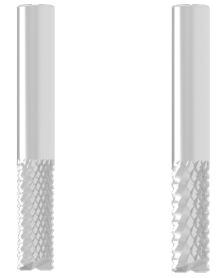
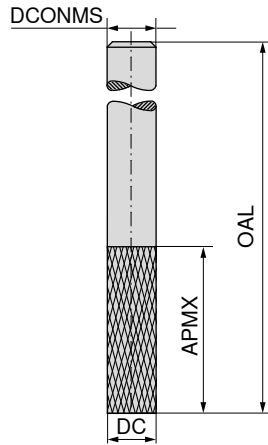

Factory standard Factory standard

DC _{h10}	APMX	OAL	DCONMS _{h6}
mm	mm	mm	mm
2,0	7	40	2,0
2,0	7	50	6,0
3,0	10	40	3,0
3,0	12	50	6,0
3,5	12	40	3,5
4,0	15	40	4,0
4,0	20	50	6,0
4,5	15	50	4,5
5,0	16	50	5,0
5,0	25	75	6,0
6,0	18	50	6,0
6,0	35	75	6,0
7,0	22	60	7,0
8,0	25	63	8,0
8,0	40	100	8,0
9,0	25	63	9,0
10,0	30	72	10,0
12,0	32	83	12,0
14,0	32	83	14,0
16,0	36	92	16,0
18,0	40	92	18,0
20,0	45	104	20,0

50 985 ...	50 986 ...
020	020
021	021
030	030
031	031
035	035
040	040
041	041
045	045
050	050
051	051
060	060
061	061
070	070
080	080
081	081
090	090
100	100
120	120
140	140
160	160
180	180
200	200

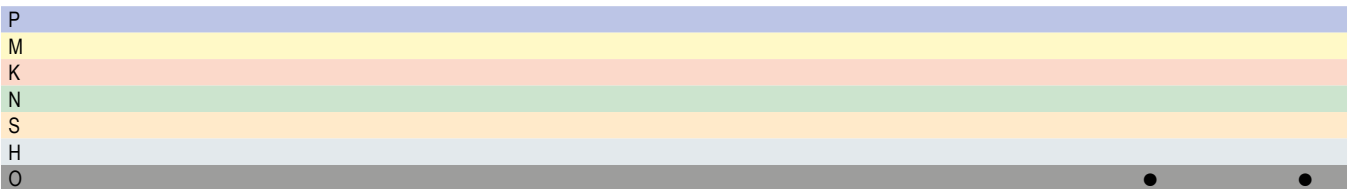

Ball nosed cutter for plastics

- ▲ right hand cutting
- ▲ cross-pitched

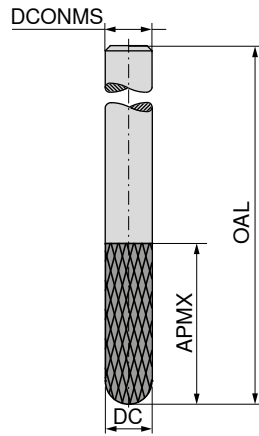

DIAMOND



Factory standard



50 932 ...

DC _{h10} mm	APMX mm	OAL mm	DCONMS _{h6} mm
2	7	40	2
2	7	50	6
3	10	40	3
3	12	50	6
4	15	40	4
4	20	50	6
5	16	50	5
5	25	75	6
6	18	50	6
6	35	75	6
8	25	63	8
8	40	100	8
10	30	72	10
12	32	83	12
16	36	92	16
20	40	104	20

- 020
- 022
- 030
- 032
- 040
- 042
- 050
- 052
- 060
- 062
- 080
- 082
- 100
- 120
- 160
- 200

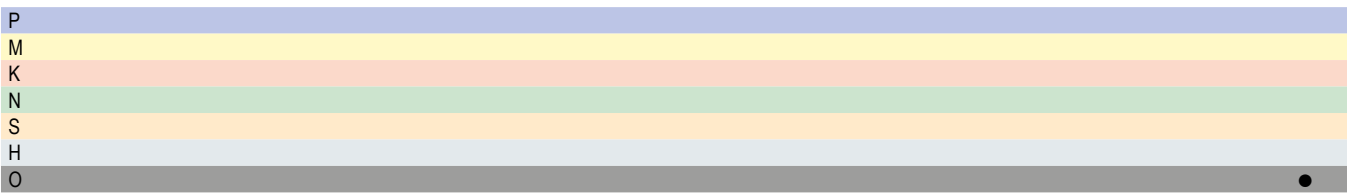

Cutter for plastics

- ▲ right hand cutting
- ▲ cross-pitched

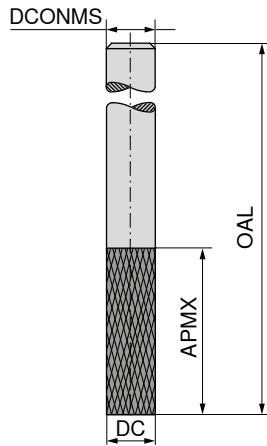
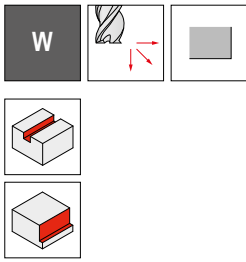

DIAMOND



Factory standard



50 937 ...

DC _{h10} mm	APMX mm	OAL mm	DCONMS _{h6} mm
5	16	60	6
5	28	75	6
6	20	60	6
6	35	75	6
8	22	63	8
8	40	100	8
10	25	72	10
10	50	100	10
12	30	83	12
12	50	100	12
16	35	92	16
16	60	125	16

- 050
- 052
- 060
- 062
- 080
- 082
- 100
- 102
- 120
- 122
- 160
- 162

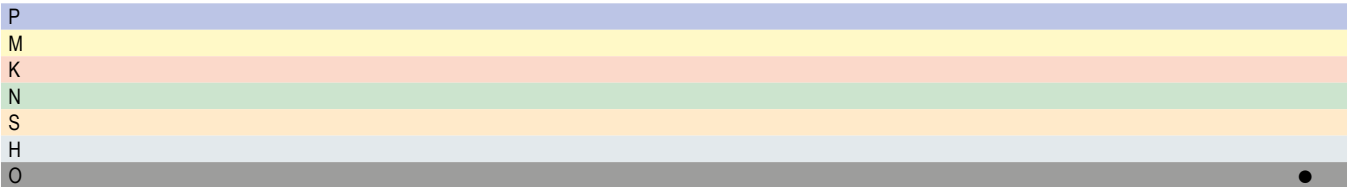

→ v_c/f_z Page 418

Cutter for honeycomb materials

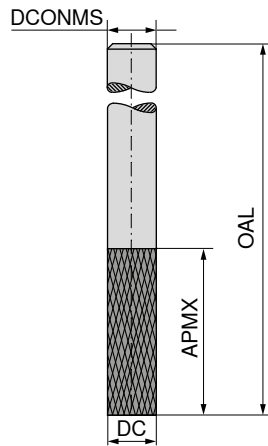
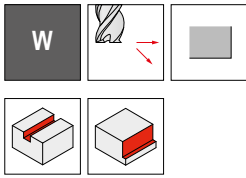

Ti28



Factory standard



50 936 ...

DC _{h10} mm	APMX mm	OAL mm	DCONMS _{h6} mm
6	16	50	6
8	19	63	8
10	22	72	10
12	26	83	12
16	17	100	12
20	17	100	12
24	10	100	12
24	17	100	12

- 006
- 008
- 010
- 012
- 016
- 020
- 024
- 025

P
M
K
N
S
H
O

→ v_c/f_z Page 418

Right and left hand helix cutter for fibre re-inforced plastics

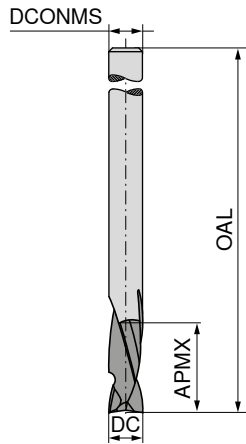
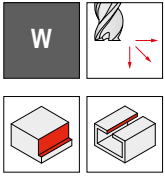

Ti28



Factory standard



50 938 ...

DC _{h10} mm	APMX mm	OAL mm	DCONMS _{h6} mm	ZEFP
2	6	40	6	2
3	12	40	3	2
3	12	50	6	2
4	14	40	4	2
5	16	50	5	2
6	18	50	6	2
8	20	63	8	2
10	25	72	10	2
12	30	83	12	2

- 020
- 030
- 032
- 040
- 050
- 060
- 080
- 100
- 120

P
M
K
N
S
H
O

→ v_c/f_z Page 418

Single flute cutter

▲ With polished chip flutes

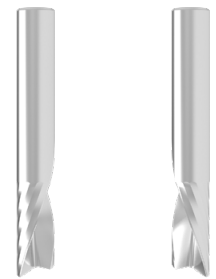
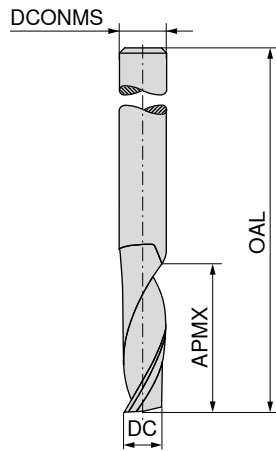
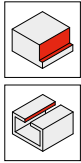
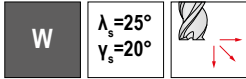

Right-hand helix
right-hand cutting

Factory standard



Left-hand helix
right-hand cutting

Factory standard

DC _{h10} mm	APMX mm	OAL mm	DCONMS _{h6} mm	ZFP
1,5	6	40	3,0	1
2,0	10	40	2,0	1
2,0	6	40	3,0	1
2,0	10	60	6,0	1
2,0	12	60	6,0	1
2,5	6	40	2,5	1
3,0	12	60	6,0	1
3,0	12	40	3,0	1
3,0	10	40	6,0	1
3,0	15	60	6,0	1
4,0	20	75	6,0	1
4,0	15	40	4,0	1
4,0	15	60	6,0	1
5,0	16	60	6,0	1
5,0	16	50	5,0	1
5,0	28	75	6,0	1
6,0	20	60	6,0	1
6,0	30	60	6,0	1
6,0	35	75	6,0	1
8,0	22	63	8,0	1
8,0	40	100	8,0	1
10,0	55	100	10,0	1
10,0	25	72	10,0	1
12,0	30	83	12,0	1
16,0	35	92	16,0	1

50 610 ...	50 611 ...
015	015
020	020
019	019
022	022
024	024
025	025
034	034
030	030
032	032
036	036
044	044
040	040
042	042
052	052
050	050
054	054
060	060
062	062
064	064
080	080
084	084
105	105
100	100
120	120
160	160

P		
M		
K		
N	•	•
S		
H		
O	•	•

→ v_c/f_z Page 418

Cutter for plastics

▲ With polished flutes

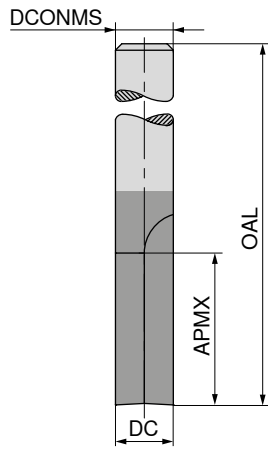
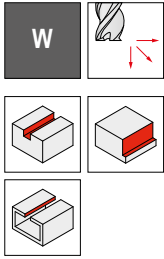

Ti40



Factory standard



50 946 ...

DC _{h10} mm	APMX mm	OAL mm	DCONMS _{h6} mm	ZEPF	
1,5	6	40	3	1	015
2,0	6	40	3	1	020
2,0	10	40	2	1	022
2,0	10	60	6	1	024
2,0	12	60	6	1	026
3,0	12	40	3	1	030
3,0	12	60	6	1	032
3,0	15	60	6	1	034
4,0	15	60	6	1	040
4,0	20	75	6	1	042
5,0	16	60	6	1	050
5,0	28	75	6	1	052
6,0	20	60	6	1	060
6,0	30	60	6	1	062
6,0	35	75	6	1	064
8,0	22	63	8	1	080
8,0	40	100	8	1	082
10,0	25	72	10	1	100
10,0	55	100	10	1	102
12,0	30	83	12	1	120

P	
M	
K	
N	●
S	
H	
O	●

→ v_c/f_z Page 418

Cutter for plastics

▲ with polished flutes

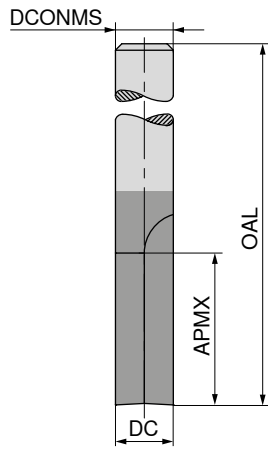
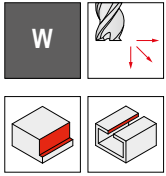

Ti28



Factory standard



50 948 ...

DC _{h10} mm	APMX mm	OAL mm	DCONMS _{h6} mm	ZEPF
2	6	40	6	2
3	12	40	3	2
3	12	50	6	2
4	14	40	6	2
5	16	50	5	2
6	18	50	6	2
8	20	63	8	2
10	25	72	10	2
12	30	83	12	2

- 020
- 030
- 031
- 040
- 050
- 060
- 080
- 100
- 120

P
M
K
N
S
H
O

→ v_c/f_z Page 418

Ball nosed cutter for plastics

- ▲ with polished flutes
- ▲ irregular pitch

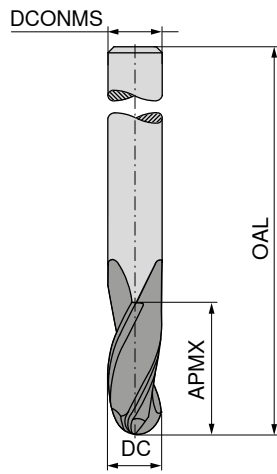
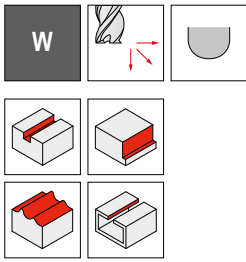

Ti40



DIN 6527 L



50 947 ...

DC _{h10} mm	APMX mm	OAL mm	DCONMS _{h6} mm	ZEFP
3	10	57	6	3
4	13	57	6	3
5	15	57	6	3
6	18	57	6	3
8	20	63	8	3
10	25	72	10	3
12	30	83	12	3

- 030
- 040
- 050
- 060
- 080
- 100
- 120

P	
M	
K	
N	●
S	
H	
O	●

→ v_c/f_z Page 418

Slot milling cutter

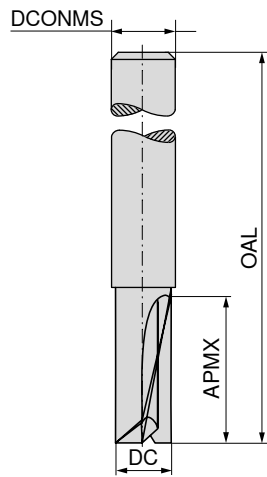
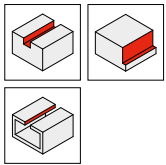
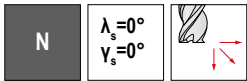

Factory standard



52 168 ...

DC _{es} mm	APMX mm	OAL mm	DCONMS _{h6} mm	ZEFP	
2	8	50	3	2	020
3	12	50	3	2	030
4	13	60	4	2	040
5	14	60	5	2	050
6	16	58	6	2	060
8	20	65	8	2	080
10	22	70	10	2	100
12	25	70	12	2	120

P	●
M	○
K	●
N	○
S	○
H	
O	●

→ v_c/f_z Page 480-483

Material examples for cutting data tables

	Material sub-group	Index	Composition / Structure / Heat treatment	Tensile strength N/mm ² / HB / HRC	Material number	Material designation	Material number	Material designation
P	Unalloyed steel	P.1.1	< 0,15 % C Annealed	420 N/mm ² / 125 HB	1.0401	C15	1.1141	Ck15
		P.1.2	< 0,45 % C Annealed	640 N/mm ² / 190 HB	1.1191	C45E	1.0718	9SMnPb28
		P.1.3	< 0,45 % C Tempered	840 N/mm ² / 250 HB	1.1191	C45E	1.0535	C55
		P.1.4	< 0,75 % C Annealed	910 N/mm ² / 270 HB	1.1223	C60R	1.0535	C55
		P.1.5	< 0,75 % C Tempered	1010 N/mm ² / 300 HB	1.1223	C60R	1.0727	45S20
	Low-alloy steel	P.2.1	Annealed	610 N/mm ² / 180 HB	1.7131	16MnCr5	1.6587	17CrNiMo6
		P.2.2	Tempered	930 N/mm ² / 275 HB	1.7131	16MnCr5	1.6587	17CrNiMo6
		P.2.3	Tempered	1010 N/mm ² / 300 HB	1.7225	42CrMo4	1.3505	100Cr6
		P.2.4	Tempered	1200 N/mm ² / 375 HB	1.7225	42CrMo4	1.3505	100Cr6
	High-alloy steel and high-alloy tool steel	P.3.1	Annealed	680 N/mm ² / 200 HB	1.4021	X20Cr13	1.4034	X46Cr13
		P.3.2	Hardened and tempered	1100 N/mm ² / 300 HB	1.2343	X38CrMoV5-1	1.4034	X46Cr13
		P.3.3	Hardened and tempered	1300 N/mm ² / 400 HB	1.2343	X38CrMoV5-1	1.4034	X46Cr13
	Stainless steel	P.4.1	Ferritic / martensitic Annealed	680 N/mm ² / 200 HB	1.4016	X6Cr17	1.2316	X36CrMo16
		P.4.2	Martensitic Tempered	1010 N/mm ² / 300 HB	1.4112	X90CrMoV18	1.2316	X36CrMo16
M	Stainless steel	M.1.1	Austenitic / austenitic-ferritic Quenched	610 N/mm ² / 180 HB	1.4301	X5CrNi18-10	1.4571	X6CrNiMoTi17-12-2
		M.2.1	Austenitic Tempered	300 HB	1.4841	X15CrNiSi25-21	1.4539	X1NiCrMoCu25-20-5
		M.3.1	Austenitic / ferritic (Duplex)	780 N/mm ² / 230 HB	1.4462	X2CrNiMoN22-5-3	1.4501	X2CrNiMoCuWN25-7-4
K	Grey cast iron	K.1.1	Pearlitic / ferritic	350 N/mm ² / 180 HB	0.6010	GG-10	0.6025	GG-25
		K.1.2	Pearlitic (martensitic)	500 N/mm ² / 260 HB	0.6030	GG-30	0.6045	GG-45
	Spherulitic graphite cast iron	K.2.1	Ferritic	540 N/mm ² / 160 HB	0.7040	GGG-40	0.7060	GGG-60
		K.2.2	Pearlitic	845 N/mm ² / 250 HB	0.7070	GGG-70	0.7080	GGG-80
	Malleable iron	K.3.1	Ferritic	440 N/mm ² / 130 HB	0.8035	GTW-35-04	0.8045	GTW-45
		K.3.2	Pearlitic	780 N/mm ² / 230 HB	0.8165	GTS-65-02	0.8170	GTS-70-02
N	Aluminium wrought alloy	N.1.1	Non-hardenable	60 HB	3.0255	Al99,5	3.3315	AlMg1
		N.1.2	Hardenable Age-hardened	340 N/mm ² / 100 HB	3.1355	AlCuMg2	3.2315	AlMgSi1
	Cast aluminium alloy	N.2.1	≤ 12 % Si, non-hardenable	250 N/mm ² / 75 HB	3.2581	G-AlSi12	3.2163	G-AlSi9Cu3
		N.2.2	≤ 12 % Si, hardenable Age-hardened	300 N/mm ² / 90 HB	3.2134	G-AlSi5Cu1Mg	3.2373	G-AlSi9Mg
		N.2.3	> 12 % Si, non-hardenable	440 N/mm ² / 130 HB		G-AlSi17Cu4Mg		G-AlSi18CuNiMg
	Copper and copper alloys (bronze/brass)	N.3.1	Free-machining alloys, PB > 1 %	375 N/mm ² / 110 HB	2.0380	CuZn39Pb2 (Ms58)	2.0410	CuZn44Pb2
		N.3.2	CuZn, CuSnZn	300 N/mm ² / 90 HB	2.0331	CuZn15	2.4070	CuZn28Sn1As
		N.3.3	CuSn, lead-free copper and electrolytic copper	340 N/mm ² / 100 HB	2.0060	E-Cu57	2.0590	CuZn40Fe
	Magnesium alloys	N.4.1	Magnesium and magnesium alloys	70 HB	3.5612	MgAl6Zn	3.5312	MgAl3Zn
	S	Heat-resistant alloys	S.1.1	Fe - basis Annealed	680 N/mm ² / 200 HB	1.4864	X12NiCrSi 36-16	1.4865
S.1.2			Fe - basis Age-hardened	950 N/mm ² / 280 HB	1.4980	X6NiCrTiMoVB25-15-2	1.4876	X10NiCrAlTi32-20
S.2.1			Ni or Co basis Annealed	840 N/mm ² / 250 HB	2.4631	NiCr20TiAl (Nimonic80A)	3.4856	NiCr22Mo9Nb
S.2.2			Ni or Co basis Age-hardened	1180 N/mm ² / 350 HB	2.4668	NiCr19Nb5Mo3 (Inconel 718)	2.4955	NiFe25Cr20NbTi
S.2.3			Ni or Co basis Cast	1080 N/mm ² / 320 HB	2.4765	CoCr20W15Ni	1.3401	G-X120Mn12
Titanium alloys		S.3.1	Pure titanium	400 N/mm ²	3.7025	Ti99,8	3.7034	Ti99,7
		S.3.2	Alpha + beta alloys Age-hardened	1050 N/mm ² / 320 HB	3.7165	TiAl6V4	Ti-6246	Ti-6Al-2Sn-4Zr-6Mo
		S.3.3	Beta alloys	1400 N/mm ² / 410 HB	Ti555.3	Ti-5Al-5V-5Mo-3Cr	R56410	Ti-10V-2Fe-3Al
H	Hardened steel	H.1.1	Hardened and tempered	46–55 HRC				
		H.1.2	Hardened and tempered	56–60 HRC				
		H.1.3	Hardened and tempered	61–65 HRC				
		H.1.4	Hardened and tempered	66–70 HRC				
	Chilled iron	H.2.1	Cast	400 HB				
Hardened cast iron	H.3.1	Hardened and tempered	55 HRC					
O	Non-metal materials	O.1.1	Plastics, duroplastic	≤ 150 N/mm ²				
		O.1.2	Plastics, thermoplastic	≤ 100 N/mm ²				
		O.2.1	Aramid fibre-reinforced	≤ 1000 N/mm ²				
		O.2.2	Glass/carbon-fibre reinforced	≤ 1000 N/mm ²				
		O.3.1	Graphite					

* Tensile strength

Cutting data standard values – MonsterMill – SCR – End mill, short – long

Index	52 600 ..., 52 601 ..., 52 602 ..., 52 603 ..., 52 604 ..., 52 606 ..., 52 607 ..., 52 608 ..., 52 611 ..., 52 612 ...																					
	Emulsion		Compressed air		MMS		Type short		Type long		Ø DC (mm) =						Ø DC (mm) =					
											3,0–3,5			4,0–4,5			5,0–5,5		6,0–7,5			8,0–9,5
	v_c (m/min)		$a_{p,max} \times DC$		f_z (mm)						$a_{p,max} \times DC$		f_z (mm)									
				a_e 0,1–0,2 x DC	a_e 0,3–0,4 x DC	a_e 0,6–1,0 x DC	a_e 0,1–0,2 x DC	a_e 0,3–0,4 x DC	a_e 0,6–1,0 x DC	Type short	Type long	a_e 0,1–0,2 x DC	a_e 0,3–0,4 x DC	a_e 0,6–1,0 x DC	a_e 0,1–0,2 x DC	a_e 0,3–0,4 x DC	a_e 0,6–1,0 x DC	a_e 0,1–0,2 x DC	a_e 0,3–0,4 x DC	a_e 0,6–1,0 x DC		
P.1.1	90	160	1,0	1,0	0,031	0,024	0,017	0,043	0,033	0,024	1,0	1,0*	0,062	0,046	0,031	0,083	0,062	0,041	0,11	0,08	0,06	
P.1.2	90	150	1,0	1,0	0,034	0,026	0,019	0,047	0,036	0,026	1,0	1,0*	0,068	0,050	0,034	0,090	0,067	0,045	0,12	0,09	0,06	
P.1.3	90	150	1,0	1,0	0,034	0,026	0,019	0,047	0,036	0,026	1,0	1,0*	0,068	0,050	0,034	0,090	0,067	0,045	0,12	0,09	0,06	
P.1.4	90	140	1,0	1,0	0,034	0,026	0,019	0,047	0,036	0,026	1,0	1,0*	0,068	0,050	0,034	0,090	0,067	0,045	0,12	0,09	0,06	
P.1.5	90	140	1,0	1,0	0,034	0,026	0,019	0,047	0,036	0,026	1,0	1,0*	0,068	0,050	0,034	0,090	0,067	0,045	0,12	0,09	0,06	
P.2.1	90	140	1,0	1,0	0,034	0,026	0,019	0,047	0,036	0,026	1,0	1,0*	0,068	0,050	0,034	0,090	0,067	0,045	0,12	0,09	0,06	
P.2.2	90	140	1,0	1,0	0,034	0,026	0,019	0,047	0,036	0,026	1,0	1,0*	0,068	0,050	0,034	0,090	0,067	0,045	0,12	0,09	0,06	
P.2.3	80	120	1,0	1,0	0,025	0,019	0,014	0,035	0,027	0,020	1,0	1,0*	0,050	0,038	0,025	0,067	0,050	0,034	0,09	0,07	0,05	
P.2.4	80	120	1,0	1,0	0,025	0,019	0,014	0,035	0,027	0,020	1,0	1,0*	0,050	0,038	0,025	0,067	0,050	0,034	0,09	0,07	0,05	
P.3.1	90	140	1,0	1,0	0,022	0,017	0,013	0,031	0,024	0,018	1,0	1,0*	0,045	0,034	0,023	0,060	0,045	0,030	0,08	0,06	0,04	
P.3.2	80	130	1,0	1,0	0,022	0,017	0,013	0,031	0,024	0,018	1,0	1,0*	0,045	0,034	0,023	0,060	0,045	0,030	0,08	0,06	0,04	
P.3.3	80	110	1,0	1,0	0,022	0,017	0,013	0,031	0,024	0,018	1,0	1,0*	0,045	0,034	0,023	0,060	0,045	0,030	0,08	0,06	0,04	
P.4.1	80		1,0	1,0	0,020	0,015	0,011	0,028	0,021	0,015	1,0	1,0*	0,040	0,030	0,020	0,053	0,039	0,026	0,07	0,05	0,04	
P.4.2	80		1,0	1,0	0,020	0,015	0,011	0,028	0,021	0,015	1,0	1,0*	0,040	0,030	0,020	0,053	0,039	0,026	0,07	0,05	0,04	
M.1.1	80		1,0	1,0	0,020	0,015	0,011	0,028	0,021	0,015	1,0	1,0*	0,040	0,030	0,020	0,053	0,039	0,026	0,07	0,05	0,04	
M.2.1	80		1,0	1,0	0,020	0,015	0,011	0,028	0,021	0,015	1,0	1,0*	0,040	0,030	0,020	0,053	0,039	0,026	0,07	0,05	0,04	
M.3.1	80		1,0	1,0	0,020	0,015	0,011	0,028	0,021	0,015	1,0	1,0*	0,040	0,030	0,020	0,053	0,039	0,026	0,07	0,05	0,04	
K.1.1		200	1,0	1,0	0,040	0,031	0,022	0,055	0,043	0,031	1,0	1,0*	0,079	0,059	0,040	0,106	0,079	0,053	0,14	0,11	0,07	
K.1.2		180	1,0	1,0	0,040	0,031	0,022	0,055	0,043	0,031	1,0	1,0*	0,079	0,059	0,040	0,106	0,079	0,053	0,14	0,11	0,07	
K.2.1		200	1,0	1,0	0,034	0,026	0,019	0,047	0,036	0,026	1,0	1,0*	0,068	0,050	0,034	0,090	0,067	0,045	0,12	0,09	0,06	
K.2.2		180	1,0	1,0	0,034	0,026	0,019	0,047	0,036	0,026	1,0	1,0*	0,068	0,050	0,034	0,090	0,067	0,045	0,12	0,09	0,06	
K.3.1		140	1,0	1,0	0,028	0,022	0,016	0,040	0,031	0,022	1,0	1,0*	0,057	0,042	0,028	0,076	0,056	0,038	0,10	0,08	0,05	
K.3.2		140	1,0	1,0	0,028	0,022	0,016	0,040	0,031	0,022	1,0	1,0*	0,057	0,042	0,028	0,076	0,056	0,038	0,10	0,08	0,05	
N.1.1																						
N.1.2																						
N.2.1																						
N.2.2																						
N.2.3																						
N.3.1	150	280	1,0	1,0	0,031	0,024	0,017	0,043	0,033	0,024	1,0	1,0*	0,062	0,046	0,031	0,083	0,062	0,041	0,11	0,08	0,06	
N.3.2	140	230	1,0	1,0	0,034	0,026	0,019	0,047	0,036	0,026	1,0	1,0*	0,068	0,050	0,034	0,090	0,067	0,045	0,12	0,09	0,06	
N.3.3	140	230	1,0	1,0	0,034	0,026	0,019	0,047	0,036	0,026	1,0	1,0*	0,068	0,050	0,034	0,090	0,067	0,045	0,12	0,09	0,06	
N.4.1																						
S.1.1	45		0,5	0,5	0,016	0,007	0,009	0,022	0,017	0,012	0,5	0,5	0,032	0,023	0,016	0,042	0,031	0,021	0,06	0,04	0,03	
S.1.2	45		0,5	0,5	0,016	0,007	0,009	0,022	0,017	0,012	0,5	0,5	0,032	0,023	0,016	0,042	0,031	0,021	0,06	0,04	0,03	
S.2.1	30		0,5	0,5	0,018	0,014	0,010	0,025	0,019	0,014	0,5	0,5	0,036	0,027	0,018	0,048	0,036	0,024	0,06	0,05	0,03	
S.2.2	30		0,5	0,5	0,016	0,007	0,009	0,022	0,017	0,012	0,5	0,5	0,032	0,023	0,016	0,042	0,031	0,021	0,06	0,04	0,03	
S.2.3	30		0,5	0,5	0,016	0,012	0,009	0,022	0,017	0,012	0,5	0,5	0,032	0,023	0,016	0,042	0,031	0,021	0,06	0,04	0,03	
S.3.1	80		0,5	0,5	0,025	0,019	0,014	0,035	0,027	0,020	0,5	0,5	0,050	0,038	0,025	0,067	0,050	0,034	0,09	0,07	0,05	
S.3.2	60		0,5	0,5	0,025	0,019	0,014	0,035	0,027	0,019	0,5	0,5	0,050	0,037	0,025	0,066	0,049	0,033	0,09	0,07	0,04	
S.3.3	60		0,5	0,5	0,022	0,017	0,013	0,031	0,024	0,018	0,5	0,5	0,045	0,034	0,023	0,060	0,045	0,030	0,08	0,06	0,04	
H.1.1		80	0,3	0,3	0,018	0,014	0,010	0,025	0,019	0,014	0,3	0,3	0,036	0,027	0,018	0,048	0,036	0,024	0,06	0,05	0,03	
H.1.2		60	0,15	0,15	0,016	0,012	0,009	0,022	0,017	0,012	0,15	0,15	0,032	0,023	0,016	0,042	0,031	0,021	0,06	0,04	0,03	
H.1.3																						
H.1.4																						
H.2.1		120	0,5	0,5	0,020	0,016	0,011	0,028	0,022	0,016	0,5	0,5	0,041	0,030	0,020	0,054	0,040	0,027	0,07	0,05	0,04	
H.3.1		80	0,3	0,3	0,018	0,014	0,010	0,025	0,019	0,014	0,3	0,3	0,036	0,027	0,018	0,048	0,036	0,024	0,06	0,05	0,03	
O.1.1	180	300	1,0	1,0	0,067	0,052	0,038	0,094	0,073	0,053	1,0	1,0*	0,135	0,101	0,068	0,180	0,134	0,090	0,24	0,18	0,12	
O.1.2																						
O.2.1																						
O.2.2																						
O.3.1																						

*= With an a_p of 1.5xD, the feed rate per tooth f_z should be multiplied by 0.8

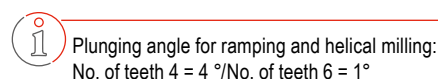
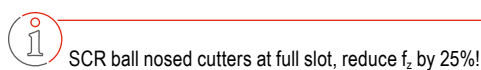

Index	52 600 ..., 52 601 ..., 52 602 ..., 52 603 ..., 52 604 ..., 52 606 ..., 52 607 ..., 52 608 ..., 52 611 ..., 52 612 ...																		● 1st choice ○ suitable		
	Ø DC (mm) =																		Emulsion	Compressed air	MMS
	10,0–11,5			12,0			14,0–15,5			16,0–17,0			18,0–19,5			20,0					
	a_p 0,1–0,2 x DC	a_p 0,3–0,4 x DC	a_p 0,6–1,0 x DC	a_p 0,1–0,2 x DC	a_p 0,3–0,4 x DC	a_p 0,6–1,0 x DC	a_p 0,1–0,2 x DC	a_p 0,3–0,4 x DC	a_p 0,6–1,0 x DC	a_p 0,1–0,2 x DC	a_p 0,3–0,4 x DC	a_p 0,6–1,0 x DC	a_p 0,1–0,2 x DC	a_p 0,3–0,4 x DC	a_p 0,6–1,0 x DC	a_p 0,1–0,2 x DC	a_p 0,3–0,4 x DC	a_p 0,6–1,0 x DC			
f _z (mm)																					
P.1.1	0,14	0,10	0,07	0,15	0,11	0,08	0,15	0,12	0,08	0,16	0,13	0,10	0,18	0,14	0,11	0,20	0,16	0,12	○	●	○
P.1.2	0,15	0,11	0,08	0,17	0,12	0,08	0,16	0,13	0,09	0,18	0,14	0,11	0,19	0,16	0,12	0,21	0,17	0,14	○	●	○
P.1.3	0,15	0,11	0,08	0,17	0,12	0,08	0,16	0,13	0,09	0,18	0,14	0,11	0,19	0,16	0,12	0,21	0,17	0,14	○	●	○
P.1.4	0,15	0,11	0,08	0,17	0,12	0,08	0,16	0,13	0,09	0,18	0,14	0,11	0,19	0,16	0,12	0,21	0,17	0,14	○	●	○
P.1.5	0,15	0,11	0,08	0,17	0,12	0,08	0,16	0,13	0,09	0,18	0,14	0,11	0,19	0,16	0,12	0,21	0,17	0,14	○	●	○
P.2.1	0,15	0,11	0,08	0,17	0,12	0,08	0,16	0,13	0,09	0,18	0,14	0,11	0,19	0,16	0,12	0,21	0,17	0,14	○	●	○
P.2.2	0,15	0,11	0,08	0,17	0,12	0,08	0,16	0,13	0,09	0,18	0,14	0,11	0,19	0,16	0,12	0,21	0,17	0,14	○	●	○
P.2.3	0,11	0,08	0,06	0,12	0,09	0,06	0,12	0,10	0,07	0,13	0,10	0,08	0,14	0,12	0,09	0,16	0,13	0,10	○	●	○
P.2.4	0,11	0,08	0,06	0,12	0,09	0,06	0,12	0,10	0,07	0,13	0,10	0,08	0,14	0,12	0,09	0,16	0,13	0,10	○	●	○
P.3.1	0,10	0,08	0,05	0,11	0,08	0,06	0,11	0,09	0,06	0,12	0,09	0,07	0,13	0,10	0,08	0,14	0,12	0,09	○	●	○
P.3.2	0,10	0,08	0,05	0,11	0,08	0,06	0,11	0,09	0,06	0,12	0,09	0,07	0,13	0,10	0,08	0,14	0,12	0,09	○	●	○
P.3.3	0,10	0,08	0,05	0,11	0,08	0,06	0,11	0,09	0,06	0,12	0,09	0,07	0,13	0,10	0,08	0,14	0,12	0,09	○	●	○
P.4.1	0,09	0,07	0,04	0,10	0,07	0,05	0,10	0,08	0,05	0,10	0,08	0,06	0,11	0,09	0,07	0,13	0,10	0,08	●		
P.4.2	0,09	0,07	0,04	0,10	0,07	0,05	0,10	0,08	0,05	0,10	0,08	0,06	0,11	0,09	0,07	0,13	0,10	0,08	●		
M.1.1	0,09	0,07	0,04	0,10	0,07	0,05	0,10	0,08	0,05	0,10	0,08	0,06	0,11	0,09	0,07	0,13	0,10	0,08	●		
M.2.1	0,09	0,07	0,04	0,10	0,07	0,05	0,10	0,08	0,05	0,10	0,08	0,06	0,11	0,09	0,07	0,13	0,10	0,08	●		
M.3.1	0,09	0,07	0,04	0,10	0,07	0,05	0,10	0,08	0,05	0,10	0,08	0,06	0,11	0,09	0,07	0,13	0,10	0,08	●		
K.1.1	0,18	0,13	0,09	0,19	0,14	0,10	0,19	0,15	0,11	0,21	0,16	0,12	0,22	0,18	0,14	0,25	0,20	0,16		●	
K.1.2	0,18	0,13	0,09	0,19	0,14	0,10	0,19	0,15	0,11	0,21	0,16	0,12	0,22	0,18	0,14	0,25	0,20	0,16		●	
K.2.1	0,15	0,11	0,08	0,17	0,12	0,08	0,16	0,13	0,09	0,18	0,14	0,11	0,19	0,16	0,12	0,21	0,17	0,14		●	
K.2.2	0,15	0,11	0,08	0,17	0,12	0,08	0,16	0,13	0,09	0,18	0,14	0,11	0,19	0,16	0,12	0,21	0,17	0,14		●	
K.3.1	0,13	0,09	0,06	0,14	0,10	0,07	0,14	0,11	0,08	0,15	0,11	0,09	0,16	0,13	0,10	0,18	0,15	0,11		●	
K.3.2	0,13	0,09	0,06	0,14	0,10	0,07	0,14	0,11	0,08	0,15	0,11	0,09	0,16	0,13	0,10	0,18	0,15	0,11		●	
N.1.1																					
N.1.2																					
N.2.1																					
N.2.2																					
N.2.3																					
N.3.1	0,14	0,10	0,07	0,15	0,11	0,08	0,15	0,12	0,08	0,16	0,13	0,10	0,18	0,14	0,11	0,20	0,16	0,12	●		○
N.3.2	0,15	0,11	0,08	0,17	0,12	0,08	0,16	0,13	0,09	0,18	0,14	0,11	0,19	0,16	0,12	0,21	0,17	0,14	●		○
N.3.3	0,15	0,11	0,08	0,17	0,12	0,08	0,16	0,13	0,09	0,18	0,14	0,11	0,19	0,16	0,12	0,21	0,17	0,14	●		○
N.4.1																					
S.1.1	0,07	0,05	0,04	0,08	0,06	0,04	0,08	0,06	0,04	0,08	0,06	0,05	0,09	0,07	0,06	0,10	0,08	0,06	●		
S.1.2	0,07	0,05	0,04	0,08	0,06	0,04	0,08	0,06	0,04	0,08	0,06	0,05	0,09	0,07	0,06	0,10	0,08	0,06	●		
S.2.1	0,08	0,06	0,04	0,09	0,07	0,04	0,09	0,07	0,05	0,10	0,07	0,06	0,10	0,08	0,06	0,11	0,09	0,07	●		
S.2.2	0,07	0,05	0,04	0,08	0,06	0,04	0,08	0,06	0,04	0,08	0,06	0,05	0,09	0,07	0,06	0,10	0,08	0,06	●		
S.2.3	0,07	0,05	0,04	0,08	0,03	0,04	0,08	0,06	0,04	0,08	0,06	0,05	0,09	0,07	0,06	0,10	0,08	0,06	●		
S.3.1	0,11	0,08	0,06	0,12	0,09	0,06	0,12	0,10	0,07	0,13	0,10	0,08	0,14	0,12	0,09	0,16	0,13	0,10	●		
S.3.2	0,11	0,08	0,06	0,12	0,09	0,06	0,12	0,09	0,07	0,13	0,10	0,08	0,14	0,11	0,09	0,16	0,13	0,10	●		
S.3.3	0,10	0,08	0,05	0,11	0,08	0,06	0,11	0,09	0,06	0,12	0,09	0,07	0,13	0,10	0,08	0,14	0,12	0,09	●		
H.1.1	0,08	0,06	0,04	0,09	0,07	0,04	0,09	0,07	0,05	0,10	0,07	0,06	0,10	0,08	0,06	0,11	0,09	0,07		●	
H.1.2	0,07	0,05	0,04	0,08	0,06	0,04	0,08	0,06	0,04	0,08	0,06	0,05	0,09	0,07	0,06	0,10	0,08	0,06		●	
H.1.3																					
H.1.4																					
H.2.1	0,09	0,07	0,05	0,10	0,07	0,05	0,10	0,08	0,05	0,11	0,08	0,06	0,11	0,09	0,07	0,13	0,11	0,08		●	
H.3.1	0,08	0,06	0,04	0,09	0,07	0,04	0,09	0,07	0,05	0,10	0,07	0,06	0,10	0,08	0,06	0,11	0,09	0,07		●	
O.1.1	0,30	0,22	0,15	0,33	0,25	0,17	0,33	0,26	0,18	0,36	0,27	0,21	0,38	0,31	0,24	0,43	0,35	0,27	●		○
O.1.2																					
O.2.1																					
O.2.2																					
O.3.1																					

Cutting data standard values – MonsterMill – SCR– End mill, extra long

Index	Emulsion	Compressed air	MMS	Type extra long	52 605 ... / 52 608 ...														
					3			4			Ø DC (mm) =			6			8		
					a_p 0,1-0,2 x DC	a_p 0,3-0,4 x DC	a_p 0,6-1,0 x DC	a_p 0,1-0,2 x DC	a_p 0,3-0,4 x DC	a_p 0,6-1,0 x DC	a_p 0,1-0,2 x DC	a_p 0,3-0,4 x DC	a_p 0,6-1,0 x DC	a_p 0,1-0,2 x DC	a_p 0,3-0,4 x DC	a_p 0,6-1,0 x DC	a_p 0,1-0,2 x DC	a_p 0,3-0,4 x DC	a_p 0,6-1,0 x DC
					f_z (mm)														
	v_c (m/min)		$a_{p,max}$ x DC																
P.1.1	80	110	1,0*	0,5	0,031	0,024	0,017	0,043	0,033	0,024	0,062	0,046	0,031	0,083	0,062	0,041	0,11	0,08	0,06
P.1.2	80	110	1,0*	0,5	0,034	0,026	0,019	0,047	0,036	0,026	0,068	0,050	0,034	0,090	0,067	0,045	0,12	0,09	0,06
P.1.3	80	110	1,0*	0,5	0,034	0,026	0,019	0,047	0,036	0,026	0,068	0,050	0,034	0,090	0,067	0,045	0,12	0,09	0,06
P.1.4	80	110	1,0*	0,5	0,034	0,026	0,019	0,047	0,036	0,026	0,068	0,050	0,034	0,090	0,067	0,045	0,12	0,09	0,06
P.1.5	80	110	1,0*	0,5	0,034	0,026	0,019	0,047	0,036	0,026	0,068	0,050	0,034	0,090	0,067	0,045	0,12	0,09	0,06
P.2.1	80	90	1,0*	0,5	0,034	0,026	0,019	0,047	0,036	0,026	0,068	0,050	0,034	0,090	0,067	0,045	0,12	0,09	0,06
P.2.2	80	90	1,0*	0,5	0,034	0,026	0,019	0,047	0,036	0,026	0,068	0,050	0,034	0,090	0,067	0,045	0,12	0,09	0,06
P.2.3	70	80	1,0*	0,5	0,025	0,019	0,014	0,035	0,027	0,020	0,050	0,038	0,025	0,067	0,050	0,034	0,09	0,07	0,05
P.2.4	70	80	1,0*	0,5	0,025	0,019	0,014	0,035	0,027	0,020	0,050	0,038	0,025	0,067	0,050	0,034	0,09	0,07	0,05
P.3.1	70	80	1,0*	0,5	0,022	0,017	0,013	0,031	0,024	0,018	0,045	0,034	0,023	0,060	0,045	0,030	0,08	0,06	0,04
P.3.2	70	80	1,0*	0,5	0,022	0,017	0,013	0,031	0,024	0,018	0,045	0,034	0,023	0,060	0,045	0,030	0,08	0,06	0,04
P.3.3	70	80	1,0*	0,5	0,022	0,017	0,013	0,031	0,024	0,018	0,045	0,034	0,023	0,060	0,045	0,030	0,08	0,06	0,04
P.4.1	70		1,0*	0,5	0,020	0,015	0,011	0,028	0,021	0,015	0,040	0,030	0,020	0,053	0,039	0,026	0,07	0,05	0,04
P.4.2	70		1,0*	0,5	0,020	0,015	0,011	0,028	0,021	0,015	0,040	0,030	0,020	0,053	0,039	0,026	0,07	0,05	0,04
M.1.1	70		1,0*	0,5	0,020	0,015	0,011	0,028	0,021	0,015	0,040	0,030	0,020	0,053	0,039	0,026	0,07	0,05	0,04
M.2.1	70		1,0*	0,5	0,020	0,015	0,011	0,028	0,021	0,015	0,040	0,030	0,020	0,053	0,039	0,026	0,07	0,05	0,04
M.3.1	70		1,0*	0,5	0,020	0,015	0,011	0,028	0,021	0,015	0,040	0,030	0,020	0,053	0,039	0,026	0,07	0,05	0,04
K.1.1		160	1,0*	0,5	0,040	0,031	0,022	0,055	0,043	0,031	0,079	0,059	0,040	0,106	0,079	0,053	0,14	0,11	0,07
K.1.2		120	1,0*	0,5	0,040	0,031	0,022	0,055	0,043	0,031	0,079	0,059	0,040	0,106	0,079	0,053	0,14	0,11	0,07
K.2.1		160	1,0*	0,5	0,034	0,026	0,019	0,047	0,036	0,026	0,068	0,050	0,034	0,090	0,067	0,045	0,12	0,09	0,06
K.2.2		120	1,0*	0,5	0,034	0,026	0,019	0,047	0,036	0,026	0,068	0,050	0,034	0,090	0,067	0,045	0,12	0,09	0,06
K.3.1		100	1,0*	0,5	0,028	0,022	0,016	0,040	0,031	0,022	0,057	0,042	0,028	0,076	0,056	0,038	0,10	0,08	0,05
K.3.2		100	1,0*	0,5	0,028	0,022	0,016	0,040	0,031	0,022	0,057	0,042	0,028	0,076	0,056	0,038	0,10	0,08	0,05
N.1.1																			
N.1.2																			
N.2.1																			
N.2.2																			
N.2.3																			
N.3.1	120	240	1,0*	0,5	0,031	0,024	0,017	0,043	0,033	0,024	0,062	0,046	0,031	0,083	0,062	0,041	0,11	0,08	0,06
N.3.2	100	200	1,0*	0,5	0,034	0,026	0,019	0,047	0,036	0,026	0,068	0,050	0,034	0,090	0,067	0,045	0,12	0,09	0,06
N.3.3	100	200	1,0*	0,5	0,034	0,026	0,019	0,047	0,036	0,026	0,068	0,050	0,034	0,090	0,067	0,045	0,12	0,09	0,06
N.4.1																			
S.1.1	40		0,5*	0,25	0,016	0,007	0,009	0,022	0,017	0,012	0,032	0,023	0,016	0,042	0,031	0,021	0,06	0,04	0,03
S.1.2	40		0,5*	0,25	0,016	0,007	0,009	0,022	0,017	0,012	0,032	0,023	0,016	0,042	0,031	0,021	0,06	0,04	0,03
S.2.1	25		0,5*	0,25	0,018	0,014	0,010	0,025	0,019	0,014	0,036	0,027	0,018	0,048	0,036	0,024	0,06	0,05	0,03
S.2.2	25		0,5*	0,25	0,016	0,007	0,009	0,022	0,017	0,012	0,032	0,023	0,016	0,042	0,031	0,021	0,06	0,04	0,03
S.2.3	25		0,5*	0,25	0,016	0,012	0,009	0,022	0,017	0,012	0,032	0,023	0,016	0,042	0,031	0,021	0,06	0,04	0,03
S.3.1	60		0,5*	0,25	0,025	0,019	0,014	0,035	0,027	0,020	0,050	0,038	0,025	0,067	0,050	0,034	0,09	0,07	0,05
S.3.2	50		0,5*	0,25	0,025	0,019	0,014	0,035	0,027	0,019	0,050	0,037	0,025	0,066	0,049	0,033	0,09	0,07	0,04
S.3.3	50		0,5*	0,25	0,022	0,017	0,013	0,031	0,024	0,018	0,045	0,034	0,023	0,060	0,045	0,030	0,08	0,06	0,04
H.1.1		60	0,5*	0,3	0,018	0,014	0,010	0,025	0,019	0,014	0,036	0,027	0,018	0,048	0,036	0,024	0,06	0,05	0,03
H.1.2		50	0,5*	0,15	0,016	0,012	0,009	0,022	0,017	0,012	0,032	0,023	0,016	0,042	0,031	0,021	0,06	0,04	0,03
H.1.3																			
H.1.4																			
H.2.1		80	0,5*	0,5	0,020	0,016	0,011	0,028	0,022	0,016	0,041	0,030	0,020	0,054	0,040	0,027	0,07	0,05	0,04
H.3.1		60	0,5*	0,3	0,018	0,014	0,010	0,025	0,019	0,014	0,036	0,027	0,018	0,048	0,036	0,024	0,06	0,05	0,03
O.1.1	120	240	1,0*	0,5	0,067	0,052	0,038	0,094	0,073	0,053	0,135	0,101	0,068	0,180	0,134	0,090	0,24	0,18	0,12
O.1.2																			
O.2.1																			
O.2.2																			
O.3.1																			

* = Trimming and trochoidal slot milling

 Plunging angle for ramping and helical milling: No. of teeth 4 = 4 °/No. of teeth 6 = 1°

Index	52 605 ... / 52 608 ...																		● 1st choice		
	Ø DC (mm) =																		○ suitable		
	10			12			14			16			18			20			Emulsion	Compressed air	MMS
	a_s 0,1-0,2 x DC	a_s 0,3-0,4 x DC	a_s 0,6-1,0 x DC	a_s 0,1-0,2 x DC	a_s 0,3-0,4 x DC	a_s 0,6-1,0 x DC	a_s 0,1-0,2 x DC	a_s 0,3-0,4 x DC	a_s 0,6-1,0 x DC	a_s 0,1-0,2 x DC	a_s 0,3-0,4 x DC	a_s 0,6-1,0 x DC	a_s 0,1-0,2 x DC	a_s 0,3-0,4 x DC	a_s 0,6-1,0 x DC	a_s 0,1-0,2 x DC	a_s 0,3-0,4 x DC	a_s 0,6-1,0 x DC			
f_z (mm)																					
P.1.1	0,14	0,10	0,07	0,15	0,11	0,08	0,15	0,12	0,08	0,15	0,13	0,10	0,18	0,14	0,11	0,20	0,16	0,12	○	●	○
P.1.2	0,15	0,11	0,08	0,17	0,12	0,08	0,16	0,13	0,09	0,17	0,14	0,11	0,19	0,16	0,12	0,21	0,17	0,14	○	●	○
P.1.3	0,15	0,11	0,08	0,17	0,12	0,08	0,16	0,13	0,09	0,17	0,14	0,11	0,19	0,16	0,12	0,21	0,17	0,14	○	●	○
P.1.4	0,15	0,11	0,08	0,17	0,12	0,08	0,16	0,13	0,09	0,17	0,14	0,11	0,19	0,16	0,12	0,21	0,17	0,14	○	●	○
P.1.5	0,15	0,11	0,08	0,17	0,12	0,08	0,16	0,13	0,09	0,17	0,14	0,11	0,19	0,16	0,12	0,21	0,17	0,14	○	●	○
P.2.1	0,15	0,11	0,08	0,17	0,12	0,08	0,16	0,13	0,09	0,17	0,14	0,11	0,19	0,16	0,12	0,21	0,17	0,14	○	●	○
P.2.2	0,15	0,11	0,08	0,17	0,12	0,08	0,16	0,13	0,09	0,17	0,14	0,11	0,19	0,16	0,12	0,21	0,17	0,14	○	●	○
P.2.3	0,11	0,08	0,06	0,12	0,09	0,06	0,12	0,10	0,07	0,12	0,10	0,08	0,14	0,12	0,09	0,16	0,13	0,10	○	●	○
P.2.4	0,11	0,08	0,06	0,12	0,09	0,06	0,12	0,10	0,07	0,12	0,10	0,08	0,14	0,12	0,09	0,16	0,13	0,10	○	●	○
P.3.1	0,10	0,08	0,05	0,11	0,08	0,06	0,11	0,09	0,06	0,11	0,09	0,07	0,13	0,10	0,08	0,14	0,12	0,09	○	●	○
P.3.2	0,10	0,08	0,05	0,11	0,08	0,06	0,11	0,09	0,06	0,11	0,09	0,07	0,13	0,10	0,08	0,14	0,12	0,09	○	●	○
P.3.3	0,10	0,08	0,05	0,11	0,08	0,06	0,11	0,09	0,06	0,11	0,09	0,07	0,13	0,10	0,08	0,14	0,12	0,09	○	●	○
P.4.1	0,09	0,07	0,04	0,10	0,07	0,05	0,10	0,08	0,05	0,10	0,08	0,06	0,11	0,09	0,07	0,13	0,10	0,08	●		
P.4.2	0,09	0,07	0,04	0,10	0,07	0,05	0,10	0,08	0,05	0,10	0,08	0,06	0,11	0,09	0,07	0,13	0,10	0,08	●		
M.1.1	0,09	0,07	0,04	0,10	0,07	0,05	0,10	0,08	0,05	0,10	0,08	0,06	0,11	0,09	0,07	0,13	0,10	0,08	●		
M.2.1	0,09	0,07	0,04	0,10	0,07	0,05	0,10	0,08	0,05	0,10	0,08	0,06	0,11	0,09	0,07	0,13	0,10	0,08	●		
M.3.1	0,09	0,07	0,04	0,10	0,07	0,05	0,10	0,08	0,05	0,10	0,08	0,06	0,11	0,09	0,07	0,13	0,10	0,08	●		
K.1.1	0,18	0,13	0,09	0,19	0,14	0,10	0,19	0,15	0,11	0,20	0,16	0,12	0,22	0,18	0,14	0,25	0,20	0,16	○	●	○
K.1.2	0,18	0,13	0,09	0,19	0,14	0,10	0,19	0,15	0,11	0,20	0,16	0,12	0,22	0,18	0,14	0,25	0,20	0,16	○	●	○
K.2.1	0,15	0,11	0,08	0,17	0,12	0,08	0,16	0,13	0,09	0,17	0,14	0,11	0,19	0,16	0,12	0,21	0,17	0,14	○	●	○
K.2.2	0,15	0,11	0,08	0,17	0,12	0,08	0,16	0,13	0,09	0,17	0,14	0,11	0,19	0,16	0,12	0,21	0,17	0,14	○	●	○
K.3.1	0,13	0,09	0,06	0,14	0,10	0,07	0,14	0,11	0,08	0,14	0,11	0,09	0,16	0,13	0,10	0,18	0,15	0,11	○	●	○
K.3.2	0,13	0,09	0,06	0,14	0,10	0,07	0,14	0,11	0,08	0,14	0,11	0,09	0,16	0,13	0,10	0,18	0,15	0,11	○	●	○
N.1.1																					
N.1.2																					
N.2.1																					
N.2.2																					
N.2.3																					
N.3.1	0,14	0,10	0,07	0,15	0,11	0,08	0,15	0,12	0,08	0,15	0,13	0,10	0,18	0,14	0,11	0,20	0,16	0,12	●		○
N.3.2	0,15	0,11	0,08	0,17	0,12	0,08	0,16	0,13	0,09	0,17	0,14	0,11	0,19	0,16	0,12	0,21	0,17	0,14	●		○
N.3.3	0,15	0,11	0,08	0,17	0,12	0,08	0,16	0,13	0,09	0,17	0,14	0,11	0,19	0,16	0,12	0,21	0,17	0,14	●		○
N.4.1																					
S.1.1	0,07	0,05	0,04	0,08	0,06	0,04	0,08	0,06	0,04	0,08	0,06	0,05	0,09	0,07	0,06	0,10	0,08	0,06	●		
S.1.2	0,07	0,05	0,04	0,08	0,06	0,04	0,08	0,06	0,04	0,08	0,06	0,05	0,09	0,07	0,06	0,10	0,08	0,06	●		
S.2.1	0,08	0,06	0,04	0,09	0,07	0,04	0,09	0,07	0,05	0,09	0,07	0,06	0,10	0,08	0,06	0,11	0,09	0,07	●		
S.2.2	0,07	0,05	0,04	0,08	0,06	0,04	0,08	0,06	0,04	0,08	0,06	0,05	0,09	0,07	0,06	0,10	0,08	0,06	●		
S.2.3	0,07	0,05	0,04	0,08	0,03	0,04	0,08	0,06	0,04	0,08	0,06	0,05	0,09	0,07	0,06	0,10	0,08	0,06	●		
S.3.1	0,11	0,08	0,06	0,12	0,09	0,06	0,12	0,10	0,07	0,12	0,10	0,08	0,14	0,12	0,09	0,16	0,13	0,10	●		
S.3.2	0,11	0,08	0,06	0,12	0,09	0,06	0,12	0,09	0,07	0,12	0,10	0,08	0,14	0,11	0,09	0,16	0,13	0,10	●		
S.3.3	0,10	0,08	0,05	0,11	0,08	0,06	0,11	0,09	0,06	0,11	0,09	0,07	0,13	0,10	0,08	0,14	0,12	0,09	●		
H.1.1	0,08	0,06	0,04	0,09	0,07	0,04	0,09	0,07	0,05	0,09	0,07	0,06	0,10	0,08	0,06	0,11	0,09	0,07		●	
H.1.2	0,07	0,05	0,04	0,08	0,06	0,04	0,08	0,06	0,04	0,08	0,06	0,05	0,09	0,07	0,06	0,10	0,08	0,06		●	
H.1.3																					
H.1.4																					
H.2.1	0,09	0,07	0,05	0,10	0,07	0,05	0,10	0,08	0,05	0,10	0,08	0,06	0,11	0,09	0,07	0,13	0,11	0,08		●	
H.3.1	0,08	0,06	0,04	0,09	0,07	0,04	0,09	0,07	0,05	0,09	0,07	0,06	0,10	0,08	0,06	0,11	0,09	0,07		●	
O.1.1	0,30	0,22	0,15	0,33	0,25	0,17	0,33	0,26	0,18	0,33	0,27	0,21	0,38	0,31	0,24	0,43	0,35	0,27	●		○
O.1.2																					
O.2.1																					
O.2.2																					
O.3.1																					

Cutting data standard values – MonsterMill – SCR – Torus face cutter, long

Index	v _c (m/min)	Type long a _{p,max} x DC	52 609 ...														
			Ø DC (mm) =														
			3			4			5			6			8		
			a _s 0,1–0,2 x DC	a _s 0,3–0,4 x DC	a _s 0,6–1,0 x DC	a _s 0,1–0,2 x DC	a _s 0,3–0,4 x DC	a _s 0,6–1,0 x DC	a _s 0,1–0,2 x DC	a _s 0,3–0,4 x DC	a _s 0,6–1,0 x DC	a _s 0,1–0,2 x DC	a _s 0,3–0,4 x DC	a _s 0,6–1,0 x DC	a _s 0,1–0,2 x DC	a _s 0,3–0,4 x DC	a _s 0,6–1,0 x DC
f _z (mm)																	
P.1.1	150	1,0	0,019	0,017	0,012	0,029	0,022	0,016	0,040	0,030	0,020	0,048	0,036	0,024	0,06	0,05	0,03
P.1.2	130	1,0	0,014	0,012	0,009	0,022	0,017	0,012	0,030	0,022	0,015	0,036	0,027	0,018	0,05	0,04	0,02
P.1.3	130	1,0	0,014	0,012	0,009	0,022	0,017	0,012	0,030	0,022	0,015	0,036	0,027	0,018	0,05	0,04	0,02
P.1.4	140	1,0	0,019	0,017	0,012	0,022	0,017	0,012	0,030	0,022	0,015	0,036	0,027	0,018	0,05	0,04	0,02
P.1.5	140	1,0	0,019	0,017	0,012	0,022	0,017	0,012	0,030	0,022	0,015	0,036	0,027	0,018	0,05	0,04	0,02
P.2.1	150	1,0	0,024	0,021	0,015	0,029	0,022	0,016	0,040	0,030	0,020	0,048	0,036	0,024	0,06	0,05	0,03
P.2.2	150	1,0	0,019	0,017	0,012	0,029	0,022	0,016	0,040	0,030	0,020	0,048	0,036	0,024	0,06	0,05	0,03
P.2.3	130	1,0	0,014	0,012	0,009	0,022	0,017	0,012	0,030	0,022	0,015	0,036	0,027	0,018	0,05	0,04	0,02
P.2.4	130	1,0	0,014	0,012	0,009	0,022	0,017	0,012	0,030	0,022	0,015	0,036	0,027	0,018	0,05	0,04	0,02
P.3.1	130	1,0	0,014	0,012	0,009	0,022	0,017	0,012	0,030	0,022	0,015	0,036	0,027	0,018	0,05	0,04	0,02
P.3.2	150	1,0	0,024	0,021	0,015	0,029	0,022	0,016	0,040	0,030	0,020	0,048	0,036	0,024	0,06	0,05	0,03
P.3.3	130	1,0	0,014	0,012	0,009	0,022	0,017	0,012	0,030	0,022	0,015	0,036	0,027	0,018	0,05	0,04	0,02
P.4.1																	
P.4.2																	
M.1.1																	
M.2.1																	
M.3.1																	
K.1.1	170	1,0	0,028	0,025	0,018	0,043	0,033	0,024	0,056	0,042	0,028	0,072	0,054	0,036	0,10	0,07	0,05
K.1.2	170	1,0	0,028	0,025	0,018	0,043	0,033	0,024	0,056	0,042	0,028	0,072	0,054	0,036	0,10	0,07	0,05
K.2.1	150	1,0	0,024	0,021	0,015	0,036	0,028	0,020	0,046	0,034	0,023	0,060	0,045	0,030	0,08	0,06	0,04
K.2.2	150	1,0	0,024	0,021	0,015	0,036	0,028	0,020	0,046	0,034	0,023	0,060	0,045	0,030	0,08	0,06	0,04
K.3.1	80	1,0	0,014	0,012	0,009	0,022	0,017	0,012	0,030	0,022	0,015	0,036	0,027	0,018	0,05	0,04	0,02
K.3.2	80	1,0	0,014	0,012	0,009	0,022	0,017	0,012	0,030	0,022	0,015	0,036	0,027	0,018	0,05	0,04	0,02
N.1.1																	
N.1.2																	
N.2.1																	
N.2.2																	
N.2.3																	
N.3.1																	
N.3.2																	
N.3.3																	
N.4.1																	
S.1.1																	
S.1.2																	
S.2.1																	
S.2.2																	
S.2.3																	
S.3.1																	
S.3.2																	
S.3.3																	
H.1.1	80	0,3	0,014	0,012	0,009	0,022	0,017	0,012	0,030	0,022	0,015	0,036	0,027	0,018	0,05	0,04	0,02
H.1.2	60	0,15	0,009	0,008	0,006	0,014	0,011	0,008	0,020	0,015	0,010	0,024	0,018	0,012	0,03	0,02	0,02
H.1.3																	
H.1.4																	
H.2.1	100	0,5	0,014	0,012	0,009	0,022	0,017	0,012	0,030	0,022	0,015	0,036	0,027	0,018	0,05	0,04	0,02
H.3.1	80	0,3	0,014	0,012	0,009	0,022	0,017	0,012	0,030	0,022	0,015	0,036	0,027	0,018	0,05	0,04	0,02
O.1.1																	
O.1.2																	
O.2.1																	
O.2.2																	
O.3.1																	

Index	52 609 ...									● 1st choice		
	Ø DC (mm) =									○ suitable		
	10			12			16			Emulsion	Compressed air	MMS
	a_p 0,1-0,2 x DC	a_p 0,3-0,4 x DC	a_p 0,6-1,0 x DC	a_p 0,1-0,2 x DC	a_p 0,3-0,4 x DC	a_p 0,6-1,0 x DC	a_p 0,1-0,2 x DC	a_p 0,3-0,4 x DC	a_p 0,6-1,0 x DC			
f_z (mm)												
P.1.1	0,08	0,06	0,04	0,10	0,07	0,05	0,11	0,08	0,06	○	●	
P.1.2	0,06	0,05	0,03	0,07	0,05	0,04	0,08	0,06	0,05	○	●	
P.1.3	0,06	0,05	0,03	0,07	0,05	0,04	0,08	0,06	0,05	○	●	
P.1.4	0,06	0,05	0,03	0,07	0,05	0,04	0,08	0,06	0,05	○	●	
P.1.5	0,06	0,05	0,03	0,07	0,05	0,04	0,08	0,06	0,05	○	●	
P.2.1	0,08	0,06	0,04	0,10	0,07	0,05	0,11	0,08	0,06	○	●	
P.2.2	0,08	0,06	0,04	0,10	0,07	0,05	0,11	0,08	0,06	○	●	
P.2.3	0,06	0,05	0,03	0,07	0,05	0,04	0,08	0,06	0,05	○	●	
P.2.4	0,06	0,05	0,03	0,07	0,05	0,04	0,08	0,06	0,05	○	●	
P.3.1	0,06	0,05	0,03	0,07	0,05	0,04	0,08	0,06	0,05	○	●	
P.3.2	0,08	0,06	0,04	0,10	0,07	0,05	0,11	0,08	0,06	○	●	
P.3.3	0,06	0,05	0,03	0,07	0,05	0,04	0,08	0,06	0,05	○	●	
P.4.1												
P.4.2												
M.1.1												
M.2.1												
M.3.1												
K.1.1	0,12	0,09	0,06	0,14	0,11	0,07	0,15	0,12	0,09	○	●	
K.1.2	0,12	0,09	0,06	0,14	0,11	0,07	0,15	0,12	0,09	○	●	
K.2.1	0,10	0,08	0,05	0,12	0,09	0,06	0,14	0,10	0,08	○	●	
K.2.2	0,10	0,08	0,05	0,12	0,09	0,06	0,14	0,10	0,08	○	●	
K.3.1	0,06	0,05	0,03	0,07	0,05	0,04	0,08	0,06	0,05	○	●	
K.3.2	0,06	0,05	0,03	0,07	0,05	0,04	0,08	0,06	0,05	○	●	
N.1.1												
N.1.2												
N.2.1												
N.2.2												
N.2.3												
N.3.1												
N.3.2												
N.3.3												
N.4.1												
S.1.1												
S.1.2												
S.2.1												
S.2.2												
S.2.3												
S.3.1												
S.3.2												
S.3.3												
H.1.1	0,06	0,05	0,03	0,07	0,05	0,04	0,08	0,06	0,05		●	
H.1.2	0,04	0,03	0,02	0,05	0,04	0,02	0,05	0,04	0,03		●	
H.1.3												
H.1.4												
H.2.1	0,06	0,05	0,03	0,07	0,05	0,04	0,08	0,06	0,05		●	
H.3.1	0,06	0,05	0,03	0,07	0,05	0,04	0,08	0,06	0,05		●	
O.1.1												
O.1.2												
O.2.1												
O.2.2												
O.3.1												

Cutting data standard values – MonsterMill – SCR – Torus face cutter, HSC machining

Index	v _c (m/min)	a _p	a _e	52 609 ...								● 1st choice ○ suitable		
				Ø DC (mm) =								Emulsion	Compressed air	MMS
				3	4	5	6	8	10	12	16			
				f _z (mm)										
P.1.1	200	0,04	0,5	0,090	0,120	0,150	0,180	0,24	0,30	0,36	0,48	○	●	
P.1.2	170	0,03	0,3	0,066	0,090	0,110	0,132	0,18	0,22	0,26	0,35	○	●	
P.1.3	170	0,03	0,3	0,066	0,090	0,110	0,132	0,18	0,22	0,26	0,35	○	●	
P.1.4	190	0,03	0,4	0,072	0,100	0,120	0,144	0,19	0,24	0,29	0,38	○	●	
P.1.5	190	0,03	0,4	0,072	0,100	0,120	0,144	0,19	0,24	0,29	0,38	○	●	
P.2.1	200	0,04	0,5	0,090	0,120	0,150	0,180	0,24	0,30	0,36	0,48	○	●	
P.2.2	200	0,04	0,5	0,090	0,120	0,150	0,180	0,24	0,30	0,36	0,48	○	●	
P.2.3	170	0,03	0,3	0,066	0,090	0,110	0,132	0,18	0,22	0,26	0,35	○	●	
P.2.4	170	0,03	0,3	0,066	0,090	0,110	0,132	0,18	0,22	0,26	0,35	○	●	
P.3.1	170	0,03	0,3	0,066	0,090	0,110	0,132	0,18	0,22	0,26	0,35	○	●	
P.3.2	200	0,04	0,5	0,090	0,120	0,150	0,180	0,24	0,30	0,36	0,48	○	●	
P.3.3	170	0,03	0,3	0,066	0,090	0,110	0,132	0,18	0,22	0,26	0,35	○	●	
P.4.1														
P.4.2														
M.1.1														
M.2.1														
M.3.1														
K.1.1	230	0,05	0,6	0,120	0,160	0,200	0,240	0,32	0,40	0,48	0,64	○	●	
K.1.2	230	0,05	0,6	0,120	0,160	0,200	0,240	0,32	0,40	0,48	0,64	○	●	
K.2.1	200	0,04	0,5	0,096	0,130	0,160	0,192	0,26	0,32	0,38	0,51	○	●	
K.2.2	200	0,04	0,5	0,096	0,130	0,160	0,192	0,26	0,32	0,38	0,51	○	●	
K.3.1	100	0,03	0,4	0,072	0,100	0,120	0,144	0,19	0,24	0,29	0,38	○	●	
K.3.2	100	0,03	0,4	0,072	0,100	0,120	0,144	0,19	0,24	0,29	0,38	○	●	
N.1.1														
N.1.2														
N.2.1														
N.2.2														
N.2.3														
N.3.1														
N.3.2														
N.3.3														
N.4.1														
S.1.1														
S.1.2														
S.2.1														
S.2.2														
S.2.3														
S.3.1														
S.3.2														
S.3.3														
H.1.1	100	0,03	0,3	0,060	0,080	0,100	0,120	0,16	0,20	0,24	0,32		●	
H.1.2	90	0,02	0,3	0,048	0,064	0,080	0,096	0,13	0,16	0,19	0,26		●	
H.1.3	80	0,02	0,2	0,024	0,056	0,070	0,084	0,11	0,14	0,17	0,22		●	
H.1.4	60	0,02	0,2	0,036	0,048	0,060	0,072	0,10	0,12	0,14	0,19		●	
H.2.1	130	0,03	0,4	0,072	0,100	0,120	0,144	0,19	0,24	0,29	0,38		●	
H.3.1	100	0,03	0,3	0,060	0,080	0,100	0,120	0,16	0,20	0,24	0,32		●	
O.1.1														
O.1.2														
O.2.1														
O.2.2														
O.3.1														

Cutting data standard values – MonsterMill – FRP CR fine pitched

Index	Compressed air	Type long	52 598 ...					● 1st choice ○ suitable		
			∅ DC (mm) =					Emulsion	Compressed air	MMS
			> ∅ 5 ≤ ∅ 6	> ∅ 6 ≤ ∅ 8	> ∅ 8 ≤ ∅ 10	> ∅ 10 ≤ ∅ 12	> ∅ 12 ≤ ∅ 14			
			a_e 0,6–1,0 x DC	a_e 0,6–1,0 x DC	a_e 0,6–1,0 x DC	a_e 0,6–1,0 x DC	a_e 0,6–1,0 x DC			
v_c (m/min)	$a_{p,max.} \times DC$	f (mm/rev)								
O.1.1										
O.1.2										
O.2.1										
O.2.2	200	1,0	0,125	0,150	0,175	0,200	0,225		●	
O.3.1										

 For the MonsterMill FRP CR cutters, the feed rate must be selected in mm/rev.

Cutting data standard values – MonsterMill – FRP CR coarse pitched

Index	Compressed air	Type long	52 599 ...					● 1st choice ○ suitable		
			∅ DC (mm) =					Emulsion	Compressed air	MMS
			> ∅ 5 ≤ ∅ 6	> ∅ 6 ≤ ∅ 8	> ∅ 8 ≤ ∅ 10	> ∅ 10 ≤ ∅ 12	> ∅ 12 ≤ ∅ 14			
			a_e 0,6–1,0 x DC	a_e 0,6–1,0 x DC	a_e 0,6–1,0 x DC	a_e 0,6–1,0 x DC	a_e 0,6–1,0 x DC			
v_c (m/min)	$a_{p,max.} \times DC$	f (mm/rev)								
O.1.1										
O.1.2										
O.2.1										
O.2.2	200	1,5	0,100	0,120	0,140	0,160	0,180		●	
O.3.1										

 For the MonsterMill FRP CR cutters, the feed rate must be selected in mm/rev.

Cutting data standard values – MonsterMill – FRP

Index	Compressed air	Type long	52 595 ..., 52 596 ..., 52 597 ...					● 1st choice ○ suitable		
			∅ DC (mm) =					Emulsion	Compressed air	MMS
			> ∅ 5 ≤ ∅ 6	> ∅ 6 ≤ ∅ 8	> ∅ 8 ≤ ∅ 10	> ∅ 10 ≤ ∅ 12	> ∅ 12 ≤ ∅ 14			
			a_e 0,6–1,0 x DC	a_e 0,6–1,0 x DC	a_e 0,6–1,0 x DC	a_e 0,6–1,0 x DC	a_e 0,6–1,0 x DC			
v_c (m/min)	$a_{p,max.} \times DC$	f (mm/rev)								
O.1.1										
O.1.2										
O.2.1										
O.2.2	200	1,0	0,018	0,022	0,026	0,03	0,034		●	
O.3.1										

 The optimum usage recommendations may differ from those provided here depending on the machining process and application. Please get in touch with your contact at CERATIZIT to determine the best recommendation for your application.

Cutting data standard values – MonsterMill – ICR – End mill, short

Index	Emulsion	Compressed air	MMS	Type short	52 784 ...									● 1st choice ○ suitable				
					Ø DC (mm) =									Emulsion	Compressed air	MMS		
					1,5			2			2,5							
					a_p 0,1-0,2 x DC	a_p 0,3-0,4 x DC	a_p 0,6-1,0 x DC	a_p 0,1-0,2 x DC	a_p 0,3-0,4 x DC	a_p 0,6-1,0 x DC	a_p 0,1-0,2 x DC	a_p 0,3-0,4 x DC	a_p 0,6-1,0 x DC				f_z (mm)	
v_c (m/min)				$a_{p,max}$ x DC														
P.1.1	140	130		0,25	0,014	0,013	0,010	0,020	0,019	0,014	0,029	0,024	0,018	○	●	○		
P.1.2	140	130		0,25	0,014	0,013	0,010	0,018	0,017	0,013	0,026	0,022	0,016	○	●	○		
P.1.3	140	130		0,25	0,014	0,013	0,010	0,018	0,017	0,013	0,026	0,022	0,016	○	●	○		
P.1.4	140	130		0,25	0,014	0,013	0,010	0,018	0,017	0,013	0,026	0,022	0,016	○	●	○		
P.1.5	140	130		0,25	0,014	0,013	0,010	0,018	0,017	0,013	0,026	0,022	0,016	○	●	○		
P.2.1	120			0,25	0,014	0,013	0,010	0,018	0,017	0,013	0,026	0,022	0,016	○	●	○		
P.2.2	120	110		0,25	0,014	0,013	0,010	0,018	0,017	0,013	0,026	0,022	0,016	○	●	○		
P.2.3	80	90		0,25	0,013	0,012	0,009	0,016	0,015	0,011	0,024	0,020	0,015	○	●	○		
P.2.4	80	90		0,25	0,013	0,012	0,009	0,016	0,015	0,011	0,024	0,020	0,015	○	●	○		
P.3.1	80	90		0,25	0,011	0,010	0,008	0,014	0,013	0,010	0,021	0,017	0,013	○	●	○		
P.3.2	80	90		0,25	0,011	0,010	0,008	0,014	0,013	0,010	0,021	0,017	0,013	○	●	○		
P.3.3	100	110		0,25	0,011	0,010	0,008	0,014	0,013	0,010	0,021	0,017	0,013	○	●	○		
P.4.1	100			0,25	0,009	0,008	0,006	0,013	0,012	0,009	0,019	0,016	0,012	●				
P.4.2	100			0,25	0,009	0,008	0,006	0,013	0,012	0,009	0,019	0,016	0,012	●				
M.1.1	100			0,25	0,009	0,008	0,006	0,013	0,012	0,009	0,019	0,016	0,012	●				
M.2.1	80			0,25	0,009	0,008	0,006	0,013	0,012	0,009	0,019	0,016	0,012	●				
M.3.1	100			0,25	0,009	0,008	0,006	0,013	0,012	0,009	0,019	0,016	0,012	●				
K.1.1		180		0,25	0,020	0,019	0,014	0,025	0,024	0,018	0,036	0,030	0,022		●			
K.1.2		160		0,25	0,020	0,019	0,014	0,025	0,024	0,018	0,036	0,030	0,022		●			
K.2.1		180		0,25	0,016	0,015	0,011	0,022	0,020	0,015	0,031	0,026	0,019		●			
K.2.2		160		0,25	0,016	0,015	0,011	0,022	0,020	0,015	0,031	0,026	0,019		●			
K.3.1		120		0,25	0,014	0,013	0,010	0,018	0,017	0,013	0,026	0,022	0,016		●			
K.3.2		120		0,25	0,014	0,013	0,010	0,018	0,017	0,013	0,026	0,022	0,016		●			
N.1.1																		
N.1.2																		
N.2.1																		
N.2.2																		
N.2.3																		
N.3.1	280	280		0,25	0,007	0,007	0,005	0,020	0,019	0,014	0,029	0,024	0,018	●		○		
N.3.2	220	220		0,25	0,016	0,015	0,011	0,022	0,020	0,015	0,031	0,026	0,019	●		○		
N.3.3	220	220		0,25	0,016	0,015	0,011	0,022	0,020	0,015	0,031	0,026	0,019	●		○		
N.4.1																		
S.1.1	45			0,25	0,009	0,008	0,006	0,013	0,012	0,009	0,019	0,012	0,012	●				
S.1.2	45			0,25	0,009	0,008	0,006	0,013	0,012	0,009	0,019	0,012	0,012	●				
S.2.1	25			0,25	0,011	0,010	0,008	0,014	0,013	0,010	0,021	0,017	0,013	●				
S.2.2	30			0,25	0,009	0,008	0,006	0,013	0,012	0,009	0,019	0,012	0,012	●				
S.2.3	25			0,25	0,011	0,010	0,008	0,014	0,013	0,010	0,021	0,017	0,013	●				
S.3.1	80			0,25	0,013	0,012	0,009	0,016	0,015	0,011	0,024	0,020	0,015	●				
S.3.2	60			0,25	0,014	0,013	0,010	0,018	0,017	0,013	0,026	0,022	0,016	●				
S.3.3	60			0,25	0,014	0,013	0,010	0,018	0,017	0,013	0,026	0,022	0,016	●				
H.1.1		80		0,20	0,011	0,010	0,008	0,014	0,013	0,010	0,021	0,017	0,013		●			
H.1.2		60		0,15	0,009	0,008	0,006	0,013	0,012	0,009	0,019	0,016	0,012		●			
H.1.3																		
H.1.4																		
H.2.1		80		0,25	0,013	0,012	0,009	0,016	0,015	0,011	0,024	0,020	0,015		●			
H.3.1		80		0,20	0,011	0,010	0,008	0,014	0,013	0,010	0,021	0,017	0,013		●			
O.1.1	300	300		0,25	0,029	0,027	0,020	0,043	0,040	0,030	0,051	0,043	0,032	●		○		
O.1.2																		
O.2.1																		
O.2.2																		
O.3.1																		

 Plunging angle for ramping and helical milling: No. of teeth 3 = 5°/No. of teeth 4 = 4°/No. of teeth 5 = 3°

Cutting data standard values – MonsterMill – ICR – End mill, short – long

Index	Emulsion	Compressed air	MMS	Type short	Type long	52 784 ..., 52 786 ...											● 1st choice ○ suitable			
						Ø DC (mm) =											Emulsion	Compressed air	MMS	
						3			4			5			6					
						a_p 0,1–0,2 x DC	a_p 0,3–0,4 x DC	a_p 0,6–1,0 x DC	a_p 0,1–0,2 x DC	a_p 0,3–0,4 x DC	a_p 0,6–1,0 x DC	a_p 0,1–0,2 x DC	a_p 0,3–0,4 x DC	a_p 0,6–1,0 x DC	a_p 0,1–0,2 x DC	a_p 0,3–0,4 x DC				a_p 0,6–1,0 x DC
v_c (m/min)					$a_{p,max}$ x DC					f_z (mm)										
P.1.1	140	130		1,0	1,0*	0,038	0,029	0,021	0,049	0,038	0,028	0,063	0,049	0,035	0,074	0,057	0,041	○	●	○
P.1.2	140	130		1,0	1,0*	0,034	0,026	0,019	0,045	0,035	0,025	0,056	0,043	0,031	0,067	0,052	0,038	○	●	○
P.1.3	140	130		1,0	1,0*	0,034	0,026	0,019	0,045	0,035	0,025	0,056	0,043	0,031	0,067	0,052	0,038	○	●	○
P.1.4	140	130		1,0	1,0*	0,034	0,026	0,019	0,045	0,035	0,025	0,056	0,043	0,031	0,067	0,052	0,038	○	●	○
P.1.5	140	130		1,0	1,0*	0,034	0,026	0,019	0,045	0,035	0,025	0,056	0,043	0,031	0,067	0,052	0,038	○	●	○
P.2.1	120	110		1,0	1,0*	0,034	0,026	0,019	0,045	0,035	0,025	0,056	0,043	0,031	0,067	0,052	0,038	○	●	○
P.2.2	120	110		1,0	1,0*	0,034	0,026	0,019	0,045	0,035	0,025	0,056	0,043	0,031	0,067	0,052	0,038	○	●	○
P.2.3	80	90		1,0	1,0*	0,031	0,024	0,018	0,063	0,049	0,035	0,052	0,040	0,029	0,061	0,047	0,034	○	●	○
P.2.4	80	90		1,0	1,0*	0,031	0,024	0,018	0,063	0,049	0,035	0,052	0,040	0,029	0,061	0,047	0,034	○	●	○
P.3.1	80	90		1,0	1,0*	0,027	0,021	0,015	0,036	0,028	0,020	0,045	0,035	0,025	0,054	0,042	0,030	○	●	○
P.3.2	80	90		1,0	1,0*	0,027	0,021	0,015	0,036	0,028	0,020	0,045	0,035	0,025	0,054	0,042	0,030	○	●	○
P.3.3	100	110		1,0	1,0*	0,027	0,021	0,015	0,036	0,028	0,020	0,045	0,035	0,025	0,054	0,042	0,030	○	●	○
P.4.1	100			1,0	1,0*	0,025	0,019	0,014	0,031	0,024	0,018	0,040	0,031	0,023	0,047	0,036	0,026	●		
P.4.2	100			1,0	1,0*	0,025	0,019	0,014	0,031	0,024	0,018	0,040	0,031	0,023	0,047	0,036	0,026	●		
M.1.1	100			1,0	1,0*	0,025	0,019	0,014	0,031	0,024	0,018	0,040	0,031	0,023	0,047	0,036	0,026	●		
M.2.1	80			1,0	1,0*	0,025	0,019	0,014	0,031	0,024	0,018	0,040	0,031	0,023	0,047	0,036	0,026	●		
M.3.1	100			1,0	1,0*	0,025	0,019	0,014	0,031	0,024	0,018	0,040	0,031	0,023	0,047	0,036	0,026	●		
K.1.1		180		1,0	1,0*	0,047	0,036	0,026	0,063	0,049	0,035	0,079	0,061	0,044	0,094	0,073	0,053		●	
K.1.2		160		1,0	1,0*	0,047	0,036	0,026	0,063	0,049	0,035	0,079	0,061	0,044	0,094	0,073	0,053		●	
K.2.1		180		1,0	1,0*	0,040	0,031	0,023	0,054	0,042	0,030	0,067	0,052	0,038	0,081	0,062	0,045		●	
K.2.2		160		1,0	1,0*	0,040	0,031	0,023	0,054	0,042	0,030	0,067	0,052	0,038	0,081	0,062	0,045		●	
K.3.1		120		1,0	1,0*	0,034	0,026	0,019	0,045	0,035	0,025	0,056	0,043	0,031	0,067	0,052	0,038		●	
K.3.2		120		1,0	1,0*	0,034	0,026	0,019	0,045	0,035	0,025	0,056	0,043	0,031	0,067	0,052	0,038		●	
N.1.1																				
N.1.2																				
N.2.1																				
N.2.2																				
N.2.3																				
N.3.1	280	280		1,0	1,0*	0,038	0,029	0,021	0,049	0,038	0,028	0,063	0,049	0,035	0,741	0,572	0,413	●		○
N.3.2	220	220		1,0	1,0*	0,040	0,031	0,023	0,054	0,042	0,030	0,067	0,052	0,038	0,081	0,062	0,045	●		○
N.3.3	220	220		1,0	1,0*	0,040	0,031	0,023	0,054	0,042	0,030	0,067	0,052	0,038	0,081	0,062	0,045	●		○
N.4.1																				
S.1.1	45			0,5	0,5	0,025	0,012	0,014	0,031	0,024	0,018	0,040	0,031	0,023	0,047	0,036	0,026	●		
S.1.2	45			0,5	0,5	0,025	0,012	0,014	0,031	0,024	0,018	0,040	0,031	0,023	0,047	0,036	0,026	●		
S.2.1	25			0,5	0,5	0,027	0,021	0,015	0,036	0,028	0,020	0,045	0,035	0,025	0,054	0,042	0,030	●		
S.2.2	30			0,5	0,5	0,025	0,012	0,014	0,031	0,024	0,018	0,040	0,031	0,023	0,047	0,036	0,026	●		
S.2.3	25			0,5	0,5	0,027	0,021	0,015	0,036	0,028	0,020	0,045	0,035	0,025	0,054	0,042	0,030	●		
S.3.1	80			0,5	0,5	0,031	0,024	0,018	0,040	0,031	0,023	0,052	0,040	0,029	0,061	0,047	0,034	●		
S.3.2	60			0,5	0,5	0,034	0,026	0,019	0,045	0,035	0,025	0,056	0,043	0,031	0,067	0,052	0,038	●		
S.3.3	60			0,5	0,5	0,034	0,026	0,019	0,045	0,035	0,025	0,056	0,043	0,031	0,067	0,052	0,038	●		
H.1.1		80		0,3	0,3	0,027	0,021	0,015	0,036	0,028	0,020	0,045	0,035	0,025	0,054	0,042	0,030		●	
H.1.2		60		0,15	0,15	0,025	0,019	0,014	0,031	0,024	0,018	0,040	0,031	0,023	0,047	0,036	0,026		●	
H.1.3																				
H.1.4																				
H.2.1		80		0,5	0,5	0,031	0,024	0,018	0,040	0,031	0,023	0,052	0,040	0,029	0,061	0,047	0,034		●	
H.3.1		80		0,3	0,3	0,027	0,021	0,015	0,036	0,028	0,020	0,045	0,035	0,025	0,054	0,042	0,030		●	
O.1.1	300	300		1,0	1,0*	0,058	0,045	0,033	0,108	0,083	0,060	0,135	0,104	0,075	0,162	0,125	0,090	●		○
O.1.2																				
O.2.1																				
O.2.2																				
O.3.1																				

* = with an a_p of 1.5 x d_1 the f_z should be multiplied by 0.8

Cutting data standard values – MonsterMill – ICR – End mill, short – long

Index	Emulsion	Compressed air	MMS	Type short	Type long	52 784 ..., 52 786 ...											
						Ø DC (mm) =											
						8			10			12			14		
						a_p 0,1-0,2 x DC	a_p 0,3-0,4 x DC	a_p 0,6-1,0 x DC	a_p 0,1-0,2 x DC	a_p 0,3-0,4 x DC	a_p 0,6-1,0 x DC	a_p 0,1-0,2 x DC	a_p 0,3-0,4 x DC	a_p 0,6-1,0 x DC	a_p 0,1-0,2 x DC	a_p 0,3-0,4 x DC	a_p 0,6-1,0 x DC
v_c (m/min)					$a_{p,max}$ x DC					f_z (mm)							
P.1.1	140	130		1,0	1,0*	0,10	0,08	0,06	0,12	0,10	0,07	0,15	0,11	0,08	0,17	0,13	0,10
P.1.2	140	130		1,0	1,0*	0,09	0,07	0,05	0,12	0,09	0,07	0,14	0,10	0,08	0,16	0,12	0,09
P.1.3	140	130		1,0	1,0*	0,09	0,07	0,05	0,12	0,09	0,07	0,14	0,10	0,08	0,16	0,12	0,09
P.1.4	140	130		1,0	1,0*	0,09	0,07	0,05	0,12	0,09	0,07	0,14	0,10	0,08	0,16	0,12	0,09
P.1.5	140	130		1,0	1,0*	0,09	0,07	0,05	0,12	0,09	0,07	0,14	0,10	0,08	0,16	0,12	0,09
P.2.1	120	110		1,0	1,0*	0,09	0,07	0,05	0,12	0,09	0,07	0,14	0,10	0,08	0,16	0,12	0,09
P.2.2	120	110		1,0	1,0*	0,09	0,07	0,05	0,12	0,09	0,07	0,14	0,10	0,08	0,16	0,12	0,09
P.2.3	80	90		1,0	1,0*	0,08	0,06	0,05	0,11	0,09	0,06	0,12	0,09	0,07	0,14	0,11	0,08
P.2.4	80	90		1,0	1,0*	0,08	0,06	0,05	0,11	0,09	0,06	0,12	0,09	0,07	0,14	0,11	0,08
P.3.1	80	90		1,0	1,0*	0,07	0,06	0,04	0,09	0,07	0,05	0,11	0,08	0,06	0,13	0,10	0,07
P.3.2	80	90		1,0	1,0*	0,07	0,06	0,04	0,09	0,07	0,05	0,11	0,08	0,06	0,13	0,10	0,07
P.3.3	100	110		1,0	1,0*	0,07	0,06	0,04	0,09	0,07	0,05	0,11	0,08	0,06	0,13	0,10	0,07
P.4.1	100			1,0	1,0*	0,06	0,05	0,04	0,08	0,06	0,04	0,10	0,07	0,05	0,11	0,09	0,06
P.4.2	100			1,0	1,0*	0,06	0,05	0,04	0,08	0,06	0,04	0,10	0,07	0,05	0,11	0,09	0,06
M.1.1	100			1,0	1,0*	0,06	0,05	0,04	0,08	0,06	0,04	0,09	0,07	0,05	0,11	0,09	0,06
M.2.1	80			1,0	1,0*	0,06	0,05	0,04	0,08	0,06	0,04	0,09	0,07	0,05	0,11	0,09	0,06
M.3.1	100			1,0	1,0*	0,06	0,05	0,04	0,08	0,06	0,04	0,09	0,07	0,05	0,11	0,09	0,06
K.1.1		180		1,0	1,0*	0,13	0,10	0,07	0,14	0,10	0,08	0,16	0,13	0,09	0,22	0,17	0,12
K.1.2		160		1,0	1,0*	0,13	0,10	0,07	0,14	0,10	0,08	0,16	0,13	0,09	0,22	0,17	0,12
K.2.1		180		1,0	1,0*	0,11	0,08	0,06	0,14	0,10	0,08	0,14	0,11	0,08	0,19	0,15	0,11
K.2.2		160		1,0	1,0*	0,11	0,08	0,06	0,12	0,09	0,07	0,14	0,11	0,08	0,19	0,15	0,11
K.3.1		120		1,0	1,0*	0,09	0,07	0,05	0,11	0,09	0,06	0,14	0,10	0,08	0,16	0,12	0,09
K.3.2		120		1,0	1,0*	0,09	0,07	0,05	0,11	0,09	0,06	0,14	0,10	0,08	0,16	0,12	0,09
N.1.1																	
N.1.2																	
N.2.1																	
N.2.2																	
N.2.3																	
N.3.1	280	280		1,0	1,0*	0,10	0,08	0,06	0,12	0,10	0,07	0,15	0,11	0,08	0,17	0,13	0,10
N.3.2	220	220		1,0	1,0*	0,11	0,08	0,06	0,14	0,10	0,08	0,16	0,13	0,09	0,14	0,11	0,08
N.3.3	220	220		1,0	1,0*	0,11	0,08	0,06	0,14	0,10	0,08	0,16	0,13	0,09	0,14	0,11	0,08
N.4.1																	
S.1.1	45			0,5	0,5	0,06	0,05	0,04	0,08	0,06	0,04	0,09	0,07	0,05	0,11	0,09	0,06
S.1.2	45			0,5	0,5	0,06	0,05	0,04	0,08	0,06	0,04	0,09	0,07	0,05	0,11	0,09	0,06
S.2.1	25			0,5	0,5	0,07	0,06	0,04	0,09	0,07	0,05	0,11	0,08	0,06	0,13	0,10	0,07
S.2.2	30			0,5	0,5	0,06	0,05	0,04	0,08	0,06	0,04	0,09	0,07	0,05	0,11	0,09	0,06
S.2.3	25			0,5	0,5	0,07	0,06	0,04	0,09	0,07	0,05	0,11	0,05	0,06	0,13	0,10	0,07
S.3.1	80			0,5	0,5	0,08	0,06	0,05	0,10	0,08	0,06	0,12	0,09	0,07	0,14	0,11	0,08
S.3.2	60			0,5	0,5	0,09	0,07	0,05	0,11	0,09	0,06	0,14	0,10	0,08	0,16	0,12	0,09
S.3.3	60			0,5	0,5	0,09	0,07	0,05	0,11	0,09	0,06	0,14	0,10	0,08	0,16	0,12	0,09
H.1.1		80		0,3	0,3	0,07	0,06	0,04	0,09	0,07	0,05	0,11	0,08	0,06	0,13	0,10	0,07
H.1.2		60		0,15	0,15	0,06	0,05	0,04	0,08	0,06	0,04	0,09	0,07	0,05	0,11	0,09	0,06
H.1.3																	
H.1.4																	
H.2.1		80		0,5	0,5	0,08	0,06	0,05	0,10	0,08	0,06	0,12	0,09	0,07	0,14	0,11	0,08
H.3.1		80		0,3	0,3	0,07	0,06	0,04	0,09	0,07	0,05	0,11	0,08	0,06	0,13	0,10	0,07
O.1.1	300	300		1,0	1,0*	0,22	0,17	0,12	0,27	0,21	0,15	0,32	0,25	0,18	0,38	0,29	0,21
O.1.2																	
O.2.1																	
O.2.2																	
O.3.1																	

* = with an a_p of 1.5 x d_1 the f_z should be multiplied by 0.8

 Plunging angle for ramping and helical milling: No. of teeth 3 = 5 °/No. of teeth 4 = 4 °/No. of teeth 5 = 3 °

Index	52 784 ..., 52 786 ...									● 1st choice		
	Ø DC (mm) =									○ suitable		
	16			18			20			Emulsion	Compressed air	MMS
	a_p 0,1-0,2 x DC	a_p 0,3-0,4 x DC	a_p 0,6-1,0 x DC	a_p 0,1-0,2 x DC	a_p 0,3-0,4 x DC	a_p 0,6-1,0 x DC	a_p 0,1-0,2 x DC	a_p 0,3-0,4 x DC	a_p 0,6-1,0 x DC			
f_t (mm)												
P.1.1	0,18	0,14	0,11	0,19	0,16	0,12	0,20	0,17	0,14	○	●	○
P.1.2	0,16	0,13	0,10	0,17	0,15	0,11	0,18	0,16	0,13	○	●	○
P.1.3	0,16	0,13	0,10	0,17	0,15	0,11	0,18	0,16	0,13	○	●	○
P.1.4	0,16	0,13	0,10	0,17	0,15	0,11	0,18	0,16	0,13	○	●	○
P.1.5	0,16	0,13	0,10	0,17	0,15	0,11	0,18	0,16	0,13	○	●	○
P.2.1	0,16	0,13	0,10	0,17	0,15	0,11	0,18	0,16	0,13	○	●	○
P.2.2	0,16	0,13	0,10	0,17	0,15	0,11	0,18	0,16	0,13	○	●	○
P.2.3	0,14	0,12	0,09	0,15	0,13	0,10	0,16	0,14	0,11	○	●	○
P.2.4	0,14	0,12	0,09	0,15	0,13	0,10	0,16	0,14	0,11	○	●	○
P.3.1	0,13	0,10	0,08	0,14	0,12	0,09	0,14	0,13	0,10	○	●	○
P.3.2	0,13	0,10	0,08	0,14	0,12	0,09	0,14	0,13	0,10	○	●	○
P.3.3	0,13	0,10	0,08	0,14	0,12	0,09	0,14	0,13	0,10	○	●	○
P.4.1	0,11	0,09	0,07	0,12	0,10	0,08	0,13	0,11	0,09	●		
P.4.2	0,11	0,09	0,07	0,12	0,10	0,08	0,13	0,11	0,09	●		
M.1.1	0,11	0,09	0,07	0,12	0,10	0,08	0,13	0,11	0,09	●		
M.2.1	0,11	0,09	0,07	0,12	0,10	0,08	0,13	0,11	0,09	●		
M.3.1	0,11	0,09	0,07	0,12	0,10	0,08	0,13	0,11	0,09	●		
K.1.1	0,22	0,18	0,14	0,24	0,20	0,16	0,25	0,22	0,18		●	
K.1.2	0,22	0,18	0,14	0,24	0,20	0,16	0,25	0,22	0,18		●	
K.2.1	0,19	0,16	0,12	0,20	0,17	0,13	0,25	0,22	0,18		●	
K.2.2	0,19	0,16	0,12	0,20	0,17	0,13	0,22	0,19	0,15		●	
K.3.1	0,16	0,13	0,10	0,17	0,15	0,11	0,18	0,16	0,13		●	
K.3.2	0,16	0,13	0,10	0,17	0,15	0,11	0,18	0,16	0,13		●	
N.1.1												
N.1.2												
N.2.1												
N.2.2												
N.2.3												
N.3.1	0,18	0,14	0,11	0,19	0,16	0,12	0,20	0,17	0,14	●		○
N.3.2	0,19	0,16	0,12	0,21	0,17	0,14	0,22	0,19	0,15	●		○
N.3.3	0,19	0,16	0,12	0,21	0,17	0,14	0,22	0,19	0,15	●		○
N.4.1												
S.1.1	0,11	0,09	0,07	0,12	0,10	0,08	0,13	0,11	0,09	●		
S.1.2	0,11	0,09	0,07	0,12	0,10	0,08	0,13	0,11	0,09	●		
S.2.1	0,13	0,10	0,08	0,14	0,12	0,09	0,14	0,13	0,10	●		
S.2.2	0,11	0,09	0,07	0,12	0,10	0,08	0,13	0,11	0,09	●		
S.2.3	0,13	0,10	0,08	0,14	0,12	0,09	0,14	0,13	0,10	●		
S.3.1	0,14	0,12	0,09	0,15	0,13	0,10	0,16	0,14	0,11	●		
S.3.2	0,16	0,13	0,10	0,17	0,15	0,11	0,18	0,16	0,13	●		
S.3.3	0,16	0,13	0,10	0,17	0,15	0,11	0,18	0,16	0,13	●		
H.1.1	0,13	0,10	0,08	0,14	0,12	0,09	0,14	0,13	0,10		●	
H.1.2	0,11	0,09	0,07	0,12	0,10	0,08	0,13	0,11	0,09		●	
H.1.3												
H.1.4												
H.2.1	0,14	0,12	0,09	0,15	0,13	0,10	0,16	0,14	0,11		●	
H.3.1	0,13	0,10	0,08	0,14	0,12	0,09	0,14	0,13	0,10		●	
O.1.1	0,38	0,31	0,24	0,41	0,35	0,27	0,43	0,38	0,30	●		○
O.1.2												
O.2.1												
O.2.2												
O.3.1												

Cutting data standard values – MonsterMill – ICR– End mill, extra long

Index	Emulsion	Compressed air	MMS	Type extra long	52 784 ...														
					Ø DC (mm) =														
					3			4			5			6			8		
					a_p 0,1–0,2 x DC	a_p 0,3–0,4 x DC	a_p 0,6–1,0 x DC	a_p 0,1–0,2 x DC	a_p 0,3–0,4 x DC	a_p 0,6–1,0 x DC	a_p 0,1–0,2 x DC	a_p 0,3–0,4 x DC	a_p 0,6–1,0 x DC	a_p 0,1–0,2 x DC	a_p 0,3–0,4 x DC	a_p 0,6–1,0 x DC	a_p 0,1–0,2 x DC	a_p 0,3–0,4 x DC	a_p 0,6–1,0 x DC
	v_c (m/min)	$a_{p,max}$ x DC			f_z (mm)														
P.1.1	120	110	1,0	0,5	0,038	0,029	0,021	0,049	0,038	0,028	0,063	0,049	0,035	0,074	0,057	0,041	0,10	0,08	0,06
P.1.2	120	110	1,0	0,5	0,034	0,026	0,019	0,045	0,035	0,025	0,056	0,043	0,031	0,067	0,052	0,038	0,09	0,07	0,05
P.1.3	120	110	1,0	0,5	0,034	0,026	0,019	0,045	0,035	0,025	0,056	0,043	0,031	0,067	0,052	0,038	0,09	0,07	0,05
P.1.4	120	110	1,0	0,5	0,034	0,026	0,019	0,045	0,035	0,025	0,056	0,043	0,031	0,067	0,052	0,038	0,09	0,07	0,05
P.1.5	120	110	1,0	0,5	0,034	0,026	0,019	0,045	0,035	0,025	0,056	0,043	0,031	0,067	0,052	0,038	0,09	0,07	0,05
P.2.1	100	90	1,0	0,5	0,034	0,026	0,019	0,045	0,035	0,025	0,056	0,043	0,031	0,067	0,052	0,038	0,09	0,07	0,05
P.2.2	100	90	1,0	0,5	0,034	0,026	0,019	0,045	0,035	0,025	0,056	0,043	0,031	0,067	0,052	0,038	0,09	0,07	0,05
P.2.3	70	70	1,0	0,5	0,031	0,024	0,018	0,063	0,049	0,035	0,052	0,040	0,029	0,061	0,047	0,034	0,08	0,06	0,05
P.2.4	70	70	1,0	0,5	0,031	0,024	0,018	0,063	0,049	0,035	0,052	0,040	0,029	0,061	0,047	0,034	0,08	0,06	0,05
P.3.1	70	70	1,0	0,5	0,027	0,021	0,015	0,036	0,028	0,020	0,045	0,035	0,025	0,054	0,042	0,030	0,07	0,06	0,04
P.3.2	70	70	1,0	0,5	0,027	0,021	0,015	0,036	0,028	0,020	0,045	0,035	0,025	0,054	0,042	0,030	0,07	0,06	0,04
P.3.3	85	90	1,0	0,5	0,027	0,021	0,015	0,036	0,028	0,020	0,045	0,035	0,025	0,054	0,042	0,030	0,07	0,06	0,04
P.4.1	85		1,0	0,5	0,025	0,019	0,014	0,031	0,024	0,018	0,040	0,031	0,023	0,047	0,036	0,026	0,06	0,05	0,04
P.4.2	85		1,0	0,5	0,025	0,019	0,014	0,031	0,024	0,018	0,040	0,031	0,023	0,047	0,036	0,026	0,06	0,05	0,04
M.1.1	85		1,0	0,5	0,025	0,019	0,014	0,031	0,024	0,018	0,040	0,031	0,023	0,047	0,036	0,026	0,06	0,05	0,04
M.2.1	70		1,0	0,5	0,025	0,019	0,014	0,031	0,024	0,018	0,040	0,031	0,023	0,047	0,036	0,026	0,06	0,05	0,04
M.3.1	85		1,0	0,5	0,025	0,019	0,014	0,031	0,024	0,018	0,040	0,031	0,023	0,047	0,036	0,026	0,06	0,05	0,04
K.1.1		150	1,0	0,5	0,047	0,036	0,026	0,063	0,049	0,035	0,079	0,061	0,044	0,094	0,073	0,053	0,13	0,10	0,07
K.1.2		140	1,0	0,5	0,047	0,036	0,026	0,063	0,049	0,035	0,079	0,061	0,044	0,094	0,073	0,053	0,13	0,10	0,07
K.2.1		150	1,0	0,5	0,040	0,031	0,023	0,054	0,042	0,030	0,067	0,052	0,038	0,081	0,062	0,045	0,11	0,08	0,06
K.2.2		140	1,0	0,5	0,040	0,031	0,023	0,054	0,042	0,030	0,067	0,052	0,038	0,081	0,062	0,045	0,11	0,08	0,06
K.3.1		105	1,0	0,5	0,034	0,026	0,019	0,045	0,035	0,025	0,056	0,043	0,031	0,067	0,052	0,038	0,09	0,07	0,05
K.3.2		105	1,0	0,5	0,034	0,026	0,019	0,045	0,035	0,025	0,056	0,043	0,031	0,067	0,052	0,038	0,09	0,07	0,05
N.1.1																			
N.1.2																			
N.2.1																			
N.2.2																			
N.2.3																			
N.3.1	240	240	1,0	0,5	0,038	0,029	0,021	0,049	0,038	0,028	0,063	0,049	0,035	0,741	0,572	0,413	0,10	0,08	0,06
N.3.2	190	190	1,0	0,5	0,040	0,031	0,023	0,054	0,042	0,030	0,067	0,052	0,038	0,081	0,062	0,045	0,11	0,08	0,06
N.3.3	190	190	1,0	0,5	0,040	0,031	0,023	0,054	0,042	0,030	0,067	0,052	0,038	0,081	0,062	0,045	0,11	0,08	0,06
N.4.1																			
S.1.1	38		0,5	0,25	0,025	0,012	0,014	0,031	0,024	0,018	0,040	0,031	0,023	0,047	0,036	0,026	0,06	0,05	0,04
S.1.2	38		0,5	0,25	0,025	0,012	0,014	0,031	0,024	0,018	0,040	0,031	0,023	0,047	0,036	0,026	0,06	0,05	0,04
S.2.1	23		0,5	0,25	0,027	0,021	0,015	0,036	0,028	0,020	0,045	0,035	0,025	0,054	0,042	0,030	0,07	0,06	0,04
S.2.2	27		0,5	0,25	0,025	0,012	0,014	0,031	0,024	0,018	0,040	0,031	0,023	0,047	0,036	0,026	0,06	0,05	0,04
S.2.3	23		0,5	0,25	0,027	0,021	0,015	0,036	0,028	0,020	0,045	0,035	0,025	0,054	0,042	0,030	0,07	0,06	0,04
S.3.1	70		0,5	0,25	0,031	0,024	0,018	0,040	0,031	0,023	0,052	0,040	0,029	0,061	0,047	0,034	0,08	0,06	0,05
S.3.2	50		0,5	0,25	0,034	0,026	0,019	0,045	0,035	0,025	0,056	0,043	0,031	0,067	0,052	0,038	0,09	0,07	0,05
S.3.3	50		0,5	0,25	0,034	0,026	0,019	0,045	0,035	0,025	0,056	0,043	0,031	0,067	0,052	0,038	0,09	0,07	0,05
H.1.1		70	0,5*		0,027	0,021		0,036	0,028		0,045	0,035		0,054	0,042		0,07	0,06	
H.1.2		50	0,5*		0,025	0,019		0,031	0,024		0,040	0,031		0,047	0,036		0,06	0,05	
H.1.3																			
H.1.4																			
H.2.1		70	0,5*		0,031	0,024		0,040	0,031		0,052	0,040		0,061	0,047		0,08	0,06	
H.3.1		70	0,5*		0,027	0,021		0,036	0,028		0,045	0,035		0,054	0,042		0,07	0,06	
O.1.1	250	250	1,0	0,5	0,058	0,045	0,033	0,108	0,083	0,060	0,135	0,104	0,075	0,162	0,125	0,090	0,22	0,17	0,12
O.1.2																			
O.2.1																			
O.2.2																			
O.3.1																			

*= Edge Milling and Trochoidal Milling

 Plunging angle for ramping and helical milling: No. of teeth 3 = 5 °/No. of teeth 4 = 4°/No. of teeth 5 = 3°

Index	52 784 ...																		● 1st choice		
	Ø DC (mm) =																		○ suitable		
	10			12			14			16			18			20			Emulsion	Compressed air	MMS
	a_p 0,1-0,2 x DC	a_p 0,3-0,4 x DC	a_p 0,6-1,0 x DC	a_p 0,1-0,2 x DC	a_p 0,3-0,4 x DC	a_p 0,6-1,0 x DC	a_p 0,1-0,2 x DC	a_p 0,3-0,4 x DC	a_p 0,6-1,0 x DC	a_p 0,1-0,2 x DC	a_p 0,3-0,4 x DC	a_p 0,6-1,0 x DC	a_p 0,1-0,2 x DC	a_p 0,3-0,4 x DC	a_p 0,6-1,0 x DC	a_p 0,1-0,2 x DC	a_p 0,3-0,4 x DC	a_p 0,6-1,0 x DC			
f_c (mm)																					
P.1.1	0,12	0,10	0,07	0,15	0,11	0,08	0,17	0,13	0,10	0,18	0,14	0,11	0,19	0,16	0,12	0,20	0,17	0,14	○	●	○
P.1.2	0,12	0,09	0,07	0,14	0,10	0,08	0,16	0,12	0,09	0,16	0,13	0,10	0,17	0,15	0,11	0,18	0,16	0,13	○	●	○
P.1.3	0,12	0,09	0,07	0,14	0,10	0,08	0,16	0,12	0,09	0,16	0,13	0,10	0,17	0,15	0,11	0,18	0,16	0,13	○	●	○
P.1.4	0,12	0,09	0,07	0,14	0,10	0,08	0,16	0,12	0,09	0,16	0,13	0,10	0,17	0,15	0,11	0,18	0,16	0,13	○	●	○
P.1.5	0,12	0,09	0,07	0,14	0,10	0,08	0,16	0,12	0,09	0,16	0,13	0,10	0,17	0,15	0,11	0,18	0,16	0,13	○	●	○
P.2.1	0,12	0,09	0,07	0,14	0,10	0,08	0,16	0,12	0,09	0,16	0,13	0,10	0,17	0,15	0,11	0,18	0,16	0,13	○	●	○
P.2.2	0,12	0,09	0,07	0,14	0,10	0,08	0,16	0,12	0,09	0,16	0,13	0,10	0,17	0,15	0,11	0,18	0,16	0,13	○	●	○
P.2.3	0,11	0,09	0,06	0,12	0,09	0,07	0,14	0,11	0,08	0,14	0,12	0,09	0,15	0,13	0,10	0,16	0,14	0,11	○	●	○
P.2.4	0,11	0,09	0,06	0,12	0,09	0,07	0,14	0,11	0,08	0,14	0,12	0,09	0,15	0,13	0,10	0,16	0,14	0,11	○	●	○
P.3.1	0,09	0,07	0,05	0,11	0,08	0,06	0,13	0,10	0,07	0,13	0,10	0,08	0,14	0,12	0,09	0,14	0,13	0,10	○	●	○
P.3.2	0,09	0,07	0,05	0,11	0,08	0,06	0,13	0,10	0,07	0,13	0,10	0,08	0,14	0,12	0,09	0,14	0,13	0,10	○	●	○
P.3.3	0,09	0,07	0,05	0,11	0,08	0,06	0,13	0,10	0,07	0,13	0,10	0,08	0,14	0,12	0,09	0,14	0,13	0,10	○	●	○
P.4.1	0,08	0,06	0,04	0,10	0,07	0,05	0,11	0,09	0,06	0,11	0,09	0,07	0,12	0,10	0,08	0,13	0,11	0,09	●		
P.4.2	0,08	0,06	0,04	0,10	0,07	0,05	0,11	0,09	0,06	0,11	0,09	0,07	0,12	0,10	0,08	0,13	0,11	0,09	●		
M.1.1	0,08	0,06	0,04	0,09	0,07	0,05	0,11	0,09	0,06	0,11	0,09	0,07	0,12	0,10	0,08	0,13	0,11	0,09	●		
M.2.1	0,08	0,06	0,04	0,09	0,07	0,05	0,11	0,09	0,06	0,11	0,09	0,07	0,12	0,10	0,08	0,13	0,11	0,09	●		
M.3.1	0,08	0,06	0,04	0,09	0,07	0,05	0,11	0,09	0,06	0,11	0,09	0,07	0,12	0,10	0,08	0,13	0,11	0,09	●		
K.1.1	0,14	0,10	0,08	0,16	0,13	0,09	0,22	0,17	0,12	0,22	0,18	0,14	0,24	0,20	0,16	0,25	0,22	0,18		●	
K.1.2	0,14	0,10	0,08	0,16	0,13	0,09	0,22	0,17	0,12	0,22	0,18	0,14	0,24	0,20	0,16	0,25	0,22	0,18		●	
K.2.1	0,14	0,10	0,08	0,14	0,11	0,08	0,19	0,15	0,11	0,19	0,16	0,12	0,20	0,17	0,13	0,25	0,22	0,18		●	
K.2.2	0,12	0,09	0,07	0,14	0,11	0,08	0,19	0,15	0,11	0,19	0,16	0,12	0,20	0,17	0,13	0,22	0,19	0,15		●	
K.3.1	0,11	0,09	0,06	0,14	0,10	0,08	0,16	0,12	0,09	0,16	0,13	0,10	0,17	0,15	0,11	0,18	0,16	0,13		●	
K.3.2	0,11	0,09	0,06	0,14	0,10	0,08	0,16	0,12	0,09	0,16	0,13	0,10	0,17	0,15	0,11	0,18	0,16	0,13		●	
N.1.1																					
N.1.2																					
N.2.1																					
N.2.2																					
N.2.3																					
N.3.1	0,12	0,10	0,07	0,15	0,11	0,08	0,17	0,13	0,10	0,18	0,14	0,11	0,19	0,16	0,12	0,20	0,17	0,14	●		○
N.3.2	0,14	0,10	0,08	0,16	0,13	0,09	0,14	0,11	0,08	0,19	0,16	0,12	0,21	0,17	0,14	0,22	0,19	0,15	●		○
N.3.3	0,14	0,10	0,08	0,16	0,13	0,09	0,14	0,11	0,08	0,19	0,16	0,12	0,21	0,17	0,14	0,22	0,19	0,15	●		○
N.4.1																					
S.1.1	0,08	0,06	0,04	0,09	0,07	0,05	0,11	0,09	0,06	0,11	0,09	0,07	0,12	0,10	0,08	0,13	0,11	0,09	●		
S.1.2	0,08	0,06	0,04	0,09	0,07	0,05	0,11	0,09	0,06	0,11	0,09	0,07	0,12	0,10	0,08	0,13	0,11	0,09	●		
S.2.1	0,09	0,07	0,05	0,11	0,08	0,06	0,13	0,10	0,07	0,13	0,10	0,08	0,14	0,12	0,09	0,14	0,13	0,10	●		
S.2.2	0,08	0,06	0,04	0,09	0,07	0,05	0,11	0,09	0,06	0,11	0,09	0,07	0,12	0,10	0,08	0,13	0,11	0,09	●		
S.2.3	0,09	0,07	0,05	0,11	0,05	0,06	0,13	0,10	0,07	0,13	0,10	0,08	0,14	0,12	0,09	0,14	0,13	0,10	●		
S.3.1	0,10	0,08	0,06	0,12	0,09	0,07	0,14	0,11	0,08	0,14	0,12	0,09	0,15	0,13	0,10	0,16	0,14	0,11	●		
S.3.2	0,11	0,09	0,06	0,14	0,10	0,08	0,16	0,12	0,09	0,16	0,13	0,10	0,17	0,15	0,11	0,18	0,16	0,13	●		
S.3.3	0,11	0,09	0,06	0,14	0,10	0,08	0,16	0,12	0,09	0,16	0,13	0,10	0,17	0,15	0,11	0,18	0,16	0,13	●		
H.1.1	0,09	0,07		0,11	0,08		0,13	0,10		0,13	0,10		0,14	0,12		0,14	0,13			●	
H.1.2	0,08	0,06		0,09	0,07		0,11	0,09		0,11	0,09		0,12	0,10		0,13	0,11			●	
H.1.3																					
H.1.4																					
H.2.1	0,10	0,08		0,12	0,09		0,14	0,11		0,14	0,12		0,16	0,13		0,16	0,14			●	
H.3.1	0,09	0,07		0,11	0,08		0,13	0,10		0,13	0,10		0,14	0,12		0,14	0,13			●	
O.1.1	0,27	0,21	0,15	0,32	0,25	0,18	0,38	0,29	0,21	0,38	0,31	0,24	0,41	0,35	0,27	0,43	0,38	0,30	●		○
O.1.2																					
O.2.1																					
O.2.2																					
O.3.1																					

Cutting data standard values – MonsterMill – TCR – End mill

Index	Type long	Type extra long	Type long	Type extra long	52 504 ..., 52 508 ...											
					Ø DC (mm) =											
					4			5			6			8		
					a_e 0,1-0,2 x DC	a_e 0,3-0,4 x DC	a_e 0,6-1,0 x DC	a_e 0,1-0,2 x DC	a_e 0,3-0,4 x DC	a_e 0,6-1,0 x DC	a_e 0,1-0,2 x DC	a_e 0,3-0,4 x DC	a_e 0,6-1,0 x DC	a_e 0,1-0,2 x DC	a_e 0,3-0,4 x DC	a_e 0,6-1,0 x DC
v_c (m/min)		$a_{p\ max.} \times DC$		f_z (mm)												
P.4.1	110	88	1,0	0,5	0,022	0,017	0,012	0,032	0,024	0,016	0,042	0,031	0,021	0,05	0,037	0,025
P.4.2	100	80	1,0	0,5	0,022	0,017	0,012	0,032	0,024	0,016	0,042	0,031	0,021	0,05	0,037	0,025
M.1.1	110	88	1,0	0,5	0,022	0,017	0,012	0,032	0,024	0,016	0,042	0,031	0,021	0,05	0,037	0,025
M.2.1	80	64	1,0	0,5	0,022	0,017	0,012	0,032	0,024	0,016	0,042	0,031	0,021	0,05	0,037	0,025
M.3.1	100	80	1,0	0,5	0,022	0,017	0,012	0,032	0,024	0,016	0,042	0,031	0,021	0,05	0,037	0,025
S.1.1																
S.1.2																
S.2.1																
S.2.2																
S.2.3																
S.3.1	80	96	1,0	0,5	0,022	0,017	0,012	0,032	0,024	0,016	0,042	0,031	0,021	0,050	0,037	0,025
S.3.2	70	80	1,0	0,5	0,020	0,015	0,010	0,030	0,022	0,014	0,040	0,029	0,019	0,048	0,035	0,022
S.3.3	60	64	1,0	0,5	0,150	0,010	0,008	0,025	0,018	0,010	0,035	0,025	0,015	0,040	0,030	0,018

Cutting data standard values – MonsterMill – TCR – End mill

Index	Type long	Type long	52 506 ...											
			Ø DC (mm) =											
			4		5		6		8		10		12	
			a_e 0,1-0,2 x DC	a_e 0,3-0,4 x DC	a_e 0,1-0,2 x DC	a_e 0,3-0,4 x DC	a_e 0,1-0,2 x DC	a_e 0,3-0,4 x DC	a_e 0,1-0,2 x DC	a_e 0,3-0,4 x DC	a_e 0,1-0,2 x DC	a_e 0,3-0,4 x DC	a_e 0,1-0,2 x DC	a_e 0,3-0,4 x DC
v_c (m/min)	$a_{p\ max.} \times DC$	f_z (mm)												
P.4.1	110	1,0	0,022	0,017	0,032	0,024	0,042	0,031	0,05	0,037	0,064	0,048	0,08	0,06
P.4.2	100	1,0	0,022	0,017	0,032	0,024	0,042	0,031	0,05	0,037	0,064	0,048	0,08	0,06
M.1.1	110	1,0	0,022	0,017	0,032	0,024	0,042	0,031	0,05	0,037	0,064	0,048	0,08	0,06
M.2.1	80	1,0	0,022	0,017	0,032	0,024	0,042	0,031	0,05	0,037	0,064	0,048	0,08	0,06
M.3.1	100	1,0	0,022	0,017	0,032	0,024	0,042	0,031	0,05	0,037	0,064	0,048	0,08	0,06
S.1.1														
S.1.2														
S.2.1														
S.2.2														
S.2.3														
S.3.1	80	1,0	0,022	0,017	0,032	0,024	0,042	0,031	0,050	0,037	0,064	0,048	0,080	0,060
S.3.2	70	1,0	0,020	0,015	0,030	0,022	0,040	0,029	0,048	0,035	0,062	0,046	0,078	0,058
S.3.3	60	1,0	0,150	0,010	0,025	0,018	0,035	0,025	0,040	0,030	0,055	0,035	0,070	0,050

Index	52 504 ..., 52 508 ...													● 1st choice ○ suitable		
	Ø DC (mm) =													Emulsion	Compressed air	MMS
	10			12			16			20						
	a_e 0,1-0,2 x DC	a_e 0,3-0,4 x DC	a_e 0,6-1,0 x DC	a_e 0,1-0,2 x DC	a_e 0,3-0,4 x DC	a_e 0,6-1,0 x DC	a_e 0,1-0,2 x DC	a_e 0,3-0,4 x DC	a_e 0,6-1,0 x DC	a_e 0,1-0,2 x DC	a_e 0,3-0,4 x DC	a_e 0,6-1,0 x DC				
f_z (mm)																
P.4.1	0,064	0,048	0,032	0,08	0,06	0,04	0,085	0,065	0,045	0,111	0,09	0,07	●	○		
P.4.2	0,064	0,048	0,032	0,08	0,06	0,04	0,085	0,065	0,045	0,111	0,09	0,07	●	○		
M.1.1	0,064	0,048	0,032	0,08	0,06	0,04	0,085	0,065	0,045	0,111	0,09	0,07	●	○		
M.2.1	0,064	0,048	0,032	0,08	0,06	0,04	0,085	0,065	0,045	0,111	0,09	0,07	●	○		
M.3.1	0,064	0,048	0,032	0,08	0,06	0,04	0,085	0,065	0,045	0,111	0,09	0,07	●	○		
S.1.1																
S.1.2																
S.2.1																
S.2.2																
S.2.3																
S.3.1	0,064	0,048	0,032	0,080	0,060	0,040	0,085	0,065	0,045	0,111	0,090	0,070	●			
S.3.2	0,062	0,046	0,030	0,078	0,058	0,038	0,083	0,063	0,043	0,109	0,088	0,068	●			
S.3.3	0,055	0,035	0,025	0,070	0,050	0,030	0,075	0,055	0,035	0,100	0,080	0,060	●			

Index	52 506 ...				● 1st choice ○ suitable		
	Ø DC (mm) =				Emulsion	Compressed air	MMS
	16		20				
	a_e 0,1-0,2 x DC	a_e 0,3-0,4 x DC	a_e 0,1-0,2 x DC	a_e 0,3-0,4 x DC			
f_z (mm)							
P.4.1	0,085	0,065	0,111	0,09	●	○	
P.4.2	0,085	0,065	0,111	0,09	●	○	
M.1.1	0,085	0,065	0,111	0,09	●	○	
M.2.1	0,085	0,065	0,111	0,09	●	○	
M.3.1	0,085	0,065	0,111	0,09	●	○	
S.1.1							
S.1.2							
S.2.1							
S.2.2							
S.2.3							
S.3.1	0,085	0,065	0,111	0,090	●		
S.3.2	0,083	0,063	0,109	0,088	●		
S.3.3	0,075	0,055	0,100	0,080	●		

Cutting data standard values – MonsterMill – TCR – Ball-nosed end mill

Index	Type long	Type extra long	$a_{p,max.} \times DC$	52 514 ...											
				$\varnothing DC (mm) =$											
				2		3		4		5		6		8	
				a_e 0,1-0,2 $\times DC$	a_e 0,3-0,4 $\times DC$	a_e 0,1-0,2 $\times DC$	a_e 0,3-0,4 $\times DC$	a_e 0,1-0,2 $\times DC$	a_e 0,3-0,4 $\times DC$	a_e 0,1-0,2 $\times DC$	a_e 0,3-0,4 $\times DC$	a_e 0,1-0,2 $\times DC$	a_e 0,3-0,4 $\times DC$	a_e 0,1-0,2 $\times DC$	a_e 0,3-0,4 $\times DC$
$v_c (m/min)$			$f_z (mm)$												
P.4.1	110	65	0,1 - 0,2	0,015	0,011	0,018	0,012	0,02	0,015	0,02	0,015	0,03	0,02	0,04	0,03
P.4.2	100	60	0,1 - 0,2	0,015	0,011	0,018	0,012	0,02	0,015	0,02	0,015	0,03	0,02	0,04	0,03
M.1.1	110	65	0,1 - 0,2	0,015	0,011	0,018	0,012	0,02	0,015	0,02	0,015	0,03	0,02	0,04	0,03
M.2.1	80	55	0,1 - 0,2	0,015	0,011	0,018	0,012	0,02	0,015	0,02	0,015	0,03	0,02	0,04	0,03
M.3.1	100	60	0,1 - 0,2	0,015	0,011	0,018	0,012	0,02	0,015	0,02	0,015	0,03	0,02	0,04	0,03
S.1.1															
S.1.2															
S.2.1															
S.2.2															
S.2.3															
S.3.1	80	60	0,1 - 0,2	0,017	0,013	0,02	0,014	0,022	0,017	0,022	0,017	0,034	0,025	0,053	0,042
S.3.2	70	50	0,1 - 0,2	0,014	0,011	0,017	0,012	0,019	0,014	0,019	0,014	0,029	0,022	0,046	0,036
S.3.3	60	40	0,1 - 0,2	0,012	0,009	0,014	0,01	0,016	0,012	0,016	0,012	0,024	0,018	0,038	0,03

Cutting data standard values – MonsterMill – TCR – Torus face cutter

Index	Type long	Type extra long	$a_{p,max.} \times DC$	52 512 ...										● 1st choice ○ suitable		
				$\varnothing DC (mm) =$										Emulsion	Compressed air	MMS
				2	3	4	5	6	8	10	12	16				
				a_e 0,1-1,0 $\times DC$												
$v_c (m/min)$			$f_z (mm)$													
P.4.1	120	110	0,06	0,025	0,04	0,06	0,07	0,09	0,11	0,13	0,18	0,22	●	○		
P.4.2	110	100	0,06	0,025	0,04	0,06	0,07	0,09	0,11	0,13	0,18	0,22	●	○		
M.1.1	120	110	0,06	0,025	0,04	0,06	0,07	0,09	0,11	0,13	0,18	0,22	●	○		
M.2.1	100	90	0,06	0,025	0,04	0,06	0,07	0,09	0,11	0,13	0,18	0,22	●	○		
M.3.1	110	100	0,06	0,025	0,04	0,06	0,07	0,09	0,11	0,13	0,18	0,22	●	○		
S.1.1																
S.1.2																
S.2.1																
S.2.2																
S.2.3																
S.3.1	130	120	0,06	0,025	0,040	0,060	0,070	0,090	0,11	0,13	0,18	0,22	●			
S.3.2	110	100	0,06	0,020	0,035	0,055	0,065	0,085	0,10	0,12	0,16	0,20	●			
S.3.3	90	80	0,06	0,015	0,030	0,050	0,060	0,080	0,09	0,11	0,15	0,18	●			

Index	52 514 ...						● 1st choice ○ suitable		
	Ø DC (mm) =						Emulsion	Compressed air	MMS
	10		12		16				
	a_e 0,1-0,2 x DC	a_e 0,3-0,4 x DC	a_e 0,1-0,2 x DC	a_e 0,3-0,4 x DC	a_e 0,1-0,2 x DC	a_e 0,3-0,4 x DC			
f_z (mm)									
P.4.1	0,05	0,04	0,06	0,05	0,07	0,06	●	○	
P.4.2	0,05	0,04	0,06	0,05	0,07	0,06	●	○	
M.1.1	0,05	0,04	0,06	0,05	0,07	0,06	●	○	
M.2.1	0,05	0,04	0,06	0,05	0,07	0,06	●	○	
M.3.1	0,05	0,04	0,06	0,05	0,07	0,06	●	○	
S.1.1									
S.1.2									
S.2.1									
S.2.2									
S.2.3									
S.3.1	0,059	0,046	0,066	0,056	0,073	0,063	●		
S.3.2	0,05	0,04	0,056	0,048	0,062	0,054	●		
S.3.3	0,042	0,033	0,047	0,04	0,052	0,045	●		

Cutting data standard values – MonsterMill – NCR – End mill, long

Index	ZEFP = 4			Type long	53 030 ...											
					Ø DC (mm) =											
					4			5			6			8		
	a_s 0,1–0,2 x DC	a_s 0,3–0,4 x DC	a_s 0,6–1,0 x DC		a_s 0,1–0,2 x DC	a_s 0,3–0,4 x DC	a_s 0,6–1,0 x DC	a_s 0,1–0,2 x DC	a_s 0,3–0,4 x DC	a_s 0,6–1,0 x DC	a_s 0,1–0,2 x DC	a_s 0,3–0,4 x DC	a_s 0,6–1,0 x DC	a_s 0,1–0,2 x DC	a_s 0,3–0,4 x DC	a_s 0,6–1,0 x DC
v_c (m/min)			$a_{p,max}$ x DC	f_z (mm)												
M.1.1	120	100	70	1,0	0,03	0,02	0,02	0,04	0,03	0,02	0,05	0,04	0,02	0,06	0,05	0,03
M.2.1	100	80	60	1,0	0,03	0,02	0,02	0,04	0,03	0,02	0,05	0,04	0,02	0,06	0,05	0,03
M.3.1	120	100	70	1,0	0,03	0,02	0,02	0,04	0,03	0,02	0,05	0,04	0,02	0,06	0,05	0,03
S.1.1	50	40	30	1,0	0,03	0,02	0,02	0,04	0,03	0,02	0,05	0,04	0,02	0,06	0,05	0,03
S.1.2	50	40	30	1,0	0,03	0,02	0,02	0,04	0,03	0,02	0,05	0,04	0,02	0,06	0,05	0,03
S.2.1	35	30	25	1,0	0,03	0,02	0,02	0,04	0,03	0,02	0,05	0,04	0,02	0,06	0,05	0,03
S.2.2	35	30	25	1,0	0,03	0,02	0,02	0,04	0,03	0,02	0,05	0,04	0,02	0,06	0,05	0,03
S.2.3	35	30	25	1,0	0,03	0,02	0,02	0,04	0,03	0,02	0,05	0,04	0,02	0,06	0,05	0,03
S.3.1	120	100	80	1,0	0,04	0,03	0,02	0,05	0,04	0,03	0,05	0,04	0,03	0,07	0,06	0,04
S.3.2	100	80	60	1,0	0,04	0,03	0,02	0,05	0,04	0,03	0,05	0,04	0,03	0,07	0,06	0,04
S.3.3	80	70	60	1,0	0,04	0,03	0,02	0,05	0,04	0,03	0,05	0,04	0,03	0,07	0,06	0,04

 Plunging angle for ramping and helical milling: 3°

Index	ZEFP = 5		Type long	53 031 ...												● 1st choice ○ suitable		
				Ø DC (mm) =												Emulsion	Compressed air	MMS
				6		8		10		12		16		20				
	a_s 0,1–0,2 x DC	a_s 0,3–0,4 x DC		a_s 0,1–0,2 x DC	a_s 0,3–0,4 x DC	a_s 0,1–0,2 x DC	a_s 0,3–0,4 x DC	a_s 0,1–0,2 x DC	a_s 0,3–0,4 x DC	a_s 0,1–0,2 x DC	a_s 0,3–0,4 x DC	a_s 0,1–0,2 x DC	a_s 0,3–0,4 x DC	a_s 0,1–0,2 x DC	a_s 0,3–0,4 x DC			
v_c (m/min)		$a_{p,max}$ x DC	f_z (mm)															
M.1.1	100	1,5	0,04	0,03	0,06	0,04	0,07	0,05	0,08	0,06	0,10	0,07	0,12	0,08	●		○	
M.2.1	80	1,5	0,04	0,03	0,06	0,04	0,07	0,05	0,08	0,06	0,10	0,07	0,12	0,08	●		○	
M.3.1	100	1,5	0,04	0,03	0,06	0,04	0,07	0,05	0,08	0,06	0,10	0,07	0,12	0,08	●		○	
S.1.1	40	1,5	0,04	0,03	0,06	0,04	0,07	0,05	0,08	0,06	0,10	0,07	0,12	0,08	●			
S.1.2	40	1,5	0,04	0,03	0,06	0,04	0,07	0,05	0,08	0,06	0,10	0,07	0,12	0,08	●			
S.2.1	35	1,5	0,04	0,03	0,06	0,04	0,07	0,05	0,08	0,06	0,10	0,07	0,12	0,08	●			
S.2.2	35	1,5	0,04	0,03	0,06	0,04	0,07	0,05	0,08	0,06	0,10	0,07	0,12	0,08	●			
S.2.3	35	1,5	0,04	0,03	0,06	0,04	0,07	0,05	0,08	0,06	0,10	0,07	0,12	0,08	●			
S.3.1	100	1,5	0,05	0,04	0,06	0,05	0,08	0,06	0,10	0,07	0,12	0,09	0,14	0,10	●			
S.3.2	80	1,5	0,05	0,04	0,06	0,05	0,08	0,06	0,10	0,07	0,12	0,09	0,14	0,10	●			
S.3.3	70	1,5	0,05	0,04	0,06	0,05	0,08	0,06	0,10	0,07	0,12	0,09	0,14	0,10	●			

 Plunging angle for ramping and helical milling = 1°

Index	53 030 ...												● 1st choice		
	Ø DC (mm) =												○ suitable		
	10			12			16			20			Emulsion	Compressed air	MMS
	a_s 0,1-0,2 x DC	a_s 0,3-0,4 x DC	a_s 0,6-1,0 x DC	a_s 0,1-0,2 x DC	a_s 0,3-0,4 x DC	a_s 0,6-1,0 x DC	a_s 0,1-0,2 x DC	a_s 0,3-0,4 x DC	a_s 0,6-1,0 x DC	a_s 0,1-0,2 x DC	a_s 0,3-0,4 x DC	a_s 0,6-1,0 x DC			
f_z (mm)															
M.1.1	0,08	0,06	0,04	0,10	0,07	0,05	0,12	0,09	0,05	0,14	0,10	0,06	●		○
M.2.1	0,08	0,06	0,04	0,10	0,07	0,05	0,12	0,09	0,05	0,14	0,10	0,06	●		○
M.3.1	0,08	0,06	0,04	0,10	0,07	0,05	0,12	0,09	0,05	0,14	0,10	0,06	●		○
S.1.1	0,08	0,06	0,04	0,10	0,07	0,05	0,12	0,09	0,05	0,14	0,10	0,06	●		
S.1.2	0,08	0,06	0,04	0,10	0,07	0,05	0,12	0,09	0,05	0,14	0,10	0,06	●		
S.2.1	0,08	0,06	0,04	0,10	0,07	0,05	0,12	0,09	0,05	0,14	0,10	0,06	●		
S.2.2	0,08	0,06	0,04	0,10	0,07	0,05	0,12	0,09	0,05	0,14	0,10	0,06	●		
S.2.3	0,08	0,06	0,04	0,10	0,07	0,05	0,12	0,09	0,05	0,14	0,10	0,06	●		
S.3.1	0,09	0,07	0,05	0,11	0,08	0,06	0,13	0,10	0,07	0,16	0,12	0,08	●		
S.3.2	0,09	0,07	0,05	0,11	0,08	0,06	0,13	0,10	0,07	0,16	0,12	0,08	●		
S.3.3	0,09	0,07	0,05	0,11	0,08	0,06	0,13	0,10	0,07	0,16	0,12	0,08	●		

Cutting data standard values – MonsterMill – NCR – End mill, extra long

Index	ZEFP = 4		Type extra long	53 030 ...											
	a _e 0,1–0,2 x DC	a _e 0,3–0,4 x DC		Ø DC (mm) =											
				4		5		6		8		10		12	
	v _c (m/min)			a _{p,max.} x DC		a _e 0,1–0,2 x DC	a _e 0,3–0,4 x DC	a _e 0,1–0,2 x DC	a _e 0,3–0,4 x DC	a _e 0,1–0,2 x DC	a _e 0,3–0,4 x DC	a _e 0,1–0,2 x DC	a _e 0,3–0,4 x DC	a _e 0,1–0,2 x DC	a _e 0,3–0,4 x DC
f _z (mm)															
M.1.1	100	80	1,0	0,03	0,02	0,04	0,03	0,05	0,04	0,06	0,05	0,08	0,06	0,10	0,07
M.2.1	90	70	1,0	0,03	0,02	0,04	0,03	0,05	0,04	0,06	0,05	0,08	0,06	0,10	0,07
M.3.1	100	80	1,0	0,03	0,02	0,04	0,03	0,05	0,04	0,06	0,05	0,08	0,06	0,10	0,07
S.1.1	50	40	1,0	0,03	0,02	0,04	0,03	0,05	0,04	0,06	0,05	0,08	0,06	0,10	0,07
S.1.2	50	40	1,0	0,03	0,02	0,04	0,03	0,05	0,04	0,06	0,05	0,08	0,06	0,10	0,07
S.2.1	35	30	1,0	0,03	0,02	0,04	0,03	0,05	0,04	0,06	0,05	0,08	0,06	0,10	0,07
S.2.2	35	30	1,0	0,03	0,02	0,04	0,03	0,05	0,04	0,06	0,05	0,08	0,06	0,10	0,07
S.2.3	35	30	1,0	0,03	0,02	0,04	0,03	0,05	0,04	0,06	0,05	0,08	0,06	0,10	0,07
S.3.1	100	80	1,0	0,04	0,03	0,05	0,04	0,05	0,04	0,07	0,06	0,09	0,07	0,11	0,08
S.3.2	80	70	1,0	0,04	0,03	0,05	0,04	0,05	0,04	0,07	0,06	0,09	0,07	0,11	0,08
S.3.3	70	60	1,0	0,04	0,03	0,05	0,04	0,05	0,04	0,07	0,06	0,09	0,07	0,11	0,08

 Plunging angle for ramping and helical milling: 3°

Cutting data standard values – MonsterMill – NCR – ball-nosed end mill

Index	Type long	Type extra long	a _{p,max.} x DC	53 032 ... / 53 033 ...											
				Ø DC (mm) =											
	2			3		4		5		6		8			
	a _e 0,01–0,02 x DC	a _e 0,03–0,05 x DC		a _e 0,01–0,02 x DC	a _e 0,03–0,05 x DC	a _e 0,01–0,02 x DC	a _e 0,03–0,05 x DC	a _e 0,01–0,02 x DC	a _e 0,03–0,05 x DC	a _e 0,01–0,02 x DC	a _e 0,03–0,05 x DC	a _e 0,01–0,02 x DC	a _e 0,03–0,05 x DC		
f _z (mm)															
M.1.1	120	90	0,02	0,02	0,015	0,03	0,02	0,035	0,025	0,04	0,03	0,055	0,04	0,07	0,05
M.2.1	100	80	0,02	0,02	0,015	0,03	0,02	0,035	0,025	0,04	0,03	0,055	0,04	0,07	0,05
M.3.1	120	90	0,02	0,02	0,015	0,03	0,02	0,035	0,025	0,04	0,03	0,055	0,04	0,07	0,05
S.1.1	60	50	0,02	0,015	0,01	0,025	0,015	0,03	0,02	0,04	0,025	0,05	0,03	0,06	0,04
S.1.2	60	50	0,02	0,015	0,01	0,025	0,015	0,03	0,02	0,04	0,025	0,05	0,03	0,06	0,04
S.2.1	50	40	0,02	0,015	0,01	0,025	0,015	0,03	0,02	0,04	0,025	0,05	0,03	0,06	0,04
S.2.2	50	40	0,02	0,015	0,01	0,025	0,015	0,03	0,02	0,04	0,025	0,05	0,03	0,06	0,04
S.2.3	50	40	0,02	0,015	0,01	0,025	0,015	0,03	0,02	0,04	0,025	0,05	0,03	0,06	0,04
S.3.1	100	80	0,02	0,02	0,015	0,03	0,02	0,035	0,025	0,04	0,03	0,055	0,04	0,07	0,05
S.3.2	90	70	0,02	0,02	0,015	0,03	0,02	0,035	0,025	0,04	0,03	0,055	0,04	0,07	0,05
S.3.3	90	70	0,02	0,02	0,015	0,03	0,02	0,035	0,025	0,04	0,03	0,055	0,04	0,07	0,05

Index	53 030 ...				● 1st choice ○ suitable		
	Ø DC (mm) =				Emulsion	Compressed air	MMS
	16		20				
	a_e 0,1-0,2 x DC	a_e 0,3-0,4 x DC	a_e 0,1-0,2 x DC	a_e 0,3-0,4 x DC			
f_z (mm)							
M.1.1	0,12	0,09	0,14	0,10	●		○
M.2.1	0,12	0,09	0,14	0,10	●		○
M.3.1	0,12	0,09	0,14	0,10	●		○
S.1.1	0,12	0,09	0,14	0,10	●		
S.1.2	0,12	0,09	0,14	0,10	●		
S.2.1	0,12	0,09	0,14	0,10	●		
S.2.2	0,12	0,09	0,14	0,10	●		
S.2.3	0,12	0,09	0,14	0,10	●		
S.3.1	0,13	0,10	0,16	0,12	●		
S.3.2	0,13	0,10	0,16	0,12	●		
S.3.3	0,13	0,10	0,16	0,12	●		

Index	53 032 ... / 53 033 ...						● 1st choice ○ suitable		
	Ø DC (mm) =						Emulsion	Compressed air	MMS
	10		12		16				
	a_e 0,01-0,02 x DC	a_e 0,03-0,05 x DC	a_e 0,01-0,02 x DC	a_e 0,03-0,05 x DC	a_e 0,01-0,02 x DC	a_e 0,03-0,05 x DC			
f_z (mm)									
M.1.1	0,08	0,06	0,09	0,07	0,12	0,1	●		○
M.2.1	0,08	0,06	0,09	0,07	0,12	0,1	●		○
M.3.1	0,08	0,06	0,09	0,07	0,12	0,1	●		○
S.1.1	0,07	0,05	0,08	0,06	0,1	0,08	●		
S.1.2	0,07	0,05	0,08	0,06	0,1	0,08	●		
S.2.1	0,07	0,05	0,08	0,06	0,1	0,08	●		
S.2.2	0,07	0,05	0,08	0,06	0,1	0,08	●		
S.2.3	0,07	0,05	0,08	0,06	0,1	0,08	●		
S.3.1	0,08	0,06	0,09	0,07	0,12	0,1	●		
S.3.2	0,08	0,06	0,09	0,07	0,12	0,1	●		
S.3.3	0,08	0,06	0,09	0,07	0,12	0,1	●		

Cutting data standard values – MonsterMill – HCR – End mill

Index	$T_x \leq 2,5 \times DC$		53 603 ..., 53 604 ...									
	Peripheral milling		$\varnothing DC (mm) =$									
			0,2	0,3	0,4–0,5	0,6–0,7	0,8–0,9	1	1,2–1,4	1,5	1,6–1,8	2
	$v_c (m/min)$	$a_{p,max.} \times DC$	$a_e 0,05 \times DC$									
			$f_z (mm)$									
P.1.3	200	1,0	0,006	0,006	0,012	0,012	0,018	0,018	0,024	0,030	0,036	0,042
P.2.3	200	1,0	0,006	0,006	0,012	0,012	0,018	0,018	0,024	0,030	0,036	0,042
P.3.3	200	1,0	0,006	0,006	0,012	0,012	0,018	0,018	0,024	0,030	0,036	0,042
H.1.1	170	1,0	0,006	0,006	0,012	0,012	0,018	0,018	0,024	0,030	0,036	0,042
H.1.2	160	1,0	0,005	0,005	0,010	0,010	0,014	0,014	0,019	0,024	0,029	0,034
H.1.3	150	1,0	0,004	0,004	0,008	0,008	0,012	0,012	0,016	0,020	0,024	0,028
H.1.4	110	1,0	0,003	0,003	0,006	0,006	0,010	0,010	0,013	0,016	0,019	0,022

Index	$T_x \leq 2,5 \times DC$		53 603 ..., 53 604 ...									
	Z-layer milling / face milling		$\varnothing DC (mm) =$									
			0,2	0,3	0,4–0,5	0,6–0,7	0,8–0,9	1	1,2–1,4	1,5	1,6–1,8	2
	$v_c (m/min)$	$a_{p,max.} \times DC$	$a_e 0,05 \times DC$									
			$f_z (mm)$									
P.1.3	120	0,07	0,003	0,003	0,006	0,006	0,009	0,009	0,012	0,015	0,018	0,021
P.2.3	120	0,07	0,003	0,003	0,006	0,006	0,009	0,009	0,012	0,015	0,018	0,021
P.3.3	120	0,07	0,003	0,003	0,006	0,006	0,009	0,009	0,012	0,015	0,018	0,021
H.1.1	110	0,05	0,003	0,003	0,006	0,006	0,009	0,009	0,012	0,015	0,018	0,021
H.1.2	100	0,05	0,002	0,002	0,005	0,005	0,007	0,007	0,010	0,012	0,014	0,017
H.1.3	80	0,03	0,002	0,002	0,004	0,004	0,006	0,006	0,008	0,010	0,012	0,014
H.1.4	60	0,03	0,002	0,002	0,003	0,003	0,005	0,005	0,006	0,008	0,010	0,011

Index	$T_x \leq 2,5 \times DC$		53 603 ..., 53 604 ...									
	Full slot		$\varnothing DC (mm) =$									
			0,2	0,3	0,4–0,5	0,6–0,7	0,8–0,9	1	1,2–1,4	1,5	1,6–1,8	2
	$v_c (m/min)$	$a_{p,max.} \times DC$	$a_e 0,05 \times DC$									
			$f_z (mm)$									
P.1.3	70	0,07	0,002	0,002	0,005	0,005	0,006	0,008	0,009	0,011	0,012	0,015
P.2.3	70	0,07	0,002	0,002	0,005	0,005	0,006	0,008	0,009	0,011	0,012	0,015
P.3.3	70	0,07	0,002	0,002	0,005	0,005	0,006	0,008	0,009	0,011	0,012	0,015
H.1.1	55	0,05	0,002	0,002	0,005	0,005	0,006	0,008	0,009	0,011	0,012	0,015
H.1.2	45	0,05	0,001	0,001	0,003	0,003	0,004	0,005	0,006	0,007	0,008	0,010
H.1.3												
H.1.4												



For improved surface quality, reduce f_z and allowance (a_e or a_p) by 30%!

Index	53 603 ..., 53 604 ...								● 1st choice ○ suitable		
	Ø DC (mm) =								Emulsion	Compressed air	MMS
	2,5	3	4	6	8	10	12				
	a _e 0,05 x DC										
f _z (mm)											
P.1.3	0,054	0,060	0,084	0,126	0,168	0,210	0,240	○	●	●	
P.2.3	0,054	0,060	0,084	0,126	0,168	0,210	0,240	○	●	●	
P.3.3	0,054	0,060	0,084	0,126	0,168	0,210	0,240	○	●	●	
H.1.1	0,054	0,060	0,084	0,126	0,168	0,210	0,240	○	●	●	
H.1.2	0,043	0,048	0,067	0,101	0,134	0,168	0,192	○	●	●	
H.1.3	0,036	0,040	0,056	0,084	0,112	0,140	0,160	○	●	●	
H.1.4	0,029	0,032	0,045	0,067	0,090	0,112	0,128	○	●	●	

Index	53 603 ..., 53 604 ...								● 1st choice ○ suitable		
	Ø DC (mm) =								Emulsion	Compressed air	MMS
	2,5	3	4	6	8	10	12				
	a _e 0,05 x DC										
f _z (mm)											
P.1.3	0,027	0,030	0,042	0,063	0,084	0,105	0,120	○	●	●	
P.2.3	0,027	0,030	0,042	0,063	0,084	0,105	0,120	○	●	●	
P.3.3	0,027	0,030	0,042	0,063	0,084	0,105	0,120	○	●	●	
H.1.1	0,027	0,030	0,042	0,063	0,084	0,105	0,120	○	●	●	
H.1.2	0,022	0,024	0,034	0,050	0,067	0,084	0,096	○	●	●	
H.1.3	0,018	0,020	0,028	0,042	0,056	0,070	0,080	○	●	●	
H.1.4	0,014	0,016	0,022	0,034	0,045	0,056	0,064	○	●	●	

Index	53 603 ..., 53 604 ...								● 1st choice ○ suitable		
	Ø DC (mm) =								Emulsion	Compressed air	MMS
	2,5	3	4	6	8	10	12				
	a _e 0,05 x DC										
f _z (mm)											
P.1.3	0,018	0,023	0,030	0,045	0,050	0,053	0,060	○	●	●	
P.2.3	0,018	0,023	0,030	0,045	0,050	0,053	0,060	○	●	●	
P.3.3	0,018	0,023	0,030	0,045	0,050	0,053	0,060	○	●	●	
H.1.1	0,018	0,023	0,030	0,045	0,050	0,053	0,060	○	●	●	
H.1.2	0,012	0,015	0,020	0,030	0,033	0,035	0,040	○	●	●	
H.1.3											
H.1.4											

Cutting data standard values – MonsterMill – HCR – End mill

Index	$T_x \leq 2,6-5,0 \times DC$		53 603 ..., 53 604 ...									
	Peripheral milling		$\varnothing DC (mm) =$									
			0,2	0,3	0,4-0,5	0,6-0,7	0,8-0,9	1	1,2-1,4	1,5	1,6-1,8	2
	$v_c (m/min)$	$a_{p,max.} \times DC$	$a_e 0,05 \times DC$									
			$f_z (mm)$									
P.1.3	140	1,0	0,005	0,005	0,009	0,009	0,014	0,014	0,018	0,023	0,027	0,032
P.2.3	140	1,0	0,005	0,005	0,009	0,009	0,014	0,014	0,018	0,023	0,027	0,032
P.3.3	140	1,0	0,005	0,005	0,009	0,009	0,014	0,014	0,018	0,023	0,027	0,032
H.1.1	119	1,0	0,005	0,005	0,009	0,009	0,014	0,014	0,018	0,023	0,027	0,032
H.1.2	112	1,0	0,004	0,004	0,007	0,007	0,011	0,011	0,014	0,018	0,022	0,025
H.1.3	105	1,0	0,003	0,003	0,006	0,006	0,009	0,009	0,012	0,015	0,018	0,021
H.1.4	77	1,0	0,002	0,002	0,005	0,005	0,007	0,007	0,010	0,012	0,014	0,017

Index	$T_x \leq 2,6-5,0 \times DC$		53 603 ..., 53 604 ...									
	Z-layer milling / face milling		$\varnothing DC (mm) =$									
			0,2	0,3	0,4-0,5	0,6-0,7	0,8-0,9	1	1,2-1,4	1,5	1,6-1,8	2
	$v_c (m/min)$	$a_{p,max.} \times DC$	$a_e 0,03 \times DC$									
			$f_z (mm)$									
P.1.3	84	0,07	0,002	0,002	0,005	0,005	0,007	0,007	0,009	0,011	0,014	0,016
P.2.3	84	0,07	0,002	0,002	0,005	0,005	0,007	0,007	0,009	0,011	0,014	0,016
P.3.3	84	0,07	0,002	0,002	0,005	0,005	0,007	0,007	0,009	0,011	0,014	0,016
H.1.1	77	0,05	0,002	0,002	0,005	0,005	0,007	0,007	0,009	0,011	0,014	0,016
H.1.2	70	0,05	0,002	0,002	0,004	0,004	0,005	0,005	0,007	0,009	0,011	0,013
H.1.3	56	0,03	0,002	0,002	0,003	0,003	0,005	0,005	0,006	0,008	0,009	0,011
H.1.4	60	0,03	0,002	0,002	0,003	0,003	0,005	0,005	0,006	0,008	0,010	0,011

Index	$T_x \leq 2,6-5,0 \times DC$		53 603 ..., 53 604 ...									
	Full slot		$\varnothing DC (mm) =$									
			0,2	0,3	0,4-0,5	0,6-0,7	0,8-0,9	1	1,2-1,4	1,5	1,6-1,8	2
	$v_c (m/min)$	$a_{p,max.} \times DC$	$a_e 1,0 \times DC$									
			$f_z (mm)$									
P.1.3	49	0,07	0,002	0,002	0,003	0,003	0,005	0,005	0,006	0,008	0,009	0,011
P.2.3	49	0,07	0,002	0,002	0,003	0,003	0,005	0,005	0,006	0,008	0,009	0,011
P.3.3	49	0,07	0,002	0,002	0,003	0,003	0,005	0,005	0,006	0,008	0,009	0,011
H.1.1	39	0,05	0,002	0,002	0,003	0,003	0,005	0,005	0,006	0,008	0,009	0,011
H.1.2	32	0,05	0,001	0,001	0,002	0,002	0,003	0,003	0,004	0,005	0,006	0,007
H.1.3												
H.1.4												



For improved surface quality, reduce f_z and allowance (a_e or a_p) by 30%!

Index	53 603 ..., 53 604 ...								● 1st choice ○ suitable		
	Ø DC (mm) =								Emulsion	Compressed air	MMS
	2,5	3	4	6	8	10	12				
	a _e 0,05 x DC										
f _z (mm)											
P.1.3	0,041	0,045	0,063	0,095	0,126	0,158	0,180	○	●	●	
P.2.3	0,041	0,045	0,063	0,095	0,126	0,158	0,180	○	●	●	
P.3.3	0,041	0,045	0,063	0,095	0,126	0,158	0,180	○	●	●	
H.1.1	0,041	0,045	0,063	0,095	0,126	0,158	0,180	○	●	●	
H.1.2	0,032	0,036	0,050	0,076	0,101	0,126	0,144	○	●	●	
H.1.3	0,027	0,030	0,042	0,063	0,084	0,105	0,120	○	●	●	
H.1.4	0,022	0,024	0,034	0,050	0,067	0,084	0,096	○	●	●	

Index	53 603 ..., 53 604 ...								● 1st choice ○ suitable		
	Ø DC (mm) =								Emulsion	Compressed air	MMS
	2,5	3	4	6	8	10	12				
	a _e 0,03 x DC										
f _z (mm)											
P.1.3	0,020	0,023	0,032	0,047	0,063	0,079	0,090	○	●	●	
P.2.3	0,020	0,023	0,032	0,047	0,063	0,079	0,090	○	●	●	
P.3.3	0,020	0,023	0,032	0,047	0,063	0,079	0,090	○	●	●	
H.1.1	0,020	0,023	0,032	0,047	0,063	0,079	0,090	○	●	●	
H.1.2	0,016	0,018	0,025	0,038	0,050	0,063	0,072	○	●	●	
H.1.3	0,014	0,015	0,021	0,032	0,042	0,053	0,060	○	●	●	
H.1.4	0,011	0,012	0,017	0,025	0,034	0,042	0,048	○	●	●	

Index	53 603 ..., 53 604 ...								● 1st choice ○ suitable		
	Ø DC (mm) =								Emulsion	Compressed air	MMS
	2,5	3	4	6	8	10	12				
	a _e 1,0 x DC										
f _z (mm)											
P.1.3	0,014	0,015	0,021	0,032	0,042	0,053	0,060	○	●	●	
P.2.3	0,014	0,015	0,021	0,032	0,042	0,053	0,060	○	●	●	
P.3.3	0,014	0,015	0,021	0,032	0,042	0,053	0,060	○	●	●	
H.1.1	0,014	0,015	0,021	0,032	0,042	0,053	0,060	○	●	●	
H.1.2	0,009	0,010	0,014	0,021	0,028	0,035	0,040	○	●	●	
H.1.3											
H.1.4											

Cutting data standard values – MonsterMill – HCR – End mill

Index	$T_x \leq 5,1-10,0 \times DC$		53 603 ..., 53 604 ...									
			$\varnothing DC (mm) =$									
	Peripheral milling		0,2	0,3	0,4-0,5	0,6-0,7	0,8-0,9	1	1,2-1,4	1,5	1,6-1,8	2
	$v_c (m/min)$	$a_{p,max.} \times DC$	$a_e 0,05 \times DC$									
		$f_z (mm)$										
P.1.3	110	0,75	0,003	0,003	0,006	0,006	0,009	0,009	0,012	0,015	0,018	0,021
P.2.3	110	0,75	0,003	0,003	0,006	0,006	0,009	0,009	0,012	0,015	0,018	0,021
P.3.3	110	0,75	0,003	0,003	0,006	0,006	0,009	0,009	0,012	0,015	0,018	0,021
H.1.1	94	0,75	0,003	0,003	0,006	0,006	0,009	0,009	0,012	0,015	0,018	0,021
H.1.2	88	0,75	0,002	0,002	0,005	0,005	0,007	0,007	0,010	0,012	0,014	0,017
H.1.3	83	0,75	0,002	0,002	0,004	0,004	0,006	0,006	0,008	0,010	0,012	0,014
H.1.4	61	0,75	0,002	0,002	0,003	0,003	0,005	0,005	0,006	0,008	0,010	0,011

Index	$T_x \leq 5,1-10,0 \times DC$		53 603 ..., 53 604 ...									
			$\varnothing DC (mm) =$									
	Z-layer milling / face milling		0,2	0,3	0,4-0,5	0,6-0,7	0,8-0,9	1	1,2-1,4	1,5	1,6-1,8	2
	$v_c (m/min)$	$a_{p,max.} \times DC$	$a_e 0,3 \times DC$									
		$f_z (mm)$										
P.1.3	66	0,07	0,002	0,002	0,003	0,003	0,005	0,005	0,006	0,008	0,009	0,011
P.2.3	66	0,07	0,002	0,002	0,003	0,003	0,005	0,005	0,006	0,008	0,009	0,011
P.3.3	66	0,07	0,002	0,002	0,003	0,003	0,005	0,005	0,006	0,008	0,009	0,011
H.1.1	61	0,05	0,002	0,002	0,003	0,003	0,005	0,005	0,006	0,008	0,009	0,011
H.1.2	55	0,05	0,001	0,001	0,002	0,002	0,004	0,004	0,005	0,006	0,007	0,008
H.1.3	44	0,03	0,001	0,001	0,002	0,002	0,003	0,003	0,004	0,005	0,006	0,007
H.1.4	33	0,03	0,001	0,001	0,002	0,002	0,002	0,002	0,003	0,004	0,005	0,006

Index	$T_x \leq 10,1-15,0 \times DC$		53 603 ..., 53 604 ...											● 1st choice ○ suitable		
			$\varnothing DC (mm) =$											Emulsion	Compressed air	MMS
	Peripheral milling		0,4-0,5	0,6-0,7	0,8-0,9	1	1,2-1,4	1,5	1,6-1,8	2	2,5	3	4			
	$v_c (m/min)$	$a_{p,max.} \times DC$	$a_e 0,05 \times DC$													
		$f_z (mm)$														
P.1.3	90	0,5	0,005	0,005	0,007	0,007	0,010	0,012	0,014	0,017	0,022	0,024	0,034	○	●	●
P.2.3	90	0,5	0,005	0,005	0,007	0,007	0,010	0,012	0,014	0,017	0,022	0,024	0,034	○	●	●
P.3.3	90	0,5	0,005	0,005	0,007	0,007	0,010	0,012	0,014	0,017	0,022	0,024	0,034	○	●	●
H.1.1	77	0,5	0,005	0,005	0,007	0,007	0,010	0,012	0,014	0,017	0,022	0,024	0,034	○	●	●
H.1.2	72	0,5	0,004	0,004	0,006	0,006	0,008	0,010	0,012	0,013	0,017	0,019	0,027	○	●	●
H.1.3	68	0,5	0,003	0,003	0,005	0,005	0,006	0,008	0,010	0,011	0,014	0,016	0,022	○	●	●
H.1.4	50	0,5	0,003	0,003	0,004	0,004	0,005	0,006	0,008	0,009	0,012	0,013	0,018	○	●	●

Index	$T_x \leq 10,1-15,0 \times DC$		53 603 ..., 53 604 ...											● 1st choice ○ suitable		
			$\varnothing DC (mm) =$											Emulsion	Compressed air	MMS
	Z-layer milling / face milling		0,4-0,5	0,6-0,7	0,8-0,9	1	1,2-1,4	1,5	1,6-1,8	2	2,5	3	4			
	$v_c (m/min)$	$a_{p,max.} \times DC$	$a_e 0,3 \times DC$													
		$f_z (mm)$														
P.1.3	90	0,5	0,005	0,005	0,007	0,007	0,010	0,012	0,014	0,017	0,022	0,024	0,034	○	●	●
P.2.3	90	0,5	0,005	0,005	0,007	0,007	0,010	0,012	0,014	0,017	0,022	0,024	0,034	○	●	●
P.3.3	90	0,5	0,005	0,005	0,007	0,007	0,010	0,012	0,014	0,017	0,022	0,024	0,034	○	●	●
H.1.1	77	0,5	0,005	0,005	0,007	0,007	0,010	0,012	0,014	0,017	0,022	0,024	0,034	○	●	●
H.1.2	72	0,5	0,004	0,004	0,006	0,006	0,008	0,010	0,012	0,013	0,017	0,019	0,027	○	●	●
H.1.3	68	0,5	0,003	0,003	0,005	0,005	0,006	0,008	0,010	0,011	0,014	0,016	0,022	○	●	●
H.1.4	50	0,5	0,003	0,003	0,004	0,004	0,005	0,006	0,008	0,009	0,012	0,013	0,018	○	●	●

 For improved surface quality, reduce f_z and allowance (a_e or a_p) by 30%!

Index	53 603 ..., 53 604 ...								● 1st choice ○ suitable		
	Ø DC (mm) =								Emulsion	Compressed air	MMS
	2,5	3	4	6	8	10	12				
	a _e 0,05 x DC										
f _z (mm)											
P.1.3	0,027	0,030	0,042	0,063	0,084	0,105	0,120	○	●	●	
P.2.3	0,027	0,030	0,042	0,063	0,084	0,105	0,120	○	●	●	
P.3.3	0,027	0,030	0,042	0,063	0,084	0,105	0,120	○	●	●	
H.1.1	0,027	0,030	0,042	0,063	0,084	0,105	0,120	○	●	●	
H.1.2	0,022	0,024	0,034	0,050	0,067	0,084	0,096	○	●	●	
H.1.3	0,018	0,020	0,028	0,042	0,056	0,070	0,080	○	●	●	
H.1.4	0,014	0,016	0,022	0,034	0,045	0,056	0,064	○	●	●	

Index	53 603 ..., 53 604 ...								● 1st choice ○ suitable		
	Ø DC (mm) =								Emulsion	Compressed air	MMS
	2,5	3	4	6	8	10	12				
	a _e 0,3 x DC										
f _z (mm)											
P.1.3	0,014	0,015	0,021	0,032	0,042	0,053	0,060	○	●	●	
P.2.3	0,014	0,015	0,021	0,032	0,042	0,053	0,060	○	●	●	
P.3.3	0,014	0,015	0,021	0,032	0,042	0,053	0,060	○	●	●	
H.1.1	0,014	0,015	0,021	0,032	0,042	0,053	0,060	○	●	●	
H.1.2	0,011	0,012	0,017	0,025	0,034	0,042	0,048	○	●	●	
H.1.3	0,009	0,010	0,014	0,021	0,028	0,035	0,040	○	●	●	
H.1.4	0,007	0,008	0,011	0,017	0,022	0,028	0,032	○	●	●	

Cutting data standard values – MonsterMill – HCR – End mill

Index	$T_x \leq 2 \times DC$		53 605 ...								● 1st choice ○ suitable		
			$\varnothing DC (mm) =$								Emulsion	Compressed air	MMS
			1	2	3	4	6	8	10	12			
	$v_c (m/min)$	$a_{p,max.} \times DC$	$a_e 0,05 \times DC$								$f_z (mm)$		
P.1.3	200	2,0	0,018	0,027	0,038	0,051	0,075	0,093	0,120	0,135	○	●	●
P.2.3	200	2,0	0,018	0,027	0,038	0,051	0,075	0,093	0,120	0,135	○	●	●
P.3.3	200	2,0	0,018	0,027	0,038	0,051	0,075	0,093	0,120	0,135	○	●	●
H.1.1	160	2,0	0,018	0,027	0,038	0,051	0,075	0,093	0,120	0,135	○	●	●
H.1.2	130	2,0	0,014	0,022	0,030	0,041	0,060	0,074	0,096	0,108	○	●	●
H.1.3	120	2,0	0,012	0,018	0,025	0,034	0,050	0,062	0,080	0,090	○	●	●
H.1.4	110	2,0	0,010	0,014	0,020	0,027	0,040	0,050	0,064	0,072	○	●	●

Index	$T_x \leq 2 \times DC$		53 605 ...								● 1st choice ○ suitable		
			$\varnothing DC (mm) =$								Emulsion	Compressed air	MMS
			1	2	3	4	6	8	10	12			
	$v_c (m/min)$	$a_{p,max.} \times DC$	$a_e 0,05 \times DC$								$f_z (mm)$		
P.1.3	120	0,07	0,015	0,021	0,030	0,042	0,063	0,084	0,105	0,120	○	●	●
P.2.3	120	0,07	0,015	0,021	0,030	0,042	0,063	0,084	0,105	0,120	○	●	●
P.3.3	120	0,07	0,015	0,021	0,030	0,042	0,063	0,084	0,105	0,120	○	●	●
H.1.1	110	0,05	0,015	0,021	0,030	0,042	0,063	0,084	0,105	0,120	○	●	●
H.1.2	90	0,05	0,012	0,017	0,024	0,034	0,050	0,067	0,084	0,096	○	●	●
H.1.3	75	0,03	0,010	0,014	0,020	0,028	0,042	0,056	0,070	0,080	○	●	●
H.1.4	60	0,03	0,008	0,011	0,016	0,022	0,034	0,045	0,056	0,064	○	●	●

Index	$T_x \leq 3 \times DC$		53 606 ...								● 1st choice ○ suitable		
			$\varnothing DC (mm) =$								Emulsion	Compressed air	MMS
			1	2	3	4	6	8	10	12			
	$v_c (m/min)$	$a_{p,max.} \times DC$	$a_e 0,04 \times DC$								$f_z (mm)$		
P.1.3	140	2,0	0,014	0,024	0,033	0,045	0,066	0,083	0,105	0,120	○	●	●
P.2.3	140	2,0	0,014	0,024	0,033	0,045	0,066	0,083	0,105	0,120	○	●	●
P.3.3	140	2,0	0,014	0,024	0,033	0,045	0,066	0,083	0,105	0,120	○	●	●
H.1.1	119	2,0	0,014	0,024	0,033	0,045	0,066	0,083	0,105	0,120	○	●	●
H.1.2	112	2,0	0,011	0,019	0,026	0,036	0,053	0,066	0,084	0,096	○	●	●
H.1.3	105	2,0	0,009	0,016	0,022	0,030	0,044	0,055	0,070	0,080	○	●	●
H.1.4	77	2,0	0,007	0,013	0,018	0,024	0,035	0,044	0,056	0,064	○	●	●

Index	$T_x \leq 3 \times DC$		53 606 ...								● 1st choice ○ suitable		
			$\varnothing DC (mm) =$								Emulsion	Compressed air	MMS
			1	2	3	4	6	8	10	12			
	$v_c (m/min)$	$a_{p,max.} \times DC$	$a_e 0,04 \times DC$								$f_z (mm)$		
P.1.3	105	0,07	0,009	0,014	0,023	0,036	0,054	0,072	0,090	0,105	○	●	●
P.2.3	105	0,07	0,009	0,014	0,023	0,036	0,054	0,072	0,090	0,105	○	●	●
P.3.3	105	0,07	0,009	0,014	0,023	0,036	0,054	0,072	0,090	0,105	○	●	●
H.1.1	84	0,05	0,009	0,014	0,023	0,036	0,054	0,072	0,090	0,105	○	●	●
H.1.2	77	0,05	0,007	0,011	0,018	0,029	0,043	0,058	0,072	0,084	○	●	●
H.1.3	63	0,03	0,006	0,009	0,015	0,024	0,036	0,048	0,060	0,070	○	●	●
H.1.4	42	0,03	0,005	0,007	0,012	0,019	0,029	0,038	0,048	0,056	○	●	●

 For improved surface quality, reduce f_z and allowance (a_e or a_p) by 30%!

Cutting data standard values – MonsterMill – HCR – Ball-nosed end mill

Index	$T_x \leq 2,5 \times DC$		53 602 ...						● 1st choice ○ suitable		
			$\emptyset DC (mm) =$						Emulsion	Compressed air	MMS
			3	4	6	8	10	12			
			$a_e, 0,05 \times DC$								
$v_c (m/min)$	$a_{p,max.} \times DC$	$f_z (mm)$									
P.1.3	200	0,07	0,038	0,050	0,076	0,101	0,126	0,151	○	●	●
P.2.3	200	0,07	0,038	0,050	0,076	0,101	0,126	0,151	○	●	●
P.3.3	200	0,07	0,038	0,050	0,076	0,101	0,126	0,151	○	●	●
H.1.1	180	0,05	0,038	0,050	0,076	0,101	0,126	0,151	○	●	●
H.1.2	160	0,05	0,030	0,040	0,060	0,081	0,101	0,121	○	●	●
H.1.3	150	0,03	0,025	0,034	0,050	0,067	0,084	0,101	○	●	●
H.1.4	130	0,03	0,020	0,027	0,040	0,054	0,067	0,081	○	●	●

Index	$T_x \leq 2,6-5,0 \times DC$		53 602 ...						● 1st choice ○ suitable		
			$\emptyset DC (mm) =$						Emulsion	Compressed air	MMS
			3	4	6	8	10	12			
			$a_e, 0,05 \times DC$								
$v_c (m/min)$	$a_{p,max.} \times DC$	$f_z (mm)$									
P.1.3	120	0,07	0,03	0,04	0,053	0,073	0,093	0,113	○	●	●
P.2.3	120	0,07	0,03	0,04	0,053	0,073	0,093	0,113	○	●	●
P.3.3	120	0,07	0,03	0,04	0,053	0,073	0,093	0,113	○	●	●
H.1.1	108	0,05	0,030	0,040	0,053	0,073	0,093	0,113	○	●	●
H.1.2	96	0,05	0,024	0,032	0,042	0,058	0,075	0,091	○	●	●
H.1.3	90	0,03	0,020	0,027	0,035	0,049	0,062	0,076	○	●	●
H.1.4	78	0,03	0,016	0,022	0,028	0,039	0,050	0,060	○	●	●

Index	$T_x \leq 5,1-10,0 \times DC$		53 602 ...						● 1st choice ○ suitable		
			$\emptyset DC (mm) =$						Emulsion	Compressed air	MMS
			3	4	6	8	10	12			
			$a_e, 0,04 \times DC$								
$v_c (m/min)$	$a_{p,max.} \times DC$	$f_z (mm)$									
P.1.3	90	0,06	0,023	0,030	0,030	0,045	0,060	0,076	○	●	●
P.2.3	90	0,06	0,023	0,030	0,030	0,045	0,060	0,076	○	●	●
P.3.3	90	0,06	0,023	0,030	0,030	0,045	0,060	0,076	○	●	●
H.1.1	81	0,04	0,023	0,030	0,030	0,045	0,060	0,076	○	●	●
H.1.2	72	0,04	0,018	0,024	0,024	0,036	0,048	0,060	○	●	●
H.1.3	68	0,02	0,015	0,020	0,020	0,030	0,040	0,050	○	●	●
H.1.4	59	0,02	0,012	0,016	0,016	0,024	0,032	0,040	○	●	●

Cutting data standard values – MonsterMill – HCR – Ball-nosed end mill

Index	$T_x \leq 2,5 \times DC$		53 600 ..., 53 601 ...									
			$\varnothing DC (mm) =$									
			0,2	0,3	0,4–0,5	0,6–0,7	0,8–0,9	1	1,2–1,4	1,5	1,6–1,8	2
			$a_e 0,05 \times DC$									
$v_c (m/min)$	$a_{p,max.} \times DC$	$f_z (mm)$										
P.1.3	200	0,07	0,003	0,006	0,008	0,011	0,015	0,018	0,021	0,027	0,033	0,036
P.2.3	200	0,07	0,003	0,006	0,008	0,011	0,015	0,018	0,021	0,027	0,033	0,036
P.3.3	200	0,07	0,003	0,006	0,008	0,011	0,015	0,018	0,021	0,027	0,033	0,036
H.1.1	180	0,05	0,003	0,006	0,008	0,011	0,015	0,018	0,021	0,027	0,033	0,036
H.1.2	160	0,05	0,002	0,005	0,006	0,008	0,012	0,014	0,017	0,022	0,026	0,029
H.1.3	150	0,03	0,002	0,004	0,005	0,007	0,010	0,012	0,014	0,018	0,022	0,024
H.1.4	130	0,03	0,002	0,003	0,004	0,006	0,008	0,010	0,011	0,014	0,018	0,019

Index	$T_x \leq 2,6–5,0 \times DC$		53 600 ..., 53 601 ...									
			$\varnothing DC (mm) =$									
			0,2	0,3	0,4–0,5	0,6–0,7	0,8–0,9	1	1,2–1,4	1,5	1,6–1,8	2
			$a_e 0,05 \times DC$									
$v_c (m/min)$	$a_{p,max.} \times DC$	$f_z (mm)$										
P.1.3	120	0,07	0,002	0,005	0,006	0,008	0,012	0,014	0,017	0,022	0,026	0,029
P.2.3	120	0,07	0,002	0,005	0,006	0,008	0,012	0,014	0,017	0,022	0,026	0,029
P.3.3	120	0,07	0,002	0,005	0,006	0,008	0,012	0,014	0,017	0,022	0,026	0,029
H.1.1	108	0,05	0,002	0,005	0,006	0,008	0,012	0,014	0,017	0,022	0,026	0,029
H.1.2	96	0,05	0,002	0,004	0,005	0,007	0,010	0,011	0,014	0,017	0,020	0,023
H.1.3	90	0,03	0,002	0,003	0,004	0,006	0,008	0,010	0,012	0,015	0,017	0,019
H.1.4	78	0,03	0,001	0,002	0,003	0,004	0,006	0,008	0,009	0,012	0,014	0,015

Index	$T_x \leq 5,1–10,0 \times DC$		53 600 ..., 53 601 ...									
			$\varnothing DC (mm) =$									
			0,2	0,3	0,4–0,5	0,6–0,7	0,8–0,9	1	1,2–1,4	1,5	1,6–1,8	2
			$a_e 0,05 \times DC$									
$v_c (m/min)$	$a_{p,max.} \times DC$	$f_z (mm)$										
P.1.3	90	0,06	0,002	0,003	0,005	0,006	0,009	0,011	0,014	0,017	0,018	0,021
P.2.3	90	0,06	0,002	0,003	0,005	0,006	0,009	0,011	0,014	0,017	0,018	0,021
P.3.3	90	0,06	0,002	0,003	0,005	0,006	0,009	0,011	0,014	0,017	0,018	0,021
H.1.1	81	0,04	0,002	0,003	0,005	0,006	0,009	0,011	0,014	0,017	0,018	0,021
H.1.2	72	0,04	0,001	0,002	0,004	0,005	0,007	0,008	0,011	0,013	0,014	0,017
H.1.3	68	0,02	0,001	0,002	0,003	0,004	0,006	0,007	0,009	0,011	0,012	0,014
H.1.4	59	0,02	0,001	0,002	0,002	0,003	0,005	0,006	0,007	0,009	0,010	0,011

Index	$T_x \leq 10,1–15,0 \times DC$		53 600 ..., 53 601 ...									
			$\varnothing DC (mm) =$									
			0,2	0,3	0,4–0,5	0,6–0,7	0,8–0,9	1	1,2–1,4	1,5	1,6–1,8	2
			$a_e 0,04 \times DC$									
$v_c (m/min)$	$a_{p,max.} \times DC$	$f_z (mm)$										
P.1.3	70	0,05	0,002	0,002	0,003	0,005	0,006	0,008	0,009	0,011	0,012	0,015
P.2.3	70	0,05	0,002	0,002	0,003	0,005	0,006	0,008	0,009	0,011	0,012	0,015
P.3.3	70	0,05	0,002	0,002	0,003	0,005	0,006	0,008	0,009	0,011	0,012	0,015
H.1.1	63	0,03	0,002	0,002	0,003	0,005	0,006	0,008	0,009	0,011	0,012	0,015
H.1.2	56	0,03	0,001	0,001	0,002	0,004	0,005	0,006	0,007	0,008	0,010	0,012
H.1.3	53	0,01	0,001	0,001	0,002	0,003	0,004	0,005	0,006	0,007	0,008	0,010
H.1.4	46	0,01	0,001	0,001	0,002	0,002	0,003	0,004	0,005	0,006	0,006	0,008

 For improved surface quality, reduce f_z and allowance (a_e or a_p) by 30%!

Index	53 600 ..., 53 601 ...								● 1st choice ○ suitable		
	Ø DC (mm) =								Emulsion	Compressed air	MMS
	2,5	3	4	6	8	10	12				
	a _e 0,05 x DC										
f _z (mm)											
P.1.3	0,045	0,054	0,072	0,108	0,144	0,180	0,216	○	●	●	
P.2.3	0,045	0,054	0,072	0,108	0,144	0,180	0,216	○	●	●	
P.3.3	0,045	0,054	0,072	0,108	0,144	0,180	0,216	○	●	●	
H.1.1	0,045	0,054	0,072	0,108	0,144	0,180	0,216	○	●	●	
H.1.2	0,036	0,043	0,058	0,086	0,115	0,144	0,173	○	●	●	
H.1.3	0,030	0,036	0,048	0,072	0,096	0,120	0,144	○	●	●	
H.1.4	0,024	0,029	0,038	0,058	0,077	0,096	0,115	○	●	●	

Index	53 600 ..., 53 601 ...								● 1st choice ○ suitable		
	Ø DC (mm) =								Emulsion	Compressed air	MMS
	2,5	3	4	6	8	10	12				
	a _e 0,05 x DC										
f _z (mm)											
P.1.3	0,036	0,044	0,058	0,076	0,104	0,133	0,162	○	●	●	
P.2.3	0,036	0,044	0,058	0,076	0,104	0,133	0,162	○	●	●	
P.3.3	0,036	0,044	0,058	0,076	0,104	0,133	0,162	○	●	●	
H.1.1	0,036	0,044	0,058	0,076	0,104	0,133	0,162	○	●	●	
H.1.2	0,029	0,035	0,046	0,060	0,084	0,107	0,130	○	●	●	
H.1.3	0,024	0,029	0,039	0,050	0,070	0,089	0,108	○	●	●	
H.1.4	0,019	0,023	0,031	0,040	0,056	0,071	0,086	○	●	●	

Index	53 600 ..., 53 601 ...								● 1st choice ○ suitable		
	Ø DC (mm) =								Emulsion	Compressed air	MMS
	2,5	3	4	6	8	10	12				
	a _e 0,05 x DC										
f _z (mm)											
P.1.3	0,027	0,033	0,044	0,043	0,065	0,086	0,108	○	●	●	
P.2.3	0,027	0,033	0,044	0,043	0,065	0,086	0,108	○	●	●	
P.3.3	0,027	0,033	0,044	0,043	0,065	0,086	0,108	○	●	●	
H.1.1	0,027	0,033	0,044	0,043	0,065	0,086	0,108	○	●	●	
H.1.2	0,022	0,026	0,035	0,035	0,052	0,069	0,086	○	●	●	
H.1.3	0,018	0,022	0,029	0,029	0,043	0,058	0,072	○	●	●	
H.1.4	0,014	0,018	0,023	0,023	0,035	0,046	0,058	○	●	●	

Index	53 600 ..., 53 601 ...								● 1st choice ○ suitable		
	Ø DC (mm) =								Emulsion	Compressed air	MMS
	2,5	3	4	6	8	10	12				
	a _e 0,04 x DC				a _e 0,05 x DC						
f _z (mm)											
P.1.3	0,021	0,027	0,035	0,035	0,052	0,069	0,086	○	●	●	
P.2.3	0,021	0,027	0,035	0,035	0,052	0,069	0,086	○	●	●	
P.3.3	0,021	0,027	0,035	0,035	0,052	0,069	0,086	○	●	●	
H.1.1	0,021	0,027	0,035	0,035	0,052	0,069	0,086	○	●	●	
H.1.2	0,017	0,022	0,028	0,028	0,041	0,055	0,069	○	●	●	
H.1.3	0,014	0,018	0,023	0,023	0,035	0,046	0,058	○	●	●	
H.1.4	0,011	0,014	0,019	0,018	0,028	0,037	0,046	○	●	●	

Cutting data standard values – MonsterMill – PCR – End mill, UNI version

Index	Short / long / extra long version	52 613 ..., 52 614 ..., 52 615 ..., 52 619 ...																						
		v_c (m/min)	$a_{p,max}$ x DC	$\varnothing DC$ (mm) =																				
				5,0			5,7-6,0			6,7-7,0			7,7-8,0			8,7-9,0			9,7-10,0			11,7-12,0		
				a_p 0,1-0,2 x DC	a_p 0,3-0,4 x DC	a_p 0,6-1,0 x DC	a_p 0,1-0,2 x DC	a_p 0,3-0,4 x DC	a_p 0,6-1,0 x DC	a_p 0,1-0,2 x DC	a_p 0,3-0,4 x DC	a_p 0,6-1,0 x DC	a_p 0,1-0,2 x DC	a_p 0,3-0,4 x DC	a_p 0,6-1,0 x DC	a_p 0,1-0,2 x DC	a_p 0,3-0,4 x DC	a_p 0,6-1,0 x DC	a_p 0,1-0,2 x DC	a_p 0,3-0,4 x DC	a_p 0,6-1,0 x DC	a_p 0,1-0,2 x DC	a_p 0,3-0,4 x DC	a_p 0,6-1,0 x DC
f_z (mm)																								
P.1.1	240	1,0	0,096	0,068	0,043	0,107	0,075	0,048	0,122	0,086	0,054	0,136	0,096	0,061	0,150	0,106	0,067	0,163	0,115	0,073	0,188	0,133	0,084	
P.1.2	230	1,0	0,092	0,065	0,041	0,102	0,072	0,046	0,116	0,082	0,052	0,130	0,092	0,058	0,143	0,101	0,064	0,156	0,110	0,070	0,179	0,127	0,080	
P.1.3	220	1,0	0,087	0,062	0,039	0,097	0,069	0,043	0,111	0,078	0,050	0,124	0,088	0,055	0,136	0,096	0,061	0,148	0,105	0,066	0,171	0,121	0,076	
P.1.4	205	1,0	0,083	0,059	0,037	0,092	0,065	0,041	0,105	0,074	0,047	0,118	0,083	0,053	0,130	0,092	0,058	0,141	0,100	0,063	0,162	0,115	0,072	
P.1.5	195	1,0	0,079	0,056	0,035	0,087	0,062	0,039	0,100	0,070	0,045	0,111	0,079	0,050	0,123	0,087	0,055	0,134	0,094	0,060	0,153	0,109	0,069	
P.2.1	220	1,0	0,096	0,068	0,043	0,107	0,075	0,048	0,122	0,086	0,054	0,136	0,096	0,061	0,150	0,106	0,067	0,163	0,115	0,073	0,188	0,133	0,084	
P.2.2	200	1,0	0,087	0,062	0,039	0,097	0,069	0,043	0,111	0,078	0,050	0,124	0,088	0,055	0,136	0,096	0,061	0,148	0,105	0,066	0,171	0,121	0,076	
P.2.3	180	1,0	0,079	0,056	0,035	0,087	0,062	0,039	0,100	0,070	0,045	0,111	0,079	0,050	0,123	0,087	0,055	0,134	0,094	0,060	0,153	0,109	0,069	
P.2.4	140	1,0	0,073	0,051	0,033	0,081	0,057	0,036	0,092	0,065	0,041	0,103	0,073	0,046	0,114	0,080	0,051	0,124	0,087	0,055	0,142	0,100	0,064	
P.3.1	130	1,0	0,084	0,060	0,038	0,094	0,066	0,042	0,107	0,076	0,048	0,120	0,085	0,054	0,132	0,093	0,059	0,143	0,101	0,064	0,165	0,117	0,074	
P.3.2	120	1,0	0,080	0,057	0,036	0,089	0,063	0,040	0,101	0,072	0,045	0,114	0,080	0,051	0,125	0,088	0,056	0,136	0,096	0,061	0,156	0,111	0,070	
P.3.3	110	1,0	0,076	0,053	0,034	0,084	0,059	0,038	0,096	0,068	0,043	0,107	0,076	0,048	0,118	0,084	0,053	0,129	0,091	0,058	0,148	0,104	0,066	
P.4.1	90	1,0	0,058	0,041	0,026	0,065	0,046	0,029	0,074	0,052	0,033	0,083	0,058	0,037	0,091	0,064	0,041	0,099	0,070	0,044	0,114	0,080	0,051	
P.4.2	90	1,0	0,058	0,041	0,026	0,065	0,046	0,029	0,074	0,052	0,033	0,083	0,058	0,037	0,091	0,064	0,041	0,099	0,070	0,044	0,114	0,080	0,051	
M.1.1	60	1,0	0,051	0,036	0,023	0,057	0,040	0,025	0,065	0,046	0,029	0,072	0,051	0,032	0,080	0,056	0,036	0,087	0,061	0,039	0,099	0,070	0,044	
M.2.1	55	1,0	0,042	0,030	0,019	0,047	0,033	0,021	0,054	0,038	0,024	0,060	0,042	0,027	0,066	0,047	0,029	0,072	0,051	0,032	0,082	0,058	0,037	
M.3.1	60	1,0	0,044	0,031	0,020	0,048	0,034	0,022	0,055	0,039	0,025	0,062	0,044	0,028	0,068	0,048	0,031	0,074	0,052	0,033	0,085	0,060	0,038	
K.1.1	240	1,0	0,145	0,103	0,065	0,162	0,114	0,072	0,185	0,130	0,083	0,206	0,146	0,092	0,227	0,161	0,102	0,247	0,175	0,111	0,284	0,201	0,127	
K.1.2	180	1,0	0,102	0,072	0,046	0,113	0,080	0,051	0,129	0,091	0,058	0,145	0,102	0,065	0,159	0,113	0,071	0,173	0,122	0,077	0,199	0,141	0,089	
K.2.1	220	1,0	0,124	0,087	0,055	0,137	0,097	0,061	0,157	0,111	0,070	0,175	0,124	0,078	0,193	0,137	0,086	0,210	0,149	0,094	0,242	0,171	0,108	
K.2.2	180	1,0	0,102	0,072	0,046	0,113	0,080	0,051	0,129	0,091	0,058	0,145	0,102	0,065	0,159	0,113	0,071	0,173	0,122	0,077	0,199	0,141	0,089	
K.3.1	160	1,0	0,102	0,072	0,046	0,113	0,080	0,051	0,129	0,091	0,058	0,145	0,102	0,065	0,159	0,113	0,071	0,173	0,122	0,077	0,199	0,141	0,089	
K.3.2	150	1,0	0,087	0,062	0,039	0,097	0,069	0,043	0,111	0,078	0,050	0,124	0,088	0,055	0,136	0,096	0,061	0,148	0,105	0,066	0,171	0,121	0,076	
N.1.1																								
N.1.2																								
N.2.1																								
N.2.2																								
N.2.3																								
N.3.1																								
N.3.2																								
N.3.3																								
N.4.1																								
S.1.1																								
S.1.2																								
S.2.1																								
S.2.2																								
S.2.3																								
S.3.1																								
S.3.2																								
S.3.3																								
H.1.1																								
H.1.2																								
H.1.3																								
H.1.4																								
H.2.1																								
H.3.1																								
O.1.1																								
O.1.2																								
O.2.1																								
O.2.2																								
O.3.1																								

 With an a_p of 1.5 x DC the f_z should be multiplied by 0.75.

Index	52 613 ..., 52 614 ..., 52 615 ..., 52 619 ...											● 1st choice ○ suitable					
	Ø DC (mm) =									Ramping 1,0 x DC Max. plunging angle	Helical milling		Drilling 1,0 x DC f _z Factor	Emulsion	Compressed air	MMS	
	13,7–14,0			15,5–16,0			17,5–20,0				α _{R max.} *	Hole diameter					
	a _s 0,1–0,2 x DC	a _s 0,3–0,4 x DC	a _s 0,6–1,0 x DC	a _s 0,1–0,2 x DC	a _s 0,3–0,4 x DC	a _s 0,6–1,0 x DC	a _s 0,1–0,2 x DC	a _s 0,3–0,4 x DC	a _s 0,6–1,0 x DC	D _{min.} DC x 1,5		D _{max.} DC x 1,8	f _z				
P.1.1	0,209	0,148	0,094	0,229	0,162	0,102	0,262	0,185	0,117	45	0,75 x DC	25°	16°	0,9	○	●	○
P.1.2	0,200	0,141	0,089	0,219	0,155	0,098	0,250	0,177	0,112	45	0,75 x DC	25°	16°	0,9	○	●	○
P.1.3	0,190	0,135	0,085	0,208	0,147	0,093	0,238	0,168	0,107	45	0,75 x DC	25°	16°	0,9	○	●	○
P.1.4	0,181	0,128	0,081	0,198	0,140	0,088	0,226	0,160	0,101	45	0,75 x DC	25°	16°	0,9	○	●	○
P.1.5	0,171	0,121	0,077	0,187	0,133	0,084	0,214	0,152	0,096	45	0,75 x DC	25°	16°	0,9	○	●	○
P.2.1	0,209	0,148	0,094	0,229	0,162	0,102	0,262	0,185	0,117	45	0,75 x DC	25°	16°	0,8	○	●	○
P.2.2	0,190	0,135	0,085	0,208	0,147	0,093	0,238	0,168	0,107	45	0,75 x DC	25°	16°	0,8	○	●	○
P.2.3	0,171	0,121	0,077	0,187	0,133	0,084	0,214	0,152	0,096	45	0,75 x DC	25°	16°	0,8	○	●	○
P.2.4	0,159	0,112	0,071	0,174	0,123	0,078	0,198	0,140	0,089	45	0,75 x DC	25°	16°	0,7	○	●	○
P.3.1	0,184	0,130	0,082	0,201	0,142	0,090	0,230	0,163	0,103	30	0,5 x DC	18°	11°	0,8	●		○
P.3.2	0,175	0,123	0,078	0,191	0,135	0,085	0,218	0,154	0,098	30	0,5 x DC	18°	11°	0,7	●		○
P.3.3	0,165	0,117	0,074	0,181	0,128	0,081	0,206	0,146	0,092	30	0,5 x DC	18°	11°	0,7	●		○
P.4.1	0,127	0,090	0,057	0,139	0,098	0,062	0,159	0,112	0,071	15	0,5 x DC	18°	11°		●		○
P.4.2	0,127	0,090	0,057	0,139	0,098	0,062	0,159	0,112	0,071	15	0,5 x DC	18°	11°		●		○
M.1.1	0,111	0,079	0,050	0,122	0,086	0,054	0,139	0,098	0,062	15	0,5 x DC	18°	11°		●		
M.2.1	0,092	0,065	0,041	0,101	0,071	0,045	0,115	0,081	0,051	15	0,5 x DC	18°	11°		●		
M.3.1	0,095	0,067	0,043	0,104	0,074	0,047	0,119	0,084	0,053	15	0,5 x DC	18°	11°		●		
K.1.1	0,317	0,224	0,142	0,347	0,245	0,155	0,397	0,281	0,178	45	0,75 x DC	25°	16°	0,8		●	
K.1.2	0,222	0,157	0,099	0,243	0,172	0,109	0,278	0,196	0,124	45	0,75 x DC	25°	16°	0,8		●	
K.2.1	0,270	0,191	0,121	0,295	0,209	0,132	0,337	0,239	0,151	45	0,75 x DC	25°	16°	0,8		●	
K.2.2	0,222	0,157	0,099	0,243	0,172	0,109	0,278	0,196	0,124	45	0,75 x DC	25°	16°	0,8		●	
K.3.1	0,222	0,157	0,099	0,243	0,172	0,109	0,278	0,196	0,124	45	0,75 x DC	25°	16°	0,8		●	
K.3.2	0,190	0,135	0,085	0,208	0,147	0,093	0,238	0,168	0,107	45	0,75 x DC	25°	16°	0,8		●	
N.1.1																	
N.1.2																	
N.2.1																	
N.2.2																	
N.2.3																	
N.3.1																	
N.3.2																	
N.3.3																	
N.4.1																	
S.1.1																	
S.1.2																	
S.2.1																	
S.2.2																	
S.2.3																	
S.3.1																	
S.3.2																	
S.3.3																	
H.1.1																	
H.1.2																	
H.1.3																	
H.1.4																	
H.2.1																	
H.3.1																	
O.1.1																	
O.1.2																	
O.2.1																	
O.2.2																	
O.3.1																	

* Width of cut per helical revolution

Cutting data for ramping and helical milling = 100 %
Multiply cutting data for drilling by the factor from the table

Cutting data standard values – MonsterMill – PCR – End mill, UNI version – trochoidal

Index	Type long		52 619																			
	v _c (m/min)	max. angle of engagement	Ø DC (mm) =																			
			5				6				8				10				12			
			a _p 0,05 x DC	a _p 0,1 x DC	a _p 0,15 x DC	h _m	a _p 0,05 x DC	a _p 0,1 x DC	a _p 0,15 x DC	h _m	a _p 0,05 x DC	a _p 0,1 x DC	a _p 0,15 x DC	h _m	a _p 0,05 x DC	a _p 0,1 x DC	a _p 0,15 x DC	h _m	a _p 0,05 x DC	a _p 0,1 x DC	a _p 0,15 x DC	h _m
f _z (mm)				f _z (mm)				f _z (mm)				f _z (mm)				f _z (mm)						
P.1.1	505	46°	0,09	0,07	0,05	0,021	0,11	0,08	0,06	0,025	0,14	0,10	0,08	0,032	0,17	0,12	0,10	0,038	0,19	0,14	0,11	0,043
P.1.2	480	46°	0,09	0,06	0,05	0,020	0,11	0,07	0,06	0,024	0,13	0,10	0,08	0,030	0,16	0,11	0,09	0,036	0,19	0,13	0,11	0,041
P.1.3	460	46°	0,09	0,06	0,05	0,019	0,10	0,07	0,06	0,022	0,13	0,09	0,07	0,029	0,15	0,11	0,09	0,034	0,18	0,12	0,10	0,039
P.1.4	435	46°	0,08	0,06	0,05	0,018	0,10	0,07	0,06	0,021	0,12	0,09	0,07	0,027	0,15	0,10	0,08	0,033	0,17	0,12	0,10	0,038
P.1.5	415	46°	0,08	0,05	0,04	0,017	0,09	0,06	0,05	0,020	0,12	0,08	0,07	0,026	0,14	0,10	0,08	0,031	0,16	0,11	0,09	0,036
P.2.1	460	46°	0,09	0,07	0,05	0,021	0,11	0,08	0,06	0,025	0,14	0,10	0,08	0,032	0,17	0,12	0,10	0,038	0,19	0,14	0,11	0,043
P.2.2	415	46°	0,09	0,06	0,05	0,019	0,10	0,07	0,06	0,022	0,13	0,09	0,07	0,029	0,15	0,11	0,09	0,034	0,18	0,12	0,10	0,039
P.2.3	375	46°	0,08	0,05	0,04	0,017	0,09	0,06	0,05	0,020	0,12	0,08	0,07	0,026	0,14	0,10	0,08	0,031	0,16	0,11	0,09	0,036
P.2.4	290	46°	0,07	0,05	0,04	0,016	0,08	0,06	0,05	0,019	0,11	0,08	0,06	0,024	0,13	0,09	0,07	0,029	0,15	0,10	0,08	0,033
P.3.1	270	46°	0,08	0,06	0,05	0,018	0,10	0,07	0,06	0,022	0,12	0,09	0,07	0,028	0,15	0,10	0,09	0,033	0,17	0,12	0,10	0,038
P.3.2	250	46°	0,08	0,06	0,05	0,018	0,09	0,07	0,05	0,021	0,12	0,08	0,07	0,026	0,14	0,10	0,08	0,031	0,16	0,11	0,09	0,036
P.3.3	230	46°	0,07	0,05	0,04	0,017	0,09	0,06	0,05	0,019	0,11	0,08	0,06	0,025	0,13	0,09	0,08	0,030	0,15	0,11	0,09	0,034
P.4.1	190	46°	0,06	0,04	0,03	0,013	0,07	0,05	0,04	0,015	0,09	0,06	0,05	0,019	0,10	0,07	0,06	0,023	0,12	0,08	0,07	0,026
P.4.2	190	46°	0,06	0,04	0,03	0,013	0,07	0,05	0,04	0,015	0,09	0,06	0,05	0,019	0,10	0,07	0,06	0,023	0,12	0,08	0,07	0,026
M.1.1	220	35°	0,05	0,03		0,011	0,06	0,04		0,013	0,08	0,05		0,018	0,10	0,06		0,022	0,12	0,07		0,027
M.2.1	200	35°	0,06	0,04		0,013	0,07	0,05		0,016	0,10	0,06		0,021	0,12	0,08		0,027	0,14	0,10		0,032
M.3.1	200	35°	0,06	0,04		0,013	0,07	0,05		0,016	0,10	0,06		0,021	0,12	0,08		0,027	0,14	0,10		0,032
K.1.1	500	46°	0,14	0,10	0,08	0,032	0,17	0,12	0,10	0,037	0,21	0,15	0,12	0,048	0,26	0,18	0,15	0,057	0,29	0,21	0,17	0,066
K.1.2	375	46°	0,10	0,07	0,06	0,022	0,12	0,08	0,07	0,026	0,15	0,11	0,09	0,033	0,18	0,13	0,10	0,040	0,21	0,15	0,12	0,046
K.2.1	460	46°	0,12	0,09	0,07	0,027	0,14	0,10	0,08	0,032	0,18	0,13	0,10	0,041	0,22	0,15	0,13	0,049	0,25	0,18	0,14	0,056
K.2.2	375	46°	0,10	0,07	0,06	0,022	0,12	0,08	0,07	0,026	0,15	0,11	0,09	0,033	0,18	0,13	0,10	0,040	0,21	0,15	0,12	0,046
K.3.1	335	46°	0,10	0,07	0,06	0,022	0,12	0,08	0,07	0,026	0,15	0,11	0,09	0,033	0,18	0,13	0,10	0,040	0,21	0,15	0,12	0,046
K.3.2	315	46°	0,09	0,06	0,05	0,019	0,10	0,07	0,06	0,022	0,13	0,09	0,07	0,029	0,15	0,11	0,09	0,034	0,18	0,12	0,10	0,039
N.1.1																						
N.1.2																						
N.2.1																						
N.2.2																						
N.2.3																						
N.3.1																						
N.3.2																						
N.3.3																						
N.4.1																						
S.1.1																						
S.1.2																						
S.2.1																						
S.2.2																						
S.2.3																						
S.3.1																						
S.3.2																						
S.3.3																						
H.1.1																						
H.1.2																						
H.1.3																						
H.1.4																						
H.2.1																						
H.3.1																						
O.1.1																						
O.1.2																						
O.2.1																						
O.2.2																						
O.3.1																						

milling

Index	52 619																● 1st choice		
	Ø DC (mm) =																○ suitable		
	14				16				18				20				Emulsion	Compressed air	MMS
	a_p 0,05 x DC	a_p 0,1 x DC	a_p 0,15 x DC	h_m	a_p 0,05 x DC	a_p 0,1 x DC	a_p 0,15 x DC	h_m	a_p 0,05 x DC	a_p 0,1 x DC	a_p 0,15 x DC	h_m	a_p 0,05 x DC	a_p 0,1 x DC	a_p 0,15 x DC	h_m			
f_z (mm)				f_z (mm)				f_z (mm)				f_z (mm)							
P.1.1	0,22	0,15	0,13	0,049	0,24	0,17	0,14	0,053	0,26	0,18	0,15	0,057	0,27	0,19	0,16	0,061	○	●	○
P.1.2	0,21	0,15	0,12	0,046	0,23	0,16	0,13	0,051	0,24	0,17	0,14	0,054	0,26	0,18	0,15	0,058	○	●	○
P.1.3	0,20	0,14	0,11	0,044	0,22	0,15	0,12	0,048	0,23	0,16	0,13	0,052	0,25	0,17	0,14	0,055	○	●	○
P.1.4	0,19	0,13	0,11	0,042	0,20	0,14	0,12	0,046	0,22	0,16	0,13	0,049	0,23	0,17	0,14	0,052	○	●	○
P.1.5	0,18	0,13	0,10	0,040	0,19	0,14	0,11	0,043	0,21	0,15	0,12	0,047	0,22	0,16	0,13	0,050	○	●	○
P.2.1	0,22	0,15	0,13	0,049	0,24	0,17	0,14	0,053	0,26	0,18	0,15	0,057	0,27	0,19	0,16	0,061	○	●	○
P.2.2	0,20	0,14	0,11	0,044	0,22	0,15	0,12	0,048	0,23	0,16	0,13	0,052	0,25	0,17	0,14	0,055	○	●	○
P.2.3	0,18	0,13	0,10	0,040	0,19	0,14	0,11	0,043	0,21	0,15	0,12	0,047	0,22	0,16	0,13	0,050	○	●	○
P.2.4	0,16	0,12	0,09	0,037	0,18	0,13	0,10	0,040	0,19	0,14	0,11	0,043	0,21	0,15	0,12	0,046	○	●	○
P.3.1	0,19	0,13	0,11	0,043	0,21	0,15	0,12	0,047	0,22	0,16	0,13	0,050	0,24	0,17	0,14	0,053	●		○
P.3.2	0,18	0,13	0,10	0,040	0,20	0,14	0,11	0,044	0,21	0,15	0,12	0,048	0,23	0,16	0,13	0,051	●		○
P.3.3	0,17	0,12	0,10	0,038	0,19	0,13	0,11	0,042	0,20	0,14	0,12	0,045	0,21	0,15	0,12	0,048	●		○
P.4.1	0,13	0,09	0,08	0,029	0,14	0,10	0,08	0,032	0,15	0,11	0,09	0,035	0,16	0,12	0,09	0,037	●		○
P.4.2	0,13	0,09	0,08	0,029	0,14	0,10	0,08	0,032	0,15	0,11	0,09	0,035	0,16	0,12	0,09	0,037	●		○
M.1.1	0,14	0,08		0,031	0,16	0,10		0,036	0,18	0,11		0,040	0,20	0,12		0,045	●		
M.2.1	0,17	0,11		0,038	0,19	0,13		0,043	0,22	0,14		0,048	0,24	0,16		0,054	●		
M.3.1	0,17	0,11		0,038	0,19	0,13		0,043	0,22	0,14		0,048	0,24	0,16		0,054	●		
K.1.1	0,33	0,23	0,19	0,073	0,36	0,25	0,21	0,080	0,39	0,27	0,22	0,086	0,41	0,29	0,24	0,092		●	
K.1.2	0,23	0,16	0,13	0,051	0,25	0,18	0,15	0,056	0,27	0,19	0,16	0,061	0,29	0,20	0,17	0,064		●	
K.2.1	0,28	0,20	0,16	0,062	0,31	0,22	0,18	0,068	0,33	0,23	0,19	0,074	0,35	0,25	0,20	0,078		●	
K.2.2	0,23	0,16	0,13	0,051	0,25	0,18	0,15	0,056	0,27	0,19	0,16	0,061	0,29	0,20	0,17	0,064		●	
K.3.1	0,23	0,16	0,13	0,051	0,25	0,18	0,15	0,056	0,27	0,19	0,16	0,061	0,29	0,20	0,17	0,064		●	
K.3.2	0,20	0,14	0,11	0,044	0,22	0,15	0,12	0,048	0,23	0,16	0,13	0,052	0,25	0,17	0,14	0,055		●	
N.1.1																			
N.1.2																			
N.2.1																			
N.2.2																			
N.2.3																			
N.3.1																			
N.3.2																			
N.3.3																			
N.4.1																			
S.1.1																			
S.1.2																			
S.2.1																			
S.2.2																			
S.2.3																			
S.3.1																			
S.3.2																			
S.3.3																			
H.1.1																			
H.1.2																			
H.1.3																			
H.1.4																			
H.2.1																			
H.3.1																			
O.1.1																			
O.1.2																			
O.2.1																			
O.2.2																			
O.3.1																			

Index	52 616 ..., 52 617 ..., 52 618 ...											● 1st choice ○ suitable				
	Ø DC (mm) =						Ramping 1,0 x DC Max. plunging angle	Helical milling Hole diameter D _{min.} D _{max.} DC x 1,5 DC x 1,8	Drilling 1,0 x DC f _z Factor	Emulsion	Compressed air	MMS				
	17,5-18,0		19,5-20,0													
	a _s 0,1-0,2 x DC	a _s 0,3-0,4 x DC	a _s 0,6-1,0 x DC	a _s 0,1-0,2 x DC	a _s 0,3-0,4 x DC	a _s 0,6-1,0 x DC	f _z (mm)									
P.1.1																
P.1.2																
P.1.3																
P.1.4																
P.1.5																
P.2.1																
P.2.2																
P.2.3																
P.2.4																
P.3.1																
P.3.2																
P.3.3																
P.4.1																
P.4.2																
M.1.1																
M.2.1																
M.3.1																
K.1.1																
K.1.2																
K.2.1																
K.2.2																
K.3.1																
K.3.2																
N.1.1	0,301	0,213	0,135	0,320	0,226	0,143	45°	0,75 x DC	25°	16°	0,8	●				
N.1.2	0,274	0,194	0,123	0,291	0,206	0,130	45°	0,75 x DC	25°	16°	0,8	●				
N.2.1	0,288	0,203	0,129	0,306	0,216	0,137	45°	0,75 x DC	25°	16°	0,8	●				
N.2.2	0,301	0,213	0,135	0,320	0,226	0,143	45°	0,75 x DC	25°	16°	0,8	●				
N.2.3	0,329	0,233	0,147	0,349	0,247	0,156	45°	0,75 x DC	25°	16°	0,8	●				
N.3.1	0,137	0,097	0,061	0,146	0,103	0,065	45°	0,75 x DC	25°	16°	0,8	●				
N.3.2	0,219	0,155	0,098	0,233	0,165	0,104	45°	0,75 x DC	25°	16°	0,8	●				
N.3.3	0,219	0,155	0,098	0,233	0,165	0,104	45°	0,75 x DC	25°	16°	0,8	●				
N.4.1																
S.1.1																
S.1.2																
S.2.1																
S.2.2																
S.2.3																
S.3.1																
S.3.2																
S.3.3																
H.1.1																
H.1.2																
H.1.3																
H.1.4																
H.2.1																
H.3.1																
O.1.1																
O.1.2																
O.2.1																
O.2.2																
O.3.1																



* Width of cut per helical revolution



Cutting data for ramping and helical milling = 100 %
Multiply cutting data for drilling by the factor from the table

Cutting data standard values – MonsterMill – PCR – End mill, AL version – trochoidal

Index	Type long		52 618 ...																			
	v _c (m/min)	max. angle of engagement	Ø DC (mm) =																			
			5				6				8				10				12			
			a _s 0,1 x DC	a _s 0,2 x DC	a _s 0,3 x DC	h _m	a _s 0,1 x DC	a _s 0,2 x DC	a _s 0,3 x DC	h _m	a _s 0,1 x DC	a _s 0,2 x DC	a _s 0,3 x DC	h _m	a _s 0,1 x DC	a _s 0,2 x DC	a _s 0,3 x DC	h _m	a _s 0,1 x DC	a _s 0,2 x DC	a _s 0,3 x DC	h _m
f _z (mm)			f _z (mm)			f _z (mm)			f _z (mm)			f _z (mm)										
P.1.1																						
P.1.2																						
P.1.3																						
P.1.4																						
P.1.5																						
P.2.1																						
P.2.2																						
P.2.3																						
P.2.4																						
P.3.1																						
P.3.2																						
P.3.3																						
P.4.1																						
P.4.2																						
M.1.1																						
M.2.1																						
M.3.1																						
K.1.1																						
K.1.2																						
K.2.1																						
K.2.2																						
K.3.1																						
K.3.2																						
N.1.1	800	66°	0,09	0,07	0,05	0,021	0,11	0,08	0,06	0,024	0,14	0,10	0,08	0,031	0,17	0,12	0,10	0,037	0,19	0,13	0,11	0,043
N.1.2	725	66°	0,08	0,06	0,05	0,019	0,10	0,07	0,06	0,022	0,13	0,09	0,07	0,028	0,15	0,11	0,09	0,034	0,17	0,12	0,10	0,039
N.2.1	485	66°	0,09	0,06	0,05	0,020	0,10	0,07	0,06	0,023	0,13	0,09	0,08	0,030	0,16	0,11	0,09	0,035	0,18	0,13	0,11	0,041
N.2.2	385	66°	0,09	0,07	0,05	0,021	0,11	0,08	0,06	0,024	0,14	0,10	0,08	0,031	0,17	0,12	0,10	0,037	0,19	0,13	0,11	0,043
N.2.3	280	66°	0,10	0,07	0,06	0,023	0,12	0,08	0,07	0,026	0,15	0,11	0,09	0,034	0,18	0,13	0,10	0,040	0,21	0,15	0,12	0,047
N.3.1	350	66°	0,04	0,03	0,02	0,009	0,05	0,03	0,03	0,011	0,06	0,04	0,04	0,014	0,08	0,05	0,04	0,017	0,09	0,06	0,05	0,019
N.3.2	210	66°	0,07	0,05	0,04	0,015	0,08	0,06	0,05	0,018	0,10	0,07	0,06	0,023	0,12	0,09	0,07	0,027	0,14	0,10	0,08	0,031
N.3.3	280	66°	0,07	0,05	0,04	0,015	0,08	0,06	0,05	0,018	0,10	0,07	0,06	0,023	0,12	0,09	0,07	0,027	0,14	0,10	0,08	0,031
N.4.1																						
S.1.1																						
S.1.2																						
S.2.1																						
S.2.2																						
S.2.3																						
S.3.1																						
S.3.2																						
S.3.3																						
H.1.1																						
H.1.2																						
H.1.3																						
H.1.4																						
H.2.1																						
H.3.1																						
O.1.1																						
O.1.2																						
O.2.1																						
O.2.2																						
O.3.1																						

 Cutting depth corresponding to the cutting length

milling

Index	52 618 ...																● 1st choice		
	Ø DC (mm) =																○ suitable		
	14				16				18				20				Emulsion	Compressed air	MMS
	a_p 0,1 x DC	a_p 0,2 x DC	a_p 0,3 x DC	h_m	a_p 0,1 x DC	a_p 0,2 x DC	a_p 0,3 x DC	h_m	a_p 0,1 x DC	a_p 0,2 x DC	a_p 0,3 x DC	h_m	a_p 0,1 x DC	a_p 0,2 x DC	a_p 0,3 x DC	h_m			
f_z (mm)				f_z (mm)				f_z (mm)				f_z (mm)							
P.1.1																			
P.1.2																			
P.1.3																			
P.1.4																			
P.1.5																			
P.2.1																			
P.2.2																			
P.2.3																			
P.2.4																			
P.3.1																			
P.3.2																			
P.3.3																			
P.4.1																			
P.4.2																			
M.1.1																			
M.2.1																			
M.3.1																			
K.1.1																			
K.1.2																			
K.2.1																			
K.2.2																			
K.3.1																			
K.3.2																			
N.1.1	0,21	0,15	0,12	0,048	0,23	0,16	0,13	0,052	0,25	0,18	0,14	0,056	0,27	0,19	0,15	0,060	●		
N.1.2	0,19	0,14	0,11	0,043	0,21	0,15	0,12	0,047	0,23	0,16	0,13	0,051	0,24	0,17	0,14	0,054	●		
N.2.1	0,20	0,14	0,12	0,045	0,22	0,16	0,13	0,050	0,24	0,17	0,14	0,054	0,25	0,18	0,15	0,057	●		
N.2.2	0,21	0,15	0,12	0,048	0,23	0,16	0,13	0,052	0,25	0,18	0,14	0,056	0,27	0,19	0,15	0,060	●		
N.2.3	0,23	0,16	0,13	0,052	0,25	0,18	0,15	0,057	0,27	0,19	0,16	0,061	0,29	0,21	0,17	0,065	●		
N.3.1	0,10	0,07	0,06	0,022	0,11	0,07	0,06	0,024	0,11	0,08	0,07	0,025	0,12	0,09	0,07	0,027	●		
N.3.2	0,15	0,11	0,09	0,035	0,17	0,12	0,10	0,038	0,18	0,13	0,11	0,041	0,19	0,14	0,11	0,043	●		
N.3.3	0,15	0,11	0,09	0,035	0,17	0,12	0,10	0,038	0,18	0,13	0,11	0,041	0,19	0,14	0,11	0,043	●		
N.4.1																			
S.1.1																			
S.1.2																			
S.2.1																			
S.2.2																			
S.2.3																			
S.3.1																			
S.3.2																			
S.3.3																			
H.1.1																			
H.1.2																			
H.1.3																			
H.1.4																			
H.2.1																			
H.3.1																			
O.1.1																			
O.1.2																			
O.2.1																			
O.2.2																			
O.3.1																			

Cutting data standard values – MonsterMill – MCR – End mill, short – long

Index	Type short		50 752 ...						Type short	Type long	50 752 ...											
	v _c (m/min)	a _{p,max.} x DC	Ø DC (mm) =								Ø DC (mm) =											
			1			2					3			4			5			6		
			a _s 0,1-0,2 x DC	a _s 0,3-0,4 x DC	a _s 0,6-1,0 x DC	a _s 0,1-0,2 x DC	a _s 0,3-0,4 x DC	a _s 0,6-1,0 x DC			a _s 0,1-0,2 x DC	a _s 0,3-0,4 x DC	a _s 0,6-1,0 x DC	a _s 0,1-0,2 x DC	a _s 0,3-0,4 x DC	a _s 0,6-1,0 x DC	a _s 0,1-0,2 x DC	a _s 0,3-0,4 x DC	a _s 0,6-1,0 x DC			
f _z (mm)						f _z (mm)						f _z (mm)										
		a _{p,max.} x DC																				
P.1.1	160	0,5	0,008	0,007	0,004	0,015	0,013	0,008	1,0	1,0*	0,032	0,024	0,015	0,043	0,032	0,020	0,053	0,040	0,025	0,064	0,047	0,030
P.1.2	140	0,5	0,008	0,007	0,004	0,015	0,013	0,008	1,0	1,0*	0,032	0,024	0,015	0,043	0,032	0,020	0,053	0,040	0,025	0,064	0,047	0,030
P.1.3	120	0,5	0,008	0,007	0,004	0,015	0,013	0,008	1,0	1,0*	0,032	0,024	0,015	0,043	0,032	0,020	0,053	0,040	0,025	0,064	0,047	0,030
P.1.4	120	0,5	0,008	0,007	0,004	0,015	0,013	0,008	1,0	1,0*	0,032	0,024	0,015	0,043	0,032	0,020	0,053	0,040	0,025	0,064	0,047	0,030
P.1.5	100	0,5	0,008	0,007	0,004	0,015	0,013	0,008	1,0	1,0*	0,032	0,024	0,015	0,043	0,032	0,020	0,053	0,040	0,025	0,064	0,047	0,030
P.2.1	140	0,5	0,008	0,007	0,004	0,015	0,013	0,008	1,0	1,0*	0,032	0,024	0,015	0,043	0,032	0,020	0,053	0,040	0,025	0,064	0,047	0,030
P.2.2	120	0,5	0,008	0,007	0,004	0,015	0,013	0,008	1,0	1,0*	0,032	0,024	0,015	0,043	0,032	0,020	0,053	0,040	0,025	0,064	0,047	0,030
P.2.3	100	0,5	0,008	0,007	0,004	0,015	0,013	0,008	1,0	1,0*	0,032	0,024	0,015	0,043	0,032	0,020	0,053	0,040	0,025	0,064	0,047	0,030
P.2.4	80	0,5	0,008	0,007	0,004	0,015	0,013	0,008	1,0	1,0*	0,032	0,024	0,015	0,043	0,032	0,020	0,053	0,040	0,025	0,064	0,047	0,030
P.3.1	80	0,5	0,008	0,007	0,004	0,015	0,013	0,008	1,0	1,0*	0,032	0,024	0,015	0,043	0,032	0,020	0,053	0,040	0,025	0,064	0,047	0,030
P.3.2	80	0,5	0,008	0,007	0,004	0,015	0,013	0,008	1,0	1,0*	0,032	0,024	0,015	0,043	0,032	0,020	0,053	0,040	0,025	0,064	0,047	0,030
P.3.3	80	0,5	0,008	0,007	0,004	0,015	0,013	0,008	1,0	1,0*	0,032	0,024	0,015	0,043	0,032	0,020	0,053	0,040	0,025	0,064	0,047	0,030
P.4.1	60	0,5	0,008	0,007	0,004	0,015	0,013	0,008	1,0	1,0*	0,030	0,022	0,014	0,038	0,028	0,018	0,049	0,036	0,023	0,058	0,043	0,027
P.4.2	60	0,5	0,008	0,007	0,004	0,015	0,013	0,008	1,0	1,0*	0,030	0,022	0,014	0,038	0,028	0,018	0,049	0,036	0,023	0,058	0,043	0,027
M.1.1	60	0,5	0,008	0,007	0,004	0,015	0,013	0,008	1,0	1,0*	0,030	0,022	0,014	0,038	0,028	0,018	0,049	0,036	0,023	0,058	0,043	0,027
M.2.1																						
M.3.1	60	0,5	0,008	0,007	0,004	0,015	0,013	0,008	1,0	1,0*	0,030	0,022	0,014	0,038	0,028	0,018	0,049	0,036	0,023	0,058	0,043	0,027
K.1.1	160	0,5	0,012	0,010	0,006	0,023	0,019	0,012	1,0	1,0*	0,045	0,033	0,021	0,060	0,044	0,028	0,075	0,055	0,035	0,090	0,066	0,042
K.1.2	160	0,5	0,012	0,010	0,006	0,023	0,019	0,012	1,0	1,0*	0,045	0,033	0,021	0,060	0,044	0,028	0,075	0,055	0,035	0,090	0,066	0,042
K.2.1	140	0,5	0,012	0,010	0,006	0,023	0,019	0,012	1,0	1,0*	0,045	0,033	0,021	0,060	0,044	0,028	0,075	0,055	0,035	0,090	0,066	0,042
K.2.2	140	0,5	0,012	0,010	0,006	0,023	0,019	0,012	1,0	1,0*	0,045	0,033	0,021	0,060	0,044	0,028	0,075	0,055	0,035	0,090	0,066	0,042
K.3.1	100	0,5	0,010	0,008	0,005	0,019	0,016	0,010	1,0	1,0*	0,038	0,028	0,018	0,051	0,038	0,024	0,064	0,047	0,030	0,077	0,057	0,036
K.3.2	100	0,5	0,010	0,008	0,005	0,019	0,016	0,010	1,0	1,0*	0,038	0,028	0,018	0,051	0,038	0,024	0,064	0,047	0,030	0,077	0,057	0,036
N.1.1																						
N.1.2																						
N.2.1																						
N.2.2																						
N.2.3																						
N.3.1	140	0,5	0,008	0,007	0,004	0,015	0,013	0,008	1,0	1,0*	0,032	0,024	0,015	0,043	0,032	0,020	0,053	0,040	0,025	0,064	0,047	0,030
N.3.2	140	0,5	0,008	0,007	0,004	0,015	0,013	0,008	1,0	1,0*	0,032	0,024	0,015	0,043	0,032	0,020	0,053	0,040	0,025	0,064	0,047	0,030
N.3.3	140	0,5	0,008	0,007	0,004	0,015	0,013	0,008	1,0	1,0*	0,032	0,024	0,015	0,043	0,032	0,020	0,053	0,040	0,025	0,064	0,047	0,030
N.4.1																						
S.1.1																						
S.1.2																						
S.2.1																						
S.2.2																						
S.2.3																						
S.3.1	60	0,25	0,008	0,007	0,004	0,015	0,013	0,008	0,5	0,5	0,026	0,019	0,012	0,034	0,025	0,016	0,043	0,032	0,020	0,051	0,038	0,024
S.3.2	60	0,25	0,008	0,007	0,004	0,015	0,013	0,008	0,5	0,5	0,026	0,019	0,012	0,034	0,025	0,016	0,043	0,032	0,020	0,051	0,038	0,024
S.3.3	60	0,25	0,008	0,007	0,004	0,015	0,013	0,008	0,5	0,5	0,026	0,019	0,012	0,034	0,025	0,016	0,043	0,032	0,020	0,051	0,038	0,024
H.1.1																						
H.1.2																						
H.1.3																						
H.1.4																						
H.2.1	80	0,25	0,008	0,007	0,004	0,015	0,013	0,008	0,5	0,5	0,032	0,024	0,015	0,043	0,032	0,020	0,053	0,040	0,025	0,064	0,047	0,030
H.3.1																						
O.1.1																						
O.1.2																						
O.2.1																						
O.2.2																						
O.3.1																						

* = with an a_p of 1.5 x d₁ the f_z should be multiplied by 0.8

 Plunging angle for ramping and helical milling: Diameter 3–5 = 3° / Diameter 6–9 = 5° / Diameter 10–20 = 8°

Index	50 752 ...																		● 1st choice ○ suitable		
	Ø DC (mm) =																		Emulsion	Compressed air	MMS
	8			10			12			14			16			20					
	a_p 0,1-0,2 x DC	a_p 0,3-0,4 x DC	a_p 0,6-1,0 x DC	a_p 0,1-0,2 x DC	a_p 0,3-0,4 x DC	a_p 0,6-1,0 x DC	a_p 0,1-0,2 x DC	a_p 0,3-0,4 x DC	a_p 0,6-1,0 x DC	a_p 0,1-0,2 x DC	a_p 0,3-0,4 x DC	a_p 0,6-1,0 x DC	a_p 0,1-0,2 x DC	a_p 0,3-0,4 x DC	a_p 0,6-1,0 x DC	a_p 0,1-0,2 x DC	a_p 0,3-0,4 x DC	a_p 0,6-1,0 x DC			
	f_z (mm)																				
P.1.1	0,09	0,06	0,04	0,11	0,08	0,05	0,12	0,09	0,06	0,13	0,10	0,07	0,14	0,11	0,08	0,16	0,13	0,10		●	
P.1.2	0,09	0,06	0,04	0,11	0,08	0,05	0,12	0,09	0,06	0,13	0,10	0,07	0,14	0,11	0,08	0,16	0,13	0,10		●	
P.1.3	0,09	0,06	0,04	0,11	0,08	0,05	0,12	0,09	0,06	0,13	0,10	0,07	0,14	0,11	0,08	0,16	0,13	0,10		●	
P.1.4	0,09	0,06	0,04	0,11	0,08	0,05	0,12	0,09	0,06	0,13	0,10	0,07	0,14	0,11	0,08	0,16	0,13	0,10		●	
P.1.5	0,09	0,06	0,04	0,11	0,08	0,05	0,12	0,09	0,06	0,13	0,10	0,07	0,14	0,11	0,08	0,16	0,13	0,10		●	
P.2.1	0,09	0,06	0,04	0,11	0,08	0,05	0,12	0,09	0,06	0,13	0,10	0,07	0,14	0,11	0,08	0,16	0,13	0,10		●	
P.2.2	0,09	0,06	0,04	0,11	0,08	0,05	0,12	0,09	0,06	0,13	0,10	0,07	0,14	0,11	0,08	0,16	0,13	0,10		●	
P.2.3	0,09	0,06	0,04	0,11	0,08	0,05	0,12	0,09	0,06	0,13	0,10	0,07	0,14	0,11	0,08	0,16	0,13	0,10		●	
P.2.4	0,09	0,06	0,04	0,11	0,08	0,05	0,12	0,09	0,06	0,13	0,10	0,07	0,14	0,11	0,08	0,16	0,13	0,10		●	
P.3.1	0,09	0,06	0,04	0,11	0,08	0,05	0,12	0,09	0,06	0,13	0,10	0,07	0,14	0,11	0,08	0,16	0,13	0,10		●	
P.3.2	0,09	0,06	0,04	0,11	0,08	0,05	0,12	0,09	0,06	0,13	0,10	0,07	0,14	0,11	0,08	0,16	0,13	0,10		●	
P.3.3	0,09	0,06	0,04	0,11	0,08	0,05	0,12	0,09	0,06	0,13	0,10	0,07	0,14	0,11	0,08	0,16	0,13	0,10		●	
P.4.1	0,08	0,06	0,04	0,10	0,07	0,05	0,10	0,08	0,05	0,11	0,09	0,06	0,12	0,10	0,07	0,14	0,12	0,09	●		
P.4.2	0,08	0,06	0,04	0,10	0,07	0,05	0,10	0,08	0,05	0,11	0,09	0,06	0,12	0,10	0,07	0,14	0,12	0,09	●		
M.1.1	0,08	0,06	0,04	0,10	0,07	0,05	0,10	0,08	0,05	0,11	0,09	0,06	0,12	0,10	0,07	0,14	0,12	0,09	●		
M.2.1																					
M.3.1	0,08	0,06	0,04	0,10	0,07	0,05	0,10	0,08	0,05	0,11	0,09	0,06	0,12	0,10	0,07	0,14	0,12	0,09	●		
K.1.1	0,12	0,09	0,06	0,15	0,11	0,07	0,16	0,13	0,08	0,18	0,14	0,10	0,19	0,16	0,11	0,22	0,18	0,14		●	
K.1.2	0,12	0,09	0,06	0,15	0,11	0,07	0,16	0,13	0,08	0,18	0,14	0,10	0,19	0,16	0,11	0,22	0,18	0,14		●	
K.2.1	0,12	0,09	0,06	0,15	0,11	0,07	0,16	0,13	0,08	0,18	0,14	0,10	0,19	0,16	0,11	0,22	0,18	0,14		●	
K.2.2	0,12	0,09	0,06	0,15	0,11	0,07	0,16	0,13	0,08	0,18	0,14	0,10	0,19	0,16	0,11	0,22	0,18	0,14		●	
K.3.1	0,10	0,08	0,05	0,13	0,10	0,06	0,14	0,11	0,07	0,15	0,12	0,08	0,16	0,14	0,10	0,19	0,16	0,12		●	
K.3.2	0,10	0,08	0,05	0,13	0,10	0,06	0,14	0,11	0,07	0,15	0,12	0,08	0,16	0,14	0,10	0,19	0,16	0,12		●	
N.1.1																					
N.1.2																					
N.2.1																					
N.2.2																					
N.2.3																					
N.3.1	0,09	0,06	0,04	0,11	0,08	0,05	0,12	0,09	0,06	0,13	0,10	0,07	0,14	0,11	0,08	0,16	0,13	0,10	●		
N.3.2	0,09	0,06	0,04	0,11	0,08	0,05	0,12	0,09	0,06	0,13	0,10	0,07	0,14	0,11	0,08	0,16	0,13	0,10	●		
N.3.3	0,09	0,06	0,04	0,11	0,08	0,05	0,12	0,09	0,06	0,13	0,10	0,07	0,14	0,11	0,08	0,16	0,13	0,10	●		
N.4.1																					
S.1.1																					
S.1.2																					
S.2.1																					
S.2.2																					
S.2.3																					
S.3.1	0,07	0,05	0,03	0,09	0,06	0,04	0,09	0,07	0,05	0,10	0,08	0,06	0,11	0,09	0,06	0,13	0,10	0,08	●		
S.3.2	0,07	0,05	0,03	0,09	0,06	0,04	0,09	0,07	0,05	0,10	0,08	0,06	0,11	0,09	0,06	0,13	0,10	0,08	●		
S.3.3	0,07	0,05	0,03	0,09	0,06	0,04	0,09	0,07	0,05	0,10	0,08	0,06	0,11	0,09	0,06	0,13	0,10	0,08	●		
H.1.1																					
H.1.2																					
H.1.3																					
H.1.4																					
H.2.1	0,09	0,06	0,04	0,11	0,08	0,05	0,12	0,09	0,06	0,13	0,10	0,07	0,14	0,11	0,08	0,16	0,13	0,10		●	
H.3.1																					
O.1.1																					
O.1.2																					
O.2.1																					
O.2.2																					
O.3.1																					

Cutting data standard values – MonsterMill – MCR – End mill, extra long

Index	Type extra long		50 752 ...															
			Ø DC (mm) =															
	v _c (m/min)	a _{p,max.} x DC	3			4			5			6			8			
			a _s 0,1–0,2 x DC	a _s 0,3–0,4 x DC	a _s 0,6–1,0 x DC	a _s 0,1–0,2 x DC	a _s 0,3–0,4 x DC	a _s 0,6–1,0 x DC	a _s 0,1–0,2 x DC	a _s 0,3–0,4 x DC	a _s 0,6–1,0 x DC	a _s 0,1–0,2 x DC	a _s 0,3–0,4 x DC	a _s 0,6–1,0 x DC	a _s 0,1–0,2 x DC	a _s 0,3–0,4 x DC	a _s 0,6–1,0 x DC	
f _z (mm)																		
P.1.1	120	1,0*	0,5	0,025	0,017	0,011	0,031	0,022	0,014	0,040	0,028	0,018	0,047	0,033	0,021	0,06	0,04	0,03
P.1.2	100	1,0*	0,5	0,025	0,017	0,011	0,031	0,022	0,014	0,040	0,028	0,018	0,047	0,033	0,021	0,06	0,04	0,03
P.1.3	80	1,0*	0,5	0,025	0,017	0,011	0,031	0,022	0,014	0,040	0,028	0,018	0,047	0,033	0,021	0,06	0,04	0,03
P.1.4	80	1,0*	0,5	0,025	0,017	0,011	0,031	0,022	0,014	0,040	0,028	0,018	0,047	0,033	0,021	0,06	0,04	0,03
P.1.5	80	1,0*	0,5	0,025	0,017	0,011	0,031	0,022	0,014	0,040	0,028	0,018	0,047	0,033	0,021	0,06	0,04	0,03
P.2.1	100	1,0*	0,5	0,025	0,017	0,011	0,031	0,022	0,014	0,040	0,028	0,018	0,047	0,033	0,021	0,06	0,04	0,03
P.2.2	80	1,0*	0,5	0,025	0,017	0,011	0,031	0,022	0,014	0,040	0,028	0,018	0,047	0,033	0,021	0,06	0,04	0,03
P.2.3	70	1,0*	0,5	0,025	0,017	0,011	0,031	0,022	0,014	0,040	0,028	0,018	0,047	0,033	0,021	0,06	0,04	0,03
P.2.4	70	1,0*	0,5	0,025	0,017	0,011	0,031	0,022	0,014	0,040	0,028	0,018	0,047	0,033	0,021	0,06	0,04	0,03
P.3.1	70	1,0*	0,5	0,025	0,017	0,011	0,031	0,022	0,014	0,040	0,028	0,018	0,047	0,033	0,021	0,06	0,04	0,03
P.3.2	70	1,0*	0,5	0,025	0,017	0,011	0,031	0,022	0,014	0,040	0,028	0,018	0,047	0,033	0,021	0,06	0,04	0,03
P.3.3	70	1,0*	0,5	0,025	0,017	0,011	0,031	0,022	0,014	0,040	0,028	0,018	0,047	0,033	0,021	0,06	0,04	0,03
P.4.1	50	1,0*	0,5	0,020	0,014	0,009	0,027	0,019	0,012	0,034	0,024	0,015	0,040	0,028	0,018	0,05	0,04	0,02
P.4.2	50	1,0*	0,5	0,020	0,014	0,009	0,027	0,019	0,012	0,034	0,024	0,015	0,040	0,028	0,018	0,05	0,04	0,02
M.1.1	50	1,0*	0,5	0,020	0,014	0,009	0,027	0,019	0,012	0,034	0,024	0,015	0,040	0,028	0,018	0,05	0,04	0,02
M.2.1																		
M.3.1	50	1,0*	0,5	0,020	0,014	0,009	0,027	0,019	0,012	0,034	0,024	0,015	0,040	0,028	0,018	0,05	0,04	0,02
K.1.1	120	1,0*	0,5	0,034	0,024	0,015	0,045	0,032	0,020	0,056	0,040	0,025	0,067	0,047	0,030	0,09	0,06	0,04
K.1.2	120	1,0*	0,5	0,034	0,024	0,015	0,045	0,032	0,020	0,056	0,040	0,025	0,067	0,047	0,030	0,09	0,06	0,04
K.2.1	120	1,0*	0,5	0,034	0,024	0,015	0,045	0,032	0,020	0,056	0,040	0,025	0,067	0,047	0,030	0,09	0,06	0,04
K.2.2	120	1,0*	0,5	0,034	0,024	0,015	0,045	0,032	0,020	0,056	0,040	0,025	0,067	0,047	0,030	0,09	0,06	0,04
K.3.1	100	1,0*	0,5	0,027	0,019	0,012	0,036	0,025	0,016	0,045	0,032	0,020	0,054	0,038	0,024	0,07	0,05	0,03
K.3.2	100	1,0*	0,5	0,027	0,019	0,012	0,036	0,025	0,016	0,045	0,032	0,020	0,054	0,038	0,024	0,07	0,05	0,03
N.1.1																		
N.1.2																		
N.2.1																		
N.2.2																		
N.2.3																		
N.3.1	120	1,0*	0,5	0,020	0,014	0,009	0,027	0,019	0,012	0,034	0,024	0,015	0,040	0,028	0,018	0,05	0,04	0,02
N.3.2	120	1,0*	0,5	0,020	0,014	0,009	0,027	0,019	0,012	0,034	0,024	0,015	0,040	0,028	0,018	0,05	0,04	0,02
N.3.3	120	1,0*	0,5	0,020	0,014	0,009	0,027	0,019	0,012	0,034	0,024	0,015	0,040	0,028	0,018	0,05	0,04	0,02
N.4.1																		
S.1.1																		
S.1.2																		
S.2.1																		
S.2.2																		
S.2.3																		
S.3.1	60	0,5*	0,25	0,020	0,014	0,009	0,027	0,019	0,012	0,034	0,024	0,015	0,040	0,028	0,018	0,05	0,04	0,02
S.3.2	60	0,5*	0,25	0,020	0,014	0,009	0,027	0,019	0,012	0,034	0,024	0,015	0,040	0,028	0,018	0,05	0,04	0,02
S.3.3	60	0,5*	0,25	0,020	0,014	0,009	0,027	0,019	0,012	0,034	0,024	0,015	0,040	0,028	0,018	0,05	0,04	0,02
H.1.1																		
H.1.2																		
H.1.3																		
H.1.4																		
H.2.1	80	0,5*	0,5	0,025	0,017	0,011	0,031	0,022	0,014	0,040	0,028	0,018	0,047	0,033	0,021	0,06	0,04	0,03
H.3.1																		
O.1.1																		
O.1.2																		
O.2.1																		
O.2.2																		
O.3.1																		

* = Trimming and trochoidal slot milling

 Plunging angle for ramping and helical milling:
Diameter 3–5 = 3° / Diameter 6–9 = 5° / Diameter 10–20 = 8°

Index	50 752 ...															● 1st choice		
	Ø DC (mm) =															○ suitable		
	10			12			14			16			20			Emulsion	Compressed air	MMS
	a_e 0,1-0,2 x DC	a_e 0,3-0,4 x DC	a_e 0,6-1,0 x DC	a_e 0,1-0,2 x DC	a_e 0,3-0,4 x DC	a_e 0,6-1,0 x DC	a_e 0,1-0,2 x DC	a_e 0,3-0,4 x DC	a_e 0,6-1,0 x DC	a_e 0,1-0,2 x DC	a_e 0,3-0,4 x DC	a_e 0,6-1,0 x DC	a_e 0,1-0,2 x DC	a_e 0,3-0,4 x DC	a_e 0,6-1,0 x DC			
	f_z (mm)																	
P.1.1	0,08	0,06	0,04	0,08	0,07	0,04	0,09	0,07	0,05	0,10	0,08	0,06	0,12	0,09	0,07		●	
P.1.2	0,08	0,06	0,04	0,08	0,07	0,04	0,09	0,07	0,05	0,10	0,08	0,06	0,12	0,09	0,07		●	
P.1.3	0,08	0,06	0,04	0,08	0,07	0,04	0,09	0,07	0,05	0,10	0,08	0,06	0,12	0,09	0,07		●	
P.1.4	0,08	0,06	0,04	0,08	0,07	0,04	0,09	0,07	0,05	0,10	0,08	0,06	0,12	0,09	0,07		●	
P.1.5	0,08	0,06	0,04	0,08	0,07	0,04	0,09	0,07	0,05	0,10	0,08	0,06	0,12	0,09	0,07		●	
P.2.1	0,08	0,06	0,04	0,08	0,07	0,04	0,09	0,07	0,05	0,10	0,08	0,06	0,12	0,09	0,07		●	
P.2.2	0,08	0,06	0,04	0,08	0,07	0,04	0,09	0,07	0,05	0,10	0,08	0,06	0,12	0,09	0,07		●	
P.2.3	0,08	0,06	0,04	0,08	0,07	0,04	0,09	0,07	0,05	0,10	0,08	0,06	0,12	0,09	0,07		●	
P.2.4	0,08	0,06	0,04	0,08	0,07	0,04	0,09	0,07	0,05	0,10	0,08	0,06	0,12	0,09	0,07		●	
P.3.1	0,08	0,06	0,04	0,08	0,07	0,04	0,09	0,07	0,05	0,10	0,08	0,06	0,12	0,09	0,07		●	
P.3.2	0,08	0,06	0,04	0,08	0,07	0,04	0,09	0,07	0,05	0,10	0,08	0,06	0,12	0,09	0,07		●	
P.3.3	0,08	0,06	0,04	0,08	0,07	0,04	0,09	0,07	0,05	0,10	0,08	0,06	0,12	0,09	0,07		●	
P.4.1	0,07	0,05	0,03	0,07	0,06	0,04	0,08	0,06	0,04	0,08	0,07	0,05	0,10	0,08	0,06	●		
P.4.2	0,07	0,05	0,03	0,07	0,06	0,04	0,08	0,06	0,04	0,08	0,07	0,05	0,10	0,08	0,06	●		
M.1.1	0,07	0,05	0,03	0,07	0,06	0,04	0,08	0,06	0,04	0,08	0,07	0,05	0,10	0,08	0,06	●		
M.2.1																		
M.3.1	0,07	0,05	0,03	0,07	0,06	0,04	0,08	0,06	0,04	0,08	0,07	0,05	0,10	0,08	0,06	●		
K.1.1	0,11	0,08	0,05	0,12	0,09	0,06	0,13	0,10	0,07	0,14	0,11	0,08	0,17	0,14	0,10		●	
K.1.2	0,11	0,08	0,05	0,12	0,09	0,06	0,13	0,10	0,07	0,14	0,11	0,08	0,17	0,14	0,10		●	
K.2.1	0,11	0,08	0,05	0,12	0,09	0,06	0,13	0,10	0,07	0,14	0,11	0,08	0,17	0,14	0,10		●	
K.2.2	0,11	0,08	0,05	0,12	0,09	0,06	0,13	0,10	0,07	0,14	0,11	0,08	0,17	0,14	0,10		●	
K.3.1	0,09	0,06	0,04	0,09	0,07	0,05	0,10	0,08	0,06	0,11	0,09	0,06	0,14	0,11	0,08		●	
K.3.2	0,09	0,06	0,04	0,09	0,07	0,05	0,10	0,08	0,06	0,11	0,09	0,06	0,14	0,11	0,08		●	
N.1.1																		
N.1.2																		
N.2.1																		
N.2.2																		
N.2.3																		
N.3.1	0,07	0,05	0,03	0,07	0,06	0,04	0,08	0,06	0,04	0,08	0,07	0,05	0,10	0,08	0,06	●		
N.3.2	0,07	0,05	0,03	0,07	0,06	0,04	0,08	0,06	0,04	0,08	0,07	0,05	0,10	0,08	0,06	●		
N.3.3	0,07	0,05	0,03	0,07	0,06	0,04	0,08	0,06	0,04	0,08	0,07	0,05	0,10	0,08	0,06	●		
N.4.1																		
S.1.1																		
S.1.2																		
S.2.1																		
S.2.2																		
S.2.3																		
S.3.1	0,07	0,05	0,03	0,07	0,06	0,04	0,08	0,06	0,04	0,08	0,07	0,05	0,10	0,08	0,06	●		
S.3.2	0,07	0,05	0,03	0,07	0,06	0,04	0,08	0,06	0,04	0,08	0,07	0,05	0,10	0,08	0,06	●		
S.3.3	0,07	0,05	0,03	0,07	0,06	0,04	0,08	0,06	0,04	0,08	0,07	0,05	0,10	0,08	0,06	●		
H.1.1																		
H.1.2																		
H.1.3																		
H.1.4																		
H.2.1	0,08	0,06	0,04	0,08	0,07	0,04	0,09	0,07	0,05	0,10	0,08	0,06	0,12	0,09	0,07		●	
H.3.1																		
O.1.1																		
O.1.2																		
O.2.1																		
O.2.2																		
O.3.1																		

Cutting data – CircularLine – End Mills – CCR-UNI, short – long

Index	Type short / long		53 585..., 53 587..., 53 586 ..., 53 642 ...															
	v _c (m/min)	max. angle of engagement	Ø DC (mm) =															
			6				8				10				12			
			a _e 0,05 x DC	a _e 0,1 x DC	a _e 0,15 x DC	h _m	a _e 0,05 x DC	a _e 0,1 x DC	a _e 0,15 x DC	h _m	a _e 0,05 x DC	a _e 0,1 x DC	a _e 0,15 x DC	h _m	a _e 0,05 x DC	a _e 0,1 x DC	a _e 0,15 x DC	h _m
f _z (mm)				f _z (mm)				f _z (mm)				f _z (mm)						
P.1.1	280	50°	0,15	0,10	0,09	0,033	0,17	0,12	0,10	0,039	0,20	0,14	0,12	0,045	0,23	0,16	0,13	0,051
P.1.2	280	50°	0,11	0,08	0,07	0,025	0,14	0,10	0,08	0,032	0,17	0,12	0,10	0,039	0,20	0,14	0,12	0,045
P.1.3	280	50°	0,11	0,08	0,07	0,025	0,14	0,10	0,08	0,032	0,17	0,12	0,10	0,039	0,20	0,14	0,12	0,045
P.1.4	260	50°	0,11	0,08	0,07	0,025	0,14	0,10	0,08	0,032	0,17	0,12	0,10	0,039	0,20	0,14	0,12	0,045
P.1.5	260	50°	0,11	0,08	0,07	0,025	0,14	0,10	0,08	0,032	0,17	0,12	0,10	0,039	0,20	0,14	0,12	0,045
P.2.1	280	50°	0,15	0,10	0,09	0,033	0,17	0,12	0,10	0,039	0,20	0,14	0,12	0,045	0,23	0,16	0,13	0,051
P.2.2	280	50°	0,15	0,10	0,09	0,033	0,17	0,12	0,10	0,039	0,20	0,14	0,12	0,045	0,23	0,16	0,13	0,051
P.2.3	260	50°	0,11	0,08	0,07	0,025	0,14	0,10	0,08	0,032	0,17	0,12	0,10	0,039	0,20	0,14	0,12	0,045
P.2.4	260	50°	0,11	0,08	0,07	0,025	0,14	0,10	0,08	0,032	0,17	0,12	0,10	0,039	0,20	0,14	0,12	0,045
P.3.1	220	50°	0,11	0,08	0,07	0,025	0,14	0,10	0,08	0,032	0,17	0,12	0,10	0,039	0,20	0,14	0,12	0,045
P.3.2	220	45°	0,11	0,08	0,07	0,025	0,14	0,10	0,08	0,032	0,17	0,12	0,10	0,039	0,20	0,14	0,12	0,045
P.3.3	200	45°	0,11	0,08	0,07	0,025	0,14	0,10	0,08	0,032	0,17	0,12	0,10	0,039	0,20	0,14	0,12	0,045
P.4.1	180	45°	0,09	0,07	0,05	0,021	0,11	0,08	0,07	0,026	0,14	0,10	0,08	0,031	0,16	0,11	0,09	0,035
P.4.2	160	45°	0,09	0,07	0,05	0,021	0,11	0,08	0,07	0,026	0,14	0,10	0,08	0,031	0,16	0,11	0,09	0,035
M.1.1	140	45°	0,09	0,07	0,05	0,021	0,11	0,08	0,07	0,026	0,14	0,10	0,08	0,031	0,16	0,11	0,09	0,035
M.2.1	140	45°	0,09	0,07	0,05	0,021	0,11	0,08	0,07	0,026	0,14	0,10	0,08	0,031	0,16	0,11	0,09	0,035
M.3.1	140	45°	0,09	0,07	0,05	0,021	0,11	0,08	0,07	0,026	0,14	0,10	0,08	0,031	0,16	0,11	0,09	0,035
K.1.1	300	50°	0,15	0,10	0,09	0,033	0,17	0,12	0,10	0,039	0,20	0,14	0,12	0,045	0,23	0,16	0,13	0,051
K.1.2	300	50°	0,15	0,10	0,09	0,033	0,17	0,12	0,10	0,039	0,20	0,14	0,12	0,045	0,23	0,16	0,13	0,051
K.2.1	300	50°	0,15	0,10	0,09	0,033	0,17	0,12	0,10	0,039	0,20	0,14	0,12	0,045	0,23	0,16	0,13	0,051
K.2.2	260	50°	0,11	0,08	0,07	0,025	0,14	0,10	0,08	0,032	0,17	0,12	0,10	0,039	0,20	0,14	0,12	0,045
K.3.1	260	50°	0,11	0,08	0,07	0,025	0,14	0,10	0,08	0,032	0,17	0,12	0,10	0,039	0,20	0,14	0,12	0,045
K.3.2	200	50°	0,11	0,08	0,07	0,025	0,14	0,10	0,08	0,032	0,17	0,12	0,10	0,039	0,20	0,14	0,12	0,045
N.1.1																		
N.1.2																		
N.2.1																		
N.2.2																		
N.2.3																		
N.3.1																		
N.3.2																		
N.3.3																		
N.4.1																		
S.1.1	80	40°	0,05	0,03	0,03	0,010	0,06	0,04	0,04	0,014	0,08	0,05	0,04	0,017	0,09	0,06	0,05	0,021
S.1.2	80	40°	0,05	0,03	0,03	0,010	0,06	0,04	0,04	0,014	0,08	0,05	0,04	0,017	0,09	0,06	0,05	0,021
S.2.1	60	40°	0,05	0,03	0,03	0,010	0,06	0,04	0,04	0,014	0,08	0,05	0,04	0,017	0,09	0,06	0,05	0,021
S.2.2	60	40°	0,05	0,03	0,03	0,010	0,06	0,04	0,04	0,014	0,08	0,05	0,04	0,017	0,09	0,06	0,05	0,021
S.2.3																		
S.3.1	140	40°	0,06	0,04	0,04	0,014	0,08	0,06	0,05	0,018	0,10	0,07	0,06	0,023	0,12	0,09	0,07	0,028
S.3.2	100	40°	0,06	0,04	0,04	0,014	0,08	0,06	0,05	0,018	0,10	0,07	0,06	0,023	0,12	0,09	0,07	0,028
S.3.3																		
H.1.1																		
H.1.2																		
H.1.3																		
H.1.4																		
H.2.1																		
H.3.1																		
O.1.1																		
O.1.2																		
O.2.1																		
O.2.2																		
O.3.1																		

 Depth of cut corresponds to the flute length

Index	53 585..., 53 587..., 53 586 ..., 53 642 ...																● 1st choice		
	Ø DC (mm) =																○ suitable		
	14				16				18				20				Emulsion	Compressed air	MMS
	a_e 0,05 x DC	a_e 0,1 x DC	a_e 0,15 x DC	h_m	a_e 0,05 x DC	a_e 0,1 x DC	a_e 0,15 x DC	h_m	a_e 0,05 x DC	a_e 0,1 x DC	a_e 0,15 x DC	h_m	a_e 0,05 x DC	a_e 0,1 x DC	a_e 0,15 x DC	h_m			
f_z (mm)				f_z (mm)				f_z (mm)				f_z (mm)							
P.1.1	0,26	0,18	0,15	0,057	0,27	0,19	0,16	0,060	0,28	0,20	0,16	0,063	0,30	0,21	0,17	0,066	○	●	○
P.1.2	0,23	0,16	0,13	0,052	0,25	0,18	0,14	0,055	0,26	0,18	0,15	0,058	0,28	0,20	0,16	0,062	○	●	○
P.1.3	0,23	0,16	0,13	0,052	0,25	0,18	0,14	0,055	0,26	0,18	0,15	0,058	0,28	0,20	0,16	0,062	○	●	○
P.1.4	0,23	0,16	0,13	0,052	0,25	0,18	0,14	0,055	0,26	0,18	0,15	0,058	0,28	0,20	0,16	0,062	○	●	○
P.1.5	0,23	0,16	0,13	0,052	0,25	0,18	0,14	0,055	0,26	0,18	0,15	0,058	0,28	0,20	0,16	0,062	○	●	○
P.2.1	0,26	0,18	0,15	0,057	0,27	0,19	0,16	0,060	0,28	0,20	0,16	0,063	0,30	0,21	0,17	0,066	○	●	○
P.2.2	0,26	0,18	0,15	0,057	0,27	0,19	0,16	0,060	0,28	0,20	0,16	0,063	0,30	0,21	0,17	0,066	○	●	○
P.2.3	0,23	0,16	0,13	0,052	0,25	0,18	0,14	0,055	0,26	0,18	0,15	0,058	0,28	0,20	0,16	0,062	○	●	○
P.2.4	0,23	0,16	0,13	0,052	0,25	0,18	0,14	0,055	0,26	0,18	0,15	0,058	0,28	0,20	0,16	0,062	○	●	○
P.3.1	0,23	0,16	0,13	0,052	0,25	0,18	0,14	0,055	0,26	0,18	0,15	0,058	0,28	0,20	0,16	0,062	○	●	○
P.3.2	0,23	0,16	0,13	0,052	0,25	0,18	0,14	0,055	0,26	0,18	0,15	0,058	0,28	0,20	0,16	0,062	○	●	○
P.3.3	0,23	0,16	0,13	0,052	0,25	0,18	0,14	0,055	0,26	0,18	0,15	0,058	0,28	0,20	0,16	0,062	○	●	○
P.4.1	0,18	0,13	0,10	0,040	0,19	0,13	0,11	0,042	0,20	0,14	0,12	0,045	0,21	0,15	0,12	0,047	●		
P.4.2	0,18	0,13	0,10	0,040	0,19	0,13	0,11	0,042	0,20	0,14	0,12	0,045	0,21	0,15	0,12	0,047	●		
M.1.1	0,18	0,13	0,10	0,040	0,19	0,13	0,11	0,042	0,20	0,14	0,12	0,045	0,21	0,15	0,12	0,047	●		
M.2.1	0,18	0,13	0,10	0,040	0,19	0,13	0,11	0,042	0,20	0,14	0,12	0,045	0,21	0,15	0,12	0,047	●		
M.3.1	0,18	0,13	0,10	0,040	0,19	0,13	0,11	0,042	0,20	0,14	0,12	0,045	0,21	0,15	0,12	0,047	●		
K.1.1	0,26	0,18	0,15	0,057	0,27	0,19	0,16	0,060	0,28	0,20	0,16	0,063	0,30	0,21	0,17	0,066	○	●	○
K.1.2	0,26	0,18	0,15	0,057	0,27	0,19	0,16	0,060	0,28	0,20	0,16	0,063	0,30	0,21	0,17	0,066	○	●	○
K.2.1	0,26	0,18	0,15	0,057	0,27	0,19	0,16	0,060	0,28	0,20	0,16	0,063	0,30	0,21	0,17	0,066	○	●	○
K.2.2	0,23	0,16	0,13	0,052	0,25	0,18	0,14	0,055	0,26	0,18	0,15	0,058	0,28	0,20	0,16	0,062	○	●	○
K.3.1	0,23	0,16	0,13	0,052	0,25	0,18	0,14	0,055	0,26	0,18	0,15	0,058	0,28	0,20	0,16	0,062	○	●	○
K.3.2	0,23	0,16	0,13	0,052	0,25	0,18	0,14	0,055	0,26	0,18	0,15	0,058	0,28	0,20	0,16	0,062	○	●	○
N.1.1																			
N.1.2																			
N.2.1																			
N.2.2																			
N.2.3																			
N.3.1																			
N.3.2																			
N.3.3																			
N.4.1																			
S.1.1	0,11	0,08	0,06	0,024	0,11	0,08	0,07	0,026	0,12	0,09	0,07	0,027	0,13	0,09	0,08	0,029	●		
S.1.2	0,11	0,08	0,06	0,024	0,11	0,08	0,07	0,026	0,12	0,09	0,07	0,027	0,13	0,09	0,08	0,029	●		
S.2.1	0,11	0,08	0,06	0,024	0,11	0,08	0,07	0,026	0,12	0,09	0,07	0,027	0,13	0,09	0,08	0,029	●		
S.2.2	0,11	0,08	0,06	0,024	0,11	0,08	0,07	0,026	0,12	0,09	0,07	0,027	0,13	0,09	0,08	0,029	●		
S.2.3																			
S.3.1	0,15	0,10	0,08	0,033	0,16	0,11	0,09	0,035	0,17	0,12	0,10	0,037	0,18	0,12	0,10	0,040	●		
S.3.2	0,15	0,10	0,08	0,033	0,16	0,11	0,09	0,035	0,17	0,12	0,10	0,037	0,18	0,12	0,10	0,040	●		
S.3.3																			
H.1.1																			
H.1.2																			
H.1.3																			
H.1.4																			
H.2.1																			
H.3.1																			
O.1.1																			
O.1.2																			
O.2.1																			
O.2.2																			
O.3.1																			

Cutting data standard values – CircularLine – End mill – CCR-UNI, extra long

Index	Type extra long			53 589 ... / 53 593 ...														
	4xDC	5xDC	max. angle of engagement	Ø DC (mm) =														
				6			8			10			12			14		
	v _c (m/min)	a _e 0,05 x DC	a _e 0,1 x DC	h _m	a _e 0,05 x DC	a _e 0,1 x DC	h _m	a _e 0,05 x DC	a _e 0,1 x DC	h _m	a _e 0,05 x DC	a _e 0,1 x DC	h _m	a _e 0,05 x DC	a _e 0,1 x DC	h _m		
f _z (mm)		f _z (mm)	f _z (mm)	f _z (mm)	f _z (mm)	f _z (mm)	f _z (mm)	f _z (mm)	f _z (mm)	f _z (mm)	f _z (mm)	f _z (mm)	f _z (mm)	f _z (mm)	f _z (mm)			
P.1.1	250	220	50°	0,07	0,05	0,016	0,08	0,06	0,019	0,10	0,07	0,022	0,11	0,08	0,025	0,13	0,09	0,028
P.1.2	250	220	50°	0,06	0,04	0,013	0,07	0,05	0,016	0,08	0,06	0,019	0,10	0,07	0,022	0,11	0,08	0,025
P.1.3	250	220	50°	0,06	0,04	0,013	0,07	0,05	0,016	0,08	0,06	0,019	0,10	0,07	0,022	0,11	0,08	0,025
P.1.4	230	210	50°	0,06	0,04	0,013	0,07	0,05	0,016	0,08	0,06	0,019	0,10	0,07	0,022	0,11	0,08	0,025
P.1.5	230	210	50°	0,06	0,04	0,013	0,07	0,05	0,016	0,08	0,06	0,019	0,10	0,07	0,022	0,11	0,08	0,025
P.2.1	250	220	50°	0,07	0,05	0,016	0,08	0,06	0,019	0,10	0,07	0,022	0,11	0,08	0,025	0,13	0,09	0,028
P.2.2	250	220	50°	0,07	0,05	0,016	0,08	0,06	0,019	0,10	0,07	0,022	0,11	0,08	0,025	0,13	0,09	0,028
P.2.3	230	210	50°	0,06	0,04	0,013	0,07	0,05	0,016	0,08	0,06	0,019	0,10	0,07	0,022	0,11	0,08	0,025
P.2.4	230	210	50°	0,06	0,04	0,013	0,07	0,05	0,016	0,08	0,06	0,019	0,10	0,07	0,022	0,11	0,08	0,025
P.3.1	200	180	50°	0,06	0,04	0,013	0,07	0,05	0,016	0,08	0,06	0,019	0,10	0,07	0,022	0,11	0,08	0,025
P.3.2	200	180	45°	0,06	0,04	0,013	0,07	0,05	0,016	0,08	0,06	0,019	0,10	0,07	0,022	0,11	0,08	0,025
P.3.3	180	160	45°	0,06	0,04	0,013	0,07	0,05	0,016	0,08	0,06	0,019	0,10	0,07	0,022	0,11	0,08	0,025
P.4.1	150	130	45°	0,04	0,03	0,009	0,05	0,04	0,011	0,06	0,05	0,014	0,08	0,05	0,017	0,09	0,06	0,020
P.4.2	130	110	45°	0,04	0,03	0,009	0,05	0,04	0,011	0,06	0,05	0,014	0,08	0,05	0,017	0,09	0,06	0,020
M.1.1	110	90	45°	0,04	0,03	0,009	0,05	0,04	0,011	0,06	0,05	0,014	0,08	0,05	0,017	0,09	0,06	0,020
M.2.1	110	90	45°	0,04	0,03	0,009	0,05	0,04	0,011	0,06	0,05	0,014	0,08	0,05	0,017	0,09	0,06	0,020
M.3.1	110	90	45°	0,04	0,03	0,009	0,05	0,04	0,011	0,06	0,05	0,014	0,08	0,05	0,017	0,09	0,06	0,020
K.1.1	260	230	50°	0,07	0,05	0,016	0,08	0,06	0,019	0,10	0,07	0,022	0,11	0,08	0,025	0,13	0,09	0,028
K.1.2	260	230	50°	0,07	0,05	0,016	0,08	0,06	0,019	0,10	0,07	0,022	0,11	0,08	0,025	0,13	0,09	0,028
K.2.1	260	230	50°	0,07	0,05	0,016	0,08	0,06	0,019	0,10	0,07	0,022	0,11	0,08	0,025	0,13	0,09	0,028
K.2.2	230	210	50°	0,07	0,05	0,016	0,08	0,06	0,019	0,10	0,07	0,022	0,11	0,08	0,025	0,13	0,09	0,028
K.3.1	230	210	50°	0,06	0,04	0,013	0,07	0,05	0,016	0,08	0,06	0,019	0,10	0,07	0,022	0,11	0,08	0,025
K.3.2	180	170	50°	0,06	0,04	0,013	0,07	0,05	0,016	0,08	0,06	0,019	0,10	0,07	0,022	0,11	0,08	0,025
N.1.1																		
N.1.2																		
N.2.1																		
N.2.2																		
N.2.3																		
N.3.1																		
N.3.2																		
N.3.3																		
N.4.1																		
S.1.1	70	60	40°	0,03	0,02	0,007	0,04	0,03	0,009	0,05	0,04	0,011	0,06	0,04	0,014	0,07	0,05	0,016
S.1.2	70	60	40°	0,03	0,02	0,007	0,04	0,03	0,009	0,05	0,04	0,011	0,06	0,04	0,014	0,07	0,05	0,016
S.2.1	50	40	40°	0,03	0,02	0,007	0,04	0,03	0,009	0,05	0,04	0,011	0,06	0,04	0,014	0,07	0,05	0,016
S.2.2	50	40	40°	0,03	0,02	0,007	0,04	0,03	0,009	0,05	0,04	0,011	0,06	0,04	0,014	0,07	0,05	0,016
S.2.3																		
S.3.1	120	100	40°	0,03	0,02	0,007	0,04	0,03	0,009	0,05	0,04	0,011	0,06	0,04	0,014	0,07	0,05	0,016
S.3.2	90	80	40°	0,03	0,02	0,007	0,04	0,03	0,009	0,05	0,04	0,011	0,06	0,04	0,014	0,07	0,05	0,016
S.3.3																		
H.1.1																		
H.1.2																		
H.1.3																		
H.1.4																		
H.2.1																		
H.3.1																		
O.1.1																		
O.1.2																		
O.2.1																		
O.2.2																		
O.3.1																		

 Depth of cut corresponds to the flute length

Index	53 589 ... / 53 593 ...									● 1st choice		
	Ø DC (mm) =									○ suitable		
	16			18			20			Emulsion	Compressed air	MMS
	a_p 0,05 x DC	a_p 0,1 x DC	h_m	a_p 0,05 x DC	a_p 0,1 x DC	h_m	a_p 0,05 x DC	a_p 0,1 x DC	h_m			
f_z (mm)			f_z (mm)			f_z (mm)						
P.1.1	0,13	0,10	0,030	0,14	0,10	0,032	0,15	0,11	0,033	○	●	○
P.1.2	0,12	0,09	0,027	0,13	0,09	0,028	0,13	0,10	0,030	○	●	○
P.1.3	0,12	0,09	0,027	0,13	0,09	0,028	0,13	0,10	0,030	○	●	○
P.1.4	0,12	0,09	0,027	0,13	0,09	0,028	0,13	0,10	0,030	○	●	○
P.1.5	0,12	0,09	0,027	0,13	0,09	0,028	0,13	0,10	0,030	○	●	○
P.2.1	0,13	0,10	0,030	0,14	0,10	0,032	0,15	0,11	0,033	○	●	○
P.2.2	0,13	0,10	0,030	0,14	0,10	0,032	0,15	0,11	0,033	○	●	○
P.2.3	0,12	0,09	0,027	0,13	0,09	0,028	0,13	0,10	0,030	○	●	○
P.2.4	0,12	0,09	0,027	0,13	0,09	0,028	0,13	0,10	0,030	○	●	○
P.3.1	0,12	0,09	0,027	0,13	0,09	0,028	0,13	0,10	0,030	○	●	○
P.3.2	0,12	0,09	0,027	0,13	0,09	0,028	0,13	0,10	0,030	○	●	○
P.3.3	0,12	0,09	0,027	0,13	0,09	0,028	0,13	0,10	0,030	○	●	○
P.4.1	0,10	0,07	0,022	0,10	0,07	0,023	0,11	0,08	0,024	●		
P.4.2	0,10	0,07	0,022	0,10	0,07	0,023	0,11	0,08	0,024	●		
M.1.1	0,10	0,07	0,022	0,10	0,07	0,023	0,11	0,08	0,024	●		
M.2.1	0,10	0,07	0,022	0,10	0,07	0,023	0,11	0,08	0,024	●		
M.3.1	0,10	0,07	0,022	0,10	0,07	0,023	0,11	0,08	0,024	●		
K.1.1	0,13	0,10	0,030	0,14	0,10	0,032	0,15	0,11	0,033	○	●	○
K.1.2	0,13	0,10	0,030	0,14	0,10	0,032	0,15	0,11	0,033	○	●	○
K.2.1	0,13	0,10	0,030	0,14	0,10	0,032	0,15	0,11	0,033	○	●	○
K.2.2	0,13	0,10	0,030	0,14	0,10	0,032	0,15	0,11	0,033	○	●	○
K.3.1	0,12	0,09	0,027	0,13	0,09	0,028	0,13	0,10	0,030	○	●	○
K.3.2	0,12	0,09	0,027	0,13	0,09	0,028	0,13	0,10	0,030	○	●	○
N.1.1												
N.1.2												
N.2.1												
N.2.2												
N.2.3												
N.3.1												
N.3.2												
N.3.3												
N.4.1												
S.1.1	0,07	0,05	0,017	0,08	0,06	0,018	0,08	0,06	0,019	●		
S.1.2	0,07	0,05	0,017	0,08	0,06	0,018	0,08	0,06	0,019	●		
S.2.1	0,07	0,05	0,017	0,08	0,06	0,018	0,08	0,06	0,019	●		
S.2.2	0,07	0,05	0,017	0,08	0,06	0,018	0,08	0,06	0,019	●		
S.2.3												
S.3.1	0,07	0,05	0,017	0,08	0,06	0,018	0,08	0,06	0,019	●		
S.3.2	0,07	0,05	0,017	0,08	0,06	0,018	0,08	0,06	0,019	●		
S.3.3												
H.1.1												
H.1.2												
H.1.3												
H.1.4												
H.2.1												
H.3.1												
O.1.1												
O.1.2												
O.2.1												
O.2.2												
O.3.1												

Cutting data standard values – CircularLine – CCR-VA, long 3xDC

Index	Type long		53 643 ...															
	v _c (m/min)	max. angle of engagement	Ø DC (mm) =															
			6				8				10				12			
			a _e 0,05 x DC	a _e 0,1 x DC	a _e 0,15 x DC	h _m	a _e 0,05 x DC	a _e 0,1 x DC	a _e 0,15 x DC	h _m	a _e 0,05 x DC	a _e 0,1 x DC	a _e 0,15 x DC	h _m	a _e 0,05 x DC	a _e 0,1 x DC	a _e 0,15 x DC	h _m
f _z (mm)				f _z (mm)				f _z (mm)				f _z (mm)						
P.1.1																		
P.1.2																		
P.1.3																		
P.1.4																		
P.1.5																		
P.2.1																		
P.2.2																		
P.2.3																		
P.2.4																		
P.3.1																		
P.3.2																		
P.3.3																		
P.4.1	200	45°	0,09	0,07	0,05	0,021	0,11	0,08	0,07	0,026	0,14	0,10	0,08	0,031	0,16	0,11	0,09	0,035
P.4.2	180	45°	0,09	0,07	0,05	0,021	0,11	0,08	0,07	0,026	0,14	0,10	0,08	0,031	0,16	0,11	0,09	0,035
M.1.1	160	45°	0,09	0,07	0,05	0,021	0,11	0,08	0,07	0,026	0,14	0,10	0,08	0,031	0,16	0,11	0,09	0,035
M.2.1	160	45°	0,09	0,07	0,05	0,021	0,11	0,08	0,07	0,026	0,14	0,10	0,08	0,031	0,16	0,11	0,09	0,035
M.3.1	160	45°	0,09	0,07	0,05	0,021	0,11	0,08	0,07	0,026	0,14	0,10	0,08	0,031	0,16	0,11	0,09	0,035
K.1.1																		
K.1.2																		
K.2.1																		
K.2.2																		
K.3.1																		
K.3.2																		
N.1.1																		
N.1.2																		
N.2.1																		
N.2.2																		
N.2.3																		
N.3.1																		
N.3.2																		
N.3.3																		
N.4.1																		
S.1.1	85	40°	0,05	0,03	0,03	0,010	0,06	0,04	0,04	0,014	0,08	0,05	0,04	0,017	0,09	0,06	0,05	0,021
S.1.2	85	40°	0,05	0,03	0,03	0,010	0,06	0,04	0,04	0,014	0,08	0,05	0,04	0,017	0,09	0,06	0,05	0,021
S.2.1	65	40°	0,05	0,03	0,03	0,010	0,06	0,04	0,04	0,014	0,08	0,05	0,04	0,017	0,09	0,06	0,05	0,021
S.2.2	65	40°	0,05	0,03	0,03	0,010	0,06	0,04	0,04	0,014	0,08	0,05	0,04	0,017	0,09	0,06	0,05	0,021
S.2.3	65	40°	0,05	0,03	0,03	0,010	0,06	0,04	0,04	0,014	0,08	0,05	0,04	0,017	0,09	0,06	0,05	0,021
S.3.1	160	40°	0,06	0,04	0,04	0,014	0,08	0,06	0,05	0,018	0,10	0,07	0,06	0,023	0,12	0,09	0,07	0,028
S.3.2	120	40°	0,06	0,04	0,04	0,014	0,08	0,06	0,05	0,018	0,10	0,07	0,06	0,023	0,12	0,09	0,07	0,028
S.3.3																		
H.1.1																		
H.1.2																		
H.1.3																		
H.1.4																		
H.2.1																		
H.3.1																		
O.1.1																		
O.1.2																		
O.2.1																		
O.2.2																		
O.3.1																		

 Depth of cut corresponds to the flute length

Index	53 643 ...																● 1st choice ○ suitable		
	Ø DC (mm) =																Emulsion	Compressed air	MMS
	14				16				18				20						
	a_e 0,05 x DC	a_e 0,1 x DC	a_e 0,15 x DC	h_m	a_e 0,05 x DC	a_e 0,1 x DC	a_e 0,15 x DC	h_m	a_e 0,05 x DC	a_e 0,1 x DC	a_e 0,15 x DC	h_m	a_e 0,05 x DC	a_e 0,1 x DC	a_e 0,15 x DC	h_m			
f_z (mm)				f_z (mm)				f_z (mm)				f_z (mm)							
P.1.1																			
P.1.2																			
P.1.3																			
P.1.4																			
P.1.5																			
P.2.1																			
P.2.2																			
P.2.3																			
P.2.4																			
P.3.1																			
P.3.2																			
P.3.3																			
P.4.1	0,18	0,13	0,10	0,040	0,19	0,13	0,11	0,042	0,20	0,14	0,12	0,045	0,21	0,15	0,12	0,047	●		
P.4.2	0,18	0,13	0,10	0,040	0,19	0,13	0,11	0,042	0,20	0,14	0,12	0,045	0,21	0,15	0,12	0,047	●		
M.1.1	0,18	0,13	0,10	0,040	0,19	0,13	0,11	0,042	0,20	0,14	0,12	0,045	0,21	0,15	0,12	0,047	●		
M.2.1	0,18	0,13	0,10	0,040	0,19	0,13	0,11	0,042	0,20	0,14	0,12	0,045	0,21	0,15	0,12	0,047	●		
M.3.1	0,18	0,13	0,10	0,040	0,19	0,13	0,11	0,042	0,20	0,14	0,12	0,045	0,21	0,15	0,12	0,047	●		
K.1.1																			
K.1.2																			
K.2.1																			
K.2.2																			
K.3.1																			
K.3.2																			
N.1.1																			
N.1.2																			
N.2.1																			
N.2.2																			
N.2.3																			
N.3.1																			
N.3.2																			
N.3.3																			
N.4.1																			
S.1.1	0,11	0,08	0,06	0,024	0,11	0,08	0,07	0,026	0,12	0,09	0,07	0,027	0,13	0,09	0,08	0,029	●		
S.1.2	0,11	0,08	0,06	0,024	0,11	0,08	0,07	0,026	0,12	0,09	0,07	0,027	0,13	0,09	0,08	0,029	●		
S.2.1	0,11	0,08	0,06	0,024	0,11	0,08	0,07	0,026	0,12	0,09	0,07	0,027	0,13	0,09	0,08	0,029	●		
S.2.2	0,11	0,08	0,06	0,024	0,11	0,08	0,07	0,026	0,12	0,09	0,07	0,027	0,13	0,09	0,08	0,029	●		
S.2.3	0,11	0,08	0,06	0,024	0,11	0,08	0,07	0,026	0,12	0,09	0,07	0,027	0,13	0,09	0,08	0,029	●		
S.3.1	0,15	0,10	0,08	0,033	0,16	0,11	0,09	0,035	0,17	0,12	0,10	0,037	0,18	0,12	0,10	0,040	●		
S.3.2	0,15	0,10	0,08	0,033	0,16	0,11	0,09	0,035	0,17	0,12	0,10	0,037	0,18	0,12	0,10	0,040	●		
S.3.3																			
H.1.1																			
H.1.2																			
H.1.3																			
H.1.4																			
H.2.1																			
H.3.1																			
O.1.1																			
O.1.2																			
O.2.1																			
O.2.2																			
O.3.1																			

Cutting data standard values – CircularLine – CCR-VA, extra-long 4xDC

Index	Type extra long		53 644 ...														
	v _c (m/min)	max. angle of engagement	Ø DC (mm) =														
			6			8			10			12			14		
			a _e 0,05 x DC	a _e 0,1 x DC	h _m	a _e 0,05 x DC	a _e 0,1 x DC	h _m	a _e 0,05 x DC	a _e 0,1 x DC	h _m	a _e 0,05 x DC	a _e 0,1 x DC	h _m	a _e 0,05 x DC	a _e 0,1 x DC	h _m
f _z (mm)			f _z (mm)			f _z (mm)			f _z (mm)			f _z (mm)					
P.1.1																	
P.1.2																	
P.1.3																	
P.1.4																	
P.1.5																	
P.2.1																	
P.2.2																	
P.2.3																	
P.2.4																	
P.3.1																	
P.3.2																	
P.3.3																	
P.4.1	170	45°	0,04	0,03	0,009	0,05	0,04	0,011	0,06	0,05	0,014	0,08	0,05	0,017	0,09	0,06	0,020
P.4.2	150	45°	0,04	0,03	0,009	0,05	0,04	0,011	0,06	0,05	0,014	0,08	0,05	0,017	0,09	0,06	0,020
M.1.1	125	45°	0,04	0,03	0,009	0,05	0,04	0,011	0,06	0,05	0,014	0,08	0,05	0,017	0,09	0,06	0,020
M.2.1	125	45°	0,04	0,03	0,009	0,05	0,04	0,011	0,06	0,05	0,014	0,08	0,05	0,017	0,09	0,06	0,020
M.3.1	125	45°	0,04	0,03	0,009	0,05	0,04	0,011	0,06	0,05	0,014	0,08	0,05	0,017	0,09	0,06	0,020
K.1.1																	
K.1.2																	
K.2.1																	
K.2.2																	
K.3.1																	
K.3.2																	
N.1.1																	
N.1.2																	
N.2.1																	
N.2.2																	
N.2.3																	
N.3.1																	
N.3.2																	
N.3.3																	
N.4.1																	
S.1.1	75	40°	0,03	0,02	0,007	0,04	0,03	0,009	0,05	0,04	0,011	0,06	0,04	0,014	0,07	0,05	0,016
S.1.2	75	40°	0,03	0,02	0,007	0,04	0,03	0,009	0,05	0,04	0,011	0,06	0,04	0,014	0,07	0,05	0,016
S.2.1	55	40°	0,03	0,02	0,007	0,04	0,03	0,009	0,05	0,04	0,011	0,06	0,04	0,014	0,07	0,05	0,016
S.2.2	55	40°	0,03	0,02	0,007	0,04	0,03	0,009	0,05	0,04	0,011	0,06	0,04	0,014	0,07	0,05	0,016
S.2.3	55	40°	0,03	0,02	0,007	0,04	0,03	0,009	0,05	0,04	0,011	0,06	0,04	0,014	0,07	0,05	0,016
S.3.1	140	40°	0,03	0,02	0,007	0,04	0,03	0,009	0,05	0,04	0,011	0,06	0,04	0,014	0,07	0,05	0,016
S.3.2	105	40°	0,03	0,02	0,007	0,04	0,03	0,009	0,05	0,04	0,011	0,06	0,04	0,014	0,07	0,05	0,016
S.3.3																	
H.1.1																	
H.1.2																	
H.1.3																	
H.1.4																	
H.2.1																	
H.3.1																	
O.1.1																	
O.1.2																	
O.2.1																	
O.2.2																	
O.3.1																	

 Depth of cut corresponds to the flute length

Index	53 644 ...									● 1st choice ○ suitable		
	Ø DC (mm) =									Emulsion	Compressed air	MMS
	16			18			20					
	a_s 0,05 x DC	a_s 0,1 x DC	h_m	a_s 0,05 x DC	a_s 0,1 x DC	h_m	a_s 0,05 x DC	a_s 0,1 x DC	h_m			
f_z (mm)			f_z (mm)			f_z (mm)						
P.1.1												
P.1.2												
P.1.3												
P.1.4												
P.1.5												
P.2.1												
P.2.2												
P.2.3												
P.2.4												
P.3.1												
P.3.2												
P.3.3												
P.4.1	0,10	0,07	0,022	0,10	0,07	0,023	0,11	0,08	0,024	●		
P.4.2	0,10	0,07	0,022	0,10	0,07	0,023	0,11	0,08	0,024	●		
M.1.1	0,10	0,07	0,022	0,10	0,07	0,023	0,11	0,08	0,024	●		
M.2.1	0,10	0,07	0,022	0,10	0,07	0,023	0,11	0,08	0,024	●		
M.3.1	0,10	0,07	0,022	0,10	0,07	0,023	0,11	0,08	0,024	●		
K.1.1												
K.1.2												
K.2.1												
K.2.2												
K.3.1												
K.3.2												
N.1.1												
N.1.2												
N.2.1												
N.2.2												
N.2.3												
N.3.1												
N.3.2												
N.3.3												
N.4.1												
S.1.1	0,07	0,05	0,017	0,08	0,06	0,018	0,08	0,06	0,019	●		
S.1.2	0,07	0,05	0,017	0,08	0,06	0,018	0,08	0,06	0,019	●		
S.2.1	0,07	0,05	0,017	0,08	0,06	0,018	0,08	0,06	0,019	●		
S.2.2	0,07	0,05	0,017	0,08	0,06	0,018	0,08	0,06	0,019	●		
S.2.3	0,07	0,05	0,017	0,08	0,06	0,018	0,08	0,06	0,019	●		
S.3.1	0,07	0,05	0,017	0,08	0,06	0,018	0,08	0,06	0,019	●		
S.3.2	0,07	0,05	0,017	0,08	0,06	0,018	0,08	0,06	0,019	●		
S.3.3												
H.1.1												
H.1.2												
H.1.3												
H.1.4												
H.2.1												
H.3.1												
O.1.1												
O.1.2												
O.2.1												
O.2.2												
O.3.1												

Cutting data standard values – CircularLine – CCR-AL

Index	Type long			max. angle of engagement	53 590 ..., 53 591 ..., 53 594 ..., 53 595 ..., 53 641 ...																	
	Type extra long		v _c (m/min)		Ø DC (mm) =																	
	3xDC	4xDC			6				8				10				12					
	5xDC	a _e			a _e			a _e			a _e			a _e			a _e					
				0,1 x DC	0,2 x DC	0,3 x DC	h _m	0,1 x DC	0,2 x DC	0,3 x DC	h _m	0,1 x DC	0,2 x DC	0,3 x DC	h _m	0,1 x DC	0,2 x DC	0,3 x DC	h _m			
				f _z (mm)			f _z (mm)			f _z (mm)			f _z (mm)			f _z (mm)			f _z (mm)			
P.1.1																						
P.1.2																						
P.1.3																						
P.1.4																						
P.1.5																						
P.2.1																						
P.2.2																						
P.2.3																						
P.2.4																						
P.3.1																						
P.3.2																						
P.3.3																						
P.4.1																						
P.4.2																						
M.1.1																						
M.2.1																						
M.3.1																						
K.1.1																						
K.1.2																						
K.2.1																						
K.2.2																						
K.3.1																						
K.3.2																						
N.1.1	500	400	300	60°	0,30	0,21	0,18	0,096	0,35	0,25	0,20	0,111	0,40	0,28	0,23	0,126	0,45	0,31	0,26	0,141		
N.1.2	500	400	300	60°	0,30	0,21	0,18	0,096	0,35	0,25	0,20	0,111	0,40	0,28	0,23	0,126	0,45	0,31	0,26	0,141		
N.2.1	500	400	300	60°	0,30	0,21	0,18	0,096	0,35	0,25	0,20	0,111	0,40	0,28	0,23	0,126	0,45	0,31	0,26	0,141		
N.2.2	500	400	300	60°	0,30	0,21	0,18	0,096	0,35	0,25	0,20	0,111	0,40	0,28	0,23	0,126	0,45	0,31	0,26	0,141		
N.2.3	400	350	265	60°	0,30	0,21	0,18	0,096	0,35	0,25	0,20	0,111	0,40	0,28	0,23	0,126	0,45	0,31	0,26	0,141		
N.3.1	400	350	265	60°	0,30	0,21	0,18	0,096	0,35	0,25	0,20	0,111	0,40	0,28	0,23	0,126	0,45	0,31	0,26	0,141		
N.3.2	400	350	265	60°	0,30	0,21	0,18	0,096	0,35	0,25	0,20	0,111	0,40	0,28	0,23	0,126	0,45	0,31	0,26	0,141		
N.3.3	300	250	190	60°	0,30	0,21	0,18	0,096	0,35	0,25	0,20	0,111	0,40	0,28	0,23	0,126	0,45	0,31	0,26	0,141		
N.4.1																						
S.1.1																						
S.1.2																						
S.2.1																						
S.2.2																						
S.2.3																						
S.3.1																						
S.3.2																						
S.3.3																						
H.1.1																						
H.1.2																						
H.1.3																						
H.1.4																						
H.2.1																						
H.3.1																						
O.1.1																						
O.1.2																						
O.2.1																						
O.2.2																						
O.3.1																						

 Depth of cut corresponds to the flute length

 Plunging angle for ramping and helical milling: 4°

Index	53 590 ..., 53 591 ..., 53 594 ..., 53 595 ..., 53 641 ...																● 1st choice ○ suitable			
	Ø DC (mm) =																Emulsion	Compressed air	MMS	
	14				16				18				20							
	a_e 0,1 x DC	a_e 0,2 x DC	a_e 0,3 x DC	h_m	a_e 0,1 x DC	a_e 0,2 x DC	a_e 0,3 x DC	h_m	a_e 0,1 x DC	a_e 0,2 x DC	a_e 0,3 x DC	h_m	a_e 0,1 x DC	a_e 0,2 x DC	a_e 0,3 x DC	h_m				
f_z (mm)				f_z (mm)				f_z (mm)				f_z (mm)								
P.1.1																				
P.1.2																				
P.1.3																				
P.1.4																				
P.1.5																				
P.2.1																				
P.2.2																				
P.2.3																				
P.2.4																				
P.3.1																				
P.3.2																				
P.3.3																				
P.4.1																				
P.4.2																				
M.1.1																				
M.2.1																				
M.3.1																				
K.1.1																				
K.1.2																				
K.2.1																				
K.2.2																				
K.3.1																				
K.3.2																				
N.1.1	0,49	0,35	0,29	0,156	0,52	0,37	0,30	0,164	0,54	0,38	0,31	0,171	0,57	0,40	0,33	0,179	●		○	
N.1.2	0,49	0,35	0,29	0,156	0,52	0,37	0,30	0,164	0,54	0,38	0,31	0,171	0,57	0,40	0,33	0,179	●		○	
N.2.1	0,49	0,35	0,29	0,156	0,52	0,37	0,30	0,164	0,54	0,38	0,31	0,171	0,57	0,40	0,33	0,179	●		○	
N.2.2	0,49	0,35	0,29	0,156	0,52	0,37	0,30	0,164	0,54	0,38	0,31	0,171	0,57	0,40	0,33	0,179	●		○	
N.2.3	0,49	0,35	0,29	0,156	0,52	0,37	0,30	0,164	0,54	0,38	0,31	0,171	0,57	0,40	0,33	0,179	●		○	
N.3.1	0,49	0,35	0,29	0,156	0,52	0,37	0,30	0,164	0,54	0,38	0,31	0,171	0,57	0,40	0,33	0,179	●		○	
N.3.2	0,49	0,35	0,29	0,156	0,52	0,37	0,30	0,164	0,54	0,38	0,31	0,171	0,57	0,40	0,33	0,179	●		○	
N.3.3	0,49	0,35	0,29	0,156	0,52	0,37	0,30	0,164	0,54	0,38	0,31	0,171	0,57	0,40	0,33	0,179	●		○	
N.4.1																				
S.1.1																				
S.1.2																				
S.2.1																				
S.2.2																				
S.2.3																				
S.3.1																				
S.3.2																				
S.3.3																				
H.1.1																				
H.1.2																				
H.1.3																				
H.1.4																				
H.2.1																				
H.3.1																				
O.1.1																				
O.1.2																				
O.2.1																				
O.2.2																				
O.3.1																				

Cutting data standard values – CircularLine – CCR Ti, long

Index	Type long		52 510 ...											
	v _c (m/min)	max. angle of engagement	Ø DC (mm) =											
			6				8				10			
			a _s 0,05 x DC	a _s 0,10 x DC	a _s 0,15 x DC	h _m	a _s 0,05 x DC	a _s 0,10 x DC	a _s 0,15 x DC	h _m	a _s 0,05 x DC	a _s 0,10 x DC	a _s 0,15 x DC	h _m
f _z (mm)			f _z (mm)			f _z (mm)			f _z (mm)					
P.4.1	200	35°	0,080	0,057	0,046	0,022	0,098	0,070	0,057	0,033	0,125	0,089	0,072	0,042
P.4.2	180	35°	0,080	0,057	0,046	0,022	0,098	0,070	0,057	0,033	0,125	0,089	0,072	0,042
M.1.1	200	35°	0,080	0,057	0,046	0,022	0,098	0,070	0,057	0,033	0,125	0,089	0,072	0,042
M.2.1	160	35°	0,080	0,057	0,046	0,022	0,098	0,070	0,057	0,033	0,125	0,089	0,072	0,042
M.3.1	180	35°	0,080	0,057	0,046	0,022	0,098	0,070	0,057	0,033	0,125	0,089	0,072	0,042
S.1.1														
S.1.2														
S.2.1														
S.2.2														
S.2.3														
S.3.1	140	25°	0,060	0,042	0,034	0,020	0,070	0,049	0,040	0,030	0,089	0,063	0,052	0,040
S.3.2	120	25°	0,060	0,042	0,034	0,020	0,070	0,049	0,040	0,030	0,089	0,063	0,052	0,040
S.3.3	100	25°	0,045	0,032	0,026	0,018	0,052	0,037	0,030	0,028	0,067	0,047	0,039	0,038

Cutting data standard values – CircularLine – CCR-Ti, extra-long

Index	Type extra long		52 510 ...											
	v _c (m/min)	max. angle of engagement	Ø DC (mm) =											
			6			8			10			12		
			a _s 0,05 x DC	a _s 0,10 x DC	h _m	a _s 0,05 x DC	a _s 0,10 x DC	h _m	a _s 0,05 x DC	a _s 0,10 x DC	h _m	a _s 0,05 x DC	a _s 0,10 x DC	h _m
f _z (mm)			f _z (mm)			f _z (mm)			f _z (mm)					
P.4.1	170	35°	0,057	0,046	0,018	0,070	0,057	0,026	0,089	0,072	0,036	0,114	0,093	0,046
P.4.2	150	35°	0,057	0,046	0,018	0,070	0,057	0,026	0,089	0,072	0,036	0,114	0,093	0,046
M.1.1	170	35°	0,057	0,046	0,018	0,070	0,057	0,026	0,089	0,072	0,036	0,114	0,093	0,046
M.2.1	130	35°	0,057	0,046	0,018	0,070	0,057	0,026	0,089	0,072	0,036	0,114	0,093	0,046
M.3.1	150	35°	0,057	0,046	0,018	0,070	0,057	0,026	0,089	0,072	0,036	0,114	0,093	0,046
S.1.1														
S.1.2														
S.2.1														
S.2.2														
S.2.3														
S.3.1	120	25°	0,031	0,022	0,015	0,036	0,025	0,020	0,045	0,032	0,030	0,054	0,038	0,040
S.3.2	100	25°	0,031	0,022	0,015	0,036	0,025	0,020	0,045	0,032	0,030	0,054	0,038	0,040
S.3.3	90	25°	0,022	0,016	0,013	0,027	0,019	0,015	0,036	0,025	0,025	0,045	0,032	0,035

 Depth of cut corresponds to the flute length

Index	52 510 ...												● 1st choice		
	Ø DC (mm) =												○ suitable		
	12				16				20				Emulsion	Compressed air	MMS
	a_e 0,05 x DC	a_e 0,10 x DC	a_e 0,15 x DC	h_m	a_e 0,05 x DC	a_e 0,10 x DC	a_e 0,15 x DC	h_m	a_e 0,05 x DC	a_e 0,10 x DC	a_e 0,15 x DC	h_m			
f_z (mm)				f_z (mm)				f_z (mm)							
P.4.1	0,161	0,114	0,093	0,053	0,188	0,133	0,108	0,064	0,268	0,190	0,155	0,079	●	○	
P.4.2	0,161	0,114	0,093	0,053	0,188	0,133	0,108	0,064	0,268	0,190	0,155	0,079	●	○	
M.1.1	0,161	0,114	0,093	0,053	0,188	0,133	0,108	0,064	0,268	0,190	0,155	0,079	●	○	
M.2.1	0,161	0,114	0,093	0,053	0,188	0,133	0,108	0,064	0,268	0,190	0,155	0,079	●	○	
M.3.1	0,161	0,114	0,093	0,053	0,188	0,133	0,108	0,064	0,268	0,190	0,155	0,079	●	○	
S.1.1															
S.1.2															
S.2.1															
S.2.2															
S.2.3															
S.3.1	0,113	0,080	0,065	0,050	0,157	0,111	0,090	0,060	0,217	0,153	0,125	0,075	●		
S.3.2	0,113	0,080	0,065	0,050	0,157	0,111	0,090	0,060	0,217	0,153	0,125	0,075	●		
S.3.3	0,085	0,060	0,049	0,048	0,117	0,083	0,068	0,058	0,163	0,115	0,094	0,070	●		

Index	52 510 ...						● 1st choice		
	Ø DC (mm) =						○ suitable		
	16			20			Emulsion	Compressed air	MMS
	a_e 0,05 x DC	a_e 0,10 x DC	h_m	a_e 0,05 x DC	a_e 0,10 x DC	h_m			
f_z (mm)			f_z (mm)						
P.4.1	0,133	0,108	0,056	0,190	0,155	0,066	●	○	
P.4.2	0,133	0,108	0,056	0,190	0,155	0,066	●	○	
M.1.1	0,133	0,108	0,056	0,190	0,155	0,066	●	○	
M.2.1	0,133	0,108	0,056	0,190	0,155	0,066	●	○	
M.3.1	0,133	0,108	0,056	0,190	0,155	0,066	●	○	
S.1.1									
S.1.2									
S.2.1									
S.2.2									
S.2.3									
S.3.1	0,076	0,054	0,050	0,107	0,076	0,060	●		
S.3.2	0,076	0,054	0,050	0,107	0,076	0,060	●		
S.3.3	0,058	0,041	0,045	0,080	0,057	0,055	●		

Cutting data standard values – CircularLine – End mill – CCR-H

Index	Type long		53 596 ...											● 1st choice ○ suitable			
	v _c (m/min)	max. angle of engagement	Ø DC (mm) =												Emulsion	Compressed air	MMS
			6				8				10						
			a _s 0,02 x DC	a _s 0,05 x DC	a _s 0,10 x DC	h _m	a _s 0,02 x DC	a _s 0,05 x DC	a _s 0,10 x DC	h _m	a _s 0,02 x DC	a _s 0,05 x DC	a _s 0,10 x DC	h _m			
f _z (mm)			f _z (mm)			f _z (mm)			f _z (mm)								
H.1.1	130	30°	0,11	0,07	0,05	0,015	0,13	0,08	0,06	0,019	0,16	0,10	0,07	0,023		●	○
H.1.2	120	30°	0,06	0,04	0,03	0,008	0,07	0,05	0,03	0,010	0,09	0,06	0,04	0,012		●	○
H.1.3	115	30°	0,04	0,03		0,006	0,05	0,03		0,007	0,06	0,04		0,009		●	○
H.1.4	110	30°	0,02			0,003	0,03				0,04			0,006		●	○
H.2.1	130	30°	0,11	0,07	0,05	0,015	0,13	0,08	0,06	0,019	0,16	0,10	0,07	0,023		●	○
H.3.1	130	30°	0,11	0,07	0,05	0,015	0,13	0,08	0,06	0,019	0,16	0,10	0,07	0,023			

Index	Type long		53 596 ...											● 1st choice ○ suitable			
	v _c (m/min)	max. angle of engagement	Ø DC (mm) =												Emulsion	Compressed air	MMS
			12				16				20						
			a _s 0,02 x DC	a _s 0,05 x DC	a _s 0,10 x DC	h _m	a _s 0,02 x DC	a _s 0,05 x DC	a _s 0,10 x DC	h _m	a _s 0,02 x DC	a _s 0,05 x DC	a _s 0,10 x DC	h _m			
f _z (mm)			f _z (mm)			f _z (mm)			f _z (mm)								
H.1.1	130	30°	0,19	0,12	0,08	0,027	0,22	0,14	0,10	0,031	0,24	0,15	0,11	0,034		●	○
H.1.2	120	30°	0,10	0,07	0,05	0,015	0,13	0,08		0,018	0,14	0,09		0,020		●	○
H.1.3	115	30°	0,07	0,05		0,010	0,09	0,06		0,012	0,09	0,06		0,013		●	○
H.1.4	110	30°	0,05			0,006	0,06			0,008	0,08			0,011		●	○
H.2.1	130	30°	0,19	0,12	0,08	0,027	0,22	0,14		0,031	0,24	0,15		0,034		●	○
H.3.1	130	30°	0,19	0,12	0,08	0,027	0,22	0,14	0,10	0,031	0,24	0,15	0,11	0,034		●	○



Depth of cut corresponds to the flute length

Cutting data standard values – SilverLine – NC deburring cutter

Index	50 560 ..., 50 561 ..., 50 562 ..., 50 563 ...							50 564 ..., 50 565 ..., 50 566 ..., 50 567 ...							● 1st choice ○ suitable		
	v _c (m/min)	DPB72S						v _c (m/min)	uncoated						Emulsion	Compressed air	MMS
		Ø DC (mm) =							Ø DC (mm) =								
		4	6	8	10	12	16		4	6	8	10	12	16			
f _z (mm)																	
P.1.1	130	0,03	0,035	0,045	0,06	0,08	0,09	70	0,02	0,025	0,035	0,05	0,07	0,08	●	○	○
P.1.2	130	0,03	0,035	0,045	0,06	0,08	0,09	70	0,02	0,025	0,035	0,05	0,07	0,08	●	○	○
P.1.3	120	0,03	0,035	0,045	0,06	0,08	0,09	65	0,02	0,025	0,035	0,05	0,07	0,08	●	○	○
P.1.4	120	0,03	0,035	0,045	0,06	0,08	0,09	65	0,02	0,025	0,035	0,05	0,07	0,08	●	○	○
P.1.5	90	0,025	0,03	0,04	0,055	0,075	0,085	50	0,015	0,02	0,03	0,045	0,065	0,075	●	○	○
P.2.1	130	0,03	0,035	0,045	0,06	0,08	0,09	70	0,02	0,025	0,035	0,05	0,07	0,08	●	○	○
P.2.2	100	0,03	0,035	0,045	0,06	0,08	0,09	60	0,02	0,025	0,035	0,05	0,07	0,08	●	○	○
P.2.3	90	0,025	0,03	0,04	0,055	0,075	0,085	50	0,015	0,02	0,03	0,045	0,065	0,075	●	○	○
P.2.4	80	0,02	0,02	0,025	0,03	0,04	0,05	45	0,01	0,015	0,015	0,02	0,03	0,04	●	○	○
P.3.1	120	0,03	0,035	0,04	0,055	0,075	0,085	65	0,02	0,025	0,03	0,045	0,065	0,075	●	○	○
P.3.2	70	0,02	0,02	0,025	0,03	0,04	0,05	40	0,01	0,015	0,015	0,02	0,03	0,04	●	○	○
P.3.3	70	0,02	0,02	0,025	0,03	0,04	0,05	40	0,01	0,015	0,015	0,02	0,03	0,04	●	○	○
P.4.1	100	0,03	0,035	0,04	0,055	0,075	0,085	60	0,02	0,025	0,03	0,045	0,065	0,075	●	○	○
P.4.2	95	0,025	0,03	0,04	0,055	0,075	0,085	55	0,015	0,02	0,03	0,045	0,065	0,075	●	○	○
M.1.1	100	0,025	0,03	0,04	0,055	0,075	0,085	65	0,025	0,03	0,04	0,055	0,075	0,085	●		
M.2.1	80	0,02	0,02	0,025	0,03	0,04	0,05	50	0,02	0,02	0,025	0,03	0,04	0,05	●		
M.3.1	100	0,025	0,03	0,04	0,055	0,075	0,085	65	0,025	0,03	0,04	0,055	0,075	0,085	●		
K.1.1	130	0,03	0,035	0,045	0,06	0,08	0,09	85	0,02	0,025	0,035	0,05	0,07	0,08	●	○	○
K.1.2	100	0,03	0,035	0,045	0,06	0,08	0,09	65	0,02	0,025	0,035	0,05	0,07	0,08	●	○	○
K.2.1	130	0,03	0,035	0,045	0,06	0,08	0,09	85	0,02	0,025	0,035	0,05	0,07	0,08	●	○	○
K.2.2	120	0,03	0,035	0,045	0,06	0,08	0,09	80	0,02	0,025	0,035	0,05	0,07	0,08	●	○	○
K.3.1	130	0,03	0,035	0,045	0,06	0,08	0,09	85	0,02	0,025	0,035	0,05	0,07	0,08	●	○	○
K.3.2	120	0,03	0,035	0,045	0,06	0,08	0,09	80	0,02	0,025	0,035	0,05	0,07	0,08	●	○	○
N.1.1																	
N.1.2																	
N.2.1																	
N.2.2																	
N.2.3																	
N.3.1																	
N.3.2																	
N.3.3																	
N.4.1																	
S.1.1	80	0,02	0,02	0,025	0,03	0,04	0,05	50	0,01	0,015	0,025	0,03	0,035	0,04	●		
S.1.2	45	0,012	0,012	0,018	0,02	0,03	0,04	30	0,01	0,015	0,025	0,03	0,035	0,04	●		
S.2.1	50	0,015	0,015	0,02	0,025	0,035	0,045	30	0,01	0,015	0,025	0,03	0,035	0,04	●		
S.2.2	40	0,012	0,012	0,018	0,02	0,03	0,04	30	0,01	0,015	0,025	0,03	0,035	0,04	●		
S.2.3	45	0,012	0,012	0,018	0,02	0,03	0,04	30	0,01	0,015	0,025	0,03	0,035	0,04	●		
S.3.1	60	0,02	0,02	0,025	0,03	0,04	0,05	45	0,01	0,015	0,025	0,03	0,035	0,04	●		
S.3.2	65	0,02	0,02	0,025	0,03	0,04	0,05	45	0,01	0,015	0,025	0,03	0,035	0,04	●		
S.3.3	50	0,015	0,015	0,02	0,025	0,035	0,045	30	0,01	0,015	0,025	0,03	0,035	0,04	●		
H.1.1																	
H.1.2																	
H.1.3																	
H.1.4																	
H.2.1																	
H.3.1																	
O.1.1																	
O.1.2																	
O.2.1																	
O.2.2																	
O.3.1																	

Cutting data standard values – SilverLine – End mill

Index	Type short / long	50 993 ..., 50 994 ..., 50 995 ..., 50 996 ..., 50 997 ..., 50 998 ...																		● 1st choice ○ suitable				
		v _c (m/min)	a _{pm} x DC	Ø DC (mm) =																		Emulsion	Compressed air	MMS
				6			8			10			12			16			20					
				a _s 0,1-0,2 x DC	a _s 0,3-0,4 x DC	a _s 0,6 x DC	a _s 0,1-0,2 x DC	a _s 0,3-0,4 x DC	a _s 0,6 x DC	a _s 0,1-0,2 x DC	a _s 0,3-0,4 x DC	a _s 0,6 x DC	a _s 0,1-0,2 x DC	a _s 0,3-0,4 x DC	a _s 0,6 x DC	a _s 0,1-0,2 x DC	a _s 0,3-0,4 x DC	a _s 0,6 x DC	a _s 0,1-0,2 x DC	a _s 0,3-0,4 x DC	a _s 0,6 x DC			
f _t (mm)																								
P.1.1	205	1,0	0,070	0,056	0,035	0,094	0,075	0,047	0,116	0,093	0,058	0,140	0,112	0,070	0,173	0,138	0,087	0,196	0,157	0,098	●	○	○	
P.1.2	200	1,0	0,070	0,056	0,035	0,094	0,075	0,047	0,116	0,093	0,058	0,140	0,112	0,070	0,173	0,138	0,087	0,196	0,157	0,098	●	○	○	
P.1.3	200	1,0	0,070	0,056	0,035	0,094	0,075	0,047	0,116	0,093	0,058	0,140	0,112	0,070	0,173	0,138	0,087	0,196	0,157	0,098	●	○	○	
P.1.4	190	1,0	0,070	0,056	0,035	0,094	0,075	0,047	0,116	0,093	0,058	0,140	0,112	0,070	0,173	0,138	0,087	0,196	0,157	0,098	●	○	○	
P.1.5	190	1,0	0,070	0,056	0,035	0,094	0,075	0,047	0,116	0,093	0,058	0,140	0,112	0,070	0,173	0,138	0,087	0,196	0,157	0,098	●	○	○	
P.2.1	200	1,0	0,070	0,056	0,035	0,094	0,075	0,047	0,116	0,093	0,058	0,140	0,112	0,070	0,173	0,138	0,087	0,196	0,157	0,098	●	○	○	
P.2.2	190	1,0	0,060	0,048	0,030	0,080	0,064	0,040	0,100	0,080	0,050	0,120	0,096	0,060	0,150	0,120	0,075	0,170	0,136	0,085	●	○	○	
P.2.3	180	1,0	0,070	0,056	0,035	0,094	0,075	0,047	0,116	0,093	0,058	0,140	0,112	0,070	0,173	0,138	0,087	0,196	0,157	0,098	●	○	○	
P.2.4	170	1,0	0,060	0,048	0,030	0,080	0,064	0,040	0,100	0,080	0,050	0,120	0,096	0,060	0,150	0,120	0,075	0,170	0,136	0,085	●	○	○	
P.3.1	180	1,0	0,070	0,056	0,035	0,094	0,075	0,047	0,116	0,093	0,058	0,140	0,112	0,070	0,173	0,138	0,087	0,196	0,157	0,098	●	○	○	
P.3.2	170	1,0	0,070	0,056	0,035	0,094	0,075	0,047	0,116	0,093	0,058	0,140	0,112	0,070	0,173	0,138	0,087	0,196	0,157	0,098	●	○	○	
P.3.3	145	1,0	0,070	0,056	0,035	0,094	0,075	0,047	0,116	0,093	0,058	0,140	0,112	0,070	0,173	0,138	0,087	0,196	0,157	0,098	●	○	○	
P.4.1	100	1,0	0,038	0,030	0,019	0,052	0,042	0,026	0,066	0,053	0,033	0,080	0,064	0,040	0,101	0,081	0,051	0,115	0,092	0,058	●			
P.4.2	80	1,0	0,038	0,030	0,019	0,052	0,042	0,026	0,066	0,053	0,033	0,080	0,064	0,040	0,101	0,081	0,051	0,115	0,092	0,058	●			
M.1.1	100	1,0	0,038	0,030	0,019	0,052	0,042	0,026	0,066	0,053	0,033	0,080	0,064	0,040	0,101	0,081	0,051	0,115	0,092	0,058	●			
M.2.1	100	1,0	0,038	0,030	0,019	0,052	0,042	0,026	0,066	0,053	0,033	0,080	0,064	0,040	0,101	0,081	0,051	0,115	0,092	0,058	●			
M.3.1	100	1,0	0,038	0,030	0,019	0,052	0,042	0,026	0,066	0,053	0,033	0,080	0,064	0,040	0,101	0,081	0,051	0,115	0,092	0,058	●			
K.1.1	200	1,0	0,094	0,075	0,047	0,126	0,101	0,063	0,160	0,128	0,080	0,192	0,154	0,096	0,240	0,192	0,120	0,274	0,219	0,137	●	○	○	
K.1.2	180	1,0	0,094	0,075	0,047	0,126	0,101	0,063	0,160	0,128	0,080	0,192	0,154	0,096	0,240	0,192	0,120	0,274	0,219	0,137	●	○	○	
K.2.1	190	1,0	0,070	0,056	0,035	0,094	0,075	0,047	0,116	0,093	0,058	0,140	0,112	0,070	0,173	0,138	0,087	0,196	0,157	0,098	●	○	○	
K.2.2	170	1,0	0,070	0,056	0,035	0,094	0,075	0,047	0,116	0,093	0,058	0,140	0,112	0,070	0,173	0,138	0,087	0,196	0,157	0,098	●	○	○	
K.3.1	180	1,0	0,070	0,056	0,035	0,094	0,075	0,047	0,116	0,093	0,058	0,140	0,112	0,070	0,173	0,138	0,087	0,196	0,157	0,098	●	○	○	
K.3.2	160	1,0	0,070	0,056	0,035	0,094	0,075	0,047	0,116	0,093	0,058	0,140	0,112	0,070	0,173	0,138	0,087	0,196	0,157	0,098	●	○	○	
N.1.1																								
N.1.2																								
N.2.1																								
N.2.2																								
N.2.3																								
N.3.1	315	1,0	0,094	0,075	0,047	0,126	0,101	0,063	0,160	0,128	0,080	0,192	0,154	0,096	0,240	0,192	0,120	0,274	0,219	0,137	●	○	○	
N.3.2	315	1,0	0,094	0,075	0,047	0,126	0,101	0,063	0,160	0,128	0,080	0,192	0,154	0,096	0,240	0,192	0,120	0,274	0,219	0,137	●	○	○	
N.3.3	250	1,0	0,094	0,075	0,047	0,126	0,101	0,063	0,160	0,128	0,080	0,192	0,154	0,096	0,240	0,192	0,120	0,274	0,219	0,137	●	○	○	
N.4.1																								
S.1.1	25	1,0	0,030	0,024	0,015	0,040	0,032	0,020	0,050	0,040	0,025	0,060	0,048	0,030	0,075	0,060	0,038	0,084	0,067	0,042	●			
S.1.2	25	1,0	0,030	0,024	0,015	0,040	0,032	0,020	0,050	0,040	0,025	0,060	0,048	0,030	0,075	0,060	0,038	0,084	0,067	0,042	●			
S.2.1	25	1,0	0,030	0,024	0,015	0,040	0,032	0,020	0,050	0,040	0,025	0,060	0,048	0,030	0,075	0,060	0,038	0,084	0,067	0,042	●			
S.2.2	25	1,0	0,030	0,024	0,015	0,040	0,032	0,020	0,050	0,040	0,025	0,060	0,048	0,030	0,075	0,060	0,038	0,084	0,067	0,042	●			
S.2.3	25	1,0	0,030	0,024	0,015	0,040	0,032	0,020	0,050	0,040	0,025	0,060	0,048	0,030	0,075	0,060	0,038	0,084	0,067	0,042	●			
S.3.1	80	1,0	0,060	0,048	0,030	0,080	0,064	0,040	0,100	0,080	0,050	0,120	0,096	0,060	0,150	0,120	0,075	0,170	0,136	0,085	●			
S.3.2																								
S.3.3																								
H.1.1																								
H.1.2																								
H.1.3																								
H.1.4																								
H.2.1																								
H.3.1																								
O.1.1																								
O.1.2																								
O.2.1																								
O.2.2																								
O.3.1																								

 Plunging angle for ramping and helical milling = 2-3°

Cutting data standard values – SilverLine – End mill

Index	Type long		50 949 ..., 50 999 ...																		● 1st choice ○ suitable		
	v _c (m/min)	a _{p,max} x DC	Ø DC (mm) =																		Emulsion	Compressed air	MMS
			6			8			10			12			16			20					
			a _s 0,1–0,2 x DC	a _s 0,3–0,4 x DC	a _s 0,6 x DC	a _s 0,1–0,2 x DC	a _s 0,3–0,4 x DC	a _s 0,6 x DC	a _s 0,1–0,2 x DC	a _s 0,3–0,4 x DC	a _s 0,6 x DC	a _s 0,1–0,2 x DC	a _s 0,3–0,4 x DC	a _s 0,6 x DC	a _s 0,1–0,2 x DC	a _s 0,3–0,4 x DC	a _s 0,6 x DC	a _s 0,1–0,2 x DC	a _s 0,3–0,4 x DC	a _s 0,6 x DC			
f _z (mm)																							
P.1.1	165	1,0	0,070	0,056	0,035	0,094	0,075	0,047	0,116	0,093	0,058	0,140	0,112	0,070	0,173	0,138	0,087	0,196	0,157	0,098	●	○	○
P.1.2	160	1,0	0,070	0,056	0,035	0,094	0,075	0,047	0,116	0,093	0,058	0,140	0,112	0,070	0,173	0,138	0,087	0,196	0,157	0,098	●	○	○
P.1.3	160	1,0	0,070	0,056	0,035	0,094	0,075	0,047	0,116	0,093	0,058	0,140	0,112	0,070	0,173	0,138	0,087	0,196	0,157	0,098	●	○	○
P.1.4	150	1,0	0,070	0,056	0,035	0,094	0,075	0,047	0,116	0,093	0,058	0,140	0,112	0,070	0,173	0,138	0,087	0,196	0,157	0,098	●	○	○
P.1.5	150	1,0	0,070	0,056	0,035	0,094	0,075	0,047	0,116	0,093	0,058	0,140	0,112	0,070	0,173	0,138	0,087	0,196	0,157	0,098	●	○	○
P.2.1	160	1,0	0,070	0,056	0,035	0,094	0,075	0,047	0,116	0,093	0,058	0,140	0,112	0,070	0,173	0,138	0,087	0,196	0,157	0,098	●	○	○
P.2.2	150	1,0	0,060	0,048	0,030	0,080	0,064	0,040	0,100	0,080	0,050	0,120	0,096	0,060	0,150	0,120	0,075	0,170	0,136	0,085	●	○	○
P.2.3	145	1,0	0,070	0,056	0,035	0,094	0,075	0,047	0,116	0,093	0,058	0,140	0,112	0,070	0,173	0,138	0,087	0,196	0,157	0,098	●	○	○
P.2.4	135	1,0	0,060	0,048	0,030	0,080	0,064	0,040	0,100	0,080	0,050	0,120	0,096	0,060	0,150	0,120	0,075	0,170	0,136	0,085	●	○	○
P.3.1	145	1,0	0,070	0,056	0,035	0,094	0,075	0,047	0,116	0,093	0,058	0,140	0,112	0,070	0,173	0,138	0,087	0,196	0,157	0,098	●	○	○
P.3.2	135	1,0	0,070	0,056	0,035	0,094	0,075	0,047	0,116	0,093	0,058	0,140	0,112	0,070	0,173	0,138	0,087	0,196	0,157	0,098	●	○	○
P.3.3	115	1,0	0,070	0,056	0,035	0,094	0,075	0,047	0,116	0,093	0,058	0,140	0,112	0,070	0,173	0,138	0,087	0,196	0,157	0,098	●	○	○
P.4.1	80	1,0	0,038	0,030	0,019	0,052	0,042	0,026	0,066	0,053	0,033	0,080	0,064	0,040	0,101	0,081	0,051	0,115	0,092	0,058	●		
P.4.2	65	1,0	0,038	0,030	0,019	0,052	0,042	0,026	0,066	0,053	0,033	0,080	0,064	0,040	0,101	0,081	0,051	0,115	0,092	0,058	●		
M.1.1	80	1,0	0,038	0,030	0,019	0,052	0,042	0,026	0,066	0,053	0,033	0,080	0,064	0,040	0,101	0,081	0,051	0,115	0,092	0,058	●		
M.2.1	80	1,0	0,038	0,030	0,019	0,052	0,042	0,026	0,066	0,053	0,033	0,080	0,064	0,040	0,101	0,081	0,051	0,115	0,092	0,058	●		
M.3.1	80	1,0	0,038	0,030	0,019	0,052	0,042	0,026	0,066	0,053	0,033	0,080	0,064	0,040	0,101	0,081	0,051	0,115	0,092	0,058	●		
K.1.1	160	1,0	0,094	0,075	0,047	0,126	0,101	0,063	0,160	0,128	0,080	0,192	0,154	0,096	0,240	0,192	0,120	0,274	0,219	0,137	●	○	○
K.1.2	145	1,0	0,094	0,075	0,047	0,126	0,101	0,063	0,160	0,128	0,080	0,192	0,154	0,096	0,240	0,192	0,120	0,274	0,219	0,137	●	○	○
K.2.1	150	1,0	0,070	0,056	0,035	0,094	0,075	0,047	0,116	0,093	0,058	0,140	0,112	0,070	0,173	0,138	0,087	0,196	0,157	0,098	●	○	○
K.2.2	135	1,0	0,070	0,056	0,035	0,094	0,075	0,047	0,116	0,093	0,058	0,140	0,112	0,070	0,173	0,138	0,087	0,196	0,157	0,098	●	○	○
K.3.1	145	1,0	0,070	0,056	0,035	0,094	0,075	0,047	0,116	0,093	0,058	0,140	0,112	0,070	0,173	0,138	0,087	0,196	0,157	0,098	●	○	○
K.3.2	130	1,0	0,070	0,056	0,035	0,094	0,075	0,047	0,116	0,093	0,058	0,140	0,112	0,070	0,173	0,138	0,087	0,196	0,157	0,098	●	○	○
N.1.1																							
N.1.2																							
N.2.1																							
N.2.2																							
N.2.3																							
N.3.1	250	1,0	0,094	0,075	0,047	0,126	0,101	0,063	0,160	0,128	0,080	0,192	0,154	0,096	0,240	0,192	0,120	0,274	0,219	0,137	●	○	○
N.3.2	250	1,0	0,094	0,075	0,047	0,126	0,101	0,063	0,160	0,128	0,080	0,192	0,154	0,096	0,240	0,192	0,120	0,274	0,219	0,137	●	○	○
N.3.3	200	1,0	0,094	0,075	0,047	0,126	0,101	0,063	0,160	0,128	0,080	0,192	0,154	0,096	0,240	0,192	0,120	0,274	0,219	0,137	●	○	○
N.4.1																							
S.1.1	20	1,0	0,030	0,024	0,015	0,040	0,032	0,020	0,050	0,040	0,025	0,060	0,048	0,030	0,075	0,060	0,038	0,084	0,067	0,042	●		
S.1.2	20	1,0	0,030	0,024	0,015	0,040	0,032	0,020	0,050	0,040	0,025	0,060	0,048	0,030	0,075	0,060	0,038	0,084	0,067	0,042	●		
S.2.1	20	1,0	0,030	0,024	0,015	0,040	0,032	0,020	0,050	0,040	0,025	0,060	0,048	0,030	0,075	0,060	0,038	0,084	0,067	0,042	●		
S.2.2	20	1,0	0,030	0,024	0,015	0,040	0,032	0,020	0,050	0,040	0,025	0,060	0,048	0,030	0,075	0,060	0,038	0,084	0,067	0,042	●		
S.2.3	20	1,0	0,030	0,024	0,015	0,040	0,032	0,020	0,050	0,040	0,025	0,060	0,048	0,030	0,075	0,060	0,038	0,084	0,067	0,042	●		
S.3.1	65	1,0	0,060	0,048	0,030	0,080	0,064	0,040	0,100	0,080	0,050	0,120	0,096	0,060	0,150	0,120	0,075	0,170	0,136	0,085	●		
S.3.2																							
S.3.3																							
H.1.1																							
H.1.2																							
H.1.3																							
H.1.4																							
H.2.1																							
H.3.1																							
O.1.1																							
O.1.2																							
O.2.1																							
O.2.2																							
O.3.1																							

Cutting data standard values – SilverLine – End mills – Trochoidal machining

Index	Type long		50 949 ..., 50 999 ...															
	v _c (m/min)	max. angle of engagement	Ø DC (mm) =															
			6				8				10				12			
			a _{se} 0,05 x DC	a _{se} 0,1 x DC	a _{se} 0,15 x DC	h _m	a _{se} 0,05 x DC	a _{se} 0,1 x DC	a _{se} 0,15 x DC	h _m	a _{se} 0,05 x DC	a _{se} 0,1 x DC	a _{se} 0,15 x DC	h _m	a _{se} 0,05 x DC	a _{se} 0,1 x DC	a _{se} 0,15 x DC	h _m
f _z (mm)				f _z (mm)				f _z (mm)				f _z (mm)						
P.1.1	280	50°	0,15	0,10	0,09	0,033	0,17	0,12	0,10	0,039	0,20	0,14	0,12	0,045	0,23	0,16	0,13	0,051
P.1.2	280	50°	0,11	0,08	0,07	0,025	0,14	0,10	0,08	0,032	0,17	0,12	0,10	0,039	0,20	0,14	0,12	0,045
P.1.3	280	50°	0,11	0,08	0,07	0,025	0,14	0,10	0,08	0,032	0,17	0,12	0,10	0,039	0,20	0,14	0,12	0,045
P.1.4	260	50°	0,11	0,08	0,07	0,025	0,14	0,10	0,08	0,032	0,17	0,12	0,10	0,039	0,20	0,14	0,12	0,045
P.1.5	260	50°	0,11	0,08	0,07	0,025	0,14	0,10	0,08	0,032	0,17	0,12	0,10	0,039	0,20	0,14	0,12	0,045
P.2.1	280	50°	0,15	0,10	0,09	0,033	0,17	0,12	0,10	0,039	0,20	0,14	0,12	0,045	0,23	0,16	0,13	0,051
P.2.2	280	50°	0,15	0,10	0,09	0,033	0,17	0,12	0,10	0,039	0,20	0,14	0,12	0,045	0,23	0,16	0,13	0,051
P.2.3	260	50°	0,11	0,08	0,07	0,025	0,14	0,10	0,08	0,032	0,17	0,12	0,10	0,039	0,20	0,14	0,12	0,045
P.2.4	260	50°	0,11	0,08	0,07	0,025	0,14	0,10	0,08	0,032	0,17	0,12	0,10	0,039	0,20	0,14	0,12	0,045
P.3.1	220	50°	0,11	0,08	0,07	0,025	0,14	0,10	0,08	0,032	0,17	0,12	0,10	0,039	0,20	0,14	0,12	0,045
P.3.2	220	45°	0,11	0,08	0,07	0,025	0,14	0,10	0,08	0,032	0,17	0,12	0,10	0,039	0,20	0,14	0,12	0,045
P.3.3	200	45°	0,11	0,08	0,07	0,025	0,14	0,10	0,08	0,032	0,17	0,12	0,10	0,039	0,20	0,14	0,12	0,045
P.4.1	180	45°	0,09	0,07	0,05	0,021	0,11	0,08	0,07	0,026	0,14	0,10	0,08	0,031	0,16	0,11	0,09	0,035
P.4.2	160	45°	0,09	0,07	0,05	0,021	0,11	0,08	0,07	0,026	0,14	0,10	0,08	0,031	0,16	0,11	0,09	0,035
M.1.1	140	45°	0,09	0,07	0,05	0,021	0,11	0,08	0,07	0,026	0,14	0,10	0,08	0,031	0,16	0,11	0,09	0,035
M.2.1	140	45°	0,09	0,07	0,05	0,021	0,11	0,08	0,07	0,026	0,14	0,10	0,08	0,031	0,16	0,11	0,09	0,035
M.3.1	140	45°	0,09	0,07	0,05	0,021	0,11	0,08	0,07	0,026	0,14	0,10	0,08	0,031	0,16	0,11	0,09	0,035
K.1.1	300	50°	0,15	0,10	0,09	0,033	0,17	0,12	0,10	0,039	0,20	0,14	0,12	0,045	0,23	0,16	0,13	0,051
K.1.2	300	50°	0,15	0,10	0,09	0,033	0,17	0,12	0,10	0,039	0,20	0,14	0,12	0,045	0,23	0,16	0,13	0,051
K.2.1	300	50°	0,15	0,10	0,09	0,033	0,17	0,12	0,10	0,039	0,20	0,14	0,12	0,045	0,23	0,16	0,13	0,051
K.2.2	260	50°	0,11	0,08	0,07	0,025	0,14	0,10	0,08	0,032	0,17	0,12	0,10	0,039	0,20	0,14	0,12	0,045
K.3.1	260	50°	0,11	0,08	0,07	0,025	0,14	0,10	0,08	0,032	0,17	0,12	0,10	0,039	0,20	0,14	0,12	0,045
K.3.2	200	50°	0,11	0,08	0,07	0,025	0,14	0,10	0,08	0,032	0,17	0,12	0,10	0,039	0,20	0,14	0,12	0,045
N.1.1																		
N.1.2																		
N.2.1																		
N.2.2																		
N.2.3																		
N.3.1																		
N.3.2																		
N.3.3																		
N.4.1																		
S.1.1	80	40°	0,05	0,03	0,03	0,010	0,06	0,04	0,04	0,014	0,08	0,05	0,04	0,017	0,09	0,06	0,05	0,021
S.1.2	80	40°	0,05	0,03	0,03	0,010	0,06	0,04	0,04	0,014	0,08	0,05	0,04	0,017	0,09	0,06	0,05	0,021
S.2.1	60	40°	0,05	0,03	0,03	0,010	0,06	0,04	0,04	0,014	0,08	0,05	0,04	0,017	0,09	0,06	0,05	0,021
S.2.2	60	40°	0,05	0,03	0,03	0,010	0,06	0,04	0,04	0,014	0,08	0,05	0,04	0,017	0,09	0,06	0,05	0,021
S.2.3																		
S.3.1	140	40°	0,06	0,04	0,04	0,014	0,08	0,06	0,05	0,018	0,10	0,07	0,06	0,023	0,12	0,09	0,07	0,028
S.3.2	100	40°	0,06	0,04	0,04	0,014	0,08	0,06	0,05	0,018	0,10	0,07	0,06	0,023	0,12	0,09	0,07	0,028
S.3.3																		
H.1.1																		
H.1.2																		
H.1.3																		
H.1.4																		
H.2.1																		
H.3.1																		
O.1.1																		
O.1.2																		
O.2.1																		
O.2.2																		
O.3.1																		

 Plunging angle for ramping and helical milling = 2-3°

 Cutting depth corresponding to the cutting length

Index	50 949 ..., 50 999 ...								● 1st choice ○ suitable		
	Ø DC (mm) =								Emulsion	Compressed air	MMS
	16				20						
	a_s 0,05 x DC	a_s 0,1 x DC	a_s 0,15 x DC	h_m	a_s 0,05 x DC	a_s 0,1 x DC	a_s 0,15 x DC	h_m			
f_z (mm)				f_z (mm)							
P.1.1	0,27	0,19	0,16	0,060	0,30	0,21	0,17	0,066	○	●	○
P.1.2	0,25	0,18	0,14	0,055	0,28	0,20	0,16	0,062	○	●	○
P.1.3	0,25	0,18	0,14	0,055	0,28	0,20	0,16	0,062	○	●	○
P.1.4	0,25	0,18	0,14	0,055	0,28	0,20	0,16	0,062	○	●	○
P.1.5	0,25	0,18	0,14	0,055	0,28	0,20	0,16	0,062	○	●	○
P.2.1	0,27	0,19	0,16	0,060	0,30	0,21	0,17	0,066	○	●	○
P.2.2	0,27	0,19	0,16	0,060	0,30	0,21	0,17	0,066	○	●	○
P.2.3	0,25	0,18	0,14	0,055	0,28	0,20	0,16	0,062	○	●	○
P.2.4	0,25	0,18	0,14	0,055	0,28	0,20	0,16	0,062	○	●	○
P.3.1	0,25	0,18	0,14	0,055	0,28	0,20	0,16	0,062	○	●	○
P.3.2	0,25	0,18	0,14	0,055	0,28	0,20	0,16	0,062	○	●	○
P.3.3	0,25	0,18	0,14	0,055	0,28	0,20	0,16	0,062	○	●	○
P.4.1	0,19	0,13	0,11	0,042	0,21	0,15	0,12	0,047	●		
P.4.2	0,19	0,13	0,11	0,042	0,21	0,15	0,12	0,047	●		
M.1.1	0,19	0,13	0,11	0,042	0,21	0,15	0,12	0,047	●		
M.2.1	0,19	0,13	0,11	0,042	0,21	0,15	0,12	0,047	●		
M.3.1	0,19	0,13	0,11	0,042	0,21	0,15	0,12	0,047	●		
K.1.1	0,27	0,19	0,16	0,060	0,30	0,21	0,17	0,066	○	●	○
K.1.2	0,27	0,19	0,16	0,060	0,30	0,21	0,17	0,066	○	●	○
K.2.1	0,27	0,19	0,16	0,060	0,30	0,21	0,17	0,066	○	●	○
K.2.2	0,25	0,18	0,14	0,055	0,28	0,20	0,16	0,062	○	●	○
K.3.1	0,25	0,18	0,14	0,055	0,28	0,20	0,16	0,062	○	●	○
K.3.2	0,25	0,18	0,14	0,055	0,28	0,20	0,16	0,062	○	●	○
N.1.1											
N.1.2											
N.2.1											
N.2.2											
N.2.3											
N.3.1											
N.3.2											
N.3.3											
N.4.1											
S.1.1	0,11	0,08	0,07	0,026	0,13	0,09	0,08	0,029	●		
S.1.2	0,11	0,08	0,07	0,026	0,13	0,09	0,08	0,029	●		
S.2.1	0,11	0,08	0,07	0,026	0,13	0,09	0,08	0,029	●		
S.2.2	0,11	0,08	0,07	0,026	0,13	0,09	0,08	0,029	●		
S.2.3											
S.3.1	0,16	0,11	0,09	0,035	0,18	0,12	0,10	0,040	●		
S.3.2	0,16	0,11	0,09	0,035	0,18	0,12	0,10	0,040	●		
S.3.3											
H.1.1											
H.1.2											
H.1.3											
H.1.4											
H.2.1											
H.3.1											
O.1.1											
O.1.2											
O.2.1											
O.2.2											
O.3.1											

Cutting data standard values – SilverLine – End mill

Index	Type long v _c (m/min) a _{p,max.} x DC		50 558 ..., 50 958																	
			Ø DC (mm) =																	
			3,0			3,5–4,0			4,5–5,0			5,5–6,0			7,0–8,0			9,0–10,0		
			a _e 0,1–0,2 x DC	a _e 0,3–0,4 x DC	a _e 0,6–1,0 x DC	a _e 0,1–0,2 x DC	a _e 0,3–0,4 x DC	a _e 0,6–1,0 x DC	a _e 0,1–0,2 x DC	a _e 0,3–0,4 x DC	a _e 0,6–1,0 x DC	a _e 0,1–0,2 x DC	a _e 0,3–0,4 x DC	a _e 0,6–1,0 x DC	a _e 0,1–0,2 x DC	a _e 0,3–0,4 x DC	a _e 0,6–1,0 x DC	a _e 0,1–0,2 x DC	a _e 0,3–0,4 x DC	a _e 0,6–1,0 x DC
f _z (mm)																				
P.1.1	110	1,0*	0,035	0,028	0,018	0,042	0,034	0,021	0,050	0,040	0,025	0,058	0,046	0,029	0,072	0,058	0,036	0,086	0,069	0,043
P.1.2	90	1,0*	0,027	0,022	0,014	0,034	0,027	0,017	0,041	0,033	0,021	0,048	0,038	0,024	0,062	0,050	0,031	0,075	0,060	0,038
P.1.3	90	1,0*	0,027	0,022	0,014	0,034	0,027	0,017	0,041	0,033	0,021	0,048	0,038	0,024	0,062	0,050	0,031	0,075	0,060	0,038
P.1.4	80	1,0*	0,027	0,022	0,014	0,034	0,027	0,017	0,041	0,033	0,021	0,048	0,038	0,024	0,062	0,050	0,031	0,075	0,060	0,038
P.1.5	80	1,0*	0,027	0,022	0,014	0,034	0,027	0,017	0,041	0,033	0,021	0,048	0,038	0,024	0,062	0,050	0,031	0,075	0,060	0,038
P.2.1	90	1,0*	0,027	0,022	0,014	0,034	0,027	0,017	0,041	0,033	0,021	0,048	0,038	0,024	0,062	0,050	0,031	0,075	0,060	0,038
P.2.2	70	1,0*	0,027	0,022	0,014	0,034	0,027	0,017	0,041	0,033	0,021	0,048	0,038	0,024	0,062	0,050	0,031	0,075	0,060	0,038
P.2.3	70	1,0*	0,027	0,022	0,014	0,034	0,027	0,017	0,041	0,033	0,021	0,048	0,038	0,024	0,062	0,050	0,031	0,075	0,060	0,038
P.2.4	55	1,0*	0,027	0,022	0,014	0,034	0,027	0,017	0,041	0,033	0,021	0,048	0,038	0,024	0,062	0,050	0,031	0,075	0,060	0,038
P.3.1																				
P.3.2																				
P.3.3																				
P.4.1	50	1,0*	0,022	0,018	0,011	0,028	0,022	0,014	0,034	0,027	0,017	0,041	0,033	0,021	0,054	0,043	0,027	0,066	0,053	0,033
P.4.2	40	1,0*	0,022	0,018	0,011	0,028	0,022	0,014	0,034	0,027	0,017	0,041	0,033	0,021	0,054	0,043	0,027	0,066	0,053	0,033
M.1.1	40	1,0*	0,022	0,018	0,011	0,028	0,022	0,014	0,034	0,027	0,017	0,041	0,033	0,021	0,054	0,043	0,027	0,066	0,053	0,033
M.2.1	50	1,0*	0,022	0,018	0,011	0,028	0,022	0,014	0,034	0,027	0,017	0,041	0,033	0,021	0,054	0,043	0,027	0,066	0,053	0,033
M.3.1	50	1,0*	0,022	0,018	0,011	0,028	0,022	0,014	0,034	0,027	0,017	0,041	0,033	0,021	0,054	0,043	0,027	0,066	0,053	0,033
K.1.1	130	1,0*	0,056	0,045	0,028	0,068	0,054	0,034	0,080	0,064	0,040	0,092	0,074	0,046	0,116	0,093	0,058	0,140	0,112	0,070
K.1.2	120	1,0*	0,056	0,045	0,028	0,068	0,054	0,034	0,080	0,064	0,040	0,092	0,074	0,046	0,116	0,093	0,058	0,140	0,112	0,070
K.2.1	130	1,0*	0,040	0,032	0,020	0,048	0,038	0,024	0,056	0,045	0,028	0,064	0,051	0,032	0,079	0,063	0,040	0,095	0,076	0,048
K.2.2	120	1,0*	0,040	0,032	0,020	0,048	0,038	0,024	0,056	0,045	0,028	0,064	0,051	0,032	0,079	0,063	0,040	0,095	0,076	0,048
K.3.1	130	1,0*	0,056	0,045	0,028	0,068	0,054	0,034	0,080	0,064	0,040	0,092	0,074	0,046	0,116	0,093	0,058	0,140	0,112	0,070
K.3.2	120	1,0*	0,056	0,045	0,028	0,068	0,054	0,034	0,080	0,064	0,040	0,092	0,074	0,046	0,116	0,093	0,058	0,140	0,112	0,070
N.1.1																				
N.1.2																				
N.2.1																				
N.2.2																				
N.2.3																				
N.3.1	200	1,0*	0,040	0,032	0,020	0,050	0,040	0,025	0,060	0,048	0,030	0,070	0,056	0,035	0,090	0,072	0,045	0,110	0,088	0,055
N.3.2	200	1,0*	0,040	0,032	0,020	0,050	0,040	0,025	0,060	0,048	0,030	0,070	0,056	0,035	0,090	0,072	0,045	0,110	0,088	0,055
N.3.3	140	1,0*	0,040	0,032	0,020	0,050	0,040	0,025	0,060	0,048	0,030	0,070	0,056	0,035	0,090	0,072	0,045	0,110	0,088	0,055
N.4.1																				
S.1.1	30	1,0*	0,015	0,012	0,008	0,020	0,016	0,010	0,025	0,020	0,013	0,030	0,024	0,015	0,040	0,032	0,020	0,050	0,040	0,025
S.1.2	30	1,0*	0,015	0,012	0,008	0,020	0,016	0,010	0,025	0,020	0,013	0,030	0,024	0,015	0,040	0,032	0,020	0,050	0,040	0,025
S.2.1	30	1,0*	0,015	0,012	0,008	0,020	0,016	0,010	0,025	0,020	0,013	0,030	0,024	0,015	0,040	0,032	0,020	0,050	0,040	0,025
S.2.2	30	1,0*	0,015	0,012	0,008	0,020	0,016	0,010	0,025	0,020	0,013	0,030	0,024	0,015	0,040	0,032	0,020	0,050	0,040	0,025
S.2.3	30	1,0*	0,015	0,012	0,008	0,020	0,016	0,010	0,025	0,020	0,013	0,030	0,024	0,015	0,040	0,032	0,020	0,050	0,040	0,025
S.3.1	50	1,0*	0,022	0,018	0,011	0,028	0,022	0,014	0,034	0,027	0,017	0,041	0,033	0,021	0,054	0,043	0,027	0,066	0,053	0,033
S.3.2	20	1,0*	0,022	0,018	0,011	0,028	0,022	0,014	0,034	0,027	0,017	0,041	0,033	0,021	0,054	0,043	0,027	0,066	0,053	0,033
S.3.3																				
H.1.1																				
H.1.2																				
H.1.3																				
H.1.4																				
H.2.1																				
H.3.1																				
O.1.1																				
O.1.2																				
O.2.1																				
O.2.2																				
O.3.1																				

* = long version: a_{p,max.} = 1.5 x DC at f_z x 0.75



Plunging angle for ramping and helical milling = 6-10°

Index	50 558 ..., 50 958															● 1st choice		
	Ø DC (mm) =															○ suitable		
	11,0–12,0			14,0			15,0–16,0			17,0–18,0			19,0–20,0			Emulsion	Compressed air	MMS
	a _e 0,1–0,2 x DC	a _e 0,3–0,4 x DC	a _e 0,6–1,0 x DC	a _e 0,1–0,2 x DC	a _e 0,3–0,4 x DC	a _e 0,6–1,0 x DC	a _e 0,1–0,2 x DC	a _e 0,3–0,4 x DC	a _e 0,6–1,0 x DC	a _e 0,1–0,2 x DC	a _e 0,3–0,4 x DC	a _e 0,6–1,0 x DC	a _e 0,1–0,2 x DC	a _e 0,3–0,4 x DC	a _e 0,6–1,0 x DC			
	f _z (mm)																	
P.1.1	0,102	0,082	0,051	0,116	0,093	0,058	0,124	0,099	0,062	0,131	0,105	0,066	0,139	0,111	0,070	●	○	○
P.1.2	0,089	0,071	0,045	0,103	0,082	0,052	0,110	0,088	0,055	0,117	0,094	0,059	0,123	0,098	0,062	●	○	○
P.1.3	0,089	0,071	0,045	0,103	0,082	0,052	0,110	0,088	0,055	0,117	0,094	0,059	0,123	0,098	0,062	●	○	○
P.1.4	0,089	0,071	0,045	0,103	0,082	0,052	0,110	0,088	0,055	0,117	0,094	0,059	0,123	0,098	0,062	●	○	○
P.1.5	0,089	0,071	0,045	0,103	0,082	0,052	0,110	0,088	0,055	0,117	0,094	0,059	0,123	0,098	0,062	●	○	○
P.2.1	0,089	0,071	0,045	0,103	0,082	0,052	0,110	0,088	0,055	0,117	0,094	0,059	0,123	0,098	0,062	●	○	○
P.2.2	0,089	0,071	0,045	0,103	0,082	0,052	0,110	0,088	0,055	0,117	0,094	0,059	0,123	0,098	0,062	●	○	○
P.2.3	0,089	0,071	0,045	0,103	0,082	0,052	0,110	0,088	0,055	0,117	0,094	0,059	0,123	0,098	0,062	●	○	○
P.2.4	0,089	0,071	0,045	0,103	0,082	0,052	0,110	0,088	0,055	0,117	0,094	0,059	0,123	0,098	0,062	●	○	○
P.3.1																		
P.3.2																		
P.3.3																		
P.4.1	0,079	0,063	0,040	0,092	0,074	0,046	0,099	0,079	0,050	0,105	0,084	0,053	0,111	0,089	0,056	●		
P.4.2	0,079	0,063	0,040	0,092	0,074	0,046	0,099	0,079	0,050	0,105	0,084	0,053	0,111	0,089	0,056	●		
M.1.1	0,079	0,063	0,040	0,092	0,074	0,046	0,099	0,079	0,050	0,105	0,084	0,053	0,111	0,089	0,056	●		
M.2.1	0,079	0,063	0,040	0,092	0,074	0,046	0,099	0,079	0,050	0,105	0,084	0,053	0,111	0,089	0,056	●		
M.3.1	0,079	0,063	0,040	0,092	0,074	0,046	0,099	0,079	0,050	0,105	0,084	0,053	0,111	0,089	0,056	●		
K.1.1	0,164	0,131	0,082	0,188	0,150	0,094	0,200	0,160	0,100	0,212	0,170	0,106	0,224	0,179	0,112	●	○	○
K.1.2	0,164	0,131	0,082	0,188	0,150	0,094	0,200	0,160	0,100	0,212	0,170	0,106	0,224	0,179	0,112	●	○	○
K.2.1	0,110	0,088	0,055	0,126	0,101	0,063	0,134	0,107	0,067	0,142	0,114	0,071	0,150	0,120	0,075	●	○	○
K.2.2	0,110	0,088	0,055	0,126	0,101	0,063	0,134	0,107	0,067	0,142	0,114	0,071	0,150	0,120	0,075	●	○	○
K.3.1	0,164	0,131	0,082	0,188	0,150	0,094	0,200	0,160	0,100	0,212	0,170	0,106	0,224	0,179	0,112	●	○	○
K.3.2	0,164	0,131	0,082	0,188	0,150	0,094	0,200	0,160	0,100	0,212	0,170	0,106	0,224	0,179	0,112	●	○	○
N.1.1																		
N.1.2																		
N.2.1																		
N.2.2																		
N.2.3																		
N.3.1	0,130	0,104	0,065	0,150	0,120	0,075	0,160	0,128	0,080	0,170	0,136	0,085	0,180	0,144	0,090	●		
N.3.2	0,130	0,104	0,065	0,150	0,120	0,075	0,160	0,128	0,080	0,170	0,136	0,085	0,180	0,144	0,090	●		
N.3.3	0,130	0,104	0,065	0,150	0,120	0,075	0,160	0,128	0,080	0,170	0,136	0,085	0,180	0,144	0,090	●		
N.4.1																		
S.1.1	0,060	0,048	0,030	0,070	0,056	0,035	0,075	0,060	0,038	0,079	0,063	0,040	0,084	0,067	0,042	●		
S.1.2	0,060	0,048	0,030	0,070	0,056	0,035	0,075	0,060	0,038	0,079	0,063	0,040	0,084	0,067	0,042	●		
S.2.1	0,060	0,048	0,030	0,070	0,056	0,035	0,075	0,060	0,038	0,079	0,063	0,040	0,084	0,067	0,042	●		
S.2.2	0,060	0,048	0,030	0,070	0,056	0,035	0,075	0,060	0,038	0,079	0,063	0,040	0,084	0,067	0,042	●		
S.2.3	0,060	0,048	0,030	0,070	0,056	0,035	0,075	0,060	0,038	0,079	0,063	0,040	0,084	0,067	0,042	●		
S.3.1	0,079	0,063	0,040	0,092	0,074	0,046	0,099	0,079	0,050	0,105	0,084	0,053	0,111	0,089	0,056	●		
S.3.2	0,079	0,063	0,040	0,092	0,074	0,046	0,099	0,079	0,050	0,105	0,084	0,053	0,111	0,089	0,056	●		
S.3.3																		
H.1.1																		
H.1.2																		
H.1.3																		
H.1.4																		
H.2.1																		
H.3.1																		
O.1.1																		
O.1.2																		
O.2.1																		
O.2.2																		
O.3.1																		

Cutting data standard values – SilverLine – End mill

Index	Type short		Type long		Type extra long		50 966 ..., 50 967 ..., 50 992 ...														
	v _c (m/min)	a _{p,max} x DC	v _c (m/min)	a _{p,max} x DC	v _c (m/min)	a _{p,max} x DC	Ø DC (mm) =														
							3,0			3,5–4,0			4,5–5,0			5,5–6,0			6,5–8,0		
							a _e 0,1–0,2 x DC	a _e 0,3–0,4 x DC	a _e 0,6–1,0 x DC	a _e 0,1–0,2 x DC	a _e 0,3–0,4 x DC	a _e 0,6–1,0 x DC	a _e 0,1–0,2 x DC	a _e 0,3–0,4 x DC	a _e 0,6–1,0 x DC	a _e 0,1–0,2 x DC	a _e 0,3–0,4 x DC	a _e 0,6–1,0 x DC	a _e 0,1–0,2 x DC	a _e 0,3–0,4 x DC	a _e 0,6–1,0 x DC
f _z (mm)																					
P.1.1	252	1,0	210	1,0*	105	0,8	0,028	0,022	0,014	0,038	0,030	0,019	0,049	0,039	0,025	0,060	0,048	0,030	0,080	0,064	0,040
P.1.2	240	1,0	200	1,0*	100	0,8	0,028	0,022	0,014	0,038	0,030	0,019	0,049	0,039	0,025	0,060	0,048	0,030	0,080	0,064	0,040
P.1.3	240	1,0	200	1,0*	100	0,8	0,028	0,022	0,014	0,038	0,030	0,019	0,049	0,039	0,025	0,060	0,048	0,030	0,080	0,064	0,040
P.1.4	228	1,0	190	1,0*	95	0,8	0,028	0,022	0,014	0,038	0,030	0,019	0,049	0,039	0,025	0,060	0,048	0,030	0,080	0,064	0,040
P.1.5	228	1,0	190	1,0*	95	0,8	0,028	0,022	0,014	0,038	0,030	0,019	0,049	0,039	0,025	0,060	0,048	0,030	0,080	0,064	0,040
P.2.1	240	1,0	200	1,0*	100	0,8	0,028	0,022	0,014	0,038	0,030	0,019	0,049	0,039	0,025	0,060	0,048	0,030	0,080	0,064	0,040
P.2.2	228	1,0	190	1,0*	95	0,8	0,028	0,022	0,014	0,038	0,030	0,019	0,049	0,039	0,025	0,060	0,048	0,030	0,080	0,064	0,040
P.2.3	216	1,0	180	1,0*	90	0,8	0,028	0,022	0,014	0,038	0,030	0,019	0,049	0,039	0,025	0,060	0,048	0,030	0,080	0,064	0,040
P.2.4	204	1,0	170	1,0*	85	0,8	0,028	0,022	0,014	0,038	0,030	0,019	0,049	0,039	0,025	0,060	0,048	0,030	0,080	0,064	0,040
P.3.1																					
P.3.2																					
P.3.3																					
P.4.1	120	1,0	100	1,0*	60	0,8	0,017	0,014	0,009	0,024	0,019	0,012	0,031	0,025	0,016	0,038	0,030	0,019	0,052	0,042	0,026
P.4.2	96	1,0	80	1,0*	50	0,8	0,017	0,014	0,009	0,024	0,019	0,012	0,031	0,025	0,016	0,038	0,030	0,019	0,052	0,042	0,026
M.1.1	120	1,0	100	1,0*	60	0,8	0,017	0,014	0,009	0,024	0,019	0,012	0,031	0,025	0,016	0,038	0,030	0,019	0,052	0,042	0,026
M.2.1	120	1,0	100	1,0*	60	0,8	0,017	0,014	0,009	0,024	0,019	0,012	0,031	0,025	0,016	0,038	0,030	0,019	0,052	0,042	0,026
M.3.1	120	1,0	100	1,0*	60	0,8	0,017	0,014	0,009	0,024	0,019	0,012	0,031	0,025	0,016	0,038	0,030	0,019	0,052	0,042	0,026
K.1.1	240	1,0	200	1,0*	100	0,8	0,037	0,030	0,019	0,048	0,038	0,024	0,060	0,048	0,030	0,070	0,056	0,035	0,094	0,075	0,047
K.1.2	216	1,0	180	1,0*	90	0,8	0,037	0,030	0,019	0,048	0,038	0,024	0,060	0,048	0,030	0,070	0,056	0,035	0,094	0,075	0,047
K.2.1	228	1,0	190	1,0*	60	0,8	0,028	0,022	0,014	0,038	0,030	0,019	0,049	0,039	0,025	0,060	0,048	0,030	0,080	0,064	0,040
K.2.2	204	1,0	170	1,0*	85	0,8	0,028	0,022	0,014	0,038	0,030	0,019	0,049	0,039	0,025	0,060	0,048	0,030	0,080	0,064	0,040
K.3.1	216	1,0	180	1,0*	90	0,8	0,028	0,022	0,014	0,038	0,030	0,019	0,049	0,039	0,025	0,060	0,048	0,030	0,080	0,064	0,040
K.3.2	192	1,0	160	1,0*	80	0,8	0,028	0,022	0,014	0,038	0,030	0,019	0,049	0,039	0,025	0,060	0,048	0,030	0,080	0,064	0,040
N.1.1																					
N.1.2																					
N.2.1																					
N.2.2																					
N.2.3																					
N.3.1	420	1,0	350	1,0*	175	0,8	0,037	0,030	0,019	0,048	0,038	0,024	0,060	0,048	0,030	0,070	0,056	0,035	0,094	0,075	0,047
N.3.2	420	1,0	350	1,0*	175	0,8	0,037	0,030	0,019	0,048	0,038	0,024	0,060	0,048	0,030	0,070	0,056	0,035	0,094	0,075	0,047
N.3.3	336	1,0	280	1,0*	140	0,8	0,037	0,030	0,019	0,048	0,038	0,024	0,060	0,048	0,030	0,070	0,056	0,035	0,094	0,075	0,047
N.4.1																					
S.1.1	30	0,5	25	0,5	15	0,4	0,015	0,012	0,008	0,020	0,016	0,010	0,025	0,020	0,013	0,030	0,024	0,015	0,040	0,032	0,020
S.1.2	30	0,5	25	0,5	15	0,4	0,015	0,012	0,008	0,020	0,016	0,010	0,025	0,020	0,013	0,030	0,024	0,015	0,040	0,032	0,020
S.2.1	30	0,5	25	0,5	15	0,4	0,015	0,012	0,008	0,020	0,016	0,010	0,025	0,020	0,013	0,030	0,024	0,015	0,040	0,032	0,020
S.2.2	30	0,5	25	0,5	15	0,4	0,015	0,012	0,008	0,020	0,016	0,010	0,025	0,020	0,013	0,030	0,024	0,015	0,040	0,032	0,020
S.2.3	30	0,5	25	0,5	15	0,4	0,015	0,012	0,008	0,020	0,016	0,010	0,025	0,020	0,013	0,030	0,024	0,015	0,040	0,032	0,020
S.3.1	108	1,0	90	1,0*	45	0,8	0,028	0,022	0,014	0,038	0,030	0,019	0,049	0,039	0,025	0,060	0,048	0,030	0,080	0,064	0,040
S.3.2	60	1,0	50	1,0*	25	0,8	0,017	0,014	0,009	0,024	0,019	0,012	0,031	0,025	0,016	0,038	0,030	0,019	0,052	0,042	0,026
S.3.3																					
H.1.1																					
H.1.2																					
H.1.3																					
H.1.4																					
H.2.1																					
H.3.1																					
O.1.1																					
O.1.2																					
O.2.1																					
O.2.2																					
O.3.1																					

* = long version: a_{p,max} = 1.5 x DC at f_z x 0.75

 "Extra-long" version: when profiling with an a_e of 0.1–0.4 x DC an a_p of 1.0 x DC should be used.

 Plunging angle for ramping and helical milling: 3°

Index	50 966 ..., 50 967 ..., 50 992 ...																		● 1st choice		
	Ø DC (mm) =																		○ suitable		
	8,5-10,0			12,0			14,0			16,0			18,0			20,0			Emulsion	Compressed air	MMS
	a _e 0,1-0,2 x DC	a _e 0,3-0,4 x DC	a _e 0,6-1,0 x DC	a _e 0,1-0,2 x DC	a _e 0,3-0,4 x DC	a _e 0,6-1,0 x DC	a _e 0,1-0,2 x DC	a _e 0,3-0,4 x DC	a _e 0,6-1,0 x DC	a _e 0,1-0,2 x DC	a _e 0,3-0,4 x DC	a _e 0,6-1,0 x DC	a _e 0,1-0,2 x DC	a _e 0,3-0,4 x DC	a _e 0,6-1,0 x DC	a _e 0,1-0,2 x DC	a _e 0,3-0,4 x DC	a _e 0,6-1,0 x DC			
f _t (mm)																					
P.1.1	0,100	0,080	0,050	0,120	0,096	0,060	0,140	0,112	0,070	0,150	0,120	0,075	0,160	0,128	0,080	0,170	0,136	0,085	●	○	○
P.1.2	0,100	0,080	0,050	0,120	0,096	0,060	0,140	0,112	0,070	0,150	0,120	0,075	0,160	0,128	0,080	0,170	0,136	0,085	●	○	○
P.1.3	0,100	0,080	0,050	0,120	0,096	0,060	0,140	0,112	0,070	0,150	0,120	0,075	0,160	0,128	0,080	0,170	0,136	0,085	●	○	○
P.1.4	0,100	0,080	0,050	0,120	0,096	0,060	0,140	0,112	0,070	0,150	0,120	0,075	0,160	0,128	0,080	0,170	0,136	0,085	●	○	○
P.1.5	0,100	0,080	0,050	0,120	0,096	0,060	0,140	0,112	0,070	0,150	0,120	0,075	0,160	0,128	0,080	0,170	0,136	0,085	●	○	○
P.2.1	0,100	0,080	0,050	0,120	0,096	0,060	0,140	0,112	0,070	0,150	0,120	0,075	0,160	0,128	0,080	0,170	0,136	0,085	●	○	○
P.2.2	0,100	0,080	0,050	0,120	0,096	0,060	0,140	0,112	0,070	0,150	0,120	0,075	0,160	0,128	0,080	0,170	0,136	0,085	●	○	○
P.2.3	0,100	0,080	0,050	0,120	0,096	0,060	0,140	0,112	0,070	0,150	0,120	0,075	0,160	0,128	0,080	0,170	0,136	0,085	●	○	○
P.2.4	0,100	0,080	0,050	0,120	0,096	0,060	0,140	0,112	0,070	0,150	0,120	0,075	0,160	0,128	0,080	0,170	0,136	0,085	●	○	○
P.3.1																					
P.3.2																					
P.3.3																					
P.4.1	0,066	0,053	0,033	0,080	0,064	0,040	0,094	0,075	0,047	0,101	0,081	0,051	0,108	0,086	0,054	0,115	0,092	0,058	●		
P.4.2	0,066	0,053	0,033	0,080	0,064	0,040	0,094	0,075	0,047	0,101	0,081	0,051	0,108	0,086	0,054	0,115	0,092	0,058	●		
M.1.1	0,066	0,053	0,033	0,080	0,064	0,040	0,094	0,075	0,047	0,101	0,081	0,051	0,108	0,086	0,054	0,115	0,092	0,058	●		
M.2.1	0,066	0,053	0,033	0,080	0,064	0,040	0,094	0,075	0,047	0,101	0,081	0,051	0,108	0,086	0,054	0,115	0,092	0,058	●		
M.3.1	0,066	0,053	0,033	0,080	0,064	0,040	0,094	0,075	0,047	0,101	0,081	0,051	0,108	0,086	0,054	0,115	0,092	0,058	●		
K.1.1	0,116	0,093	0,058	0,140	0,112	0,070	0,162	0,130	0,081	0,173	0,138	0,087	0,184	0,147	0,092	0,196	0,157	0,098	●	●	●
K.1.2	0,116	0,093	0,058	0,140	0,112	0,070	0,162	0,130	0,081	0,173	0,138	0,087	0,184	0,147	0,092	0,196	0,157	0,098	●	●	●
K.2.1	0,100	0,080	0,050	0,120	0,096	0,060	0,140	0,112	0,070	0,150	0,120	0,075	0,160	0,128	0,080	0,170	0,136	0,085	●	●	●
K.2.2	0,100	0,080	0,050	0,120	0,096	0,060	0,140	0,112	0,070	0,150	0,120	0,075	0,160	0,128	0,080	0,170	0,136	0,085	●	●	●
K.3.1	0,100	0,080	0,050	0,120	0,096	0,060	0,140	0,112	0,070	0,150	0,120	0,075	0,160	0,128	0,080	0,170	0,136	0,085	●	●	●
K.3.2	0,100	0,080	0,050	0,120	0,096	0,060	0,140	0,112	0,070	0,150	0,120	0,075	0,160	0,128	0,080	0,170	0,136	0,085	●	●	●
N.1.1																					
N.1.2																					
N.2.1																					
N.2.2																					
N.2.3																					
N.3.1	0,116	0,093	0,058	0,140	0,112	0,070	0,162	0,130	0,081	0,173	0,138	0,087	0,184	0,147	0,092	0,196	0,157	0,098	●		
N.3.2	0,116	0,093	0,058	0,140	0,112	0,070	0,162	0,130	0,081	0,173	0,138	0,087	0,184	0,147	0,092	0,196	0,157	0,098	●		
N.3.3	0,116	0,093	0,058	0,140	0,112	0,070	0,162	0,130	0,081	0,173	0,138	0,087	0,184	0,147	0,092	0,196	0,157	0,098	●		
N.4.1																					
S.1.1	0,050	0,040	0,025	0,060	0,048	0,030	0,070	0,056	0,035	0,075	0,060	0,038	0,079	0,063	0,040	0,084	0,067	0,042	●		
S.1.2	0,050	0,040	0,025	0,060	0,048	0,030	0,070	0,056	0,035	0,075	0,060	0,038	0,079	0,063	0,040	0,084	0,067	0,042	●		
S.2.1	0,050	0,040	0,025	0,060	0,048	0,030	0,070	0,056	0,035	0,075	0,060	0,038	0,079	0,063	0,040	0,084	0,067	0,042	●		
S.2.2	0,050	0,040	0,025	0,060	0,048	0,030	0,070	0,056	0,035	0,075	0,060	0,038	0,079	0,063	0,040	0,084	0,067	0,042	●		
S.2.3	0,050	0,040	0,025	0,060	0,048	0,030	0,070	0,056	0,035	0,075	0,060	0,038	0,079	0,063	0,040	0,084	0,067	0,042	●		
S.3.1	0,100	0,080	0,050	0,120	0,096	0,060	0,140	0,112	0,070	0,150	0,120	0,075	0,160	0,128	0,080	0,170	0,136	0,085	●		
S.3.2	0,066	0,053	0,033	0,080	0,064	0,040	0,094	0,075	0,047	0,101	0,081	0,051	0,108	0,086	0,054	0,115	0,092	0,058	●		
S.3.3																					
H.1.1																					
H.1.2																					
H.1.3																					
H.1.4																					
H.2.1																					
H.3.1																					
O.1.1																					
O.1.2																					
O.2.1																					
O.2.2																					
O.3.1																					

Cutting data standard values – SilverLine – End mill

Index	Type long v _c (m/min) a _{p,max} x DC		50 976 ..., 50 977 ...															
			Ø DC (mm) =															
			3		4		5		6		8		10		12		14	
			a _e 0,3–0,4 x DC	a _e 0,6–1,0 x DC	a _e 0,3–0,4 x DC	a _e 0,6–1,0 x DC	a _e 0,3–0,4 x DC	a _e 0,6–1,0 x DC	a _e 0,3–0,4 x DC	a _e 0,6–1,0 x DC	a _e 0,3–0,4 x DC	a _e 0,6–1,0 x DC	a _e 0,3–0,4 x DC	a _e 0,6–1,0 x DC	a _e 0,3–0,4 x DC	a _e 0,6–1,0 x DC	a _e 0,3–0,4 x DC	a _e 0,6–1,0 x DC
f _z (mm)																		
P.1.1	210	2,0	0,026	0,019	0,034	0,024	0,042	0,030	0,049	0,035	0,066	0,047	0,081	0,058	0,098	0,070	0,113	0,081
P.1.2	200	2,0	0,026	0,019	0,034	0,024	0,042	0,030	0,049	0,035	0,066	0,047	0,081	0,058	0,098	0,070	0,113	0,081
P.1.3	200	2,0	0,026	0,019	0,034	0,024	0,042	0,030	0,049	0,035	0,066	0,047	0,081	0,058	0,098	0,070	0,113	0,081
P.1.4	190	2,0	0,026	0,019	0,034	0,024	0,042	0,030	0,049	0,035	0,066	0,047	0,081	0,058	0,098	0,070	0,113	0,081
P.1.5	190	2,0	0,026	0,019	0,034	0,024	0,042	0,030	0,049	0,035	0,066	0,047	0,081	0,058	0,098	0,070	0,113	0,081
P.2.1	200	2,0	0,026	0,019	0,034	0,024	0,042	0,030	0,049	0,035	0,066	0,047	0,081	0,058	0,098	0,070	0,113	0,081
P.2.2	190	2,0	0,020	0,014	0,027	0,019	0,034	0,025	0,042	0,030	0,056	0,040	0,070	0,050	0,084	0,060	0,098	0,070
P.2.3	180	2,0	0,026	0,019	0,034	0,024	0,042	0,030	0,049	0,035	0,066	0,047	0,081	0,058	0,098	0,070	0,113	0,081
P.2.4	170	2,0	0,020	0,014	0,027	0,019	0,034	0,025	0,042	0,030	0,056	0,040	0,070	0,050	0,084	0,060	0,098	0,070
P.3.1	180	2,0	0,026	0,019	0,034	0,024	0,042	0,030	0,049	0,035	0,066	0,047	0,081	0,058	0,098	0,070	0,113	0,081
P.3.2	170	2,0	0,026	0,019	0,034	0,024	0,042	0,030	0,049	0,035	0,066	0,047	0,081	0,058	0,098	0,070	0,113	0,081
P.3.3	140	2,0	0,026	0,019	0,034	0,024	0,042	0,030	0,049	0,035	0,066	0,047	0,081	0,058	0,098	0,070	0,113	0,081
P.4.1	120	1,5	0,012	0,009	0,017	0,012	0,022	0,016	0,027	0,019	0,036	0,026	0,046	0,033	0,056	0,040	0,066	0,047
P.4.2	100	1,5	0,012	0,009	0,017	0,012	0,022	0,016	0,027	0,019	0,036	0,026	0,046	0,033	0,056	0,040	0,066	0,047
M.1.1	120	1,5	0,012	0,009	0,017	0,012	0,022	0,016	0,027	0,019	0,036	0,026	0,046	0,033	0,056	0,040	0,066	0,047
M.2.1	120	1,5	0,012	0,009	0,017	0,012	0,022	0,016	0,027	0,019	0,036	0,026	0,046	0,033	0,056	0,040	0,066	0,047
M.3.1	120	1,5	0,012	0,009	0,017	0,012	0,022	0,016	0,027	0,019	0,036	0,026	0,046	0,033	0,056	0,040	0,066	0,047
K.1.1	200	2,0	0,031	0,022	0,039	0,028	0,048	0,034	0,056	0,040	0,074	0,053	0,091	0,065	0,108	0,077	0,126	0,090
K.1.2	180	2,0	0,031	0,022	0,039	0,028	0,048	0,034	0,056	0,040	0,074	0,053	0,091	0,065	0,108	0,077	0,126	0,090
K.2.1	190	2,0	0,026	0,019	0,034	0,024	0,042	0,030	0,049	0,035	0,066	0,047	0,081	0,058	0,098	0,070	0,113	0,081
K.2.2	170	2,0	0,026	0,019	0,034	0,024	0,042	0,030	0,049	0,035	0,066	0,047	0,081	0,058	0,098	0,070	0,113	0,081
K.3.1	180	2,0	0,026	0,019	0,034	0,024	0,042	0,030	0,049	0,035	0,066	0,047	0,081	0,058	0,098	0,070	0,113	0,081
K.3.2	160	2,0	0,026	0,019	0,034	0,024	0,042	0,030	0,049	0,035	0,066	0,047	0,081	0,058	0,098	0,070	0,113	0,081
N.1.1																		
N.1.2																		
N.2.1																		
N.2.2																		
N.2.3																		
N.3.1	350	2,0	0,031	0,022	0,039	0,028	0,048	0,034	0,056	0,040	0,074	0,053	0,091	0,065	0,108	0,077	0,126	0,090
N.3.2	350	2,0	0,031	0,022	0,039	0,028	0,048	0,034	0,056	0,040	0,074	0,053	0,091	0,065	0,108	0,077	0,126	0,090
N.3.3	280	2,0	0,031	0,022	0,039	0,028	0,048	0,034	0,056	0,040	0,074	0,053	0,091	0,065	0,108	0,077	0,126	0,090
N.4.1																		
S.1.1																		
S.1.2																		
S.2.1																		
S.2.2																		
S.2.3																		
S.3.1																		
S.3.2																		
S.3.3																		
H.1.1																		
H.1.2																		
H.1.3																		
H.1.4																		
H.2.1																		
H.3.1																		
O.1.1																		
O.1.2																		
O.2.1																		
O.2.2																		
O.3.1																		

 Profiling with an a_e < 0.3xDC only possible under certain conditions!

 Plunging angle for ramping and helical milling: 3°

Index	50 976 ..., 50 977 ...						● 1st choice ○ suitable		
	Ø DC (mm) =						Emulsion	Compressed air	MMS
	16		18		20				
	a_e 0,3-0,4 x DC	a_e 0,6-1,0 x DC	a_e 0,3-0,4 x DC	a_e 0,6-1,0 x DC	a_e 0,3-0,4 x DC	a_e 0,6-1,0 x DC			
f_z (mm)									
P.1.1	0,121	0,087	0,129	0,092	0,137	0,098	●	○	○
P.1.2	0,121	0,087	0,129	0,092	0,137	0,098	●	○	○
P.1.3	0,121	0,087	0,129	0,092	0,137	0,098	●	○	○
P.1.4	0,121	0,087	0,129	0,092	0,137	0,098	●	○	○
P.1.5	0,121	0,087	0,129	0,092	0,137	0,098	●	○	○
P.2.1	0,121	0,087	0,129	0,092	0,137	0,098	●	○	○
P.2.2	0,105	0,075	0,112	0,080	0,119	0,085	●	○	○
P.2.3	0,121	0,087	0,129	0,092	0,137	0,098	●	○	○
P.2.4	0,105	0,075	0,112	0,080	0,119	0,085	●	○	○
P.3.1	0,121	0,087	0,129	0,092	0,137	0,098	●	○	○
P.3.2	0,121	0,087	0,129	0,092	0,137	0,098	●	○	○
P.3.3	0,121	0,087	0,129	0,092	0,137	0,098	●	○	○
P.4.1	0,071	0,051	0,076	0,054	0,081	0,058	●		
P.4.2	0,071	0,051	0,076	0,054	0,081	0,058	●		
M.1.1	0,071	0,051	0,076	0,054	0,081	0,058	●		
M.2.1	0,071	0,051	0,076	0,054	0,081	0,058	●		
M.3.1	0,071	0,051	0,076	0,054	0,081	0,058	●		
K.1.1	0,134	0,096	0,143	0,102	0,151	0,108	●	●	●
K.1.2	0,134	0,096	0,143	0,102	0,151	0,108	●	●	●
K.2.1	0,121	0,087	0,129	0,092	0,137	0,098	●	●	●
K.2.2	0,121	0,087	0,129	0,092	0,137	0,098	●	●	●
K.3.1	0,121	0,087	0,129	0,092	0,137	0,098	●	●	●
K.3.2	0,121	0,087	0,129	0,092	0,137	0,098	●	●	●
N.1.1									
N.1.2									
N.2.1									
N.2.2									
N.2.3									
N.3.1	0,134	0,096	0,143	0,102	0,151	0,108	●	○	○
N.3.2	0,134	0,096	0,143	0,102	0,151	0,108	●	○	○
N.3.3	0,134	0,096	0,143	0,102	0,151	0,108	●	○	○
N.4.1									
S.1.1									
S.1.2									
S.2.1									
S.2.2									
S.2.3									
S.3.1									
S.3.2									
S.3.3									
H.1.1									
H.1.2									
H.1.3									
H.1.4									
H.2.1									
H.3.1									
O.1.1									
O.1.2									
O.2.1									
O.2.2									
O.3.1									

Cutting data standard values – SilverLine – End mill

Index	Type extra long v _c (m/min) a _{p,max.} x DC		50 970 ..., 50 971 ..., 50 974 ..., 50 975 ...																	
			Ø DC (mm) =																	
			3			4			5			6			8			10		
			a _e 0,1–0,2 x DC	a _e 0,3–0,4 x DC	a _e 0,6–1,0 x DC	a _e 0,1–0,2 x DC	a _e 0,3–0,4 x DC	a _e 0,6–1,0 x DC	a _e 0,1–0,2 x DC	a _e 0,3–0,4 x DC	a _e 0,6–1,0 x DC	a _e 0,1–0,2 x DC	a _e 0,3–0,4 x DC	a _e 0,6–1,0 x DC	a _e 0,1–0,2 x DC	a _e 0,3–0,4 x DC	a _e 0,6–1,0 x DC	a _e 0,1–0,2 x DC	a _e 0,3–0,4 x DC	a _e 0,6–1,0 x DC
f _z (mm)																				
P.1.1	160	1,0	0,027	0,021	0,015	0,036	0,028	0,020	0,050	0,037	0,025	0,060	0,045	0,030	0,080	0,060	0,040	0,100	0,075	0,050
P.1.2	140	1,0	0,027	0,021	0,015	0,036	0,028	0,020	0,050	0,037	0,025	0,060	0,045	0,030	0,080	0,060	0,040	0,100	0,075	0,050
P.1.3	140	1,0	0,027	0,021	0,015	0,036	0,028	0,020	0,050	0,037	0,025	0,060	0,045	0,030	0,080	0,060	0,040	0,100	0,075	0,050
P.1.4	140	1,0	0,027	0,021	0,015	0,036	0,028	0,020	0,050	0,037	0,025	0,060	0,045	0,030	0,080	0,060	0,040	0,100	0,075	0,050
P.1.5	140	1,0	0,027	0,021	0,015	0,036	0,028	0,020	0,050	0,037	0,025	0,060	0,045	0,030	0,080	0,060	0,040	0,100	0,075	0,050
P.2.1	140	1,0	0,027	0,021	0,015	0,036	0,028	0,020	0,050	0,037	0,025	0,060	0,045	0,030	0,080	0,060	0,040	0,100	0,075	0,050
P.2.2	140	1,0	0,027	0,021	0,015	0,036	0,028	0,020	0,050	0,037	0,025	0,060	0,045	0,030	0,080	0,060	0,040	0,100	0,075	0,050
P.2.3	120	1,0	0,027	0,021	0,015	0,036	0,028	0,020	0,050	0,037	0,025	0,060	0,045	0,030	0,080	0,060	0,040	0,100	0,075	0,050
P.2.4	120	1,0	0,027	0,021	0,015	0,036	0,028	0,020	0,050	0,037	0,025	0,060	0,045	0,030	0,080	0,060	0,040	0,100	0,075	0,050
P.3.1	140	1,0	0,027	0,021	0,015	0,036	0,028	0,020	0,050	0,037	0,025	0,060	0,045	0,030	0,080	0,060	0,040	0,100	0,075	0,050
P.3.2	80	1,0	0,027	0,021	0,015	0,036	0,028	0,020	0,050	0,037	0,025	0,060	0,045	0,030	0,080	0,060	0,040	0,100	0,075	0,050
P.3.3	80	1,0	0,027	0,021	0,015	0,036	0,028	0,020	0,050	0,037	0,025	0,060	0,045	0,030	0,080	0,060	0,040	0,100	0,075	0,050
P.4.1	80	0,5	0,016	0,012	0,009	0,022	0,017	0,012	0,030	0,022	0,015	0,038	0,028	0,019	0,050	0,037	0,025	0,064	0,048	0,032
P.4.2	80	0,5	0,016	0,012	0,009	0,022	0,017	0,012	0,030	0,022	0,015	0,038	0,028	0,019	0,050	0,037	0,025	0,064	0,048	0,032
M.1.1	80	0,5	0,016	0,012	0,009	0,022	0,017	0,012	0,030	0,022	0,015	0,038	0,028	0,019	0,050	0,037	0,025	0,064	0,048	0,032
M.2.1	70	0,5	0,016	0,012	0,009	0,022	0,017	0,012	0,030	0,022	0,015	0,038	0,028	0,019	0,050	0,037	0,025	0,064	0,048	0,032
M.3.1	80	0,5	0,016	0,012	0,009	0,022	0,017	0,012	0,030	0,022	0,015	0,038	0,028	0,019	0,050	0,037	0,025	0,064	0,048	0,032
K.1.1	150	1,0	0,040	0,031	0,022	0,054	0,042	0,030	0,070	0,052	0,035	0,080	0,060	0,040	0,100	0,075	0,050	0,110	0,082	0,055
K.1.2	140	1,0	0,040	0,031	0,022	0,054	0,042	0,030	0,070	0,052	0,035	0,080	0,060	0,040	0,100	0,075	0,050	0,110	0,082	0,055
K.2.1	150	1,0	0,027	0,021	0,015	0,036	0,028	0,020	0,050	0,037	0,025	0,060	0,045	0,030	0,080	0,060	0,040	0,090	0,067	0,045
K.2.2	140	1,0	0,027	0,021	0,015	0,036	0,028	0,020	0,050	0,037	0,025	0,060	0,045	0,030	0,080	0,060	0,040	0,090	0,067	0,045
K.3.1	140	1,0	0,027	0,021	0,015	0,036	0,028	0,020	0,050	0,037	0,025	0,060	0,045	0,030	0,080	0,060	0,040	0,090	0,067	0,045
K.3.2	140	1,0	0,027	0,021	0,015	0,036	0,028	0,020	0,050	0,037	0,025	0,060	0,045	0,030	0,080	0,060	0,040	0,090	0,067	0,045
N.1.1																				
N.1.2																				
N.2.1																				
N.2.2																				
N.2.3																				
N.3.1	220	1,0	0,034	0,026	0,019	0,045	0,035	0,025	0,054	0,042	0,030	0,063	0,049	0,035	0,081	0,062	0,045	0,102	0,079	0,057
N.3.2	180	1,0	0,034	0,026	0,019	0,045	0,035	0,025	0,054	0,042	0,030	0,063	0,049	0,035	0,081	0,062	0,045	0,102	0,079	0,057
N.3.3	180	1,0	0,034	0,026	0,019	0,045	0,035	0,025	0,054	0,042	0,030	0,063	0,049	0,035	0,081	0,062	0,045	0,102	0,079	0,057
N.4.1																				
S.1.1	25	0,5	0,013	0,010	0,007	0,018	0,014	0,010	0,022	0,017	0,012	0,027	0,021	0,015	0,036	0,028	0,020	0,045	0,035	0,025
S.1.2	25	0,5	0,013	0,010	0,007	0,018	0,014	0,010	0,022	0,017	0,012	0,027	0,021	0,015	0,036	0,028	0,020	0,045	0,035	0,025
S.2.1	25	0,5	0,013	0,010	0,007	0,018	0,014	0,010	0,022	0,017	0,012	0,027	0,021	0,015	0,036	0,028	0,020	0,045	0,035	0,025
S.2.2	25	0,5	0,013	0,010	0,007	0,018	0,014	0,010	0,022	0,017	0,012	0,027	0,021	0,015	0,036	0,028	0,020	0,045	0,035	0,025
S.2.3	25	0,5	0,013	0,010	0,007	0,018	0,014	0,010	0,022	0,017	0,012	0,027	0,021	0,015	0,036	0,028	0,020	0,045	0,035	0,025
S.3.1	80	0,5	0,027	0,021	0,015	0,036	0,028	0,020	0,045	0,035	0,025	0,054	0,042	0,030	0,072	0,055	0,040	0,090	0,069	0,050
S.3.2	70	0,5	0,020	0,015	0,011	0,027	0,021	0,015	0,032	0,025	0,018	0,040	0,031	0,022	0,054	0,042	0,030	0,072	0,055	0,040
S.3.3																				
H.1.1																				
H.1.2																				
H.1.3																				
H.1.4																				
H.2.1																				
H.3.1																				
O.1.1																				
O.1.2																				
O.2.1																				
O.2.2																				
O.3.1																				

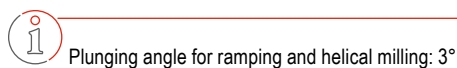

Index	50 970 ..., 50 971 ..., 50 974 ..., 50 975 ...															● 1st choice		
	Ø DC (mm) =															○ suitable		
	12			14			16			18			20			Emulsion	Compressed air	MMS
	a _e 0,1-0,2 x DC	a _s 0,3-0,4 x DC	a _e 0,6-1,0 x DC	a _e 0,1-0,2 x DC	a _s 0,3-0,4 x DC	a _e 0,6-1,0 x DC	a _e 0,1-0,2 x DC	a _s 0,3-0,4 x DC	a _e 0,6-1,0 x DC	a _e 0,1-0,2 x DC	a _s 0,3-0,4 x DC	a _e 0,6-1,0 x DC	a _e 0,1-0,2 x DC	a _s 0,3-0,4 x DC	a _e 0,6-1,0 x DC			
	f _t (mm)																	
P.1.1	0,120	0,089	0,060	0,128	0,099	0,070	0,135	0,103	0,080	0,142	0,116	0,090	0,158	0,129	0,100	●	○	○
P.1.2	0,120	0,089	0,060	0,128	0,099	0,070	0,135	0,103	0,080	0,142	0,116	0,090	0,158	0,129	0,100	●	○	○
P.1.3	0,120	0,089	0,060	0,128	0,099	0,070	0,135	0,103	0,080	0,142	0,116	0,090	0,158	0,129	0,100	●	○	○
P.1.4	0,120	0,089	0,060	0,128	0,099	0,070	0,135	0,103	0,080	0,142	0,116	0,090	0,158	0,129	0,100	●	○	○
P.1.5	0,120	0,089	0,060	0,128	0,099	0,070	0,135	0,103	0,080	0,142	0,116	0,090	0,158	0,129	0,100	●	○	○
P.2.1	0,120	0,089	0,060	0,128	0,099	0,070	0,135	0,103	0,080	0,142	0,116	0,090	0,158	0,129	0,100	●	○	○
P.2.2	0,120	0,089	0,060	0,128	0,099	0,070	0,135	0,103	0,080	0,142	0,116	0,090	0,158	0,129	0,100	●	○	○
P.2.3	0,120	0,089	0,060	0,128	0,099	0,070	0,135	0,103	0,080	0,142	0,116	0,090	0,158	0,129	0,100	●	○	○
P.2.4	0,120	0,089	0,060	0,128	0,099	0,070	0,135	0,103	0,080	0,142	0,116	0,090	0,158	0,129	0,100	●	○	○
P.3.1	0,120	0,089	0,060	0,128	0,099	0,070	0,135	0,103	0,080	0,142	0,116	0,090	0,158	0,129	0,100	●	○	○
P.3.2	0,120	0,089	0,060	0,128	0,099	0,070	0,135	0,103	0,080	0,142	0,116	0,090	0,158	0,129	0,100	●	○	○
P.3.3	0,120	0,089	0,060	0,128	0,099	0,070	0,135	0,103	0,080	0,142	0,116	0,090	0,158	0,129	0,100	●	○	○
P.4.1	0,080	0,060	0,040	0,082	0,064	0,045	0,085	0,065	0,050	0,095	0,077	0,060	0,111	0,090	0,070	●		
P.4.2	0,080	0,060	0,040	0,082	0,064	0,045	0,085	0,065	0,050	0,095	0,077	0,060	0,111	0,090	0,070	●		
M.1.1	0,080	0,060	0,040	0,082	0,064	0,045	0,085	0,065	0,050	0,095	0,077	0,060	0,111	0,090	0,070	●		
M.2.1	0,080	0,060	0,040	0,082	0,064	0,045	0,085	0,065	0,050	0,095	0,077	0,060	0,111	0,090	0,070	●		
M.3.1	0,080	0,060	0,040	0,082	0,064	0,045	0,085	0,065	0,050	0,095	0,077	0,060	0,111	0,090	0,070	●		
K.1.1	0,120	0,089	0,060	0,128	0,099	0,070	0,135	0,103	0,080	0,142	0,116	0,090	0,158	0,129	0,100	●	●	●
K.1.2	0,120	0,089	0,060	0,128	0,099	0,070	0,135	0,103	0,080	0,142	0,116	0,090	0,158	0,129	0,100	●	●	●
K.2.1	0,100	0,075	0,050	0,100	0,078	0,055	0,101	0,077	0,060	0,103	0,084	0,065	0,111	0,090	0,070	●	●	●
K.2.2	0,100	0,075	0,050	0,100	0,078	0,055	0,101	0,077	0,060	0,103	0,084	0,065	0,111	0,090	0,070	●	●	●
K.3.1	0,100	0,075	0,050	0,100	0,078	0,055	0,101	0,077	0,060	0,103	0,084	0,065	0,111	0,090	0,070	●	●	●
K.3.2	0,100	0,075	0,050	0,100	0,078	0,055	0,101	0,077	0,060	0,103	0,084	0,065	0,111	0,090	0,070	●	●	●
N.1.1																		
N.1.2																		
N.2.1																		
N.2.2																		
N.2.3																		
N.3.1	0,126	0,097	0,070	0,153	0,118	0,085	0,180	0,139	0,100	0,198	0,153	0,110	0,216	0,166	0,120	●		
N.3.2	0,126	0,097	0,070	0,153	0,118	0,085	0,180	0,139	0,100	0,198	0,153	0,110	0,216	0,166	0,120	●		
N.3.3	0,126	0,097	0,070	0,153	0,118	0,085	0,180	0,139	0,100	0,198	0,153	0,110	0,216	0,166	0,120	●		
N.4.1																		
S.1.1	0,054	0,042	0,030	0,063	0,049	0,035	0,072	0,055	0,040	0,081	0,062	0,045	0,090	0,069	0,050	●		
S.1.2	0,054	0,042	0,030	0,063	0,049	0,035	0,072	0,055	0,040	0,081	0,062	0,045	0,090	0,069	0,050	●		
S.2.1	0,054	0,042	0,030	0,063	0,049	0,035	0,072	0,055	0,040	0,081	0,062	0,045	0,090	0,069	0,050	●		
S.2.2	0,054	0,042	0,030	0,063	0,049	0,035	0,072	0,055	0,040	0,081	0,062	0,045	0,090	0,069	0,050	●		
S.2.3	0,054	0,042	0,030	0,063	0,049	0,035	0,072	0,055	0,040	0,081	0,062	0,045	0,090	0,069	0,050	●		
S.3.1	0,108	0,083	0,060	0,126	0,097	0,070	0,144	0,111	0,080	0,162	0,125	0,090	0,180	0,139	0,100	●		
S.3.2	0,090	0,069	0,050	0,099	0,076	0,055	0,108	0,083	0,060	0,126	0,097	0,070	0,144	0,111	0,080	●		
S.3.3																●		
H.1.1																		
H.1.2																		
H.1.3																		
H.1.4																		
H.2.1																		
H.3.1																		
O.1.1																		
O.1.2																		
O.2.1																		
O.2.2																		
O.3.1																		

Cutting data standard values – SilverLine – End mill, roughing-finishing and rough milling cutter

Index	Type short	Type long	v _c (m/min)	a _{p,max} x DC	50 969 ..., 50 970..., 50 971 ..., 50 972 ..., 50 973 ..., 50 974 ..., 50 975 ..., 50 978 ..., 50 979 ...																	
					Ø DC (mm) =																	
					3,0			3,5–4,0			4,5–5,0			5,5–6,0			7,0–8,0			9,0–10,0		
					a _e 0,1–0,2 x DC	a _e 0,3–0,4 x DC	a _e 0,6–1,0 x DC	a _e 0,1–0,2 x DC	a _e 0,3–0,4 x DC	a _e 0,6–1,0 x DC	a _e 0,1–0,2 x DC	a _e 0,3–0,4 x DC	a _e 0,6–1,0 x DC	a _e 0,1–0,2 x DC	a _e 0,3–0,4 x DC	a _e 0,6–1,0 x DC	a _e 0,1–0,2 x DC	a _e 0,3–0,4 x DC	a _e 0,6–1,0 x DC	a _e 0,1–0,2 x DC	a _e 0,3–0,4 x DC	a _e 0,6–1,0 x DC
f _z (mm)																						
P.1.1	253	230	1,0*	0,037	0,030	0,019	0,048	0,038	0,024	0,060	0,048	0,030	0,070	0,056	0,035	0,094	0,075	0,047	0,116	0,093	0,058	
P.1.2	242	220	1,0*	0,037	0,030	0,019	0,048	0,038	0,024	0,060	0,048	0,030	0,070	0,056	0,035	0,094	0,075	0,047	0,116	0,093	0,058	
P.1.3	242	220	1,0*	0,037	0,030	0,019	0,048	0,038	0,024	0,060	0,048	0,030	0,070	0,056	0,035	0,094	0,075	0,047	0,116	0,093	0,058	
P.1.4	230	210	1,0*	0,037	0,030	0,019	0,048	0,038	0,024	0,060	0,048	0,030	0,070	0,056	0,035	0,094	0,075	0,047	0,116	0,093	0,058	
P.1.5	230	210	1,0*	0,037	0,030	0,019	0,048	0,038	0,024	0,060	0,048	0,030	0,070	0,056	0,035	0,094	0,075	0,047	0,116	0,093	0,058	
P.2.1	242	220	1,0*	0,037	0,030	0,019	0,048	0,038	0,024	0,060	0,048	0,030	0,070	0,056	0,035	0,094	0,075	0,047	0,116	0,093	0,058	
P.2.2	230	210	1,0*	0,028	0,022	0,014	0,038	0,030	0,019	0,049	0,039	0,025	0,060	0,048	0,030	0,080	0,064	0,040	0,100	0,080	0,050	
P.2.3	220	200	1,0*	0,037	0,030	0,019	0,048	0,038	0,024	0,060	0,048	0,030	0,070	0,056	0,035	0,094	0,075	0,047	0,116	0,093	0,058	
P.2.4	210	190	1,0*	0,028	0,022	0,014	0,038	0,030	0,019	0,049	0,039	0,025	0,060	0,048	0,030	0,080	0,064	0,040	0,100	0,080	0,050	
P.3.1	220	200	1,0*	0,037	0,030	0,019	0,048	0,038	0,024	0,060	0,048	0,030	0,070	0,056	0,035	0,094	0,075	0,047	0,116	0,093	0,058	
P.3.2	210	190	1,0*	0,037	0,030	0,019	0,048	0,038	0,024	0,060	0,048	0,030	0,070	0,056	0,035	0,094	0,075	0,047	0,116	0,093	0,058	
P.3.3	176	160	1,0*	0,037	0,030	0,019	0,048	0,038	0,024	0,060	0,048	0,030	0,070	0,056	0,035	0,094	0,075	0,047	0,116	0,093	0,058	
P.4.1	120	110	1,0*	0,017	0,014	0,009	0,024	0,019	0,012	0,031	0,025	0,016	0,038	0,030	0,019	0,052	0,042	0,026	0,066	0,053	0,033	
P.4.2	100	90	1,0*	0,017	0,014	0,009	0,024	0,019	0,012	0,031	0,025	0,016	0,038	0,030	0,019	0,052	0,042	0,026	0,066	0,053	0,033	
M.1.1	120	110	1,0*	0,017	0,014	0,009	0,024	0,019	0,012	0,031	0,025	0,016	0,038	0,030	0,019	0,052	0,042	0,026	0,066	0,053	0,033	
M.2.1	120	110	1,0*	0,017	0,014	0,009	0,024	0,019	0,012	0,031	0,025	0,016	0,038	0,030	0,019	0,052	0,042	0,026	0,066	0,053	0,033	
M.3.1	120	110	1,0*	0,017	0,014	0,009	0,024	0,019	0,012	0,031	0,025	0,016	0,038	0,030	0,019	0,052	0,042	0,026	0,066	0,053	0,033	
K.1.1	242	220	1,0*	0,046	0,037	0,023	0,062	0,050	0,031	0,078	0,062	0,039	0,094	0,075	0,047	0,126	0,101	0,063	0,160	0,128	0,080	
K.1.2	220	200	1,0*	0,046	0,037	0,023	0,062	0,050	0,031	0,078	0,062	0,039	0,094	0,075	0,047	0,126	0,101	0,063	0,160	0,128	0,080	
K.2.1	230	210	1,0*	0,037	0,030	0,019	0,048	0,038	0,024	0,060	0,048	0,030	0,070	0,056	0,035	0,094	0,075	0,047	0,116	0,093	0,058	
K.2.2	210	190	1,0*	0,037	0,030	0,019	0,048	0,038	0,024	0,060	0,048	0,030	0,070	0,056	0,035	0,094	0,075	0,047	0,116	0,093	0,058	
K.3.1	220	200	1,0*	0,037	0,030	0,019	0,048	0,038	0,024	0,060	0,048	0,030	0,070	0,056	0,035	0,094	0,075	0,047	0,116	0,093	0,058	
K.3.2	200	180	1,0*	0,037	0,030	0,019	0,048	0,038	0,024	0,060	0,048	0,030	0,070	0,056	0,035	0,094	0,075	0,047	0,116	0,093	0,058	
N.1.1																						
N.1.2																						
N.2.1																						
N.2.2																						
N.2.3																						
N.3.1	385	350	1,0*	0,046	0,037	0,023	0,062	0,050	0,031	0,078	0,062	0,039	0,094	0,075	0,047	0,126	0,101	0,063	0,160	0,128	0,080	
N.3.2	308	350	1,0*	0,046	0,037	0,023	0,062	0,050	0,031	0,078	0,062	0,039	0,094	0,075	0,047	0,126	0,101	0,063	0,160	0,128	0,080	
N.3.3	308	280	1,0*	0,046	0,037	0,023	0,062	0,050	0,031	0,078	0,062	0,039	0,094	0,075	0,047	0,126	0,101	0,063	0,160	0,128	0,080	
N.4.1																						
S.1.1	35	30	0,5	0,015	0,012	0,008	0,020	0,016	0,010	0,025	0,020	0,013	0,030	0,024	0,015	0,040	0,032	0,020	0,050	0,040	0,025	
S.1.2	35	30	0,5	0,015	0,012	0,008	0,020	0,016	0,010	0,025	0,020	0,013	0,030	0,024	0,015	0,040	0,032	0,020	0,050	0,040	0,025	
S.2.1	35	30	0,5	0,015	0,012	0,008	0,020	0,016	0,010	0,025	0,020	0,013	0,030	0,024	0,015	0,040	0,032	0,020	0,050	0,040	0,025	
S.2.2	35	30	0,5	0,015	0,012	0,008	0,020	0,016	0,010	0,025	0,020	0,013	0,030	0,024	0,015	0,040	0,032	0,020	0,050	0,040	0,025	
S.2.3	35	30	0,5	0,015	0,012	0,008	0,020	0,016	0,010	0,025	0,020	0,013	0,030	0,024	0,015	0,040	0,032	0,020	0,050	0,040	0,025	
S.3.1	110	90	0,5	0,028	0,022	0,014	0,038	0,030	0,019	0,049	0,039	0,025	0,060	0,048	0,030	0,080	0,064	0,040	0,100	0,080	0,050	
S.3.2	70	50	0,5	0,017	0,014	0,009	0,024	0,019	0,012	0,031	0,025	0,016	0,038	0,030	0,019	0,052	0,042	0,026	0,066	0,053	0,033	
S.3.3																						
H.1.1																						
H.1.2																						
H.1.3																						
H.1.4																						
H.2.1																						
H.3.1																						
O.1.1																						
O.1.2																						
O.2.1																						
O.2.2																						
O.3.1																						

* = long version: a_{p,max} = 1.5 x DC at f_z x 0.75



Plunging angle for ramping and helical milling: 3°

Index	50 969 ..., 50 970 ..., 50 971 ..., 50 972 ..., 50 973 ..., 50 974 ..., 50 975 ..., 50 978 ..., 50 979 ...															● 1st choice ○ suitable		
	Ø DC (mm) =															Emulsion	Compressed air	MMS
	11,0–12,0			14,0			15,0–16,0			17,0→18,0			19,0–20,0					
	a _e 0,1–0,2 x DC	a _e 0,3–0,4 x DC	a _e 0,6–1,0 x DC	a _e 0,1–0,2 x DC	a _e 0,3–0,4 x DC	a _e 0,6–1,0 x DC	a _e 0,1–0,2 x DC	a _e 0,3–0,4 x DC	a _e 0,6–1,0 x DC	a _e 0,1–0,2 x DC	a _e 0,3–0,4 x DC	a _e 0,6–1,0 x DC	a _e 0,1–0,2 x DC	a _e 0,3–0,4 x DC	a _e 0,6–1,0 x DC			
f _s (mm)																		
P.1.1	0,140	0,112	0,070	0,162	0,130	0,081	0,173	0,138	0,087	0,184	0,147	0,092	0,196	0,157	0,098	●	○	○
P.1.2	0,140	0,112	0,070	0,162	0,130	0,081	0,173	0,138	0,087	0,184	0,147	0,092	0,196	0,157	0,098	●	○	○
P.1.3	0,140	0,112	0,070	0,162	0,130	0,081	0,173	0,138	0,087	0,184	0,147	0,092	0,196	0,157	0,098	●	○	○
P.1.4	0,140	0,112	0,070	0,162	0,130	0,081	0,173	0,138	0,087	0,184	0,147	0,092	0,196	0,157	0,098	●	○	○
P.1.5	0,140	0,112	0,070	0,162	0,130	0,081	0,173	0,138	0,087	0,184	0,147	0,092	0,196	0,157	0,098	●	○	○
P.2.1	0,140	0,112	0,070	0,162	0,130	0,081	0,173	0,138	0,087	0,184	0,147	0,092	0,196	0,157	0,098	●	○	○
P.2.2	0,120	0,096	0,060	0,140	0,112	0,070	0,150	0,120	0,075	0,160	0,128	0,080	0,170	0,136	0,085	●	○	○
P.2.3	0,140	0,112	0,070	0,162	0,130	0,081	0,173	0,138	0,087	0,184	0,147	0,092	0,196	0,157	0,098	●	○	○
P.2.4	0,120	0,096	0,060	0,140	0,112	0,070	0,150	0,120	0,075	0,160	0,128	0,080	0,170	0,136	0,085	●	○	○
P.3.1	0,140	0,112	0,070	0,162	0,130	0,081	0,173	0,138	0,087	0,184	0,147	0,092	0,196	0,157	0,098	●	○	○
P.3.2	0,140	0,112	0,070	0,162	0,130	0,081	0,173	0,138	0,087	0,184	0,147	0,092	0,196	0,157	0,098	●	○	○
P.3.3	0,140	0,112	0,070	0,162	0,130	0,081	0,173	0,138	0,087	0,184	0,147	0,092	0,196	0,157	0,098	●	○	○
P.4.1	0,080	0,064	0,040	0,094	0,075	0,047	0,101	0,081	0,051	0,108	0,086	0,054	0,115	0,092	0,058	●		
P.4.2	0,080	0,064	0,040	0,094	0,075	0,047	0,101	0,081	0,051	0,108	0,086	0,054	0,115	0,092	0,058	●		
M.1.1	0,080	0,064	0,040	0,094	0,075	0,047	0,101	0,081	0,051	0,108	0,086	0,054	0,115	0,092	0,058	●		
M.2.1	0,080	0,064	0,040	0,094	0,075	0,047	0,101	0,081	0,051	0,108	0,086	0,054	0,115	0,092	0,058	●		
M.3.1	0,080	0,064	0,040	0,094	0,075	0,047	0,101	0,081	0,051	0,108	0,086	0,054	0,115	0,092	0,058	●		
K.1.1	0,192	0,154	0,096	0,224	0,179	0,112	0,240	0,192	0,120	0,258	0,206	0,129	0,274	0,219	0,137	●	●	●
K.1.2	0,192	0,154	0,096	0,224	0,179	0,112	0,240	0,192	0,120	0,258	0,206	0,129	0,274	0,219	0,137	●	●	●
K.2.1	0,140	0,112	0,070	0,162	0,130	0,081	0,173	0,138	0,087	0,184	0,147	0,092	0,196	0,157	0,098	●	●	●
K.2.2	0,140	0,112	0,070	0,162	0,130	0,081	0,173	0,138	0,087	0,184	0,147	0,092	0,196	0,157	0,098	●	●	●
K.3.1	0,140	0,112	0,070	0,162	0,130	0,081	0,173	0,138	0,087	0,184	0,147	0,092	0,196	0,157	0,098	●	●	●
K.3.2	0,140	0,112	0,070	0,162	0,130	0,081	0,173	0,138	0,087	0,184	0,147	0,092	0,196	0,157	0,098	●	●	●
N.1.1																		
N.1.2																		
N.2.1																		
N.2.2																		
N.2.3																		
N.3.1	0,192	0,154	0,096	0,224	0,179	0,112	0,240	0,192	0,120	0,258	0,206	0,129	0,274	0,219	0,137	●		
N.3.2	0,192	0,154	0,096	0,224	0,179	0,112	0,240	0,192	0,120	0,258	0,206	0,129	0,274	0,219	0,137	●		
N.3.3	0,192	0,154	0,096	0,224	0,179	0,112	0,240	0,192	0,120	0,258	0,206	0,129	0,274	0,219	0,137	●		
N.4.1																		
S.1.1	0,060	0,048	0,030	0,070	0,056	0,035	0,075	0,060	0,038	0,079	0,063	0,040	0,084	0,067	0,042	●		
S.1.2	0,060	0,048	0,030	0,070	0,056	0,035	0,075	0,060	0,038	0,079	0,063	0,040	0,084	0,067	0,042	●		
S.2.1	0,060	0,048	0,030	0,070	0,056	0,035	0,075	0,060	0,038	0,079	0,063	0,040	0,084	0,067	0,042	●		
S.2.2	0,060	0,048	0,030	0,070	0,056	0,035	0,075	0,060	0,038	0,079	0,063	0,040	0,084	0,067	0,042	●		
S.2.3	0,060	0,048	0,030	0,070	0,056	0,035	0,075	0,060	0,038	0,079	0,063	0,040	0,084	0,067	0,042	●		
S.3.1	0,120	0,096	0,060	0,140	0,112	0,070	0,150	0,120	0,075	0,160	0,128	0,080	0,170	0,136	0,085	●		
S.3.2	0,080	0,064	0,040	0,094	0,075	0,047	0,101	0,081	0,051	0,108	0,086	0,054	0,115	0,092	0,058	●		
S.3.3																		
H.1.1																		
H.1.2																		
H.1.3																		
H.1.4																		
H.2.1																		
H.3.1																		
O.1.1																		
O.1.2																		
O.2.1																		
O.2.2																		
O.3.1																		

Cutting data standard values – SilverLine – High-precision finish milling cutter

Index	Type long v_c (m/min)	Type extra long	$a_{p,max.} \times DC$	50 991 ...							● 1st choice ○ suitable		
				$\varnothing DC$ (mm) =							Emulsion	Compressed air	MMS
				6	8	10	12	16	20	25			
				a_e 0,05 $\times DC$ f_z (mm)									
P.1.1	260	180	2,0	0,030	0,040	0,050	0,060	0,075	0,085	0,098	●		
P.1.2	250	175	2,0	0,030	0,040	0,050	0,060	0,075	0,085	0,098	●		
P.1.3	250	175	2,0	0,030	0,040	0,050	0,060	0,075	0,085	0,098	●		
P.1.4	230	160	2,0	0,030	0,040	0,050	0,060	0,075	0,085	0,098	●		
P.1.5	230	160	2,0	0,030	0,040	0,050	0,060	0,075	0,085	0,098	●		
P.2.1	250	175	2,0	0,030	0,040	0,050	0,060	0,075	0,085	0,098	●		
P.2.2	230	160	2,0	0,023	0,031	0,039	0,047	0,059	0,067	0,077	●		
P.2.3	220	155	2,0	0,030	0,040	0,050	0,060	0,075	0,085	0,098	●		
P.2.4	210	145	2,0	0,023	0,031	0,039	0,047	0,059	0,067	0,077	●		
P.3.1	220	155	2,0	0,030	0,040	0,050	0,060	0,075	0,085	0,098	●		
P.3.2	210	145	2,0	0,030	0,040	0,050	0,060	0,075	0,085	0,098	●		
P.3.3	175	120	2,0	0,030	0,040	0,050	0,060	0,075	0,085	0,098	●		
P.4.1	120	80	2,0	0,019	0,026	0,033	0,040	0,051	0,058	0,066	●		
P.4.2	100	70	2,0	0,019	0,026	0,033	0,040	0,051	0,058	0,066	●		
M.1.1	120	80	2,0	0,019	0,026	0,033	0,040	0,051	0,058	0,066	●		
M.2.1	120	80	2,0	0,019	0,026	0,033	0,040	0,051	0,058	0,066	●		
M.3.1	120	80	2,0	0,019	0,026	0,033	0,040	0,051	0,058	0,066	●		
K.1.1	250	175	2,0	0,035	0,047	0,058	0,070	0,087	0,098	0,112	●		
K.1.2	220	155	2,0	0,035	0,047	0,058	0,070	0,087	0,098	0,112	●		
K.2.1	230	160	2,0	0,030	0,040	0,050	0,060	0,075	0,085	0,098	●		
K.2.2	210	145	2,0	0,030	0,040	0,050	0,060	0,075	0,085	0,098	●		
K.3.1	220	155	2,0	0,030	0,040	0,050	0,060	0,075	0,085	0,098	●		
K.3.2	200	140	2,0	0,030	0,040	0,050	0,060	0,075	0,085	0,098	●		
N.1.1													
N.1.2													
N.2.1													
N.2.2													
N.2.3													
N.3.1	430	300	2,0	0,035	0,047	0,058	0,070	0,087	0,098	0,112	●		
N.3.2	430	300	2,0	0,035	0,047	0,058	0,070	0,087	0,098	0,112	●		
N.3.3	350	245	2,0	0,035	0,047	0,058	0,070	0,087	0,098	0,112	●		
N.4.1													
S.1.1	40	30	2,0	0,015	0,020	0,025	0,030	0,038	0,042	0,048	●		
S.1.2	40	30	2,0	0,015	0,020	0,025	0,030	0,038	0,042	0,048	●		
S.2.1	40	30	2,0	0,015	0,020	0,025	0,030	0,038	0,042	0,048	●		
S.2.2	40	30	2,0	0,015	0,020	0,025	0,030	0,038	0,042	0,048	●		
S.2.3	40	30	2,0	0,015	0,020	0,025	0,030	0,038	0,042	0,048	●		
S.3.1	200	140	2,0	0,030	0,040	0,050	0,060	0,075	0,085	0,098	●		
S.3.2	125	85	2,0	0,019	0,026	0,033	0,040	0,051	0,058	0,066	●		
S.3.3													
H.1.1													
H.1.2													
H.1.3													
H.1.4													
H.2.1													
H.3.1													
O.1.1													
O.1.2													
O.2.1													
O.2.2													
O.3.1													

 Plunging angle for ramping and helical milling = 1°

Cutting data standard values – SilverLine – Radius milling cutters – 50 990 ... – Finish machining

Index	Type long		50 990 ...								● 1st choice ○ suitable		
			Ø DC (mm) =								Emulsion	Compressed air	MMS
	v _c (m/min)	a _{p,max.} x DC	4	5	6	8	10	12	16	20			
			$a_a = \frac{0,05}{f_z} \times DC$										
f _z (mm)													
P.1.1	195	0,08	0,019	0,025	0,030	0,040	0,050	0,060	0,075	0,085	●	○	○
P.1.2	165	0,08	0,018	0,023	0,027	0,036	0,045	0,054	0,068	0,077	●	○	○
P.1.3	165	0,08	0,018	0,023	0,027	0,036	0,045	0,054	0,068	0,077	●	○	○
P.1.4	145	0,08	0,018	0,023	0,027	0,036	0,045	0,054	0,068	0,077	●	○	○
P.1.5	145	0,08	0,018	0,023	0,027	0,036	0,045	0,054	0,068	0,077	●	○	○
P.2.1	165	0,08	0,018	0,023	0,027	0,036	0,045	0,054	0,068	0,077	●	○	○
P.2.2	130	0,08	0,018	0,023	0,027	0,036	0,045	0,054	0,068	0,077	●	○	○
P.2.3	130	0,08	0,018	0,023	0,027	0,036	0,045	0,054	0,068	0,077	●	○	○
P.2.4	100	0,08	0,018	0,023	0,027	0,036	0,045	0,054	0,068	0,077	●	○	○
P.3.1													
P.3.2													
P.3.3													
P.4.1	90	0,08	0,011	0,014	0,017	0,023	0,029	0,035	0,044	0,050	●		
P.4.2	75	0,08	0,011	0,014	0,017	0,023	0,029	0,035	0,044	0,050	●		
M.1.1	75	0,08	0,011	0,014	0,017	0,023	0,029	0,035	0,044	0,050	●		
M.2.1	90	0,08	0,011	0,014	0,017	0,023	0,029	0,035	0,044	0,050	●		
M.3.1	90	0,08	0,011	0,014	0,017	0,023	0,029	0,035	0,044	0,050	●		
K.1.1	235	0,08	0,028	0,034	0,040	0,053	0,065	0,077	0,096	0,108	●		○
K.1.2	220	0,08	0,028	0,034	0,040	0,053	0,065	0,077	0,096	0,108	●		○
K.2.1	235	0,08	0,028	0,033	0,039	0,050	0,061	0,072	0,089	0,100	●		○
K.2.2	220	0,08	0,028	0,033	0,039	0,050	0,061	0,072	0,089	0,100	●		○
K.3.1	235	0,08	0,028	0,034	0,040	0,053	0,065	0,077	0,096	0,108	●		○
K.3.2	220	0,08	0,028	0,034	0,040	0,053	0,065	0,077	0,096	0,108	●		○
N.1.1													
N.1.2													
N.2.1													
N.2.2													
N.2.3													
N.3.1	360	0,08	0,028	0,034	0,040	0,053	0,065	0,077	0,096	0,108	●	○	○
N.3.2	360	0,08	0,028	0,034	0,040	0,053	0,065	0,077	0,096	0,108	●	○	○
N.3.3	255	0,08	0,028	0,034	0,040	0,053	0,065	0,077	0,096	0,108	●	○	○
N.4.1													
S.1.1													
S.1.2													
S.2.1													
S.2.2													
S.2.3													
S.3.1													
S.3.2													
S.3.3													
H.1.1													
H.1.2													
H.1.3													
H.1.4													
H.2.1													
H.3.1													
O.1.1													
O.1.2													
O.2.1													
O.2.2													
O.3.1													

Cutting data standard values – SilverLine – Radius milling cutters – 50 990 ... – Rough machining

Index	Type long v_c (m/min) $a_{p,max.} \times DC$		50 990 ...																	
			$\varnothing DC$ (mm) =																	
			4			5			6			8			10			12		
			a_e 0,1–0,2 x DC	a_e 0,3–0,4 x DC	a_e 0,6–1,0 x DC	a_e 0,1–0,2 x DC	a_e 0,3–0,4 x DC	a_e 0,6–1,0 x DC	a_e 0,1–0,2 x DC	a_e 0,3–0,4 x DC	a_e 0,6–1,0 x DC	a_e 0,1–0,2 x DC	a_e 0,3–0,4 x DC	a_e 0,6–1,0 x DC	a_e 0,1–0,2 x DC	a_e 0,3–0,4 x DC	a_e 0,6–1,0 x DC	a_e 0,1–0,2 x DC	a_e 0,3–0,4 x DC	a_e 0,6–1,0 x DC
f_z (mm)																				
P.1.1	130	1,0	0,026	0,022	0,017	0,031	0,027	0,021	0,036	0,031	0,024	0,047	0,040	0,031	0,056	0,049	0,038	0,067	0,058	0,045
P.1.2	110	1,0	0,021	0,018	0,014	0,026	0,022	0,017	0,031	0,027	0,021	0,041	0,035	0,027	0,050	0,043	0,033	0,059	0,051	0,040
P.1.3	110	1,0	0,021	0,018	0,014	0,026	0,022	0,017	0,031	0,027	0,021	0,041	0,035	0,027	0,050	0,043	0,033	0,059	0,051	0,040
P.1.4	95	1,0	0,021	0,018	0,014	0,026	0,022	0,017	0,031	0,027	0,021	0,041	0,035	0,027	0,050	0,043	0,033	0,059	0,051	0,040
P.1.5	95	1,0	0,021	0,018	0,014	0,026	0,022	0,017	0,031	0,027	0,021	0,041	0,035	0,027	0,050	0,043	0,033	0,059	0,051	0,040
P.2.1	110	1,0	0,021	0,018	0,014	0,026	0,022	0,017	0,031	0,027	0,021	0,041	0,035	0,027	0,050	0,043	0,033	0,059	0,051	0,040
P.2.2	85	1,0	0,021	0,018	0,014	0,026	0,022	0,017	0,031	0,027	0,021	0,041	0,035	0,027	0,050	0,043	0,033	0,059	0,051	0,040
P.2.3	85	1,0	0,021	0,018	0,014	0,026	0,022	0,017	0,031	0,027	0,021	0,041	0,035	0,027	0,050	0,043	0,033	0,059	0,051	0,040
P.2.4	65	1,0	0,021	0,018	0,014	0,026	0,022	0,017	0,031	0,027	0,021	0,041	0,035	0,027	0,050	0,043	0,033	0,059	0,051	0,040
P.3.1																				
P.3.2																				
P.3.3																				
P.4.1	60	1,0	0,015	0,013	0,010	0,019	0,016	0,013	0,023	0,020	0,015	0,030	0,026	0,020	0,038	0,033	0,025	0,045	0,039	0,030
P.4.2	50	1,0	0,015	0,013	0,010	0,019	0,016	0,013	0,023	0,020	0,015	0,030	0,026	0,020	0,038	0,033	0,025	0,045	0,039	0,030
M.1.1	50	1,0	0,015	0,013	0,010	0,019	0,016	0,013	0,023	0,020	0,015	0,030	0,026	0,020	0,038	0,033	0,025	0,045	0,039	0,030
M.2.1	60	1,0	0,015	0,013	0,010	0,019	0,016	0,013	0,023	0,020	0,015	0,030	0,026	0,020	0,038	0,033	0,025	0,045	0,039	0,030
M.3.1	60	1,0	0,015	0,013	0,010	0,019	0,016	0,013	0,023	0,020	0,015	0,030	0,026	0,020	0,038	0,033	0,025	0,045	0,039	0,030
K.1.1	155	1,0	0,042	0,036	0,028	0,050	0,043	0,033	0,059	0,051	0,039	0,075	0,065	0,050	0,092	0,079	0,061	0,108	0,094	0,072
K.1.2	145	1,0	0,042	0,036	0,028	0,050	0,043	0,033	0,059	0,051	0,039	0,075	0,065	0,050	0,092	0,079	0,061	0,108	0,094	0,072
K.2.1	155	1,0	0,032	0,027	0,021	0,038	0,033	0,025	0,044	0,038	0,029	0,054	0,047	0,036	0,065	0,056	0,043	0,077	0,066	0,051
K.2.2	145	1,0	0,032	0,027	0,021	0,038	0,033	0,025	0,044	0,038	0,029	0,054	0,047	0,036	0,065	0,056	0,043	0,077	0,066	0,051
K.3.1	155	1,0	0,042	0,036	0,028	0,050	0,043	0,033	0,059	0,051	0,039	0,075	0,065	0,050	0,092	0,079	0,061	0,108	0,094	0,072
K.3.2	145	1,0	0,042	0,036	0,028	0,050	0,043	0,033	0,059	0,051	0,039	0,075	0,065	0,050	0,092	0,079	0,061	0,108	0,094	0,072
N.1.1																				
N.1.2																				
N.2.1																				
N.2.2																				
N.2.3																				
N.3.1	240	1,0	0,032	0,028	0,022	0,041	0,035	0,027	0,050	0,043	0,033	0,066	0,057	0,044	0,083	0,072	0,055	0,099	0,086	0,066
N.3.2	240	1,0	0,032	0,028	0,022	0,041	0,035	0,027	0,050	0,043	0,033	0,066	0,057	0,044	0,083	0,072	0,055	0,099	0,086	0,066
N.3.3	170	1,0	0,032	0,028	0,022	0,041	0,035	0,027	0,050	0,043	0,033	0,066	0,057	0,044	0,083	0,072	0,055	0,099	0,086	0,066
N.4.1																				
S.1.1																				
S.1.2																				
S.2.1																				
S.2.2																				
S.2.3																				
S.3.1																				
S.3.2																				
S.3.3																				
H.1.1																				
H.1.2																				
H.1.3																				
H.1.4																				
H.2.1																				
H.3.1																				
O.1.1																				
O.1.2																				
O.2.1																				
O.2.2																				
O.3.1																				

Index	50 990 ...						● 1st choice ○ suitable		
	Ø DC (mm) =						Emulsion	Compressed air	MMS
	16			20					
	a_e 0,1-0,2 x DC	a_e 0,3-0,4 x DC	a_e 0,6-1,0 x DC	a_e 0,1-0,2 x DC	a_e 0,3-0,4 x DC	a_e 0,6-1,0 x DC			
f_z (mm)									
P.1.1	0,083	0,072	0,055	0,092	0,080	0,062	●	○	○
P.1.2	0,074	0,064	0,050	0,083	0,072	0,056	●	○	○
P.1.3	0,074	0,064	0,050	0,083	0,072	0,056	●	○	○
P.1.4	0,074	0,064	0,050	0,083	0,072	0,056	●	○	○
P.1.5	0,074	0,064	0,050	0,083	0,072	0,056	●	○	○
P.2.1	0,074	0,064	0,050	0,083	0,072	0,056	●	○	○
P.2.2	0,074	0,064	0,050	0,083	0,072	0,056	●	○	○
P.2.3	0,074	0,064	0,050	0,083	0,072	0,056	●	○	○
P.2.4	0,074	0,064	0,050	0,083	0,072	0,056	●	○	○
P.3.1									
P.3.2									
P.3.3									
P.4.1	0,056	0,049	0,038	0,063	0,055	0,042	●		
P.4.2	0,056	0,049	0,038	0,063	0,055	0,042	●		
M.1.1	0,056	0,049	0,038	0,063	0,055	0,042	●		
M.2.1	0,056	0,049	0,038	0,063	0,055	0,042	●		
M.3.1	0,056	0,049	0,038	0,063	0,055	0,042	●		
K.1.1	0,133	0,115	0,089	0,150	0,130	0,100	●	○	○
K.1.2	0,133	0,115	0,089	0,150	0,130	0,100	●	○	○
K.2.1	0,093	0,081	0,062	0,104	0,090	0,070	●	○	○
K.2.2	0,093	0,081	0,062	0,104	0,090	0,070	●	○	○
K.3.1	0,133	0,115	0,089	0,150	0,130	0,100	●	○	○
K.3.2	0,133	0,115	0,089	0,150	0,130	0,100	●	○	○
N.1.1									
N.1.2									
N.2.1									
N.2.2									
N.2.3									
N.3.1	0,125	0,108	0,083	0,141	0,122	0,094	●	○	○
N.3.2	0,125	0,108	0,083	0,141	0,122	0,094	●	○	○
N.3.3	0,125	0,108	0,083	0,141	0,122	0,094	●	○	○
N.4.1									
S.1.1									
S.1.2									
S.2.1									
S.2.2									
S.2.3									
S.3.1									
S.3.2									
S.3.3									
H.1.1									
H.1.2									
H.1.3									
H.1.4									
H.2.1									
H.3.1									
O.1.1									
O.1.2									
O.2.1									
O.2.2									
O.3.1									

Cutting data standard values – SilverLine – Ball-nosed end mill

Index	Type short		Type long		50 963 ...																	
	v _c (m/min)	a _{p,max} x DC	v _c (m/min)	a _{p,max} x DC	Ø DC (mm) =																	
					3			4			5			6			7			8		
					a _e x DC																	
					0,01-0,02	0,03-0,04	0,05	0,01-0,02	0,03-0,04	0,05	0,01-0,02	0,03-0,04	0,05	0,01-0,02	0,03-0,04	0,05	0,01-0,02	0,03-0,04	0,05	0,01-0,02	0,03-0,04	0,05
f _z (mm)																						
P.1.1	300	0,08	180	0,06	0,072	0,058	0,036	0,094	0,075	0,047	0,118	0,094	0,059	0,142	0,114	0,071	0,166	0,133	0,083	0,190	0,152	0,095
P.1.2	280	0,08	170	0,06	0,072	0,058	0,036	0,094	0,075	0,047	0,118	0,094	0,059	0,142	0,114	0,071	0,166	0,133	0,083	0,190	0,152	0,095
P.1.3	225	0,08	135	0,06	0,072	0,058	0,036	0,094	0,075	0,047	0,118	0,094	0,059	0,142	0,114	0,071	0,166	0,133	0,083	0,190	0,152	0,095
P.1.4	225	0,08	135	0,06	0,072	0,058	0,036	0,094	0,075	0,047	0,118	0,094	0,059	0,142	0,114	0,071	0,166	0,133	0,083	0,190	0,152	0,095
P.1.5	245	0,08	145	0,06	0,072	0,058	0,036	0,094	0,075	0,047	0,118	0,094	0,059	0,142	0,114	0,071	0,166	0,133	0,083	0,190	0,152	0,095
P.2.1	280	0,08	170	0,06	0,072	0,058	0,036	0,094	0,075	0,047	0,118	0,094	0,059	0,142	0,114	0,071	0,166	0,133	0,083	0,190	0,152	0,095
P.2.2	215	0,08	130	0,06	0,058	0,046	0,029	0,076	0,061	0,038	0,092	0,074	0,046	0,110	0,088	0,055	0,128	0,102	0,064	0,146	0,117	0,073
P.2.3	190	0,08	115	0,06	0,072	0,058	0,036	0,094	0,075	0,047	0,118	0,094	0,059	0,142	0,114	0,071	0,166	0,133	0,083	0,190	0,152	0,095
P.2.4	210	0,08	125	0,06	0,072	0,058	0,036	0,094	0,075	0,047	0,118	0,094	0,059	0,142	0,114	0,071	0,166	0,133	0,083	0,190	0,152	0,095
P.3.1	210	0,08	125	0,06	0,072	0,058	0,036	0,094	0,075	0,047	0,118	0,094	0,059	0,142	0,114	0,071	0,166	0,133	0,083	0,190	0,152	0,095
P.3.2	175	0,08	105	0,06	0,058	0,046	0,029	0,076	0,061	0,038	0,092	0,074	0,046	0,110	0,088	0,055	0,128	0,102	0,064	0,146	0,117	0,073
P.3.3	130	0,08	80	0,06	0,046	0,037	0,023	0,058	0,046	0,029	0,068	0,054	0,034	0,080	0,064	0,040	0,091	0,073	0,046	0,102	0,082	0,051
P.4.1																						
P.4.2																						
M.1.1																						
M.2.1																						
M.3.1																						
K.1.1	330	0,08	200	0,06	0,072	0,058	0,036	0,094	0,075	0,047	0,118	0,094	0,059	0,142	0,114	0,071	0,166	0,133	0,083	0,190	0,152	0,095
K.1.2	280	0,08	170	0,06	0,072	0,058	0,036	0,094	0,075	0,047	0,118	0,094	0,059	0,142	0,114	0,071	0,166	0,133	0,083	0,190	0,152	0,095
K.2.1	330	0,08	200	0,06	0,072	0,058	0,036	0,094	0,075	0,047	0,118	0,094	0,059	0,142	0,114	0,071	0,166	0,133	0,083	0,190	0,152	0,095
K.2.2	280	0,08	170	0,06	0,058	0,046	0,029	0,076	0,061	0,038	0,092	0,074	0,046	0,110	0,088	0,055	0,128	0,102	0,064	0,146	0,117	0,073
K.3.1	330	0,08	200	0,06	0,072	0,058	0,036	0,094	0,075	0,047	0,118	0,094	0,059	0,142	0,114	0,071	0,166	0,133	0,083	0,190	0,152	0,095
K.3.2	280	0,08	170	0,06	0,058	0,046	0,029	0,076	0,061	0,038	0,092	0,074	0,046	0,110	0,088	0,055	0,128	0,102	0,064	0,146	0,117	0,073
N.1.1																						
N.1.2																						
N.2.1																						
N.2.2																						
N.2.3																						
N.3.1																						
N.3.2																						
N.3.3	455	0,08	275	0,06	0,046	0,037	0,023	0,058	0,046	0,029	0,068	0,054	0,034	0,080	0,064	0,040	0,091	0,073	0,046	0,102	0,082	0,051
N.4.1																						
S.1.1																						
S.1.2																						
S.2.1																						
S.2.2																						
S.2.3																						
S.3.1																						
S.3.2																						
S.3.3																						
H.1.1	100	0,08	60	0,06	0,046	0,037	0,023	0,058	0,046	0,029	0,068	0,054	0,034	0,080	0,064	0,040	0,091	0,073	0,046	0,102	0,082	0,051
H.1.2	60	0,08	35	0,06	0,046	0,037	0,023	0,058	0,046	0,029	0,068	0,054	0,034	0,080	0,064	0,040	0,091	0,073	0,046	0,102	0,082	0,051
H.1.3	55	0,08	35	0,06	0,046	0,037	0,023	0,058	0,046	0,029	0,068	0,054	0,034	0,080	0,064	0,040	0,091	0,073	0,046	0,102	0,082	0,051
H.1.4																						
H.2.1	70	0,08	40	0,06	0,046	0,037	0,023	0,058	0,046	0,029	0,068	0,054	0,034	0,080	0,064	0,040	0,091	0,073	0,046	0,102	0,082	0,051
H.3.1	100	0,08	60	0,06	0,046	0,037	0,023	0,058	0,046	0,029	0,068	0,054	0,034	0,080	0,064	0,040	0,091	0,073	0,046	0,102	0,082	0,051
O.1.1																						
O.1.2																						
O.2.1																						
O.2.2																						
O.3.1																						

Index	50 963 ...																		● 1st choice		
	Ø DC (mm) =																		○ suitable		
	10			12			14			16			18			20			Emulsion	Compressed air	MMS
	a _e x DC																				
0,01-0,02	0,03-0,04	0,05	0,01-0,02	0,03-0,04	0,05	0,01-0,02	0,03-0,04	0,05	0,01-0,02	0,03-0,04	0,05	0,01-0,02	0,03-0,04	0,05	0,01-0,02	0,03-0,04	0,05	0,01-0,02	0,03-0,04	0,05	
f _t (mm)																					
P.1.1	0,238	0,190	0,119	0,286	0,229	0,143	0,334	0,267	0,167	0,400	0,320	0,200	0,450	0,360	0,225	0,500	0,400	0,250	●	○	○
P.1.2	0,238	0,190	0,119	0,286	0,229	0,143	0,334	0,267	0,167	0,400	0,320	0,200	0,450	0,360	0,225	0,500	0,400	0,250	●	○	○
P.1.3	0,238	0,190	0,119	0,286	0,229	0,143	0,334	0,267	0,167	0,400	0,320	0,200	0,450	0,360	0,225	0,500	0,400	0,250	●	○	○
P.1.4	0,238	0,190	0,119	0,286	0,229	0,143	0,334	0,267	0,167	0,400	0,320	0,200	0,450	0,360	0,225	0,500	0,400	0,250	●	○	○
P.1.5	0,238	0,190	0,119	0,286	0,229	0,143	0,334	0,267	0,167	0,400	0,320	0,200	0,450	0,360	0,225	0,500	0,400	0,250	●	○	○
P.2.1	0,238	0,190	0,119	0,286	0,229	0,143	0,334	0,267	0,167	0,400	0,320	0,200	0,450	0,360	0,225	0,500	0,400	0,250	●	○	○
P.2.2	0,180	0,144	0,090	0,216	0,173	0,108	0,250	0,200	0,125	0,300	0,240	0,150	0,350	0,280	0,175	0,400	0,320	0,200	●	○	○
P.2.3	0,238	0,190	0,119	0,286	0,229	0,143	0,334	0,267	0,167	0,400	0,320	0,200	0,450	0,360	0,225	0,500	0,400	0,250	●	○	○
P.2.4	0,238	0,190	0,119	0,286	0,229	0,143	0,334	0,267	0,167	0,400	0,320	0,200	0,450	0,360	0,225	0,500	0,400	0,250	●	○	○
P.3.1	0,238	0,190	0,119	0,286	0,229	0,143	0,334	0,267	0,167	0,400	0,320	0,200	0,450	0,360	0,225	0,500	0,400	0,250	●	○	○
P.3.2	0,180	0,144	0,090	0,216	0,173	0,108	0,250	0,200	0,125	0,300	0,240	0,150	0,350	0,280	0,175	0,400	0,320	0,200	●	○	○
P.3.3	0,124	0,099	0,062	0,146	0,117	0,073	0,168	0,134	0,084	0,180	0,144	0,090	0,210	0,168	0,105	0,240	0,192	0,120	●	○	○
P.4.1																					
P.4.2																					
M.1.1																					
M.2.1																					
M.3.1																					
K.1.1	0,238	0,190	0,119	0,286	0,229	0,143	0,334	0,267	0,167	0,400	0,320	0,200	0,450	0,360	0,225	0,500	0,400	0,250	●	○	○
K.1.2	0,238	0,190	0,119	0,286	0,229	0,143	0,334	0,267	0,167	0,400	0,320	0,200	0,450	0,360	0,225	0,500	0,400	0,250	●	○	○
K.2.1	0,238	0,190	0,119	0,286	0,229	0,143	0,334	0,267	0,167	0,400	0,320	0,200	0,450	0,360	0,225	0,500	0,400	0,250	●	○	○
K.2.2	0,180	0,144	0,090	0,216	0,173	0,108	0,250	0,200	0,125	0,300	0,240	0,150	0,350	0,280	0,175	0,400	0,320	0,200	●	○	○
K.3.1	0,238	0,190	0,119	0,286	0,229	0,143	0,334	0,267	0,167	0,400	0,320	0,200	0,450	0,360	0,225	0,500	0,400	0,250	●	○	○
K.3.2	0,180	0,144	0,090	0,216	0,173	0,108	0,250	0,200	0,125	0,300	0,240	0,150	0,350	0,280	0,175	0,400	0,320	0,200	●	○	○
N.1.1																					
N.1.2																					
N.2.1																					
N.2.2																					
N.2.3																					
N.3.1																					
N.3.2																					
N.3.3	0,124	0,099	0,062	0,146	0,117	0,073	0,168	0,134	0,084	0,180	0,144	0,090	0,210	0,168	0,105	0,240	0,192	0,120	●		
N.4.1																					
S.1.1																					
S.1.2																					
S.2.1																					
S.2.2																					
S.2.3																					
S.3.1																					
S.3.2																					
S.3.3																					
H.1.1	0,124	0,099	0,062	0,146	0,117	0,073	0,168	0,134	0,084	0,179	0,143	0,090	0,190	0,152	0,095	0,200	0,160	0,100		●	
H.1.2	0,124	0,099	0,062	0,146	0,117	0,073	0,168	0,134	0,084	0,179	0,143	0,090	0,190	0,152	0,095	0,200	0,160	0,100		●	
H.1.3	0,124	0,099	0,062	0,146	0,117	0,073	0,168	0,134	0,084	0,179	0,143	0,090	0,190	0,152	0,095	0,200	0,160	0,100		●	
H.1.4																					
H.2.1	0,124	0,099	0,062	0,146	0,117	0,073	0,168	0,134	0,084	0,179	0,143	0,090	0,190	0,152	0,095	0,200	0,160	0,100		●	
H.3.1	0,124	0,099	0,062	0,146	0,117	0,073	0,168	0,134	0,084	0,179	0,143	0,090	0,190	0,152	0,095	0,200	0,160	0,100		●	
O.1.1																					
O.1.2																					
O.2.1																					
O.2.2																					
O.3.1																					

Cutting data standard values – SilverLine – Torus face cutter

Index	Type long v _c (m/min)	Type extra long a _{p max} x DC	50 989 ...															
			Ø DC (mm) =															
			6			8			10			12			16			
			a _e 0,1–0,2 x DC	a _e 0,3–0,4 x DC	a _e 0,5 x DC	a _e 0,1–0,2 x DC	a _e 0,3–0,4 x DC	a _e 0,5 x DC	a _e 0,1–0,2 x DC	a _e 0,3–0,4 x DC	a _e 0,5 x DC	a _e 0,1–0,2 x DC	a _e 0,3–0,4 x DC	a _e 0,5 x DC	a _e 0,1–0,2 x DC	a _e 0,3–0,4 x DC	a _e 0,5 x DC	
f _z (mm)																		
P.1.1	240	190	0,03	0,360	0,288	0,180	0,460	0,368	0,230	0,560	0,448	0,280	0,660	0,528	0,330	0,814	0,651	0,407
P.1.2	210	170	0,03	0,360	0,288	0,180	0,460	0,368	0,230	0,560	0,448	0,280	0,660	0,528	0,330	0,814	0,651	0,407
P.1.3	210	170	0,03	0,360	0,288	0,180	0,460	0,368	0,230	0,560	0,448	0,280	0,660	0,528	0,330	0,814	0,651	0,407
P.1.4	190	150	0,03	0,360	0,288	0,180	0,460	0,368	0,230	0,560	0,448	0,280	0,660	0,528	0,330	0,814	0,651	0,407
P.1.5	190	150	0,03	0,360	0,288	0,180	0,460	0,368	0,230	0,560	0,448	0,280	0,660	0,528	0,330	0,814	0,651	0,407
P.2.1	220	175	0,03	0,360	0,288	0,180	0,460	0,368	0,230	0,560	0,448	0,280	0,660	0,528	0,330	0,814	0,651	0,407
P.2.2	200	160	0,03	0,360	0,288	0,180	0,460	0,368	0,230	0,560	0,448	0,280	0,660	0,528	0,330	0,814	0,651	0,407
P.2.3	180	145	0,03	0,360	0,288	0,180	0,460	0,368	0,230	0,560	0,448	0,280	0,660	0,528	0,330	0,814	0,651	0,407
P.2.4	170	135	0,03	0,360	0,288	0,180	0,460	0,368	0,230	0,560	0,448	0,280	0,660	0,528	0,330	0,814	0,651	0,407
P.3.1	170	135	0,03	0,360	0,288	0,180	0,460	0,368	0,230	0,560	0,448	0,280	0,660	0,528	0,330	0,814	0,651	0,407
P.3.2	150	120	0,03	0,360	0,288	0,180	0,460	0,368	0,230	0,560	0,448	0,280	0,660	0,528	0,330	0,814	0,651	0,407
P.3.3	120	95	0,03	0,360	0,288	0,180	0,460	0,368	0,230	0,560	0,448	0,280	0,660	0,528	0,330	0,814	0,651	0,407
P.4.1	90	70	0,03	0,360	0,288	0,180	0,460	0,368	0,230	0,560	0,448	0,280	0,660	0,528	0,330	0,814	0,651	0,407
P.4.2	70	55	0,03	0,360	0,288	0,180	0,460	0,368	0,230	0,560	0,448	0,280	0,660	0,528	0,330	0,814	0,651	0,407
M.1.1	90	70	0,03	0,360	0,288	0,180	0,460	0,368	0,230	0,560	0,448	0,280	0,660	0,528	0,330	0,814	0,651	0,407
M.2.1	90	70	0,03	0,360	0,288	0,180	0,460	0,368	0,230	0,560	0,448	0,280	0,660	0,528	0,330	0,814	0,651	0,407
M.3.1	90	70	0,03	0,360	0,288	0,180	0,460	0,368	0,230	0,560	0,448	0,280	0,660	0,528	0,330	0,814	0,651	0,407
K.1.1	250	200	0,03	0,360	0,288	0,180	0,460	0,368	0,230	0,560	0,448	0,280	0,660	0,528	0,330	0,814	0,651	0,407
K.1.2	230	185	0,03	0,360	0,288	0,180	0,460	0,368	0,230	0,560	0,448	0,280	0,660	0,528	0,330	0,814	0,651	0,407
K.2.1	200	160	0,03	0,360	0,288	0,180	0,460	0,368	0,230	0,560	0,448	0,280	0,660	0,528	0,330	0,814	0,651	0,407
K.2.2	180	145	0,03	0,360	0,288	0,180	0,460	0,368	0,230	0,560	0,448	0,280	0,660	0,528	0,330	0,814	0,651	0,407
K.3.1	220	175	0,03	0,360	0,288	0,180	0,460	0,368	0,230	0,560	0,448	0,280	0,660	0,528	0,330	0,814	0,651	0,407
K.3.2	210	170	0,03	0,360	0,288	0,180	0,460	0,368	0,230	0,560	0,448	0,280	0,660	0,528	0,330	0,814	0,651	0,407
N.1.1																		
N.1.2																		
N.2.1																		
N.2.2																		
N.2.3																		
N.3.1																		
N.3.2																		
N.3.3	250	200	0,03	0,360	0,288	0,180	0,460	0,368	0,230	0,560	0,448	0,280	0,660	0,528	0,330	0,814	0,651	0,407
N.4.1																		
S.1.1																		
S.1.2																		
S.2.1																		
S.2.2																		
S.2.3																		
S.3.1																		
S.3.2																		
S.3.3																		
H.1.1	120	95	0,03	0,240	0,192	0,120	0,330	0,264	0,165	0,420	0,336	0,210	0,510	0,408	0,255	0,644	0,515	0,322
H.1.2	80	65	0,03	0,240	0,192	0,120	0,330	0,264	0,165	0,420	0,336	0,210	0,510	0,408	0,255	0,644	0,515	0,322
H.1.3																		
H.1.4																		
H.2.1	120	95	0,03	0,240	0,192	0,120	0,330	0,264	0,165	0,420	0,336	0,210	0,510	0,408	0,255	0,644	0,515	0,322
H.3.1	120	95	0,03	0,240	0,192	0,120	0,330	0,264	0,165	0,420	0,336	0,210	0,510	0,408	0,255	0,644	0,515	0,322
O.1.1																		
O.1.2																		
O.2.1																		
O.2.2																		
O.3.1																		

Index	50 989 ...			● 1st choice ○ suitable		
	Ø DC (mm) = 20			Emulsion	Compressed air	MMS
	a_e 0,1-0,2 x DC	a_e 0,3-0,4 x DC	a_e 0,5 x DC			
f_z (mm)						
P.1.1	0,912	0,730	0,456	●	○	○
P.1.2	0,912	0,730	0,456	●	○	○
P.1.3	0,912	0,730	0,456	●	○	○
P.1.4	0,912	0,730	0,456	●	○	○
P.1.5	0,912	0,730	0,456	●	○	○
P.2.1	0,912	0,730	0,456	●	○	○
P.2.2	0,912	0,730	0,456	●	○	○
P.2.3	0,912	0,730	0,456	●	○	○
P.2.4	0,912	0,730	0,456	●	○	○
P.3.1	0,912	0,730	0,456	●	○	○
P.3.2	0,912	0,730	0,456	●	○	○
P.3.3	0,912	0,730	0,456	●	○	○
P.4.1	0,912	0,730	0,456	●		
P.4.2	0,912	0,730	0,456	●		
M.1.1	0,912	0,730	0,456	●		
M.2.1	0,912	0,730	0,456	●		
M.3.1	0,912	0,730	0,456	●		
K.1.1	0,912	0,730	0,456	●	○	○
K.1.2	0,912	0,730	0,456	●	○	○
K.2.1	0,912	0,730	0,456	●	○	○
K.2.2	0,912	0,730	0,456	●	○	○
K.3.1	0,912	0,730	0,456	●	○	○
K.3.2	0,912	0,730	0,456	●	○	○
N.1.1						
N.1.2						
N.2.1						
N.2.2						
N.2.3						
N.3.1						
N.3.2						
N.3.3	0,912	0,730	0,456	●	○	○
N.4.1						
S.1.1						
S.1.2						
S.2.1						
S.2.2						
S.2.3						
S.3.1						
S.3.2						
S.3.3						
H.1.1	0,736	0,589	0,368		●	●
H.1.2	0,736	0,589	0,368		●	●
H.1.3						
H.1.4						
H.2.1	0,736	0,589	0,368		●	●
H.3.1	0,736	0,589	0,368		●	●
O.1.1						
O.1.2						
O.2.1						
O.2.2						
O.3.1						

Cutting data standard values – S-Cut – End mill, short – long

Index	Type short / long		52 205 ..., 52 223 ..., 52 224 ..., 52 225 ..., 52 228 ...														
			Ø DC (mm) =														
	v _c (m/min)	a _{p max.} x DC	3			4			5			6			8		
			a _s 0,1–0,2 x DC	a _s 0,3–0,4 x DC	a _s 0,6–1,0 x DC	a _s 0,1–0,2 x DC	a _s 0,3–0,4 x DC	a _s 0,6–1,0 x DC	a _s 0,1–0,2 x DC	a _s 0,3–0,4 x DC	a _s 0,6–1,0 x DC	a _s 0,1–0,2 x DC	a _s 0,3–0,4 x DC	a _s 0,6–1,0 x DC	a _s 0,1–0,2 x DC	a _s 0,3–0,4 x DC	a _s 0,6–1,0 x DC
f _z (mm)																	
P.1.1	150	1,0	0,036	0,028	0,020	0,049	0,038	0,028	0,071	0,053	0,036	0,095	0,071	0,047	0,127	0,092	0,069
P.1.2	150	1,0	0,039	0,030	0,022	0,054	0,041	0,030	0,078	0,058	0,039	0,104	0,077	0,052	0,138	0,104	0,069
P.1.3	130	1,0	0,039	0,030	0,022	0,054	0,041	0,030	0,078	0,058	0,039	0,104	0,077	0,052	0,138	0,104	0,069
P.1.4	140	1,0	0,039	0,030	0,022	0,054	0,041	0,030	0,078	0,058	0,039	0,104	0,077	0,052	0,138	0,104	0,069
P.1.5	120	1,0	0,039	0,030	0,022	0,054	0,041	0,030	0,078	0,058	0,039	0,104	0,077	0,052	0,138	0,104	0,069
P.2.1	140	1,0	0,039	0,030	0,022	0,054	0,041	0,030	0,078	0,058	0,039	0,104	0,077	0,052	0,138	0,104	0,069
P.2.2	120	1,0	0,039	0,030	0,022	0,054	0,041	0,030	0,078	0,058	0,039	0,104	0,077	0,052	0,138	0,104	0,069
P.2.3	140	1,0	0,039	0,030	0,022	0,054	0,041	0,030	0,078	0,058	0,039	0,104	0,077	0,052	0,138	0,104	0,069
P.2.4	120	1,0	0,039	0,030	0,022	0,054	0,041	0,030	0,078	0,058	0,039	0,104	0,077	0,052	0,138	0,104	0,069
P.3.1	100	1,0	0,023	0,017	0,013	0,032	0,024	0,017	0,046	0,035	0,023	0,061	0,045	0,030	0,081	0,058	0,046
P.3.2	120	1,0	0,025	0,020	0,015	0,036	0,028	0,021	0,052	0,039	0,026	0,069	0,052	0,035	0,092	0,069	0,046
P.3.3	100	1,0	0,025	0,020	0,015	0,036	0,028	0,021	0,052	0,039	0,026	0,069	0,052	0,035	0,092	0,069	0,046
P.4.1	130	1,0	0,023	0,017	0,013	0,032	0,024	0,017	0,046	0,035	0,023	0,061	0,045	0,030	0,081	0,058	0,046
P.4.2	110	1,0	0,023	0,017	0,013	0,032	0,024	0,017	0,046	0,035	0,023	0,061	0,045	0,030	0,081	0,058	0,046
M.1.1	100	1,0	0,023	0,017	0,013	0,032	0,024	0,017	0,046	0,035	0,023	0,061	0,045	0,030	0,081	0,058	0,046
M.2.1	50	1,0	0,020	0,015	0,012	0,028	0,021	0,015	0,039	0,029	0,020	0,053	0,039	0,026	0,069	0,029	0,035
M.3.1	100	1,0	0,023	0,017	0,013	0,032	0,024	0,017	0,046	0,035	0,023	0,061	0,045	0,030	0,081	0,058	0,046
K.1.1	200	1,0	0,046	0,036	0,025	0,063	0,049	0,036	0,091	0,068	0,046	0,122	0,091	0,061	0,161	0,127	0,081
K.1.2	200	1,0	0,046	0,036	0,025	0,063	0,049	0,036	0,091	0,068	0,046	0,122	0,091	0,061	0,161	0,127	0,081
K.2.1	220	1,0	0,039	0,030	0,022	0,054	0,041	0,030	0,078	0,058	0,039	0,104	0,077	0,052	0,138	0,104	0,069
K.2.2	200	1,0	0,039	0,030	0,022	0,054	0,041	0,030	0,078	0,058	0,039	0,104	0,077	0,052	0,138	0,104	0,069
K.3.1	180	1,0	0,039	0,030	0,022	0,054	0,041	0,030	0,078	0,058	0,039	0,104	0,077	0,052	0,138	0,104	0,069
K.3.2	160	1,0	0,032	0,025	0,018	0,046	0,036	0,025	0,066	0,048	0,032	0,087	0,064	0,044	0,115	0,092	0,058
N.1.1																	
N.1.2																	
N.2.1																	
N.2.2																	
N.2.3																	
N.3.1	250	1,0	0,036	0,028	0,020	0,049	0,038	0,028	0,071	0,053	0,036	0,095	0,071	0,047	0,127	0,092	0,069
N.3.2	250	1,0	0,036	0,028	0,020	0,049	0,038	0,028	0,071	0,053	0,036	0,095	0,071	0,047	0,127	0,092	0,069
N.3.3	250	1,0	0,036	0,028	0,020	0,049	0,038	0,028	0,071	0,053	0,036	0,095	0,071	0,047	0,127	0,092	0,069
N.4.1																	
S.1.1	50	0,5	0,020	0,015	0,012	0,028	0,021	0,015	0,039	0,029	0,020	0,053	0,039	0,026	0,069	0,029	0,035
S.1.2	50	0,5	0,020	0,015	0,012	0,028	0,021	0,015	0,039	0,029	0,020	0,053	0,039	0,026	0,069	0,029	0,035
S.2.1	30	0,5	0,018	0,014	0,010	0,025	0,020	0,014	0,037	0,026	0,018	0,048	0,036	0,024	0,069	0,046	0,035
S.2.2	30	0,5	0,018	0,014	0,010	0,025	0,020	0,014	0,037	0,026	0,018	0,048	0,036	0,024	0,069	0,046	0,035
S.2.3	30	0,5	0,018	0,014	0,010	0,025	0,020	0,014	0,037	0,026	0,018	0,048	0,036	0,024	0,069	0,046	0,035
S.3.1	120	0,5	0,029	0,022	0,016	0,040	0,031	0,023	0,058	0,044	0,029	0,077	0,058	0,039	0,104	0,081	0,058
S.3.2	110	0,5	0,029	0,022	0,016	0,040	0,031	0,022	0,058	0,043	0,029	0,076	0,056	0,038	0,104	0,081	0,058
S.3.3	75	0,5	0,025	0,020	0,015	0,036	0,028	0,021	0,052	0,039	0,026	0,069	0,052	0,035	0,092	0,069	0,046
H.1.1	120	0,5	0,023	0,018	0,013	0,032	0,025	0,018	0,047	0,035	0,023	0,062	0,046	0,031	0,081	0,058	0,046
H.1.2	120	0,3	0,023	0,018	0,013	0,032	0,025	0,018	0,047	0,035	0,023	0,062	0,046	0,031	0,081	0,058	0,046
H.1.3	120	0,2	0,023	0,018	0,013	0,032	0,025	0,018	0,047	0,035	0,023	0,062	0,046	0,031	0,081	0,058	0,046
H.1.4																	
H.2.1																	
H.3.1																	
O.1.1																	
O.1.2																	
O.2.1																	
O.2.2																	
O.3.1																	

With an a_p of 1.5 x DC the f_z should be multiplied by 0.75.
With an a_p of 2.0 x DC the f_z should be multiplied by 0.5.

Plunging angle for ramping and helical milling: 3°

Index	52 205 ..., 52 223 ..., 52 224 ..., 52 225 ..., 52 228 ...															● 1st choice		
	Ø DC (mm) =															○ suitable		
	10			12			16			20			25			Emulsion	Compressed air	MMS
	a_e 0,1-0,2 x DC	a_e 0,3-0,4 x DC	a_e 0,6-1,0 x DC	a_e 0,1-0,2 x DC	a_e 0,3-0,4 x DC	a_e 0,6-1,0 x DC	a_e 0,1-0,2 x DC	a_e 0,3-0,4 x DC	a_e 0,6-1,0 x DC	a_e 0,1-0,2 x DC	a_e 0,3-0,4 x DC	a_e 0,6-1,0 x DC	a_e 0,1-0,2 x DC	a_e 0,3-0,4 x DC	a_e 0,6-1,0 x DC			
f_z (mm)																		
P.1.1	0,161	0,115	0,081	0,173	0,127	0,029	0,184	0,150	0,115	0,230	0,184	0,138	0,292	0,234	0,175	●	○	○
P.1.2	0,173	0,127	0,092	0,196	0,138	0,092	0,207	0,161	0,127	0,242	0,196	0,161	0,307	0,248	0,204	●	○	○
P.1.3	0,173	0,127	0,092	0,196	0,138	0,092	0,207	0,161	0,127	0,242	0,196	0,161	0,307	0,248	0,204	●	○	○
P.1.4	0,173	0,127	0,092	0,196	0,138	0,092	0,207	0,161	0,127	0,242	0,196	0,161	0,307	0,248	0,204	●	○	○
P.1.5	0,173	0,127	0,092	0,196	0,138	0,092	0,207	0,161	0,127	0,242	0,196	0,161	0,307	0,248	0,204	●	○	○
P.2.1	0,173	0,127	0,092	0,196	0,138	0,092	0,207	0,161	0,127	0,242	0,196	0,161	0,307	0,248	0,204	●	○	○
P.2.2	0,173	0,127	0,092	0,196	0,138	0,092	0,207	0,161	0,127	0,242	0,196	0,161	0,307	0,248	0,204	●	○	○
P.2.3	0,173	0,127	0,092	0,196	0,138	0,092	0,207	0,161	0,127	0,242	0,196	0,161	0,307	0,248	0,204	●	○	○
P.2.4	0,173	0,127	0,092	0,196	0,138	0,092	0,207	0,161	0,127	0,242	0,196	0,161	0,307	0,248	0,204	●	○	○
P.3.1	0,104	0,081	0,046	0,115	0,081	0,058	0,115	0,092	0,069	0,150	0,115	0,092	0,190	0,146	0,117	●		
P.3.2	0,115	0,092	0,058	0,127	0,092	0,069	0,138	0,104	0,081	0,161	0,138	0,104	0,204	0,175	0,131	●	○	○
P.3.3	0,115	0,092	0,058	0,127	0,092	0,069	0,138	0,104	0,081	0,161	0,138	0,104	0,204	0,175	0,131	●	○	○
P.4.1	0,104	0,081	0,046	0,115	0,081	0,058	0,115	0,092	0,069	0,150	0,115	0,092	0,190	0,146	0,117	●		
P.4.2	0,104	0,081	0,046	0,115	0,081	0,058	0,115	0,092	0,069	0,150	0,115	0,092	0,190	0,146	0,117	●		
M.1.1	0,104	0,081	0,046	0,115	0,081	0,058	0,115	0,092	0,069	0,150	0,115	0,092	0,190	0,146	0,117	●		
M.2.1	0,092	0,069	0,046	0,092	0,069	0,046	0,104	0,081	0,058	0,127	0,104	0,081	0,161	0,131	0,102	●		
M.3.1	0,104	0,081	0,046	0,115	0,081	0,058	0,115	0,092	0,069	0,150	0,115	0,092	0,190	0,146	0,117	●		
K.1.1	0,207	0,150	0,104	0,219	0,161	0,115	0,242	0,184	0,138	0,288	0,230	0,184	0,365	0,292	0,234	○	●	○
K.1.2	0,207	0,150	0,104	0,219	0,161	0,115	0,242	0,184	0,138	0,288	0,230	0,184	0,365	0,292	0,234	○	●	○
K.2.1	0,173	0,127	0,092	0,196	0,138	0,092	0,207	0,161	0,127	0,242	0,196	0,161	0,307	0,248	0,204	○	●	○
K.2.2	0,173	0,127	0,092	0,196	0,138	0,092	0,207	0,161	0,127	0,242	0,196	0,161	0,307	0,248	0,204	○	●	○
K.3.1	0,173	0,127	0,092	0,196	0,138	0,092	0,207	0,161	0,127	0,242	0,196	0,161	0,307	0,248	0,204	○	●	○
K.3.2	0,150	0,104	0,069	0,161	0,115	0,081	0,173	0,127	0,104	0,207	0,173	0,127	0,263	0,219	0,161	○	●	○
N.1.1																		
N.1.2																		
N.2.1																		
N.2.2																		
N.2.3																		
N.3.1	0,161	0,115	0,081	0,173	0,127	0,092	0,184	0,150	0,127	0,230	0,184	0,138	0,292	0,234	0,175	●		○
N.3.2	0,161	0,115	0,081	0,173	0,127	0,092	0,184	0,150	0,127	0,230	0,184	0,138	0,292	0,234	0,175	●		○
N.3.3	0,161	0,115	0,081	0,173	0,127	0,092	0,184	0,150	0,115	0,230	0,184	0,138	0,292	0,234	0,175	●		○
N.4.1																		
S.1.1	0,092	0,069	0,046	0,092	0,069	0,046	0,104	0,081	0,058	0,127	0,104	0,081	0,161	0,131	0,102	●		
S.1.2	0,092	0,069	0,046	0,092	0,069	0,046	0,104	0,081	0,058	0,127	0,104	0,081	0,161	0,131	0,102	●		
S.2.1	0,081	0,058	0,046	0,092	0,035	0,046	0,092	0,069	0,058	0,115	0,092	0,069	0,146	0,117	0,088	●		
S.2.2	0,081	0,058	0,046	0,092	0,035	0,046	0,092	0,069	0,058	0,115	0,092	0,069	0,146	0,117	0,088	●		
S.2.3	0,081	0,058	0,046	0,092	0,035	0,046	0,092	0,069	0,058	0,115	0,092	0,069	0,146	0,117	0,088	●		
S.3.1	0,127	0,092	0,069	0,138	0,104	0,069	0,150	0,115	0,092	0,184	0,150	0,115	0,234	0,190	0,146	●		
S.3.2	0,127	0,092	0,069	0,138	0,104	0,069	0,150	0,115	0,092	0,184	0,150	0,115	0,234	0,190	0,146	●		
S.3.3	0,115	0,092	0,058	0,127	0,092	0,069	0,138	0,104	0,081	0,161	0,138	0,104	0,204	0,175	0,131	●		
H.1.1	0,104	0,081	0,058	0,115	0,081	0,058	0,127	0,092	0,069	0,150	0,127	0,092	0,190	0,161	0,117		●	
H.1.2	0,104	0,081	0,058	0,115	0,081	0,058	0,127	0,092	0,069	0,150	0,127	0,092	0,190	0,161	0,117		●	
H.1.3	0,104	0,081	0,058	0,115	0,081	0,058	0,127	0,092	0,069	0,150	0,127	0,092	0,190	0,161	0,117		●	
H.1.4																		
H.2.1																		
H.3.1																		
O.1.1																		
O.1.2																		
O.2.1																		
O.2.2																		
O.3.1																		

Cutting data standard values – S-Cut– End mill, extra long

Index	Type extra long v _c (m/min) a _{p,max.} x DC		52 205 ..., 52 226 ..., 52 227 ...															
			Ø DC (mm) =															
			3			4			5			6			8			
			a _s 0,1–0,2 x DC	a _s 0,3–0,4 x DC	a _s 0,6–1,0 x DC	a _s 0,1–0,2 x DC	a _s 0,3–0,4 x DC	a _s 0,6–1,0 x DC	a _s 0,1–0,2 x DC	a _s 0,3–0,4 x DC	a _s 0,6–1,0 x DC	a _s 0,1–0,2 x DC	a _s 0,3–0,4 x DC	a _s 0,6–1,0 x DC	a _s 0,1–0,2 x DC	a _s 0,3–0,4 x DC	a _s 0,6–1,0 x DC	
P.1.1	130	1,0	0,5	0,036	0,028	0,02	0,049	0,038	0,028	0,071	0,053	0,036	0,095	0,071	0,047	0,127	0,092	0,069
P.1.2	120	1,0	0,5	0,039	0,030	0,022	0,054	0,041	0,03	0,078	0,058	0,039	0,104	0,077	0,052	0,138	0,104	0,069
P.1.3	100	1,0	0,5	0,039	0,030	0,022	0,054	0,041	0,03	0,078	0,058	0,039	0,104	0,077	0,052	0,138	0,104	0,069
P.1.4	120	1,0	0,5	0,039	0,030	0,022	0,054	0,041	0,03	0,078	0,058	0,039	0,104	0,077	0,052	0,138	0,104	0,069
P.1.5	100	1,0	0,5	0,039	0,030	0,022	0,054	0,041	0,03	0,078	0,058	0,039	0,104	0,077	0,052	0,138	0,104	0,069
P.2.1	110	1,0	0,5	0,039	0,030	0,022	0,054	0,041	0,03	0,078	0,058	0,039	0,104	0,077	0,052	0,138	0,104	0,069
P.2.2	100	1,0	0,5	0,039	0,030	0,022	0,054	0,041	0,03	0,078	0,058	0,039	0,104	0,077	0,052	0,138	0,104	0,069
P.2.3	100	1,0	0,5	0,039	0,030	0,022	0,054	0,041	0,03	0,078	0,058	0,039	0,104	0,077	0,052	0,138	0,104	0,069
P.2.4	90	1,0	0,5	0,039	0,030	0,022	0,054	0,041	0,03	0,078	0,058	0,039	0,104	0,077	0,052	0,138	0,104	0,069
P.3.1	70	1,0	0,5	0,023	0,017	0,013	0,032	0,024	0,017	0,046	0,035	0,023	0,061	0,045	0,03	0,081	0,058	0,046
P.3.2	100	1,0	0,5	0,025	0,020	0,015	0,036	0,028	0,021	0,052	0,039	0,026	0,069	0,052	0,035	0,092	0,069	0,046
P.3.3	90	1,0	0,5	0,025	0,020	0,015	0,036	0,028	0,021	0,052	0,039	0,026	0,069	0,052	0,035	0,092	0,069	0,046
P.4.1	70	1,0	0,5	0,023	0,017	0,013	0,032	0,024	0,017	0,046	0,035	0,023	0,061	0,045	0,03	0,081	0,058	0,046
P.4.2	60	1,0	0,5	0,023	0,017	0,013	0,032	0,024	0,017	0,046	0,035	0,023	0,061	0,045	0,03	0,081	0,058	0,046
M.1.1	60	1,0	0,5	0,023	0,017	0,013	0,032	0,024	0,017	0,046	0,035	0,023	0,061	0,045	0,03	0,081	0,058	0,046
M.2.1	40	1,0	0,5	0,02	0,015	0,012	0,028	0,021	0,015	0,039	0,029	0,02	0,053	0,039	0,026	0,069	0,029	0,035
M.3.1	60	1,0	0,5	0,023	0,017	0,013	0,032	0,024	0,017	0,046	0,035	0,023	0,061	0,045	0,03	0,081	0,058	0,046
K.1.1	180	1,0	0,5	0,046	0,036	0,025	0,063	0,049	0,036	0,091	0,068	0,046	0,122	0,091	0,061	0,161	0,127	0,081
K.1.2	140	1,0	0,5	0,046	0,036	0,025	0,063	0,049	0,036	0,091	0,068	0,046	0,122	0,091	0,061	0,161	0,127	0,081
K.2.1	180	1,0	0,5	0,039	0,030	0,022	0,054	0,041	0,03	0,078	0,058	0,039	0,104	0,077	0,052	0,138	0,104	0,069
K.2.2	140	1,0	0,5	0,039	0,030	0,022	0,054	0,041	0,03	0,078	0,058	0,039	0,104	0,077	0,052	0,138	0,104	0,069
K.3.1	140	1,0	0,5	0,039	0,030	0,022	0,054	0,041	0,03	0,078	0,058	0,039	0,104	0,077	0,052	0,138	0,104	0,069
K.3.2	120	1,0	0,5	0,032	0,025	0,018	0,046	0,036	0,025	0,066	0,048	0,032	0,087	0,064	0,044	0,115	0,092	0,058
N.1.1																		
N.1.2																		
N.2.1																		
N.2.2																		
N.2.3																		
N.3.1	250	1,0	0,5	0,036	0,028	0,020	0,049	0,038	0,028	0,071	0,053	0,036	0,095	0,071	0,047	0,127	0,092	0,069
N.3.2	250	1,0	0,5	0,036	0,028	0,020	0,049	0,038	0,028	0,071	0,053	0,036	0,095	0,071	0,047	0,127	0,092	0,069
N.3.3	250	1,0	0,5	0,036	0,028	0,020	0,049	0,038	0,028	0,071	0,053	0,036	0,095	0,071	0,047	0,127	0,092	0,069
N.4.1																		
S.1.1	40	0,5	0,25	0,02	0,015	0,012	0,028	0,021	0,015	0,039	0,029	0,02	0,053	0,039	0,026	0,069	0,029	0,035
S.1.2	40	0,5	0,25	0,02	0,015	0,012	0,028	0,021	0,015	0,039	0,029	0,02	0,053	0,039	0,026	0,069	0,029	0,035
S.2.1	25	0,5	0,25	0,018	0,014	0,010	0,025	0,02	0,014	0,037	0,026	0,018	0,048	0,036	0,024	0,069	0,046	0,035
S.2.2	25	0,5	0,25	0,018	0,014	0,010	0,025	0,02	0,014	0,037	0,026	0,018	0,048	0,036	0,024	0,069	0,046	0,035
S.2.3	25	0,5	0,25	0,018	0,014	0,010	0,025	0,02	0,014	0,037	0,026	0,018	0,048	0,036	0,024	0,069	0,046	0,035
S.3.1	50	0,5	0,25	0,029	0,022	0,016	0,040	0,031	0,023	0,058	0,044	0,029	0,077	0,058	0,039	0,104	0,081	0,058
S.3.2	40	0,5	0,25	0,029	0,022	0,016	0,040	0,031	0,022	0,058	0,043	0,029	0,076	0,056	0,038	0,104	0,081	0,058
S.3.3	40	0,5	0,25	0,025	0,020	0,015	0,036	0,028	0,021	0,052	0,039	0,026	0,069	0,052	0,035	0,092	0,069	0,046
H.1.1	100	0,5	0,5	0,023	0,018	0,013	0,032	0,025	0,018	0,047	0,035	0,023	0,062	0,046	0,031	0,081	0,058	0,046
H.1.2	100	0,5	0,3	0,023	0,018	0,013	0,032	0,025	0,018	0,047	0,035	0,023	0,062	0,046	0,031	0,081	0,058	0,046
H.1.3	100	0,5	0,15	0,023	0,018	0,013	0,032	0,025	0,018	0,047	0,035	0,023	0,062	0,046	0,031	0,081	0,058	0,046
H.1.4																		
H.2.1																		
H.3.1																		
O.1.1																		
O.1.2																		
O.2.1																		
O.2.2																		
O.3.1																		



Index	52 205 ..., 52 226 ..., 52 227 ...															● 1st choice		
	Ø DC (mm) =															○ suitable		
	10			12			16			20			25			Emulsion	Compressed air	MMS
	a_p 0,1-0,2 x DC	a_p 0,3-0,4 x DC	a_p 0,6-1,0 x DC	a_p 0,1-0,2 x DC	a_p 0,3-0,4 x DC	a_p 0,6-1,0 x DC	a_p 0,1-0,2 x DC	a_p 0,3-0,4 x DC	a_p 0,6-1,0 x DC	a_p 0,1-0,2 x DC	a_p 0,3-0,4 x DC	a_p 0,6-1,0 x DC	a_p 0,1-0,2 x DC	a_p 0,3-0,4 x DC	a_p 0,6-1,0 x DC			
f_z (mm)																		
P.1.1	0,161	0,115	0,081	0,173	0,127	0,029	0,184	0,15	0,115	0,23	0,184	0,138	0,276	0,23	0,184	●	○	○
P.1.2	0,173	0,127	0,092	0,196	0,138	0,092	0,207	0,161	0,127	0,242	0,196	0,161	0,288	0,242	0,196	●	○	○
P.1.3	0,173	0,127	0,092	0,196	0,138	0,092	0,207	0,161	0,127	0,242	0,196	0,161	0,288	0,242	0,196	●	○	○
P.1.4	0,173	0,127	0,092	0,196	0,138	0,092	0,207	0,161	0,127	0,242	0,196	0,161	0,288	0,242	0,196	●	○	○
P.1.5	0,173	0,127	0,092	0,196	0,138	0,092	0,207	0,161	0,127	0,242	0,196	0,161	0,288	0,242	0,196	●	○	○
P.2.1	0,173	0,127	0,092	0,196	0,138	0,092	0,207	0,161	0,127	0,242	0,196	0,161	0,288	0,242	0,196	●	○	○
P.2.2	0,173	0,127	0,092	0,196	0,138	0,092	0,207	0,161	0,127	0,242	0,196	0,161	0,288	0,242	0,196	●	○	○
P.2.3	0,173	0,127	0,092	0,196	0,138	0,092	0,207	0,161	0,127	0,242	0,196	0,161	0,288	0,242	0,196	●	○	○
P.2.4	0,173	0,127	0,092	0,196	0,138	0,092	0,207	0,161	0,127	0,242	0,196	0,161	0,288	0,242	0,196	●	○	○
P.3.1	0,104	0,081	0,046	0,115	0,081	0,058	0,115	0,092	0,069	0,15	0,115	0,092	0,184	0,15	0,115	●		
P.3.2	0,115	0,092	0,058	0,127	0,092	0,069	0,138	0,104	0,081	0,161	0,138	0,104	0,184	0,161	0,138	●	○	○
P.3.3	0,115	0,092	0,058	0,127	0,092	0,069	0,138	0,104	0,081	0,161	0,138	0,104	0,184	0,161	0,138	●	○	○
P.4.1	0,104	0,081	0,046	0,115	0,081	0,058	0,115	0,092	0,069	0,15	0,115	0,092	0,184	0,150	0,115	●		
P.4.2	0,104	0,081	0,046	0,115	0,081	0,058	0,115	0,092	0,069	0,15	0,115	0,092	0,184	0,150	0,115	●		
M.1.1	0,104	0,081	0,046	0,115	0,081	0,058	0,115	0,092	0,069	0,15	0,115	0,092	0,184	0,150	0,115	●		
M.2.1	0,092	0,069	0,046	0,092	0,069	0,046	0,104	0,081	0,058	0,127	0,104	0,081	0,15	0,127	0,104	●		
M.3.1	0,104	0,081	0,046	0,115	0,081	0,058	0,115	0,092	0,069	0,15	0,115	0,092	0,184	0,150	0,115	●		
K.1.1	0,207	0,15	0,104	0,219	0,161	0,115	0,242	0,184	0,138	0,288	0,23	0,184	0,345	0,288	0,230	○	●	○
K.1.2	0,207	0,15	0,104	0,219	0,161	0,115	0,242	0,184	0,138	0,288	0,23	0,184	0,345	0,288	0,230	○	●	○
K.2.1	0,173	0,127	0,092	0,196	0,138	0,092	0,207	0,161	0,127	0,242	0,196	0,161	0,288	0,242	0,196	○	●	○
K.2.2	0,173	0,127	0,092	0,196	0,138	0,092	0,207	0,161	0,127	0,242	0,196	0,161	0,288	0,242	0,196	○	●	○
K.3.1	0,173	0,127	0,092	0,196	0,138	0,092	0,207	0,161	0,127	0,242	0,196	0,161	0,288	0,242	0,196	○	●	○
K.3.2	0,15	0,104	0,069	0,161	0,115	0,081	0,173	0,127	0,104	0,207	0,173	0,127	0,242	0,207	0,173	○	●	○
N.1.1																		
N.1.2																		
N.2.1																		
N.2.2																		
N.2.3																		
N.3.1	0,161	0,115	0,081	0,173	0,127	0,092	0,184	0,15	0,127	0,23	0,184	0,138	0,276	0,230	0,184	●		○
N.3.2	0,161	0,115	0,081	0,173	0,127	0,092	0,184	0,15	0,127	0,23	0,184	0,138	0,276	0,230	0,184	●		○
N.3.3	0,161	0,115	0,081	0,173	0,127	0,092	0,184	0,15	0,115	0,23	0,184	0,138	0,276	0,230	0,184	●		○
N.4.1																		
S.1.1	0,092	0,069	0,046	0,092	0,069	0,046	0,104	0,081	0,058	0,127	0,104	0,081	0,15	0,127	0,104	●		
S.1.2	0,092	0,069	0,046	0,092	0,069	0,046	0,104	0,081	0,058	0,127	0,104	0,081	0,15	0,127	0,104	●		
S.2.1	0,081	0,058	0,046	0,092	0,035	0,046	0,092	0,069	0,058	0,115	0,092	0,069	0,138	0,115	0,092	●		
S.2.2	0,081	0,058	0,046	0,092	0,035	0,046	0,092	0,069	0,058	0,115	0,092	0,069	0,138	0,115	0,092	●		
S.2.3	0,081	0,058	0,046	0,092	0,035	0,046	0,092	0,069	0,058	0,115	0,092	0,069	0,138	0,115	0,092	●		
S.3.1	0,127	0,092	0,069	0,138	0,104	0,069	0,15	0,115	0,092	0,184	0,15	0,115	0,219	0,184	0,15	●		
S.3.2	0,127	0,092	0,069	0,138	0,104	0,069	0,15	0,115	0,092	0,184	0,15	0,115	0,219	0,184	0,15	●		
S.3.3	0,115	0,092	0,058	0,127	0,092	0,069	0,138	0,104	0,081	0,161	0,138	0,104	0,184	0,161	0,138	●		
H.1.1	0,104	0,081	0,058	0,115	0,081	0,058	0,127	0,092	0,069	0,150	0,127	0,092	0,173	0,150	0,127		●	
H.1.2	0,104	0,081	0,058	0,115	0,081	0,058	0,127	0,092	0,069	0,150	0,127	0,092	0,173	0,150	0,127		●	
H.1.3	0,104	0,081	0,058	0,115	0,081	0,058	0,127	0,092	0,069	0,150	0,127	0,092	0,173	0,150	0,127		●	
H.1.4																		
H.2.1																		
H.3.1																		
O.1.1																		
O.1.2																		
O.2.1																		
O.2.2																		
O.3.1																		

Cutting data standard values – S-Cut – End mills – SC-UNI, ZEFP = 5, long

Index	Type long v_c (m/min)	max. angle of engagement	52 230 ...															
			$\varnothing DC$ (mm) =															
			6				8				10				12			
			a_e 0,050 x DC	a_e 0,1 x DC	a_e 0,150 x DC	h_m	a_e 0,050 x DC	a_e 0,1 x DC	a_e 0,150 x DC	h_m	a_e 0,050 x DC	a_e 0,1 x DC	a_e 0,150 x DC	h_m	a_e 0,050 x DC	a_e 0,1 x DC	a_e 0,150 x DC	h_m
f_z (mm)				f_z (mm)				f_z (mm)				f_z (mm)						
P.1.1	280	50°	0,134	0,095	0,077	0,030	0,157	0,111	0,090	0,035	0,201	0,142	0,116	0,045	0,255	0,180	0,147	0,057
P.1.2	280	50°	0,112	0,079	0,065	0,025	0,143	0,101	0,083	0,032	0,179	0,126	0,103	0,040	0,228	0,161	0,132	0,051
P.1.3	280	50°	0,112	0,079	0,065	0,025	0,143	0,101	0,083	0,032	0,179	0,126	0,103	0,040	0,228	0,161	0,132	0,051
P.1.4	260	50°	0,112	0,079	0,065	0,025	0,143	0,101	0,083	0,032	0,179	0,126	0,103	0,040	0,228	0,161	0,132	0,051
P.1.5	260	50°	0,112	0,079	0,065	0,025	0,143	0,101	0,083	0,032	0,179	0,126	0,103	0,040	0,228	0,161	0,132	0,051
P.2.1	280	50°	0,134	0,095	0,077	0,030	0,157	0,111	0,090	0,035	0,201	0,142	0,116	0,045	0,255	0,180	0,147	0,057
P.2.2	280	50°	0,134	0,095	0,077	0,030	0,157	0,111	0,090	0,035	0,201	0,142	0,116	0,045	0,255	0,180	0,147	0,057
P.2.3	280	50°	0,112	0,079	0,065	0,025	0,143	0,101	0,083	0,032	0,179	0,126	0,103	0,040	0,228	0,161	0,132	0,051
P.2.4	280	50°	0,112	0,079	0,065	0,025	0,143	0,101	0,083	0,032	0,179	0,126	0,103	0,040	0,228	0,161	0,132	0,051
P.3.1	160	50°	0,080	0,057	0,046	0,018	0,098	0,070	0,057	0,022	0,125	0,089	0,072	0,028	0,161	0,114	0,093	0,036
P.3.2	220	50°	0,112	0,079	0,065	0,025	0,143	0,101	0,083	0,032	0,179	0,126	0,103	0,040	0,228	0,161	0,132	0,051
P.3.3	220	50°	0,112	0,079	0,065	0,025	0,143	0,101	0,083	0,032	0,179	0,126	0,103	0,040	0,228	0,161	0,132	0,051
P.4.1	180	50°	0,080	0,057	0,046	0,018	0,098	0,070	0,057	0,022	0,125	0,089	0,072	0,028	0,161	0,114	0,093	0,036
P.4.2	180	50°	0,080	0,057	0,046	0,018	0,098	0,070	0,057	0,022	0,125	0,089	0,072	0,028	0,161	0,114	0,093	0,036
M.1.1	140	45°	0,080	0,057	0,046	0,018	0,098	0,070	0,057	0,022	0,125	0,089	0,072	0,028	0,161	0,114	0,093	0,036
M.2.1	140	45°	0,080	0,057	0,046	0,018	0,098	0,070	0,057	0,022	0,125	0,089	0,072	0,028	0,161	0,114	0,093	0,036
M.3.1	140	45°	0,080	0,057	0,046	0,018	0,098	0,070	0,057	0,022	0,125	0,089	0,072	0,028	0,161	0,114	0,093	0,036
K.1.1	300	50°	0,134	0,095	0,077	0,030	0,157	0,111	0,090	0,035	0,201	0,142	0,116	0,045	0,255	0,180	0,147	0,057
K.1.2	300	50°	0,134	0,095	0,077	0,030	0,157	0,111	0,090	0,035	0,201	0,142	0,116	0,045	0,255	0,180	0,147	0,057
K.2.1	300	50°	0,134	0,095	0,077	0,030	0,157	0,111	0,090	0,035	0,201	0,142	0,116	0,045	0,255	0,180	0,147	0,057
K.2.2	260	50°	0,134	0,095	0,077	0,030	0,157	0,111	0,090	0,035	0,201	0,142	0,116	0,045	0,255	0,180	0,147	0,057
K.3.1	260	50°	0,112	0,079	0,065	0,025	0,143	0,101	0,083	0,032	0,179	0,126	0,103	0,040	0,228	0,161	0,132	0,051
K.3.2	200	50°	0,112	0,079	0,065	0,025	0,143	0,101	0,083	0,032	0,179	0,126	0,103	0,040	0,228	0,161	0,132	0,051
N.1.1																		
N.1.2																		
N.2.1																		
N.2.2																		
N.2.3																		
N.3.1																		
N.3.2																		
N.3.3																		
N.4.1																		
S.1.1	140	40°	0,080	0,057	0,046	0,018	0,098	0,070	0,057	0,022	0,125	0,089	0,072	0,028	0,161	0,114	0,093	0,036
S.1.2	140	40°	0,080	0,057	0,046	0,018	0,098	0,070	0,057	0,022	0,125	0,089	0,072	0,028	0,161	0,114	0,093	0,036
S.2.1	60	40°	0,045	0,032	0,026	0,010	0,054	0,038	0,031	0,012	0,067	0,047	0,039	0,015	0,085	0,060	0,049	0,019
S.2.2	60	40°	0,045	0,032	0,026	0,010	0,054	0,038	0,031	0,012	0,067	0,047	0,039	0,015	0,085	0,060	0,049	0,019
S.2.3	60	40°	0,045	0,032	0,026	0,010	0,054	0,038	0,031	0,012	0,067	0,047	0,039	0,015	0,085	0,060	0,049	0,019
S.3.1	140	40°	0,045	0,032	0,026	0,010	0,072	0,051	0,041	0,016	0,089	0,063	0,052	0,020	0,112	0,079	0,065	0,025
S.3.2	120	40°	0,045	0,032	0,026	0,010	0,072	0,051	0,041	0,016	0,089	0,063	0,052	0,020	0,112	0,079	0,065	0,025
S.3.3	100	40°	0,045	0,032	0,026	0,010	0,054	0,038	0,031	0,012	0,067	0,047	0,039	0,015	0,085	0,060	0,049	0,019
H.1.1																		
H.1.2																		
H.1.3																		
H.1.4																		
H.2.1																		
H.3.1																		
O.1.1																		
O.1.2																		
O.2.1																		
O.2.2																		
O.3.1																		

Index	52 230 ...									● 1st choice		
	Ø DC (mm) =									○ suitable		
	16				20					Emulsion	Compressed air	MMS
	a_p 0,050 x DC	a_p 0,1 x DC	a_p 0,150 x DC	h_m	a_p 0,050 x DC	a_p 0,1 x DC	a_p 0,150 x DC	h_m				
f_z (mm)				f_z (mm)								
P.1.1	0,291	0,206	0,168	0,065	0,335	0,237	0,194	0,075	○	●	○	
P.1.2	0,268	0,190	0,155	0,060	0,291	0,206	0,168	0,065	○	●	○	
P.1.3	0,268	0,190	0,155	0,060	0,291	0,206	0,168	0,065	○	●	○	
P.1.4	0,268	0,190	0,155	0,060	0,291	0,206	0,168	0,065	○	●	○	
P.1.5	0,268	0,190	0,155	0,060	0,291	0,206	0,168	0,065	○	●	○	
P.2.1	0,291	0,206	0,168	0,065	0,335	0,237	0,194	0,075	○	●	○	
P.2.2	0,291	0,206	0,168	0,065	0,335	0,237	0,194	0,075	○	●	○	
P.2.3	0,268	0,190	0,155	0,060	0,291	0,206	0,168	0,065	○	●	○	
P.2.4	0,268	0,190	0,155	0,060	0,291	0,206	0,168	0,065	○	●	○	
P.3.1	0,188	0,133	0,108	0,042	0,268	0,190	0,155	0,060	●			
P.3.2	0,268	0,190	0,155	0,060	0,291	0,206	0,168	0,065	○	●	○	
P.3.3	0,268	0,190	0,155	0,060	0,291	0,206	0,168	0,065	○	●	○	
P.4.1	0,188	0,133	0,108	0,042	0,268	0,190	0,155	0,060	●			
P.4.2	0,188	0,133	0,108	0,042	0,268	0,190	0,155	0,060	●			
M.1.1	0,188	0,133	0,108	0,042	0,268	0,190	0,155	0,060	●			
M.2.1	0,188	0,133	0,108	0,042	0,268	0,190	0,155	0,060	●			
M.3.1	0,188	0,133	0,108	0,042	0,268	0,190	0,155	0,060	●			
K.1.1	0,291	0,206	0,168	0,065	0,335	0,237	0,194	0,075	○	●	○	
K.1.2	0,291	0,206	0,168	0,065	0,335	0,237	0,194	0,075	○	●	○	
K.2.1	0,291	0,206	0,168	0,065	0,335	0,237	0,194	0,075	○	●	○	
K.2.2	0,291	0,206	0,168	0,065	0,335	0,237	0,194	0,075	○	●	○	
K.3.1	0,268	0,190	0,155	0,060	0,291	0,206	0,168	0,065	○	●	○	
K.3.2	0,268	0,190	0,155	0,060	0,291	0,206	0,168	0,065	○	●	○	
N.1.1												
N.1.2												
N.2.1												
N.2.2												
N.2.3												
N.3.1												
N.3.2												
N.3.3												
N.4.1												
S.1.1	0,188	0,133	0,108	0,042	0,268	0,190	0,155	0,060	●			
S.1.2	0,188	0,133	0,108	0,042	0,268	0,190	0,155	0,060	●			
S.2.1	0,116	0,082	0,067	0,026	0,161	0,114	0,093	0,036	●			
S.2.2	0,116	0,082	0,067	0,026	0,161	0,114	0,093	0,036	●			
S.2.3	0,116	0,082	0,067	0,026	0,161	0,114	0,093	0,036	●			
S.3.1	0,157	0,111	0,090	0,035	0,219	0,155	0,127	0,049	●			
S.3.2	0,157	0,111	0,090	0,035	0,219	0,155	0,127	0,049	●			
S.3.3	0,116	0,082	0,067	0,026	0,161	0,114	0,093	0,036	●			
H.1.1												
H.1.2												
H.1.3												
H.1.4												
H.2.1												
H.3.1												
O.1.1												
O.1.2												
O.2.1												
O.2.2												
O.3.1												

Cutting data standard values – 3D Finish – barrel shape

Index	v _c (m/min)	52 739 ...		● 1st choice ○ suitable		
		Ø DC (mm) = 10		Emulsion	Compressed air	MMS
		a _e 0,05-0,10	a _s 0,10-0,20			
		f _z (mm)				
P.1.1	280	0,07	0,06	●	●	○
P.1.2	250	0,07	0,05	●	●	○
P.1.3	250	0,07	0,05	●	●	○
P.1.4	250	0,07	0,05	●	●	○
P.1.5	250	0,07	0,05	●	●	○
P.2.1	250	0,07	0,05	●	●	○
P.2.2	250	0,07	0,05	●	●	○
P.2.3	210	0,06	0,04	●	●	○
P.2.4	210	0,06	0,04	●	●	○
P.3.1	210	0,06	0,04	●	●	○
P.3.2	200	0,05	0,03		●	
P.3.3	200	0,05	0,03		●	
P.4.1	80	0,05	0,03	●		○
P.4.2	80	0,05	0,03	●		○
M.1.1	60	0,04	0,02	●		○
M.2.1	60	0,04	0,02	●		○
M.3.1	60	0,04	0,02	●		○
K.1.1	280	0,08	0,06		●	
K.1.2	280	0,08	0,06		●	
K.2.1	250	0,07	0,05		●	
K.2.2	250	0,07	0,05		●	
K.3.1	140	0,04	0,03		●	
K.3.2	140	0,04	0,03		●	
N.1.1	600	0,07	0,05	●		○
N.1.2	600	0,06	0,04	●		○
N.2.1	410	0,07	0,05	●		○
N.2.2						
N.2.3						
N.3.1	180	0,08	0,06	●	○	○
N.3.2	180	0,08	0,06	●		○
N.3.3	180	0,08	0,06	●		○
N.4.1	410	0,10	0,08	●		○
S.1.1	30	0,04	0,02	●		
S.1.2	30	0,04	0,02	●		
S.2.1	30	0,04	0,02	●		
S.2.2	30	0,04	0,02	●		
S.2.3	30	0,04	0,02	●		
S.3.1	100	0,04	0,02	●		
S.3.2	80	0,04	0,02	●		
S.3.3	60	0,04	0,02	●		
H.1.1	100	0,05	0,03		●	
H.1.2						
H.1.3						
H.1.4						
H.2.1	130	0,05	0,03		●	
H.3.1	100	0,05	0,03		●	
O.1.1	410	0,10	0,08	●	○	○
O.1.2	600	0,10	0,08	●		○
O.2.1						
O.2.2						
O.3.1						

 In order to calculate the rotational speed n, the diameter DC has to be used.

Cutting data standard values – 3D Finish – oval shape

Index	v _c (m/min)	52 745 ...															● 1st choice ○ suitable		
		Ø DC (mm) =															Emulsion	Compressed air	MMS
		6			8			10			12			16					
		a _s 0,05-0,10	a _s 0,1-0,2	a _s 0,2-0,3	a _s 0,05-0,10	a _s 0,1-0,2	a _s 0,2-0,3	a _s 0,05-0,10	a _s 0,1-0,2	a _s 0,2-0,3	a _s 0,05-0,10	a _s 0,1-0,2	a _s 0,2-0,3	a _s 0,05-0,10	a _s 0,1-0,2	a _s 0,2-0,3			
f _t (mm)																			
P.1.1	280	0,04	0,04	0,04	0,06	0,06	0,05	0,07	0,07	0,06	0,08	0,08	0,07	0,11	0,11	0,10	●	●	○
P.1.2	250	0,04	0,04	0,03	0,06	0,05	0,04	0,07	0,06	0,05	0,08	0,07	0,06	0,11	0,10	0,08	●	●	○
P.1.3	250	0,04	0,04	0,03	0,06	0,05	0,04	0,07	0,06	0,05	0,08	0,07	0,06	0,11	0,10	0,08	●	●	○
P.1.4	250	0,04	0,04	0,03	0,06	0,05	0,04	0,07	0,06	0,05	0,08	0,07	0,06	0,11	0,10	0,08	●	●	○
P.1.5	250	0,04	0,04	0,03	0,06	0,05	0,04	0,07	0,06	0,05	0,08	0,07	0,06	0,11	0,10	0,08	●	●	○
P.2.1	250	0,04	0,04	0,03	0,06	0,05	0,04	0,07	0,06	0,05	0,08	0,07	0,06	0,11	0,10	0,08	●	●	○
P.2.2	250	0,04	0,04	0,03	0,06	0,05	0,04	0,07	0,06	0,05	0,08	0,07	0,06	0,11	0,10	0,08	●	●	○
P.2.3	210	0,04	0,03	0,02	0,05	0,04	0,03	0,06	0,05	0,04	0,07	0,06	0,05	0,10	0,08	0,06	●	●	○
P.2.4	210	0,04	0,03	0,02	0,05	0,04	0,03	0,06	0,05	0,04	0,07	0,06	0,05	0,10	0,08	0,06	●	●	○
P.3.1	210	0,04	0,03	0,02	0,05	0,04	0,03	0,06	0,05	0,04	0,07	0,06	0,05	0,10	0,08	0,06	●	●	○
P.3.2	200	0,03	0,02	0,02	0,04	0,03	0,02	0,05	0,04	0,03	0,06	0,05	0,04	0,08	0,06	0,05		●	
P.3.3	200	0,03	0,02	0,02	0,04	0,03	0,02	0,05	0,04	0,03	0,06	0,05	0,04	0,08	0,06	0,05		●	
P.4.1	80	0,03	0,02	0,02	0,04	0,03	0,02	0,05	0,04	0,03	0,06	0,05	0,04	0,08	0,06	0,05	●		○
P.4.2	80	0,03	0,02	0,02	0,04	0,03	0,02	0,05	0,04	0,03	0,06	0,05	0,04	0,08	0,06	0,05	●		○
M.1.1	60	0,02	0,02	0,01	0,03	0,02	0,02	0,04	0,03	0,02	0,05	0,04	0,02	0,06	0,05	0,03	●		○
M.2.1	60	0,02	0,02	0,01	0,03	0,02	0,02	0,04	0,03	0,02	0,05	0,04	0,02	0,06	0,05	0,03	●		○
M.3.1	60	0,02	0,02	0,01	0,03	0,02	0,02	0,04	0,03	0,02	0,05	0,04	0,02	0,06	0,05	0,03	●		○
K.1.1	280	0,05	0,04	0,04	0,06	0,06	0,05	0,08	0,07	0,06	0,10	0,08	0,07	0,13	0,11	0,10		●	
K.1.2	280	0,05	0,04	0,04	0,06	0,06	0,05	0,08	0,07	0,06	0,10	0,08	0,07	0,13	0,11	0,10		●	
K.2.1	250	0,04	0,04	0,03	0,06	0,05	0,04	0,07	0,06	0,05	0,08	0,07	0,06	0,11	0,10	0,08		●	
K.2.2	250	0,04	0,04	0,03	0,06	0,05	0,04	0,07	0,06	0,05	0,08	0,07	0,06	0,11	0,10	0,08		●	
K.3.1	140	0,02	0,02	0,01	0,03	0,02	0,02	0,04	0,03	0,02	0,05	0,04	0,02	0,06	0,05	0,03		●	
K.3.2	140	0,02	0,02	0,01	0,03	0,02	0,02	0,04	0,03	0,02	0,05	0,04	0,02	0,06	0,05	0,03		●	
N.1.1	600	0,04	0,04	0,03	0,06	0,05	0,04	0,07	0,06	0,05	0,08	0,07	0,06	0,11	0,10	0,08	●		○
N.1.2	600	0,04	0,03	0,02	0,05	0,04	0,03	0,06	0,05	0,04	0,07	0,06	0,05	0,10	0,08	0,06	●		○
N.2.1	410	0,04	0,04	0,03	0,06	0,05	0,04	0,07	0,06	0,05	0,08	0,07	0,06	0,11	0,10	0,08	●		○
N.2.2																			
N.2.3																			
N.3.1	180	0,05	0,04	0,04	0,06	0,06	0,05	0,08	0,07	0,06	0,10	0,08	0,07	0,13	0,11	0,10	●	○	○
N.3.2	180	0,05	0,04	0,04	0,06	0,06	0,05	0,08	0,07	0,06	0,10	0,08	0,07	0,13	0,11	0,10	●		○
N.3.3	180	0,05	0,04	0,04	0,06	0,06	0,05	0,08	0,07	0,06	0,10	0,08	0,07	0,13	0,11	0,10	●		○
N.4.1	410	0,06	0,05	0,05	0,08	0,06	0,06	0,10	0,08	0,08	0,12	0,10	0,10	0,16	0,13	0,13	●		○
S.1.1	30	0,02	0,02	0,01	0,03	0,02	0,02	0,04	0,03	0,02	0,05	0,04	0,02	0,06	0,05	0,03	●		
S.1.2	30	0,02	0,02	0,01	0,03	0,02	0,02	0,04	0,03	0,02	0,05	0,04	0,02	0,06	0,05	0,03	●		
S.2.1	30	0,02	0,02	0,01	0,03	0,02	0,02	0,04	0,03	0,02	0,05	0,04	0,02	0,06	0,05	0,03	●		
S.2.2	30	0,02	0,02	0,01	0,03	0,02	0,02	0,04	0,03	0,02	0,05	0,04	0,02	0,06	0,05	0,03	●		
S.2.3	30	0,02	0,02	0,01	0,03	0,02	0,02	0,04	0,03	0,02	0,05	0,04	0,02	0,06	0,05	0,03	●		
S.3.1	100	0,04	0,03	0,02	0,05	0,04	0,03	0,06	0,05	0,04	0,07	0,06	0,05	0,10	0,08	0,06	●		
S.3.2	80	0,03	0,02	0,02	0,04	0,03	0,02	0,05	0,04	0,03	0,06	0,05	0,04	0,08	0,06	0,05	●		
S.3.3	60	0,03	0,02	0,02	0,04	0,03	0,02	0,05	0,04	0,03	0,06	0,05	0,04	0,08	0,06	0,05	●		
H.1.1	100	0,03	0,02	0,02	0,04	0,03	0,02	0,05	0,04	0,03	0,06	0,05	0,04	0,08	0,06	0,05		●	
H.1.2																			
H.1.3																			
H.1.4																			
H.2.1	130	0,03	0,02	0,02	0,04	0,03	0,02	0,05	0,04	0,03	0,06	0,05	0,04	0,08	0,06	0,05		●	
H.3.1	100	0,03	0,02	0,02	0,04	0,03	0,02	0,05	0,04	0,03	0,06	0,05	0,04	0,08	0,06	0,05		●	
O.1.1	410	0,06	0,05	0,05	0,08	0,06	0,06	0,10	0,08	0,08	0,12	0,10	0,10	0,16	0,13	0,13	●	○	○
O.1.2	600	0,06	0,05	0,05	0,08	0,06	0,06	0,10	0,08	0,08	0,12	0,10	0,10	0,16	0,13	0,13	●		○
O.2.1																			
O.2.2																			
O.3.1																			

 In order to calculate the rotational speed n, the diameter DC has to be used.

Cutting data standard values – 3D Finish – taper shape

Index	v _c (m/min)	52 753 ..., 52 755 ...										● 1st choice ○ suitable		
		Ø DC (mm) =										Emulsion	Compressed air	MMS
		6		8		10		12		16				
		a _s 0,05-0,10	a _s 0,1-0,2	a _s 0,05-0,10	a _s 0,1-0,2	a _s 0,05-0,10	a _s 0,1-0,2	a _s 0,05-0,10	a _s 0,1-0,2	a _s 0,05-0,10	a _s 0,1-0,2			
f _z (mm)														
P.1.1	280	0,04	0,02	0,05	0,03	0,06	0,04	0,07	0,05	0,10	0,06	●	●	○
P.1.2	250	0,04	0,02	0,05	0,03	0,06	0,04	0,07	0,05	0,10	0,06	●	●	○
P.1.3	250	0,04	0,02	0,05	0,03	0,06	0,04	0,07	0,05	0,10	0,06	●	●	○
P.1.4	250	0,04	0,02	0,05	0,03	0,06	0,04	0,07	0,05	0,10	0,06	●	●	○
P.1.5	250	0,04	0,02	0,05	0,03	0,06	0,04	0,07	0,05	0,10	0,06	●	●	○
P.2.1	250	0,04	0,02	0,05	0,03	0,06	0,04	0,07	0,05	0,10	0,06	●	●	○
P.2.2	250	0,04	0,02	0,05	0,03	0,06	0,04	0,07	0,05	0,10	0,06	●	●	○
P.2.3	210	0,03	0,02	0,04	0,02	0,05	0,03	0,06	0,04	0,08	0,05	●	●	○
P.2.4	210	0,03	0,02	0,04	0,02	0,05	0,03	0,06	0,04	0,08	0,05	●	●	○
P.3.1	210	0,03	0,02	0,04	0,02	0,05	0,03	0,06	0,04	0,08	0,05	●	●	○
P.3.2	200	0,02	0,02	0,03	0,02	0,04	0,03	0,05	0,04	0,06	0,05		●	
P.3.3	200	0,02	0,02	0,03	0,02	0,04	0,03	0,05	0,04	0,06	0,05		●	
P.4.1	80	0,02	0,02	0,03	0,02	0,04	0,03	0,05	0,04	0,06	0,05	●		○
P.4.2	80	0,02	0,02	0,03	0,02	0,04	0,03	0,05	0,04	0,06	0,05	●		○
M.1.1	60	0,02	0,01	0,02	0,02	0,03	0,02	0,04	0,02	0,05	0,03	●		○
M.2.1	60	0,02	0,01	0,02	0,02	0,03	0,02	0,04	0,02	0,05	0,03	●		○
M.3.1	60	0,02	0,01	0,02	0,02	0,03	0,02	0,04	0,02	0,05	0,03	●		○
K.1.1	280	0,04	0,03	0,06	0,04	0,07	0,05	0,08	0,06	0,11	0,08		●	
K.1.2	280	0,04	0,03	0,06	0,04	0,07	0,05	0,08	0,06	0,11	0,08		●	
K.2.1	250	0,04	0,03	0,05	0,04	0,06	0,05	0,07	0,06	0,10	0,08		●	
K.2.2	250	0,04	0,03	0,05	0,04	0,06	0,05	0,07	0,06	0,10	0,08		●	
K.3.1	140	0,02	0,01	0,02	0,02	0,03	0,02	0,04	0,02	0,05	0,03		●	
K.3.2	140	0,02	0,01	0,02	0,02	0,03	0,02	0,04	0,02	0,05	0,03		●	
N.1.1	600	0,04	0,02	0,05	0,03	0,06	0,04	0,07	0,05	0,10	0,06	●		○
N.1.2	600	0,03	0,02	0,04	0,03	0,05	0,04	0,06	0,05	0,08	0,06	●		○
N.2.1	410	0,04	0,02	0,05	0,03	0,06	0,04	0,07	0,05	0,10	0,06	●		○
N.2.2														
N.2.3														
N.3.1	180	0,04	0,03	0,05	0,04	0,06	0,05	0,07	0,06	0,10	0,08	●	○	○
N.3.2	180	0,04	0,03	0,05	0,04	0,06	0,05	0,07	0,06	0,10	0,08	●		○
N.3.3	180	0,04	0,03	0,05	0,04	0,06	0,05	0,07	0,06	0,10	0,08	●		○
N.4.1	410	0,06	0,05	0,08	0,06	0,10	0,08	0,12	0,10	0,16	0,13	●		○
S.1.1	30	0,02	0,01	0,02	0,02	0,03	0,02	0,04	0,02	0,05	0,03	●		
S.1.2	30	0,02	0,01	0,02	0,02	0,03	0,02	0,04	0,02	0,05	0,03	●		
S.2.1	30	0,02	0,01	0,02	0,02	0,03	0,02	0,04	0,02	0,05	0,03	●		
S.2.2	30	0,02	0,01	0,02	0,02	0,03	0,02	0,04	0,02	0,05	0,03	●		
S.2.3	30	0,02	0,01	0,02	0,02	0,03	0,02	0,04	0,02	0,05	0,03	●		
S.3.1	100	0,02	0,01	0,02	0,02	0,03	0,02	0,04	0,02	0,05	0,03	●		
S.3.2	80	0,02	0,01	0,02	0,02	0,03	0,02	0,04	0,02	0,05	0,03	●		
S.3.3	60	0,02	0,01	0,02	0,02	0,03	0,02	0,04	0,02	0,05	0,03	●		
H.1.1	100	0,02	0,02	0,03	0,02	0,04	0,03	0,05	0,04	0,06	0,05		●	
H.1.2														
H.1.3														
H.1.4														
H.2.1	130	0,02	0,02	0,03	0,02	0,04	0,03	0,05	0,04	0,06	0,05		●	
H.3.1	100	0,02	0,02	0,03	0,02	0,04	0,03	0,05	0,04	0,06	0,05		●	
O.1.1	410	0,06	0,05	0,08	0,06	0,10	0,08	0,12	0,10	0,16	0,13	●	○	○
O.1.2	600	0,06	0,05	0,08	0,06	0,10	0,08	0,12	0,10	0,16	0,13	●		○
O.2.1														
O.2.2														
O.3.1														

 In order to calculate the rotational speed n, the diameter DC has to be used.





Cutting data standard values – 3D Finish – lens shape



Index	vc (m/min)	52 756 ...										● 1st choice ○ suitable		
		Ø DC (mm) =										Emulsion	Compressed air	MMS
		4		6		8		10		12				
		Allowance												
0,05-0,10	0,1-0,2	0,05-0,10	0,1-0,2	0,05-0,10	0,1-0,2	0,05-0,10	0,1-0,2	0,05-0,10	0,1-0,2	0,05-0,10	0,1-0,2			
fz (mm)														
P.1.1	280	0,03	0,02	0,04	0,03	0,06	0,04	0,07	0,05	0,08	0,06	●	●	○
P.1.2	240	0,03	0,02	0,04	0,03	0,06	0,04	0,07	0,05	0,08	0,06	●	●	○
P.1.3	240	0,03	0,02	0,04	0,03	0,06	0,04	0,07	0,05	0,08	0,06	●	●	○
P.1.4	240	0,03	0,02	0,04	0,03	0,06	0,04	0,07	0,05	0,08	0,06	●	●	○
P.1.5	240	0,03	0,02	0,04	0,03	0,06	0,04	0,07	0,05	0,08	0,06	●	●	○
P.2.1	240	0,03	0,02	0,04	0,03	0,06	0,04	0,07	0,05	0,08	0,06	●	●	○
P.2.2	240	0,03	0,02	0,04	0,03	0,06	0,04	0,07	0,05	0,08	0,06	●	●	○
P.2.3	200	0,02	0,02	0,04	0,02	0,05	0,03	0,06	0,04	0,07	0,05	●	●	○
P.2.4	200	0,02	0,02	0,04	0,02	0,05	0,03	0,06	0,04	0,07	0,05	●	●	○
P.3.1	200	0,02	0,02	0,04	0,02	0,05	0,03	0,06	0,04	0,07	0,05	●	●	○
P.3.2	180	0,02	0,01	0,03	0,02	0,04	0,02	0,05	0,03	0,06	0,04		●	
P.3.3	180	0,02	0,01	0,03	0,02	0,04	0,02	0,05	0,03	0,06	0,04		●	
P.4.1	120	0,02	0,01	0,03	0,02	0,04	0,02	0,05	0,03	0,06	0,04	●		○
P.4.2	120	0,02	0,01	0,03	0,02	0,04	0,02	0,05	0,03	0,06	0,04	●		○
M.1.1	90	0,02	0,01	0,02	0,01	0,03	0,02	0,04	0,02	0,05	0,02	●		○
M.2.1	90	0,02	0,01	0,02	0,01	0,03	0,02	0,04	0,02	0,05	0,02	●		○
M.3.1	90	0,02	0,01	0,02	0,01	0,03	0,02	0,04	0,02	0,05	0,02	●		○
K.1.1	300	0,03	0,02	0,05	0,04	0,06	0,05	0,08	0,06	0,10	0,07		●	
K.1.2	300	0,03	0,02	0,05	0,04	0,06	0,05	0,08	0,06	0,10	0,07		●	
K.2.1	270	0,03	0,02	0,04	0,03	0,06	0,04	0,07	0,05	0,08	0,06		●	
K.2.2	270	0,03	0,02	0,04	0,03	0,06	0,04	0,07	0,05	0,08	0,06		●	
K.3.1	150	0,02	0,01	0,02	0,02	0,03	0,02	0,04	0,03	0,05	0,04		●	
K.3.2	150	0,02	0,01	0,02	0,02	0,03	0,02	0,04	0,03	0,05	0,04		●	
N.1.1	900	0,03	0,02	0,04	0,03	0,06	0,04	0,07	0,05	0,08	0,06	●		○
N.1.2	900	0,02	0,02	0,04	0,02	0,05	0,03	0,06	0,04	0,07	0,05	●		○
N.2.1	600	0,03	0,02	0,04	0,03	0,06	0,04	0,07	0,05	0,08	0,06	●		○
N.2.2														
N.2.3														
N.3.1	270	0,03	0,02	0,05	0,04	0,06	0,05	0,08	0,06	0,10	0,07	●	○	○
N.3.2	270	0,03	0,02	0,05	0,04	0,06	0,05	0,08	0,06	0,10	0,07	●		○
N.3.3	270	0,03	0,02	0,05	0,04	0,06	0,05	0,08	0,06	0,10	0,07	●		○
N.4.1	600	0,04	0,03	0,06	0,05	0,08	0,06	0,10	0,08	0,12	0,10	●		○
S.1.1														
S.1.2														
S.2.1														
S.2.2														
S.2.3														
S.3.1	150	0,02	0,02	0,04	0,02	0,05	0,03	0,06	0,04	0,07	0,05	●		
S.3.2	120	0,02	0,01	0,03	0,02	0,04	0,02	0,05	0,03	0,06	0,04	●		
S.3.3	90	0,02	0,01	0,03	0,02	0,04	0,02	0,05	0,03	0,06	0,04	●		
H.1.1														
H.1.2														
H.1.3														
H.1.4														
H.2.1														
H.3.1														
O.1.1														
O.1.2														
O.2.1														
O.2.2														
O.3.1														

 In order to calculate the rotational speed n, the diameter DC has to be used.

Cutting data standard values – PCD milling cutter

Index	v _c (m/min)	50 011 ..., 50 012 ...		50 010 ..., 50 013 ...		50 014 ...		50 015 ...			
		a _{p max.} x DC	a _e	a _{p max.} x DC	a _e	a _{p max.} x DC	a _e		a _{p max.} x DC	a _e	a _{p max.} x DC
N.1.1	900	0,15xDC	1xDC	1xDC	0,1xDC	0,15xDC	0,1xDC	0,9xAPMX	0,3xDC	0,1xDC	1xDC
N.1.2	900	0,15xDC	1xDC	1xDC	0,1xDC	0,15xDC	0,1xDC	0,9xAPMX	0,3xDC	0,1xDC	1xDC
N.2.1	700	0,15xDC	1xDC	1xDC	0,1xDC	0,15xDC	0,1xDC	0,9xAPMX	0,3xDC	0,1xDC	1xDC
N.2.2	600	0,15xDC	1xDC	1xDC	0,1xDC	0,15xDC	0,1xDC	0,9xAPMX	0,3xDC	0,1xDC	1xDC
N.2.3	400	0,15xDC	1xDC	1xDC	0,1xDC	0,15xDC	0,1xDC	0,9xAPMX	0,3xDC	0,1xDC	1xDC
N.3.1	500							0,9xAPMX	0,3xDC	0,1xDC	1xDC
N.3.2											
N.3.3											
N.4.1	900							0,9xAPMX	0,3xDC	0,1xDC	1xDC
O.1.1	120	0,2xDC	1xDC	1xDC	0,1xDC	0,2xDC	0,1xDC	0,9xAPMX	0,3xDC	0,1xDC	1xDC
O.1.2	250	0,2xDC	1xDC	1xDC	0,1xDC	0,2xDC	0,1xDC	0,9xAPMX	0,3xDC	0,1xDC	1xDC
O.2.1											
O.2.2	200–300	0,2xDC	1xDC	1xDC	0,1xDC	0,2xDC	0,1xDC	0,9xAPMX	0,3xDC	0,1xDC	1xDC
O.3.1	650	0,2xDC	1xDC	1xDC	0,1xDC	0,2xDC	0,1xDC	0,9xAPMX	0,3xDC	0,1xDC	1xDC

Index	v _c (m/min)	50 016 ..., 50 017 ...				50 018 ...				50 020 ...			
						a _{p max.} x DC	a _e	a _{p max.} x DC	a _e	a _{p max.} x DC	a _e	a _{p max.} x DC	a _e
N.1.1	900	0,9xAPMX	0,3xDC	0,1xDC	1xDC	0,8xAPMX	0,3xDC	0,1xDC	0,8xDC	1,2xAPMX	0,2xDC	1xDC	1xDC
N.1.2	900	0,9xAPMX	0,3xDC	0,1xDC	1xDC	0,8xAPMX	0,3xDC	0,1xDC	0,8xDC	1,2xAPMX	0,2xDC	1xDC	1xDC
N.2.1	700	0,9xAPMX	0,3xDC	0,1xDC	1xDC	0,8xAPMX	0,3xDC	0,1xDC	0,8xDC	1,2xAPMX	0,2xDC	1xDC	1xDC
N.2.2	600	0,9xAPMX	0,3xDC	0,1xDC	1xDC	0,8xAPMX	0,3xDC	0,1xDC	0,8xDC	1,2xAPMX	0,2xDC	1xDC	1xDC
N.2.3	400	0,9xAPMX	0,3xDC	0,1xDC	1xDC	0,8xAPMX	0,3xDC	0,1xDC	0,8xDC	1,2xAPMX	0,2xDC	1xDC	1xDC
N.3.1	500	0,9xAPMX	0,3xDC	0,1xDC	1xDC	0,8xAPMX	0,3xDC	0,1xDC	0,8xDC	1,2xAPMX	0,2xDC	1xDC	1xDC
N.3.2													
N.3.3													
N.4.1	900	0,9xAPMX	0,3xDC	0,1xDC	1xDC	0,8xAPMX	0,3xDC	0,1xDC	0,8xDC	1,2xAPMX	0,2xDC	1xDC	1xDC
O.1.1	120	0,9xAPMX	0,3xDC	0,1xDC	1xDC	0,8xAPMX	0,3xDC	0,1xDC	0,8xDC	1,2xAPMX	0,2xDC	1xDC	1xDC
O.1.2	250	0,9xAPMX	0,3xDC	0,1xDC	1xDC	0,8xAPMX	0,3xDC	0,1xDC	0,8xDC	1,2xAPMX	0,2xDC	1xDC	1xDC
O.2.1													
O.2.2	200–300	0,9xAPMX	0,3xDC	0,1xDC	1xDC	0,8xAPMX	0,3xDC	0,1xDC	0,8xDC	1,2xAPMX	0,2xDC	1xDC	1xDC
O.3.1	650	0,9xAPMX	0,3xDC	0,1xDC	1xDC	0,8xAPMX	0,3xDC	0,1xDC	0,8xDC	1,2xAPMX	0,2xDC	1xDC	1xDC

Index	v _c (m/min)	50 019 ...										● 1st choice ○ suitable		
				Ø DC (mm) =								Emulsion	Compressed air	MMS
		a _{p max.} x DC	a _e	a _{p max.} x DC	a _e	40	50	63	80	100	125			
N.1.1	2200	0,8xAPMX	0,3xDC	0,1xDC	0,8xDC	0,150	0,150	0,150	0,150	0,150	0,150	●		○
N.1.2	2100	0,8xAPMX	0,3xDC	0,1xDC	0,8xDC	0,150	0,150	0,150	0,150	0,150	0,150	●		○
N.2.1	1850	0,8xAPMX	0,3xDC	0,1xDC	0,8xDC	0,150	0,150	0,150	0,150	0,150	0,150	●		○
N.2.2	1850	0,8xAPMX	0,3xDC	0,1xDC	0,8xDC	0,150	0,150	0,150	0,150	0,150	0,150	●		○
N.2.3	1750	0,8xAPMX	0,3xDC	0,1xDC	0,8xDC	0,150	0,150	0,150	0,150	0,150	0,150	●		○
N.3.1	1000–1500	0,8xAPMX	0,3xDC	0,1xDC	0,8xDC	0,150	0,150	0,150	0,150	0,150	0,150	●		○
N.3.2														
N.3.3														
N.4.1	2200	0,8xAPMX	0,3xDC	0,1xDC	0,8xDC	0,150	0,150	0,150	0,150	0,150	0,150	●		○
O.1.1														
O.1.2														
O.2.1														
O.2.2	500–600	0,8xAPMX	0,3xDC	0,1xDC	0,8xDC	0,230	0,230	0,230	0,230	0,230	0,230	●		○
O.3.1														

Index	50 010 ..., 50 011 ..., 50 012 ..., 50 013 ..., 50 014 ..., 50 015 ...													● 1st choice ○ suitable		
	Ø DC (mm) =													Emulsion	Compressed air	MMS
	2	3	4	5	6	8	10	12	16	20	25	32				
	f _z (mm)															
N.1.1	0,018	0,027	0,035	0,048	0,060	0,065	0,070	0,080	0,090	0,120	0,140	0,160	●		○	
N.1.2	0,018	0,027	0,035	0,048	0,060	0,065	0,070	0,080	0,090	0,120	0,140	0,160	●		○	
N.2.1	0,018	0,027	0,035	0,048	0,060	0,065	0,070	0,080	0,090	0,120	0,140	0,160	●		○	
N.2.2	0,018	0,027	0,035	0,048	0,060	0,065	0,070	0,080	0,090	0,120	0,140	0,160	●		○	
N.2.3	0,018	0,027	0,035	0,048	0,060	0,065	0,070	0,080	0,090	0,120	0,140	0,160	●		○	
N.3.1							0,070	0,080	0,090	0,120	0,140	0,160	●		○	
N.3.2																
N.3.3																
N.4.1							0,070	0,080	0,090	0,120	0,140	0,160	●		○	
O.1.1	0,025	0,038	0,050	0,071	0,100	0,150	0,200	0,250	0,300	0,400	0,440	0,460	●		○	
O.1.2	0,021	0,031	0,040	0,050	0,060	0,070	0,080	0,115	0,150	0,200	0,220	0,260	●		○	
O.2.1																
O.2.2	0,021	0,031	0,040	0,050	0,060	0,070	0,080	0,115	0,150	0,200	0,220	0,260	●		○	
O.3.1	0,021	0,031	0,040	0,050	0,060	0,070	0,080	0,115	0,150	0,200	0,220	0,260	●		○	

Index	50 016 ..., 50 017 ..., 50 018 ..., 50 020 ...													● 1st choice ○ suitable		
	Ø DC (mm) =													Emulsion	Compressed air	MMS
	2	3	4	5	6	8	10	12	16	20	25	32				
	f _z (mm)															
N.1.1	0,018	0,027	0,035	0,0475	0,060	0,065	0,070	0,080	0,090	0,120	0,140	0,160	●		○	
N.1.2	0,018	0,027	0,035	0,0475	0,060	0,065	0,070	0,080	0,090	0,120	0,140	0,160	●		○	
N.2.1	0,018	0,027	0,035	0,0475	0,060	0,065	0,070	0,080	0,090	0,120	0,140	0,160	●		○	
N.2.2	0,018	0,027	0,035	0,0475	0,060	0,065	0,070	0,080	0,090	0,120	0,140	0,160	●		○	
N.2.3	0,018	0,027	0,035	0,0475	0,060	0,065	0,070	0,080	0,090	0,120	0,140	0,160	●		○	
N.3.1							0,070	0,080	0,090	0,120	0,140	0,160	●		○	
N.3.2																
N.3.3																
N.4.1							0,070	0,080	0,090	0,120	0,140	0,160	●		○	
O.1.1	0,025	0,038	0,050	0,0705	0,100	0,150	0,200	0,250	0,300	0,400	0,440	0,460	●		○	
O.1.2	0,021	0,031	0,040	0,050	0,060	0,070	0,080	0,115	0,150	0,200	0,220	0,260	●		○	
O.2.1																
O.2.2	0,021	0,031	0,040	0,050	0,060	0,070	0,080	0,115	0,150	0,200	0,220	0,260	●		○	
O.3.1	0,021	0,031	0,040	0,050	0,060	0,070	0,080	0,115	0,150	0,200	0,220	0,260	●		○	

Cutting data standard values – AluLine – End mills – ZEFP = 2

Index	Type short		Medium-length version		53 623..., 53 624..., 53 625..., 53 626..., 53 633..., 53 634..., 53 635..., 53 636..., 53 619..., 53 620..., 53 621..., 53 622..., 53 629..., 53 630..., 53 631..., 53 632..., 52 627..., 53 628..., 53 637..., 53 638...																	
	v _c (m/min)	a _{p,max.} x DC	v _c (m/min)	a _{p,max.} x DC	Ø DC (mm) =																	
					2			2,5–3,0			3,5–4,0			4,5–5,0			5,5–6,0			6,5–8,0		
					a _e 0,1–0,2 x DC	a _e 0,3–0,4 x DC	a _e 0,6–1,0 x DC	a _e 0,1–0,2 x DC	a _e 0,3–0,4 x DC	a _e 0,6–1,0 x DC	a _e 0,1–0,2 x DC	a _e 0,3–0,4 x DC	a _e 0,6–1,0 x DC	a _e 0,1–0,2 x DC	a _e 0,3–0,4 x DC	a _e 0,6–1,0 x DC	a _e 0,1–0,2 x DC	a _e 0,3–0,4 x DC	a _e 0,6–1,0 x DC	a _e 0,1–0,2 x DC	a _e 0,3–0,4 x DC	a _e 0,6–1,0 x DC
f _z (mm)																						
N.1.1	600	1,0	360	0,7	0,032	0,027	0,021	0,045	0,039	0,030	0,057	0,049	0,038	0,071	0,061	0,047	0,084	0,073	0,056	0,110	0,095	0,073
N.1.2	600	1,0	360	0,7	0,032	0,027	0,021	0,045	0,039	0,030	0,057	0,049	0,038	0,071	0,061	0,047	0,084	0,073	0,056	0,110	0,095	0,073
N.2.1	360	1,0	215	0,7	0,023	0,020	0,015	0,035	0,030	0,023	0,047	0,040	0,031	0,059	0,051	0,039	0,071	0,061	0,047	0,095	0,082	0,063
N.2.2	360	1,0	215	0,7	0,023	0,020	0,015	0,035	0,030	0,023	0,047	0,040	0,031	0,059	0,051	0,039	0,071	0,061	0,047	0,095	0,082	0,063
N.2.3	240	1,0	145	0,7	0,023	0,020	0,015	0,035	0,030	0,023	0,047	0,040	0,031	0,059	0,051	0,039	0,071	0,061	0,047	0,095	0,082	0,063
N.3.1	240	1,0	145	0,7	0,018	0,016	0,012	0,029	0,025	0,019	0,038	0,033	0,025	0,048	0,042	0,032	0,058	0,050	0,039	0,078	0,068	0,052
N.3.2	240	1,0	145	0,7	0,018	0,016	0,012	0,029	0,025	0,019	0,038	0,033	0,025	0,048	0,042	0,032	0,058	0,050	0,039	0,078	0,068	0,052
N.3.3	170	1,0	100	0,7	0,018	0,016	0,012	0,029	0,025	0,019	0,038	0,033	0,025	0,048	0,042	0,032	0,058	0,050	0,039	0,078	0,068	0,052
N.4.1	220	1,0	130	0,7	0,023	0,020	0,015	0,035	0,030	0,023	0,047	0,040	0,031	0,059	0,051	0,039	0,071	0,061	0,047	0,095	0,082	0,063

Cutting data standard values – AluLine – End mill – ZEFP = 3

Index	Type short / medium length		Type long		Type extra long		53 615..., 53 616..., 53 617..., 53 618..., 53 611..., 53 612..., 53 613..., 53 614..., 53 712..., 53 713..., 53 714..., 53 715..., 53 708..., 53 709..., 53 710..., 53 711..., 53 584..., 53 597...														
	v _c (m/min)	a _{p,max.} x DC	v _c (m/min)	a _{p,max.} x DC	v _c (m/min)	a _{p,max.} x DC	Ø DC (mm) =														
							2			2,5–3,0			3,5–4,0			4,5–5,0			5,5–6,0		
							a _e 0,1–0,2 x DC	a _e 0,3–0,4 x DC	a _e 0,6–1,0 x DC	a _e 0,1–0,2 x DC	a _e 0,3–0,4 x DC	a _e 0,6–1,0 x DC	a _e 0,1–0,2 x DC	a _e 0,3–0,4 x DC	a _e 0,6–1,0 x DC	a _e 0,1–0,2 x DC	a _e 0,3–0,4 x DC	a _e 0,6–1,0 x DC	a _e 0,1–0,2 x DC	a _e 0,3–0,4 x DC	a _e 0,6–1,0 x DC
f _z (mm)																					
N.1.1	600	1,0	480	0,8	240	0,6	0,023	0,020	0,015	0,035	0,030	0,023	0,047	0,040	0,031	0,059	0,051	0,039	0,071	0,061	0,047
N.1.2	600	1,0	480	0,8	240	0,6	0,023	0,020	0,015	0,035	0,030	0,023	0,047	0,040	0,031	0,059	0,051	0,039	0,071	0,061	0,047
N.2.1	360	1,0	290	0,8	145	0,6	0,023	0,020	0,015	0,033	0,029	0,022	0,044	0,038	0,029	0,054	0,047	0,036	0,066	0,057	0,044
N.2.2	360	1,0	290	0,8	145	0,6	0,023	0,020	0,015	0,033	0,029	0,022	0,044	0,038	0,029	0,054	0,047	0,036	0,066	0,057	0,044
N.2.3	240	1,0	190	0,8	95	0,6	0,023	0,020	0,015	0,033	0,029	0,022	0,044	0,038	0,029	0,054	0,047	0,036	0,066	0,057	0,044
N.3.1	240	1,0	190	0,8	95	0,6	0,015	0,013	0,010	0,024	0,021	0,016	0,032	0,028	0,022	0,041	0,035	0,027	0,050	0,043	0,033
N.3.2	240	1,0	190	0,8	95	0,6	0,015	0,013	0,010	0,024	0,021	0,016	0,032	0,028	0,022	0,041	0,035	0,027	0,050	0,043	0,033
N.3.3	170	1,0	135	0,8	70	0,6	0,015	0,013	0,010	0,024	0,021	0,016	0,032	0,028	0,022	0,041	0,035	0,027	0,050	0,043	0,033
N.4.1	220	1,0	175	0,8	90	0,6	0,023	0,020	0,015	0,033	0,029	0,022	0,044	0,038	0,029	0,054	0,047	0,036	0,066	0,057	0,044

Cutting data standard values – AluLine – End mill – ZEFP = 4

Index	Type short / medium length		Type long		Type extra long		53 700..., 53 701..., 53 702..., 53 703..., 53 704..., 53 705..., 53 706..., 53 707..., 53 560..., 53 561..., 53 562..., 53 563..., 53 564..., 53 565..., 53 566..., 53 567..., 53 568..., 53 569...														
	v _c (m/min)	a _{p,max.} x DC	v _c (m/min)	a _{p,max.} x DC	v _c (m/min)	a _{p,max.} x DC	Ø DC (mm) =														
							2			3,0			4,0			5,0			6,0		
							a _e 0,1–0,2 x DC	a _e 0,3–0,4 x DC	a _e 0,6–1,0 x DC	a _e 0,1–0,2 x DC	a _e 0,3–0,4 x DC	a _e 0,6–1,0 x DC	a _e 0,1–0,2 x DC	a _e 0,3–0,4 x DC	a _e 0,6–1,0 x DC	a _e 0,1–0,2 x DC	a _e 0,3–0,4 x DC	a _e 0,6–1,0 x DC	a _e 0,1–0,2 x DC	a _e 0,3–0,4 x DC	a _e 0,6–1,0 x DC
f _z (mm)																					
N.1.1	600	1,0	480	0,8	240	0,6	0,018	0,016	0,012	0,029	0,025	0,019	0,038	0,033	0,025	0,048	0,042	0,032	0,058	0,050	0,039
N.1.2	600	1,0	480	0,8	240	0,6	0,018	0,016	0,012	0,029	0,025	0,019	0,038	0,033	0,025	0,048	0,042	0,032	0,058	0,050	0,039
N.2.1	360	1,0	290	0,8	145	0,6	0,020	0,017	0,013	0,028	0,024	0,019	0,036	0,031	0,024	0,045	0,039	0,030	0,053	0,046	0,035
N.2.2	480	1,0	385	0,8	145	0,6	0,020	0,017	0,013	0,028	0,024	0,019	0,036	0,031	0,024	0,045	0,039	0,030	0,053	0,046	0,035
N.2.3	240	1,0	190	0,8	95	0,6	0,020	0,017	0,013	0,028	0,024	0,019	0,036	0,031	0,024	0,045	0,039	0,030	0,053	0,046	0,035
N.3.1	240	1,0	190	0,8	95	0,6	0,014	0,012	0,009	0,021	0,018	0,014	0,029	0,025	0,019	0,037	0,032	0,025	0,045	0,039	0,030
N.3.2	240	1,0	190	0,8	95	0,6	0,014	0,012	0,009	0,021	0,018	0,014	0,029	0,025	0,019	0,037	0,032	0,025	0,045	0,039	0,030
N.3.3	170	1,0	135	0,8	70	0,6	0,014	0,012	0,009	0,021	0,018	0,014	0,029	0,025	0,019	0,037	0,032	0,025	0,045	0,039	0,030
N.4.1	220	1,0	175	0,8	90	0,6	0,020	0,017	0,013	0,028	0,024	0,019	0,036	0,031	0,024	0,045	0,039	0,030	0,053	0,046	0,035

53 623..., 53 624..., 53 625..., 53 626..., 53 633..., 53 634..., 53 635..., 53 636..., 53 619..., 53 620..., 53 621..., 53 622..., 53 629..., 53 630..., 53 631..., 53 632..., 52 627..., 53 628..., 53 637..., 53 638...																		● 1st choice ○ suitable			
Index	Ø DC (mm) =																		Emulsion	Compressed air	MMS
	8,5–10,0			10,5–12,0			12,5–14,0			14,5–16,0			16,5–18,0			18,5–20,0					
	a _e 0,1–0,2 x DC	a _e 0,3–0,4 x DC	a _e 0,6–1,0 x DC	a _e 0,1–0,2 x DC	a _e 0,3–0,4 x DC	a _e 0,6–1,0 x DC	a _e 0,1–0,2 x DC	a _e 0,3–0,4 x DC	a _e 0,6–1,0 x DC	a _e 0,1–0,2 x DC	a _e 0,3–0,4 x DC	a _e 0,6–1,0 x DC	a _e 0,1–0,2 x DC	a _e 0,3–0,4 x DC	a _e 0,6–1,0 x DC	a _e 0,1–0,2 x DC	a _e 0,3–0,4 x DC	a _e 0,6–1,0 x DC			
f _t (mm)																					
N.1.1	0,137	0,118	0,091	0,162	0,140	0,108	0,189	0,164	0,126	0,203	0,176	0,135	0,216	0,187	0,144	0,230	0,199	0,153	●	○*	○
N.1.2	0,137	0,118	0,091	0,162	0,140	0,108	0,189	0,164	0,126	0,203	0,176	0,135	0,216	0,187	0,144	0,230	0,199	0,153	●	○*	○
N.2.1	0,120	0,104	0,080	0,144	0,125	0,096	0,168	0,146	0,112	0,180	0,156	0,120	0,194	0,168	0,129	0,206	0,178	0,137	●	○*	○
N.2.2	0,120	0,104	0,080	0,144	0,125	0,096	0,168	0,146	0,112	0,180	0,156	0,120	0,194	0,168	0,129	0,206	0,178	0,137	●	○*	○
N.2.3	0,120	0,104	0,080	0,144	0,125	0,096	0,168	0,146	0,112	0,180	0,156	0,120	0,194	0,168	0,129	0,206	0,178	0,137	●	○*	○
N.3.1	0,098	0,085	0,065	0,119	0,103	0,079	0,138	0,120	0,092	0,149	0,129	0,099	0,158	0,137	0,105	0,168	0,146	0,112	●	○*	○
N.3.2	0,098	0,085	0,065	0,119	0,103	0,079	0,138	0,120	0,092	0,149	0,129	0,099	0,158	0,137	0,105	0,168	0,146	0,112	●	○*	○
N.3.3	0,098	0,085	0,065	0,119	0,103	0,079	0,138	0,120	0,092	0,149	0,129	0,099	0,158	0,137	0,105	0,168	0,146	0,112	●	○*	○
N.4.1	0,120	0,104	0,080	0,144	0,125	0,096	0,168	0,146	0,112	0,180	0,156	0,120	0,194	0,168	0,129	0,206	0,178	0,137	●	○*	○

* = only suitable for DLC-coated cutters

53 598..., 53 599..., 53 578..., 53 579..., 53 580... / 53 581..., 53 517..., 53 518..., 53 519..., 53 520..., 53 521..., 53 522..., 53 523..., 53 524...																		● 1st choice ○ suitable						
Index	Ø DC (mm) =																		Emulsion	Compressed air	MMS			
	6,5–8,0			8,5–10,0			10,5–12,0			12,5–14,0			14,5–16,0			16,5–18,0						18,5–20,0		
	a _e 0,1–0,2 x DC	a _e 0,3–0,4 x DC	a _e 0,6–1,0 x DC	a _e 0,1–0,2 x DC	a _e 0,3–0,4 x DC	a _e 0,6–1,0 x DC	a _e 0,1–0,2 x DC	a _e 0,3–0,4 x DC	a _e 0,6–1,0 x DC	a _e 0,1–0,2 x DC	a _e 0,3–0,4 x DC	a _e 0,6–1,0 x DC	a _e 0,1–0,2 x DC	a _e 0,3–0,4 x DC	a _e 0,6–1,0 x DC	a _e 0,1–0,2 x DC	a _e 0,3–0,4 x DC	a _e 0,6–1,0 x DC						
f _t (mm)																								
N.1.1	0,095	0,082	0,063	0,120	0,104	0,080	0,144	0,125	0,096	0,168	0,146	0,112	0,180	0,156	0,120	0,194	0,168	0,129	0,206	0,178	0,137	●	○*	○
N.1.2	0,095	0,082	0,063	0,120	0,104	0,080	0,144	0,125	0,096	0,168	0,146	0,112	0,180	0,156	0,120	0,194	0,168	0,129	0,206	0,178	0,137	●	○*	○
N.2.1	0,087	0,075	0,058	0,110	0,095	0,073	0,132	0,114	0,088	0,153	0,133	0,102	0,164	0,142	0,109	0,174	0,151	0,116	0,186	0,161	0,124	●	○*	○
N.2.2	0,087	0,075	0,058	0,110	0,095	0,073	0,132	0,114	0,088	0,153	0,133	0,102	0,164	0,142	0,109	0,174	0,151	0,116	0,186	0,161	0,124	●	○*	○
N.2.3	0,087	0,075	0,058	0,110	0,095	0,073	0,132	0,114	0,088	0,153	0,133	0,102	0,164	0,142	0,109	0,174	0,151	0,116	0,186	0,161	0,124	●	○*	○
N.3.1	0,066	0,057	0,044	0,083	0,072	0,055	0,099	0,086	0,066	0,117	0,101	0,078	0,125	0,108	0,083	0,134	0,116	0,089	0,141	0,122	0,094	●	○*	○
N.3.2	0,066	0,057	0,044	0,083	0,072	0,055	0,099	0,086	0,066	0,117	0,101	0,078	0,125	0,108	0,083	0,134	0,116	0,089	0,141	0,122	0,094	●	○*	○
N.3.3	0,066	0,057	0,044	0,083	0,072	0,055	0,099	0,086	0,066	0,117	0,101	0,078	0,125	0,108	0,083	0,134	0,116	0,089	0,141	0,122	0,094	●	○*	○
N.4.1	0,087	0,075	0,058	0,110	0,095	0,073	0,132	0,114	0,088	0,153	0,133	0,102	0,164	0,142	0,109	0,174	0,151	0,116	0,186	0,161	0,124	●	○*	○

* = only suitable for DLC-coated cutters

53 700..., 53 701..., 53 702..., 53 703..., 53 704..., 53 705..., 53 706..., 53 707..., 53 560..., 53 561..., 53 562..., 53 563..., 53 564..., 53 565..., 53 566..., 53 567..., 53 568..., 53 569...																		● 1st choice ○ suitable						
Index	Ø DC (mm) =																		Emulsion	Compressed air	MMS			
	8,0			8,5–10,0			12,0			14,0			16,0			18,0						20,0		
	a _e 0,1–0,2 x DC	a _e 0,3–0,4 x DC	a _e 0,6–1,0 x DC	a _e 0,1–0,2 x DC	a _e 0,3–0,4 x DC	a _e 0,6–1,0 x DC	a _e 0,1–0,2 x DC	a _e 0,3–0,4 x DC	a _e 0,6–1,0 x DC	a _e 0,1–0,2 x DC	a _e 0,3–0,4 x DC	a _e 0,6–1,0 x DC	a _e 0,1–0,2 x DC	a _e 0,3–0,4 x DC	a _e 0,6–1,0 x DC	a _e 0,1–0,2 x DC	a _e 0,3–0,4 x DC	a _e 0,6–1,0 x DC						
f _t (mm)																								
N.1.1	0,078	0,068	0,052	0,098	0,085	0,065	0,119	0,103	0,079	0,138	0,120	0,092	0,149	0,129	0,099	0,158	0,137	0,105	0,168	0,146	0,112	●	○*	○
N.1.2	0,078	0,068	0,052	0,098	0,085	0,065	0,119	0,103	0,079	0,138	0,120	0,092	0,149	0,129	0,099	0,158	0,137	0,105	0,168	0,146	0,112	●	○*	○
N.2.1	0,071	0,061	0,047	0,087	0,075	0,058	0,105	0,091	0,070	0,122	0,105	0,081	0,130	0,112	0,087	0,138	0,120	0,092	0,147	0,127	0,098	●	○*	○
N.2.2	0,071	0,061	0,047	0,087	0,075	0,058	0,105	0,091	0,070	0,122	0,105	0,081	0,130	0,112	0,087	0,138	0,120	0,092	0,147	0,127	0,098	●	○*	○
N.2.3	0,071	0,061	0,047	0,087	0,075	0,058	0,105	0,091	0,070	0,122	0,105	0,081	0,130	0,112	0,087	0,138	0,120	0,092	0,147	0,127	0,098	●	○*	○
N.3.1	0,060	0,052	0,040	0,075	0,065	0,050	0,090	0,078	0,060	0,105	0,091	0,070	0,113	0,098	0,075	0,120	0,104	0,080	0,128	0,111	0,085	●	○*	○
N.3.2	0,060	0,052	0,040	0,075	0,065	0,050	0,090	0,078	0,060	0,105	0,091	0,070	0,113	0,098	0,075	0,120	0,104	0,080	0,128	0,111	0,085	●	○*	○
N.3.3	0,060	0,052	0,040	0,075	0,065	0,050	0,090	0,078	0,060	0,105	0,091	0,070	0,113	0,098	0,075	0,120	0,104	0,080	0,128	0,111	0,085	●	○*	○
N.4.1	0,071	0,061	0,047	0,087	0,075	0,058	0,105	0,091	0,070	0,122	0,105	0,081	0,130	0,112	0,087	0,138	0,120	0,092	0,147	0,127	0,098	●	○*	○

* = only suitable for DLC-coated cutters

Cutting data standard values – AluLine – Roughing-finishing milling cutter

Index	Type short / long		Medium-length version		53 582 ..., 53 583 ...														
	v _c (m/min)	a _{p,max} x DC	v _c (m/min)	a _{p,max} x DC	Ø DC (mm) =														
					3			4			5			6			8		
					a _e 0,1-0,2 x DC	a _e 0,3-0,4 x DC	a _e 0,6-1,0 x DC	a _e 0,1-0,2 x DC	a _e 0,3-0,4 x DC	a _e 0,6-1,0 x DC	a _e 0,1-0,2 x DC	a _e 0,3-0,4 x DC	a _e 0,6-1,0 x DC	a _e 0,1-0,2 x DC	a _e 0,3-0,4 x DC	a _e 0,6-1,0 x DC	a _e 0,1-0,2 x DC	a _e 0,3-0,4 x DC	a _e 0,6-1,0 x DC
f _z (mm)																			
N.1.1	600	1,0	480	0,8	0,114	0,099	0,076	0,131	0,113	0,087	0,147	0,127	0,098	0,162	0,140	0,108	0,195	0,169	0,130
N.1.2	600	1,0	480	0,8	0,114	0,099	0,076	0,131	0,113	0,087	0,147	0,127	0,098	0,162	0,140	0,108	0,195	0,169	0,130
N.2.1	360	1,0	290	0,8	0,082	0,071	0,055	0,098	0,085	0,065	0,113	0,098	0,075	0,129	0,112	0,086	0,162	0,140	0,108
N.2.2	360	1,0	290	0,8	0,082	0,071	0,055	0,098	0,085	0,065	0,113	0,098	0,075	0,129	0,112	0,086	0,162	0,140	0,108
N.2.3	240	1,0	190	0,8	0,082	0,071	0,055	0,098	0,085	0,065	0,113	0,098	0,075	0,129	0,112	0,086	0,162	0,140	0,108
N.3.1	240	1,0	190	0,8	0,049	0,042	0,033	0,065	0,056	0,043	0,081	0,070	0,054	0,098	0,085	0,065	0,129	0,112	0,086
N.3.2	240	1,0	190	0,8	0,049	0,042	0,033	0,065	0,056	0,043	0,081	0,070	0,054	0,098	0,085	0,065	0,129	0,112	0,086
N.3.3	170	1,0	135	0,8	0,049	0,042	0,033	0,065	0,056	0,043	0,081	0,070	0,054	0,098	0,085	0,065	0,129	0,112	0,086
N.4.1	220	1,0	175	0,8	0,082	0,071	0,055	0,098	0,085	0,065	0,113	0,098	0,075	0,129	0,112	0,086	0,162	0,140	0,108

Cutting data – AluLine – Ball Nosed End Mills

Index	Type short		Type long		Type extra long		53 607 ..., 53 608 ..., 53 609 ..., 53 610 ...														
	v _c (m/min)	a _{p,max} x DC	v _c (m/min)	a _{p,max} x DC	v _c (m/min)	a _{p,max} x DC	Ø DC (mm) =														
							3			4			5			6			8		
							a _e 0,1-0,2 x DC	a _e 0,3-0,4 x DC	a _e 0,6-1,0 x DC	a _e 0,1-0,2 x DC	a _e 0,3-0,4 x DC	a _e 0,6-1,0 x DC	a _e 0,1-0,2 x DC	a _e 0,3-0,4 x DC	a _e 0,6-1,0 x DC	a _e 0,1-0,2 x DC	a _e 0,3-0,4 x DC	a _e 0,6-1,0 x DC	a _e 0,1-0,2 x DC	a _e 0,3-0,4 x DC	a _e 0,6-1,0 x DC
f _z (mm)																					
N.1.1	750	0,03	450	0,02	225	0,015	0,035	0,030	0,023	0,047	0,040	0,031	0,059	0,051	0,039	0,071	0,061	0,047	0,095	0,082	0,063
N.1.2	750	0,03	450	0,02	225	0,015	0,035	0,030	0,023	0,047	0,040	0,031	0,059	0,051	0,039	0,071	0,061	0,047	0,095	0,082	0,063
N.2.1	600	0,03	360	0,02	180	0,015	0,033	0,029	0,022	0,044	0,038	0,029	0,054	0,047	0,036	0,066	0,057	0,044	0,087	0,075	0,058
N.2.2	600	0,03	360	0,02	180	0,015	0,033	0,029	0,022	0,044	0,038	0,029	0,054	0,047	0,036	0,066	0,057	0,044	0,087	0,075	0,058
N.2.3	400	0,03	240	0,02	120	0,015	0,033	0,029	0,022	0,044	0,038	0,029	0,054	0,047	0,036	0,066	0,057	0,044	0,087	0,075	0,058
N.3.1	180	0,03	110	0,02	55	0,015	0,024	0,021	0,016	0,032	0,028	0,022	0,041	0,035	0,027	0,050	0,043	0,033	0,066	0,057	0,044
N.3.2	180	0,03	110	0,02	55	0,015	0,024	0,021	0,016	0,032	0,028	0,022	0,041	0,035	0,027	0,050	0,043	0,033	0,066	0,057	0,044
N.3.3	230	0,03	140	0,02	70	0,015	0,024	0,021	0,016	0,032	0,028	0,022	0,041	0,035	0,027	0,050	0,043	0,033	0,066	0,057	0,044
N.4.1	350	0,03	210	0,02	105	0,015	0,033	0,029	0,022	0,044	0,038	0,029	0,054	0,047	0,036	0,066	0,057	0,044	0,087	0,075	0,058
O.1.1	65	0,03	40	0,03	40	0,03				0,135	0,104	0,075	0,200	0,149	0,100	0,240	0,179	0,120	0,300	0,224	0,150
O.1.2	240	0,03	145	0,03	145	0,03				0,135	0,104	0,075	0,200	0,149	0,100	0,240	0,179	0,120	0,300	0,224	0,150

Cutting data – AluLine – High Accuracy Finishing Cutters

Index	Type short		Type long		Type extra long		53 639 ...														
	v _c (m/min)	a _{p,max} x DC	v _c (m/min)	a _{p,max} x DC	v _c (m/min)	a _{p,max} x DC	Ø DC (mm) =														
							6			8			10			12			16		
							a _e < 0,02 x DC	a _e 0,02-0,04 x DC	a _e 0,05 x DC	a _e < 0,02 x DC	a _e 0,02-0,04 x DC	a _e 0,05 x DC	a _e < 0,02 x DC	a _e 0,02-0,04 x DC	a _e 0,05 x DC	a _e < 0,02 x DC	a _e 0,02-0,04 x DC	a _e 0,05 x DC	a _e < 0,02 x DC	a _e 0,02-0,04 x DC	a _e 0,05 x DC
f _z (mm)																					
N.1.1	500	400	300	2,0	0,036	0,031	0,024	0,047	0,040	0,031	0,056	0,049	0,038	0,067	0,058	0,045	0,083	0,072	0,055		
N.1.2	500	400	300	2,0	0,036	0,031	0,024	0,047	0,040	0,031	0,056	0,049	0,038	0,067	0,058	0,045	0,083	0,072	0,055		
N.2.1	300	240	180	2,0	0,027	0,023	0,018	0,036	0,031	0,024	0,045	0,039	0,030	0,054	0,047	0,036	0,068	0,059	0,045		
N.2.2	300	240	180	2,0	0,027	0,023	0,018	0,036	0,031	0,024	0,045	0,039	0,030	0,054	0,047	0,036	0,068	0,059	0,045		
N.2.3	210	170	125	2,0	0,027	0,023	0,018	0,036	0,031	0,024	0,045	0,039	0,030	0,054	0,047	0,036	0,068	0,059	0,045		
N.3.1	210	170	125	2,0	0,027	0,023	0,018	0,036	0,031	0,024	0,045	0,039	0,030	0,054	0,047	0,036	0,068	0,059	0,045		
N.3.2	210	170	125	2,0	0,027	0,023	0,018	0,036	0,031	0,024	0,045	0,039	0,030	0,054	0,047	0,036	0,068	0,059	0,045		
N.3.3	150	120	90	2,0	0,027	0,023	0,018	0,036	0,031	0,024	0,045	0,039	0,030	0,054	0,047	0,036	0,068	0,059	0,045		
N.4.1	200	160	120	2,0	0,027	0,023	0,018	0,036	0,031	0,024	0,045	0,039	0,030	0,054	0,047	0,036	0,068	0,059	0,045		

Index	53 582 ..., 53 583 ...												● 1st choice		
	Ø DC (mm) =												○ suitable		
	10			12			16			20			Emulsion	Compressed air	MMS
	a_e 0,1-0,2 x DC	a_e 0,3-0,4 x DC	a_e 0,6-1,0 x DC	a_e 0,1-0,2 x DC	a_e 0,3-0,4 x DC	a_e 0,6-1,0 x DC	a_e 0,1-0,2 x DC	a_e 0,3-0,4 x DC	a_e 0,6-1,0 x DC	a_e 0,1-0,2 x DC	a_e 0,3-0,4 x DC	a_e 0,6-1,0 x DC			
N.1.1	0,225	0,195	0,150	0,258	0,224	0,172	0,305	0,264	0,203	0,336	0,291	0,224	●		
N.1.2	0,225	0,195	0,150	0,258	0,224	0,172	0,305	0,264	0,203	0,336	0,291	0,224	●		
N.2.1	0,194	0,168	0,129	0,225	0,195	0,150	0,273	0,237	0,182	0,305	0,264	0,203	●		
N.2.2	0,194	0,168	0,129	0,225	0,195	0,150	0,273	0,237	0,182	0,305	0,264	0,203	●		
N.2.3	0,194	0,168	0,129	0,225	0,195	0,150	0,273	0,237	0,182	0,305	0,264	0,203	●		
N.3.1	0,161	0,139	0,107	0,194	0,168	0,129	0,240	0,208	0,160	0,272	0,235	0,181	●		
N.3.2	0,161	0,139	0,107	0,194	0,168	0,129	0,240	0,208	0,160	0,272	0,235	0,181	●		
N.3.3	0,161	0,139	0,107	0,194	0,168	0,129	0,240	0,208	0,160	0,272	0,235	0,181	●		
N.4.1	0,194	0,168	0,129	0,225	0,195	0,150	0,273	0,237	0,182	0,305	0,264	0,203	●		

Index	53 607 ..., 53 608 ..., 53 609 ..., 53 610 ...															● 1st choice		
	Ø DC (mm) =															○ suitable		
	10			12			14			16			20			Emulsion	Compressed air	MMS
	a_e 0,1-0,2 x DC	a_e 0,3-0,4 x DC	a_e 0,6-1,0 x DC	a_e 0,1-0,2 x DC	a_e 0,3-0,4 x DC	a_e 0,6-1,0 x DC	a_e 0,1-0,2 x DC	a_e 0,3-0,4 x DC	a_e 0,6-1,0 x DC	a_e 0,1-0,2 x DC	a_e 0,3-0,4 x DC	a_e 0,6-1,0 x DC	a_e 0,1-0,2 x DC	a_e 0,3-0,4 x DC	a_e 0,6-1,0 x DC			
N.1.1	0,120	0,104	0,080	0,144	0,125	0,096	0,168	0,146	0,112	0,180	0,156	0,120	0,206	0,178	0,137	●	○	
N.1.2	0,120	0,104	0,080	0,144	0,125	0,096	0,168	0,146	0,112	0,180	0,156	0,120	0,206	0,178	0,137	●	○	
N.2.1	0,110	0,095	0,073	0,132	0,114	0,088	0,153	0,133	0,102	0,164	0,142	0,109	0,186	0,161	0,124	●	○	
N.2.2	0,110	0,095	0,073	0,132	0,114	0,088	0,153	0,133	0,102	0,164	0,142	0,109	0,186	0,161	0,124	●	○	
N.2.3	0,110	0,095	0,073	0,132	0,114	0,088	0,153	0,133	0,102	0,164	0,142	0,109	0,186	0,161	0,124	●	○	
N.3.1	0,083	0,072	0,055	0,099	0,086	0,066	0,117	0,101	0,078	0,125	0,108	0,083	0,141	0,122	0,094	●	○	
N.3.2	0,083	0,072	0,055	0,099	0,086	0,066	0,117	0,101	0,078	0,125	0,108	0,083	0,141	0,122	0,094	●	○	
N.3.3	0,083	0,072	0,055	0,099	0,086	0,066	0,117	0,101	0,078	0,125	0,108	0,083	0,141	0,122	0,094	●	○	
N.4.1	0,110	0,095	0,073	0,132	0,114	0,088	0,153	0,133	0,102	0,164	0,142	0,109	0,186	0,161	0,124	●	○	
O.1.1	0,400	0,298	0,200	0,500	0,373	0,250	0,548	0,424	0,300	0,592	0,452	0,350	0,712	0,581	0,450	●	○	
O.1.2	0,400	0,298	0,200	0,500	0,373	0,250	0,548	0,424	0,300	0,592	0,452	0,350	0,712	0,581	0,450	●	○	

Index	53 639 ...			● 1st choice		
	Ø DC (mm) =			○ suitable		
	10			Emulsion	Compressed air	MMS
	a_e < 0,02 x DC	a_e 0,02-0,04 x DC	a_e 0,05 x DC			
N.1.1	0,092	0,080	0,062	●		○
N.1.2	0,092	0,080	0,062	●		○
N.2.1	0,077	0,066	0,051	●		○
N.2.2	0,077	0,066	0,051	●		○
N.2.3	0,077	0,066	0,051	●		○
N.3.1	0,077	0,066	0,051	●		○
N.3.2	0,077	0,066	0,051	●		○
N.3.3	0,077	0,066	0,051	●		○
N.4.1	0,077	0,066	0,051	●		○

Cutting data – Cutters for plastic machining

Index	Strength N/mm ² – HB	50 983 ..., 50 984 ..., 50 985 ..., 50 986 ..., 50 932 ...	50 937 ...	50 936 ...	50 938 ...	50 610 ..., 50 611 ..., 52 76. ...	50 91 ...	50 946 ...	50 948 ...	50 947 ...
		v _c (m/min)								
N.1.1	60 HB					400–450	400–450			
N.1.2	340 N/mm ² / 100 HB					400–450	400–450			
N.2.1	250 N/mm ² / 75 HB					350–400	350–400			
N.2.2	300 N/mm ² / 90 HB				300–400			300–400	300–400	300–400
N.2.3	440 N/mm ² / 130 HB				300–400			250–300	250–300	250–300
N.3.1	375 N/mm ² / 110 HB					350–400	350–400			
N.3.2	300 N/mm ² / 90 HB					400–450	400–450			
N.3.3	340 N/mm ² / 100 HB					400–450	400–450			
N.4.1	70 HB				250			250	250	250
O.1.1	≤ 150 N/mm ²					500–550	500–550			
O.1.2	≤ 100 N/mm ²					500–550	500–550			
O.2.1	≤ 1000 N/mm ²	150–200	150–200	500–600	150–200					
O.2.2	≤ 1000 N/mm ²	150–200	150–200	500–600	150–200					
O.3.1		300–400	500–600	500–600	300–400					

DC in mm	Plastics, Thermoset, Hardwood, Pressed Cardboard					Plastic, Thermoplast, Polycarbonate, Non-ferrous metal, Hard rubber				
	End milling cutter Type W			Ball nosed cutter Type W		End milling cutter Type W			Ball nosed cutter Type W	
	Shoulder milling, trimming		Slot milling	Copy milling - Line milling		Shoulder milling, trimming		Slot milling	Copy milling - Line milling	
	Roughing	Finishing		Roughing	Finishing	Roughing	Finishing		Roughing	Finishing
	a _p = 1,0 x DC	a _p = 1,0 x DC		a _e = 0,5 x DC	a _e = 0,03 x DC	a _e = 1,5 x DC	a _p = 1,0 x DC		a _e = 0,5 x DC	a _e = 0,03 x DC
a _e = 0,4 x DC	a _e = 0,1 x DC	a _e = 0,5 x DC	a _e = 0,02 x DC	a _e = 0,8 x DC	a _e = 0,1 x DC	a _e = 0,5 x DC	a _e = 0,02 x DC			
f _z (mm)										
2	0,024	0,018	0,016	0,028	0,024	0,024	0,022	0,017	0,037	0,030
3	0,036	0,027	0,024	0,042	0,036	0,036	0,033	0,026	0,056	0,045
4	0,048	0,036	0,032	0,056	0,048	0,048	0,044	0,034	0,074	0,060
5	0,060	0,045	0,040	0,070	0,060	0,060	0,055	0,043	0,093	0,075
6	0,072	0,054	0,048	0,084	0,072	0,072	0,066	0,051	0,111	0,090
8	0,100	0,070	0,060	0,110	0,100	0,100	0,090	0,070	0,150	0,120
10	0,120	0,090	0,080	0,140	0,120	0,120	0,110	0,090	0,190	0,150
12	0,140	0,110	0,100	0,170	0,140	0,140	0,130	0,100	0,220	0,180
14	0,170	0,130	0,110	0,200	0,170	0,170	0,150	0,120	0,260	0,210
16	0,190	0,140	0,130	0,220	0,190	0,190	0,180	0,140	0,300	0,240
18	0,220	0,160	0,140	0,250	0,220	0,220	0,200	0,150	0,330	0,270
20	0,240	0,180	0,160	0,280	0,240	0,240	0,220	0,170	0,370	0,300

DC in mm	Fiber reinforced plastics AFK, CFK, GFK			
	End mill staggered teeth			
	Shoulder milling, trimming		Slot milling	
	a _p = 1,0 x DC		a _p = 0,35 x DC	
	a _e = 0,4 x DC			
	fine	medium	fine	medium
f (mm/rev)				
2	0,16	0,14	0,14	0,12
3	0,24	0,21	0,21	0,18
4	0,32	0,28	0,28	0,24
5	0,40	0,35	0,35	0,30
6	0,48	0,42	0,42	0,36
8	0,64	0,56	0,56	0,48
10	0,80	0,70	0,70	0,60
12	0,96	0,84	0,84	0,72
16	1,28	1,12	1,12	0,96
20	1,60	1,40	1,40	1,20



Feedrate values for ball nosed and torus cutters on → page 486

Cutting data standard values – AluLine – NC deburring cutter

Index	v _c (m/min)	53 660 ..., 53 661 ..., 53 662 ..., 53 663 ...						v _c (m/min)	53 664 ..., 53 665 ..., 53 666 ..., 53 667 ...						● 1st choice ○ suitable		
		DLC							uncoated						Emulsion	Compressed air	MMS
		Ø DC (mm) =							Ø DC (mm) =								
		4	6	8	10	12	16		4	6	8	10	12	16			
f _z (mm)																	
N.1.1	300	0,03	0,04	0,05	0,06	0,07	0,08	195	0,02	0,03	0,04	0,05	0,06	0,07	●	○*	○
N.1.2	300	0,03	0,04	0,05	0,06	0,07	0,08	195	0,02	0,03	0,04	0,05	0,06	0,07	●	○*	○
N.2.1	260	0,03	0,04	0,05	0,06	0,07	0,08	170	0,02	0,03	0,04	0,05	0,06	0,07	●	○*	○
N.2.2	280	0,03	0,04	0,05	0,06	0,07	0,08	180	0,02	0,03	0,04	0,05	0,06	0,07	●	○*	○
N.2.3	250	0,03	0,04	0,05	0,06	0,07	0,08	165	0,02	0,03	0,04	0,05	0,06	0,07	●	○*	○
N.3.1	110	0,03	0,04	0,05	0,06	0,07	0,08	75	0,02	0,03	0,04	0,05	0,06	0,07	●	○*	○
N.3.2	140	0,03	0,04	0,05	0,06	0,07	0,08	90	0,02	0,03	0,04	0,05	0,06	0,07	●	○*	○
N.3.3	120	0,03	0,04	0,05	0,06	0,07	0,08	80	0,02	0,03	0,04	0,05	0,06	0,07	●	○*	○
N.4.1																	
O.1.1	320	0,03	0,04	0,05	0,06	0,07	0,08	195	0,02	0,03	0,04	0,05	0,06	0,07	●	○	○
O.1.2	320	0,03	0,04	0,05	0,06	0,07	0,08	195	0,02	0,03	0,04	0,05	0,06	0,07	●	○	○
O.2.1																	
O.2.2																	
O.3.1																	

* = only suitable for DLC-coated cutters

Cutting data standard values – BlueLine – NC deburring cutter

Index	v _c (m/min)	52 560 ..., 52 561 ..., 52 562 ..., 52 563 ...						● 1st choice ○ suitable		
		Ti2000						Emulsion	Compressed air	MMS
		Ø DC (mm) =								
		4	6	8	10	12	16			
f _z (mm)										
P.3.2	80	0,02	0,02	0,025	0,03	0,04	0,05		●	
P.3.3	70	0,02	0,02	0,025	0,03	0,04	0,05		●	
H.1.1	120	0,045	0,055	0,06	0,065	0,065	0,07		●	
H.1.2	90	0,04	0,05	0,055	0,06	0,06	0,065		●	
H.1.3	70	0,035	0,045	0,05	0,055	0,055	0,06		●	
H.1.4	50	0,025	0,03	0,04	0,045	0,045	0,05		●	
H.2.1										
H.3.1										

Cutting data standard values – BlueLine – Micro-end mill / micro-torus cutter

Index	$T_x \leq 2,5 \times DC$		52 345 ..., 52 346 ..., 52 347 ..., 52 349 ..., 52 350 ..., 52 351 ...												Compressed air
	v_c (m/min)	$a_{p,max} \times DC$	$\varnothing DC$ (mm) =												
			0,2	0,3	0,4–0,5	0,6–0,7	0,8–0,9	1,0	1,2–1,4	1,5	1,6–1,8	2,0	2,5	3,0	
			$a_e 0,05 \times DC$												
f_z (mm)															
P.3.2	190	0,5	0,0038	0,0045	0,0050	0,0078	0,0093	0,0131	0,0165	0,018	0,0195	0,0210	0,0225	0,0240	●
P.3.3	190	0,5	0,0038	0,0045	0,0050	0,0078	0,0093	0,0131	0,0165	0,018	0,0195	0,0210	0,0225	0,0240	●
H.1.1	120	0,5	0,0038	0,0045	0,0050	0,0078	0,0093	0,0131	0,0165	0,018	0,0195	0,0210	0,0225	0,0240	●
H.1.2	70	0,5	0,0030	0,0360	0,0045	0,0062	0,0074	0,0104	0,0132	0,0144	0,0156	0,0168	0,0180	0,0192	●
H.1.3	50	0,5	0,0025	0,0030	0,0040	0,0052	0,0062	0,0087	0,0110	0,0120	0,0130	0,0140	0,0150	0,0160	●
H.1.4															
H.2.1	190	0,5	0,0038	0,0045	0,0050	0,0078	0,0093	0,0131	0,0165	0,0180	0,0195	0,0210	0,0225	0,0240	●
H.3.1	70	0,5	0,0030	0,0360	0,0045	0,0062	0,0074	0,0104	0,0132	0,0144	0,0156	0,0168	0,0180	0,0192	●

Index	$T_x \leq 2,6-5,0 \times DC$		52 345 ..., 52 346 ..., 52 347 ..., 52 349 ..., 52 350 ..., 52 351 ...												Compressed air
	v_c (m/min)	$a_{p,max} \times DC$	$\varnothing DC$ (mm) =												
			0,2	0,3	0,4–0,5	0,6–0,7	0,8–0,9	1,0	1,2–1,4	1,5	1,6–1,8	2,0	2,5	3,0	
			$a_e 0,05 \times DC$												
f_z (mm)															
P.3.2	170	0,5	0,0038	0,0041	0,0045	0,0063	0,0075	0,0102	0,0134	0,0152	0,0158	0,0176	0,0195	0,0195	●
P.3.3	170	0,5	0,0038	0,0041	0,0045	0,0063	0,0075	0,0102	0,0134	0,0152	0,0158	0,0176	0,0195	0,0195	●
H.1.1	108	0,5	0,0038	0,0041	0,0045	0,0063	0,0075	0,0102	0,0134	0,0152	0,0158	0,0176	0,0195	0,0195	●
H.1.2	63	0,5	0,0030	0,0032	0,0036	0,0050	0,0060	0,0082	0,0107	0,0121	0,0126	0,0140	0,0156	0,0156	●
H.1.3	45	0,5	0,0025	0,0027	0,0030	0,0042	0,0050	0,0068	0,0089	0,0101	0,0105	0,0117	0,0130	0,0130	●
H.1.4															
H.2.1	170	0,5	0,0038	0,0041	0,0045	0,0063	0,0075	0,0102	0,0134	0,0152	0,0158	0,0176	0,0195	0,0195	●
H.3.1	63	0,5	0,0030	0,0032	0,0036	0,0050	0,0060	0,0082	0,0107	0,0121	0,0126	0,0140	0,0156	0,0156	●

Index	$T_x \leq 5,1-10,0 \times DC$		52 345 ..., 52 346 ..., 52 347 ..., 52 349 ..., 52 350 ..., 52 351 ...												Compressed air
	v_c (m/min)	$a_{p,max} \times DC$	$\varnothing DC$ (mm) =												
			0,2	0,3	0,4–0,5	0,6–0,7	0,8–0,9	1,0	1,2–1,4	1,5	1,6–1,8	2,0	2,5	3,0	
			$a_e 0,05 \times DC$												
f_z (mm)															
P.3.2	150	0,5	0,0030	0,0038	0,0045	0,0060	0,0068	0,0075	0,0083	0,0090	0,0105	0,0113	0,012	0,0128	●
P.3.3	150	0,5	0,0030	0,0038	0,0045	0,0060	0,0068	0,0075	0,0083	0,0090	0,0105	0,0113	0,012	0,0128	●
H.1.1	96	0,5	0,0030	0,0038	0,0045	0,0060	0,0068	0,0075	0,0083	0,0090	0,0105	0,0113	0,0120	0,0128	●
H.1.2	56	0,5	0,0024	0,0030	0,0036	0,0048	0,0054	0,0060	0,0066	0,0072	0,0084	0,0090	0,0096	0,0102	●
H.1.3	40	0,5	0,0020	0,0025	0,0030	0,0040	0,0045	0,0050	0,0055	0,0060	0,0070	0,0075	0,0080	0,0085	●
H.1.4															
H.2.1	150	0,5	0,0030	0,0038	0,0045	0,0060	0,0068	0,0075	0,0083	0,0090	0,0105	0,0113	0,0120	0,0128	●
H.3.1	56	0,5	0,0024	0,0030	0,0036	0,0048	0,0054	0,0060	0,0066	0,0072	0,0084	0,0090	0,0096	0,0102	●

Index	$T_x \leq 10,1-15,0 \times DC$		52 345 ..., 52 346 ..., 52 347 ..., 52 349 ..., 52 350 ..., 52 351 ...												Compressed air
	v_c (m/min)	$a_{p,max.} \times DC$	$\varnothing DC$ (mm) =												
			0,2	0,3	0,4-0,5	0,6-0,7	0,8-0,9	1,0	1,2-1,4	1,5	1,6-1,8	2,0	2,5	3,0	
			$a_e 0,05 \times DC$												
f_z (mm)															
P.3.2	114	0,5	0,0015	0,0023	0,0030	0,0038	0,0045	0,0048	0,0051	0,0054	0,0057	0,0060	0,0063	0,0066	●
P.3.3	114	0,5	0,0015	0,0023	0,0030	0,0038	0,0045	0,0048	0,0051	0,0054	0,0057	0,0060	0,0063	0,0066	●
H.1.1	72	0,5	0,0015	0,0023	0,0030	0,0038	0,0045	0,0048	0,0051	0,0054	0,0057	0,0060	0,0063	0,0066	●
H.1.2	42	0,5	0,0012	0,0018	0,0024	0,0030	0,0036	0,0038	0,0041	0,0043	0,0046	0,0048	0,0050	0,0053	●
H.1.3	30	0,5	0,0010	0,0015	0,0020	0,0025	0,0030	0,0032	0,0034	0,0036	0,0038	0,0040	0,0042	0,0044	●
H.1.4															
H.2.1	114	0,5	0,0015	0,0023	0,0030	0,0038	0,0045	0,0048	0,0051	0,0054	0,0057	0,0060	0,0063	0,0066	●
H.3.1	42	0,5	0,0012	0,0018	0,0024	0,0030	0,0036	0,0038	0,0041	0,0043	0,0046	0,0048	0,0050	0,0053	●

Index	$T_x \leq 15,1-20,0 \times DC$		52 345 ..., 52 346 ..., 52 347 ..., 52 349 ..., 52 350 ..., 52 351 ...												Compressed air
	v_c (m/min)	$a_{p,max.} \times DC$	$\varnothing DC$ (mm) =												
			0,2	0,3	0,4-0,5	0,6-0,7	0,8-0,9	1,0	1,2-1,4	1,5	1,6-1,8	2,0	2,5	3,0	
			$a_e 0,05 \times DC$												
f_z (mm)															
P.3.2	75	0,5	0,0015	0,0015	0,0023	0,003	0,0038	0,0045	0,0048	0,0051	0,0054	0,0057	0,0060	0,0063	●
P.3.3	75	0,5	0,0015	0,0015	0,0023	0,003	0,0038	0,0045	0,0048	0,0051	0,0054	0,0057	0,0060	0,0063	●
H.1.1	48	0,5	0,0015	0,0015	0,0023	0,0030	0,0038	0,0045	0,0048	0,0051	0,0054	0,0057	0,0060	0,0063	●
H.1.2	28	0,5	0,0012	0,0012	0,0018	0,0024	0,003	0,0036	0,0038	0,0041	0,0043	0,0046	0,0048	0,0050	●
H.1.3	20	0,5	0,0010	0,0010	0,0015	0,0020	0,0025	0,0030	0,0032	0,0034	0,0036	0,0038	0,0040	0,0042	●
H.1.4															
H.2.1	75	0,5	0,0015	0,0015	0,0023	0,0030	0,0038	0,0045	0,0048	0,0051	0,0054	0,0057	0,0060	0,0063	●
H.3.1	28	0,5	0,0012	0,0012	0,0018	0,0024	0,0030	0,0036	0,0038	0,0041	0,0043	0,0046	0,0048	0,0050	●

Index	$T_x \leq 20,1-30,0 \times DC$		52 345 ..., 52 346 ..., 52 347 ..., 52 349 ..., 52 350 ..., 52 351 ...												Compressed air
	v_c (m/min)	$a_{p,max.} \times DC$	$\varnothing DC$ (mm) =												
			0,2	0,3	0,4-0,5	0,6-0,7	0,8-0,9	1,0	1,2-1,4	1,5	1,6-1,8	2,0	2,5	3,0	
			$a_e 0,05 \times DC$												
f_z (mm)															
P.3.2	57	0,5	0,0010	0,002	0,0020	0,0030	0,0030	0,0030	0,0040	0,0040	0,0040	0,005	0,0050	0,0050	●
P.3.3	57	0,5	0,0010	0,002	0,0020	0,0030	0,0030	0,0030	0,0040	0,0040	0,0040	0,005	0,0050	0,0050	●
H.1.1	36	0,5	0,0010	0,002	0,0020	0,0030	0,0030	0,0030	0,0040	0,0040	0,0040	0,005	0,0050	0,0050	●
H.1.2	21	0,5	0,0010	0,001	0,0020	0,0020	0,0020	0,0030	0,0030	0,0030	0,0030	0,004	0,0040	0,0040	●
H.1.3	15	0,5	0,0008	0,001	0,0013	0,0017	0,0019	0,0022	0,0025	0,0027	0,0029	0,003	0,0031	0,0032	●
H.1.4															
H.2.1	57	0,5	0,0010	0,002	0,0020	0,0030	0,0030	0,0030	0,0040	0,0040	0,0040	0,005	0,0050	0,0050	●
H.3.1	21	0,5	0,0010	0,001	0,0020	0,0020	0,0020	0,0030	0,0030	0,0030	0,0030	0,004	0,0040	0,0040	●

Cutting data standard values – BlueLine – Micro-ball-nosed end mill

Index	$T_x \leq 2,5 \times DC$		52 356 ..., 52 357 ..., 52 358 ..., 52 359 ..., 52 360 ...												Compressed air
	v_c (m/min)	$a_{p,max.} \times DC$	$\varnothing DC$ (mm) =												
			0,2	0,3	0,4–0,5	0,6–0,7	0,8–0,9	1,0	1,2–1,4	1,5	1,6–1,8	2,0	2,5	3,0	
			$a_e 0,05 \times DC$												
f_z (mm)															
P.3.2	190	0,5	0,0015	0,0023	0,0030	0,0038	0,0045	0,0053	0,0060	0,0063	0,0066	0,0069	0,0072	0,0075	●
P.3.3	190	0,5	0,0015	0,0023	0,0030	0,0038	0,0045	0,0053	0,0060	0,0063	0,0066	0,0069	0,0072	0,0075	●
H.1.1	120	0,5	0,0015	0,0023	0,0030	0,0038	0,0045	0,0053	0,0060	0,0063	0,0066	0,0069	0,0072	0,0075	●
H.1.2	70	0,5	0,0012	0,0018	0,0024	0,0030	0,0036	0,0042	0,0048	0,0050	0,0053	0,0055	0,0058	0,0060	●
H.1.3	50	0,5	0,0010	0,0015	0,0020	0,0025	0,0030	0,0035	0,0040	0,0042	0,0044	0,0046	0,0048	0,0050	●
H.1.4															
H.2.1	190	0,5	0,0015	0,0023	0,0030	0,0038	0,0045	0,0053	0,0060	0,0063	0,0066	0,0069	0,0072	0,0075	●
H.3.1	70	0,5	0,0012	0,0018	0,0024	0,0030	0,0036	0,0042	0,0048	0,0050	0,0053	0,0055	0,0058	0,0060	●

Index	$T_x \leq 2,6-5,0 \times DC$		52 356 ..., 52 357 ..., 52 358 ..., 52 359 ..., 52 360 ...												Compressed air
	v_c (m/min)	$a_{p,max.} \times DC$	$\varnothing DC$ (mm) =												
			0,2	0,3	0,4–0,5	0,6–0,7	0,8–0,9	1,0	1,2–1,4	1,5	1,6–1,8	2,0	2,5	3,0	
			$a_e 0,05 \times DC$												
f_z (mm)															
P.3.2	170	0,5	0,0011	0,0014	0,0018	0,0023	0,0026	0,0029	0,0032	0,0035	0,0038	0,0041	0,0044	0,0048	●
P.3.3	170	0,5	0,0011	0,0014	0,0018	0,0023	0,0026	0,0029	0,0032	0,0035	0,0038	0,0041	0,0044	0,0048	●
H.1.1	108	0,5	0,0011	0,0014	0,0018	0,0023	0,0026	0,0029	0,0032	0,0035	0,0038	0,0041	0,0044	0,0048	●
H.1.2	63	0,5	0,0008	0,0011	0,0014	0,0018	0,0019	0,0021	0,0023	0,0025	0,0027	0,0029	0,0032	0,0038	●
H.1.3	45	0,5	0,0007	0,0009	0,0012	0,0015	0,0017	0,0019	0,0021	0,0023	0,0025	0,0027	0,0029	0,0032	●
H.1.4															
H.2.1	170	0,5	0,0011	0,0014	0,0018	0,0023	0,0026	0,0029	0,0032	0,0035	0,0038	0,0041	0,0044	0,0048	●
H.3.1	63	0,5	0,0008	0,0011	0,0014	0,0018	0,0019	0,0021	0,0023	0,0025	0,0027	0,0029	0,0032	0,0038	●

Index	$T_x \leq 5,1-10,0 \times DC$		52 356 ..., 52 357 ..., 52 358 ..., 52 359 ..., 52 360 ...												Compressed air
	v_c (m/min)	$a_{p,max.} \times DC$	$\varnothing DC$ (mm) =												
			0,2	0,3	0,4–0,5	0,6–0,7	0,8–0,9	1,0	1,2–1,4	1,5	1,6–1,8	2,0	2,5	3,0	
			$a_e 0,05 \times DC$												
f_z (mm)															
P.3.2	150	0,5	0,0006	0,0009	0,0012	0,0015	0,0018	0,0021	0,0024	0,0027	0,0030	0,0033	0,0036	0,0039	●
P.3.3	150	0,5	0,0006	0,0009	0,0012	0,0015	0,0018	0,0021	0,0024	0,0027	0,0030	0,0033	0,0036	0,0039	●
H.1.1	96	0,5	0,0006	0,0009	0,0012	0,0015	0,0018	0,0021	0,0024	0,0027	0,0030	0,0033	0,0036	0,0039	●
H.1.2	56	0,5	0,0005	0,0007	0,0010	0,0012	0,0014	0,0017	0,0019	0,0022	0,0024	0,0026	0,0029	0,0031	●
H.1.3	40	0,5	0,0004	0,0006	0,0008	0,0010	0,0012	0,0014	0,0016	0,0018	0,0020	0,0022	0,0024	0,0026	●
H.1.4															
H.2.1	150	0,5	0,0006	0,0009	0,0012	0,0015	0,0018	0,0021	0,0024	0,0027	0,0030	0,0033	0,0036	0,0039	●
H.3.1	56	0,5	0,0005	0,0007	0,0010	0,0012	0,0014	0,0017	0,0019	0,0022	0,0024	0,0026	0,0029	0,0031	●

Index	$T_x \leq 10,1-15,0 \times DC$		52 356 ..., 52 357 ..., 52 358 ..., 52 359 ..., 52 360 ...												Compressed air
	v_c (m/min)	$a_{p,max.} \times DC$	$\varnothing DC$ (mm) =												
			0,2	0,3	0,4-0,5	0,6-0,7	0,8-0,9	1,0	1,2-1,4	1,5	1,6-1,8	2,0	2,5	3,0	
			$a_p 0,05 \times DC$												
f_z (mm)															
P.3.2	114	0,5	0,0003	0,0006	0,0009	0,0012	0,0015	0,0018	0,0021	0,0024	0,0027	0,0030	0,0033	0,0036	●
P.3.3	114	0,5	0,0003	0,0006	0,0009	0,0012	0,0015	0,0018	0,0021	0,0024	0,0027	0,0030	0,0033	0,0036	●
H.1.1	72	0,5	0,0003	0,0006	0,0008	0,0012	0,0015	0,0018	0,0021	0,0024	0,0027	0,0030	0,0033	0,0036	●
H.1.2	42	0,5	0,0002	0,0005	0,0007	0,0010	0,0012	0,0014	0,0017	0,0019	0,0022	0,0022	0,0026	0,0029	●
H.1.3	30	0,5	0,0002	0,0004	0,0006	0,0008	0,0010	0,0012	0,0014	0,0016	0,0018	0,0020	0,0022	0,0024	●
H.1.4															
H.2.1	114	0,5	0,0003	0,0006	0,0008	0,0012	0,0015	0,0018	0,0021	0,0024	0,0027	0,0030	0,0033	0,0036	●
H.3.1	42	0,5	0,0002	0,0005	0,0007	0,0010	0,0012	0,0014	0,0017	0,0019	0,0022	0,0022	0,0026	0,0029	●

Index	$T_x \leq 15,1-20,0 \times DC$		52 356 ..., 52 357 ..., 52 358 ..., 52 359 ..., 52 360 ...												Compressed air
	v_c (m/min)	$a_{p,max.} \times DC$	$\varnothing DC$ (mm) =												
			0,2	0,3	0,4-0,5	0,6-0,7	0,8-0,9	1,0	1,2-1,4	1,5	1,6-1,8	2,0	2,5	3,0	
			$a_p 0,05 \times DC$												
f_z (mm)															
P.3.2	114	0,5	0,0002	0,0004	0,0006	0,0009	0,0012	0,0015	0,0018	0,0021	0,0024	0,0027	0,003	0,0033	●
P.3.3	114	0,5	0,0002	0,0004	0,0006	0,0009	0,0012	0,0015	0,0018	0,0021	0,0024	0,0027	0,003	0,0033	●
H.1.1	72	0,5	0,0002	0,0004	0,0005	0,0009	0,0012	0,0015	0,0018	0,0021	0,0024	0,0027	0,003	0,0033	●
H.1.2	42	0,5	0,0001	0,0003	0,0004	0,0007	0,0009	0,0011	0,0014	0,0016	0,0019	0,0019	0,0023	0,0026	●
H.1.3	30	0,5	0,0001	0,0002	0,0003	0,0005	0,0007	0,0009	0,0011	0,0013	0,0015	0,0017	0,0019	0,0021	●
H.1.4															
H.2.1	114	0,5	0,0002	0,0004	0,0005	0,0009	0,0012	0,0015	0,0018	0,0021	0,0024	0,0027	0,003	0,0033	●
H.3.1	42	0,5	0,0001	0,0003	0,0004	0,0007	0,0009	0,0011	0,0014	0,0016	0,0019	0,0021	0,0023	0,0026	●

Cutting data standard values – BlueLine – End mill

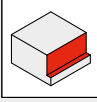
Index	52 140 ... 52 141 ...		 $a_{p,max.} \times DC$	52 133 ..., 52 134 ..., 52 140 ..., 52 141 ..., 52 324 ...										Compressed air
	v_c (m/min)			$\varnothing DC$ (mm) =										
				3	4	5	6	8	10	12	16	20		
				a_e 0,05 x DC										
		f_z (mm)												
P.3.2	190	160	1,0	0,018	0,020	0,022	0,024	0,025	0,030	0,035	0,038	0,040	●	
P.3.3	190	160	1,0	0,018	0,020	0,022	0,024	0,025	0,030	0,035	0,038	0,040	●	
H.1.1	160	140	1,0	0,013	0,013	0,016	0,018	0,020	0,023	0,025	0,029	0,032	●	
H.1.2	140	130	1,0	0,011	0,011	0,014	0,016	0,018	0,020	0,022	0,025	0,027	●	
H.1.3	100	90	1,0	0,010	0,010	0,012	0,014	0,016	0,018	0,020	0,023	0,025	●	
H.1.4														
H.2.1	190	160	1,0	0,018	0,020	0,022	0,024	0,025	0,030	0,035	0,038	0,040	●	
H.3.1	140	130	1,0	0,011	0,011	0,014	0,016	0,018	0,020	0,022	0,025	0,027	●	

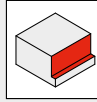
Index	52 135 ..., 52 136 ..., 52 325 ...		 $a_{p,max.} \times DC$	52 135 ..., 52 136 ..., 52 325 ...										Compressed air
	v_c (m/min)			$\varnothing DC$ (mm) =										
				3	4	5	6	8	10	12	16	20		
				a_e 0,05 x DC										
		f_z (mm)												
P.3.2	140	1,0	0,011	0,013	0,015	0,019	0,022	0,027	0,032	0,034	0,035	●		
P.3.3	140	1,0	0,011	0,013	0,015	0,019	0,022	0,027	0,032	0,034	0,035	●		
H.1.1	125	1,0	0,008	0,009	0,011	0,014	0,016	0,02	0,023	0,026	0,028	●		
H.1.2	115	1,0	0,007	0,008	0,009	0,012	0,014	0,017	0,02	0,023	0,025	●		
H.1.3	80	1,0	0,005	0,006	0,007	0,01	0,012	0,015	0,017	0,019	0,02	●		
H.1.4														
H.2.1	140	1,0	0,011	0,013	0,015	0,019	0,022	0,027	0,032	0,034	0,035	●		
H.3.1	115	1,0	0,007	0,008	0,009	0,012	0,014	0,017	0,02	0,023	0,025	●		

Index	52 344 ...		52 344 ...																		Compressed air
	v_c (m/min)		$\varnothing DC$ (mm) =																		
			0,5			1,0–1,5			2,0–2,5			3,0–3,5			4,0			5,0			
			a_e 0,1–0,2 x DC	a_e 0,3–0,4 x DC	a_e 0,6–1,0 x DC	a_e 0,1–0,2 x DC	a_e 0,3–0,4 x DC	a_e 0,6–1,0 x DC	a_e 0,1–0,2 x DC	a_e 0,3–0,4 x DC	a_e 0,6–1,0 x DC	a_e 0,1–0,2 x DC	a_e 0,3–0,4 x DC	a_e 0,6–1,0 x DC	a_e 0,1–0,2 x DC	a_e 0,3–0,4 x DC	a_e 0,6–1,0 x DC	a_e 0,1–0,2 x DC	a_e 0,3–0,4 x DC	a_e 0,6–1,0 x DC	
		f_z (mm)																			
P.3.2	120	0,5	0,006	0,004	0,004	0,008	0,006	0,005	0,011	0,008	0,006	0,016	0,012	0,009	0,022	0,017	0,012	0,027	0,020	0,014	●
P.3.3	120	0,5	0,006	0,004	0,004	0,008	0,006	0,005	0,011	0,008	0,006	0,016	0,012	0,009	0,022	0,017	0,012	0,027	0,020	0,014	●
H.1.1	80	0,5	0,006	0,004	0,004	0,008	0,006	0,005	0,011	0,008	0,006	0,016	0,012	0,009	0,022	0,017	0,012	0,027	0,020	0,014	●
H.1.2	60	0,5	0,004	0,004	0,003	0,006	0,005	0,004	0,009	0,007	0,005	0,013	0,010	0,007	0,017	0,013	0,010	0,022	0,016	0,011	●
H.1.3	50	0,5	0,004	0,003	0,002	0,005	0,004	0,003	0,007	0,006	0,004	0,011	0,008	0,006	0,014	0,011	0,008	0,018	0,013	0,009	●
H.1.4																					
H.2.1	120	0,5	0,006	0,004	0,004	0,008	0,006	0,005	0,011	0,008	0,006	0,016	0,012	0,009	0,022	0,017	0,012	0,027	0,020	0,014	●
H.3.1	60	0,5	0,004	0,004	0,003	0,006	0,005	0,004	0,009	0,007	0,005	0,013	0,010	0,007	0,017	0,013	0,010	0,022	0,016	0,011	●

Index	52 140 ... 52 141 ...		52 133 ... 52 134 ... 52 324 ...		52 133 ..., 52 134 ..., 52 140 ..., 52 141 ..., 52 324 ...									Compressed air
	v_c (m/min)		$a_{p,max.} \times DC$		$\varnothing DC$ (mm) =									
					3 4 5 6 8 10 12 16 20									
					a_p 0,6-1,0 x DC									
				f_z (mm)										
P.3.2	190	160	0,05		0,018	0,020	0,022	0,024	0,025	0,030	0,035	0,038	0,040	●
P.3.3	190	160	0,05		0,018	0,020	0,022	0,024	0,025	0,030	0,035	0,038	0,040	●
H.1.1	160	140	0,05		0,013	0,013	0,016	0,018	0,020	0,023	0,025	0,029	0,032	●
H.1.2	140	130	0,05		0,011	0,011	0,014	0,016	0,018	0,020	0,022	0,025	0,027	●
H.1.3	100	90	0,05		0,010	0,010	0,012	0,014	0,016	0,018	0,020	0,023	0,025	●
H.1.4														
H.2.1	190	160	0,05		0,018	0,020	0,022	0,024	0,025	0,030	0,035	0,038	0,040	●
H.3.1	140	130	0,05		0,011	0,011	0,014	0,016	0,018	0,020	0,022	0,025	0,027	●

Index	52 135 ... 52 136 ... 52 325 ...		52 135 ..., 52 136 ..., 52 325 ...										Compressed air		
	v_c (m/min)		$a_{p,max.} \times DC$		$\varnothing DC$ (mm) =										
					3 4 5 6 8 10 12 16 20										
					a_p 0,6-1,0 x DC										
				f_z (mm)											
P.3.2	140	0,05	0,011	0,013	0,015	0,019	0,022	0,027	0,032	0,034	0,035	●			
P.3.3	140	0,05	0,011	0,013	0,015	0,019	0,022	0,027	0,032	0,034	0,035	●			
H.1.1	125	0,05	0,008	0,009	0,011	0,014	0,016	0,02	0,023	0,026	0,028	●			
H.1.2	115	0,05	0,007	0,008	0,009	0,012	0,014	0,017	0,02	0,023	0,025	●			
H.1.3	80	0,05	0,005	0,006	0,007	0,01	0,012	0,015	0,017	0,019	0,02	●			
H.1.4															
H.2.1	140	0,05	0,011	0,013	0,015	0,019	0,022	0,027	0,032	0,034	0,035	●			
H.3.1	115	0,05	0,007	0,008	0,009	0,012	0,014	0,017	0,02	0,023	0,025	●			

Index	52 344 ...																		Compressed air
	$\varnothing DC$ (mm) =																		
	6,0			8,0			10,0			12,0			16,0			20,0			
	a_p 0,1-0,2 x DC	a_p 0,3-0,4 x DC	a_p 0,6-1,0 x DC	a_p 0,1-0,2 x DC	a_p 0,3-0,4 x DC	a_p 0,6-1,0 x DC	a_p 0,1-0,2 x DC	a_p 0,3-0,4 x DC	a_p 0,6-1,0 x DC	a_p 0,1-0,2 x DC	a_p 0,3-0,4 x DC	a_p 0,6-1,0 x DC	a_p 0,1-0,2 x DC	a_p 0,3-0,4 x DC	a_p 0,6-1,0 x DC	a_p 0,1-0,2 x DC	a_p 0,3-0,4 x DC	a_p 0,6-1,0 x DC	
f_z (mm)																			
P.3.2	0,036	0,027	0,018	0,048	0,036	0,024	0,054	0,040	0,027	0,06	0,045	0,030	0,076	0,058	0,045	0,095	0,077	0,060	●
P.3.3	0,036	0,027	0,018	0,048	0,036	0,024	0,054	0,040	0,027	0,06	0,045	0,030	0,076	0,058	0,045	0,095	0,077	0,060	●
H.1.1	0,036	0,027	0,018	0,048	0,036	0,024	0,054	0,040	0,027	0,06	0,045	0,030	0,076	0,058	0,045	0,095	0,077	0,060	●
H.1.2	0,029	0,021	0,014	0,038	0,029	0,019	0,043	0,032	0,022	0,048	0,036	0,024	0,061	0,046	0,036	0,076	0,062	0,048	●
H.1.3	0,024	0,018	0,012	0,032	0,024	0,016	0,036	0,027	0,018	0,040	0,030	0,020	0,051	0,039	0,030	0,063	0,052	0,040	●
H.1.4																			
H.2.1	0,036	0,027	0,018	0,048	0,036	0,024	0,054	0,040	0,027	0,060	0,045	0,030	0,076	0,058	0,045	0,095	0,077	0,060	●
H.3.1	0,029	0,021	0,014	0,038	0,029	0,019	0,043	0,032	0,022	0,048	0,036	0,024	0,061	0,046	0,036	0,076	0,062	0,048	●

Cutting data standard values – BlueLine – End mill

Index	v_c (m/min)	$a_{p,max.} \times DC$	52 348 ...												Compressed air
			$\varnothing DC$ (mm) =												
			6		8		10		12		16		20		
			a_e 0,05 x DC	a_e 0,1 x DC	a_e 0,05 x DC	a_e 0,1 x DC	a_e 0,05 x DC	a_e 0,1 x DC	a_e 0,05 x DC	a_e 0,1 x DC	a_e 0,05 x DC	a_e 0,1 x DC	a_e 0,05 x DC	a_e 0,1 x DC	
f_z (mm)															
P.3.2	120	2,0	0,025	0,021	0,029	0,024	0,031	0,027	0,036	0,032	0,042	0,038	0,049	0,045	●
P.3.3	120	2,0	0,025	0,021	0,029	0,024	0,031	0,027	0,036	0,032	0,042	0,038	0,049	0,045	●
H.1.1	100	2,0	0,025	0,021	0,029	0,024	0,031	0,027	0,036	0,032	0,042	0,038	0,049	0,045	●
H.1.2	90	2,0	0,021	0,017	0,024	0,019	0,027	0,022	0,030	0,025	0,035	0,030	0,041	0,036	●
H.1.3	60	2,0	0,014	0,011	0,016	0,013	0,018	0,015	0,021	0,018	0,025	0,022	0,030	0,027	●
H.1.4															
H.2.1	120	2,0	0,025	0,021	0,029	0,024	0,031	0,027	0,036	0,032	0,042	0,038	0,049	0,045	●
H.3.1	90	2,0	0,021	0,017	0,024	0,019	0,027	0,022	0,030	0,025	0,035	0,030	0,041	0,036	●

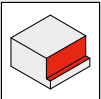
Index		v_c (m/min)	$a_{p,max.} \times DC$	52 353 ...										Compressed air
				$\varnothing DC$ (mm) =										
				1	2	3	4	5	6	8	10	12	16	
				a_e 0,05 x DC										
f_z (mm)														
P.3.2	200	0,5	0,008	0,015	0,030	0,045	0,060	0,075	0,090	0,105	0,120	0,135	●	
P.3.3	200	0,5	0,008	0,015	0,030	0,045	0,060	0,075	0,090	0,105	0,120	0,135	●	
H.1.1	170	0,5	0,008	0,015	0,030	0,045	0,060	0,075	0,090	0,105	0,120	0,135	●	
H.1.2	150	0,5	0,006	0,012	0,024	0,036	0,048	0,060	0,072	0,084	0,096	0,108	●	
H.1.3	110	0,5	0,005	0,010	0,020	0,030	0,040	0,050	0,060	0,070	0,080	0,090	●	
H.1.4														
H.2.1	200	0,5	0,008	0,015	0,030	0,045	0,060	0,075	0,090	0,105	0,120	0,135	●	
H.3.1	150	0,5	0,006	0,012	0,024	0,036	0,048	0,060	0,072	0,084	0,096	0,108	●	

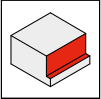
Index		v_c (m/min)	$a_{p,max.} \times DC$	52 354 ...										Compressed air
				$\varnothing DC$ (mm) =										
				1	2	3	4	5	6	8	10	12	16	
				a_e 0,05 x DC										
f_z (mm)														
P.3.2	200	0,5	0,005	0,008	0,015	0,023	0,030	0,038	0,045	0,053	0,060	0,068	●	
P.3.3	200	0,5	0,005	0,008	0,015	0,023	0,030	0,038	0,045	0,053	0,060	0,068	●	
H.1.1	170	0,5	0,005	0,008	0,015	0,023	0,030	0,038	0,045	0,053	0,060	0,068	●	
H.1.2	150	0,5	0,004	0,006	0,012	0,018	0,024	0,030	0,036	0,042	0,048	0,054	●	
H.1.3	110	0,5	0,003	0,005	0,010	0,015	0,020	0,025	0,03	0,035	0,040	0,045	●	
H.1.4														
H.2.1	200	0,5	0,005	0,008	0,015	0,023	0,030	0,038	0,045	0,053	0,060	0,068	●	
H.3.1	150	0,5	0,004	0,006	0,012	0,018	0,024	0,030	0,036	0,042	0,048	0,054	●	

Index	v _c (m/min)	a _{p max.} x DC	52 353 ...											Compressed air
			Ø DC (mm) =											
			1	2	3	4	5	6	8	10	12	16		
			a _e 0,6–1,0 x DC											
f _z (mm)														
P.3.2	200	0,05	0,008	0,015	0,030	0,045	0,06	0,075	0,090	0,105	0,120	0,135	●	
P.3.3	200	0,05	0,008	0,015	0,030	0,045	0,06	0,075	0,090	0,105	0,120	0,135	●	
H.1.1	170	0,05	0,008	0,015	0,030	0,045	0,06	0,075	0,090	0,105	0,120	0,135	●	
H.1.2	150	0,05	0,006	0,012	0,024	0,036	0,048	0,060	0,072	0,084	0,096	0,108	●	
H.1.3	110	0,05	0,005	0,010	0,020	0,030	0,040	0,050	0,060	0,070	0,080	0,090	●	
H.1.4														
H.2.1	200	0,05	0,008	0,015	0,030	0,045	0,060	0,075	0,090	0,105	0,120	0,135	●	
H.3.1	150	0,05	0,006	0,012	0,024	0,036	0,048	0,060	0,072	0,084	0,096	0,108	●	

Index	v _c (m/min)	a _{p max.} x DC	52 354 ...											Compressed air
			Ø DC (mm) =											
			1	2	3	4	5	6	8	10	12	16		
			a _e 0,6–1,0 x DC											
f _z (mm)														
P.3.2	200	0,05	0,005	0,008	0,015	0,023	0,030	0,038	0,045	0,053	0,060	0,068	●	
P.3.3	200	0,05	0,005	0,008	0,015	0,023	0,030	0,038	0,045	0,053	0,060	0,068	●	
H.1.1	170	0,05	0,005	0,008	0,015	0,023	0,030	0,038	0,045	0,053	0,060	0,068	●	
H.1.2	150	0,05	0,004	0,006	0,012	0,018	0,024	0,030	0,036	0,042	0,048	0,054	●	
H.1.3	110	0,05	0,003	0,005	0,010	0,015	0,020	0,025	0,030	0,035	0,040	0,045	●	
H.1.4														
H.2.1	200	0,05	0,005	0,008	0,015	0,023	0,030	0,038	0,045	0,053	0,060	0,068	●	
H.3.1	150	0,05	0,004	0,006	0,012	0,018	0,024	0,030	0,036	0,042	0,048	0,054	●	

Cutting data standard values – BlueLine – Ball-nosed end mill

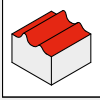
Index		52 258 ..., 52 259 ...										
		Ø DC (mm) =										
		0,1–0,5	0,6–1,0	1,5–2,0	2,5	3,0	4,0	5,0	6,0	8,0	10,0	
		a_e 0,05 x DC										
v_c (m/min)	$a_{p,max.} \times DC$	f_z (mm)										
P.3.2	190	0,05	0,008	0,010	0,012	0,016	0,020	0,025	0,030	0,040	0,050	0,060
P.3.3	190	0,05	0,008	0,010	0,012	0,016	0,020	0,025	0,030	0,040	0,050	0,060
H.1.1	165	0,05	0,004	0,005	0,006	0,008	0,010	0,014	0,017	0,028	0,038	0,048
H.1.2	145	0,05	0,004	0,004	0,005	0,006	0,008	0,012	0,015	0,025	0,035	0,045
H.1.3	105	0,05	0,003	0,004	0,005	0,005	0,006	0,010	0,014	0,022	0,030	0,040
H.1.4												
H.2.1	190	0,05	0,008	0,010	0,012	0,016	0,020	0,025	0,030	0,040	0,050	0,060
H.3.1	145	0,05	0,004	0,004	0,005	0,006	0,008	0,012	0,015	0,025	0,035	0,045

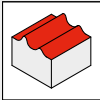
Index		52 256 ..., 52 257 ..., 52 302 ..., 52 303 ..., 52 404 ..., 52 405 ...										
		Ø DC (mm) =										
		0,1–0,5	0,6–1,0	1,1–1,5	1,6–2,0	2,5	3,0	4,0	5,0	6,0	7,0	
		a_e 0,05 x DC										
v_c (m/min)	$a_{p,max.} \times DC$	f_z (mm)										
P.3.2	200	0,05	0,010	0,012	0,015	0,019	0,025	0,030	0,033	0,036	0,040	0,040
P.3.3	200	0,05	0,010	0,012	0,015	0,019	0,025	0,030	0,033	0,036	0,040	0,040
H.1.1	170	0,05	0,005	0,006	0,006	0,008	0,011	0,015	0,020	0,024	0,027	0,035
H.1.2	150	0,05	0,005	0,006	0,006	0,008	0,010	0,013	0,018	0,022	0,025	0,032
H.1.3	110	0,05	0,004	0,005	0,005	0,007	0,009	0,013	0,016	0,021	0,025	0,030
H.1.4												
H.2.1	200	0,05	0,010	0,012	0,015	0,019	0,025	0,030	0,033	0,036	0,040	0,040
H.3.1	150	0,05	0,005	0,006	0,006	0,008	0,010	0,013	0,018	0,022	0,025	0,032

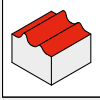
Index		52 355 ...													Compressed air
		Ø DC (mm) =													
		0,6–0,8	1,0	1,2–1,5	2,0	2,0	3,0	4,0	5,0	6,0	8,0	10,0	12,0		
		a_e 0,05 x DC													
v_c (m/min)	$a_{p,max.} \times DC$	f_z (mm)													
P.3.2	200	0,05	0,006	0,008	0,010	0,015	0,030	0,045	0,060	0,075	0,090	0,105	0,120	0,120	●
P.3.3	200	0,05	0,006	0,008	0,010	0,015	0,030	0,045	0,060	0,075	0,090	0,105	0,120	0,120	●
H.1.1	170	0,05	0,006	0,008	0,010	0,015	0,030	0,045	0,060	0,075	0,090	0,105	0,120	0,105	●
H.1.2	150	0,05	0,004	0,006	0,008	0,012	0,024	0,036	0,048	0,060	0,072	0,084	0,096	0,100	●
H.1.3	110	0,05	0,004	0,005	0,007	0,010	0,020	0,030	0,040	0,050	0,060	0,070	0,080	0,090	●
H.1.4															
H.2.1	200	0,05	0,006	0,008	0,010	0,015	0,030	0,045	0,060	0,075	0,090	0,105	0,120	0,120	●
H.3.1	150	0,05	0,004	0,006	0,008	0,012	0,024	0,036	0,048	0,060	0,072	0,084	0,096	0,100	●

	Index	52 258 ..., 52 259 ...			Compressed air
		Ø DC (mm) =			
		12,0	16,0	20,0	
		a _e 0,05 x DC			
	f _z (mm)				
	P.3.2	0,070	0,090	0,10	●
	P.3.3	0,070	0,090	0,10	●
	H.1.1	0,058	0,078	0,09	●
	H.1.2	0,055	0,075	0,08	●
	H.1.3	0,050	0,070	0,07	●
	H.1.4				
	H.2.1	0,070	0,090	0,10	●
	H.3.1	0,055	0,075	0,08	●

	Index	52 258 ..., 52 259 ...							Compressed air
		Ø DC (mm) =							
		8,0	9,0	10,0	12,0	14,0	16,0	20,0	
		a _e 0,05 x DC							
	f _z (mm)								
	P.3.2	0,050	0,06	0,07	0,08	0,09	0,100	0,120	●
	P.3.3	0,050	0,06	0,07	0,08	0,09	0,100	0,120	●
	H.1.1	0,042	0,048	0,058	0,068	0,078	0,088	0,105	●
	H.1.2	0,039	0,045	0,055	0,065	0,075	0,085	0,100	●
	H.1.3	0,035	0,040	0,050	0,060	0,070	0,080	0,090	●
	H.1.4								
	H.2.1	0,050	0,060	0,070	0,080	0,090	0,100	0,120	●
	H.3.1	0,039	0,045	0,055	0,065	0,075	0,085	0,100	●

Cutting data standard values – BlueLine – Torus cutter

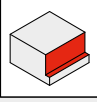
Index		52 304 ...										Compressed air
		Ø DC (mm) =										
		0,5-1,5	2,0-3,0	4,0	5,0	6,0	8,0	10,0	12,0	16,0		
		a _p 0,05 x DC										
v _c (m/min)		a _{p,max.} x DC	f _z (mm)									
P.3.2	190	1,0	0,012	0,028	0,055	0,055	0,065	0,075	0,090	0,100	0,120	●
P.3.3	190	1,0	0,012	0,028	0,055	0,055	0,065	0,075	0,090	0,100	0,120	●
H.1.1	160	1,0	0,007	0,023	0,040	0,040	0,055	0,070	0,082	0,090	0,110	●
H.1.2	140	1,0	0,006	0,020	0,038	0,038	0,052	0,065	0,080	0,085	0,105	●
H.1.3	100	1,0	0,005	0,018	0,035	0,035	0,050	0,060	0,075	0,080	0,100	●
H.1.4												
H.2.1	190	1,0	0,012	0,028	0,055	0,055	0,065	0,075	0,090	0,100	0,120	●
H.3.1	140	1,0	0,006	0,020	0,038	0,038	0,052	0,065	0,080	0,085	0,105	●

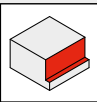
Index		52 305 ...							Compressed air
		Ø DC (mm) =							
		1,0-1,5	2,0	3,0	4,0	5,30	6,0		
		a _p 0,05 x DC							
v _c (m/min)		a _{p,max.} x DC	f _z (mm)						
P.3.2	190	1,0	0,010	0,025	0,025	0,050	0,050	0,060	●
P.3.3	190	1,0	0,010	0,025	0,025	0,050	0,050	0,060	●
H.1.1	160	1,0	0,005	0,020	0,020	0,035	0,035	0,050	●
H.1.2	140	1,0	0,004	0,017	0,017	0,033	0,033	0,053	●
H.1.3	100	1,0	0,003	0,015	0,015	0,030	0,030	0,005	●
H.1.4									
H.2.1	190	1,0	0,010	0,025	0,025	0,050	0,050	0,060	●
H.3.1	140	1,0	0,004	0,017	0,017	0,033	0,033	0,053	●

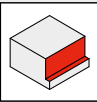
Index		52 361 ...										Compressed air
		Ø DC (mm) =										
		0,8-1,0	1,2-1,5	2,0	3,0	4,0	6,0	8,0	10,0	12,0		
		a _p 0,05 x DC										
v _c (m/min)		a _{p,max.} x DC	f _z (mm)									
P.3.2	200	0,5	0,008	0,010	0,015	0,030	0,045	0,075	0,090	0,105	0,120	●
P.3.3	200	0,5	0,008	0,010	0,015	0,030	0,045	0,075	0,090	0,105	0,120	●
H.1.1	170	0,5	0,008	0,010	0,015	0,030	0,045	0,075	0,090	0,105	0,120	●
H.1.2	150	0,5	0,006	0,008	0,012	0,024	0,036	0,060	0,072	0,084	0,096	●
H.1.3	110	0,5	0,005	0,007	0,010	0,020	0,030	0,050	0,060	0,070	0,080	●
H.1.4												
H.2.1	200	0,5	0,008	0,010	0,015	0,030	0,045	0,075	0,090	0,105	0,120	●
H.3.1	150	0,5	0,006	0,008	0,012	0,024	0,036	0,060	0,072	0,084	0,096	●

Index	v _c (m/min)	a _{p,max.} x DC	52 304 ...										Compressed air
			Ø DC (mm) =										
			0,5-1,5	2,0-3,0	4,0	5,0	6,0	8,0	10,0	12,0	16,0		
			a _e 0,05 x DC										
f _z (mm)													
P.3.2	190	0,05	0,016	0,032	0,060	0,060	0,080	0,090	0,100	0,120	0,140	●	
P.3.3	190	0,05	0,016	0,032	0,060	0,060	0,080	0,090	0,100	0,120	0,140	●	
H.1.1	160	0,05	0,011	0,028	0,050	0,050	0,070	0,080	0,090	0,100	0,130	●	
H.1.2	140	0,05	0,010	0,025	0,044	0,044	0,070	0,075	0,088	0,085	0,125	●	
H.1.3	100	0,05	0,009	0,021	0,040	0,040	0,065	0,070	0,085	0,080	0,120	●	
H.1.4													
H.2.1	190	0,05	0,016	0,032	0,060	0,060	0,080	0,090	0,100	0,120	0,140	●	
H.3.1	140	0,05	0,010	0,025	0,044	0,044	0,070	0,075	0,088	0,085	0,125	●	

Index	v _c (m/min)	a _{p,max.} x DC	52 305 ...							Compressed air
			Ø DC (mm) =							
			1,0-1,5	2,0	3,0	4,0	5,30	6,0		
			a _e 0,05 x DC							
f _z (mm)										
P.3.2	190	0,05	0,014	0,030	0,030	0,055	0,055	0,070	●	
P.3.3	190	0,05	0,014	0,030	0,030	0,055	0,055	0,070	●	
H.1.1	160	0,05	0,009	0,025	0,025	0,045	0,045	0,060	●	
H.1.2	140	0,05	0,008	0,022	0,022	0,040	0,040	0,058	●	
H.1.3	100	0,05	0,007	0,018	0,018	0,035	0,035	0,050	●	
H.1.4										
H.2.1	190	0,05	0,014	0,030	0,030	0,055	0,055	0,070	●	
H.3.1	140	0,05	0,008	0,022	0,022	0,040	0,040	0,058	●	

Index	v _c (m/min)	a _{p,max.} x DC	52 361 ...										Compressed air
			Ø DC (mm) =										
			0,8-1,0	1,2-1,5	2,0	3,0	4,0	6,0	8,0	10,0	12,0		
			a _e 0,05 x DC										
f _z (mm)													
P.3.2	200	0,05	0,008	0,010	0,015	0,030	0,045	0,075	0,090	0,105	0,120	●	
P.3.3	200	0,05	0,008	0,010	0,015	0,030	0,045	0,075	0,090	0,105	0,120	●	
H.1.1	170	0,05	0,008	0,010	0,015	0,030	0,045	0,075	0,090	0,105	0,120	●	
H.1.2	150	0,05	0,006	0,008	0,012	0,024	0,036	0,060	0,072	0,084	0,096	●	
H.1.3	110	0,05	0,005	0,007	0,010	0,020	0,030	0,050	0,060	0,070	0,080	●	
H.1.4													
H.2.1	200	0,05	0,008	0,010	0,015	0,030	0,045	0,075	0,090	0,105	0,120	●	
H.3.1	150	0,05	0,006	0,008	0,012	0,024	0,036	0,060	0,072	0,084	0,096	●	

Cutting data standard values – Micro cutter – 2.2xDC

Index	52 802 ..., 52 804 ..., 52 806 ...																	
	Ø DC (mm) = 0,2–0,4						Ø DC (mm) = 0,5–0,7						Ø DC (mm) = 0,8–0,9					
	a _e	0,1 x DC	0,2 x DC	0,3 x DC	0,4 x DC	0,6–1,0 x DC	a _e	0,1 x DC	0,2 x DC	0,3 x DC	0,4 x DC	0,6–1,0 x DC	a _e	0,1 x DC	0,2 x DC	0,3 x DC	0,4 x DC	0,6–1,0 x DC
	a _{p max.}	0,02	0,02	0,02	0,01	0,01	a _{p max.}	0,1	0,1	0,1	0,1	0,05	a _{p max.}	0,2	0,2	0,2	0,2	0,12
	n _{min.}	30.000					n _{min.}	12.000					n _{min.}	8.000				
n	v _r (mm/min)					n	v _r (mm/min)					n	v _r (mm/min)					
P.1.1	50.000	232	202	174	144	116	50.000	274	238	205	170	137	50.000	485	422	364	301	242
P.1.2	50.000	232	202	174	144	116	50.000	274	238	205	170	137	50.000	485	422	364	301	242
P.1.3	50.000	232	202	174	144	116	50.000	274	238	205	170	137	50.000	485	422	364	301	242
P.1.4	50.000	201	175	151	125	101	50.000	237	206	178	147	119	50.000	420	365	315	260	210
P.1.5	50.000	201	175	151	125	101	50.000	237	206	178	147	119	50.000	420	365	315	260	210
P.2.1	50.000	232	202	174	144	116	50.000	274	238	205	170	137	50.000	485	422	364	301	242
P.2.2	50.000	232	202	174	144	116	50.000	274	238	205	170	137	50.000	485	422	364	301	242
P.2.3	50.000	201	175	151	125	101	50.000	237	206	178	147	119	50.000	420	365	315	260	210
P.2.4	50.000	201	175	151	125	101	50.000	237	206	178	147	119	50.000	420	365	315	260	210
P.3.1	50.000	201	175	151	125	101	50.000	237	206	178	147	119	50.000	420	365	315	260	210
P.3.2	50.000	232	202	174	144	116	50.000	274	238	205	170	137	50.000	485	422	364	301	242
P.3.3	50.000	201	175	151	125	101	50.000	237	206	178	147	119	50.000	420	365	315	260	210
P.4.1	50.000	232	202	174	144	116	50.000	274	238	205	170	137	50.000	485	422	364	301	242
P.4.2	50.000	232	202	174	144	116	50.000	274	238	205	170	137	50.000	485	422	364	301	242
M.1.1	50.000	232	202	174	144	116	50.000	274	238	205	170	137	50.000	485	422	364	301	242
M.2.1	50.000	232	202	174	144	116	50.000	274	238	205	170	137	50.000	485	422	364	301	242
M.3.1	50.000	232	202	174	144	116	50.000	274	238	205	170	137	50.000	485	422	364	301	242
K.1.1	50.000	232	202	174	144	116	50.000	274	238	205	170	137	50.000	485	422	364	301	242
K.1.2	50.000	232	202	174	144	116	50.000	274	238	205	170	137	50.000	485	422	364	301	242
K.2.1	50.000	232	202	174	144	116	50.000	274	238	205	170	137	50.000	485	422	364	301	242
K.2.2	50.000	232	202	174	144	116	50.000	274	238	205	170	137	50.000	485	422	364	301	242
K.3.1	50.000	141	123	106	88	71	50.000	175	152	131	109	88	32.000	285	248	213	176	142
K.3.2	50.000	141	123	106	88	71	50.000	175	152	131	109	88	32.000	285	248	213	176	142
N.1.1	50.000	232	202	174	144	116	50.000	274	238	205	170	137	50.000	582	506	436	361	291
N.1.2	50.000	232	202	174	144	116	50.000	274	238	205	170	137	50.000	582	506	436	361	291
N.2.1																		
N.2.2																		
N.2.3																		
N.3.1	50.000	232	202	174	144	116	50.000	274	238	205	170	137	44.000	485	422	364	301	242
N.3.2	50.000	232	202	174	144	116	50.000	274	238	205	170	137	50.000	582	506	436	361	291
N.3.3	50.000	232	202	174	144	116	50.000	274	238	205	170	137	50.000	582	506	436	361	291
N.4.1	50.000	212	185	159	132	106	50.000	250	218	188	155	125	50.000	531	462	398	329	266
S.1.1	50.000	46	40	35	29	23	30.000	55	48	41	34	27	19.000	69	60	51	43	34
S.1.2	50.000	46	40	35	29	23	30.000	55	48	41	34	27	19.000	69	60	51	43	34
S.2.1	50.000	72	62	54	44	36	50.000	89	77	66	55	44	25.000	91	79	68	56	45
S.2.2	50.000	46	40	35	29	23	30.000	55	48	41	34	27	19.000	69	60	51	43	34
S.2.3	50.000	54	47	41	34	27	30.000	66	57	49	41	33	12.000	78	68	59	49	39
S.3.1	50.000	114	99	85	71	57	50.000	164	143	123	102	82	44.000	114	99	85	71	57
S.3.2	50.000	114	99	85	71	57	50.000	164	143	123	102	82	44.000	164	143	123	102	82
S.3.3	50.000	70	61	53	43	35	50.000	85	74	64	53	42	38.000	101	88	76	63	51
H.1.1	50.000	219	191	164	136	110	50.000	232	202	174	144	116	50.000	388	338	291	241	194
H.1.2	50.000	201	175	151	125	101	50.000	285	248	213	176	142	38.000	336	292	252	208	168
H.1.3	50.000	114	99	85	71	57	50.000	134	117	101	83	67	25.000	156	136	117	97	78
H.1.4	50.000	107	93	80	67	54	50.000	126	110	95	78	63	25.000	141	123	106	88	71
H.2.1	50.000	219	191	164	136	110	50.000	232	202	174	144	116	50.000	388	338	291	241	194
H.3.1	50.000	201	175	151	125	101	50.000	285	248	213	176	142	38.000	336	292	252	208	168
O.1.1	50.000	232	202	174	144	116	50.000	274	238	205	170	137	50.000	582	506	436	361	291
O.1.2	50.000	232	202	174	144	116	50.000	274	238	205	170	137	50.000	582	506	436	361	291
O.2.1	50.000	212	185	159	132	106	50.000	200	174	150	124	100	38.000	316	275	237	196	158
O.2.2	50.000	212	185	159	132	106	50.000	200	174	150	124	100	38.000	316	275	237	196	158
O.3.1																		

Index	52 802 ..., 52 804 ..., 52 806 ...												● 1st choice ○ suitable			
	Ø DC (mm) = 1,0–1,4						Ø DC (mm) = 1,5–1,7						Emulsion	Compressed air	MMS	
	a _e	0,1 x DC	0,2 x DC	0,3 x DC	0,4 x DC	0,6–1,0 x DC	a _e	0,1 x DC	0,2 x DC	0,3 x DC	0,4 x DC	0,6–1,0 x DC				
	a _{p max.}	0,3	0,3	0,3	0,3	0,2	a _{p max.}	0,45	0,45	0,45	0,45	0,3				
	n _{min.}	6.500						n _{min.}	6.500							
n	v _r (mm/min)						n	v _r (mm/min)								
P.1.1	50.000	775	674	581	480	387	33.000	1200	1044	900	744	600	●	○	○	
P.1.2	50.000	775	674	581	480	387	33.000	1200	1044	900	744	600	●	○	○	
P.1.3	50.000	775	674	581	480	387	33.000	1200	1044	900	744	600	●	○	○	
P.1.4	50.000	671	584	503	416	335	33.000	1039	904	779	644	520	●	○	○	
P.1.5	50.000	671	584	503	416	335	33.000	1039	904	779	644	520	●	○	○	
P.2.1	50.000	775	674	581	480	387	33.000	1200	1044	900	744	600		●	○	
P.2.2	50.000	775	674	581	480	387	33.000	1200	1044	900	744	600		●	○	
P.2.3	50.000	671	584	503	416	335	33.000	1039	904	779	644	520		●	○	
P.2.4	50.000	671	584	503	416	335	33.000	1039	904	779	644	520		●	○	
P.3.1	50.000	671	584	503	416	335	33.000	1039	904	779	644	520		●	○	
P.3.2	50.000	775	674	581	480	387	33.000	1200	1044	900	744	600		●	○	
P.3.3	50.000	671	584	503	416	335	33.000	1039	904	779	644	520		●	○	
P.4.1	50.000	775	674	581	480	387	33.000	1200	1044	900	744	600		●	○	
P.4.2	50.000	775	674	581	480	387	33.000	1200	1044	900	744	600		●	○	
M.1.1	50.000	775	674	581	480	387	33.000	1200	1044	900	744	600	●		○	
M.2.1	50.000	775	674	581	480	387	33.000	1200	1044	900	744	600	●		○	
M.3.1	50.000	775	674	581	480	387	33.000	1200	1044	900	744	600	●		○	
K.1.1	50.000	775	674	581	480	387	33.000	1200	1044	900	744	600	○	●		
K.1.2	50.000	775	674	581	480	387	33.000	1200	1044	900	744	600	○	●		
K.2.1	50.000	775	674	581	480	387	33.000	1200	1044	900	744	600	○	●		
K.2.2	50.000	775	674	581	480	387	33.000	1200	1044	900	744	600	○	●		
K.3.1	50.000	389	338	292	241	194	21.000	548	477	411	340	274		●		
K.3.2	25000	389	338	292	241	194	21.000	548	477	411	340	274		●		
N.1.1	50.000	930	809	697	576	465	50.000	1500	1305	1125	930	750	●		○	
N.1.2	50.000	930	809	697	576	465	50.000	1500	1305	1125	930	750	●		○	
N.2.1																
N.2.2																
N.2.3																
N.3.1	44.000	775	674	581	480	387	29.000	1160	1009	870	719	580	●		○	
N.3.2	50.000	930	809	697	576	465	38.000	1400	1218	1050	868	700	●		○	
N.3.3	50.000	930	809	697	576	465	38.000	1400	1218	1050	868	700	●		○	
N.4.1	50.000	849	738	636	526	424	38.000	1388	1207	1041	860	694	●		○	
S.1.1	15.000	99	86	74	61	49	12.000	170	148	127	105	85	●		○	
S.1.2	15.000	99	86	74	61	49	12.000	170	148	127	105	85	●		○	
S.2.1	25.000	152	132	114	94	76	16.000	294	256	220	182	147	●		○	
S.2.2	15.000	99	86	74	61	49	12.000	170	148	127	105	85	●		○	
S.2.3	12.000	131	114	99	82	66	8.000	255	221	191	158	127	●		○	
S.3.1	44.000	170	148	127	105	85	29.000	329	286	246	204	164	●		○	
S.3.2	44.000	247	215	186	153	124	29.000	365	318	274	226	183	●		○	
S.3.3	38.000	170	148	127	105	85	25.000	329	286	246	204	164	●		○	
H.1.1	50.000	620	539	465	384	310	33.000	850	740	638	527	425		●		
H.1.2	38.000	537	467	402	333	268	25.000	779	678	585	483	390		●		
H.1.3	25.000	235	204	176	146	117	16.000	346	301	260	215	173		●		
H.1.4	25.000	221	193	166	137	111	16.000	327	284	245	202	163		●		
H.2.1	50.000	620	539	465	384	310	33.000	850	740	638	527	425		●		
H.3.1	38.000	537	467	402	333	268	25.000	779	678	585	483	390		●		
O.1.1	50.000	930	809	697	576	465	38.000	1520	1322	1140	942	760	●	○	○	
O.1.2	50.000	930	809	697	576	465	33.000	1320	1148	990	818	660	●	○	○	
O.2.1	38.000	495	431	371	307	247	25.000	685	596	513	424	342	●	○	○	
O.2.2	38.000	495	431	371	307	247	25.000	685	596	513	424	342	●	○	○	
O.3.1																

Cutting data standard values – Micro cutter – 2.2xDC

Index	52 802 ..., 52 804 ..., 52 806 ...												● 1st choice ○ suitable			
	Ø DC (mm) = 1,8–1,9						Ø DC (mm) = 2,0						Emulsion	Compressed air	MMS	
	a _e	0,1 x DC	0,2 x DC	0,3 x DC	0,4 x DC	0,6–1,0 x DC	a _e	0,1 x DC	0,2 x DC	0,3 x DC	0,4 x DC	0,6–1,0 x DC				
	a _{p max.}	0,54	0,54	0,54	0,54	0,36	a _{p max.}	0,6	0,6	0,6	0,6	0,4				
	n _{min.}	5.500						n _{min.}	5.000							
n	v _r (mm/min)						n	v _r (mm/min)								
P.1.1	29.000	1300	1131	975	806	650	25.000	1500	1300	1125	930	750	●	○	○	
P.1.2	29.000	1300	1131	975	806	650	25.000	1500	1300	1125	930	750	●	○	○	
P.1.3	29.000	1300	1131	975	806	650	25.000	1500	1300	1125	930	750	●	○	○	
P.1.4	29.000	1300	1131	975	806	650	25.000	1500	1300	1125	930	750	●	○	○	
P.1.5	29.000	1300	1131	975	806	650	25.000	1500	1300	1125	930	750	●	○	○	
P.2.1	29.000	1300	1131	975	806	650	25.000	1500	1300	1125	930	750		●	○	
P.2.2	29.000	1300	1131	975	806	650	25.000	1500	1300	1125	930	750		●	○	
P.2.3	29.000	1300	1131	975	806	650	25.000	1500	1300	1125	930	750		●	○	
P.2.4	29.000	1300	1131	975	806	650	25.000	1500	1300	1125	930	750		●	○	
P.3.1	29.000	1300	1131	975	806	650	25.000	1500	1300	1125	930	750		●	○	
P.3.2	29.000	1300	1131	975	806	650	25.000	1500	1300	1125	930	750		●	○	
P.3.3	29.000	1300	1131	975	806	650	25.000	1500	1300	1125	930	750		●	○	
P.4.1	29.000	1300	1131	975	806	650	25.000	1500	1300	1125	930	750		●	○	
P.4.2	29.000	1300	1131	975	806	650	25.000	1500	1300	1125	930	750		●	○	
M.1.1	29.000	1300	1131	975	806	650	25.000	1500	1300	1125	930	750	●		○	
M.2.1	29.000	1300	1131	975	806	650	25.000	1500	1300	1125	930	750	●		○	
M.3.1	29.000	1300	1131	975	806	650	25.000	1500	1300	1125	930	750	●		○	
K.1.1	29.000	1300	1131	975	806	650	25.000	1500	1300	1125	930	750	○	●		
K.1.2	29.000	1300	1131	975	806	650	25.000	1500	1300	1125	930	750	○	●		
K.2.1	29.000	1300	1131	975	806	650	25.000	1500	1300	1125	930	750	○	●		
K.2.2	29.000	1300	1131	975	806	650	25.000	1500	1300	1125	930	750	○	●		
K.3.1	18.000	630	548	473	391	315	12.000	750	650	550	450	350		●		
K.3.2	18.000	630	548	473	391	315	12.000	750	650	550	450	350		●		
N.1.1	44.000	1800	1566	1350	1116	900	25.000	1500	1300	1125	930	750	●		○	
N.1.2	44.000	1800	1566	1350	1116	900	25.000	1500	1300	1125	930	750	●		○	
N.2.1																
N.2.2																
N.2.3																
N.3.1	25.000	1250	1088	938	775	625	19.000	1140	990	855	700	570	●		○	
N.3.2	32.000	1520	1322	1140	942	760	25.000	1500	1300	1125	930	750	●		○	
N.3.3	32.000	1520	1322	1140	942	760	25.000	1500	1300	1125	930	750	●		○	
N.4.1	33.000	1560	1357	1170	967	780	25.000	1500	1300	1125	930	750	●		○	
S.1.1	10.000	280	244	210	174	140	7.500	300	260	230	200	160	●		○	
S.1.2	10.000	280	244	210	174	140	7.500	300	260	230	200	160	●		○	
S.2.1	14.000	420	365	315	260	210	12.500	500	400	350	300	250	●		○	
S.2.2	10.000	280	244	210	174	140	7.500	300	260	230	200	160	●		○	
S.2.3	7.000	370	322	278	229	185	6.000	300	260	230	200	160	●		○	
S.3.1	25.000	400	348	300	248	200	25.000	1500	1300	1125	930	750	●		○	
S.3.2	25.000	480	418	360	298	240	25.000	1500	1300	1125	930	750	●		○	
S.3.3	22.000	380	331	285	236	190	25.000	1500	1300	1125	930	750	●		○	
H.1.1	29.000	1200	1044	900	744	600	25.000	1500	1300	1125	930	750		●		
H.1.2	22.000	1000	870	750	620	500	19.000	1140	990	855	700	570		●		
H.1.3	14.000	420	365	315	260	210	19.000	1140	990	855	700	570		●		
H.1.4	14.000	420	365	315	260	210	19.000	1140	990	855	700	570		●		
H.2.1	29.000	1200	1044	900	744	600	25.000	1500	1300	1125	930	750		●		
H.3.1	22.000	1000	870	750	620	500	19.000	1140	990	855	700	570		●		
O.1.1	33.000	1560	1357	1170	967	780	19.000	1140	990	855	700	570	●	○	○	
O.1.2	28.000	1400	1218	1050	868	700	19.000	1140	990	855	700	570	●	○	○	
O.2.1	22.000	800	696	600	496	400	12.000	720	630	540	450	360	●	○	○	
O.2.2	22.000	800	696	600	496	400	12.000	720	630	540	450	360	●	○	○	
O.3.1																

Cutting data standard values – Micro cutter – 5xDC

Index	52 802 ..., 52 804 ..., 52 806 ...																● 1st choice		
	Ø DC (mm) = 0,2–0,4 mm				Ø DC (mm) = 0,5–0,7 mm				Ø DC (mm) = 0,8–0,9 mm								○ suitable		
	a _e		0,1 x DC 0,2 x DC 0,3 x DC 0,4 x DC		a _e		0,1 x DC 0,2 x DC 0,3 x DC 0,4 x DC		a _e		0,1 x DC 0,2 x DC 0,3 x DC 0,4 x DC		0,6–1,0 x DC		Emulsion	Compressed air	MMS		
	a _{p max.}		0,012		a _{p max.}		0,06		a _{p max.}		0,12		0,064						
	n _{min.}		30.000		n _{min.}		12.000		n _{min.}		8.000								
n		v _f (mm/min)		n		v _f (mm/min)		n		v _f (mm/min)									
P.1.1	50.000	232	202	174	144	50.000	274	238	205	170	44.000	485	422	364				301	242
P.1.2	50.000	232	202	174	144	50.000	274	238	205	170	44.000	485	422	364	301	242	●	○	○
P.1.3	50.000	232	202	174	144	50.000	274	238	205	170	44.000	485	422	364	301	242	●	○	○
P.1.4	50.000	201	175	151	125	50.000	237	206	178	147	31.000	330	287	248	205	165	●	○	○
P.1.5	50.000	201	175	151	125	50.000	237	206	178	147	31.000	330	287	248	205	165	●	○	○
P.2.1	50.000	232	202	174	144	50.000	274	238	205	170	44.000	485	422	364	301	242		●	○
P.2.2	50.000	232	202	174	144	50.000	274	238	205	170	44.000	485	422	364	301	242		●	○
P.2.3	50.000	201	175	151	125	50.000	237	206	178	147	31.000	330	287	248	205	165		●	○
P.2.4	50.000	201	175	151	125	50.000	237	206	178	147	31.000	330	287	248	205	165		●	○
P.3.1	50.000	201	175	151	125	50.000	237	206	178	147	31.000	330	287	248	205	165		●	○
P.3.2	50.000	232	202	174	144	50.000	274	238	205	170	44.000	485	422	364	301	242		●	○
P.3.3	50.000	201	175	151	125	50.000	237	206	178	147	31.000	330	287	248	205	165		●	○
P.4.1	50.000	232	202	174	144	50.000	274	238	205	170	44.000	485	422	364	301	242		●	○
P.4.2	50.000	232	202	174	144	50.000	274	238	205	170	44.000	485	422	364	301	242		●	○
M.1.1	50.000	232	202	174	144	50.000	219	191	164	136	31.000	346	301	260	215	173	●		○
M.2.1	50.000	232	202	174	144	50.000	219	191	164	136	31.000	346	301	260	215	173	●		○
M.3.1	50.000	232	202	174	144	50.000	219	191	164	136	31.000	346	301	260	215	173	●		○
K.1.1	50.000	232	202	174	144	50.000	219	191	164	136	50.000	416	362	312	258	208	○	●	
K.1.2	50.000	232	202	174	144	50.000	219	191	164	136	50.000	416	362	312	258	208	○	●	
K.2.1	50.000	232	202	174	144	50.000	219	191	164	136	50.000	416	362	312	258	208	○	●	
K.2.2	50.000	232	202	174	144	50.000	219	191	164	136	50.000	416	362	312	258	208	○	●	
K.3.1	50.000	141	123	106	88	50.000	175	152	131	109	25.000	240	209	180	149	120		●	
K.3.2	50.000	141	123	106	88	50.000	175	152	131	109	25.000	240	209	180	149	120		●	
N.1.1	50.000	232	202	174	144	50.000	274	238	205	170	50.000	554	482	416	344	277	●		○
N.1.2	50.000	232	202	174	144	50.000	274	238	205	170	50.000	554	482	416	344	277	●		○
N.2.1																			
N.2.2																			
N.2.3																			
N.3.1	50.000	232	202	174	144	50.000	274	238	205	170	38.000	485	422	364	301	242	●		○
N.3.2	50.000	232	202	174	144	50.000	274	238	205	170	50.000	554	482	416	344	277	●		○
N.3.3	50.000	232	202	174	144	50.000	274	238	205	170	50.000	554	482	416	344	277	●		○
N.4.1	50.000	212	185	159	132	50.000	250	218	188	155	50.000	506	440	379	314	253	●		○
S.1.1	50.000	55	48	41	32	31.000	58	51	44	36	15.000	98	85	73	61	49	●		○
S.1.2	50.000	55	48	41	32	31.000	58	51	44	36	15.000	98	85	73	61	49	●		○
S.2.1	50.000	63	54	47	39	44.000	76	66	57	47	22.000	91	79	68	56	45	●		○
S.2.2	50.000	55	47	40	32	31.000	58	51	44	36	15.000	98	85	73	61	49	●		○
S.2.3	50.000	46	40	35	29	25.000	55	48	41	34	12.000	78	68	59	49	39	●		○
S.3.1	50.000	60	61	48	41	50.000	71	62	53	44	38.000	114	99	85	71	57	●		○
S.3.2	50.000	60	61	48	41	50.000	71	62	53	44	38.000	126	110	95	78	63	●		○
S.3.3	50.000	60	52	45	37	50.000	71	62	49	39	31.000	89	77	66	55	44	●		○
H.1.1	50.000	95	83	71	59	50.000	134	117	101	83	31.000	180	157	135	112	90		●	
H.1.2	50.000	95	83	71	59	44.000	134	117	101	83	22.000	180	157	135	112	90		●	
H.1.3	50.000	89	78	67	55	44.000	126	110	95	78	22.000	170	148	127	105	85		●	
H.1.4																			
H.2.1	50.000	155	135	116	96	50.000	164	143	123	102	44.000	346	301	260	215	173		●	
H.3.1	50.000	95	83	71	59	50.000	134	117	101	83	31.000	180	157	135	112	90		●	
O.1.1	50.000	232	202	174	144	50.000	274	238	205	170	50.000	554	482	416	344	277	●	○	○
O.1.2	50.000	232	202	174	144	50.000	274	238	205	170	44.000	554	482	416	344	277	●	○	○
O.2.1	50.000	141	123	106	88	50.000	200	174	150	124	31.000	316	275	237	196	158	●	○	○
O.2.2	50.000	141	123	106	88	50.000	200	174	150	124	31.000	316	275	237	196	158	●	○	○
O.3.1																			



a_e = 0,6–1,0 x DC: If values are missing, only trochoidal slot milling and profiling are permitted. Otherwise, there is the risk of tool breakage.

Cutting data standard values – Micro cutter – 5xDC

Index	52 802 ..., 52 804 ..., 52 806 ...																				
	Ø DC (mm) = 1,0–1,4						Ø DC (mm) = 1,5–1,7						Ø DC (mm) = 1,8–1,9								
	a _e	0,1 x DC	0,2 x DC	0,3 x DC	0,4 x DC	0,6–1,0 x DC	a _e	0,1 x DC	0,2 x DC	0,3 x DC	0,4 x DC	0,6–1,0 x DC	a _e	0,1 x DC	0,2 x DC	0,3 x DC	0,4 x DC	0,6–1,0 x DC			
	a _{p max.}	0,3				0,2	a _{p max.}	0,3				0,2	a _{p max.}	0,54				0,36			
	n _{min.}	6.500						n _{min.}	6.500						n _{min.}	5.500					
	n	v _r (mm/min)						n	v _r (mm/min)						n	v _r (mm/min)					
P.1.1	44.000	682	593	511	423	341	29.000	1160	1009	870	719	580	25.000	1250	1088	938	775	625			
P.1.2	44.000	682	593	511	423	341	29.000	1160	1009	870	719	580	25.000	1250	1088	938	775	625			
P.1.3	44.000	682	593	511	423	341	29.000	1160	1009	870	719	580	25.000	1250	1088	938	775	625			
P.1.4	31.000	416	362	312	258	208	21.000	693	603	520	430	346	18.000	850	740	638	527	425			
P.1.5	31.000	416	362	312	258	208	21.000	693	603	520	430	346	18.000	850	740	638	527	425			
P.2.1	44.000	682	593	511	423	341	29.000	1160	1009	870	719	580	25.000	1250	1088	938	775	625			
P.2.2	44.000	682	593	511	423	341	29.000	1160	1009	870	719	580	25.000	1250	1088	938	775	625			
P.2.3	31.000	416	362	312	258	208	21.000	693	603	520	430	346	18.000	850	740	638	527	425			
P.2.4	31.000	416	362	312	258	208	21.000	693	603	520	430	346	18.000	850	740	638	527	425			
P.3.1	31.000	416	362	312	258	208	21.000	693	603	520	430	346	18.000	850	740	638	527	425			
P.3.2	44.000	682	593	511	423	341	29.000	1160	1009	870	719	580	25.000	1250	1088	938	775	625			
P.3.3	31.000	416	362	312	258	208	21.000	693	603	520	430	346	18.000	850	740	638	527	425			
P.4.1	44.000	682	593	511	423	341	29.000	1160	1009	870	719	580	25.000	1250	1088	938	775	625			
P.4.2	44.000	682	593	511	423	341	29.000	1160	1009	870	719	580	25.000	1250	1088	938	775	625			
M.1.1	31.000	480	418	360	298	240	21.000	800	696	600	496	400	18.000	850	740	638	527	425			
M.2.1	31.000	480	418	360	298	240	21.000	800	696	600	496	400	18.000	850	740	638	527	425			
M.3.1	31.000	480	418	360	298	240	21.000	800	696	600	496	400	18.000	850	740	638	527	425			
K.1.1	50.000	620	539	465	384	310	33.000	1000	870	750	620	500	28.000	1320	1148	990	818	660			
K.1.2	50.000	620	539	465	384	310	33.000	1000	870	750	620	500	28.000	1320	1148	990	818	660			
K.2.1	50.000	620	539	465	384	310	33.000	1000	870	750	620	500	28.000	1320	1148	990	818	660			
K.2.2	50.000	620	539	465	384	310	33.000	1000	870	750	620	500	28.000	1320	1148	990	818	660			
K.3.1	25.000	297	258	223	184	148	16.000	411	357	308	255	205	14.000	480	418	360	298	240			
K.3.2	25.000	297	258	223	184	148	16.000	411	357	308	255	205	14.000	480	418	360	298	240			
N.1.1	50.000	775	674	581	480	387	42.000	1200	1044	900	744	600	36.000	1500	1305	1125	930	750			
N.1.2	50.000	775	674	581	480	387	42.000	1200	1044	900	744	600	36.000	1500	1305	1125	930	750			
N.2.1																					
N.2.2																					
N.2.3																					
N.3.1	38.000	697	607	523	432	349	25.000	1000	870	750	620	500	22.000	1100	957	825	682	550			
N.3.2	50.000	930	809	697	576	465	33.000	1320	1148	990	818	660	28.000	1400	1218	1050	868	700			
N.3.3	50.000	930	809	697	576	465	33.000	1320	1148	990	818	660	28.000	1400	1218	1050	868	700			
N.4.1	50.000	849	738	636	526	424	33.000	1205	1048	904	747	602	28.000	1400	1218	1050	868	700			
S.1.1	15.000	120	105	90	75	60	10.000	184	160	138	114	92	8.000	280	244	210	174	140			
S.1.2	15.000	120	105	90	75	60	10.000	184	160	138	114	92	8.000	280	244	210	174	140			
S.2.1	22.000	114	99	85	71	57	14.000	196	170	147	121	98	12.000	300	261	225	186	150			
S.2.2	15.000	120	105	90	75	60	10.000	184	160	138	114	92	8.000	280	244	210	174	140			
S.2.3	12.000	131	114	99	82	66	8.000	170	148	127	105	85	7.000	240	209	180	149	120			
S.3.1	38.000	156	135	117	96	78	25.000	274	238	205	170	137	22.000	380	331	285	236	190			
S.3.2	38.000	212	185	159	132	106	25.000	365	318	274	226	183	22.000	450	392	338	279	225			
S.3.3	31.000	127	111	95	79	64	21.000	201	175	151	125	100	18.000	300	261	225	186	150			
H.1.1	31.000	201	175	151	125	101	21.000	346	301	260	215	173	16.000	500	435	375	310	250			
H.1.2	22.000	235	204	176	146	117	14.000	346	301	260	215	173	12.000	450	392	338	279	225			
H.1.3	22.000	221	193	166	137	111	14.000	327	284	245	202	163	12.000	450	392	338	279	225			
H.1.4																					
H.2.1	44.000	426	371	320	264	213	29.000	600	522	450	372	300	25.000	800	696	600	496	400			
H.3.1	31.000	201	175	151	125	101	21.000	346	301	260	215	173	16.000	500	435	375	310	250			
O.1.1	50.000	930	809	697	576	465	33.000	1320	1148	990	818	660	28.000	1400	1218	1050	868	700			
O.1.2	44.000	813	708	610	504	407	29.000	1160	1009	870	719	580	25.000	1200	1044	900	744	600			
O.2.1	31.000	438	381	329	272	219	21.000	575	500	431	357	288	18.000	650	566	488	403	325			
O.2.2	31.000	438	381	329	272	219	21.000	575	500	431	357	288	18.000	650	566	488	403	325			
O.3.1																					

Index	52 802 ..., 52 804 ..., 52 806 ...							● 1st choice ○ suitable		
	Ø DC (mm) = 2,0							Emulsion	Compressed air	MMS
	a _e	0,1 x DC	0,2 x DC	0,3 x DC	0,4 x DC	0,6–1,0 x DC				
	a _{p max.}	0,6					0,4			
	n _{min.}	5.000								
n	v _f (mm/min)									
P.1.1	22.000	1320	1148	990	818	660	●	○	○	
P.1.2	22.000	1320	1148	990	818	660	●	○	○	
P.1.3	22.000	1320	1148	990	818	660	●	○	○	
P.1.4	15.000	900	783	675	558	450	●	○	○	
P.1.5	15.000	900	783	675	558	450	●	○	○	
P.2.1	22.000	1320	1148	990	818	660		●	○	
P.2.2	22.000	1320	1148	990	818	660		●	○	
P.2.3	15.000	900	783	675	558	450		●	○	
P.2.4	15.000	900	783	675	558	450		●	○	
P.3.1	15.000	900	783	675	558	450		●	○	
P.3.2	22.000	1320	1148	990	818	660		●	○	
P.3.3	15.000	900	783	675	558	450		●	○	
P.4.1	22.000	1320	1148	990	818	660		●	○	
P.4.2	22.000	1320	1148	990	818	660		●	○	
M.1.1	15.000	900	783	675	558	450	●		○	
M.2.1	15.000	900	783	675	558	450	●		○	
M.3.1	15.000	900	783	675	558	450	●		○	
K.1.1	25.000	1500	1305	1125	930	750	○	●		
K.1.2	25.000	1500	1305	1125	930	750	○	●		
K.2.1	25.000	1500	1305	1125	930	750	○	●		
K.2.2	25.000	1500	1305	1125	930	750	○	●		
K.3.1	12.000	520	452	390	322	260		●		
K.3.2	12.000	520	452	390	322	260		●		
N.1.1	31.000	1860	1618	1395	1153	930	●		○	
N.1.2	31.000	1860	1618	1395	1153	930	●		○	
N.2.1										
N.2.2										
N.2.3										
N.3.1	19.000	1140	992	855	707	570	●		○	
N.3.2	25.000	1500	1305	1125	930	750	●		○	
N.3.3	25.000	1500	1305	1125	930	750	●		○	
N.4.1	25.000	1500	1305	1125	930	750	●		○	
S.1.1	7.000	300	261	225	186	150	●		○	
S.1.2	7.000	300	261	225	186	150	●		○	
S.2.1	11.000	400	348	300	248	200	●		○	
S.2.2	7.000	300	261	225	186	150	●		○	
S.2.3	6.000	260	226	195	161	130	●		○	
S.3.1	19.000	420	365	315	260	210	●		○	
S.3.2	19.000	500	435	375	310	250	●		○	
S.3.3	15.000	400	348	300	248	200	●		○	
H.1.1	15.000	500	435	375	310	250		●		
H.1.2	11.000	480	418	360	298	240		●		
H.1.3	11.000	480	418	360	298	240		●		
H.1.4										
H.2.1	22.000	1000	870	750	620	500		●		
H.3.1	15.000	500	435	375	310	250		●		
O.1.1	25.000	1500	1305	1125	930	750	●	○	○	
O.1.2	22.000	1320	1148	990	818	660	●	○	○	
O.2.1	15.000	660	574	495	409	330	●	○	○	
O.2.2	15.000	660	574	495	409	330	●	○	○	
O.3.1										

Cutting data standard values – Micro cutter – 10xDC

Index	52 802 ..., 52 804 ..., 52 806 ...																	
	a _e	Ø DC (mm) = 0,2–0,4				Ø DC (mm) = 0,5–0,7				a _e	Ø DC (mm) = 0,8–0,9				Ø DC (mm) = 1,0–1,4			
		0,1 x DC	0,2 x DC	0,3 x DC	0,4 x DC	0,1 x DC	0,2 x DC	0,3 x DC	0,4 x DC		0,1 x DC	0,2 x DC	0,3 x DC	0,4 x DC	0,1 x DC	0,2 x DC	0,3 x DC	0,4 x DC
	a _{p max.}	0,006	0,006	0,006	0,006	0,015	0,015	0,015	0,015	a _{p max.}	0,024	0,024	0,024	0,024	0,03	0,03	0,03	0,03
	n _{min.}	30.000				12.000				n _{min.}	8.000				6.500			
n	v _f (mm/min)								n	v _f (mm/min)								
P.1.1	50.000	232	202	174	144	274	238	205	170	38.000	450	392	338	279	589	512	442	365
P.1.2	50.000	232	202	174	144	274	238	205	170	38.000	450	392	338	279	589	512	442	365
P.1.3	50.000	232	202	174	144	274	238	205	170	38.000	450	392	338	279	589	512	442	365
P.1.4	50.000	201	175	151	125	190	165	142	118	25.000	300	261	225	186	335	292	252	208
P.1.5	50.000	201	175	151	125	190	165	142	118	25.000	300	261	225	186	335	292	252	208
P.2.1	50.000	232	202	174	144	274	238	205	170	38.000	450	392	338	279	589	512	442	365
P.2.2	50.000	232	202	174	144	274	238	205	170	38.000	450	392	338	279	589	512	442	365
P.2.3	50.000	201	175	151	125	190	165	142	118	25.000	300	261	225	186	335	292	252	208
P.2.4	50.000	201	175	151	125	190	165	142	118	25.000	300	261	225	186	335	292	252	208
P.3.1	50.000	201	175	151	125	190	165	142	118	25.000	300	261	225	186	335	292	252	208
P.3.2	50.000	232	202	174	144	274	238	205	170	38.000	450	392	338	279	589	512	442	365
P.3.3	50.000	201	175	151	125	190	165	142	118	25.000	300	261	225	186	335	292	252	208
P.4.1	50.000	232	202	174	144	274	238	205	170	38.000	450	392	338	279	589	512	442	365
P.4.2	50.000	232	202	174	144	274	238	205	170	38.000	450	392	338	279	589	512	442	365
M.1.1	50.000	155	135	116	96	219	191	164	136	25.000	312	271	234	193	387	337	290	240
M.2.1	50.000	155	135	116	96	219	191	164	136	25.000	312	271	234	193	387	337	290	240
M.3.1	50.000	155	135	116	96	219	191	164	136	25.000	312	271	234	193	387	337	290	240
K.1.1	50.000	232	202	174	144	274	238	205	170	44.000	485	422	364	301	682	593	511	423
K.1.2	50.000	232	202	174	144	274	238	205	170	44.000	485	422	364	301	682	593	511	423
K.2.1	50.000	232	202	174	144	274	238	205	170	44.000	485	422	364	301	682	593	511	423
K.2.2	50.000	232	202	174	144	274	238	205	170	44.000	485	422	364	301	682	593	511	423
K.3.1	50.000	141	123	106	88	150	131	113	93	19.000	215	187	161	133	269	234	202	167
K.3.2	50.000	141	123	106	88	150	131	113	93	19.000	215	187	161	133	269	234	202	167
N.1.1	50.000	232	202	174	144	438	381	329	272	50.000	693	603	520	430	930	809	697	576
N.1.2	50.000	232	202	174	144	438	381	329	272	50.000	693	603	520	430	930	809	697	576
N.2.1																		
N.2.2																		
N.2.3																		
N.3.1	50.000	232	202	174	144	274	238	205	170	31.000	402	350	301	249	480	418	360	298
N.3.2	50.000	232	202	174	144	274	238	205	170	44.000	416	362	312	258	542	472	407	336
N.3.3	50.000	232	202	174	144	274	238	205	170	44.000	416	362	312	258	542	472	407	336
N.4.1	50.000	212	185	159	132	300	261	225	186	44.000	506	440	379	314	742	646	557	460
S.1.1	50.000	46	40	35	29	55	48	41	34	12.000	69	60	51	43	88	76	66	54
S.1.2	50.000	46	40	35	29	55	48	41	34	12.000	69	60	51	43	88	76	66	54
S.2.1	50.000	54	47	40	33	63	55	47	39	19.000	102	89	76	63	126	110	95	78
S.2.2	50.000	46	40	35	29	55	48	41	34	12.000	69	60	51	43	88	76	66	54
S.2.3	50.000	46	40	35	29	55	48	41	34	12.000	59	51	44	36	82	71	62	51
S.3.1	50.000	60	52	45	37	71	62	53	44	31.000	101	88	76	63	141	123	106	88
S.3.2	50.000	60	52	45	37	71	62	53	44	31.000	101	88	76	63	177	154	133	110
S.3.3	50.000	60	52	45	37	71	62	53	44	25.000	89	77	66	55	141	123	106	88
H.1.1	50.000	47	41	36	29	67	58	50	42	25.000	90	78	68	56	101	88	75	62
H.1.2	50.000	47	41	36	29	67	58	50	42	19.000	90	78	68	56	101	88	75	62
H.1.3	50.000	45	39	34	28	63	55	47	39	19.000	85	74	64	53	95	83	71	59
H.1.4																		
H.2.1	50.000	77	67	58	48	82	71	62	51	38.000	173	151	130	107	194	168	145	120
H.3.1	50.000	47	41	36	29	67	58	50	42	25.000	90	78	68	56	101	88	75	62
O.1.1	50.000	232	202	174	144	329	286	246	204	44.000	554	482	416	344	813	708	610	504
O.1.2	50.000	232	202	174	144	329	286	246	204	38.000	554	482	416	344	705	613	529	437
O.2.1	50.000	141	123	106	88	200	174	150	124	25.000	285	248	213	176	339	295	255	210
O.2.2	50.000	141	123	106	88	200	174	150	124	25.000	285	248	213	176	339	295	255	210
O.3.1																		



a_e = 0,6–1,0 x DC: Missing values only trochoidal slotting and milling is recommended. Otherwise there is the risk of tool breakage.

Index	52 802 ..., 52 804 ..., 52 806 ...															● 1st choice				
	Ø DC (mm) = 1,5–1,7					Ø DC (mm) = 1,8–1,9					Ø DC (mm) = 2,0					○ suitable				
	a _e	0,1 x DC	0,2 x DC	0,3 x DC	0,4 x DC	a _e	0,1 x DC	0,2 x DC	0,3 x DC	0,4 x DC	a _e	0,1 x DC	0,2 x DC	0,3 x DC	0,4 x DC	Emulsion	Compressed air	MMS		
	a _{p max.}	0,06	0,06	0,06	0,06	a _{p max.}	0,072	0,072	0,072	0,072	a _{p max.}	0,08	0,08	0,08	0,08					
	n _{min.}	6.500					n _{min.}	5.500					n _{min.}	5.000						
n	v _f (mm/min)					n	v _f (mm/min)					n	v _f (mm/min)							
P.1.1	25.000	1000	870	750	620	22.000	1080	940	810	670	19.000	1140	992	855	707				●	○
P.1.2	25.000	1000	870	750	620	22.000	1080	940	810	670	19.000	1140	992	855	707	●	○	○		
P.1.3	25.000	1000	870	750	620	22.000	1080	940	810	670	19.000	1140	992	855	707	●	○	○		
P.1.4	16.000	554	482	416	344	14.000	680	592	510	422	12.000	720	626	540	446	●	○	○		
P.1.5	16.000	554	482	416	344	14.000	680	592	510	422	12.000	720	626	540	446	●	○	○		
P.2.1	25.000	1000	870	750	620	22.000	1080	940	810	670	19.000	1140	992	855	707		●	○		
P.2.2	25.000	1000	870	750	620	22.000	1080	940	810	670	19.000	1140	992	855	707		●	○		
P.2.3	16.000	554	482	416	344	14.000	680	592	510	422	12.000	720	626	540	446		●	○		
P.2.4	16.000	554	482	416	344	14.000	680	592	510	422	12.000	720	626	540	446		●	○		
P.3.1	16.000	554	482	416	344	14.000	680	592	510	422	12.000	720	626	540	446		●	○		
P.3.2	25.000	1000	870	750	620	22.000	1080	940	810	670	19.000	1140	992	855	707		●	○		
P.3.3	16.000	554	482	416	344	14.000	680	592	510	422	12.000	720	626	540	446		●	○		
P.4.1	25.000	1000	870	750	620	22.000	1080	940	810	670	19.000	1140	992	855	707		●	○		
P.4.2	25.000	1000	870	750	620	22.000	1080	940	810	670	19.000	1140	992	855	707		●	○		
M.1.1	16.000	600	522	450	372	14.000	650	566	488	403	12.000	720	626	540	446	●		○		
M.2.1	16.000	600	522	450	372	14.000	650	566	488	403	12.000	720	626	540	446	●		○		
M.3.1	16.000	600	522	450	372	14.000	650	566	488	403	12.000	720	626	540	446	●		○		
K.1.1	29.000	1160	1009	870	719	25.000	1240	1079	930	769	22.000	1320	1148	990	818	○	●			
K.1.2	29.000	1160	1009	870	719	25.000	1240	1079	930	769	22.000	1320	1148	990	818	○	●			
K.2.1	29.000	1160	1009	870	719	25.000	1240	1079	930	769	22.000	1320	1148	990	818	○	●			
K.2.2	29.000	1160	1009	870	719	25.000	1240	1079	930	769	22.000	1320	1148	990	818	○	●			
K.3.1	12.000	329	286	246	204	10.000	380	331	285	236	9.000	390	339	293	242		●			
K.3.2	12.000	329	286	246	204	10.000	380	331	285	236	9.000	390	339	293	242		●			
N.1.1	38.000	1520	1322	1140	942	33.000	1600	1392	1200	992	28.000	1680	1462	1260	1042	●		○		
N.1.2	38.000	1520	1322	1140	942	33.000	1600	1392	1200	992	28.000	1680	1462	1260	1042	●		○		
N.2.1																				
N.2.2																				
N.2.3																				
N.3.1	21.000	800	696	600	496	18.000	850	740	638	527	15.000	900	783	675	558	●		○		
N.3.2	29.000	900	783	675	558	25.000	1000	870	750	620	22.000	1140	992	855	707	●		○		
N.3.3	29.000	900	783	675	558	25.000	1000	870	750	620	22.000	1140	992	855	707	●		○		
N.4.1	29.000	1059	921	794	657	25.000	1200	1044	900	744	22.000	1320	1148	990	818	●		○		
S.1.1	8.000	127	111	95	79	7.000	220	191	165	136	6.000	250	218	188	155	●		○		
S.1.2	8.000	127	111	95	79	7.000	220	191	165	136	6.000	250	218	188	155	●		○		
S.2.1	12.000	204	178	153	127	10.000	300	261	225	186	9.000	350	305	263	217	●		○		
S.2.2	8.000	127	111	95	79	7.000	220	191	165	136	6.000	250	218	188	155	●		○		
S.2.3	8.000	106	92	80	66	7.000	200	174	150	124	6.000	220	191	165	136	●		○		
S.3.1	21.000	228	199	171	141	18.000	300	261	225	186	15.000	380	331	285	236	●		○		
S.3.2	21.000	274	238	205	170	18.000	400	348	300	248	15.000	450	392	338	279	●		○		
S.3.3	16.000	237	206	178	147	14.000	300	261	225	186	12.000	380	331	285	236	●		○		
H.1.1	16.000	173	151	130	107	14.000	200	174	150	124	12.000	240	209	180	149		●			
H.1.2	12.000	173	151	130	107	10.000	200	174	150	124	9.000	240	209	180	149		●			
H.1.3	12.000	163	142	122	101	10.000	200	174	150	124	9.000	240	209	180	149		●			
H.1.4																				
H.2.1	25.000	300	261	225	186	21.000	400	348	300	248	19.000	500	435	375	310		●			
H.3.1	16.000	173	151	130	107	14.000	200	174	150	124	12.000	240	209	180	149		●			
O.1.1	29.000	1160	1009	870	719	25.000	1200	1044	900	744	22.000	1320	1148	990	818	●	○	○		
O.1.2	25.000	1000	870	750	620	18.000	1000	870	750	620	19.000	1140	992	855	707	●	○	○		
O.2.1	16.000	438	381	329	272	14.000	500	435	375	310	12.000	520	452	390	322	●	○	○		
O.2.2	16.000	438	381	329	272	14.000	500	435	375	310	12.000	520	452	390	322	●	○	○		
O.3.1																				

Cutting data standard values – MultiLock – Radius milling cutter

Index	53 803 ..., 53 804 ...						● 1st choice ○ suitable		
	CTC5240	CTPX225	Ø DC (mm) =				Emulsion	Compressed air	MMS
	v _c (m/min)		12	16	20	25			
			a _e / a _p = 0,05 x DC						
		f _z (mm)							
P.1.1		180	0,12	0,15	0,18	0,20	●	○	○
P.1.2		160	0,13	0,16	0,19	0,21	●	○	○
P.1.3		160	0,13	0,16	0,19	0,21	●	○	○
P.1.4		140	0,10	0,13	0,16	0,18	●	○	○
P.1.5		140	0,10	0,13	0,16	0,18	●	○	○
P.2.1		150	0,10	0,13	0,16	0,18	●	○	○
P.2.2		150	0,10	0,13	0,16	0,18	●	○	○
P.2.3		90	0,09	0,10	0,13	0,14	●	○	○
P.2.4		90	0,09	0,10	0,13	0,14	●	○	○
P.3.1		80	0,07	0,09	0,11	0,12	●	○	○
P.3.2		80	0,07	0,09	0,11	0,12	●	○	○
P.3.3		80	0,07	0,09	0,11	0,12	●	○	○
P.4.1		60	0,09	0,10	0,13	0,14	●	○	○
P.4.2		50	0,09	0,10	0,13	0,14	●	○	○
M.1.1		50	0,07	0,09	0,11	0,12	●	○	○
M.2.1		40	0,06	0,08	0,10	0,11	●	○	○
M.3.1		50	0,07	0,09	0,11	0,12	●	○	○
K.1.1		150	0,13	0,17	0,21	0,23	●	○	○
K.1.2		120	0,12	0,15	0,18	0,20	●	○	○
K.2.1		140	0,13	0,16	0,19	0,21	●	○	○
K.2.2		120	0,10	0,13	0,16	0,18	●	○	○
K.3.1		120	0,13	0,16	0,19	0,21	●	○	○
K.3.2		100	0,12	0,15	0,18	0,20	●	○	○
N.1.1		500	0,20	0,25	0,30	0,33	●	○	○
N.1.2		450	0,20	0,25	0,30	0,33	●	○	○
N.2.1									
N.2.2		380	0,19	0,24	0,28	0,31	●	○	○
N.2.3		150	0,16	0,20	0,24	0,26	●	○	○
N.3.1		220	0,13	0,17	0,21	0,23	●	○	○
N.3.2		190	0,13	0,17	0,21	0,23	●	○	○
N.3.3		250	0,13	0,16	0,19	0,21	●	○	○
N.4.1									
S.1.1	60		0,08	0,11	0,16	0,17	●		
S.1.2									
S.2.1	60		0,08	0,11	0,16	0,17	●		
S.2.2	60		0,08	0,11	0,16	0,17	●		
S.2.3									
S.3.1	140		0,11	0,16	0,21	0,22	●		
S.3.2	100		0,08	0,11	0,16	0,17	●		
S.3.3									
H.1.1									
H.1.2									
H.1.3									
H.1.4									
H.2.1									
H.3.1									
O.1.1									
O.1.2									
O.2.1									
O.2.2									
O.3.1									

Cutting data standard values – MultiLock – Torus cutter

Index	CTC5240	CTPX225	53 805 ..., 53 806 ...								● 1st choice ○ suitable		
			Ø DC (mm) =								Emulsion	Compressed air	MMS
			12		16		20		25				
			$a_e = 0,1-0,3 \times DC$	$a_e = 0,3-0,6 \times DC$	$a_e = 0,1-0,3 \times DC$	$a_e = 0,3-0,6 \times DC$	$a_e = 0,1-0,3 \times DC$	$a_e = 0,3-0,6 \times DC$	$a_e = 0,1-0,3 \times DC$	$a_e = 0,3-0,6 \times DC$			
$a_{p,max.} (mm) =$													
$v_c (m/min)$	$f_z (mm)$												
P.1.1		180	0,08	0,05	0,11	0,07	0,14	0,08	0,15	0,08	●	○	○
P.1.2		160	0,09	0,05	0,12	0,07	0,15	0,09	0,17	0,09	●	○	○
P.1.3		160	0,09	0,05	0,12	0,07	0,15	0,09	0,17	0,09	●	○	○
P.1.4		140	0,07	0,04	0,10	0,06	0,13	0,08	0,14	0,08	●	○	○
P.1.5		140	0,07	0,04	0,10	0,06	0,13	0,08	0,14	0,08	●	○	○
P.2.1		150	0,07	0,04	0,10	0,06	0,13	0,08	0,14	0,08	●	○	○
P.2.2		150	0,07	0,04	0,10	0,06	0,13	0,08	0,14	0,08	●	○	○
P.2.3		90	0,06	0,03	0,08	0,05	0,10	0,06	0,11	0,06	●	○	○
P.2.4		90	0,06	0,03	0,08	0,05	0,10	0,06	0,11	0,06	●	○	○
P.3.1		80	0,05	0,03	0,07	0,04	0,09	0,06	0,10	0,06	●	○	○
P.3.2		80	0,05	0,03	0,07	0,04	0,09	0,06	0,10	0,06	●	○	○
P.3.3		80	0,05	0,03	0,07	0,04	0,09	0,06	0,10	0,06	●	○	○
P.4.1		60	0,06	0,05	0,08	0,07	0,10	0,09	0,11	0,09	●	○	○
P.4.2		50	0,06	0,05	0,08	0,07	0,10	0,09	0,11	0,09	●	○	○
M.1.1		50	0,05	0,04	0,07	0,06	0,09	0,08	0,10	0,08	●	○	○
M.2.1		40	0,04	0,03	0,06	0,05	0,08	0,07	0,09	0,07	●	○	○
M.3.1		50	0,05	0,04	0,07	0,06	0,09	0,08	0,10	0,08	●	○	○
K.1.1		150	0,09	0,06	0,13	0,08	0,16	0,10	0,18	0,10	●	○	○
K.1.2		120	0,08	0,05	0,11	0,07	0,14	0,08	0,15	0,08	●	○	○
K.2.1		140	0,09	0,05	0,12	0,07	0,15	0,09	0,17	0,09	●	○	○
K.2.2		120	0,07	0,04	0,10	0,06	0,13	0,08	0,14	0,08	●	○	○
K.3.1		120	0,09	0,05	0,12	0,07	0,15	0,09	0,17	0,09	●	○	○
K.3.2		100	0,08	0,05	0,11	0,07	0,14	0,08	0,15	0,08	●	○	○
N.1.1													
N.1.2													
N.2.1													
N.2.2													
N.2.3													
N.3.1													
N.3.2		220	0,09	0,06	0,13	0,08	0,16	0,10	0,18	0,10	●	○	○
N.3.3													
N.4.1													
S.1.1	60		0,07	0,04	0,10	0,06	0,15	0,08	0,17	0,10	●	○	○
S.1.2	60		0,07	0,04	0,10	0,06	0,15	0,08	0,17	0,10	●	○	○
S.2.1	60		0,07	0,04	0,10	0,06	0,15	0,08	0,17	0,10	●	○	○
S.2.2	60		0,07	0,04	0,10	0,06	0,15	0,08	0,17	0,10	●	○	○
S.2.3	60		0,07	0,04	0,10	0,06	0,15	0,08	0,17	0,10	●	○	○
S.3.1	140		0,10	0,05	0,15	0,08	0,2	0,11	0,22	0,13	●	○	○
S.3.2	100		0,07	0,04	0,10	0,06	0,15	0,08	0,17	0,10	●	○	○
S.3.3													
H.1.1													
H.1.2													
H.1.3													
H.1.4													
H.2.1													
H.3.1													
O.1.1													
O.1.2													
O.2.1													
O.2.2													
O.3.1													

 Plunging angle for ramping milling = 1.9°
 Plunging angle for helical milling = 1.5°
 Bore diameter with helical milling = $D_{min} 1.7xDC / D_{max} 1.95xDC$
 With ramping and helical milling, multiply the f_z by 0.5

Cutting data standard values – MultiLock – HFC milling cutter

Index	CTC5240	CTPX225	53 801 ..., 53 802 ...												● 1st choice ○ suitable		
			Ø DC (mm) =												Emulsion	Compressed air	MMS
			12			16			20			25					
			a _e x DC =														
			0,1-0,2	0,3-0,4	0,6-1,0	0,1-0,2	0,3-0,4	0,6-1,0	0,1-0,2	0,3-0,4	0,6-1,0	0,1-0,2	0,3-0,4	0,6-1,0			
a _{p,max} (mm) =																	
0,5			0,8			0,8			0,8								
v _c (m/min)		f _z (mm)															
P.1.1		200	0,45	0,36	0,26	0,63	0,47	0,30	0,81	0,60	0,38	0,89	0,63	0,38	●	○	○
P.1.2		180	0,50	0,39	0,29	0,69	0,51	0,33	0,89	0,65	0,41	0,98	0,69	0,41	●	○	○
P.1.3		180	0,50	0,39	0,29	0,69	0,51	0,33	0,89	0,65	0,41	0,98	0,69	0,41	●	○	○
P.1.4		150	0,41	0,33	0,24	0,57	0,42	0,27	0,74	0,54	0,35	0,82	0,58	0,35	●	○	○
P.1.5		150	0,41	0,33	0,24	0,57	0,42	0,27	0,74	0,54	0,35	0,82	0,58	0,35	●	○	○
P.2.1		170	0,41	0,33	0,24	0,57	0,42	0,27	0,74	0,54	0,35	0,82	0,58	0,35	●	○	○
P.2.2		170	0,41	0,33	0,24	0,57	0,42	0,27	0,74	0,54	0,35	0,82	0,58	0,35	●	○	○
P.2.3		100	0,33	0,26	0,20	0,46	0,34	0,22	0,59	0,44	0,28	0,65	0,47	0,28	●	○	○
P.2.4		100	0,33	0,26	0,20	0,46	0,34	0,22	0,59	0,44	0,28	0,65	0,47	0,28	●	○	○
P.3.1		90	0,29	0,23	0,17	0,41	0,30	0,19	0,52	0,38	0,25	0,57	0,41	0,25	●	○	○
P.3.2		90	0,29	0,23	0,17	0,41	0,30	0,19	0,52	0,38	0,25	0,57	0,41	0,25	●	○	○
P.3.3		90	0,29	0,23	0,17	0,41	0,30	0,19	0,52	0,38	0,25	0,57	0,41	0,25	●	○	○
P.4.1		70	0,50	0,39	0,29	0,69	0,51	0,33	0,89	0,65	0,41	0,98	0,69	0,41	●	○	○
P.4.2		60	0,50	0,39	0,29	0,69	0,51	0,33	0,89	0,65	0,41	0,98	0,69	0,41	●	○	○
M.1.1		55	0,29	0,23	0,17	0,41	0,30	0,19	0,52	0,38	0,24	0,57	0,40	0,24	●	○	○
M.2.1		40	0,25	0,20	0,15	0,35	0,26	0,17	0,44	0,33	0,21	0,49	0,35	0,21	●	○	○
M.3.1		60	0,29	0,23	0,17	0,41	0,30	0,19	0,52	0,38	0,24	0,57	0,40	0,24	●	○	○
K.1.1		170	0,53	0,42	0,32	0,74	0,55	0,35	0,96	0,71	0,45	1,06	0,75	0,45	●	○	○
K.1.2		130	0,45	0,36	0,26	0,63	0,47	0,3	0,81	0,59	0,38	0,89	0,63	0,38	●	○	○
K.2.1		150	0,50	0,39	0,29	0,69	0,51	0,33	0,89	0,65	0,41	0,98	0,69	0,41	●	○	○
K.2.2		130	0,41	0,33	0,24	0,57	0,42	0,27	0,74	0,54	0,35	0,82	0,58	0,35	●	○	○
K.3.1		130	0,50	0,39	0,29	0,69	0,51	0,33	0,89	0,65	0,41	0,98	0,69	0,41	●	○	○
K.3.2		110	0,45	0,36	0,26	0,63	0,47	0,30	0,81	0,59	0,38	0,89	0,63	0,38	●	○	○
N.1.1																	
N.1.2																	
N.2.1																	
N.2.2																	
N.2.3																	
N.3.1																	
N.3.2																	
N.3.3																	
N.4.1																	
S.1.1	60		0,18	0,15	0,11	0,20	0,15	0,11	0,21	0,18	0,14	0,23	0,19	0,16	●		
S.1.2	60		0,18	0,15	0,11	0,20	0,15	0,11	0,21	0,18	0,14	0,23	0,19	0,16	●		
S.2.1	60		0,18	0,15	0,11	0,20	0,15	0,11	0,21	0,18	0,14	0,23	0,19	0,16	●		
S.2.2	60		0,18	0,15	0,11	0,20	0,15	0,11	0,21	0,18	0,14	0,23	0,19	0,16	●		
S.2.3	60		0,18	0,15	0,11	0,20	0,15	0,11	0,21	0,18	0,14	0,23	0,19	0,16	●		
S.3.1	140		0,18	0,15	0,11	0,20	0,15	0,11	0,21	0,18	0,14	0,23	0,19	0,16	●		
S.3.2	100		0,25	0,19	0,14	0,26	0,19	0,12	0,28	0,22	0,17	0,29	0,24	0,18	●		
S.3.3	140		0,18	0,15	0,11	0,20	0,15	0,11	0,22	0,18	0,14	0,23	0,20	0,16	●		
H.1.1																	
H.1.2																	
H.1.3																	
H.1.4																	
H.2.1																	
H.3.1																	
O.1.1																	
O.1.2																	
O.2.1																	
O.2.2																	
O.3.1																	

 Plunging angle for ramping and helical milling = 1.9°
 Bore diameter with helical milling = D_{min} 1.6xDC / D_{max} 1.95xDC
 With ramping and helical milling, multiply the f_z by 0.5

Cutting data standard values – MultiLock – Deburring cutter

Index	CTPX225 v _c (m/min)	53800 ...		● 1st choice ○ suitable		
		Ø DC (mm) =		Emulsion	Compressed air	MMS
		12	16			
		a _e x DC =				
0,1–0,2		0,1–0,3				
a _{p,max.} (mm) =		f _z (mm)				
4		6				
P.1.1	200	0,09	0,12	●	○	○
P.1.2	180	0,10	0,13	●	○	○
P.1.3	180	0,10	0,13	●	○	○
P.1.4	150	0,08	0,11	●	○	○
P.1.5	150	0,08	0,11	●	○	○
P.2.1	170	0,08	0,11	●	○	○
P.2.2	170	0,08	0,11	●	○	○
P.2.3	100	0,07	0,09	●	○	○
P.2.4	100	0,07	0,09	●	○	○
P.3.1	90	0,06	0,08	●	○	○
P.3.2	90	0,06	0,08	●	○	○
P.3.3	90	0,06	0,08	●	○	○
P.4.1	70	0,07	0,09	●		○
P.4.2	60	0,07	0,09	●		○
M.1.1	60	0,06	0,08	●		○
M.2.1	40	0,05	0,07	●		○
M.3.1	60	0,06	0,08	●		○
K.1.1	170	0,11	0,14	●	○	○
K.1.2	130	0,09	0,12	●	○	○
K.2.1	150	0,10	0,13	●	○	○
K.2.2	130	0,08	0,11	●	○	○
K.3.1	130	0,10	0,13	●	○	○
K.3.2	110	0,09	0,12	●	○	○
N.1.1	550	0,16	0,21	●		
N.1.2	500	0,16	0,21	●		
N.2.1						
N.2.2	420	0,15	0,20	●		
N.2.3	170	0,13	0,17	●		
N.3.1	240	0,11	0,14	●		
N.3.2	210	0,11	0,14	●		
N.3.3	280	0,10	0,13	●		
N.4.1						
S.1.1						
S.1.2						
S.2.1						
S.2.2						
S.2.3						
S.3.1						
S.3.2						
S.3.3						
H.1.1						
H.1.2						
H.1.3						
H.1.4						
H.2.1						
H.3.1						
O.1.1						
O.1.2						
O.2.1						
O.2.2						
O.3.1						

Cutting data standard values – MultiChange – PCR-UNI

Index	52 871 ...													
	Correction factor f_z and v_c				Feedrates for extra short and short holder									
	Tool holder			$a_{p \max}$	v_c (m/min)	\varnothing DC (mm) =				v_c (m/min)	\varnothing DC (mm) =			
	Medium-length version	Type long	Type extra long			10,0 12,0 16,0 20,0					10,0 12,0 16,0 20,0			
						a_e 0,25xDC					a_e 1xDC			
f_z (mm)						f_z (mm)								
P.1.1	0,9	0,7*	0,6*	0,56	490	0,057	0,065	0,080	0,091	240	0,028	0,033	0,040	0,046
P.1.2	0,9	0,7*	0,6*	0,56	470	0,054	0,062	0,076	0,087	230	0,027	0,031	0,038	0,044
P.1.3	0,9	0,7*	0,6*	0,56	445	0,052	0,059	0,073	0,083	220	0,026	0,030	0,036	0,041
P.1.4	0,9	0,7*	0,6*	0,56	425	0,049	0,056	0,069	0,079	205	0,025	0,028	0,034	0,039
P.1.5	0,9	0,7*	0,6*	0,56	400	0,047	0,053	0,065	0,075	195	0,023	0,027	0,033	0,037
P.2.1	0,9	0,7*	0,6*	0,56	445	0,057	0,065	0,080	0,091	220	0,028	0,033	0,040	0,046
P.2.2	0,9	0,7*	0,6*	0,56	405	0,052	0,059	0,073	0,083	200	0,026	0,030	0,036	0,041
P.2.3	0,9	0,7*	0,6*	0,56	365	0,047	0,053	0,065	0,075	180	0,023	0,027	0,033	0,037
P.2.4	0,9	0,7*	0,6*	0,56	285	0,043	0,050	0,060	0,069	140	0,022	0,025	0,030	0,035
P.3.1	0,9	0,7*	0,6*	0,56	265	0,050	0,057	0,070	0,080	130	0,025	0,029	0,035	0,040
P.3.2	0,9	0,7*	0,6*	0,56	245	0,047	0,054	0,067	0,076	120	0,024	0,027	0,033	0,038
P.3.3	0,9	0,7*	0,6*	0,56	225	0,045	0,051	0,063	0,072	110	0,022	0,026	0,031	0,036
P.4.1	0,9	0,7*	0,6*	0,56	180	0,034	0,040	0,048	0,055	90	0,017	0,020	0,024	0,028
P.4.2	0,9	0,7*	0,6*	0,56	180	0,034	0,040	0,048	0,055	90	0,017	0,020	0,024	0,028
M.1.1	0,9	0,7*	0,6*	0,56	120	0,030	0,035	0,042	0,048	60	0,015	0,017	0,021	0,024
M.2.1	0,9	0,7*	0,6*	0,56	115	0,025	0,029	0,035	0,040	55	0,012	0,014	0,018	0,020
M.3.1	0,9	0,7*	0,6*	0,56	120	0,026	0,030	0,036	0,041	60	0,013	0,015	0,018	0,021
K.1.1	0,9	0,7*	0,6*	0,56	485	0,086	0,099	0,121	0,138	240	0,043	0,050	0,060	0,069
K.1.2	0,9	0,7*	0,6*	0,56	365	0,060	0,069	0,085	0,097	180	0,030	0,035	0,042	0,048
K.2.1	0,9	0,7*	0,6*	0,56	445	0,073	0,084	0,103	0,118	220	0,037	0,042	0,051	0,059
K.2.2	0,9	0,7*	0,6*	0,56	365	0,060	0,069	0,085	0,097	180	0,030	0,035	0,042	0,048
K.3.1	0,9	0,7*	0,6*	0,56	325	0,060	0,069	0,085	0,097	160	0,030	0,035	0,042	0,048
K.3.2	0,9	0,7*	0,6*	0,56	305	0,052	0,059	0,073	0,083	150	0,026	0,030	0,036	0,041

* = Trimming and trochoidal slot milling

Cutting data standard values – MultiChange – PCR-ALU

Index	52 872 ...													
	Correction factor f_z and v_c				Feedrates for extra short and short holder									
	Tool holder			$a_{p \max}$	v_c (m/min)	\varnothing DC (mm) =				v_c (m/min)	\varnothing DC (mm) =			
	Medium-length version	Type long	Type extra long			10,0 12,0 16,0 20,0					10,0 12,0 16,0 20,0			
						a_e 0,25xDC					a_e 1xDC			
f_z (mm)						f_z (mm)								
N.1.1	0,9	0,7*	0,6*	0,56	1035	0,169	0,194	0,237	0,271	675	0,084	0,097	0,119	0,136
N.1.2	0,9	0,7*	0,6*	0,56	945	0,154	0,177	0,216	0,247	610	0,077	0,088	0,108	0,123
N.2.1	0,9	0,7*	0,6*	0,56	625	0,161	0,185	0,226	0,259	405	0,081	0,093	0,113	0,129
N.2.2	0,9	0,7*	0,6*	0,56	500	0,169	0,194	0,237	0,271	325	0,084	0,097	0,119	0,136
N.2.3	0,9	0,7*	0,6*	0,56	360	0,184	0,212	0,259	0,296	235	0,092	0,106	0,129	0,148
N.3.1	0,9	0,7*	0,6*	0,56	450	0,077	0,088	0,108	0,123	295	0,038	0,044	0,054	0,062
N.3.2	0,9	0,7*	0,6*	0,56	270	0,123	0,141	0,173	0,197	175	0,061	0,071	0,086	0,099
N.3.3	0,9	0,7*	0,6*	0,56	360	0,123	0,141	0,173	0,197	235	0,061	0,071	0,086	0,099
N.4.1														

* = Trimming and trochoidal slot milling

 For unstable applications, the cutting data can be reduced.

Index	52 871 ...						● 1st choice ○ suitable		
	Ramping Max. angle	Drilling f _z factor	Helical milling			Emulsion	Compressed air	MMS	
			a _{R max} **	Max. plunging angle					
				D _{min} 1,5 x DC	D _{max} 1,8 x DC				
P.1.1	45°	0,9	0,56xDC	20°	13°	○	●	○	
P.1.2	45°	0,9	0,56xDC	20°	13°	○	●	○	
P.1.3	45°	0,9	0,56xDC	20°	13°	○	●	○	
P.1.4	45°	0,9	0,56xDC	20°	13°	○	●	○	
P.1.5	45°	0,9	0,56xDC	20°	13°	○	●	○	
P.2.1	45°	0,8	0,56xDC	20°	13°	○	●	○	
P.2.2	45°	0,8	0,56xDC	20°	13°	○	●	○	
P.2.3	45°	0,8	0,56xDC	20°	13°	○	●	○	
P.2.4	45°	0,7	0,56xDC	20°	13°	○	●	○	
P.3.1	30°	0,8	0,56xDC	20°	13°	●		○	
P.3.2	30°	0,7	0,56xDC	20°	13°	●		○	
P.3.3	30°	0,7	0,56xDC	20°	13°	●		○	
P.4.1	15°		0,56xDC	20°	13°	●		○	
P.4.2	15°		0,56xDC	20°	13°	●		○	
M.1.1	15°		0,4xDC	14°	9°	●			
M.2.1	15°		0,4xDC	14°	9°	●			
M.3.1	15°		0,4xDC	14°	9°	●			
K.1.1	45°	0,8	0,56xDC	20	13		●		
K.1.2	45°	0,8	0,56xDC	20	13		●		
K.2.1	45°	0,8	0,56xDC	20	13		●		
K.2.2	45°	0,8	0,56xDC	20	13		●		
K.3.1	45°	0,8	0,56xDC	20	13		●		
K.3.2	45°	0,8	0,56xDC	20	13		●		

Index	52 872 ...						● 1st choice ○ suitable		
	Ramping Max. angle	Drilling f _z factor	Helical milling			Emulsion	Compressed air	MMS	
			a _{R max} **	Max. plunging angle					
				D _{min} 1,5 x DC	D _{max} 1,8 x DC				
N.1.1	45°	0,9	0,56xDC	20°	13°	●		○	
N.1.2	45°	0,9	0,56xDC	20°	13°	●		○	
N.2.1	45°	0,9	0,56xDC	20°	13°	●		○	
N.2.2	45°	0,9	0,56xDC	20°	13°	●		○	
N.2.3	45°	0,9	0,56xDC	20°	13°	●		○	
N.3.1	45°	0,9	0,56xDC	20°	13°	●		○	
N.3.2	45°	0,9	0,56xDC	20°	13°	●		○	
N.3.3	45°	0,9	0,56xDC	20°	13°	●		○	
N.4.1									



** Width of cut per helical revolution

Cutting data standard values – MultiChange – Shoulder milling heads

Index	52 860 ..., 52 861 ...																		● 1st choice			
	Correction factor f_z and v_c Medium Holder	Correction factor f_z and v_c Long Holder	Correction factor f_z and v_c Extra Long Holder	v_c (m/min)	Feedrates for extra short and short holder															Emulsion	Compressed air	MMS
					Ø DC (mm) =																	
					8			10			12			16			20					
					$a_{p,max} =$																	
					5,2	4,4	3,6	6,5	5,5	4,5	7,8	6,6	5,4	10,4	8,8	7,2	13	11	9			
$a_g \times DC =$																						
0,1-0,2	0,3-0,4	0,6-1,0	0,1-0,2	0,3-0,4	0,6-1,0	0,1-0,2	0,3-0,4	0,6-1,0	0,1-0,2	0,3-0,4	0,6-1,0	0,1-0,2	0,3-0,4	0,6-1,0	0,1-0,2	0,3-0,4	0,6-1,0					
f_z (mm)																						
P.1.1	0,9	0,7*	0,6*	175	0,05	0,04	0,02	0,06	0,04	0,03	0,07	0,05	0,03	0,08	0,06	0,04	0,09	0,07	0,05	○	●	○
P.1.2	0,9	0,7*	0,6*	165	0,05	0,03	0,02	0,05	0,04	0,03	0,06	0,05	0,03	0,08	0,06	0,04	0,09	0,07	0,04	○	●	○
P.1.3	0,9	0,7*	0,6*	160	0,04	0,03	0,02	0,05	0,04	0,03	0,06	0,04	0,03	0,07	0,05	0,04	0,08	0,06	0,04	○	●	○
P.1.4	0,9	0,7*	0,6*	150	0,04	0,03	0,02	0,05	0,04	0,02	0,06	0,04	0,03	0,07	0,05	0,03	0,08	0,06	0,04	○	●	○
P.1.5	0,9	0,7*	0,6*	145	0,04	0,03	0,02	0,05	0,04	0,02	0,05	0,04	0,03	0,07	0,05	0,03	0,08	0,06	0,04	○	●	○
P.2.1	0,9	0,7*	0,6*	160	0,05	0,04	0,02	0,06	0,04	0,03	0,07	0,05	0,03	0,08	0,06	0,04	0,09	0,07	0,05	○	●	○
P.2.2	0,9	0,7*	0,6*	145	0,04	0,03	0,02	0,05	0,04	0,03	0,06	0,04	0,03	0,07	0,05	0,04	0,08	0,06	0,04	○	●	○
P.2.3	0,9	0,7*	0,6*	130	0,04	0,03	0,02	0,05	0,04	0,02	0,05	0,04	0,03	0,07	0,05	0,03	0,08	0,06	0,04	○	●	○
P.2.4	0,9	0,7*	0,6*	100	0,04	0,03	0,02	0,04	0,03	0,02	0,05	0,04	0,03	0,06	0,05	0,03	0,07	0,05	0,04	○	●	○
P.3.1	0,9	0,7*	0,6*	95	0,04	0,03	0,02	0,05	0,04	0,03	0,06	0,04	0,03	0,07	0,05	0,04	0,08	0,06	0,04	●		○
P.3.2	0,9	0,7*	0,6*	85	0,04	0,03	0,02	0,05	0,04	0,02	0,06	0,04	0,03	0,07	0,05	0,03	0,08	0,06	0,04	●		○
P.3.3	0,9	0,7*	0,6*	80	0,04	0,03	0,02	0,05	0,03	0,02	0,05	0,04	0,03	0,06	0,05	0,03	0,07	0,05	0,04	●		○
P.4.1	0,9	0,7*	0,6*	65	0,03	0,02	0,01	0,03	0,03	0,02	0,04	0,03	0,02	0,05	0,04	0,02	0,06	0,04	0,03	●		○
P.4.2	0,9	0,7*	0,6*	65	0,03	0,02	0,01	0,03	0,03	0,02	0,04	0,03	0,02	0,05	0,04	0,02	0,06	0,04	0,03	●		○
M.1.1																						
M.2.1																						
M.3.1																						
K.1.1	0,9	0,7*	0,6*	175	0,07	0,05	0,04	0,09	0,07	0,04	0,10	0,07	0,05	0,12	0,09	0,06	0,14	0,10	0,07		●	
K.1.2	0,9	0,7*	0,6*	130	0,05	0,04	0,03	0,06	0,05	0,03	0,07	0,05	0,04	0,09	0,06	0,04	0,10	0,07	0,05		●	
K.2.1	0,9	0,7*	0,6*	160	0,06	0,05	0,03	0,07	0,06	0,04	0,09	0,06	0,04	0,10	0,08	0,05	0,12	0,09	0,06		●	
K.2.2	0,9	0,7*	0,6*	130	0,05	0,04	0,03	0,06	0,05	0,03	0,07	0,05	0,04	0,09	0,06	0,04	0,10	0,07	0,05		●	
K.3.1	0,9	0,7*	0,6*	115	0,05	0,04	0,03	0,06	0,05	0,03	0,07	0,05	0,04	0,09	0,06	0,04	0,10	0,07	0,05		●	
K.3.2	0,9	0,7*	0,6*	110	0,04	0,03	0,02	0,05	0,04	0,03	0,06	0,04	0,03	0,07	0,05	0,04	0,08	0,06	0,04		●	
N.1.1																						
N.1.2																						
N.2.1																						
N.2.2																						
N.2.3																						
N.3.1																						
N.3.2																						
N.3.3																						
N.4.1																						
S.1.1																						
S.1.2																						
S.2.1																						
S.2.2																						
S.2.3																						
S.3.1																						
S.3.2																						
S.3.3																						
H.1.1																						
H.1.2																						
H.1.3																						
H.1.4																						
H.2.1																						
H.3.1																						
O.1.1																						
O.1.2																						
O.2.1																						
O.2.2																						
O.3.1																						

* = Trimming and trochoidal slot milling

 For unstable applications, the cutting data can be reduced.

Cutting data standard values – MultiChange – Rough-finishing milling heads

Index	52 862 ...														● 1st choice ○ suitable		
	Correction factor f_z and v_c Medium Holder	Correction factor f_z and v_c Long Holder	Correction factor f_z and v_c Extra Long Holder	v_c (m/min)	Feedrates for extra short and short holder										Emulsion	Compressed air	MMS
					Ø DC (mm) =												
					8		10		12		16		20				
					$a_{p,max} =$												
					7,5		9,4		11,3		15,0		18,8				
$a_e \times DC =$																	
0,1–0,2		0,3–0,4		0,1–0,2		0,3–0,4		0,1–0,2					0,3–0,4				
f_z (mm)																	
P.1.1	0,9	0,7*	0,6*	225	0,04	0,03	0,05	0,04	0,06	0,04	0,08	0,05	0,09	0,06	○	●	○
P.1.2	0,9	0,7*	0,6*	215	0,04	0,03	0,05	0,04	0,06	0,04	0,07	0,05	0,08	0,06	○	●	○
P.1.3	0,9	0,7*	0,6*	205	0,04	0,03	0,05	0,03	0,06	0,04	0,07	0,05	0,08	0,06	○	●	○
P.1.4	0,9	0,7*	0,6*	195	0,04	0,03	0,05	0,03	0,05	0,04	0,06	0,05	0,07	0,05	○	●	○
P.1.5	0,9	0,7*	0,6*	185	0,04	0,03	0,04	0,03	0,05	0,04	0,06	0,04	0,07	0,05	○	●	○
P.2.1	0,9	0,7*	0,6*	205	0,04	0,03	0,05	0,04	0,06	0,04	0,08	0,05	0,09	0,06	○	●	○
P.2.2	0,9	0,7*	0,6*	185	0,04	0,03	0,05	0,03	0,06	0,04	0,07	0,05	0,08	0,06	○	●	○
P.2.3	0,9	0,7*	0,6*	170	0,04	0,03	0,04	0,03	0,05	0,04	0,06	0,04	0,07	0,05	○	●	○
P.2.4	0,9	0,7*	0,6*	130	0,03	0,02	0,04	0,03	0,05	0,03	0,06	0,04	0,06	0,05	○	●	○
P.3.1	0,9	0,7*	0,6*	120	0,04	0,03	0,05	0,03	0,05	0,04	0,07	0,05	0,08	0,05	●		○
P.3.2	0,9	0,7*	0,6*	110	0,04	0,03	0,04	0,03	0,05	0,04	0,06	0,04	0,07	0,05	●		○
P.3.3	0,9	0,7*	0,6*	105	0,04	0,02	0,04	0,03	0,05	0,03	0,06	0,04	0,07	0,05	●		○
P.4.1	0,9	0,7*	0,6*	85	0,03	0,02	0,03	0,02	0,04	0,03	0,05	0,03	0,05	0,04	●		○
P.4.2	0,9	0,7*	0,6*	85	0,03	0,02	0,03	0,02	0,04	0,03	0,05	0,03	0,05	0,04	●		○
M.1.1	0,9	0,7*	0,6*	55	0,02	0,02	0,03	0,02	0,03	0,02	0,04	0,03	0,05	0,03	●		
M.2.1	0,9	0,7*	0,6*	50	0,02	0,01	0,02	0,02	0,03	0,02	0,03	0,02	0,04	0,03	●		
M.3.1	0,9	0,7*	0,6*	55	0,02	0,01	0,02	0,02	0,03	0,02	0,03	0,02	0,04	0,03	●		
K.1.1	0,9	0,7*	0,6*	225	0,07	0,05	0,08	0,06	0,09	0,07	0,11	0,08	0,13	0,09		●	
K.1.2	0,9	0,7*	0,6*	170	0,05	0,03	0,06	0,04	0,07	0,05	0,08	0,06	0,09	0,06		●	
K.2.1	0,9	0,7*	0,6*	205	0,06	0,04	0,07	0,05	0,08	0,06	0,10	0,07	0,11	0,08		●	
K.2.2	0,9	0,7*	0,6*	170	0,05	0,03	0,06	0,04	0,07	0,05	0,08	0,06	0,09	0,06		●	
K.3.1	0,9	0,7*	0,6*	150	0,05	0,03	0,06	0,04	0,07	0,05	0,08	0,06	0,09	0,06		●	
K.3.2	0,9	0,7*	0,6*	140	0,04	0,03	0,05	0,03	0,06	0,04	0,07	0,05	0,08	0,06		●	
N.1.1	0,9	0,7*	0,6*	785	0,08	0,05	0,09	0,06	0,10	0,07	0,13	0,09	0,15	0,10	●		○
N.1.2	0,9	0,7*	0,6*	715	0,07	0,05	0,08	0,06	0,09	0,07	0,12	0,08	0,13	0,09	●		○
N.2.1	0,9	0,7*	0,6*	475	0,07	0,05	0,09	0,06	0,10	0,07	0,12	0,09	0,14	0,10	●		○
N.2.2	0,9	0,7*	0,6*	380	0,08	0,05	0,09	0,06	0,10	0,07	0,13	0,09	0,15	0,10	●		○
N.2.3	0,9	0,7*	0,6*	275	0,08	0,06	0,10	0,07	0,11	0,08	0,14	0,10	0,16	0,11	●		○
N.3.1	0,9	0,7*	0,6*	340	0,03	0,02	0,04	0,03	0,05	0,03	0,06	0,04	0,07	0,05	●		○
N.3.2	0,9	0,7*	0,6*	205	0,06	0,04	0,07	0,05	0,08	0,05	0,09	0,07	0,11	0,07	●		○
N.3.3	0,9	0,7*	0,6*	275	0,06	0,04	0,07	0,05	0,08	0,05	0,09	0,07	0,11	0,07	●		○
N.4.1																	
S.1.1																	
S.1.2																	
S.2.1																	
S.2.2																	
S.2.3																	
S.3.1																	
S.3.2																	
S.3.3																	
H.1.1																	
H.1.2																	
H.1.3																	
H.1.4																	
H.2.1																	
H.3.1																	
O.1.1																	
O.1.2																	
O.2.1																	
O.2.2																	
O.3.1																	

* = Trimming and trochoidal slot milling



For unstable applications, the cutting data can be reduced.

Cutting data standard values – MultiChange – HFC milling heads

Index	52 864 ...																		● 1st choice ○ suitable							
	Correction factor f_c and v_c Medium Holder	Correction factor f_c and v_c Long Holder	Correction factor f_c and v_c Extra Long Holder	v_c (m/min)	$a_{p,max}$ x DCX	Feedrates for extra short and short holder																		Emulsion	Compressed air	MMS
						\varnothing DCX (mm) =																				
						8			10			12			16			20								
						a_e x DCX =																				
						0,1-0,2			0,3-0,4			0,6-1,0			0,1-0,2			0,3-0,4			0,6-1,0					
f_z (mm)																										
P.1.1	0,9	0,7*	0,6*	175	0,05	0,44	0,31	0,20	0,53	0,37	0,24	0,61	0,43	0,27	0,74	0,52	0,33	0,85	0,60	0,38	○	●	○			
P.1.2	0,9	0,7*	0,6*	165	0,05	0,42	0,30	0,19	0,50	0,36	0,22	0,58	0,41	0,26	0,71	0,50	0,32	0,81	0,57	0,36	○	●	○			
P.1.3	0,9	0,7*	0,6*	160	0,05	0,40	0,28	0,18	0,48	0,34	0,21	0,55	0,39	0,25	0,67	0,48	0,30	0,77	0,54	0,34	○	●	○			
P.1.4	0,9	0,7*	0,6*	150	0,05	0,38	0,27	0,17	0,45	0,32	0,20	0,52	0,37	0,23	0,64	0,45	0,29	0,73	0,52	0,33	○	●	○			
P.1.5	0,9	0,7*	0,6*	145	0,05	0,36	0,25	0,16	0,43	0,30	0,19	0,50	0,35	0,22	0,60	0,43	0,27	0,69	0,49	0,31	○	●	○			
P.2.1	0,9	0,7*	0,6*	160	0,05	0,44	0,31	0,20	0,53	0,37	0,24	0,61	0,43	0,27	0,74	0,52	0,33	0,85	0,60	0,38	○	●	○			
P.2.2	0,9	0,7*	0,6*	145	0,05	0,40	0,28	0,18	0,48	0,34	0,21	0,55	0,39	0,25	0,67	0,48	0,30	0,77	0,54	0,34	○	●	○			
P.2.3	0,9	0,7*	0,6*	130	0,05	0,36	0,25	0,16	0,43	0,30	0,19	0,50	0,35	0,22	0,60	0,43	0,27	0,69	0,49	0,31	○	●	○			
P.2.4	0,9	0,7*	0,6*	100	0,05	0,33	0,24	0,15	0,40	0,28	0,18	0,46	0,32	0,21	0,56	0,40	0,25	0,64	0,45	0,29	○	●	○			
P.3.1	0,9	0,7*	0,6*	95	0,05	0,39	0,27	0,17	0,46	0,33	0,21	0,53	0,38	0,24	0,65	0,46	0,29	0,74	0,53	0,33	●	○	○			
P.3.2	0,9	0,7*	0,6*	85	0,05	0,37	0,26	0,16	0,44	0,31	0,20	0,50	0,36	0,23	0,62	0,44	0,28	0,70	0,50	0,32	●	○	○			
P.3.3	0,9	0,7*	0,6*	80	0,05	0,35	0,24	0,15	0,41	0,29	0,19	0,48	0,34	0,21	0,58	0,41	0,26	0,67	0,47	0,30	●	○	○			
P.4.1	0,9	0,7*	0,6*	65	0,05	0,27	0,19	0,12	0,32	0,23	0,14	0,37	0,26	0,16	0,45	0,32	0,20	0,51	0,36	0,23	●	○	○			
P.4.2	0,9	0,7*	0,6*	65	0,05	0,27	0,19	0,12	0,32	0,23	0,14	0,37	0,26	0,16	0,45	0,32	0,20	0,51	0,36	0,23	●	○	○			
M.1.1	0,9	0,7*	0,6*	45	0,05	0,23	0,16	0,10	0,28	0,20	0,12	0,32	0,23	0,14	0,39	0,28	0,18	0,45	0,32	0,20	●	○	○			
M.2.1	0,9	0,7*	0,6*	40	0,05	0,19	0,14	0,09	0,23	0,16	0,10	0,27	0,19	0,12	0,32	0,23	0,15	0,37	0,26	0,17	●	○	○			
M.3.1	0,9	0,7*	0,6*	45	0,05	0,20	0,14	0,09	0,24	0,17	0,11	0,28	0,19	0,12	0,34	0,24	0,15	0,38	0,27	0,17	●	○	○			
K.1.1	0,9	0,7*	0,6*	175	0,05	0,67	0,47	0,30	0,80	0,56	0,36	0,92	0,65	0,41	1,12	0,79	0,50	1,28	0,91	0,57	○	●	○			
K.1.2	0,9	0,7*	0,6*	130	0,05	0,47	0,33	0,21	0,56	0,39	0,25	0,64	0,45	0,29	0,78	0,55	0,35	0,90	0,63	0,40	○	●	○			
K.2.1	0,9	0,7*	0,6*	160	0,05	0,57	0,40	0,25	0,68	0,48	0,30	0,78	0,55	0,35	0,95	0,67	0,43	1,09	0,77	0,49	○	●	○			
K.2.2	0,9	0,7*	0,6*	130	0,05	0,47	0,33	0,21	0,56	0,39	0,25	0,64	0,45	0,29	0,78	0,55	0,35	0,90	0,63	0,40	○	●	○			
K.3.1	0,9	0,7*	0,6*	115	0,05	0,47	0,33	0,21	0,56	0,39	0,25	0,64	0,45	0,29	0,78	0,55	0,35	0,90	0,63	0,40	○	●	○			
K.3.2	0,9	0,7*	0,6*	110	0,05	0,40	0,28	0,18	0,48	0,34	0,21	0,55	0,39	0,25	0,67	0,48	0,30	0,77	0,54	0,34	○	●	○			
N.1.1																										
N.1.2																										
N.2.1																										
N.2.2																										
N.2.3																										
N.3.1																										
N.3.2																										
N.3.3																										
N.4.1																										
S.1.1																										
S.1.2																										
S.2.1																										
S.2.2																										
S.2.3																										
S.3.1																										
S.3.2																										
S.3.3																										
H.1.1																										
H.1.2																										
H.1.3																										
H.1.4																										
H.2.1																										
H.3.1																										
O.1.1																										
O.1.2																										
O.2.1																										
O.2.2																										
O.3.1																										

* = Trimming and trochoidal slot milling

 For unstable applications, the cutting data can be reduced.

Cutting data standard values – MultiChange – Finishing milling heads

Index	52 863 ...									● 1st choice ○ suitable		
	Correction factor f_z and v_c Medium Holder	Correction factor f_z and v_c Long Holder	Correction factor f_z and v_c Extra Long Holder	v_c (m/min)	Feedrates for extra short and short holder					Emulsion	Compressed air	MMS
					\varnothing DC (mm) =							
					8	10	12	16	20			
					$a_{p,max} =$							
					7,5	9,4	11,3	15,0	18,8			
$a_e \times DC =$ 0,1–0,2												
f_z (mm)												
P.1.1	0,9	0,7*	0,6*	405	0,04	0,05	0,06	0,08	0,09	○	●	○
P.1.2	0,9	0,7*	0,6*	385	0,04	0,05	0,06	0,07	0,08	○	●	○
P.1.3	0,9	0,7*	0,6*	365	0,04	0,05	0,06	0,07	0,08	○	●	○
P.1.4	0,9	0,7*	0,6*	350	0,04	0,05	0,05	0,06	0,07	○	●	○
P.1.5	0,9	0,7*	0,6*	330	0,04	0,04	0,05	0,06	0,07	○	●	○
P.2.1	0,9	0,7*	0,6*	365	0,04	0,05	0,06	0,08	0,09	○	●	○
P.2.2	0,9	0,7*	0,6*	335	0,04	0,05	0,06	0,07	0,08	○	●	○
P.2.3	0,9	0,7*	0,6*	300	0,04	0,04	0,05	0,06	0,07	○	●	○
P.2.4	0,9	0,7*	0,6*	235	0,03	0,04	0,05	0,06	0,06	○	●	○
P.3.1	0,9	0,7*	0,6*	215	0,04	0,05	0,05	0,07	0,08	●		○
P.3.2	0,9	0,7*	0,6*	200	0,04	0,04	0,05	0,06	0,07	●		○
P.3.3	0,9	0,7*	0,6*	185	0,04	0,04	0,05	0,06	0,07	●		○
P.4.1	0,9	0,7*	0,6*	150	0,03	0,03	0,04	0,05	0,05	●		○
P.4.2	0,9	0,7*	0,6*	150	0,03	0,03	0,04	0,05	0,05	●		○
M.1.1	0,9	0,7*	0,6*	100	0,02	0,03	0,03	0,04	0,05	●		
M.2.1	0,9	0,7*	0,6*	95	0,02	0,02	0,03	0,03	0,04	●		
M.3.1	0,9	0,7*	0,6*	100	0,02	0,02	0,03	0,03	0,04	●		
K.1.1	0,9	0,7*	0,6*	400	0,07	0,08	0,09	0,11	0,13		●	
K.1.2	0,9	0,7*	0,6*	300	0,05	0,06	0,07	0,08	0,09		●	
K.2.1	0,9	0,7*	0,6*	365	0,06	0,07	0,08	0,10	0,11		●	
K.2.2	0,9	0,7*	0,6*	300	0,05	0,06	0,07	0,08	0,09		●	
K.3.1	0,9	0,7*	0,6*	265	0,05	0,06	0,07	0,08	0,09		●	
K.3.2	0,9	0,7*	0,6*	250	0,04	0,05	0,06	0,07	0,08		●	
N.1.1												
N.1.2												
N.2.1												
N.2.2												
N.2.3												
N.3.1												
N.3.2												
N.3.3												
N.4.1												
S.1.1												
S.1.2												
S.2.1												
S.2.2												
S.2.3												
S.3.1												
S.3.2												
S.3.3												
H.1.1												
H.1.2												
H.1.3												
H.1.4												
H.2.1												
H.3.1												
O.1.1												
O.1.2												
O.2.1												
O.2.2												
O.3.1												

* = Trimming and trochoidal slot milling

 For unstable applications, the cutting data can be reduced.

Cutting data standard values – MultiChange – Radius torus cutters

Index	52 865 ..., 52 866 ...																		● 1st choice ○ suitable			
	Correction factor f_v and v_c Medium Holder	Correction factor f_v and v_c Long Holder	Correction factor f_v and v_c Extra Long Holder	v_c (m/min)	Feedrates for extra short and short holder															Emulsion	Compressed air	MMS
					Ø DC (mm) =																	
					8			10			12			16			20					
					$a_{p,max} =$																	
					4,8	1,6	0,8	5,6	2,0	1,0	6,8	2,4	1,2	9,0	3,2	1,6	11,3	4,0	2,0			
$a_g \times DC =$																						
0,1-0,2	0,3-0,4	0,6-1,0	0,1-0,2	0,3-0,4	0,6-1,0	0,1-0,2	0,3-0,4	0,6-1,0	0,1-0,2	0,3-0,4	0,6-1,0	0,1-0,2	0,3-0,4	0,6-1,0	0,1-0,2	0,3-0,4	0,6-1,0					
f_z (mm)																						
P.1.1	0,9	0,7*	0,6*	110	0,027	0,025	0,018	0,032	0,030	0,022	0,037	0,034	0,025	0,045	0,042	0,031	0,051	0,048	0,035	○	●	○
P.1.2	0,9	0,7*	0,6*	105	0,025	0,024	0,017	0,030	0,028	0,021	0,035	0,032	0,024	0,043	0,040	0,029	0,049	0,045	0,033	○	●	○
P.1.3	0,9	0,7*	0,6*	100	0,024	0,022	0,017	0,029	0,027	0,020	0,033	0,031	0,023	0,041	0,038	0,028	0,046	0,043	0,032	○	●	○
P.1.4	0,9	0,7*	0,6*	95	0,023	0,021	0,016	0,027	0,026	0,019	0,032	0,029	0,022	0,039	0,036	0,026	0,044	0,041	0,030	○	●	○
P.1.5	0,9	0,7*	0,6*	90	0,022	0,020	0,015	0,026	0,024	0,018	0,030	0,028	0,020	0,037	0,034	0,025	0,042	0,039	0,029	○	●	○
P.2.1	0,9	0,7*	0,6*	100	0,027	0,025	0,018	0,032	0,030	0,022	0,037	0,034	0,025	0,045	0,042	0,031	0,051	0,048	0,035	○	●	○
P.2.2	0,9	0,7*	0,6*	90	0,024	0,022	0,017	0,029	0,027	0,020	0,033	0,031	0,023	0,041	0,038	0,028	0,046	0,043	0,032	○	●	○
P.2.3	0,9	0,7*	0,6*	80	0,022	0,020	0,015	0,026	0,024	0,018	0,030	0,028	0,020	0,037	0,034	0,025	0,042	0,039	0,029	○	●	○
P.2.4	0,9	0,7*	0,6*	65	0,020	0,019	0,014	0,024	0,022	0,016	0,028	0,026	0,019	0,034	0,031	0,023	0,039	0,036	0,026	○	●	○
P.3.1	0,9	0,7*	0,6*	60	0,023	0,022	0,016	0,028	0,026	0,019	0,032	0,030	0,022	0,039	0,037	0,027	0,045	0,042	0,031	●	○	○
P.3.2	0,9	0,7*	0,6*	55	0,022	0,021	0,015	0,026	0,025	0,018	0,030	0,028	0,021	0,037	0,035	0,025	0,043	0,040	0,029	●	○	○
P.3.3	0,9	0,7*	0,6*	50	0,021	0,019	0,014	0,025	0,023	0,017	0,029	0,027	0,020	0,035	0,033	0,024	0,040	0,037	0,028	●	○	○
P.4.1	0,9	0,7*	0,6*	40	0,016	0,015	0,011	0,019	0,018	0,013	0,022	0,021	0,015	0,027	0,025	0,019	0,031	0,029	0,021	●	○	○
P.4.2	0,9	0,7*	0,6*	40	0,016	0,015	0,011	0,019	0,018	0,013	0,022	0,021	0,015	0,027	0,025	0,019	0,031	0,029	0,021	●	○	○
M.1.1	0,9	0,7*	0,6*	27	0,014	0,013	0,010	0,017	0,016	0,012	0,019	0,018	0,013	0,024	0,022	0,016	0,027	0,025	0,019	●	○	○
M.2.1	0,9	0,7*	0,6*	25	0,012	0,011	0,008	0,014	0,013	0,010	0,016	0,015	0,011	0,020	0,018	0,013	0,022	0,021	0,015	●	○	○
M.3.1	0,9	0,7*	0,6*	27	0,012	0,011	0,008	0,014	0,013	0,010	0,017	0,015	0,011	0,020	0,019	0,014	0,023	0,022	0,016	●	○	○
K.1.1	0,9	0,7*	0,6*	110	0,040	0,037	0,028	0,048	0,045	0,033	0,055	0,052	0,038	0,068	0,063	0,046	0,077	0,072	0,053	○	●	○
K.1.2	0,9	0,7*	0,6*	80	0,028	0,026	0,019	0,034	0,031	0,023	0,039	0,036	0,027	0,047	0,044	0,032	0,054	0,050	0,037	○	●	○
K.2.1	0,9	0,7*	0,6*	100	0,034	0,032	0,023	0,041	0,038	0,028	0,047	0,044	0,032	0,057	0,054	0,039	0,066	0,061	0,045	○	●	○
K.2.2	0,9	0,7*	0,6*	80	0,028	0,026	0,019	0,034	0,031	0,023	0,039	0,036	0,027	0,047	0,044	0,032	0,054	0,050	0,037	○	●	○
K.3.1	0,9	0,7*	0,6*	70	0,028	0,026	0,019	0,034	0,031	0,023	0,039	0,036	0,027	0,047	0,044	0,032	0,054	0,050	0,037	○	●	○
K.3.2	0,9	0,7*	0,6*	70	0,024	0,022	0,017	0,029	0,027	0,020	0,033	0,031	0,023	0,041	0,038	0,028	0,046	0,043	0,032	○	●	○
N.1.1	0,9	0,7*	0,6*	420	0,045	0,042	0,031	0,054	0,050	0,037	0,062	0,058	0,042	0,076	0,071	0,052	0,087	0,081	0,059	●	○	○
N.1.2	0,9	0,7*	0,6*	380	0,041	0,038	0,028	0,049	0,046	0,034	0,056	0,053	0,039	0,069	0,064	0,047	0,079	0,073	0,054	●	○	○
N.2.1	0,9	0,7*	0,6*	255	0,043	0,040	0,029	0,052	0,048	0,035	0,059	0,055	0,041	0,072	0,067	0,050	0,083	0,077	0,057	●	○	○
N.2.2	0,9	0,7*	0,6*	205	0,045	0,042	0,031	0,054	0,050	0,037	0,062	0,058	0,042	0,076	0,071	0,052	0,087	0,081	0,059	●	○	○
N.2.3	0,9	0,7*	0,6*	145	0,049	0,046	0,034	0,059	0,055	0,040	0,068	0,063	0,046	0,083	0,077	0,057	0,095	0,088	0,065	●	○	○
N.3.1	0,9	0,7*	0,6*	185	0,020	0,019	0,014	0,025	0,023	0,017	0,028	0,026	0,019	0,034	0,032	0,024	0,039	0,037	0,027	●	○	○
N.3.2	0,9	0,7*	0,6*	110	0,033	0,031	0,022	0,039	0,037	0,027	0,045	0,042	0,031	0,055	0,051	0,038	0,063	0,059	0,043	●	○	○
N.3.3	0,9	0,7*	0,6*	145	0,033	0,031	0,022	0,039	0,037	0,027	0,045	0,042	0,031	0,055	0,051	0,038	0,063	0,059	0,043	●	○	○
N.4.1																						
S.1.1																						
S.1.2																						
S.2.1																						
S.2.2																						
S.2.3																						
S.3.1																						
S.3.2																						
S.3.3																						
H.1.1																						
H.1.2																						
H.1.3																						
H.1.4																						
H.2.1																						
H.3.1																						
O.1.1																						
O.1.2																						
O.2.1																						
O.2.2																						
O.3.1																						

* = Trimming and trochoidal slot milling

 For unstable applications, the cutting data can be reduced.

Cutting data standard values – MultiChange – Radius torus cutters – HSC machining

Index	52 865 ..., 52 866 ...									● 1st choice ○ suitable		
	Correction factor f_v and v_c Medium Holder	Correction factor f_v and v_c Long Holder	Correction factor f_v and v_c Extra Long Holder	v_c (m/min)	Feedrates for extra short and short holder					Emulsion	Compressed air	MMS
					Ø DC (mm) =							
					8	10	12	16	20			
					$a_p/a_p =$							
0,04	0,05	0,06	0,08	0,10	f_z (mm)							
P.1.1	0,9	0,7*	0,6*	385	0,11	0,11	0,11	0,11	0,11	○	●	○
P.1.2	0,9	0,7*	0,6*	365	0,10	0,11	0,11	0,11	0,11	○	●	○
P.1.3	0,9	0,7*	0,6*	350	0,10	0,10	0,10	0,10	0,10	○	●	○
P.1.4	0,9	0,7*	0,6*	330	0,09	0,10	0,10	0,10	0,10	○	●	○
P.1.5	0,9	0,7*	0,6*	315	0,09	0,09	0,09	0,09	0,09	○	●	○
P.2.1	0,9	0,7*	0,6*	350	0,11	0,11	0,11	0,11	0,11	○	●	○
P.2.2	0,9	0,7*	0,6*	315	0,10	0,10	0,10	0,10	0,10	○	●	○
P.2.3	0,9	0,7*	0,6*	285	0,09	0,09	0,09	0,09	0,09	○	●	○
P.2.4	0,9	0,7*	0,6*	220	0,08	0,08	0,09	0,09	0,08	○	●	○
P.3.1	0,9	0,7*	0,6*	205	0,09	0,10	0,10	0,10	0,10	●		○
P.3.2	0,9	0,7*	0,6*	190	0,09	0,09	0,09	0,09	0,09	●		○
P.3.3	0,9	0,7*	0,6*	175	0,08	0,09	0,09	0,09	0,09	●		○
P.4.1	0,9	0,7*	0,6*	140	0,07	0,07	0,07	0,07	0,07	●		○
P.4.2	0,9	0,7*	0,6*	140	0,07	0,07	0,07	0,07	0,07	●		○
M.1.1	0,9	0,7*	0,6*	95	0,06	0,06	0,06	0,06	0,06	●		
M.2.1	0,9	0,7*	0,6*	90	0,05	0,05	0,05	0,05	0,05	●		
M.3.1	0,9	0,7*	0,6*	95	0,05	0,05	0,05	0,05	0,05	●		
K.1.1	0,9	0,7*	0,6*	380	0,16	0,17	0,17	0,17	0,17		●	
K.1.2	0,9	0,7*	0,6*	285	0,11	0,12	0,12	0,12	0,12		●	
K.2.1	0,9	0,7*	0,6*	350	0,14	0,14	0,14	0,15	0,14		●	
K.2.2	0,9	0,7*	0,6*	285	0,11	0,12	0,12	0,12	0,12		●	
K.3.1	0,9	0,7*	0,6*	255	0,11	0,12	0,12	0,12	0,12		●	
K.3.2	0,9	0,7*	0,6*	235	0,10	0,10	0,10	0,10	0,10		●	
N.1.1	0,9	0,7*	0,6*	840	0,18	0,19	0,19	0,19	0,19	●		○
N.1.2	0,9	0,7*	0,6*	765	0,17	0,17	0,17	0,17	0,17	●		○
N.2.1	0,9	0,7*	0,6*	510	0,17	0,18	0,18	0,18	0,18	●		○
N.2.2	0,9	0,7*	0,6*	405	0,18	0,19	0,19	0,19	0,19	●		○
N.2.3	0,9	0,7*	0,6*	290	0,20	0,21	0,21	0,21	0,20	●		○
N.3.1	0,9	0,7*	0,6*	365	0,08	0,09	0,09	0,09	0,09	●		○
N.3.2	0,9	0,7*	0,6*	220	0,13	0,14	0,14	0,14	0,14	●		○
N.3.3	0,9	0,7*	0,6*	290	0,13	0,14	0,14	0,14	0,14	●		○
N.4.1												
S.1.1												
S.1.2												
S.2.1												
S.2.2												
S.2.3												
S.3.1												
S.3.2												
S.3.3												
H.1.1												
H.1.2												
H.1.3												
H.1.4												
H.2.1												
H.3.1												
O.1.1				150	0,083	0,086	0,087	0,087	0,085	●		
O.1.2				100	0,083	0,086	0,087	0,087	0,085	●		
O.2.1												
O.2.2												
O.3.1												

* = Trimming and trochoidal slot milling

 For unstable applications, the cutting data can be reduced.

Cutting data standard values – MultiChange – Torus cutter heads

Index	52 870 ...												● 1st choice ○ suitable			
	Correction factor f_c and v_c Medium Holder	Correction factor f_c and v_c Long Holder	Correction factor f_c and v_c Extra Long Holder	v_c (m/min)	Feedrates for extra short and short holder								Emulsion	Compressed air	MMS	
					\varnothing DC (mm) =											
					10		12		16		20					
					$a_{p,max.} =$											
					5,0	3,0	6,0	3,6	8,0	4,8	10,0	6,0				
$a_e \times DC$																
f_z (mm)																
P.1.1																
P.1.2																
P.1.3																
P.1.4																
P.1.5																
P.2.1																
P.2.2																
P.2.3																
P.2.4																
P.3.1																
P.3.2																
P.3.3																
P.4.1																
P.4.2																
M.1.1																
M.2.1																
M.3.1																
K.1.1																
K.1.2																
K.2.1																
K.2.2																
K.3.1																
K.3.2																
N.1.1	0,9	0,7	0,6	840	0,187	0,216	0,215	0,248	0,263	0,303	0,301	0,346	●			
N.1.2	0,9	0,7	0,6	765	0,170	0,196	0,196	0,225	0,239	0,275	0,273	0,315	●			
N.2.1	0,9	0,7	0,6	510	0,179	0,206	0,206	0,237	0,251	0,289	0,287	0,331	●			
N.2.2	0,9	0,7	0,6	405	0,187	0,216	0,215	0,248	0,263	0,303	0,301	0,346	●			
N.2.3	0,9	0,7	0,6	295	0,204	0,235	0,235	0,271	0,287	0,331	0,328	0,378	●			
N.3.1																
N.3.2																
N.3.3																
N.4.1																
S.1.1																
S.1.2																
S.2.1																
S.2.2																
S.2.3																
S.3.1																
S.3.2																
S.3.3																
H.1.1																
H.1.2																
H.1.3																
H.1.4																
H.2.1																
H.3.1																
O.1.1																
O.1.2																
O.2.1																
O.2.2																
O.3.1																

 For unstable applications, the cutting data can be reduced.

Cutting data standard values – MultiChange – Quarter-round cutter heads

Index	v _c (m/min)	52 869 ...												● 1st choice ○ suitable		
		Ø DCX (mm) =												Emulsion	Compressed air	MMS
		8		10		12		16		20						
		PRFRAD =														
0,5	1,0	1,5	2,0	2,5	3,0	3,5	4,0	4,5	5,0	5,0	6,0					
f _z (mm)																
P.1.1	150	0,03	0,03	0,04	0,03	0,05	0,05	0,04	0,07	0,07	0,06	0,08	0,08	○	●	○
P.1.2	170	0,03	0,03	0,04	0,04	0,06	0,05	0,05	0,08	0,08	0,07	0,09	0,09	○	●	○
P.1.3	130	0,03	0,04	0,03	0,05	0,05	0,04	0,04	0,08	0,07	0,07	0,09	0,08	○	●	○
P.1.4	120	0,03	0,04	0,03	0,05	0,05	0,04	0,04	0,08	0,07	0,07	0,09	0,08	○	●	○
P.1.5	170	0,03	0,03	0,04	0,04	0,06	0,05	0,05	0,08	0,08	0,07	0,09	0,09	○	●	○
P.2.1	130	0,03	0,02	0,03	0,03	0,05	0,04	0,04	0,06	0,06	0,05	0,07	0,07	○	●	○
P.2.2	130	0,03	0,02	0,03	0,03	0,05	0,04	0,04	0,06	0,06	0,05	0,07	0,07	○	●	○
P.2.3	120	0,03	0,03	0,04	0,03	0,05	0,05	0,04	0,08	0,07	0,07	0,09	0,08	○	●	○
P.2.4	120	0,03	0,03	0,04	0,03	0,05	0,05	0,04	0,08	0,07	0,07	0,09	0,08	○	●	○
P.3.1	80	0,02	0,02	0,03	0,02	0,03	0,03	0,03	0,05	0,05	0,04	0,06	0,06	○	●	○
P.3.2	70	0,02	0,02	0,02	0,02	0,03	0,03	0,02	0,04	0,04	0,04	0,05	0,05	○	●	○
P.3.3	70	0,02	0,02	0,02	0,02	0,03	0,03	0,02	0,04	0,04	0,04	0,05	0,05	○	●	○
P.4.1	70	0,02	0,02	0,02	0,02	0,03	0,03	0,02	0,04	0,04	0,04	0,05	0,05	○	●	○
P.4.2	70	0,02	0,02	0,02	0,02	0,03	0,03	0,02	0,04	0,04	0,04	0,05	0,05	○	●	○
M.1.1	40	0,02	0,02	0,02	0,02	0,03	0,03	0,02	0,04	0,04	0,04	0,05	0,05	●		
M.2.1	40	0,02	0,02	0,02	0,02	0,03	0,03	0,02	0,04	0,04	0,04	0,05	0,05	●		
M.3.1	40	0,02	0,02	0,02	0,02	0,03	0,03	0,02	0,04	0,04	0,04	0,05	0,05	●		
K.1.1	130	0,03	0,03	0,04	0,04	0,06	0,05	0,05	0,08	0,08	0,07	0,09	0,09		●	
K.1.2	100	0,03	0,03	0,04	0,03	0,05	0,05	0,04	0,07	0,07	0,06	0,08	0,08		●	
K.2.1	120	0,03	0,03	0,04	0,03	0,05	0,05	0,04	0,08	0,07	0,07	0,09	0,08		●	
K.2.2	100	0,03	0,02	0,03	0,03	0,05	0,04	0,04	0,06	0,06	0,05	0,07	0,07		●	
K.3.1	100	0,03	0,03	0,04	0,03	0,05	0,05	0,04	0,08	0,07	0,07	0,09	0,08		●	
K.3.2	90	0,03	0,02	0,03	0,03	0,05	0,04	0,04	0,06	0,06	0,05	0,07	0,07		●	
N.1.1	430	0,05	0,04	0,06	0,05	0,09	0,08	0,07	0,12	0,11	0,1	0,14	0,13	●		○
N.1.2	380	0,05	0,04	0,06	0,05	0,09	0,08	0,07	0,12	0,11	0,1	0,14	0,13	●		○
N.2.1	260	0,05	0,04	0,05	0,05	0,08	0,07	0,06	0,11	0,1	0,09	0,12	0,12	●		○
N.2.2	320	0,05	0,04	0,06	0,05	0,08	0,07	0,07	0,11	0,11	0,1	0,13	0,12	●		○
N.2.3	130	0,04	0,03	0,05	0,04	0,07	0,06	0,05	0,1	0,09	0,08	0,11	0,1	●		○
N.3.1	190	0,03	0,03	0,04	0,04	0,06	0,05	0,05	0,08	0,08	0,07	0,09	0,09	●		○
N.3.2	170	0,02	0,02	0,02	0,02	0,03	0,03	0,03	0,04	0,04	0,04	0,05	0,05	●		○
N.3.3	140	0,02	0,02	0,02	0,02	0,03	0,03	0,02	0,04	0,04	0,04	0,05	0,05	●		○
N.4.1																
S.1.1																
S.1.2																
S.2.1																
S.2.2																
S.2.3																
S.3.1																
S.3.2																
S.3.3																
H.1.1																
H.1.2																
H.1.3																
H.1.4																
H.2.1																
H.3.1																
O.1.1																
O.1.2																
O.2.1																
O.2.2																
O.3.1																

 For unstable applications, the cutting data can be reduced.

Cutting data standard values – MultiChange – Deburring milling heads

Index	Correction factor f_z and v_c Medium Holder	Correction factor f_z and v_c Long Holder	Correction factor f_z and v_c Extra Long Holder	v_c (m/min)	52 867 ...				52 868 ...				● 1st choice ○ suitable		
					Feedrates for extra short and short holder								Emulsion	Compressed air	MMS
					\varnothing DCX (mm) =				\varnothing DCX (mm) =						
					10	12	16	20	10	12	16	20			
					$a_{p,max}$ (mm) =				$a_{p,max}$ (mm) =						
5,0	6,0	4,8	6,0	1,25	1,5	2,0	2,5								
a_e 0,1– 0,2 x DCX				a_e 0,1– 0,2 x DCX				f_z (mm)							
P.1.1	0,9	0,7	0,6	200	0,06	0,07	0,08	0,09	0,06	0,07	0,08	0,09	○	●	○
P.1.2	0,9	0,7	0,6	190	0,06	0,06	0,08	0,09	0,06	0,06	0,08	0,09	○	●	○
P.1.3	0,9	0,7	0,6	185	0,05	0,06	0,07	0,08	0,05	0,06	0,07	0,08	○	●	○
P.1.4	0,9	0,7	0,6	175	0,05	0,06	0,07	0,08	0,05	0,06	0,07	0,08	○	●	○
P.1.5	0,9	0,7	0,6	165	0,05	0,05	0,07	0,08	0,05	0,05	0,07	0,08	○	●	○
P.2.1	0,9	0,7	0,6	185	0,06	0,07	0,08	0,09	0,06	0,07	0,08	0,09	○	●	○
P.2.2	0,9	0,7	0,6	165	0,05	0,06	0,07	0,08	0,05	0,06	0,07	0,08	○	●	○
P.2.3	0,9	0,7	0,6	150	0,05	0,05	0,07	0,08	0,05	0,05	0,07	0,08	○	●	○
P.2.4	0,9	0,7	0,6	115	0,04	0,05	0,06	0,07	0,04	0,05	0,06	0,07	○	●	○
P.3.1	0,9	0,7	0,6	110	0,05	0,06	0,07	0,08	0,05	0,06	0,07	0,08	●		○
P.3.2	0,9	0,7	0,6	100	0,05	0,06	0,07	0,08	0,05	0,06	0,07	0,08	●		○
P.3.3	0,9	0,7	0,6	90	0,05	0,05	0,06	0,07	0,05	0,05	0,06	0,07	●		○
P.4.1	0,9	0,7	0,6	75	0,04	0,04	0,05	0,06	0,04	0,04	0,05	0,06	●		○
P.4.2	0,9	0,7	0,6	75	0,04	0,04	0,05	0,06	0,04	0,04	0,05	0,06	●		○
M.1.1	0,9	0,7	0,6	50	0,03	0,04	0,04	0,05	0,03	0,04	0,04	0,05	●		
M.2.1	0,9	0,7	0,6	45	0,03	0,03	0,04	0,04	0,03	0,03	0,04	0,04	●		
M.3.1	0,9	0,7	0,6	50	0,03	0,03	0,04	0,04	0,03	0,03	0,04	0,04	●		
K.1.1	0,9	0,7	0,6	200	0,09	0,10	0,12	0,14	0,09	0,10	0,12	0,14		●	
K.1.2	0,9	0,7	0,6	150	0,06	0,07	0,09	0,10	0,06	0,07	0,09	0,10		●	
K.2.1	0,9	0,7	0,6	185	0,07	0,09	0,11	0,12	0,07	0,09	0,11	0,12		●	
K.2.2	0,9	0,7	0,6	150	0,06	0,07	0,09	0,10	0,06	0,07	0,09	0,10		●	
K.3.1	0,9	0,7	0,6	135	0,06	0,07	0,09	0,10	0,06	0,07	0,09	0,10		●	
K.3.2	0,9	0,7	0,6	125	0,05	0,06	0,07	0,08	0,05	0,06	0,07	0,08		●	
N.1.1	0,9	0,7	0,6	550	0,10	0,11	0,14	0,16	0,10	0,11	0,14	0,16	●		○
N.1.2	0,9	0,7	0,6	500	0,09	0,10	0,13	0,14	0,09	0,10	0,13	0,14	●		○
N.2.1	0,9	0,7	0,6	330	0,09	0,11	0,13	0,15	0,09	0,11	0,13	0,15	●		○
N.2.2	0,9	0,7	0,6	265	0,10	0,11	0,14	0,16	0,10	0,11	0,14	0,16	●		○
N.2.3	0,9	0,7	0,6	190	0,11	0,12	0,15	0,17	0,11	0,12	0,15	0,17	●		○
N.3.1	0,9	0,7	0,6	240	0,04	0,05	0,06	0,07	0,04	0,05	0,06	0,07	●		○
N.3.2	0,9	0,7	0,6	145	0,07	0,08	0,10	0,12	0,07	0,08	0,10	0,12	●		○
N.3.3	0,9	0,7	0,6	190	0,07	0,08	0,10	0,12	0,07	0,08	0,10	0,12	●		○
N.4.1															
S.1.1															
S.1.2															
S.2.1															
S.2.2															
S.2.3															
S.3.1															
S.3.2															
S.3.3															
H.1.1															
H.1.2															
H.1.3															
H.1.4															
H.2.1															
H.3.1															
O.1.1															
O.1.2															
O.2.1															
O.2.2															
O.3.1															

 For unstable applications the machining parameters must be reduced.

Cutting data standard values – T-slot milling cutter

Index	v _c (m/min)	54 065 ...												● 1st choice ○ suitable		
		Ø DC (mm) =												Emulsion	Compressed air	MMS
		11,0	12,5	16,0	18,0	19,0	21,0	22,0	25,0	28,0	32,0	36,0	40,0			
f _z (mm)																
P.1.1	72	0,015	0,018	0,021	0,025	0,028	0,030	0,030	0,030	0,035	0,040	0,045	0,050	●		
P.1.2	68	0,015	0,018	0,021	0,025	0,028	0,030	0,030	0,030	0,035	0,040	0,045	0,050	●		
P.1.3	68	0,015	0,018	0,021	0,025	0,028	0,030	0,030	0,030	0,035	0,040	0,045	0,050	●		
P.1.4	64	0,015	0,018	0,021	0,025	0,028	0,030	0,030	0,030	0,035	0,040	0,045	0,050	●		
P.1.5	64	0,015	0,018	0,021	0,025	0,028	0,030	0,030	0,030	0,035	0,040	0,045	0,050	●		
P.2.1	64	0,015	0,018	0,021	0,025	0,028	0,030	0,030	0,030	0,035	0,040	0,045	0,050	●		
P.2.2	64	0,015	0,018	0,021	0,025	0,028	0,030	0,030	0,030	0,035	0,040	0,045	0,050	●		
P.2.3	56	0,015	0,018	0,021	0,025	0,028	0,030	0,030	0,030	0,035	0,040	0,045	0,050	●		
P.2.4	56	0,015	0,018	0,021	0,025	0,028	0,030	0,030	0,030	0,035	0,040	0,045	0,050	●		
P.3.1	64	0,015	0,018	0,021	0,025	0,028	0,030	0,030	0,030	0,035	0,040	0,045	0,050	●		
P.3.2	60	0,015	0,018	0,021	0,025	0,028	0,030	0,030	0,030	0,035	0,040	0,045	0,050	●		
P.3.3	52	0,015	0,018	0,021	0,025	0,028	0,030	0,030	0,030	0,035	0,040	0,045	0,050	●		
P.4.1	40	0,010	0,012	0,014	0,017	0,019	0,020	0,020	0,020	0,023	0,027	0,030	0,033	●		
P.4.2	40	0,010	0,012	0,014	0,017	0,019	0,020	0,020	0,020	0,023	0,027	0,030	0,033	●		
M.1.1	40	0,010	0,012	0,014	0,017	0,019	0,020	0,020	0,020	0,023	0,027	0,030	0,033	●		
M.2.1	40	0,010	0,012	0,014	0,017	0,019	0,020	0,020	0,020	0,023	0,027	0,030	0,033	●		
M.3.1	40	0,010	0,012	0,014	0,017	0,019	0,020	0,020	0,020	0,023	0,027	0,030	0,033	●		
K.1.1	68	0,040	0,048	0,056	0,067	0,075	0,080	0,080	0,080	0,093	0,093	0,105	0,117	●		
K.1.2	56	0,030	0,036	0,042	0,050	0,056	0,060	0,060	0,060	0,070	0,070	0,079	0,088	●		
K.2.1	64	0,030	0,036	0,042	0,050	0,056	0,060	0,060	0,060	0,070	0,070	0,079	0,088	●		
K.2.2	52	0,030	0,036	0,042	0,050	0,056	0,060	0,060	0,060	0,070	0,070	0,079	0,088	●		
K.3.1	56	0,030	0,036	0,042	0,050	0,056	0,060	0,060	0,060	0,070	0,070	0,079	0,088	●		
K.3.2	54	0,030	0,036	0,042	0,050	0,056	0,060	0,060	0,060	0,070	0,070	0,079	0,088	●		
N.1.1																
N.1.2																
N.2.1																
N.2.2																
N.2.3																
N.3.1																
N.3.2																
N.3.3																
N.4.1																
S.1.1																
S.1.2																
S.2.1																
S.2.2																
S.2.3																
S.3.1																
S.3.2																
S.3.3																
H.1.1																
H.1.2																
H.1.3																
H.1.4																
H.2.1																
H.3.1																
O.1.1																
O.1.2																
O.2.1																
O.2.2																
O.3.1																

 The feed f_z must be reduced by 50% until the tool is fully engaged.

Cutting data standard values – mini milling cutter, uncoated

Index	Extra-short type		50 608 ..., 50 664 ...															
			Ø DC (mm) =															
			0,5		1,0		1,2		1,5		1,8-2,0		2,5-3,0		3,5-4,0			
			a_p 0,1-0,2 x DC	a_p 0,3-0,4 x DC	a_p 0,1-0,2 x DC	a_p 0,3-0,4 x DC	a_p 0,1-0,2 x DC	a_p 0,3-0,4 x DC	a_p 0,1-0,2 x DC	a_p 0,3-0,4 x DC	a_p 0,1-0,2 x DC	a_p 0,3-0,4 x DC	a_p 0,1-0,2 x DC	a_p 0,3-0,4 x DC	a_p 0,6-1,0 x DC	a_p 0,1-0,2 x DC	a_p 0,3-0,4 x DC	a_p 0,6-1,0 x DC
v_c (m/min)	$a_{p,max}$ x DC	f_z (mm)																
P.1.1																		
P.1.2																		
P.1.3																		
P.1.4																		
P.1.5																		
P.2.1																		
P.2.2																		
P.2.3																		
P.2.4																		
P.3.1																		
P.3.2																		
P.3.3																		
P.4.1																		
P.4.2																		
M.1.1																		
M.2.1																		
M.3.1																		
K.1.1																		
K.1.2																		
K.2.1																		
K.2.2																		
K.3.1																		
K.3.2																		
N.1.1	250	1,0	0,007	0,006	0,011	0,009	0,014	0,011	0,018	0,014	0,024	0,019	0,038	0,030	0,019	0,050	0,040	0,025
N.1.2	250	1,0	0,007	0,006	0,011	0,009	0,014	0,011	0,018	0,014	0,024	0,019	0,038	0,030	0,019	0,050	0,040	0,025
N.2.1	180	1,0	0,009	0,007	0,013	0,010	0,016	0,013	0,020	0,016	0,026	0,021	0,037	0,030	0,019	0,048	0,038	0,024
N.2.2	180	1,0	0,009	0,007	0,013	0,010	0,016	0,013	0,020	0,016	0,026	0,021	0,037	0,030	0,019	0,048	0,038	0,024
N.2.3	150	1,0	0,009	0,007	0,013	0,010	0,016	0,013	0,020	0,016	0,026	0,021	0,037	0,030	0,019	0,048	0,038	0,024
N.3.1	200	1,0	0,004	0,003	0,008	0,006	0,010	0,008	0,014	0,011	0,018	0,014	0,028	0,022	0,014	0,038	0,030	0,019
N.3.2	200	1,0	0,004	0,003	0,008	0,006	0,010	0,008	0,014	0,011	0,018	0,014	0,028	0,022	0,014	0,038	0,030	0,019
N.3.3	140	1,0	0,004	0,003	0,008	0,006	0,010	0,008	0,014	0,011	0,018	0,014	0,028	0,022	0,014	0,038	0,030	0,019
N.4.1	180	1,0	0,009	0,007	0,013	0,010	0,016	0,013	0,020	0,016	0,026	0,021	0,037	0,030	0,019	0,048	0,038	0,024
S.1.1																		
S.1.2																		
S.2.1																		
S.2.2																		
S.2.3																		
S.3.1	50	0,5	0,003	0,002	0,005	0,004	0,006	0,005	0,007	0,006	0,010	0,008	0,015	0,012	0,008	0,020	0,016	0,010
S.3.2	20	0,5	0,003	0,002	0,005	0,004	0,006	0,005	0,007	0,006	0,010	0,008	0,015	0,012	0,008	0,020	0,016	0,010
S.3.3																		
H.1.1																		
H.1.2																		
H.1.3																		
H.1.4																		
H.2.1																		
H.3.1																		
O.1.1																		
O.1.2																		
O.2.1																		
O.2.2																		
O.3.1																		

Index	50 608 ..., 50 664 ...												● 1st choice			
	Ø DC (mm) =												○ suitable			
	4,5-5,0			5,5-6,0			6,7-8,0			8,7-10,0			Emulsion	Compressed air	MMS	
	a_p 0,1-0,2 x DC	a_p 0,3-0,4 x DC	a_p 0,6-1,0 x DC	a_p 0,1-0,2 x DC	a_p 0,3-0,4 x DC	a_p 0,6-1,0 x DC	a_p 0,1-0,2 x DC	a_p 0,3-0,4 x DC	a_p 0,6-1,0 x DC	a_p 0,1-0,2 x DC	a_p 0,3-0,4 x DC	a_p 0,6-1,0 x DC				
f _z (mm)																
P.1.1																
P.1.2																
P.1.3																
P.1.4																
P.1.5																
P.2.1																
P.2.2																
P.2.3																
P.2.4																
P.3.1																
P.3.2																
P.3.3																
P.4.1																
P.4.2																
M.1.1																
M.2.1																
M.3.1																
K.1.1																
K.1.2																
K.2.1																
K.2.2																
K.3.1																
K.3.2																
N.1.1	0,064	0,051	0,032	0,077	0,062	0,039	0,104	0,083	0,052	0,130	0,104	0,065	●			○
N.1.2	0,064	0,051	0,032	0,077	0,062	0,039	0,104	0,083	0,052	0,130	0,104	0,065	●			○
N.2.1	0,060	0,048	0,030	0,070	0,056	0,035	0,094	0,075	0,047	0,116	0,093	0,058	●			○
N.2.2	0,060	0,048	0,030	0,070	0,056	0,035	0,094	0,075	0,047	0,116	0,093	0,058	●			○
N.2.3	0,060	0,048	0,030	0,070	0,056	0,035	0,094	0,075	0,047	0,116	0,093	0,058	●			○
N.3.1	0,049	0,039	0,025	0,060	0,048	0,030	0,080	0,064	0,040	0,100	0,080	0,050	●			○
N.3.2	0,049	0,039	0,025	0,060	0,048	0,030	0,080	0,064	0,040	0,100	0,080	0,050	●			○
N.3.3	0,049	0,039	0,025	0,060	0,048	0,030	0,080	0,064	0,040	0,100	0,080	0,050	●			○
N.4.1	0,060	0,048	0,030	0,070	0,056	0,035	0,094	0,075	0,047	0,116	0,093	0,058	●			○
S.1.1																
S.1.2																
S.2.1																
S.2.2																
S.2.3																
S.3.1	0,025	0,020	0,013	0,030	0,024	0,015	0,040	0,032	0,020	0,050	0,040	0,025	●			○
S.3.2	0,025	0,020	0,013	0,030	0,024	0,015	0,040	0,032	0,020	0,050	0,040	0,025	●			○
S.3.3																
H.1.1																
H.1.2																
H.1.3																
H.1.4																
H.2.1																
H.3.1																
O.1.1																
O.1.2																
O.2.1																
O.2.2																
O.3.1																

Cutting data standard values – mini milling cutter, coated

Index	Extra-short type v _c (m/min) a _{p,max.} x DC		50 609 ..., 50 691 ...															
			Ø DC (mm) =															
			0,5		1,0		1,2		1,5		1,8-2,0		2,5-3,0			3,5-4,0		
			a _p 0,1-0,2 x DC	a _p 0,3-0,4 x DC	a _p 0,1-0,2 x DC	a _p 0,3-0,4 x DC	a _p 0,1-0,2 x DC	a _p 0,3-0,4 x DC	a _p 0,1-0,2 x DC	a _p 0,3-0,4 x DC	a _p 0,1-0,2 x DC	a _p 0,3-0,4 x DC	a _p 0,1-0,2 x DC	a _p 0,3-0,4 x DC	a _p 0,6-1,0 x DC	a _p 0,1-0,2 x DC	a _p 0,3-0,4 x DC	a _p 0,6-1,0 x DC
f _z (mm)																		
P.1.1	110	1,0	0,011	0,009	0,014	0,011	0,015	0,012	0,017	0,014	0,020	0,016	0,027	0,022	0,014	0,034	0,027	0,017
P.1.2	90	1,0	0,006	0,005	0,008	0,006	0,010	0,008	0,012	0,010	0,015	0,012	0,022	0,018	0,011	0,028	0,022	0,014
P.1.3	90	1,0	0,006	0,005	0,008	0,006	0,010	0,008	0,012	0,010	0,015	0,012	0,022	0,018	0,011	0,028	0,022	0,014
P.1.4	80	1,0	0,006	0,005	0,008	0,006	0,010	0,008	0,012	0,010	0,015	0,012	0,022	0,018	0,011	0,028	0,022	0,014
P.1.5	80	1,0	0,006	0,005	0,008	0,006	0,010	0,008	0,012	0,010	0,015	0,012	0,022	0,018	0,011	0,028	0,022	0,014
P.2.1	90	1,0	0,006	0,005	0,008	0,006	0,010	0,008	0,012	0,010	0,015	0,012	0,022	0,018	0,011	0,028	0,022	0,014
P.2.2	70	1,0	0,006	0,005	0,008	0,006	0,010	0,008	0,012	0,010	0,015	0,012	0,022	0,018	0,011	0,028	0,022	0,014
P.2.3	70	1,0	0,006	0,005	0,008	0,006	0,010	0,008	0,012	0,010	0,015	0,012	0,022	0,018	0,011	0,028	0,022	0,014
P.2.4	55	1,0	0,006	0,005	0,008	0,006	0,010	0,008	0,012	0,010	0,015	0,012	0,022	0,018	0,011	0,028	0,022	0,014
P.3.1																		
P.3.2																		
P.3.3																		
P.4.1	50	1,0	0,003	0,002	0,005	0,004	0,006	0,005	0,007	0,006	0,010	0,008	0,015	0,012	0,008	0,020	0,016	0,010
P.4.2	40	1,0	0,003	0,002	0,005	0,004	0,006	0,005	0,007	0,006	0,010	0,008	0,015	0,012	0,008	0,020	0,016	0,010
M.1.1	40	1,0	0,003	0,002	0,005	0,004	0,006	0,005	0,007	0,006	0,010	0,008	0,015	0,012	0,008	0,020	0,016	0,010
M.2.1	50	1,0	0,003	0,002	0,005	0,004	0,006	0,005	0,007	0,006	0,010	0,008	0,015	0,012	0,008	0,020	0,016	0,010
M.3.1	50	1,0	0,003	0,002	0,005	0,004	0,006	0,005	0,007	0,006	0,010	0,008	0,015	0,012	0,008	0,020	0,016	0,010
K.1.1	130	1,0	0,018	0,014	0,022	0,018	0,024	0,019	0,028	0,022	0,034	0,027	0,044	0,035	0,022	0,056	0,045	0,028
K.1.2	120	1,0	0,018	0,014	0,022	0,018	0,024	0,019	0,028	0,022	0,034	0,027	0,044	0,035	0,022	0,056	0,045	0,028
K.2.1	130	1,0	0,017	0,014	0,020	0,016	0,022	0,018	0,024	0,019	0,028	0,022	0,035	0,028	0,018	0,042	0,034	0,021
K.2.2	120	1,0	0,017	0,014	0,020	0,016	0,022	0,018	0,024	0,019	0,028	0,022	0,035	0,028	0,018	0,042	0,034	0,021
K.3.1	130	1,0	0,018	0,014	0,022	0,018	0,024	0,019	0,028	0,022	0,034	0,027	0,044	0,035	0,022	0,056	0,045	0,028
K.3.2	120	1,0	0,018	0,014	0,022	0,018	0,024	0,019	0,028	0,022	0,034	0,027	0,044	0,035	0,022	0,056	0,045	0,028
N.1.1																		
N.1.2																		
N.2.1																		
N.2.2																		
N.2.3																		
N.3.1	200	1,0	0,004	0,003	0,008	0,006	0,010	0,008	0,014	0,011	0,018	0,014	0,028	0,022	0,014	0,038	0,030	0,019
N.3.2	200	1,0	0,004	0,003	0,008	0,006	0,010	0,008	0,014	0,011	0,018	0,014	0,028	0,022	0,014	0,038	0,030	0,019
N.3.3	140	1,0	0,004	0,003	0,008	0,006	0,010	0,008	0,014	0,011	0,018	0,014	0,028	0,022	0,014	0,038	0,030	0,019
N.4.1																		
S.1.1	30	0,5	0,003	0,002	0,005	0,004	0,006	0,005	0,007	0,006	0,010	0,008	0,015	0,012	0,008	0,020	0,016	0,010
S.1.2	30	0,5	0,003	0,002	0,005	0,004	0,006	0,005	0,007	0,006	0,010	0,008	0,015	0,012	0,008	0,020	0,016	0,010
S.2.1	30	0,5	0,003	0,002	0,005	0,004	0,006	0,005	0,007	0,006	0,010	0,008	0,015	0,012	0,008	0,020	0,016	0,010
S.2.2	30	0,5	0,003	0,002	0,005	0,004	0,006	0,005	0,007	0,006	0,010	0,008	0,015	0,012	0,008	0,020	0,016	0,010
S.2.3	30	0,5	0,003	0,002	0,005	0,004	0,006	0,005	0,007	0,006	0,010	0,008	0,015	0,012	0,008	0,020	0,016	0,010
S.3.1	50	0,5	0,003	0,002	0,005	0,004	0,006	0,005	0,007	0,006	0,010	0,008	0,015	0,012	0,008	0,020	0,016	0,010
S.3.2	20	0,5	0,003	0,002	0,005	0,004	0,006	0,005	0,007	0,006	0,010	0,008	0,015	0,012	0,008	0,020	0,016	0,010
S.3.3																		
H.1.1																		
H.1.2																		
H.1.3																		
H.1.4																		
H.2.1																		
H.3.1																		
O.1.1																		
O.1.2																		
O.2.1																		
O.2.2																		
O.3.1																		

Index	50 609 ..., 50 691 ...												● 1st choice		
	Ø DC (mm) =												○ suitable		
	4,5-5,0			5,5-6,0			6,7-8,0			8,7-10,0			Emulsion	Compressed air	MMS
	a_p 0,1-0,2 x DC	a_p 0,3-0,4 x DC	a_p 0,6-1,0 x DC	a_p 0,1-0,2 x DC	a_p 0,3-0,4 x DC	a_p 0,6-1,0 x DC	a_p 0,1-0,2 x DC	a_p 0,3-0,4 x DC	a_p 0,6-1,0 x DC	a_p 0,1-0,2 x DC	a_p 0,3-0,4 x DC	a_p 0,6-1,0 x DC			
f _z (mm)															
P.1.1	0,041	0,033	0,021	0,048	0,038	0,024	0,062	0,050	0,031	0,075	0,060	0,038	○	●	○
P.1.2	0,034	0,027	0,017	0,041	0,033	0,021	0,054	0,043	0,027	0,066	0,053	0,033	○	●	○
P.1.3	0,034	0,027	0,017	0,041	0,033	0,021	0,054	0,043	0,027	0,066	0,053	0,033	○	●	○
P.1.4	0,034	0,027	0,017	0,041	0,033	0,021	0,054	0,043	0,027	0,066	0,053	0,033	○	●	○
P.1.5	0,034	0,027	0,017	0,041	0,033	0,021	0,054	0,043	0,027	0,066	0,053	0,033	○	●	○
P.2.1	0,034	0,027	0,017	0,041	0,033	0,021	0,054	0,043	0,027	0,066	0,053	0,033	○	●	○
P.2.2	0,034	0,027	0,017	0,041	0,033	0,021	0,054	0,043	0,027	0,066	0,053	0,033	○	●	○
P.2.3	0,034	0,027	0,017	0,041	0,033	0,021	0,054	0,043	0,027	0,066	0,053	0,033	○	●	○
P.2.4	0,034	0,027	0,017	0,041	0,033	0,021	0,054	0,043	0,027	0,066	0,053	0,033	○	●	○
P.3.1															
P.3.2															
P.3.3															
P.4.1	0,025	0,020	0,013	0,030	0,024	0,015	0,040	0,032	0,020	0,050	0,040	0,025	●		○
P.4.2	0,025	0,020	0,013	0,030	0,024	0,015	0,040	0,032	0,020	0,050	0,040	0,025	●		○
M.1.1	0,025	0,020	0,013	0,030	0,024	0,015	0,040	0,032	0,020	0,050	0,040	0,025	●		○
M.2.1	0,025	0,020	0,013	0,030	0,024	0,015	0,040	0,032	0,020	0,050	0,040	0,025	●		○
M.3.1	0,025	0,020	0,013	0,030	0,024	0,015	0,040	0,032	0,020	0,050	0,040	0,025	●		○
K.1.1	0,066	0,053	0,033	0,078	0,062	0,039	0,100	0,080	0,050	0,122	0,098	0,061	○	●	○
K.1.2	0,066	0,053	0,033	0,078	0,062	0,039	0,100	0,080	0,050	0,122	0,098	0,061	○	●	○
K.2.1	0,050	0,040	0,025	0,058	0,046	0,029	0,072	0,058	0,036	0,086	0,069	0,043	○	●	○
K.2.2	0,050	0,040	0,025	0,058	0,046	0,029	0,072	0,058	0,036	0,086	0,069	0,043	○	●	○
K.3.1	0,066	0,053	0,033	0,078	0,062	0,039	0,100	0,080	0,050	0,122	0,098	0,061	○	●	○
K.3.2	0,066	0,053	0,033	0,078	0,062	0,039	0,100	0,080	0,050	0,122	0,098	0,061	○	●	○
N.1.1															
N.1.2															
N.2.1															
N.2.2															
N.2.3															
N.3.1	0,049	0,039	0,025	0,060	0,048	0,030	0,080	0,064	0,040	0,100	0,080	0,050	●		○
N.3.2	0,049	0,039	0,025	0,060	0,048	0,030	0,080	0,064	0,040	0,100	0,080	0,050	●		○
N.3.3	0,049	0,039	0,025	0,060	0,048	0,030	0,080	0,064	0,040	0,100	0,080	0,050	●		○
N.4.1															
S.1.1	0,025	0,020	0,013	0,030	0,024	0,015	0,040	0,032	0,020	0,050	0,040	0,025	●		○
S.1.2	0,025	0,020	0,013	0,030	0,024	0,015	0,040	0,032	0,020	0,050	0,040	0,025	●		○
S.2.1	0,025	0,020	0,013	0,030	0,024	0,015	0,040	0,032	0,020	0,050	0,040	0,025	●		○
S.2.2	0,025	0,020	0,013	0,030	0,024	0,015	0,040	0,032	0,020	0,050	0,040	0,025	●		○
S.2.3	0,025	0,020	0,013	0,030	0,024	0,015	0,040	0,032	0,020	0,050	0,040	0,025	●		○
S.3.1	0,025	0,020	0,013	0,030	0,024	0,015	0,040	0,032	0,020	0,050	0,040	0,025	●		○
S.3.2	0,025	0,020	0,013	0,030	0,024	0,015	0,040	0,032	0,020	0,050	0,040	0,025	●		○
S.3.3															
H.1.1															
H.1.2															
H.1.3															
H.1.4															
H.2.1															
H.3.1															
O.1.1															
O.1.2															
O.2.1															
O.2.2															
O.3.1															

Cutting data standard values – End mill – W version, short

Index	HPC		54 590..., 54 591..., 54 594..., 54 595..., 54 610..., 54 611..., 54 640..., 54 642...																	
	v _c (m/min)	a _{p,max.} x DC	Ø DC (mm) =																	
			2,7–3,0			3,7–4,0			4,7–5,0			5,7–7,0			7,7–9,0			9,7–11,0		
			a _s 0,1–0,2 x DC	a _s 0,3–0,4 x DC	a _s 0,6–1,0 x DC	a _s 0,1–0,2 x DC	a _s 0,3–0,4 x DC	a _s 0,6–1,0 x DC	a _s 0,1–0,2 x DC	a _s 0,3–0,4 x DC	a _s 0,6–1,0 x DC	a _s 0,1–0,2 x DC	a _s 0,3–0,4 x DC	a _s 0,6–1,0 x DC	a _s 0,1–0,2 x DC	a _s 0,3–0,4 x DC	a _s 0,6–1,0 x DC	a _s 0,1–0,2 x DC	a _s 0,3–0,4 x DC	a _s 0,6–1,0 x DC
f _t (mm)																				
N.1.1	560	1,0*	0,054	0,042	0,030	0,063	0,049	0,035	0,100	0,075	0,050	0,120	0,089	0,060	0,200	0,150	0,100	0,240	0,180	0,120
N.1.2	560	1,0*	0,054	0,042	0,030	0,063	0,049	0,035	0,100	0,075	0,050	0,120	0,089	0,060	0,200	0,150	0,100	0,240	0,180	0,120
N.2.1	336	1,0*	0,054	0,042	0,030	0,063	0,049	0,035	0,100	0,075	0,050	0,120	0,089	0,060	0,200	0,150	0,100	0,240	0,180	0,120
N.2.2	336	1,0*	0,054	0,042	0,030	0,063	0,049	0,035	0,100	0,075	0,050	0,120	0,089	0,060	0,200	0,150	0,100	0,240	0,180	0,120
N.2.3	224	1,0*	0,054	0,042	0,030	0,063	0,049	0,035	0,100	0,075	0,050	0,120	0,089	0,060	0,200	0,150	0,100	0,240	0,180	0,120
N.3.1	224	1,0*	0,036	0,028	0,020	0,054	0,042	0,030	0,080	0,060	0,040	0,100	0,075	0,050	0,160	0,120	0,080	0,200	0,150	0,100
N.3.2	160	1,0*	0,036	0,028	0,020	0,054	0,042	0,030	0,080	0,060	0,040	0,100	0,075	0,050	0,160	0,120	0,080	0,200	0,150	0,100
N.3.3	160	1,0*	0,036	0,028	0,020	0,054	0,042	0,030	0,080	0,060	0,040	0,100	0,075	0,050	0,160	0,120	0,080	0,200	0,150	0,100
N.4.1																				

* = use a_p 1.5 x DC only in a_s range 0.1–0.4 x DC

Cutting data standard values – End mill – W version, long

Index	HPC		50 960 ..., 54 590 ..., 54 592 ..., 54 591 ..., 54 593 ..., 54 594 ..., 54 595 ..., 54 596 ..., 54 597 ..., 54 610 ..., 54 611 ..., 54 612 ..., 54 613 ..., 54 620 ..., 54 630 ..., 54 631 ..., 54 640 ...																	
	v _c (m/min)	a _{p,max.} x DC	Ø DC (mm) =																	
			2,7–3,0			3,7–4,0			4,7–5,0			5,7–7,0			7,7–9,0			9,7–11,0		
			a _s 0,1–0,2 x DC	a _s 0,3–0,4 x DC	a _s 0,6–1,0 x DC	a _s 0,1–0,2 x DC	a _s 0,3–0,4 x DC	a _s 0,6–1,0 x DC	a _s 0,1–0,2 x DC	a _s 0,3–0,4 x DC	a _s 0,6–1,0 x DC	a _s 0,1–0,2 x DC	a _s 0,3–0,4 x DC	a _s 0,6–1,0 x DC	a _s 0,1–0,2 x DC	a _s 0,3–0,4 x DC	a _s 0,6–1,0 x DC	a _s 0,1–0,2 x DC	a _s 0,3–0,4 x DC	a _s 0,6–1,0 x DC
f _t (mm)																				
N.1.1	320	1,0*	0,036	0,028	0,020	0,063	0,049	0,035	0,100	0,075	0,050	0,120	0,089	0,060	0,160	0,120	0,080	0,200	0,150	0,100
N.1.2	320	1,0*	0,036	0,028	0,020	0,063	0,049	0,035	0,100	0,075	0,050	0,120	0,089	0,060	0,160	0,120	0,080	0,200	0,150	0,100
N.2.1	192	1,0*	0,036	0,028	0,020	0,063	0,049	0,035	0,100	0,075	0,050	0,120	0,089	0,060	0,160	0,120	0,080	0,200	0,150	0,100
N.2.2	192	1,0*	0,036	0,028	0,020	0,063	0,049	0,035	0,100	0,075	0,050	0,120	0,089	0,060	0,160	0,120	0,080	0,200	0,150	0,100
N.2.3	128	1,0*	0,036	0,028	0,020	0,063	0,049	0,035	0,100	0,075	0,050	0,120	0,089	0,060	0,160	0,120	0,080	0,200	0,150	0,100
N.3.1	128	1,0*	0,027	0,021	0,015	0,045	0,035	0,025	0,070	0,052	0,035	0,100	0,075	0,050	0,140	0,100	0,070	0,180	0,130	0,090
N.3.2	92	1,0*	0,027	0,021	0,015	0,045	0,035	0,025	0,070	0,052	0,035	0,100	0,075	0,050	0,140	0,100	0,070	0,180	0,130	0,090
N.3.3	92	1,0*	0,027	0,021	0,015	0,045	0,035	0,025	0,070	0,052	0,035	0,100	0,075	0,050	0,140	0,100	0,070	0,180	0,130	0,090
N.4.1																				

* = use a_p 1.5 x DC only in a_s range 0.1–0.4 x DC

Cutting data standard values – End mill – W and WR version, extra long

Index	HPC		54 590 ..., 54 592 ..., 54 610 ..., 54 612 ..., 54 630 ..., 54 631 ..., 54 632 ..., 54 633 ..., 54 650 ..., 54 640 ..., 54 642 ...																	
	v _c (m/min)	a _{p,max.} x DC	Ø DC (mm) =																	
			2,7–3,0			3,7–4,0			4,7–5,0			5,7–7,0			7,7–9,0			9,7–11,0		
			a _s 0,1–0,2 x DC	a _s 0,3–0,4 x DC	a _s 0,6–1,0 x DC	a _s 0,1–0,2 x DC	a _s 0,3–0,4 x DC	a _s 0,6–1,0 x DC	a _s 0,1–0,2 x DC	a _s 0,3–0,4 x DC	a _s 0,6–1,0 x DC	a _s 0,1–0,2 x DC	a _s 0,3–0,4 x DC	a _s 0,6–1,0 x DC	a _s 0,1–0,2 x DC	a _s 0,3–0,4 x DC	a _s 0,6–1,0 x DC	a _s 0,1–0,2 x DC	a _s 0,3–0,4 x DC	a _s 0,6–1,0 x DC
f _t (mm)																				
N.1.1	240	0,750*	0,013	0,010	0,007	0,018	0,014	0,010	0,040	0,030	0,020	0,050	0,037	0,025	0,060	0,050	0,030	0,070	0,050	0,040
N.1.2	240	0,750*	0,013	0,010	0,007	0,018	0,014	0,010	0,040	0,030	0,020	0,050	0,037	0,025	0,060	0,050	0,030	0,070	0,050	0,040
N.2.1	144	0,750*	0,013	0,010	0,007	0,018	0,014	0,010	0,040	0,030	0,020	0,050	0,037	0,025	0,060	0,050	0,030	0,070	0,050	0,040
N.2.2	144	0,750*	0,013	0,010	0,007	0,018	0,014	0,010	0,040	0,030	0,020	0,050	0,037	0,025	0,060	0,050	0,030	0,070	0,050	0,040
N.2.3	100	0,750*	0,013	0,010	0,007	0,018	0,014	0,010	0,040	0,030	0,020	0,050	0,037	0,025	0,060	0,050	0,030	0,070	0,050	0,040
N.3.1	100	0,750*	0,009	0,007	0,005	0,014	0,011	0,008	0,020	0,015	0,010	0,030	0,022	0,015	0,040	0,030	0,020	0,050	0,040	0,030
N.3.2	72	0,750*	0,009	0,007	0,005	0,014	0,011	0,008	0,020	0,015	0,010	0,030	0,022	0,015	0,040	0,030	0,020	0,050	0,040	0,030
N.3.3	72	0,750*	0,009	0,007	0,005	0,014	0,011	0,008	0,020	0,015	0,010	0,030	0,022	0,015	0,040	0,030	0,020	0,050	0,040	0,030
N.4.1																				

* = use a_p 1.5 x DC only in a_s range 0.1–0.4 x DC

Index	54 590..., 54 591..., 54 594..., 54 595..., 54 610..., 54 611..., 54 640..., 54 642...																		Emulsion	MMS
	Ø DC (mm) =																			
	11,7-13,0			13,7-15,0			15,7-16,0			18,0			19,7-20,0			24,7-25,0				
	a_p 0,1-0,2 x DC	a_p 0,3-0,4 x DC	a_p 0,6-1,0 x DC	a_p 0,1-0,2 x DC	a_p 0,3-0,4 x DC	a_p 0,6-1,0 x DC	a_p 0,1-0,2 x DC	a_p 0,3-0,4 x DC	a_p 0,6-1,0 x DC	a_p 0,1-0,2 x DC	a_p 0,3-0,4 x DC	a_p 0,6-1,0 x DC	a_p 0,1-0,2 x DC	a_p 0,3-0,4 x DC	a_p 0,6-1,0 x DC	a_p 0,1-0,2 x DC	a_p 0,3-0,4 x DC	a_p 0,6-1,0 x DC		
f_z (mm)																				
N.1.1	0,270	0,220	0,150	0,290	0,230	0,160	0,310	0,240	0,170	0,330	0,250	0,180	0,340	0,270	0,270	0,350	0,280	0,220	●	●
N.1.2	0,270	0,220	0,150	0,290	0,230	0,160	0,310	0,240	0,170	0,330	0,250	0,180	0,340	0,270	0,270	0,350	0,280	0,220	●	●
N.2.1	0,270	0,220	0,150	0,290	0,230	0,160	0,310	0,240	0,170	0,330	0,250	0,180	0,340	0,270	0,270	0,350	0,280	0,220	●	●
N.2.2	0,270	0,220	0,150	0,290	0,230	0,160	0,310	0,240	0,170	0,330	0,250	0,180	0,340	0,270	0,270	0,350	0,280	0,220	●	●
N.2.3	0,270	0,220	0,150	0,290	0,230	0,160	0,310	0,240	0,170	0,330	0,250	0,180	0,340	0,270	0,270	0,350	0,280	0,220	●	●
N.3.1	0,220	0,170	0,120	0,240	0,180	0,130	0,250	0,200	0,140	0,270	0,210	0,150	0,300	0,240	0,240	0,320	0,260	0,200	●	●
N.3.2	0,220	0,170	0,120	0,240	0,180	0,130	0,250	0,200	0,140	0,270	0,210	0,150	0,300	0,240	0,240	0,320	0,260	0,200	●	●
N.3.3	0,220	0,170	0,120	0,240	0,180	0,130	0,250	0,200	0,140	0,270	0,210	0,150	0,300	0,240	0,240	0,320	0,260	0,200	●	●
N.4.1																				

Index	50 960 ..., 54 590 ..., 54 592 ..., 54 591 ..., 54 593 ..., 54 594 ..., 54 595 ..., 54 596 ..., 54 597 ..., 54 610 ..., 54 611 ..., 54 612 ..., 54 613 ..., 54 620 ..., 54 630 ..., 54 631 ..., 54 640 ...																		Emulsion	MMS
	Ø DC (mm) =																			
	11,7-13,0			13,7-15,0			15,7-16,0			18,0			19,7-20,0			24,7-25,0				
	a_p 0,1-0,2 x DC	a_p 0,3-0,4 x DC	a_p 0,6-1,0 x DC	a_p 0,1-0,2 x DC	a_p 0,3-0,4 x DC	a_p 0,6-1,0 x DC	a_p 0,1-0,2 x DC	a_p 0,3-0,4 x DC	a_p 0,6-1,0 x DC	a_p 0,1-0,2 x DC	a_p 0,3-0,4 x DC	a_p 0,6-1,0 x DC	a_p 0,1-0,2 x DC	a_p 0,3-0,4 x DC	a_p 0,6-1,0 x DC	a_p 0,1-0,2 x DC	a_p 0,3-0,4 x DC	a_p 0,6-1,0 x DC		
f_z (mm)																				
N.1.1	0,220	0,170	0,120	0,240	0,180	0,130	0,250	0,200	0,140	0,270	0,210	0,150	0,300	0,240	0,170	0,320	0,260	0,200	●	●
N.1.2	0,220	0,170	0,120	0,240	0,180	0,130	0,250	0,200	0,140	0,270	0,210	0,150	0,300	0,240	0,170	0,320	0,260	0,200	●	●
N.2.1	0,220	0,170	0,120	0,240	0,180	0,130	0,250	0,200	0,140	0,270	0,210	0,150	0,300	0,240	0,170	0,320	0,260	0,200	●	●
N.2.2	0,220	0,170	0,120	0,240	0,180	0,130	0,250	0,200	0,140	0,270	0,210	0,150	0,300	0,240	0,170	0,320	0,260	0,200	●	●
N.2.3	0,220	0,170	0,120	0,240	0,180	0,130	0,250	0,200	0,140	0,270	0,210	0,150	0,300	0,240	0,170	0,320	0,260	0,200	●	●
N.3.1	0,200	0,160	0,110	0,220	0,170	0,120	0,230	0,180	0,130	0,260	0,200	0,140	0,260	0,210	0,150	0,290	0,230	0,180	●	●
N.3.2	0,200	0,160	0,110	0,220	0,170	0,120	0,230	0,180	0,130	0,260	0,200	0,140	0,260	0,210	0,150	0,290	0,230	0,180	●	●
N.3.3	0,200	0,160	0,110	0,220	0,170	0,120	0,230	0,180	0,130	0,260	0,200	0,140	0,260	0,210	0,150	0,290	0,230	0,180	●	●
N.4.1																				

Index	54 590 ..., 54 592 ..., 54 610 ..., 54 612 ..., 54 630 ..., 54 631 ..., 54 632 ..., 54 633 ..., 54 650 ..., 54 640 ..., 54 642 ...																		Emulsion	MMS
	Ø DC (mm) =																			
	11,7-13,0			13,7-15,0			15,7-16,0			18,0			19,7-20,0			24,7-25,0				
	a_p 0,1-0,2 x DC	a_p 0,3-0,4 x DC	a_p 0,6-1,0 x DC	a_p 0,1-0,2 x DC	a_p 0,3-0,4 x DC	a_p 0,6-1,0 x DC	a_p 0,1-0,2 x DC	a_p 0,3-0,4 x DC	a_p 0,6-1,0 x DC	a_p 0,1-0,2 x DC	a_p 0,3-0,4 x DC	a_p 0,6-1,0 x DC	a_p 0,1-0,2 x DC	a_p 0,3-0,4 x DC	a_p 0,6-1,0 x DC	a_p 0,1-0,2 x DC	a_p 0,3-0,4 x DC	a_p 0,6-1,0 x DC		
f_z (mm)																				
N.1.1	0,080	0,060	0,040	0,090	0,070	0,050	0,100	0,080	0,060	0,110	0,090	0,070	0,130	0,100	0,080	0,160	0,130	0,100	●	●
N.1.2	0,080	0,060	0,040	0,090	0,070	0,050	0,100	0,080	0,060	0,110	0,090	0,070	0,130	0,100	0,080	0,160	0,130	0,100	●	●
N.2.1	0,080	0,060	0,040	0,090	0,070	0,050	0,100	0,080	0,060	0,110	0,090	0,070	0,130	0,100	0,080	0,160	0,130	0,100	●	●
N.2.2	0,080	0,060	0,040	0,090	0,070	0,050	0,100	0,080	0,060	0,110	0,090	0,070	0,130	0,100	0,080	0,160	0,130	0,100	●	●
N.2.3	0,080	0,060	0,040	0,090	0,070	0,050	0,100	0,080	0,060	0,110	0,090	0,070	0,130	0,100	0,080	0,160	0,130	0,100	●	●
N.3.1	0,060	0,050	0,030	0,070	0,060	0,040	0,090	0,070	0,050	0,100	0,080	0,060	0,110	0,090	0,070	0,140	0,120	0,090	●	●
N.3.2	0,060	0,050	0,030	0,070	0,060	0,040	0,090	0,070	0,050	0,100	0,080	0,060	0,110	0,090	0,070	0,140	0,120	0,090	●	●
N.3.3	0,060	0,050	0,030	0,070	0,060	0,040	0,090	0,070	0,050	0,100	0,080	0,060	0,110	0,090	0,070	0,140	0,120	0,090	●	●
N.4.1																				

Cutting data standard values – End mill

Index	Type short / long		54 070 ..., 54 071 ..., 54 072 ...														
	v _c (m/min)	a _{p,max.} x DC	Ø DC (mm) =														
			3			4			5			6			8		
			a _p 0,1-0,2 x DC	a _p 0,3-0,4 x DC	a _p 0,6-1,0 x DC	a _p 0,1-0,2 x DC	a _p 0,3-0,4 x DC	a _p 0,6-1,0 x DC	a _p 0,1-0,2 x DC	a _p 0,3-0,4 x DC	a _p 0,6-1,0 x DC	a _p 0,1-0,2 x DC	a _p 0,3-0,4 x DC	a _p 0,6-1,0 x DC	a _p 0,1-0,2 x DC	a _p 0,3-0,4 x DC	a _p 0,6-1,0 x DC
f _z (mm)																	
P.1.1	210	1,0	0,028	0,022	0,014	0,038	0,030	0,019	0,049	0,039	0,025	0,060	0,048	0,030	0,080	0,064	0,040
P.1.2	200	1,0	0,028	0,022	0,014	0,038	0,030	0,019	0,049	0,039	0,025	0,060	0,048	0,030	0,080	0,064	0,040
P.1.3	200	1,0	0,028	0,022	0,014	0,038	0,030	0,019	0,049	0,039	0,025	0,060	0,048	0,030	0,080	0,064	0,040
P.1.4	190	1,0	0,028	0,022	0,014	0,038	0,030	0,019	0,049	0,039	0,025	0,060	0,048	0,030	0,080	0,064	0,040
P.1.5	190	1,0	0,028	0,022	0,014	0,038	0,030	0,019	0,049	0,039	0,025	0,060	0,048	0,030	0,080	0,064	0,040
P.2.1	200	1,0	0,028	0,022	0,014	0,038	0,030	0,019	0,049	0,039	0,025	0,060	0,048	0,030	0,080	0,064	0,040
P.2.2	190	1,0	0,022	0,018	0,011	0,030	0,024	0,015	0,038	0,030	0,019	0,046	0,037	0,023	0,062	0,050	0,031
P.2.3	180	1,0	0,028	0,022	0,014	0,038	0,030	0,019	0,049	0,039	0,025	0,060	0,048	0,030	0,080	0,064	0,040
P.2.4	170	1,0	0,022	0,018	0,011	0,030	0,024	0,015	0,038	0,030	0,019	0,046	0,037	0,023	0,062	0,050	0,031
P.3.1	180	1,0	0,028	0,022	0,014	0,038	0,030	0,019	0,049	0,039	0,025	0,060	0,048	0,030	0,080	0,064	0,040
P.3.2	170	1,0	0,028	0,022	0,014	0,038	0,030	0,019	0,049	0,039	0,025	0,060	0,048	0,030	0,080	0,064	0,040
P.3.3	140	1,0	0,028	0,022	0,014	0,038	0,030	0,019	0,049	0,039	0,025	0,060	0,048	0,030	0,080	0,064	0,040
P.4.1	100	1,0	0,017	0,014	0,009	0,024	0,019	0,012	0,031	0,025	0,016	0,038	0,030	0,019	0,052	0,042	0,026
P.4.2	80	1,0	0,017	0,014	0,009	0,024	0,019	0,012	0,031	0,025	0,016	0,038	0,030	0,019	0,052	0,042	0,026
M.1.1	100	1,0	0,017	0,014	0,009	0,024	0,019	0,012	0,031	0,025	0,016	0,038	0,030	0,019	0,052	0,042	0,026
M.2.1	100	1,0	0,017	0,014	0,009	0,024	0,019	0,012	0,031	0,025	0,016	0,038	0,030	0,019	0,052	0,042	0,026
M.3.1	100	1,0	0,017	0,014	0,009	0,024	0,019	0,012	0,031	0,025	0,016	0,038	0,030	0,019	0,052	0,042	0,026
K.1.1	200	1,0	0,037	0,030	0,019	0,048	0,038	0,024	0,060	0,048	0,030	0,070	0,056	0,035	0,094	0,075	0,047
K.1.2	180	1,0	0,037	0,030	0,019	0,048	0,038	0,024	0,060	0,048	0,030	0,070	0,056	0,035	0,094	0,075	0,047
K.2.1	190	1,0	0,028	0,022	0,014	0,038	0,030	0,019	0,049	0,039	0,025	0,060	0,048	0,030	0,080	0,064	0,040
K.2.2	170	1,0	0,028	0,022	0,014	0,038	0,030	0,019	0,049	0,039	0,025	0,060	0,048	0,030	0,080	0,064	0,040
K.3.1	180	1,0	0,028	0,022	0,014	0,038	0,030	0,019	0,049	0,039	0,025	0,060	0,048	0,030	0,080	0,064	0,040
K.3.2	160	1,0	0,028	0,022	0,014	0,038	0,030	0,019	0,049	0,039	0,025	0,060	0,048	0,030	0,080	0,064	0,040
N.1.1																	
N.1.2																	
N.2.1																	
N.2.2																	
N.2.3																	
N.3.1	350	1,0	0,037	0,030	0,019	0,048	0,038	0,024	0,060	0,048	0,030	0,070	0,056	0,035	0,094	0,075	0,047
N.3.2	350	1,0	0,037	0,030	0,019	0,048	0,038	0,024	0,060	0,048	0,030	0,070	0,056	0,035	0,094	0,075	0,047
N.3.3	280	1,0	0,037	0,030	0,019	0,048	0,038	0,024	0,060	0,048	0,030	0,070	0,056	0,035	0,094	0,075	0,047
N.4.1																	
S.1.1	30	1,0	0,015	0,012	0,008	0,020	0,016	0,010	0,025	0,020	0,013	0,030	0,024	0,015	0,040	0,032	0,020
S.1.2	30	1,0	0,015	0,012	0,008	0,020	0,016	0,010	0,025	0,020	0,013	0,030	0,024	0,015	0,040	0,032	0,020
S.2.1	30	1,0	0,015	0,012	0,008	0,020	0,016	0,010	0,025	0,020	0,013	0,030	0,024	0,015	0,040	0,032	0,020
S.2.2	30	1,0	0,015	0,012	0,008	0,020	0,016	0,010	0,025	0,020	0,013	0,030	0,024	0,015	0,040	0,032	0,020
S.2.3	30	1,0	0,015	0,012	0,008	0,020	0,016	0,010	0,025	0,020	0,013	0,030	0,024	0,015	0,040	0,032	0,020
S.3.1	90	1,0	0,028	0,022	0,014	0,038	0,030	0,019	0,049	0,039	0,025	0,060	0,048	0,030	0,080	0,064	0,040
S.3.2	50	1,0	0,017	0,014	0,009	0,024	0,019	0,012	0,031	0,025	0,016	0,038	0,030	0,019	0,052	0,042	0,026
S.3.3																	
H.1.1																	
H.1.2																	
H.1.3																	
H.1.4																	
H.2.1																	
H.3.1																	
O.1.1																	
O.1.2																	
O.2.1																	
O.2.2																	
O.3.1																	

 Plunging angle for ramping and helical milling: 3°

Index	54 070 ..., 54 071 ..., 54 072 ...												● 1st choice		
	Ø DC (mm) =												○ suitable		
	10			12			16			20			Emulsion	Compressed air	MMS
	a_p 0,1-0,2 x DC	a_p 0,3-0,4 x DC	a_p 0,6-1,0 x DC	a_p 0,1-0,2 x DC	a_p 0,3-0,4 x DC	a_p 0,6-1,0 x DC	a_p 0,1-0,2 x DC	a_p 0,3-0,4 x DC	a_p 0,6-1,0 x DC	a_p 0,1-0,2 x DC	a_p 0,3-0,4 x DC	a_p 0,6-1,0 x DC			
f_z (mm)															
P.1.1	0,100	0,080	0,050	0,120	0,096	0,060	0,150	0,120	0,075	0,170	0,136	0,085	●	○	○
P.1.2	0,100	0,080	0,050	0,120	0,096	0,060	0,150	0,120	0,075	0,170	0,136	0,085	●	○	○
P.1.3	0,100	0,080	0,050	0,120	0,096	0,060	0,150	0,120	0,075	0,170	0,136	0,085	●	○	○
P.1.4	0,100	0,080	0,050	0,120	0,096	0,060	0,150	0,120	0,075	0,170	0,136	0,085	●	○	○
P.1.5	0,100	0,080	0,050	0,120	0,096	0,060	0,150	0,120	0,075	0,170	0,136	0,085	●	○	○
P.2.1	0,100	0,080	0,050	0,120	0,096	0,060	0,150	0,120	0,075	0,170	0,136	0,085	●	○	○
P.2.2	0,078	0,062	0,039	0,094	0,075	0,047	0,118	0,094	0,059	0,134	0,107	0,067	●	○	○
P.2.3	0,100	0,080	0,050	0,120	0,096	0,060	0,150	0,120	0,075	0,170	0,136	0,085	●	○	○
P.2.4	0,078	0,062	0,039	0,094	0,075	0,047	0,118	0,094	0,059	0,134	0,107	0,067	●	○	○
P.3.1	0,100	0,080	0,050	0,120	0,096	0,060	0,150	0,120	0,075	0,170	0,136	0,085	●	○	○
P.3.2	0,100	0,080	0,050	0,120	0,096	0,060	0,150	0,120	0,075	0,170	0,136	0,085	●	○	○
P.3.3	0,100	0,080	0,050	0,120	0,096	0,060	0,150	0,120	0,075	0,170	0,136	0,085	●	○	○
P.4.1	0,066	0,053	0,033	0,080	0,064	0,040	0,101	0,081	0,051	0,115	0,092	0,058	●		
P.4.2	0,066	0,053	0,033	0,080	0,064	0,040	0,101	0,081	0,051	0,115	0,092	0,058	●		
M.1.1	0,066	0,053	0,033	0,080	0,064	0,040	0,101	0,081	0,051	0,115	0,092	0,058	●		
M.2.1	0,066	0,053	0,033	0,080	0,064	0,040	0,101	0,081	0,051	0,115	0,092	0,058	●		
M.3.1	0,066	0,053	0,033	0,080	0,064	0,040	0,101	0,081	0,051	0,115	0,092	0,058	●		
K.1.1	0,116	0,093	0,058	0,140	0,112	0,070	0,173	0,138	0,087	0,196	0,157	0,098	●	○	○
K.1.2	0,116	0,093	0,058	0,140	0,112	0,070	0,173	0,138	0,087	0,196	0,157	0,098	●	○	○
K.2.1	0,100	0,080	0,050	0,120	0,096	0,060	0,150	0,120	0,075	0,170	0,136	0,085	●	○	○
K.2.2	0,100	0,080	0,050	0,120	0,096	0,060	0,150	0,120	0,075	0,170	0,136	0,085	●	○	○
K.3.1	0,100	0,080	0,050	0,120	0,096	0,060	0,150	0,120	0,075	0,170	0,136	0,085	●	○	○
K.3.2	0,100	0,080	0,050	0,120	0,096	0,060	0,150	0,120	0,075	0,170	0,136	0,085	●	○	○
N.1.1															
N.1.2															
N.2.1															
N.2.2															
N.2.3															
N.3.1	0,116	0,093	0,058	0,140	0,112	0,070	0,173	0,138	0,087	0,196	0,157	0,098	●		
N.3.2	0,116	0,093	0,058	0,140	0,112	0,070	0,173	0,138	0,087	0,196	0,157	0,098	●		
N.3.3	0,116	0,093	0,058	0,140	0,112	0,070	0,173	0,138	0,087	0,196	0,157	0,098	●		
N.4.1															
S.1.1	0,050	0,040	0,025	0,060	0,048	0,030	0,075	0,060	0,038	0,084	0,067	0,042	●		
S.1.2	0,050	0,040	0,025	0,060	0,048	0,030	0,075	0,060	0,038	0,084	0,067	0,042	●		
S.2.1	0,050	0,040	0,025	0,060	0,048	0,030	0,075	0,060	0,038	0,084	0,067	0,042	●		
S.2.2	0,050	0,040	0,025	0,060	0,048	0,030	0,075	0,060	0,038	0,084	0,067	0,042	●		
S.2.3	0,050	0,040	0,025	0,060	0,048	0,030	0,075	0,060	0,038	0,084	0,067	0,042	●		
S.3.1	0,100	0,080	0,050	0,120	0,096	0,060	0,150	0,120	0,075	0,170	0,136	0,085	●		
S.3.2	0,066	0,053	0,033	0,080	0,064	0,040	0,101	0,081	0,051	0,115	0,092	0,058	●		
S.3.3															
H.1.1															
H.1.2															
H.1.3															
H.1.4															
H.2.1															
H.3.1															
O.1.1															
O.1.2															
O.2.1															
O.2.2															
O.3.1															

Cutting data standard values – End mill

Index	Type long		54 078 ...														
	v _c (m/min)	a _{p,max} x DC	Ø DC (mm) =														
			6			8			10			12			16		
			a _e 0,1–0,2 x DC	a _e 0,3–0,4 x DC	a _e 0,6–1,0 x DC	a _e 0,1–0,2 x DC	a _e 0,3–0,4 x DC	a _e 0,6–1,0 x DC	a _e 0,1–0,2 x DC	a _e 0,3–0,4 x DC	a _e 0,6–1,0 x DC	a _e 0,1–0,2 x DC	a _e 0,3–0,4 x DC	a _e 0,6–1,0 x DC	a _e 0,1–0,2 x DC	a _e 0,3–0,4 x DC	a _e 0,6–1,0 x DC
f _z (mm)																	
P.1.1	120	1xDC	0,048	0,038	0,024	0,062	0,050	0,031	0,075	0,060	0,038	0,089	0,071	0,045	0,110	0,088	0,055
P.1.2	110	1xDC	0,041	0,033	0,021	0,054	0,043	0,027	0,066	0,053	0,033	0,079	0,063	0,040	0,099	0,079	0,050
P.1.3	110	1xDC	0,041	0,033	0,021	0,054	0,043	0,027	0,066	0,053	0,033	0,079	0,063	0,040	0,099	0,079	0,050
P.1.4	110	1xDC	0,041	0,033	0,021	0,054	0,043	0,027	0,066	0,053	0,033	0,079	0,063	0,040	0,099	0,079	0,050
P.1.5	110	1xDC	0,041	0,033	0,021	0,054	0,043	0,027	0,066	0,053	0,033	0,079	0,063	0,040	0,099	0,079	0,050
P.2.1	110	1xDC	0,041	0,033	0,021	0,054	0,043	0,027	0,066	0,053	0,033	0,079	0,063	0,040	0,099	0,079	0,050
P.2.2	110	1xDC	0,041	0,033	0,021	0,054	0,043	0,027	0,066	0,053	0,033	0,079	0,063	0,040	0,099	0,079	0,050
P.2.3	110	1xDC	0,041	0,033	0,021	0,054	0,043	0,027	0,066	0,053	0,033	0,079	0,063	0,040	0,099	0,079	0,050
P.2.4	95	1xDC	0,041	0,033	0,021	0,054	0,043	0,027	0,066	0,053	0,033	0,079	0,063	0,040	0,099	0,079	0,050
P.3.1	95	1xDC	0,041	0,033	0,021	0,054	0,043	0,027	0,066	0,053	0,033	0,079	0,063	0,040	0,099	0,079	0,050
P.3.2	95	1xDC	0,041	0,033	0,021	0,054	0,043	0,027	0,066	0,053	0,033	0,079	0,063	0,040	0,099	0,079	0,050
P.3.3																	
P.4.1	70	1xDC	0,041	0,033	0,021	0,054	0,043	0,027	0,066	0,053	0,033	0,079	0,063	0,040	0,099	0,079	0,050
P.4.2	60	1xDC	0,041	0,033	0,021	0,054	0,043	0,027	0,066	0,053	0,033	0,079	0,063	0,040	0,099	0,079	0,050
M.1.1	70	1xDC	0,041	0,033	0,021	0,054	0,043	0,027	0,066	0,053	0,033	0,079	0,063	0,040	0,099	0,079	0,050
M.2.1	70	1xDC	0,041	0,033	0,021	0,054	0,043	0,027	0,066	0,053	0,033	0,079	0,063	0,040	0,099	0,079	0,050
M.3.1	70	1xDC	0,041	0,033	0,021	0,054	0,043	0,027	0,066	0,053	0,033	0,079	0,063	0,040	0,099	0,079	0,050
K.1.1	130	1xDC	0,078	0,062	0,039	0,100	0,080	0,050	0,122	0,098	0,061	0,144	0,115	0,072	0,177	0,142	0,089
K.1.2	120	1xDC	0,078	0,062	0,039	0,100	0,080	0,050	0,122	0,098	0,061	0,144	0,115	0,072	0,177	0,142	0,089
K.2.1	130	1xDC	0,058	0,046	0,029	0,072	0,058	0,036	0,086	0,069	0,043	0,102	0,082	0,051	0,124	0,099	0,062
K.2.2	120	1xDC	0,058	0,046	0,029	0,072	0,058	0,036	0,086	0,069	0,043	0,102	0,082	0,051	0,124	0,099	0,062
K.3.1	130	1xDC	0,078	0,062	0,039	0,100	0,080	0,050	0,122	0,098	0,061	0,144	0,115	0,072	0,177	0,142	0,089
K.3.2	130	1xDC	0,078	0,062	0,039	0,100	0,080	0,050	0,122	0,098	0,061	0,144	0,115	0,072	0,177	0,142	0,089
N.1.1																	
N.1.2																	
N.2.1																	
N.2.2																	
N.2.3																	
N.3.1																	
N.3.2																	
N.3.3																	
N.4.1																	
S.1.1																	
S.1.2																	
S.2.1																	
S.2.2																	
S.2.3																	
S.3.1																	
S.3.2																	
S.3.3																	
H.1.1																	
H.1.2																	
H.1.3																	
H.1.4																	
H.2.1																	
H.3.1																	
O.1.1																	
O.1.2																	
O.2.1																	
O.2.2																	
O.3.1																	

Plunging angle for ramping and helical milling: 3°

At an a_e of < 0.3xDC, an a_p of 3xDC may be used.

Index	54 078 ...			● 1st choice		
	Ø DC (mm) = 20			○ suitable		
	a_p 0,1-0,2 x DC	a_p 0,3-0,4 x DC	a_p 0,6-1,0 x DC	Emulsion	Compressed air	MMS
	f_z (mm)					
P.1.1	0,123	0,098	0,062	●	●	○
P.1.2	0,111	0,089	0,056	●	●	○
P.1.3	0,111	0,089	0,056	●	●	○
P.1.4	0,111	0,089	0,056	●	●	○
P.1.5	0,111	0,089	0,056	●	●	○
P.2.1	0,111	0,089	0,056	●	●	○
P.2.2	0,111	0,089	0,056	●	●	○
P.2.3	0,111	0,089	0,056	●	●	○
P.2.4	0,111	0,089	0,056	●	●	○
P.3.1	0,111	0,089	0,056	●	●	○
P.3.2	0,111	0,089	0,056	●	●	○
P.3.3						
P.4.1	0,111	0,089	0,056	●		
P.4.2	0,111	0,089	0,056	●		
M.1.1	0,111	0,089	0,056	●		
M.2.1	0,111	0,089	0,056	●		
M.3.1	0,111	0,089	0,056	●		
K.1.1	0,200	0,160	0,100		●	●
K.1.2	0,200	0,160	0,100		●	●
K.2.1	0,139	0,111	0,070		●	●
K.2.2	0,139	0,111	0,070		●	●
K.3.1	0,200	0,160	0,100		●	●
K.3.2	0,200	0,160	0,100		●	●
N.1.1						
N.1.2						
N.2.1						
N.2.2						
N.2.3						
N.3.1						
N.3.2						
N.3.3						
N.4.1						
S.1.1						
S.1.2						
S.2.1						
S.2.2						
S.2.3						
S.3.1						
S.3.2						
S.3.3						
H.1.1						
H.1.2						
H.1.3						
H.1.4						
H.2.1						
H.3.1						
O.1.1						
O.1.2						
O.2.1						
O.2.2						
O.3.1						

Cutting data standard values – End mill

Index	Type extra long		54 070 ..., 54 071 ..., 54 072 ...														
	v _c (m/min)	a _{p,max.} x DC	Ø DC (mm) =														
			3			4			5			6			8		
			a _e 0,1–0,2 x DC	a _e 0,3–0,4 x DC	a _e 0,6–1,0 x DC	a _e 0,1–0,2 x DC	a _e 0,3–0,4 x DC	a _e 0,6–1,0 x DC	a _e 0,1–0,2 x DC	a _e 0,3–0,4 x DC	a _e 0,6–1,0 x DC	a _e 0,1–0,2 x DC	a _e 0,3–0,4 x DC	a _e 0,6–1,0 x DC	a _e 0,1–0,2 x DC	a _e 0,3–0,4 x DC	a _e 0,6–1,0 x DC
			f _z (mm)														
P.1.1	120	0,8	0,027	0,022	0,014	0,034	0,027	0,017	0,041	0,033	0,021	0,048	0,038	0,024	0,062	0,050	0,031
P.1.2	110	0,8	0,022	0,018	0,011	0,028	0,022	0,014	0,034	0,027	0,017	0,041	0,033	0,021	0,054	0,043	0,027
P.1.3	110	0,8	0,022	0,018	0,011	0,028	0,022	0,014	0,034	0,027	0,017	0,041	0,033	0,021	0,054	0,043	0,027
P.1.4	110	0,8	0,022	0,018	0,011	0,028	0,022	0,014	0,034	0,027	0,017	0,041	0,033	0,021	0,054	0,043	0,027
P.1.5	110	0,8	0,022	0,018	0,011	0,028	0,022	0,014	0,034	0,027	0,017	0,041	0,033	0,021	0,054	0,043	0,027
P.2.1	110	0,8	0,022	0,018	0,011	0,028	0,022	0,014	0,034	0,027	0,017	0,041	0,033	0,021	0,054	0,043	0,027
P.2.2	110	0,8	0,022	0,018	0,011	0,028	0,022	0,014	0,034	0,027	0,017	0,041	0,033	0,021	0,054	0,043	0,027
P.2.3	110	0,8	0,022	0,018	0,011	0,028	0,022	0,014	0,034	0,027	0,017	0,041	0,033	0,021	0,054	0,043	0,027
P.2.4	95	0,8	0,022	0,018	0,011	0,028	0,022	0,014	0,034	0,027	0,017	0,041	0,033	0,021	0,054	0,043	0,027
P.3.1	95	0,8	0,022	0,018	0,011	0,028	0,022	0,014	0,034	0,027	0,017	0,041	0,033	0,021	0,054	0,043	0,027
P.3.2	95	0,8	0,022	0,018	0,011	0,028	0,022	0,014	0,034	0,027	0,017	0,041	0,033	0,021	0,054	0,043	0,027
P.3.3																	
P.4.1	70	0,8	0,022	0,018	0,011	0,028	0,022	0,014	0,034	0,027	0,017	0,041	0,033	0,021	0,054	0,043	0,027
P.4.2	60	0,8	0,022	0,018	0,011	0,028	0,022	0,014	0,034	0,027	0,017	0,041	0,033	0,021	0,054	0,043	0,027
M.1.1	70	0,8	0,022	0,018	0,011	0,028	0,022	0,014	0,034	0,027	0,017	0,041	0,033	0,021	0,054	0,043	0,027
M.2.1	70	0,8	0,022	0,018	0,011	0,028	0,022	0,014	0,034	0,027	0,017	0,041	0,033	0,021	0,054	0,043	0,027
M.3.1	70	0,8	0,022	0,018	0,011	0,028	0,022	0,014	0,034	0,027	0,017	0,041	0,033	0,021	0,054	0,043	0,027
K.1.1	130	0,8	0,044	0,035	0,022	0,056	0,045	0,028	0,066	0,053	0,033	0,078	0,062	0,039	0,100	0,080	0,050
K.1.2	120	0,8	0,044	0,035	0,022	0,056	0,045	0,028	0,066	0,053	0,033	0,078	0,062	0,039	0,100	0,080	0,050
K.2.1	130	0,8	0,035	0,028	0,018	0,042	0,034	0,021	0,050	0,040	0,025	0,058	0,046	0,029	0,072	0,058	0,036
K.2.2	120	0,8	0,035	0,028	0,018	0,042	0,034	0,021	0,050	0,040	0,025	0,058	0,046	0,029	0,072	0,058	0,036
K.3.1	130	0,8	0,044	0,035	0,022	0,056	0,045	0,028	0,066	0,053	0,033	0,078	0,062	0,039	0,100	0,080	0,050
K.3.2	130	0,8	0,044	0,035	0,022	0,056	0,045	0,028	0,066	0,053	0,033	0,078	0,062	0,039	0,100	0,080	0,050
N.1.1																	
N.1.2																	
N.2.1																	
N.2.2																	
N.2.3																	
N.3.1																	
N.3.2																	
N.3.3																	
N.4.1																	
S.1.1																	
S.1.2																	
S.2.1																	
S.2.2																	
S.2.3																	
S.3.1																	
S.3.2																	
S.3.3																	
H.1.1																	
H.1.2																	
H.1.3																	
H.1.4																	
H.2.1																	
H.3.1																	
O.1.1																	
O.1.2																	
O.2.1																	
O.2.2																	
O.3.1																	

Plunging angle for ramping and helical milling: 3°

Index	54 070 ..., 54 071 ..., 54 072 ...												● 1st choice ○ suitable		
	Ø DC (mm) =												Emulsion	Compressed air	MMS
	10			12			16			20					
	a_p 0,1-0,2 x DC	a_p 0,3-0,4 x DC	a_p 0,6-1,0 x DC	a_p 0,1-0,2 x DC	a_p 0,3-0,4 x DC	a_p 0,6-1,0 x DC	a_p 0,1-0,2 x DC	a_p 0,3-0,4 x DC	a_p 0,6-1,0 x DC	a_p 0,1-0,2 x DC	a_p 0,3-0,4 x DC	a_p 0,6-1,0 x DC			
f_z (mm)															
P.1.1	0,075	0,060	0,038	0,089	0,071	0,045	0,110	0,088	0,055	0,123	0,098	0,062	●	○	○
P.1.2	0,066	0,053	0,033	0,079	0,063	0,040	0,099	0,079	0,050	0,111	0,089	0,056	●	○	○
P.1.3	0,066	0,053	0,033	0,079	0,063	0,040	0,099	0,079	0,050	0,111	0,089	0,056	●	○	○
P.1.4	0,066	0,053	0,033	0,079	0,063	0,040	0,099	0,079	0,050	0,111	0,089	0,056	●	○	○
P.1.5	0,066	0,053	0,033	0,079	0,063	0,040	0,099	0,079	0,050	0,111	0,089	0,056	●	○	○
P.2.1	0,066	0,053	0,033	0,079	0,063	0,040	0,099	0,079	0,050	0,111	0,089	0,056	●	○	○
P.2.2	0,066	0,053	0,033	0,079	0,063	0,040	0,099	0,079	0,050	0,111	0,089	0,056	●	○	○
P.2.3	0,066	0,053	0,033	0,079	0,063	0,040	0,099	0,079	0,050	0,111	0,089	0,056	●	○	○
P.2.4	0,066	0,053	0,033	0,079	0,063	0,040	0,099	0,079	0,050	0,111	0,089	0,056	●	○	○
P.3.1	0,066	0,053	0,033	0,079	0,063	0,040	0,099	0,079	0,050	0,111	0,089	0,056	●	○	○
P.3.2	0,066	0,053	0,033	0,079	0,063	0,040	0,099	0,079	0,050	0,111	0,089	0,056	●	○	○
P.3.3															
P.4.1	0,066	0,053	0,033	0,079	0,063	0,040	0,099	0,079	0,050	0,111	0,089	0,056	●		
P.4.2	0,066	0,053	0,033	0,079	0,063	0,040	0,099	0,079	0,050	0,111	0,089	0,056	●		
M.1.1	0,066	0,053	0,033	0,079	0,063	0,040	0,099	0,079	0,050	0,111	0,089	0,056	●		
M.2.1	0,066	0,053	0,033	0,079	0,063	0,040	0,099	0,079	0,050	0,111	0,089	0,056	●		
M.3.1	0,066	0,053	0,033	0,079	0,063	0,040	0,099	0,079	0,050	0,111	0,089	0,056	●		
K.1.1	0,122	0,098	0,061	0,144	0,115	0,072	0,177	0,142	0,089	0,200	0,160	0,100	●	○	○
K.1.2	0,122	0,098	0,061	0,144	0,115	0,072	0,177	0,142	0,089	0,200	0,160	0,100	●	○	○
K.2.1	0,086	0,069	0,043	0,102	0,082	0,051	0,124	0,099	0,062	0,139	0,111	0,070	●	○	○
K.2.2	0,086	0,069	0,043	0,102	0,082	0,051	0,124	0,099	0,062	0,139	0,111	0,070	●	○	○
K.3.1	0,122	0,098	0,061	0,144	0,115	0,072	0,177	0,142	0,089	0,200	0,160	0,100	●	○	○
K.3.2	0,122	0,098	0,061	0,144	0,115	0,072	0,177	0,142	0,089	0,200	0,160	0,100	●	○	○
N.1.1															
N.1.2															
N.2.1															
N.2.2															
N.2.3															
N.3.1															
N.3.2															
N.3.3															
N.4.1															
S.1.1															
S.1.2															
S.2.1															
S.2.2															
S.2.3															
S.3.1															
S.3.2															
S.3.3															
H.1.1															
H.1.2															
H.1.3															
H.1.4															
H.2.1															
H.3.1															
O.1.1															
O.1.2															
O.2.1															
O.2.2															
O.3.1															

Cutting data standard values – Finish milling cutter

Index	Type long	Type extra long	Type long / extra long	54 075 ..., 54 076 ...						● 1st choice ○ suitable		
				Ø DC (mm) =						Emulsion	Compressed air	MMS
				6	8	10	12	16	20			
				a_p 0,05 x DC								
v_c (m/min)		$a_{p,max}$ x DC	f_z (mm)									
P.1.1	210	145	2,0	0,027	0,036	0,045	0,054	0,068	0,077	●	○	○
P.1.2	200	140	2,0	0,027	0,036	0,045	0,054	0,068	0,077	●	○	○
P.1.3	200	140	2,0	0,027	0,036	0,045	0,054	0,068	0,077	●	○	○
P.1.4	185	130	2,0	0,027	0,036	0,045	0,054	0,068	0,077	●	○	○
P.1.5	185	130	2,0	0,027	0,036	0,045	0,054	0,068	0,077	●	○	○
P.2.1	200	140	2,0	0,027	0,036	0,045	0,054	0,068	0,077	●	○	○
P.2.2	185	130	2,0	0,021	0,028	0,035	0,042	0,053	0,060	●	○	○
P.2.3	175	125	2,0	0,027	0,036	0,045	0,054	0,068	0,077	●	○	○
P.2.4	170	115	2,0	0,021	0,028	0,035	0,042	0,053	0,060	●	○	○
P.3.1	180	125	2,0	0,027	0,036	0,045	0,054	0,068	0,077	●	○	○
P.3.2	170	115	2,0	0,027	0,036	0,045	0,054	0,068	0,077	●	○	○
P.3.3	140	95	2,0	0,027	0,036	0,045	0,054	0,068	0,077	●	○	○
P.4.1	95	65	2,0	0,017	0,023	0,030	0,036	0,045	0,052	●		
P.4.2	80	60	2,0	0,017	0,023	0,030	0,036	0,045	0,052	●		
M.1.1	95	65	2,0	0,017	0,023	0,030	0,036	0,045	0,052	●		
M.2.1	95	65	2,0	0,017	0,023	0,030	0,036	0,045	0,052	●		
M.3.1	95	65	2,0	0,017	0,023	0,030	0,036	0,045	0,052	●		
K.1.1	200	140	2,0	0,032	0,042	0,052	0,063	0,078	0,088	●	○	○
K.1.2	175	125	2,0	0,032	0,042	0,052	0,063	0,078	0,088	●	○	○
K.2.1	185	130	2,0	0,027	0,036	0,045	0,054	0,068	0,077	●	○	○
K.2.2	170	115	2,0	0,027	0,036	0,045	0,054	0,068	0,077	●	○	○
K.3.1	175	125	2,0	0,027	0,036	0,045	0,054	0,068	0,077	●	○	○
K.3.2	160	110	2,0	0,027	0,036	0,045	0,054	0,068	0,077	●	○	○
N.1.1												
N.1.2												
N.2.1												
N.2.2												
N.2.3												
N.3.1	345	240	2,0	0,032	0,042	0,052	0,063	0,078	0,088	●	○	○
N.3.2	345	240	2,0	0,032	0,042	0,052	0,063	0,078	0,088	●	○	○
N.3.3	280	196	2,0	0,032	0,042	0,052	0,063	0,078	0,088	●	○	○
N.4.1												
S.1.1	35	25	2,0	0,014	0,018	0,023	0,027	0,034	0,038	●		
S.1.2	35	25	2,0	0,014	0,018	0,023	0,027	0,034	0,038	●		
S.2.1	35	25	2,0	0,014	0,018	0,023	0,027	0,034	0,038	●		
S.2.2	35	25	2,0	0,014	0,018	0,023	0,027	0,034	0,038	●		
S.2.3	35	25	2,0	0,014	0,018	0,023	0,027	0,034	0,038	●		
S.3.1	160	110	2,0	0,027	0,036	0,045	0,054	0,068	0,077	●		
S.3.2	100	70	2,0	0,017	0,023	0,030	0,036	0,045	0,052	●		
S.3.3												
H.1.1												
H.1.2												
H.1.3												
H.1.4												
H.2.1												
H.3.1												
O.1.1												
O.1.2												
O.2.1												
O.2.2												
O.3.1												

 Plunging angle for ramping and helical milling = 1°

Cutting data standard values – Circular saw blades

Index	54 700 ... / 54 701 ...	
	Circular saws	
	Solid carbide Fine	
	v_c (m/min)	f_z (mm)
P.1.1	80–140	0,002–0,012
P.1.2	50–80	0,001–0,012
P.1.3	50–80	0,001–0,012
P.1.4	50–80	0,001–0,012
P.1.5	50–80	0,001–0,012
P.2.1	50–80	0,001–0,012
P.2.2	50–80	0,001–0,012
P.2.3	50–80	0,001–0,012
P.2.4	50–80	0,001–0,012
P.3.1	50–80	0,001–0,012
P.3.2	50–80	0,001–0,012
P.3.3	50–80	0,001–0,012
P.4.1	80–120	0,001–0,012
P.4.2	50–80	0,001–0,012
M.1.1	50–80	0,001–0,012
M.2.1	50–80	0,001–0,012
M.3.1	50–80	0,001–0,012
K.1.1	80–140	0,002–0,012
K.1.2	50–80	0,001–0,010
K.2.1	50–80	0,001–0,010
K.2.2	50–80	0,001–0,010
K.3.1	50–80	0,001–0,010
K.3.2	50–80	0,001–0,010
N.1.1	200–500	0,003–0,012
N.1.2	200–500	0,003–0,012
N.2.1	200–450	0,003–0,012
N.2.2	200–450	0,003–0,012
N.2.3	200–450	0,003–0,012
N.3.1	200–450	0,003–0,012
N.3.2	200–450	0,003–0,012
N.3.3	200–450	0,003–0,012
N.4.1		
S.1.1	20–30	0,001–0,012
S.1.2	20–30	0,001–0,012
S.2.1	20–30	0,001–0,012
S.2.2	20–30	0,001–0,012
S.2.3	20–30	0,001–0,012
S.3.1	30–70	0,001–0,012
S.3.2	30–70	0,001–0,012
S.3.3	30–70	0,001–0,012
H.1.1		
H.1.2		
H.1.3		
H.1.4		
H.2.1		
H.3.1		
O.1.1	130–200	0,003–0,015
O.1.2	130–200	0,003–0,015
O.2.1		
O.2.2		
O.3.1		



The cutting data depends extremely on the external conditions, e.g. stability of the tool and tool clamping, material and machine type. The indicated values are possible cutting data which have to be increased or reduced according to the application conditions.

Cutting data standard values – NTR roughing-finishing milling cutter

Index			ap, max in mm	52 318 ...														
	as 0,1-0,4 x DC	as 0,6-1,0 x DC		Ø DC (mm) =														
				6			8			10			12			14		
				as 0,1-0,2 x DC	as 0,3-0,4 x DC	as 0,6-1,0 x DC	as 0,1-0,2 x DC	as 0,3-0,4 x DC	as 0,6-1,0 x DC	as 0,1-0,2 x DC	as 0,3-0,4 x DC	as 0,6-1,0 x DC	as 0,1-0,2 x DC	as 0,3-0,4 x DC	as 0,6-1,0 x DC	as 0,1-0,2 x DC	as 0,3-0,4 x DC	as 0,6-1,0 x DC
vc (m/min)		fz (mm)																
P.1.1	250	140	1xDC	0,074	0,047	0,028	0,095	0,060	0,035	0,114	0,072	0,042	0,131	0,083	0,049	0,145	0,092	0,055
P.1.2	250	140	1xDC	0,074	0,047	0,028	0,095	0,060	0,035	0,114	0,072	0,042	0,131	0,083	0,049	0,145	0,092	0,055
P.1.3	205	115	1xDC	0,069	0,044	0,026	0,089	0,056	0,033	0,106	0,067	0,040	0,122	0,077	0,046	0,135	0,086	0,051
P.1.4	205	115	1xDC	0,069	0,044	0,026	0,089	0,056	0,033	0,106	0,067	0,040	0,122	0,077	0,046	0,135	0,086	0,051
P.1.5	205	115	1xDC	0,069	0,044	0,026	0,089	0,056	0,033	0,106	0,067	0,040	0,122	0,077	0,046	0,135	0,086	0,051
P.2.1	225	125	1xDC	0,074	0,047	0,028	0,095	0,060	0,035	0,114	0,072	0,042	0,131	0,083	0,049	0,145	0,092	0,055
P.2.2	225	125	1xDC	0,074	0,047	0,028	0,095	0,060	0,035	0,114	0,072	0,042	0,131	0,083	0,049	0,145	0,092	0,055
P.2.3	135	75	1xDC	0,068	0,043	0,025	0,087	0,055	0,033	0,104	0,066	0,039	0,120	0,076	0,045	0,133	0,085	0,055
P.2.4	135	75	1xDC	0,068	0,043	0,025	0,087	0,055	0,033	0,104	0,066	0,039	0,120	0,076	0,045	0,133	0,085	0,050
P.3.1	145	85	1xDC	0,072	0,045	0,027	0,092	0,058	0,034	0,110	0,070	0,041	0,127	0,080	0,047	0,141	0,089	0,053
P.3.2	125	70	1xDC	0,064	0,041	0,024	0,082	0,052	0,031	0,099	0,062	0,037	0,113	0,072	0,042	0,126	0,080	0,047
P.3.3	125	70	1xDC	0,064	0,041	0,024	0,082	0,052	0,031	0,099	0,062	0,037	0,113	0,072	0,042	0,126	0,080	0,047
P.4.1	100	55	1xDC	0,050	0,031	0,018	0,063	0,040	0,024	0,076	0,048	0,028	0,087	0,055	0,033	0,097	0,061	0,037
P.4.2	100	55	1xDC	0,050	0,031	0,018	0,063	0,040	0,024	0,076	0,048	0,028	0,087	0,055	0,033	0,097	0,061	0,037
M.1.1	75	40	1xDC	0,043	0,027	0,016	0,055	0,035	0,021	0,066	0,042	0,025	0,076	0,048	0,028	0,084	0,054	0,032
M.2.1	85	40	1xDC	0,047	0,030	0,018	0,060	0,038	0,022	0,072	0,046	0,027	0,083	0,052	0,031	0,092	0,058	0,035
M.3.1	70	35	1xDC	0,036	0,023	0,013	0,046	0,029	0,017	0,055	0,035	0,021	0,063	0,040	0,024	0,070	0,045	0,027
K.1.1	310	150	1xDC	0,124	0,078	0,046	0,158	0,100	0,059	0,190	0,120	0,071	0,218	0,138	0,081	0,242	0,154	0,090
K.1.2	260	100	1xDC	0,100	0,060	0,026	0,138	0,080	0,039	0,160	0,100	0,051	0,188	0,120	0,061	0,212	0,135	0,070
K.2.1	285	140	1xDC	0,105	0,067	0,039	0,135	0,085	0,050	0,161	0,102	0,060	0,185	0,117	0,069	0,205	0,130	0,077
K.2.2	130	65	1xDC	0,050	0,031	0,018	0,063	0,040	0,024	0,076	0,048	0,028	0,087	0,055	0,033	0,097	0,061	0,037
K.3.1	205	100	1xDC	0,087	0,055	0,032	0,111	0,070	0,041	0,133	0,084	0,050	0,153	0,097	0,057	0,170	0,108	0,064
K.3.2	195	95	1xDC	0,074	0,047	0,028	0,095	0,060	0,035	0,114	0,072	0,042	0,131	0,083	0,049	0,145	0,092	0,055
N.1.1	825	535	1xDC	0,092	0,066	0,047	0,117	0,084	0,060	0,140	0,101	0,072	0,161	0,116	0,083	0,179	0,129	0,092
N.1.2	825	535	1xDC	0,092	0,066	0,047	0,117	0,084	0,060	0,140	0,101	0,072	0,161	0,116	0,083	0,179	0,129	0,092
N.2.1	550	355	1xDC	0,096	0,069	0,049	0,123	0,088	0,063	0,147	0,106	0,076	0,169	0,122	0,087	0,188	0,136	0,097
N.2.2	440	285	1xDC	0,101	0,073	0,052	0,129	0,093	0,066	0,154	0,111	0,079	0,178	0,128	0,091	0,198	0,142	0,101
N.2.3	315	205	1xDC	0,110	0,079	0,057	0,141	0,101	0,072	0,168	0,121	0,087	0,194	0,139	0,099	0,216	0,155	0,110
N.3.1	395	255	1xDC	0,046	0,033	0,024	0,059	0,042	0,030	0,070	0,050	0,036	0,081	0,058	0,041	0,090	0,065	0,046
N.3.2	315	205	1xDC	0,073	0,053	0,038	0,094	0,067	0,048	0,112	0,081	0,058	0,129	0,093	0,066	0,144	0,103	0,074
N.3.3	235	155	1xDC	0,073	0,053	0,038	0,094	0,067	0,048	0,112	0,081	0,058	0,129	0,093	0,066	0,144	0,103	0,074
N.4.1																		
S.1.1																		
S.1.2																		
S.2.1																		
S.2.2																		
S.2.3																		
S.3.1																		
S.3.2																		
S.3.3																		
H.1.1																		
H.1.2																		
H.1.3																		
H.1.4																		
H.2.1																		
H.3.1																		
O.1.1																		
O.1.2																		
O.2.1																		
O.2.2																		
O.3.1																		













Index	52 318 ...									● 1st choice ○ suitable		
	Ø DC (mm) =									Emulsion	Compressed air	MMS
	16			18			20					
	a_p 0,1-0,2 x DC	a_p 0,3-0,4 x DC	a_p 0,6-1,0 x DC	a_p 0,1-0,2 x DC	a_p 0,3-0,4 x DC	a_p 0,6-1,0 x DC	a_p 0,1-0,2 x DC	a_p 0,3-0,4 x DC	a_p 0,6-1,0 x DC			
f_z (mm)												
P.1.1	0,160	0,101	0,060	0,171	0,109	0,064	0,183	0,116	0,068	●	○	○
P.1.2	0,160	0,101	0,060	0,171	0,109	0,064	0,183	0,116	0,068	●	○	○
P.1.3	0,149	0,094	0,056	0,160	0,101	0,060	0,171	0,108	0,064	●	○	○
P.1.4	0,149	0,094	0,056	0,160	0,101	0,060	0,171	0,108	0,064	●	○	○
P.1.5	0,149	0,094	0,056	0,160	0,101	0,060	0,171	0,108	0,064	●	○	○
P.2.1	0,160	0,101	0,060	0,171	0,109	0,064	0,183	0,116	0,068	●	○	○
P.2.2	0,160	0,101	0,060	0,171	0,109	0,064	0,183	0,116	0,068	●	○	○
P.2.3	0,147	0,093	0,055	0,157	0,100	0,059	0,168	0,106	0,062	●	○	○
P.2.4	0,147	0,093	0,055	0,157	0,100	0,059	0,168	0,106	0,062	●	○	○
P.3.1	0,155	0,098	0,058	0,166	0,105	0,062	0,177	0,112	0,066	●	○	○
P.3.2	0,139	0,088	0,052	0,148	0,094	0,056	0,158	0,100	0,059	●	○	○
P.3.3	0,139	0,088	0,052	0,148	0,094	0,056	0,158	0,100	0,059	●	○	○
P.4.1	0,107	0,067	0,040	0,114	0,072	0,043	0,122	0,077	0,045	●	○	○
P.4.2	0,107	0,067	0,040	0,114	0,072	0,043	0,122	0,077	0,045	●	○	○
M.1.1	0,093	0,059	0,035	0,100	0,063	0,038	0,107	0,067	0,040	●	○	○
M.2.1	0,101	0,064	0,038	0,108	0,069	0,041	0,116	0,073	0,043	●	○	○
M.3.1	0,077	0,049	0,029	0,082	0,053	0,031	0,088	0,056	0,033	●	○	○
K.1.1	0,266	0,169	0,099	0,286	0,181	0,107	0,305	0,193	0,114	●	○	○
K.1.2	0,236	0,149	0,079	0,256	0,161	0,087	0,275	0,173	0,094	●	○	○
K.2.1	0,226	0,143	0,084	0,243	0,154	0,091	0,259	0,164	0,097	●	○	○
K.2.2	0,107	0,067	0,040	0,115	0,072	0,043	0,122	0,077	0,045	●	○	○
K.3.1	0,187	0,118	0,070	0,200	0,127	0,075	0,213	0,135	0,080	●	○	○
K.3.2	0,160	0,101	0,060	0,172	0,109	0,064	0,183	0,116	0,068	●	○	○
N.1.1	0,197	0,142	0,101	0,211	0,152	0,109	0,225	0,162	0,116	●	○	○
N.1.2	0,197	0,142	0,101	0,211	0,152	0,109	0,225	0,162	0,116	●	○	○
N.2.1	0,207	0,149	0,106	0,222	0,160	0,114	0,237	0,170	0,122	●	○	○
N.2.2	0,217	0,156	0,111	0,233	0,167	0,119	0,248	0,178	0,127	●	○	○
N.2.3	0,237	0,170	0,121	0,254	0,182	0,130	0,270	0,194	0,139	●	○	○
N.3.1	0,099	0,071	0,051	0,106	0,076	0,055	0,113	0,081	0,058	●	○	○
N.3.2	0,158	0,113	0,081	0,169	0,122	0,087	0,180	0,130	0,093	●	○	○
N.3.3	0,158	0,113	0,081	0,169	0,122	0,087	0,180	0,130	0,093	●	○	○
N.4.1												
S.1.1												
S.1.2												
S.2.1												
S.2.2												
S.2.3												
S.3.1												
S.3.2												
S.3.3												
H.1.1												
H.1.2												
H.1.3												
H.1.4												
H.2.1												
H.3.1												
O.1.1												
O.1.2												
O.2.1												
O.2.2												
O.3.1												

Cutting data standard values – Rough milling cutter

Index	Type long		54 077 ...														
	v_c (m/min)	$a_{p,max.} \times DC$	$\varnothing DC$ (mm) =														
			4			5			6			8			10		
			a_p 0,1–0,2 x DC	a_p 0,3–0,4 x DC	a_p 0,6–1,0 x DC	a_p 0,1–0,2 x DC	a_p 0,3–0,4 x DC	a_p 0,6–1,0 x DC	a_p 0,1–0,2 x DC	a_p 0,3–0,4 x DC	a_p 0,6–1,0 x DC	a_p 0,1–0,2 x DC	a_p 0,3–0,4 x DC	a_p 0,6–1,0 x DC	a_p 0,1–0,2 x DC	a_p 0,3–0,4 x DC	a_p 0,6–1,0 x DC
			f_z (mm)														
P.1.1	185	1,0	0,043	0,035	0,022	0,054	0,043	0,027	0,063	0,050	0,032	0,085	0,068	0,042	0,104	0,084	0,052
P.1.2	175	1,0	0,043	0,035	0,022	0,054	0,043	0,027	0,063	0,050	0,032	0,085	0,068	0,042	0,104	0,084	0,052
P.1.3	175	1,0	0,043	0,035	0,022	0,054	0,043	0,027	0,063	0,050	0,032	0,085	0,068	0,042	0,104	0,084	0,052
P.1.4	170	1,0	0,043	0,035	0,022	0,054	0,043	0,027	0,063	0,050	0,032	0,085	0,068	0,042	0,104	0,084	0,052
P.1.5	170	1,0	0,043	0,035	0,022	0,054	0,043	0,027	0,063	0,050	0,032	0,085	0,068	0,042	0,104	0,084	0,052
P.2.1	175	1,0	0,043	0,035	0,022	0,054	0,043	0,027	0,063	0,050	0,032	0,085	0,068	0,042	0,104	0,084	0,052
P.2.2	170	1,0	0,034	0,027	0,017	0,044	0,035	0,022	0,054	0,043	0,027	0,072	0,058	0,036	0,090	0,072	0,045
P.2.3	160	1,0	0,043	0,035	0,022	0,054	0,043	0,027	0,063	0,050	0,032	0,085	0,068	0,042	0,104	0,084	0,052
P.2.4	150	1,0	0,034	0,027	0,017	0,044	0,035	0,022	0,054	0,043	0,027	0,072	0,058	0,036	0,090	0,072	0,045
P.3.1	160	1,0	0,043	0,035	0,022	0,054	0,043	0,027	0,063	0,050	0,032	0,085	0,068	0,042	0,104	0,084	0,052
P.3.2	150	1,0	0,043	0,035	0,022	0,054	0,043	0,027	0,063	0,050	0,032	0,085	0,068	0,042	0,104	0,084	0,052
P.3.3	130	1,0	0,043	0,035	0,022	0,054	0,043	0,027	0,063	0,050	0,032	0,085	0,068	0,042	0,104	0,084	0,052
P.4.1	90	1,0	0,022	0,017	0,011	0,028	0,022	0,014	0,034	0,027	0,017	0,047	0,037	0,023	0,059	0,048	0,030
P.4.2	70	1,0	0,022	0,017	0,011	0,028	0,022	0,014	0,034	0,027	0,017	0,047	0,037	0,023	0,059	0,048	0,030
M.1.1	90	1,0	0,022	0,017	0,011	0,028	0,022	0,014	0,034	0,027	0,017	0,047	0,037	0,023	0,059	0,048	0,030
M.2.1	90	1,0	0,022	0,017	0,011	0,028	0,022	0,014	0,034	0,027	0,017	0,047	0,037	0,023	0,059	0,048	0,030
M.3.1	90	1,0	0,022	0,017	0,011	0,028	0,022	0,014	0,034	0,027	0,017	0,047	0,037	0,023	0,059	0,048	0,030
K.1.1	175	1,0	0,056	0,045	0,028	0,070	0,056	0,035	0,085	0,068	0,042	0,113	0,091	0,057	0,144	0,115	0,072
K.1.2	160	1,0	0,056	0,045	0,028	0,070	0,056	0,035	0,085	0,068	0,042	0,113	0,091	0,057	0,144	0,115	0,072
K.2.1	170	1,0	0,043	0,035	0,022	0,054	0,043	0,027	0,063	0,050	0,032	0,085	0,068	0,042	0,104	0,084	0,052
K.2.2	155	1,0	0,043	0,035	0,022	0,054	0,043	0,027	0,063	0,050	0,032	0,085	0,068	0,042	0,104	0,084	0,052
K.3.1	160	1,0	0,043	0,035	0,022	0,054	0,043	0,027	0,063	0,050	0,032	0,085	0,068	0,042	0,104	0,084	0,052
K.3.2	145	1,0	0,043	0,035	0,022	0,054	0,043	0,027	0,063	0,050	0,032	0,085	0,068	0,042	0,104	0,084	0,052
N.1.1																	
N.1.2																	
N.2.1																	
N.2.2																	
N.2.3																	
N.3.1	280	1,0	0,056	0,045	0,028	0,070	0,056	0,035	0,085	0,068	0,042	0,113	0,091	0,057	0,144	0,115	0,072
N.3.2	280	1,0	0,056	0,045	0,028	0,070	0,056	0,035	0,085	0,068	0,042	0,113	0,091	0,057	0,144	0,115	0,072
N.3.3	225	1,0	0,056	0,045	0,028	0,070	0,056	0,035	0,085	0,068	0,042	0,113	0,091	0,057	0,144	0,115	0,072
N.4.1																	
S.1.1	25	1,0	0,018	0,014	0,009	0,023	0,018	0,011	0,027	0,022	0,014	0,036	0,029	0,018	0,045	0,036	0,023
S.1.2	25	1,0	0,018	0,014	0,009	0,023	0,018	0,011	0,027	0,022	0,014	0,036	0,029	0,018	0,045	0,036	0,023
S.2.1	25	1,0	0,018	0,014	0,009	0,023	0,018	0,011	0,027	0,022	0,014	0,036	0,029	0,018	0,045	0,036	0,023
S.2.2	25	1,0	0,018	0,014	0,009	0,023	0,018	0,011	0,027	0,022	0,014	0,036	0,029	0,018	0,045	0,036	0,023
S.2.3	25	1,0	0,018	0,014	0,009	0,023	0,018	0,011	0,027	0,022	0,014	0,036	0,029	0,018	0,045	0,036	0,023
S.3.1	70	1,0	0,034	0,027	0,017	0,044	0,035	0,022	0,054	0,043	0,027	0,072	0,058	0,036	0,090	0,072	0,045
S.3.2	40	1,0	0,022	0,017	0,011	0,028	0,022	0,014	0,034	0,027	0,017	0,047	0,037	0,023	0,059	0,048	0,030
S.3.3																	
H.1.1																	
H.1.2																	
H.1.3																	
H.1.4																	
H.2.1																	
H.3.1																	
O.1.1																	
O.1.2																	
O.2.1																	
O.2.2																	
O.3.1																	

Index	54 077 ...									● 1st choice ○ suitable		
	Ø DC (mm) =									Emulsion	Compressed air	MMS
	12			16			20					
	a_p 0,1-0,2 x DC	a_p 0,3-0,4 x DC	a_p 0,6-1,0 x DC	a_p 0,1-0,2 x DC	a_p 0,3-0,4 x DC	a_p 0,6-1,0 x DC	a_p 0,1-0,2 x DC	a_p 0,3-0,4 x DC	a_p 0,6-1,0 x DC			
f_z (mm)												
P.1.1	0,126	0,101	0,063	0,156	0,125	0,078	0,176	0,141	0,088	●	○	○
P.1.2	0,126	0,101	0,063	0,156	0,125	0,078	0,176	0,141	0,088	●	○	○
P.1.3	0,126	0,101	0,063	0,156	0,125	0,078	0,176	0,141	0,088	●	○	○
P.1.4	0,126	0,101	0,063	0,156	0,125	0,078	0,176	0,141	0,088	●	○	○
P.1.5	0,126	0,101	0,063	0,156	0,125	0,078	0,176	0,141	0,088	●	○	○
P.2.1	0,126	0,101	0,063	0,156	0,125	0,078	0,176	0,141	0,088	●	○	○
P.2.2	0,108	0,086	0,054	0,135	0,108	0,068	0,153	0,122	0,077	●	○	○
P.2.3	0,126	0,101	0,063	0,156	0,125	0,078	0,176	0,141	0,088	●	○	○
P.2.4	0,108	0,086	0,054	0,135	0,108	0,068	0,153	0,122	0,077	●	○	○
P.3.1	0,126	0,101	0,063	0,156	0,125	0,078	0,176	0,141	0,088	●	○	○
P.3.2	0,126	0,101	0,063	0,156	0,125	0,078	0,176	0,141	0,088	●	○	○
P.3.3	0,126	0,101	0,063	0,156	0,125	0,078	0,176	0,141	0,088	●	○	○
P.4.1	0,072	0,058	0,036	0,091	0,073	0,045	0,104	0,083	0,052	●		
P.4.2	0,072	0,058	0,036	0,091	0,073	0,045	0,104	0,083	0,052	●		
M.1.1	0,072	0,058	0,036	0,091	0,073	0,045	0,104	0,083	0,052	●		
M.2.1	0,072	0,058	0,036	0,091	0,073	0,045	0,104	0,083	0,052	●		
M.3.1	0,072	0,058	0,036	0,091	0,073	0,045	0,104	0,083	0,052	●		
K.1.1	0,173	0,138	0,086	0,216	0,173	0,108	0,247	0,197	0,123	●	○	○
K.1.2	0,173	0,138	0,086	0,216	0,173	0,108	0,247	0,197	0,123	●	○	○
K.2.1	0,126	0,101	0,063	0,156	0,125	0,078	0,176	0,141	0,088	●	○	○
K.2.2	0,126	0,101	0,063	0,156	0,125	0,078	0,176	0,141	0,088	●	○	○
K.3.1	0,126	0,101	0,063	0,156	0,125	0,078	0,176	0,141	0,088	●	○	○
K.3.2	0,126	0,101	0,063	0,156	0,125	0,078	0,176	0,141	0,088	●	○	○
N.1.1												
N.1.2												
N.2.1												
N.2.2												
N.2.3												
N.3.1	0,173	0,138	0,086	0,216	0,173	0,108	0,247	0,197	0,123	●		
N.3.2	0,173	0,138	0,086	0,216	0,173	0,108	0,247	0,197	0,123	●		
N.3.3	0,173	0,138	0,086	0,216	0,173	0,108	0,247	0,197	0,123	●		
N.4.1												
S.1.1	0,054	0,043	0,027	0,068	0,054	0,034	0,076	0,060	0,038	●		
S.1.2	0,054	0,043	0,027	0,068	0,054	0,034	0,076	0,060	0,038	●		
S.2.1	0,054	0,043	0,027	0,068	0,054	0,034	0,076	0,060	0,038	●		
S.2.2	0,054	0,043	0,027	0,068	0,054	0,034	0,076	0,060	0,038	●		
S.2.3	0,054	0,043	0,027	0,068	0,054	0,034	0,076	0,060	0,038	●		
S.3.1	0,108	0,086	0,054	0,135	0,108	0,068	0,153	0,122	0,077	●		
S.3.2	0,072	0,058	0,036	0,091	0,073	0,045	0,104	0,083	0,052	●		
S.3.3												
H.1.1												
H.1.2												
H.1.3												
H.1.4												
H.2.1												
H.3.1												
O.1.1												
O.1.2												
O.2.1												
O.2.2												
O.3.1												

Cutting data standard values – Rough milling cutter

Index	  Full slot milling Contour milling v_c (m/min)		52 338 ..., 52 339 ..., 52 341 ..., 52 342 ..., 52 343 ...									
			Ti1000									
			Ø DC (mm) =									
			6	8		10		12		14		
		f_z (mm)										
												
P.1.1	170	190	0,028	0,03	0,04	0,05	0,05	0,06	0,06	0,07	0,07	0,08
P.1.2	160	180	0,028	0,03	0,04	0,05	0,05	0,06	0,06	0,07	0,07	0,08
P.1.3	150	170	0,028	0,03	0,04	0,05	0,05	0,06	0,06	0,07	0,07	0,08
P.1.4	150	170	0,028	0,03	0,04	0,05	0,05	0,06	0,06	0,07	0,07	0,08
P.1.5	130	150	0,028	0,03	0,04	0,05	0,05	0,06	0,06	0,07	0,07	0,08
P.2.1	110	130	0,028	0,03	0,04	0,05	0,05	0,06	0,06	0,07	0,07	0,08
P.2.2	110	130	0,028	0,03	0,04	0,05	0,05	0,06	0,06	0,07	0,07	0,08
P.2.3	110	130	0,028	0,03	0,04	0,05	0,05	0,06	0,06	0,07	0,07	0,08
P.2.4	110	130	0,028	0,03	0,04	0,05	0,05	0,06	0,06	0,07	0,07	0,08
P.3.1	160	180	0,028	0,03	0,04	0,05	0,05	0,06	0,06	0,07	0,07	0,08
P.3.2	90	110	0,028	0,03	0,04	0,05	0,05	0,06	0,06	0,07	0,07	0,08
P.3.3	90	110	0,028	0,03	0,04	0,05	0,05	0,06	0,06	0,07	0,07	0,08
P.4.1	55	65	0,02	0,03	0,03	0,04	0,04	0,05	0,05	0,06	0,06	0,07
P.4.2	35	45	0,02	0,03	0,03	0,04	0,04	0,05	0,05	0,06	0,06	0,07
M.1.1	60	70	0,02	0,03	0,03	0,04	0,04	0,05	0,05	0,06	0,06	0,07
M.2.1	45	55	0,02	0,03	0,03	0,04	0,04	0,05	0,05	0,06	0,06	0,07
M.3.1	50	60	0,02	0,03	0,03	0,04	0,04	0,05	0,05	0,06	0,06	0,07
K.1.1	120	130	0,028	0,03	0,04	0,05	0,05	0,06	0,06	0,07	0,07	0,08
K.1.2	110	120	0,028	0,03	0,04	0,05	0,05	0,06	0,06	0,07	0,07	0,08
K.2.1	110	120	0,028	0,03	0,04	0,05	0,05	0,06	0,06	0,07	0,07	0,08
K.2.2	90	100	0,028	0,03	0,04	0,05	0,05	0,06	0,06	0,07	0,07	0,08
K.3.1	110	120	0,028	0,03	0,04	0,05	0,05	0,06	0,06	0,07	0,07	0,08
K.3.2	100	110	0,028	0,03	0,04	0,05	0,05	0,06	0,06	0,07	0,07	0,08
N.1.1												
N.1.2												
N.2.1												
N.2.2												
N.2.3												
N.3.1												
N.3.2												
N.3.3												
N.4.1												
S.1.1												
S.1.2												
S.2.1												
S.2.2												
S.2.3												
S.3.1												
S.3.2												
S.3.3												
H.1.1												
H.1.2												
H.1.3												
H.1.4												
H.2.1												
H.3.1												
O.1.1												
O.1.2												
O.2.1												
O.2.2												
O.3.1												

 For Full slot milling the values indicated in the table are based on:
 $a_e = 1,0 \times DC / a_p = 1,0 \times DC$

 For Contour milling the values indicated in the table are based on:
 $a_e = 0,4 \times DC / a_p = 1,0 \times DC$

Index	52 338 ..., 52 339 ..., 52 340 ..., 52 341 ..., 52 342 ..., 52 343 ...								● 1st choice ○ suitable		
	Ti1000								Emulsion	Compressed air	MMS
	Ø DC (mm) =										
	16		18		20		25				
f _z (mm)											
P.1.1	0,08	0,09	0,09	0,1	0,1	0,12	0,1	0,12	●	○	
P.1.2	0,08	0,09	0,09	0,1	0,1	0,12	0,1	0,12	●	○	
P.1.3	0,08	0,09	0,09	0,1	0,1	0,12	0,1	0,12	●	○	
P.1.4	0,08	0,09	0,09	0,1	0,1	0,12	0,1	0,12	●	○	
P.1.5	0,08	0,09	0,09	0,1	0,1	0,12	0,1	0,12	●	○	
P.2.1	0,08	0,09	0,09	0,1	0,1	0,12	0,1	0,12	●	○	
P.2.2	0,08	0,09	0,09	0,1	0,1	0,12	0,1	0,12	●	○	
P.2.3	0,08	0,09	0,09	0,1	0,1	0,12	0,1	0,12	●	○	
P.2.4	0,08	0,09	0,09	0,1	0,1	0,12	0,1	0,12	●	○	
P.3.1	0,08	0,09	0,09	0,1	0,1	0,12	0,1	0,12	●	○	
P.3.2	0,08	0,09	0,09	0,1	0,1	0,12	0,1	0,12	●	○	
P.3.3	0,08	0,09	0,09	0,1	0,1	0,12	0,1	0,12	●	○	
P.4.1	0,06	0,08	0,07	0,09	0,08	0,1	0,08	0,1	●		
P.4.2	0,06	0,08	0,07	0,09	0,08	0,1	0,08	0,1	●		
M.1.1	0,06	0,08	0,07	0,09	0,08	0,1	0,08	0,1	●		
M.2.1	0,06	0,08	0,07	0,09	0,08	0,1	0,08	0,1	●		
M.3.1	0,06	0,08	0,07	0,09	0,08	0,1	0,08	0,1	●		
K.1.1	0,08	0,09	0,09	0,1	0,1	0,12	0,1	0,12	●	○	
K.1.2	0,08	0,09	0,09	0,1	0,1	0,12	0,1	0,12	●	○	
K.2.1	0,08	0,09	0,09	0,1	0,1	0,12	0,1	0,12	●	○	
K.2.2	0,08	0,09	0,09	0,1	0,1	0,12	0,1	0,12	●	○	
K.3.1	0,08	0,09	0,09	0,1	0,1	0,12	0,1	0,12	●	○	
K.3.2	0,08	0,09	0,09	0,1	0,1	0,12	0,1	0,12	●	○	
N.1.1											
N.1.2											
N.2.1											
N.2.2											
N.2.3											
N.3.1											
N.3.2											
N.3.3											
N.4.1											
S.1.1											
S.1.2											
S.2.1											
S.2.2											
S.2.3											
S.3.1											
S.3.2											
S.3.3											
H.1.1											
H.1.2											
H.1.3											
H.1.4											
H.2.1											
H.3.1											
O.1.1											
O.1.2											
O.2.1											
O.2.2											
O.3.1											

With tools with internal cooling (52 338.../52 339...) the cutting speed (v_c) can be increased by 20–30 %!

Cutting data standard values – Ball-nosed end mill

Index	Type short		54 073 ...														
	v _c (m/min)	a _{p,max.} x DC	Ø DC (mm) =														
			3			4			5			6			8		
			a _e 0,01–0,02 x DC	a _e 0,03–0,04 x DC	a _e 0,05 x DC	a _e 0,01–0,02 x DC	a _e 0,03–0,04 x DC	a _e 0,05 x DC	a _e 0,01–0,02 x DC	a _e 0,03–0,04 x DC	a _e 0,05 x DC	a _e 0,01–0,02 x DC	a _e 0,03–0,04 x DC	a _e 0,05 x DC	a _e 0,01–0,02 x DC	a _e 0,03–0,04 x DC	a _e 0,05 x DC
			f _z (mm)														
P.1.1	180	0,08	0,022	0,018	0,011	0,028	0,022	0,014	0,034	0,027	0,017	0,041	0,033	0,021	0,054	0,043	0,027
P.1.2	160	0,08	0,022	0,018	0,011	0,028	0,022	0,014	0,034	0,027	0,017	0,041	0,033	0,021	0,054	0,043	0,027
P.1.3	160	0,08	0,022	0,018	0,011	0,028	0,022	0,014	0,034	0,027	0,017	0,041	0,033	0,021	0,054	0,043	0,027
P.1.4	150	0,08	0,022	0,018	0,011	0,028	0,022	0,014	0,034	0,027	0,017	0,041	0,033	0,021	0,054	0,043	0,027
P.1.5	150	0,08	0,022	0,018	0,011	0,028	0,022	0,014	0,034	0,027	0,017	0,041	0,033	0,021	0,054	0,043	0,027
P.2.1	170	0,08	0,022	0,018	0,011	0,028	0,022	0,014	0,034	0,027	0,017	0,041	0,033	0,021	0,054	0,043	0,027
P.2.2	140	0,08	0,022	0,018	0,011	0,028	0,022	0,014	0,034	0,027	0,017	0,041	0,033	0,021	0,054	0,043	0,027
P.2.3	140	0,08	0,022	0,018	0,011	0,028	0,022	0,014	0,034	0,027	0,017	0,041	0,033	0,021	0,054	0,043	0,027
P.2.4	130	0,08	0,022	0,018	0,011	0,028	0,022	0,014	0,034	0,027	0,017	0,041	0,033	0,021	0,054	0,043	0,027
P.3.1																	
P.3.2																	
P.3.3																	
P.4.1	100	0,08	0,015	0,012	0,008	0,020	0,016	0,010	0,025	0,020	0,013	0,030	0,024	0,015	0,040	0,032	0,020
P.4.2	40	0,08	0,015	0,012	0,008	0,020	0,016	0,010	0,025	0,020	0,013	0,030	0,024	0,015	0,040	0,032	0,020
M.1.1	50	0,08	0,015	0,012	0,008	0,020	0,016	0,010	0,025	0,020	0,013	0,030	0,024	0,015	0,040	0,032	0,020
M.2.1	50	0,08	0,015	0,012	0,008	0,020	0,016	0,010	0,025	0,020	0,013	0,030	0,024	0,015	0,040	0,032	0,020
M.3.1	50	0,08	0,015	0,012	0,008	0,020	0,016	0,010	0,025	0,020	0,013	0,030	0,024	0,015	0,040	0,032	0,020
K.1.1	120	0,08	0,044	0,035	0,022	0,056	0,045	0,028	0,066	0,053	0,033	0,078	0,062	0,039	0,100	0,080	0,050
K.1.2	80	0,08	0,044	0,035	0,022	0,056	0,045	0,028	0,066	0,053	0,033	0,078	0,062	0,039	0,100	0,080	0,050
K.2.1	120	0,08	0,035	0,028	0,018	0,042	0,034	0,021	0,050	0,040	0,025	0,058	0,046	0,029	0,072	0,058	0,036
K.2.2	200	0,08	0,035	0,028	0,018	0,042	0,034	0,021	0,050	0,040	0,025	0,058	0,046	0,029	0,072	0,058	0,036
K.3.1	120	0,08	0,044	0,035	0,022	0,056	0,045	0,028	0,066	0,053	0,033	0,078	0,062	0,039	0,100	0,080	0,050
K.3.2	100	0,08	0,044	0,035	0,022	0,056	0,045	0,028	0,066	0,053	0,033	0,078	0,062	0,039	0,100	0,080	0,050
N.1.1																	
N.1.2																	
N.2.1																	
N.2.2																	
N.2.3																	
N.3.1	200	0,08	0,032	0,026	0,016	0,043	0,034	0,022	0,054	0,043	0,027	0,066	0,053	0,033	0,088	0,070	0,044
N.3.2	200	0,08	0,032	0,026	0,016	0,043	0,034	0,022	0,054	0,043	0,027	0,066	0,053	0,033	0,088	0,070	0,044
N.3.3	140	0,08	0,032	0,026	0,016	0,043	0,034	0,022	0,054	0,043	0,027	0,066	0,053	0,033	0,088	0,070	0,044
N.4.1																	
S.1.1	30	0,08	0,015	0,012	0,008	0,020	0,016	0,010	0,025	0,020	0,013	0,030	0,024	0,015	0,040	0,032	0,020
S.1.2	30	0,08	0,015	0,012	0,008	0,020	0,016	0,010	0,025	0,020	0,013	0,030	0,024	0,015	0,040	0,032	0,020
S.2.1	30	0,08	0,015	0,012	0,008	0,020	0,016	0,010	0,025	0,020	0,013	0,030	0,024	0,015	0,040	0,032	0,020
S.2.2	30	0,08	0,015	0,012	0,008	0,020	0,016	0,010	0,025	0,020	0,013	0,030	0,024	0,015	0,040	0,032	0,020
S.2.3	30	0,08	0,015	0,012	0,008	0,020	0,016	0,010	0,025	0,020	0,013	0,030	0,024	0,015	0,040	0,032	0,020
S.3.1	50	0,08	0,015	0,012	0,008	0,020	0,016	0,010	0,025	0,020	0,013	0,030	0,024	0,015	0,040	0,032	0,020
S.3.2	20	0,08	0,015	0,012	0,008	0,020	0,016	0,010	0,025	0,020	0,013	0,030	0,024	0,015	0,040	0,032	0,020
S.3.3																	
H.1.1																	
H.1.2																	
H.1.3																	
H.1.4																	
H.2.1																	
H.3.1																	
O.1.1																	
O.1.2																	
O.2.1																	
O.2.2																	
O.3.1																	







Index	54 073 ...												● 1st choice		
	Ø DC (mm) =												○ suitable		
	10			12			16			20			Emulsion	Compressed air	MMS
	a_s 0,01-0,02 x DC	a_s 0,03-0,04 x DC	a_s 0,05 x DC	a_s 0,01-0,02 x DC	a_s 0,03-0,04 x DC	a_s 0,05 x DC	a_s 0,01-0,02 x DC	a_s 0,03-0,04 x DC	a_s 0,05 x DC	a_s 0,01-0,02 x DC	a_s 0,03-0,04 x DC	a_s 0,05 x DC			
f_z (mm)															
P.1.1	0,066	0,053	0,033	0,079	0,063	0,040	0,099	0,079	0,050	0,111	0,089	0,056	●	○	○
P.1.2	0,066	0,053	0,033	0,079	0,063	0,040	0,099	0,079	0,050	0,111	0,089	0,056	●	○	○
P.1.3	0,066	0,053	0,033	0,079	0,063	0,040	0,099	0,079	0,050	0,111	0,089	0,056	●	○	○
P.1.4	0,066	0,053	0,033	0,079	0,063	0,040	0,099	0,079	0,050	0,111	0,089	0,056	●	○	○
P.1.5	0,066	0,053	0,033	0,079	0,063	0,040	0,099	0,079	0,050	0,111	0,089	0,056	●	○	○
P.2.1	0,066	0,053	0,033	0,079	0,063	0,040	0,099	0,079	0,050	0,111	0,089	0,056	●	○	○
P.2.2	0,066	0,053	0,033	0,079	0,063	0,040	0,099	0,079	0,050	0,111	0,089	0,056	●	○	○
P.2.3	0,066	0,053	0,033	0,079	0,063	0,040	0,099	0,079	0,050	0,111	0,089	0,056	●	○	○
P.2.4	0,066	0,053	0,033	0,079	0,063	0,040	0,099	0,079	0,050	0,111	0,089	0,056	●	○	○
P.3.1															
P.3.2															
P.3.3															
P.4.1	0,050	0,040	0,025	0,060	0,048	0,030	0,075	0,060	0,038	0,084	0,067	0,042	●		
P.4.2	0,050	0,040	0,025	0,060	0,048	0,030	0,075	0,060	0,038	0,084	0,067	0,042	●		
M.1.1	0,050	0,040	0,025	0,060	0,048	0,030	0,075	0,060	0,038	0,084	0,067	0,042	●		
M.2.1	0,050	0,040	0,025	0,060	0,048	0,030	0,075	0,060	0,038	0,084	0,067	0,042	●		
M.3.1	0,050	0,040	0,025	0,060	0,048	0,030	0,075	0,060	0,038	0,084	0,067	0,042	●		
K.1.1	0,122	0,098	0,061	0,144	0,115	0,072	0,177	0,142	0,089	0,200	0,160	0,100	●	○	○
K.1.2	0,122	0,098	0,061	0,144	0,115	0,072	0,177	0,142	0,089	0,200	0,160	0,100	●	○	○
K.2.1	0,086	0,069	0,043	0,102	0,082	0,051	0,124	0,099	0,062	0,139	0,111	0,070	●	○	○
K.2.2	0,086	0,069	0,043	0,102	0,082	0,051	0,124	0,099	0,062	0,139	0,111	0,070	●	○	○
K.3.1	0,122	0,098	0,061	0,144	0,115	0,072	0,177	0,142	0,089	0,200	0,160	0,100	●	○	○
K.3.2	0,122	0,098	0,061	0,144	0,115	0,072	0,177	0,142	0,089	0,200	0,160	0,100	●	○	○
N.1.1															
N.1.2															
N.2.1															
N.2.2															
N.2.3															
N.3.1	0,110	0,088	0,055	0,132	0,106	0,066	0,166	0,133	0,083	0,188	0,150	0,094	●		
N.3.2	0,110	0,088	0,055	0,132	0,106	0,066	0,166	0,133	0,083	0,188	0,150	0,094	●		
N.3.3	0,110	0,088	0,055	0,132	0,106	0,066	0,166	0,133	0,083	0,188	0,150	0,094	●		
N.4.1															
S.1.1	0,050	0,040	0,025	0,060	0,048	0,030	0,075	0,060	0,038	0,084	0,067	0,042	●		
S.1.2	0,050	0,040	0,025	0,060	0,048	0,030	0,075	0,060	0,038	0,084	0,067	0,042	●		
S.2.1	0,050	0,040	0,025	0,060	0,048	0,030	0,075	0,060	0,038	0,084	0,067	0,042	●		
S.2.2	0,050	0,040	0,025	0,060	0,048	0,030	0,075	0,060	0,038	0,084	0,067	0,042	●		
S.2.3	0,050	0,040	0,025	0,060	0,048	0,030	0,075	0,060	0,038	0,084	0,067	0,042	●		
S.3.1	0,050	0,040	0,025	0,060	0,048	0,030	0,075	0,060	0,038	0,084	0,067	0,042	●		
S.3.2	0,050	0,040	0,025	0,060	0,048	0,030	0,075	0,060	0,038	0,084	0,067	0,042	●		
S.3.3															
H.1.1															
H.1.2															
H.1.3															
H.1.4															
H.2.1															
H.3.1															
O.1.1															
O.1.2															
O.2.1															
O.2.2															
O.3.1															





Cutting data standard values – Ball-nosed end mill

Index	Type short / long		54 074 ...														
	v _c (m/min)	a _{p,max.} x DC	Ø DC (mm) =														
			3			4			5			6			8		
			a _e 0,01–0,02 x DC	a _e 0,03–0,04 x DC	a _e 0,05 x DC	a _e 0,01–0,02 x DC	a _e 0,03–0,04 x DC	a _e 0,05 x DC	a _e 0,01–0,02 x DC	a _e 0,03–0,04 x DC	a _e 0,05 x DC	a _e 0,01–0,02 x DC	a _e 0,03–0,04 x DC	a _e 0,05 x DC	a _e 0,01–0,02 x DC	a _e 0,03–0,04 x DC	a _e 0,05 x DC
			f _z (mm)														
P.1.1	130	0,08xD	0,027	0,022	0,014	0,034	0,027	0,017	0,041	0,033	0,021	0,048	0,038	0,024	0,062	0,050	0,031
P.1.2	110	0,08xD	0,022	0,018	0,011	0,028	0,022	0,014	0,034	0,027	0,017	0,041	0,033	0,021	0,054	0,043	0,027
P.1.3	110	0,08xD	0,022	0,018	0,011	0,028	0,022	0,014	0,034	0,027	0,017	0,041	0,033	0,021	0,054	0,043	0,027
P.1.4	95	0,08xD	0,022	0,018	0,011	0,028	0,022	0,014	0,034	0,027	0,017	0,041	0,033	0,021	0,054	0,043	0,027
P.1.5	95	0,08xD	0,022	0,018	0,011	0,028	0,022	0,014	0,034	0,027	0,017	0,041	0,033	0,021	0,054	0,043	0,027
P.2.1	110	0,08xD	0,022	0,018	0,011	0,028	0,022	0,014	0,034	0,027	0,017	0,041	0,033	0,021	0,054	0,043	0,027
P.2.2	85	0,08xD	0,022	0,018	0,011	0,028	0,022	0,014	0,034	0,027	0,017	0,041	0,033	0,021	0,054	0,043	0,027
P.2.3	85	0,08xD	0,022	0,018	0,011	0,028	0,022	0,014	0,034	0,027	0,017	0,041	0,033	0,021	0,054	0,043	0,027
P.2.4	65	0,08xD	0,022	0,018	0,011	0,028	0,022	0,014	0,034	0,027	0,017	0,041	0,033	0,021	0,054	0,043	0,027
P.3.1																	
P.3.2																	
P.3.3																	
P.4.1	60	0,08xD	0,015	0,012	0,008	0,020	0,016	0,010	0,025	0,020	0,013	0,030	0,024	0,015	0,040	0,032	0,020
P.4.2	50	0,08xD	0,015	0,012	0,008	0,020	0,016	0,010	0,025	0,020	0,013	0,030	0,024	0,015	0,040	0,032	0,020
M.1.1	50	0,08xD	0,015	0,012	0,008	0,020	0,016	0,010	0,025	0,020	0,013	0,030	0,024	0,015	0,040	0,032	0,020
M.2.1	60	0,08xD	0,015	0,012	0,008	0,020	0,016	0,010	0,025	0,020	0,013	0,030	0,024	0,015	0,040	0,032	0,020
M.3.1	60	0,08xD	0,015	0,012	0,008	0,020	0,016	0,010	0,025	0,020	0,013	0,030	0,024	0,015	0,040	0,032	0,020
K.1.1	155	0,08xD	0,044	0,035	0,022	0,056	0,045	0,028	0,066	0,053	0,033	0,078	0,062	0,039	0,100	0,080	0,050
K.1.2	145	0,08xD	0,044	0,035	0,022	0,056	0,045	0,028	0,066	0,053	0,033	0,078	0,062	0,039	0,100	0,080	0,050
K.2.1	155	0,08xD	0,035	0,028	0,018	0,042	0,034	0,021	0,050	0,040	0,025	0,058	0,046	0,029	0,072	0,058	0,036
K.2.2	145	0,08xD	0,035	0,028	0,018	0,042	0,034	0,021	0,050	0,040	0,025	0,058	0,046	0,029	0,072	0,058	0,036
K.3.1	155	0,08xD	0,044	0,035	0,022	0,056	0,045	0,028	0,066	0,053	0,033	0,078	0,062	0,039	0,100	0,080	0,050
K.3.2	145	0,08xD	0,044	0,035	0,022	0,056	0,045	0,028	0,066	0,053	0,033	0,078	0,062	0,039	0,100	0,080	0,050
N.1.1																	
N.1.2																	
N.2.1																	
N.2.2																	
N.2.3																	
N.3.1	240	0,08xD	0,032	0,026	0,016	0,043	0,034	0,022	0,054	0,043	0,027	0,066	0,053	0,033	0,088	0,070	0,044
N.3.2	240	0,08xD	0,032	0,026	0,016	0,043	0,034	0,022	0,054	0,043	0,027	0,066	0,053	0,033	0,088	0,070	0,044
N.3.3	170	0,08xD	0,032	0,026	0,016	0,043	0,034	0,022	0,054	0,043	0,027	0,066	0,053	0,033	0,088	0,070	0,044
N.4.1																	
S.1.1																	
S.1.2																	
S.2.1																	
S.2.2																	
S.2.3																	
S.3.1																	
S.3.2																	
S.3.3																	
H.1.1																	
H.1.2																	
H.1.3																	
H.1.4																	
H.2.1																	
H.3.1																	
O.1.1																	
O.1.2																	
O.2.1																	
O.2.2																	
O.3.1																	

Index	54 074 ...												● 1st choice		
	Ø DC (mm) =												○ suitable		
	10			12			16			20			Emulsion	Compressed air	MMS
	a_s 0,01-0,02 x DC	a_s 0,03-0,04 x DC	a_s 0,05 x DC	a_s 0,01-0,02 x DC	a_s 0,03-0,04 x DC	a_s 0,05 x DC	a_s 0,01-0,02 x DC	a_s 0,03-0,04 x DC	a_s 0,05 x DC	a_s 0,01-0,02 x DC	a_s 0,03-0,04 x DC	a_s 0,05 x DC			
f _z (mm)															
P.1.1	0,075	0,060	0,038	0,089	0,071	0,045	0,110	0,088	0,055	0,123	0,098	0,062	●	○	○
P.1.2	0,066	0,053	0,033	0,079	0,063	0,040	0,099	0,079	0,050	0,111	0,089	0,056	●	○	○
P.1.3	0,066	0,053	0,033	0,079	0,063	0,040	0,099	0,079	0,050	0,111	0,089	0,056	●	○	○
P.1.4	0,066	0,053	0,033	0,079	0,063	0,040	0,099	0,079	0,050	0,111	0,089	0,056	●	○	○
P.1.5	0,066	0,053	0,033	0,079	0,063	0,040	0,099	0,079	0,050	0,111	0,089	0,056	●	○	○
P.2.1	0,066	0,053	0,033	0,079	0,063	0,040	0,099	0,079	0,050	0,111	0,089	0,056	●	○	○
P.2.2	0,066	0,053	0,033	0,079	0,063	0,040	0,099	0,079	0,050	0,111	0,089	0,056	●	○	○
P.2.3	0,066	0,053	0,033	0,079	0,063	0,040	0,099	0,079	0,050	0,111	0,089	0,056	●	○	○
P.2.4	0,066	0,053	0,033	0,079	0,063	0,040	0,099	0,079	0,050	0,111	0,089	0,056	●	○	○
P.3.1															
P.3.2															
P.3.3															
P.4.1	0,050	0,040	0,025	0,060	0,048	0,030	0,075	0,060	0,038	0,084	0,067	0,042	●		
P.4.2	0,050	0,040	0,025	0,060	0,048	0,030	0,075	0,060	0,038	0,084	0,067	0,042	●		
M.1.1	0,050	0,040	0,025	0,060	0,048	0,030	0,075	0,060	0,038	0,084	0,067	0,042	●		
M.2.1	0,050	0,040	0,025	0,060	0,048	0,030	0,075	0,060	0,038	0,084	0,067	0,042	●		
M.3.1	0,050	0,040	0,025	0,060	0,048	0,030	0,075	0,060	0,038	0,084	0,067	0,042	●		
K.1.1	0,122	0,098	0,061	0,144	0,115	0,072	0,177	0,142	0,089	0,200	0,160	0,100	●	○	○
K.1.2	0,122	0,098	0,061	0,144	0,115	0,072	0,177	0,142	0,089	0,200	0,160	0,100	●	○	○
K.2.1	0,086	0,069	0,043	0,102	0,082	0,051	0,124	0,099	0,062	0,139	0,111	0,070	●	○	○
K.2.2	0,086	0,069	0,043	0,102	0,082	0,051	0,124	0,099	0,062	0,139	0,111	0,070	●	○	○
K.3.1	0,122	0,098	0,061	0,144	0,115	0,072	0,177	0,142	0,089	0,200	0,160	0,100	●	○	○
K.3.2	0,122	0,098	0,061	0,144	0,115	0,072	0,177	0,142	0,089	0,200	0,160	0,100	●	○	○
N.1.1															
N.1.2															
N.2.1															
N.2.2															
N.2.3															
N.3.1	0,110	0,088	0,055	0,132	0,106	0,066	0,166	0,133	0,083	0,188	0,150	0,094	●		
N.3.2	0,110	0,088	0,055	0,132	0,106	0,066	0,166	0,133	0,083	0,188	0,150	0,094	●		
N.3.3	0,110	0,088	0,055	0,132	0,106	0,066	0,166	0,133	0,083	0,188	0,150	0,094	●		
N.4.1															
S.1.1															
S.1.2															
S.2.1															
S.2.2															
S.2.3															
S.3.1															
S.3.2															
S.3.3															
H.1.1															
H.1.2															
H.1.3															
H.1.4															
H.2.1															
H.3.1															
O.1.1															
O.1.2															
O.2.1															
O.2.2															
O.3.1															

Cutting Speeds – Depending upon Coating

Index	uncoated		Ti400		● 1st choice ○ suitable			Ti1000 / DPX72S		● 1st choice ○ suitable		
					Emulsion	Compressed air	MMS			Emulsion	Compressed air	MMS
	v _c (m/min)		v _c (m/min)					v _c (m/min)				
P.1.1	90-110	130-160	90-130	140-200	●	○	○	150-170	220-240	○	●	○
P.1.2	80-100	120-140	90-110	100-160	●	○	○	130-150	180-220	○	●	○
P.1.3	80-100	120-140	90-110	100-160	●	○	○	130-150	180-220	○	●	○
P.1.4	50-60	70-90	60-70	80-110	●	○	○	70-100	100-140	○	●	○
P.1.5	50-60	70-90	60-70	80-110	●	○	○	70-100	100-140	○	●	○
P.2.1	70-90	100-130	80-100	140-160	●	○	○	120-140	170-200	○	●	○
P.2.2	70-90	100-130	80-100	100-150	●	○	○	120-140	170-200	○	●	○
P.2.3	40-60	60-80	50-70	70-100	●	○	○	60-80	90-120	○	●	○
P.2.4	40-60	60-80	50-70	70-100	●	○	○	60-80	90-120	○	●	○
P.3.1	50-60	70-90	60-80	70-110	●	○	○	70-100	100-140	○	●	○
P.3.2	30-50	40-70	40-60	70-100	●	○	○	60-80	80-120	○	●	○
P.3.3	25-40	40-60	40-60	70-100	●	○	○	50-80	70-110	○	●	○
P.4.1	40-50	60-70	40-50	60-80	●	○	○	60-80	90-120	●	○	○
P.4.2	40-50	60-70	40-50	60-80	●	○	○	60-80	90-120	●	○	○
M.1.1	40-50	60-70	50-60	80-110	●	○	○	70-80	100-120	●	○	○
M.2.1	20-30	30-40	25-35	40-70	●	○	○	40-60	60-80	●	○	○
M.3.1	30-40	40-50	40-50	70-100	●	○	○	50-70	80-100	●	○	○
K.1.1	60-80	90-120	70-90	100-130	●	○	○	100-110	140-160	○	●	○
K.1.2	60-70	80-100	60-80	90-120	●	○	○	80-100	120-140	○	●	○
K.2.1	60-70	80-100	70-90	100-130	●	○	○	80-100	120-140	○	●	○
K.2.2	50-60	70-90	60-80	90-120	●	○	○	70-80	100-120	○	●	○
K.3.1	60-80	90-120	60-80	90-120	●	○	○	100-110	140-160	○	●	○
K.3.2	50-60	70-90	60-80	90-120	●	○	○	70-80	100-120	○	●	○
N.1.1	<300	<400	280-320	250-350	●	○	○	180-350	250-500	●	○	○
N.1.2	<300	<400	280-320	220-320	●	○	○	180-350	250-500	●	○	○
N.2.1	130-180	200-250	220-270	200-300	●	○	○	140-200	200-300	●	○	○
N.2.2	100-120	140-170	170-200	200-250	●	○	○	110-130	160-180	●	○	○
N.2.3	40-60	60-80	120-180	150-200	●	○	○	50-70	80-100	●	○	○
N.3.1	160-200	230-280	100-130	120-200	●	○	○	180-210	250-300	●	○	○
N.3.2	150-180	210-260	100-130	120-180	●	○	○	180-210	250-300	●	○	○
N.3.3	150-180	210-260	100-130	120-180	●	○	○	180-210	250-300	●	○	○
N.4.1	150-180	220-260	170-200	170-250	●	●	○	180-210	250-300	○	●	○
S.1.1			25-35	30-50	●	○	○	30-40	40-60	●	○	○
S.1.2			25-35	30-50	●	○	○	30-40	40-60	●	○	○
S.2.1	15-25	20-35	40-60	50-80	●	○	○	35-50	50-70	●	○	○
S.2.2			30-40	40-60	●	○	○	30-40	40-60	●	○	○
S.2.3												
S.3.1	30-50	40-70	40-50	70-100	●	○	○	50-70	80-100	●	○	○
S.3.2	30-40	40-50	50-60	80-120	●	○	○	50-60	70-90	●	○	○
S.3.3			30-40	40-60	●	○	○	20-30	30-40	●	○	○
H.1.1								60-70	80-100		●	○
H.1.2								40-60	60-80		●	○
H.1.3								30-40	40-60		●	○
H.1.4								20-30	30-40		●	○
H.2.1								70-80	100-120		●	○
H.3.1								60-70	80-100		●	○
O.1.1	50-70	70-100	120-180	150-220	●	○	○	60-80	80-120	○	●	○
O.1.2	40-60	60-90	70-90	90-120	●	○	○	40-70	60-100	○	●	○
O.2.1	30-50	40-70	50-70	70-110	●	○	○	40-60	60-80	○	●	○
O.2.2	30-50	40-70	50-70	70-110	●	○	○	40-60	60-80	○	●	○
O.3.1	70-100	100-140	100-120	130-180		●	○	80-120	120-180		●	○

Index	Ti1001		● 1st choice ○ suitable			Ti10 / Ti20		● 1st choice ○ suitable		
			Emulsion	Compressed air	MMS			Emulsion	Compressed air	MMS
	v _c (m/min)					v _c (m/min)				
P.1.1										
P.1.2										
P.1.3										
P.1.4										
P.1.5										
P.2.1										
P.2.2										
P.2.3										
P.2.4										
P.3.1										
P.3.2										
P.3.3										
P.4.1										
P.4.2										
M.1.1										
M.2.1										
M.3.1										
K.1.1										
K.1.2										
K.2.1										
K.2.2										
K.3.1										
K.3.2										
N.1.1	300-400	300-500	●		○	150-350	250-500	●		○
N.1.2	300-400	300-500	●		○	120-220	150-300	●		○
N.2.1	250-300	300-450	●		○	150-180	220-250	●		○
N.2.2	200-250	250-350	●		○	100-130	150-180	●		○
N.2.3	150-200	200-250	●		○					○
N.3.1						170-180	240-260	●		○
N.3.2	220-280	250-330	●		○	120-150	170-220	●		○
N.3.3	220-280	250-330	●		○	120-150	170-220	●		○
N.4.1						140-170	200-250		●	
S.1.1										
S.1.2										
S.2.1										
S.2.2										
S.2.3										
S.3.1							80-100	●		○
S.3.2										
S.3.3										
H.1.1										
H.1.2										
H.1.3										
H.1.4										
H.2.1										
H.3.1										
O.1.1						220-280	300-400	●		○
O.1.2						140-170	200-240	●		○
O.2.1						70-100	100-140	●		○
O.2.2						70-100	100-140	●		○
O.3.1										

Depths of Cut Reference Values – Milling Cutters – extra short – long

Index	Ø DC (mm) =									Ø DC (mm) =									
	2,5			3,0			4,0			5,0			6,0						
	a_e 0,1-0,2 x DC	a_e 0,3-0,4 x DC	a_e 0,6-1,0 x DC	a_e 0,1-0,2 x DC	a_e 0,3-0,4 x DC	a_e 0,6-1,0 x DC	a_e 0,1-0,2 x DC	a_e 0,3-0,4 x DC	a_e 0,6-1,0 x DC	a_e 0,1-0,2 x DC	a_e 0,3-0,4 x DC	a_e 0,6-1,0 x DC	a_e 0,1-0,2 x DC	a_e 0,3-0,4 x DC	a_e 0,6-1,0 x DC				
$a_{p max.} \times DC$	f_z (mm)									$a_{p max.} \times DC$	f_z (mm)								
P.1.1	1,0	0,5	0,017	0,011	0,008	0,024	0,016	0,012	1,5	1,0	0,033	0,022	0,016	0,041	0,027	0,020	0,054	0,035	0,026
P.1.2	1,0	0,5	0,017	0,011	0,008	0,024	0,016	0,012	1,5	1,0	0,033	0,022	0,016	0,043	0,028	0,021	0,054	0,035	0,026
P.1.3	1,0	0,5	0,017	0,011	0,008	0,024	0,016	0,012	1,5	1,0	0,033	0,022	0,016	0,043	0,028	0,021	0,054	0,035	0,026
P.1.4	1,0	0,5	0,017	0,011	0,008	0,024	0,016	0,012	1,5	1,0	0,033	0,022	0,016	0,043	0,028	0,021	0,054	0,035	0,026
P.1.5	1,0	0,5	0,017	0,011	0,008	0,024	0,016	0,012	1,5	1,0	0,033	0,022	0,016	0,043	0,028	0,021	0,054	0,035	0,026
P.2.1	1,0	0,5	0,017	0,011	0,008	0,024	0,016	0,012	1,5	1,0	0,033	0,022	0,016	0,043	0,028	0,021	0,054	0,035	0,026
P.2.2	1,0	0,5	0,014	0,009	0,007	0,020	0,013	0,010	1,5	1,0	0,027	0,018	0,013	0,036	0,024	0,018	0,045	0,029	0,022
P.2.3	1,0	0,5	0,014	0,009	0,007	0,020	0,013	0,010	1,5	1,0	0,027	0,018	0,013	0,036	0,024	0,018	0,045	0,029	0,022
P.2.4	1,0	0,5	0,014	0,009	0,007	0,020	0,013	0,010	1,5	1,0	0,027	0,018	0,013	0,036	0,024	0,018	0,045	0,029	0,022
P.3.1	1,0	0,5	0,017	0,011	0,008	0,024	0,016	0,012	1,5	1,0	0,033	0,022	0,016	0,043	0,028	0,021	0,054	0,035	0,026
P.3.2	1,0	0,5	0,017	0,011	0,008	0,024	0,016	0,012	1,5	1,0	0,033	0,022	0,016	0,043	0,028	0,021	0,054	0,035	0,026
P.3.3	1,0	0,5	0,017	0,011	0,008	0,024	0,016	0,012	1,5	1,0	0,033	0,022	0,016	0,043	0,028	0,021	0,054	0,035	0,026
P.4.1	1,0	0,5	0,011	0,007	0,005	0,016	0,011	0,008	1,5	1,0	0,022	0,014	0,011	0,029	0,019	0,014	0,036	0,023	0,017
P.4.2	1,0	0,5	0,011	0,007	0,005	0,016	0,011	0,008	1,5	1,0	0,022	0,014	0,011	0,029	0,019	0,014	0,036	0,023	0,017
M.1.1	1,0	0,5	0,011	0,007	0,005	0,016	0,011	0,008	1,5	1,0	0,022	0,014	0,011	0,029	0,019	0,014	0,036	0,023	0,017
M.2.1	1,0	0,5	0,011	0,007	0,005	0,016	0,011	0,008	1,5	1,0	0,022	0,014	0,011	0,029	0,019	0,014	0,036	0,023	0,017
M.3.1	1,0	0,5	0,011	0,007	0,005	0,016	0,011	0,008	1,5	1,0	0,022	0,014	0,011	0,029	0,019	0,014	0,036	0,023	0,017
K.1.1	1,0	0,5	0,020	0,013	0,010	0,029	0,019	0,014	1,5	1,0	0,039	0,026	0,019	0,052	0,034	0,025	0,064	0,042	0,031
K.1.2	1,0	0,5	0,017	0,011	0,008	0,025	0,016	0,012	1,5	1,0	0,034	0,022	0,016	0,044	0,029	0,022	0,055	0,036	0,027
K.2.1	1,0	0,5	0,017	0,011	0,008	0,025	0,016	0,012	1,5	1,0	0,034	0,022	0,016	0,044	0,029	0,022	0,055	0,036	0,027
K.2.2	1,0	0,5	0,017	0,011	0,008	0,025	0,016	0,012	1,5	1,0	0,034	0,022	0,016	0,044	0,029	0,022	0,055	0,036	0,027
K.3.1	1,0	0,5	0,017	0,011	0,008	0,025	0,016	0,012	1,5	1,0	0,034	0,022	0,016	0,044	0,029	0,022	0,055	0,036	0,027
K.3.2	1,0	0,5	0,017	0,011	0,008	0,025	0,016	0,012	1,5	1,0	0,034	0,022	0,016	0,044	0,029	0,022	0,055	0,036	0,027
N.1.1	1,0	0,5	0,028	0,018	0,013	0,040	0,027	0,020	1,5	1,0	0,055	0,036	0,027	0,072	0,047	0,035	0,090	0,059	0,043
N.1.2	1,0	0,5	0,028	0,018	0,013	0,040	0,027	0,020	1,5	1,0	0,055	0,036	0,027	0,072	0,047	0,035	0,090	0,059	0,043
N.2.1	1,0	0,5	0,028	0,018	0,013	0,040	0,027	0,020	1,5	1,0	0,055	0,036	0,027	0,072	0,047	0,035	0,090	0,059	0,043
N.2.2	1,0	0,5	0,028	0,018	0,013	0,040	0,027	0,020	1,5	1,0	0,055	0,036	0,027	0,072	0,047	0,035	0,090	0,059	0,043
N.2.3	1,0	0,5	0,028	0,018	0,013	0,040	0,027	0,020	1,5	1,0	0,055	0,036	0,027	0,072	0,047	0,035	0,090	0,059	0,043
N.3.1	1,0	0,5	0,019	0,012	0,009	0,028	0,018	0,013	1,5	1,0	0,038	0,025	0,018	0,050	0,032	0,024	0,061	0,040	0,030
N.3.2	1,0	0,5	0,019	0,012	0,009	0,028	0,018	0,013	1,5	1,0	0,038	0,025	0,018	0,050	0,032	0,024	0,061	0,040	0,030
N.3.3	1,0	0,5	0,019	0,012	0,009	0,028	0,018	0,013	1,5	1,0	0,038	0,025	0,018	0,050	0,032	0,024	0,061	0,040	0,030
N.4.1	1,0	0,5	0,026	0,017	0,012	0,038	0,025	0,018	1,5	1,0	0,051	0,033	0,025	0,067	0,044	0,033	0,083	0,054	0,040
S.1.1	0,7	0,3	0,014	0,009	0,007	0,020	0,013	0,010	1,0	1,0	0,027	0,018	0,013	0,036	0,024	0,018	0,045	0,029	0,022
S.1.2	0,7	0,3	0,014	0,009	0,007	0,020	0,013	0,010	1,0	1,0	0,027	0,018	0,013	0,036	0,024	0,018	0,045	0,029	0,022
S.2.1	0,7	0,3	0,015	0,010	0,007	0,022	0,014	0,011	1,0	1,0	0,030	0,020	0,014	0,039	0,026	0,019	0,049	0,032	0,024
S.2.2	0,7	0,3	0,014	0,009	0,007	0,020	0,013	0,010	1,0	1,0	0,027	0,018	0,013	0,036	0,024	0,018	0,045	0,029	0,022
S.2.3	0,7	0,3	0,015	0,010	0,007	0,022	0,014	0,011	1,0	1,0	0,030	0,020	0,014	0,039	0,026	0,019	0,049	0,032	0,024
S.3.1	0,7	0,3	0,017	0,011	0,008	0,024	0,016	0,012	1,0	1,0	0,033	0,022	0,016	0,043	0,028	0,021	0,054	0,035	0,026
S.3.2	0,7	0,3	0,018	0,012	0,009	0,026	0,017	0,013	1,0	1,0	0,035	0,023	0,017	0,046	0,030	0,023	0,058	0,038	0,028
S.3.3	0,7	0,3	0,018	0,012	0,009	0,026	0,017	0,013	1,0	1,0	0,035	0,023	0,017	0,046	0,030	0,023	0,058	0,038	0,028
H.1.1	0,5*		0,019**			0,027**			1,0		0,037**			0,049**			0,061**		
H.1.2	0,5*		0,017**			0,025**			1,0		0,034**			0,045**			0,056**		
H.1.3	0,5*		0,015**			0,022**			1,0		0,030**			0,040**			0,050**		
H.1.4	0,5*		0,013**			0,020**			1,0		0,026**			0,035**			0,043**		
H.2.1	0,5*		0,021**			0,030**			1,0		0,041**			0,054**			0,067**		
H.3.1	0,5*		0,019**			0,027**			1,0		0,037**			0,049**			0,061**		
O.1.1	1,0	0,5	0,044	0,029	0,021	0,064	0,042	0,031	1,5	1,0	0,086	0,057	0,042	0,114	0,074	0,055	0,141	0,092	0,068
O.1.2	1,0	0,5	0,040	0,026	0,019	0,058	0,038	0,028	1,5	1,1	0,078	0,051	0,038	0,103	0,068	0,050	0,128	0,084	0,062
O.2.1	1,0	0,5	0,019	0,012	0,009	0,028	0,018	0,013	1,5	1,2	0,038	0,025	0,018	0,050	0,032	0,024	0,061	0,040	0,030
O.2.2	1,0	0,5	0,019	0,012	0,009	0,028	0,018	0,013	1,5	1,3	0,038	0,025	0,018	0,050	0,032	0,024	0,061	0,040	0,030
O.3.1	1,0	0,5	0,019	0,012	0,009	0,028	0,018	0,013	1,5	1,4	0,038	0,025	0,018	0,050	0,032	0,024	0,061	0,040	0,030

* = Trimming and trochoidal slot milling

** = With an $a_e = 0.1 \times DC$

Depths of cut reference values – Finish milling, extra short – long

$a_{p max.} \times DC$	Ø DC (mm) =						$a_{p max.} \times DC$	Ø DC (mm) =																	
	2,5			3,0				4,0			5,0			6,0											
	f_z (mm)							f_z (mm)																	
0,7							1,5	0,080***						0,090***						0,100***					

*** = To improve the surface quality reduce the f_z

Depths of Cut Reference Values – Milling Cutters – extra long

Index	a _{p,max} x DC	Ø DC (mm) =				a _{p,max} x DC	Ø DC (mm) =											
		2,5		3,0			4,0		5,0		6,0		8,0		10,0		12,0	
		a _e 0,1-0,2 x DC	a _e 0,3-0,4 x DC	a _e 0,1-0,2 x DC	a _e 0,3-0,4 x DC		a _e 0,1-0,2 x DC	a _e 0,3-0,4 x DC	a _e 0,1-0,2 x DC	a _e 0,3-0,4 x DC	a _e 0,1-0,2 x DC	a _e 0,3-0,4 x DC	a _e 0,1-0,2 x DC	a _e 0,3-0,4 x DC	a _e 0,1-0,2 x DC	a _e 0,3-0,4 x DC	a _e 0,1-0,2 x DC	a _e 0,3-0,4 x DC
f _z (mm)																		
P.1.1	0,6	0,013	0,009	0,024	0,016	1,0	0,033	0,021	0,052	0,034	0,049	0,032	0,070	0,040	0,080	0,050	0,090	0,060
P.1.2	0,6	0,013	0,009	0,024	0,016	1,0	0,033	0,021	0,041	0,027	0,049	0,032	0,070	0,040	0,080	0,050	0,090	0,060
P.1.3	0,6	0,013	0,009	0,024	0,016	1,0	0,033	0,021	0,041	0,027	0,049	0,032	0,070	0,040	0,080	0,050	0,090	0,060
P.1.4	0,6	0,013	0,009	0,024	0,016	1,0	0,033	0,021	0,041	0,027	0,049	0,032	0,070	0,040	0,080	0,050	0,090	0,060
P.1.5	0,6	0,013	0,009	0,024	0,016	1,0	0,033	0,021	0,041	0,027	0,049	0,032	0,070	0,040	0,080	0,050	0,090	0,060
P.2.1	0,6	0,013	0,009	0,024	0,016	1,0	0,033	0,021	0,041	0,027	0,049	0,032	0,070	0,040	0,080	0,050	0,090	0,060
P.2.2	0,6	0,011	0,007	0,020	0,013	1,0	0,027	0,018	0,034	0,022	0,041	0,027	0,050	0,040	0,070	0,040	0,080	0,050
P.2.3	0,6	0,011	0,007	0,020	0,013	1,0	0,027	0,018	0,034	0,022	0,041	0,027	0,050	0,040	0,070	0,040	0,080	0,050
P.2.4	0,6	0,011	0,007	0,020	0,013	1,0	0,027	0,018	0,034	0,022	0,041	0,027	0,050	0,040	0,070	0,040	0,080	0,050
P.3.1	0,6	0,013	0,009	0,024	0,016	1,0	0,033	0,021	0,041	0,027	0,049	0,032	0,070	0,040	0,080	0,050	0,090	0,060
P.3.2	0,6	0,013	0,009	0,024	0,016	1,0	0,033	0,021	0,041	0,027	0,049	0,032	0,070	0,040	0,080	0,050	0,090	0,060
P.3.3	0,6	0,013	0,009	0,024	0,016	1,0	0,033	0,021	0,041	0,027	0,049	0,032	0,070	0,040	0,080	0,050	0,090	0,060
P.4.1	0,6	0,009	0,006	0,016	0,011	1,0	0,022	0,014	0,027	0,018	0,033	0,021	0,040	0,030	0,050	0,040	0,060	0,040
P.4.2	0,6	0,009	0,006	0,016	0,011	1,0	0,022	0,014	0,027	0,018	0,033	0,021	0,040	0,030	0,050	0,040	0,060	0,040
M.1.1	0,6	0,009	0,006	0,016	0,011	1,0	0,022	0,014	0,027	0,018	0,033	0,021	0,040	0,030	0,050	0,040	0,060	0,040
M.2.1	0,6	0,009	0,006	0,016	0,011	1,0	0,022	0,014	0,027	0,018	0,033	0,021	0,040	0,030	0,050	0,040	0,060	0,040
M.3.1	0,6	0,009	0,006	0,016	0,011	1,0	0,022	0,014	0,027	0,018	0,033	0,021	0,040	0,030	0,050	0,040	0,060	0,040
K.1.1	0,6	0,015	0,010	0,029	0,019	1,0	0,039	0,025	0,048	0,032	0,058	0,038	0,080	0,050	0,100	0,060	0,110	0,070
K.1.2	0,6	0,013	0,009	0,025	0,016	1,0	0,033	0,022	0,042	0,027	0,050	0,033	0,070	0,040	0,080	0,060	0,090	0,060
K.2.1	0,6	0,013	0,009	0,025	0,016	1,0	0,033	0,022	0,042	0,027	0,050	0,033	0,070	0,040	0,080	0,060	0,090	0,060
K.2.2	0,6	0,013	0,009	0,025	0,016	1,0	0,033	0,022	0,042	0,027	0,050	0,033	0,070	0,040	0,080	0,060	0,090	0,060
K.3.1	0,6	0,013	0,009	0,025	0,016	1,0	0,033	0,022	0,042	0,027	0,050	0,033	0,070	0,040	0,080	0,060	0,090	0,060
K.3.2	0,6	0,013	0,009	0,025	0,016	1,0	0,033	0,022	0,042	0,027	0,050	0,033	0,070	0,040	0,080	0,060	0,090	0,060
N.1.1	0,6	0,022	0,014	0,041	0,027	1,0	0,054	0,035	0,068	0,044	0,081	0,053	0,110	0,070	0,140	0,090	0,150	0,100
N.1.2	0,6	0,022	0,014	0,041	0,027	1,0	0,054	0,035	0,068	0,044	0,081	0,053	0,110	0,070	0,140	0,090	0,150	0,100
N.2.1	0,6	0,022	0,014	0,041	0,027	1,0	0,054	0,035	0,068	0,044	0,081	0,053	0,110	0,070	0,140	0,090	0,150	0,100
N.2.2	0,6	0,022	0,014	0,041	0,027	1,0	0,054	0,035	0,068	0,044	0,081	0,053	0,110	0,070	0,140	0,090	0,150	0,100
N.2.3	0,6	0,022	0,014	0,041	0,027	1,0	0,054	0,035	0,068	0,044	0,081	0,053	0,110	0,070	0,140	0,090	0,150	0,100
N.3.1	0,6	0,015	0,010	0,028	0,018	1,0	0,037	0,024	0,046	0,030	0,056	0,037	0,070	0,050	0,090	0,060	0,100	0,070
N.3.2	0,6	0,015	0,010	0,028	0,018	1,0	0,037	0,024	0,046	0,030	0,056	0,037	0,070	0,050	0,090	0,060	0,100	0,070
N.3.3	0,6	0,015	0,010	0,028	0,018	1,0	0,037	0,024	0,046	0,030	0,056	0,037	0,070	0,050	0,090	0,060	0,100	0,070
N.4.1	0,6	0,020	0,013	0,038	0,025	1,0	0,050	0,033	0,063	0,041	0,076	0,049	0,100	0,070	0,130	0,080	0,140	0,090
S.1.1	0,3	0,011	0,007	0,020	0,013	0,5	0,027	0,018	0,034	0,022	0,041	0,027	0,050	0,040	0,070	0,040	0,080	0,050
S.1.2	0,3	0,011	0,007	0,020	0,013	0,5	0,027	0,018	0,034	0,022	0,041	0,027	0,050	0,040	0,070	0,040	0,080	0,050
S.2.1	0,3	0,012	0,008	0,022	0,014	0,5	0,029	0,019	0,037	0,024	0,044	0,029	0,060	0,040	0,070	0,050	0,080	0,050
S.2.2	0,3	0,011	0,007	0,020	0,013	0,5	0,027	0,018	0,034	0,022	0,041	0,027	0,050	0,040	0,070	0,040	0,080	0,050
S.2.3	0,3	0,012	0,008	0,022	0,014	0,5	0,029	0,019	0,037	0,024	0,044	0,029	0,060	0,040	0,070	0,050	0,080	0,050
S.3.1	0,3	0,013	0,009	0,024	0,016	0,5	0,033	0,021	0,041	0,027	0,049	0,032	0,070	0,040	0,080	0,050	0,090	0,060
S.3.2	0,3	0,014	0,009	0,026	0,017	0,5	0,035	0,023	0,044	0,029	0,052	0,034	0,070	0,050	0,090	0,060	0,100	0,060
S.3.3	0,3	0,014	0,009	0,026	0,017	0,5	0,035	0,023	0,044	0,029	0,052	0,034	0,070	0,050	0,090	0,060	0,100	0,060
H.1.1	0,3*	0,012**		0,022**		0,5*	0,029**		0,037**		0,044**		0,060**		0,070**		0,080**	
H.1.2	0,3*	0,011**		0,020**		0,5*	0,027**		0,034**		0,041**		0,050**		0,070**		0,080**	
H.1.3	0,3*	0,010**		0,018**		0,5*	0,024**		0,030**		0,036**		0,050**		0,060**		0,070**	
H.1.4	0,3*	0,008**		0,016**		0,5*	0,021**		0,026**		0,031**		0,040**		0,050**		0,060**	
H.2.1	0,3*	0,013**		0,024**		0,5*	0,033**		0,041**		0,049**		0,070**		0,080**		0,090**	
H.3.1	0,3*	0,012**		0,022**		0,5*	0,029**		0,037**		0,044**		0,060**		0,070**		0,080**	
O.1.1	0,6	0,034	0,022	0,064	0,042	1,0	0,085	0,056	0,107	0,070	0,128	0,084	0,170	0,110	0,210	0,140	0,230	0,150
O.1.2	0,6	0,031	0,020	0,058	0,038	1,0	0,077	0,051	0,097	0,063	0,116	0,076	0,160	0,100	0,190	0,130	0,210	0,140
O.2.1	0,6	0,015	0,010	0,028	0,018	1,0	0,037	0,024	0,046	0,030	0,056	0,037	0,070	0,050	0,090	0,060	0,100	0,070
O.2.2	0,6	0,015	0,010	0,028	0,018	1,0	0,037	0,024	0,046	0,030	0,056	0,037	0,070	0,050	0,090	0,060	0,100	0,070
O.3.1	0,6	0,015	0,010	0,028	0,018	1,0	0,037	0,024	0,046	0,030	0,056	0,037	0,070	0,050	0,090	0,060	0,100	0,070

* = Trimming and trochoidal slot milling

** = With an a_e = 0.1xDC

Depths of cut reference values – Finish milling, extra long

Index	a _{p,max} x DC	Ø DC (mm) =		a _{p,max} x DC	Ø DC (mm) =					
		2,5	3,0		4,0	5,0	6,0	8,0	10,0	12,0
		a _e 0,2-0,3 mm	a _e 0,2-0,3 mm		a _e 0,2-0,3 mm	a _e 0,2-0,3 mm	a _e 0,2-0,3 mm	a _e 0,2-0,3 mm	a _e 0,2-0,3 mm	a _e 0,2-0,3 mm
f _z (mm)										
	0,7			0,7	0,080***	0,090***	0,100***	0,110***	0,130***	0,150***

*** = With an a_e of 1.5 x DC multiply the f_z by 0.75

Index	Ø DC (mm) =							
	14,0		16,0		18,0		20,0–25,0	
	a_p 0,1–0,2 x DC	a_p 0,3–0,4 x DC	a_p 0,1–0,2 x DC	a_p 0,3–0,4 x DC	a_p 0,1–0,2 x DC	a_p 0,3–0,4 x DC	a_p 0,1–0,2 x DC	a_p 0,3–0,4 x DC
f_z (mm)								
P.1.1	0,100	0,060	0,110	0,070	0,120	0,080	0,140	0,090
P.1.2	0,100	0,060	0,110	0,070	0,120	0,080	0,140	0,090
P.1.3	0,100	0,060	0,110	0,070	0,120	0,080	0,140	0,090
P.1.4	0,100	0,060	0,110	0,070	0,120	0,080	0,140	0,090
P.1.5	0,100	0,060	0,110	0,070	0,120	0,080	0,140	0,090
P.2.1	0,100	0,060	0,110	0,070	0,120	0,080	0,140	0,090
P.2.2	0,080	0,050	0,090	0,060	0,100	0,070	0,110	0,080
P.2.3	0,080	0,050	0,090	0,060	0,100	0,070	0,110	0,080
P.2.4	0,080	0,050	0,090	0,060	0,100	0,070	0,110	0,080
P.3.1	0,100	0,060	0,110	0,070	0,120	0,080	0,140	0,090
P.3.2	0,100	0,060	0,110	0,070	0,120	0,080	0,140	0,090
P.3.3	0,100	0,060	0,110	0,070	0,120	0,080	0,140	0,090
P.4.1	0,070	0,040	0,070	0,050	0,080	0,050	0,090	0,060
P.4.2	0,070	0,040	0,070	0,050	0,080	0,050	0,090	0,060
M.1.1	0,070	0,040	0,070	0,050	0,080	0,050	0,090	0,060
M.2.1	0,070	0,040	0,070	0,050	0,080	0,050	0,090	0,060
M.3.1	0,070	0,040	0,070	0,050	0,080	0,050	0,090	0,060
K.1.1	0,120	0,080	0,130	0,090	0,150	0,100	0,160	0,110
K.1.2	0,100	0,070	0,110	0,070	0,130	0,080	0,140	0,090
K.2.1	0,100	0,070	0,110	0,070	0,130	0,080	0,140	0,090
K.2.2	0,100	0,070	0,110	0,070	0,130	0,080	0,140	0,090
K.3.1	0,100	0,070	0,110	0,070	0,130	0,080	0,140	0,090
K.3.2	0,100	0,070	0,110	0,070	0,130	0,080	0,140	0,090
N.1.1	0,160	0,110	0,180	0,120	0,200	0,130	0,230	0,150
N.1.2	0,160	0,110	0,180	0,120	0,200	0,130	0,230	0,150
N.2.1	0,160	0,110	0,180	0,120	0,200	0,130	0,230	0,150
N.2.2	0,160	0,110	0,180	0,120	0,200	0,130	0,230	0,150
N.2.3	0,160	0,110	0,180	0,120	0,200	0,130	0,230	0,150
N.3.1	0,110	0,070	0,130	0,080	0,140	0,090	0,160	0,100
N.3.2	0,110	0,070	0,130	0,080	0,140	0,090	0,160	0,100
N.3.3	0,110	0,070	0,130	0,080	0,140	0,090	0,160	0,100
N.4.1	0,150	0,100	0,170	0,110	0,190	0,120	0,210	0,140
S.1.1	0,080	0,050	0,090	0,060	0,100	0,070	0,110	0,080
S.1.2	0,080	0,050	0,090	0,060	0,100	0,070	0,110	0,080
S.2.1	0,090	0,060	0,100	0,070	0,110	0,070	0,120	0,080
S.2.2	0,080	0,050	0,090	0,060	0,100	0,070	0,110	0,080
S.2.3	0,090	0,060	0,100	0,070	0,110	0,070	0,120	0,080
S.3.1	0,100	0,060	0,110	0,070	0,120	0,080	0,140	0,090
S.3.2	0,110	0,070	0,120	0,080	0,130	0,090	0,150	0,100
S.3.3	0,110	0,070	0,120	0,080	0,130	0,090	0,150	0,100
H.1.1	0,090**		0,100**		0,110**		0,120**	
H.1.2	0,080**		0,090**		0,100**		0,110**	
H.1.3	0,070**		0,080**		0,090**		0,100**	
H.1.4	0,060**		0,070**		0,080**		0,090**	
H.2.1	0,100**		0,110**		0,120**		0,140**	
H.3.1	0,090**		0,100**		0,110**		0,120**	
O.1.1	0,260	0,170	0,290	0,190	0,320	0,210	0,360	0,230
O.1.2	0,230	0,150	0,260	0,170	0,290	0,190	0,330	0,210
O.2.1	0,110	0,070	0,130	0,080	0,140	0,090	0,160	0,100
O.2.2	0,110	0,070	0,130	0,080	0,140	0,090	0,160	0,100
O.3.1	0,110	0,070	0,130	0,080	0,140	0,090	0,160	0,100

	Ø DC (mm) =			
	14,0	16,0	18,0	20,0–25,0
	a_p 0,2–0,3 mm	a_p 0,2–0,3 mm	a_p 0,2–0,3 mm	a_p 0,2–0,3 mm
f_z (mm)				
	0,170***	0,190***	0,210***	0,230***

 Plunging angle for ramping and helical milling: 3°

 Feed rate guide values for ball nosed and torus cutters on → Page 486

Feedrate for machining in steel, iron and non-ferrous materials with torus and ball nosed end mills

Ball nose end milling cutters

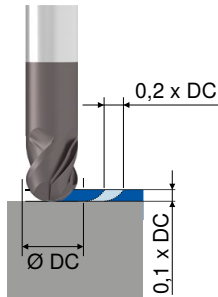

Ball Nosed and Torus Cutters

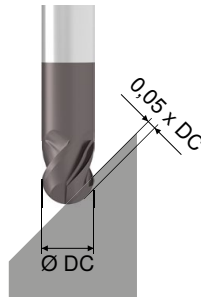

Torus end milling cutters

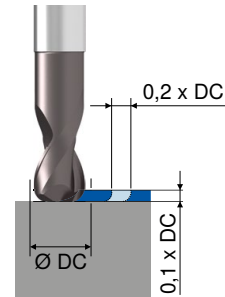

Ø DC mm	f_z mm	f_z mm	f_z mm
2	0,015	0,010	0,010
3	0,030	0,020	0,015
4	0,040	0,030	0,020
5	0,060	0,050	0,030
6	0,070	0,060	0,050
8	0,100	0,080	0,070
10	0,120	0,100	0,080
12	0,150	0,120	0,100
16	0,180	0,150	0,120
18	0,200	0,180	0,140
20	0,220	0,200	0,150



The feed should be reduced by 10–20% for uncoated tools.

Feedrates for the machining of hardened materials with Ti1000 coated torus and ball nosed cutters

Ball Nosed and Torus Cutters

Hardness = 40–60 HRC
 $v_c = 80 - 120$ m/min

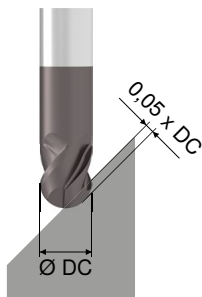

Ball Nosed and Torus Cutters

Hardness = 40–60 HRC
 $v_c = 80 - 120$ m/min

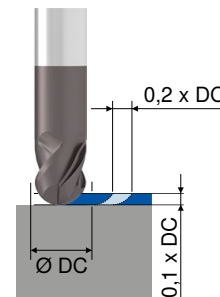

Ø DC mm	f_z mm	f_z mm
2	0,005	0,005
3	0,015	0,010
4	0,030	0,015
5	0,050	0,020
6	0,060	0,030
8	0,070	0,035
10	0,080	0,040
12	0,080	0,050
16	0,100	0,080

Trochoidal Milling

Due to the trochoidal milling process, large depths of cut are also possible on unstable and weak machines.

Depending on the tensile strength of the material, the radial infeed is 5–20% of the cutting edge diameter. As trochoidal milling is a plain milling process, the forces that occur are lower.

When trochoidal milling a slot, the milling cutter diameter should be a maximum of 70% of the slot width.

Example: Slot 20 mm x 70% = 14 mm

A Ø 14 mm milling cutter would be the perfect tool.

Advantages/Benefits

- ▲ Reduced tool wear
- ▲ Reduced cycle time
- ▲ Exploiting the full length of the cutting edge
- ▲ Reduced cutting pressure

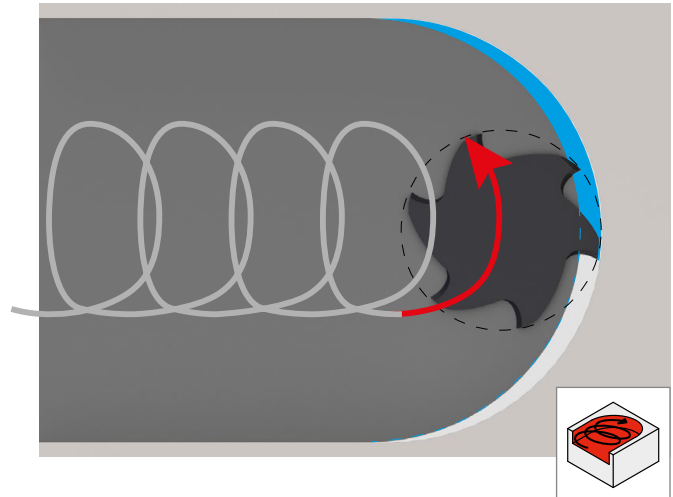

Most CAM providers offer an application for trochoidal milling. Our recommendations for this application are as follows:

Material	Depth of Cut	Radial Infeed	Feed rate Correction Factor	v_c Correction Factor
Steel	2xDC	0,05xD	3,5	1,6
	2xDC	0,10xD	2,5	1,3
Stainless steel	2xDC	0,05xD	3,5	1,4
	2xDC	0,10xD	2,5	1,2
Cast iron	2xDC	0,05xD	3,5	1,6
	2xDC	0,10xD	2,5	1,3
Non-ferrous metals	2xDC	0,05xD	3,5	1,8
	2xDC	0,10xD	2,5	1,4
	2xDC	0,20xD	1,5	1,2
Heat-resistant	2xDC	0,05xD	2,5	1,4
	2xDC	0,10xD	2,0	1,2
Tempered steel	2xDC	0,02xD	2,5	1,5
	2xDC	0,05xD	2,0	1,3



Please note that the indicated values may require reducing due to the component design, machine rigidity and machine dynamics. In optimal conditions, the values can also be increased.

Technical references

Feedrate Adjustment

If the speed stated in the tables cannot be achieved by the machine spindle you are using, reduce the feed rate as a percentage of the speed.

Example:

required according to table = n 50,000 rpm and v_f 1000 mm/min,
available machine speed = 40,000 rpm

Calculation of the feed rate to be entered:

$40,000 \text{ rpm} / 50,000 \text{ rpm} * 100 =$ corresponds to 80%

$1000 \text{ mm/min} * 80\% = 800 \text{ mm/min}$

The feed rate to be entered = **800 mm/min.**

Angled ramping with solid carbide cutters

Angled ramping with solid carbide cutters is possible at an angle of 2° to 10° depending on the cutter type.

A protective edge chamfer or corner radius is an advantage.

Recommended ramping angles for solid carbide mills:

- ▲ Ramping angle with 3 or less cutting edges → 6° – 10°
- ▲ Ramping angle with 4 cutting edges → 3° – 6°
- ▲ Ramping angle with 5 cutting edges → 2° – 3°
- ▲ Ramping angle with more than 5 cutting edges → only possible under certain conditions!

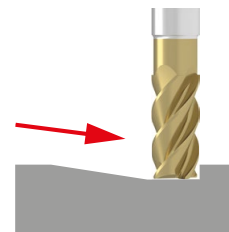

Preparation for T-slot milling cutter

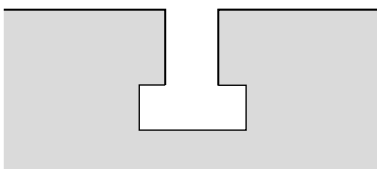

To produce a T-slot with the solid carbide T-slot milling cutter, proceed as follows:

1

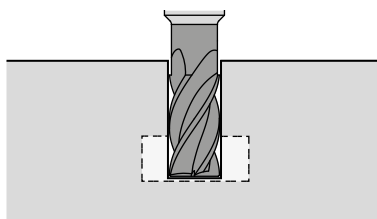

Rough-mill the slot up to approx. 0.5 mm above the bottom.
Bottom corresponds to the finished dimension of the T-slot.
The slot width should be milled to the finished dimension during this step.

2

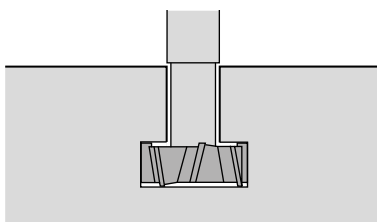

Then finish milling the slot with the T-slot milling cutter.
Reduce the feed by 50% when entering the material

General formula for calculating the cutting parameters

Designation	Abbreviation	Unit	Formula	Example	
Number of revolutions	n	min ⁻¹	$n = \frac{v_c \times 1000}{DC \times \pi}$	$v_c = 25 \text{ m/min}$ $DC = 20 \text{ mm}$	$n = \frac{25 \times 1000}{20 \times \pi} = 398 \text{ min}^{-1}$
Cutting speed	v_c	m/min	$v_c = \frac{DC \times \pi \times n}{1000}$	$n = 400 \text{ min}^{-1}$ $DC = 20 \text{ mm}$	$v_c = \frac{20 \times \pi \times 400}{1000} = 25 \text{ m/min}$
Feed per tooth	f_z	mm	$f_z = \frac{v_f}{Z \times n}$	$v_f = 320 \text{ mm/min.}$ $n = 400 \text{ min}^{-1}$ $Z = 4$	$f_z = \frac{320}{4 \times 400} = 0,2 \text{ mm}$
Feed per revolution	f	mm/rev.	$f = f_z \times Z$	$f_z = 0,2 \text{ mm}$ $Z = 4$	$f = 0,2 \times 4 = 0,8 \text{ mm}$
Feed rate	v_f	mm/min.	$v_f = f_z \times Z \times n$	$f_z = 0,2 \text{ mm}$ $Z = 4$ $n = 400 \text{ min}^{-1}$	$v_f = 0,2 \times 4 \times 400 = 320 \text{ mm/min.}$
Average chip thickness	h_m	mm	$h_m = f_z \times \sqrt{\frac{a_e}{DC}}$	$f_z = 0,2 \text{ mm}$ $a_e = 0,3 \text{ mm}$ $DC = 20 \text{ mm}$	$h_m = 0,2 \times \sqrt{\frac{0,3}{20}} = 0,024 \text{ mm}$

Z = Number of flutes
 a_e = cutting width

Calculation of the feed rate on the midpoint path of the milling cutter (v_{fM})

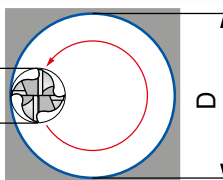
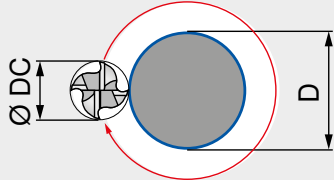
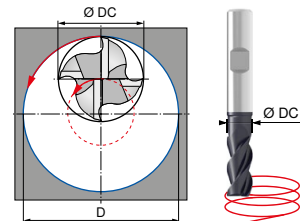
Designation	Abbreviation	Unit	Formula	Example
Internal contour	v_{fM}	mm/min.	$v_{fM} = \frac{v_f \times (D - DC)}{D}$	
Outside profile	v_{fM}	mm/min.	$v_{fM} = \frac{v_f \times (D + DC)}{D}$	
Helical ramping	v_{fM}	mm/min.	$v_{fM} = \frac{n \times f_z \times Z \times (D - D_c)}{D}$	

Assembly instructions

Image of MultiLock cylindrical shank adapter assembly

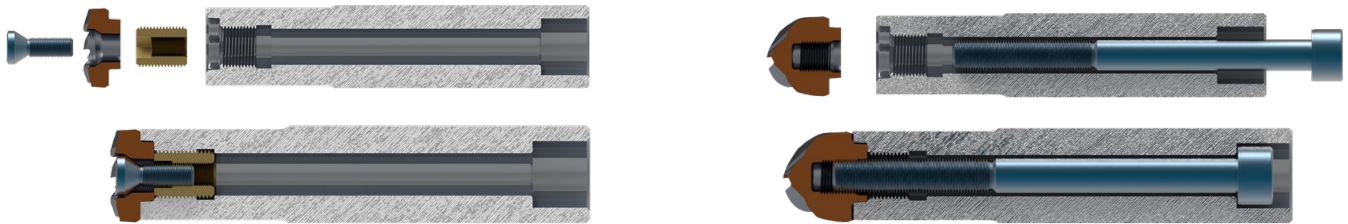

- ▲ The cylindrical shank adapter can be used universally. In this case, the MultiLock high-feed and torus cutters are clamped from the front using a threaded bush and clamping screw. The MultiLock radius milling and deburring cutters are clamped via the shank using a cylindrical screw.

Image of MultiLock screw-in adapter assembly

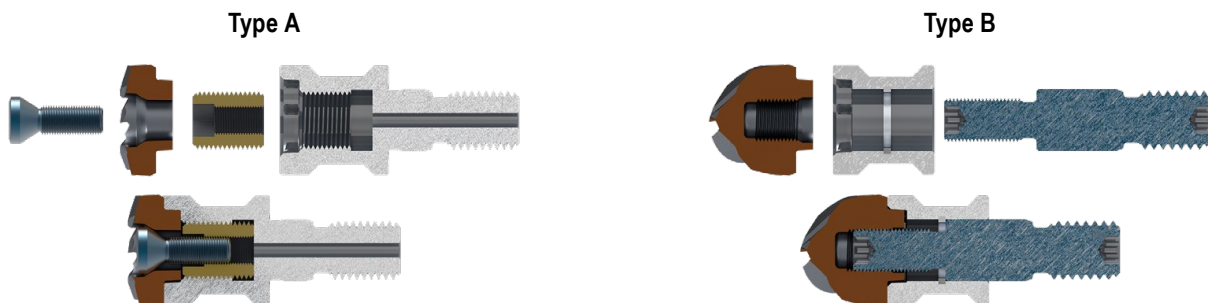

- ▲ The type A screw-in adapter must be used for MultiLock high-feed and torus cutters. These are clamped from the front using a threaded bush and clamping screw.
- ▲ The type B screw-in adapter has two parts and must be used for MultiLock radius milling and deburring cutters. These are tensioned from the rear using a clamping screw. The clamping screw is simultaneously used for screwing in the adapter.



Detailed assembly instructions are enclosed with the respective holders. You can also find this in our online shop.

Comparison – ball nose end milling cutters vs. 3D Finish

3D Finish

- ▲ Radius does not depend on the tool diameter
- ▲ High depths of cut possible owing to the large radius
- ▲ Tools with a large radius and small shank diameter are more economical as the carbide content is lower, e.g. diameter 16 mm, radius 1500 mm

Ball nose end milling cutters

- ▲ Radius depends on the tool diameter
- ▲ Only low widths of cut are possible; linked to the small radius
- ▲ Tools with a large diameter/radius are expensive due to the high carbide content, e.g. diameter 16 mm radius 8 mm

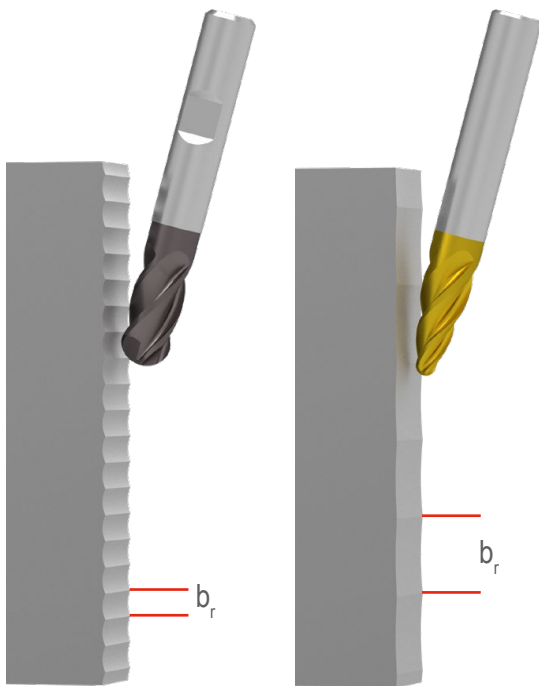

Formulae for calculations:

$$b_r = 2 \times \sqrt{R_{th} \times (r \times 2 - R_{th})}$$

$$R_{th} = r - \sqrt{\frac{(r \times 2)^2 - b_r^2}{4}}$$

$$R_a \approx 0,1 \times R_{th}$$

$$R_{th} \approx R_a / 0,1$$

Result

Required surface quality = R_a 0,4

$R_{th} \approx 0,4 / 0,1 \approx 4 \mu\text{m} = 0,004 \text{ mm}$

Ball nose end milling cutters

Diameter 16 mm, radius 8 mm

$$b_r = 2 \times \sqrt{0,004 \times (8 \times 2 - 0,004)}$$

$b_r = 0,51 \text{ mm}$



3D Finish

Diameter 16 mm, radius 1500 mm

$$b_r = 2 \times \sqrt{0,004 \times (1500 \times 2 - 0,004)}$$

$b_r = 6,93 \text{ mm}$

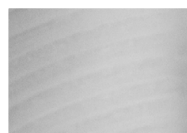

Key

R_{th} = Theoretical roughness

r = Radius

R_a = Average roughness

b_r = Step down

Application information

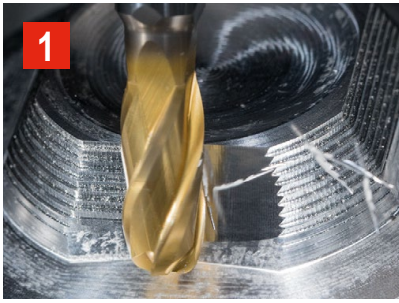

1

3D Finish – barrel shape

- ▲ Suitable for easily accessible areas



2

3D Finish – oval shape

- ▲ Suitable for easily accessible flanks
- ▲ Not suitable for deep areas

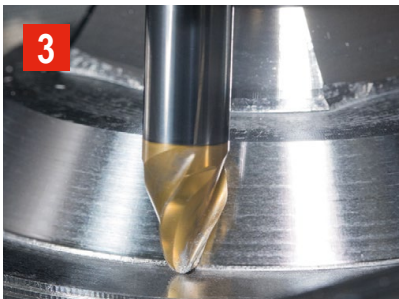

3

3D Finish – taper shape

- ▲ Suitable for steep walls and deep cavities
- ▲ $\alpha/2$ is the angle to the surface to be used
- ▲ If the surface exhibits a tilt angle of $\alpha/2$, the surface can also be machined on three axes

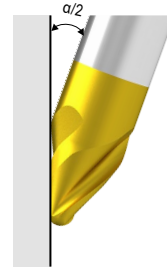

4

3D Finish – taper shape

- ▲ Suitable for flat areas
- ▲ $\alpha/2$ is the angle to the surface to be used
- ▲ If the surface exhibits a tilt angle of $\alpha/2$, the surface can also be machined on three axes

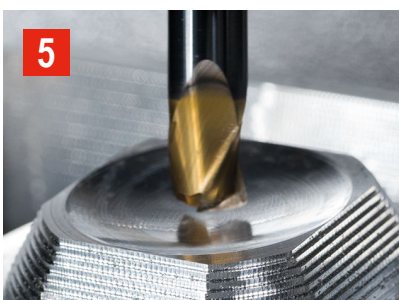
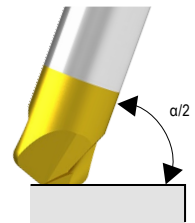

5

3D Finish – lens shape

- ▲ Suitable for flat areas

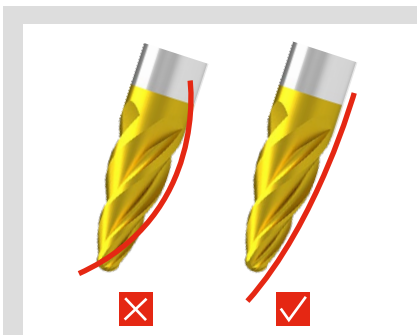





Please note:

Note that the curvature of the component should be greater than the curvature of the tool.

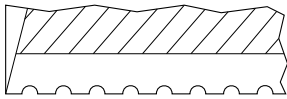
Check whether your programming system supports the tool geometry of the 3D Finish and can work with it.

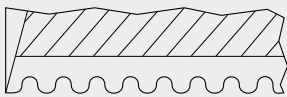
Differences between the milling cutter types

Designation	Type	Shape of the chip breaker	Application description	Chip shape
Rough and finish milling cutters	WF		<ul style="list-style-type: none"> ▲ High chip volume, even on less powerful machines ▲ Surface quality mostly sufficient ▲ Lower cutting pressure compared to smooth-edged milling cutters ▲ Finish machining not needed 	
	NF			
	HF			
Rough milling cutters	WR		<ul style="list-style-type: none"> ▲ Produces very small and short chips ▲ Problem-solver in unstable conditions ▲ High chip volume, even on the weakest machines ▲ Exceptionally well suited to full slot milling ▲ Additional finish machining needed ▲ High feeds possible 	
	NR			
	HR			

Temperature scale for chips when dry machining steel

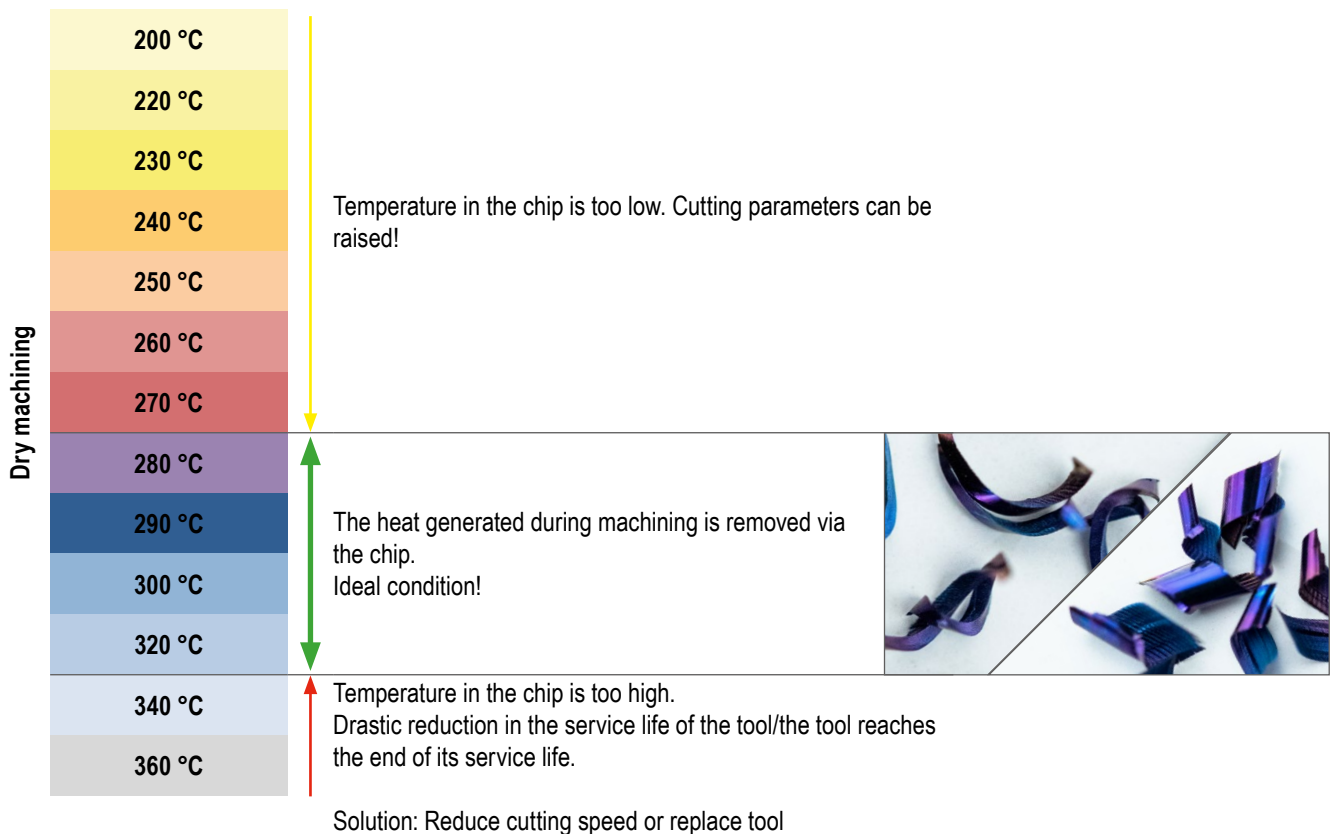

Tips for Tool Selection

Rake and helix angles combined with the coating are decisive factors for the operational area.

Characteristics	Benefits
Helix angle with slow spiral	
▲ For materials with high tensile strength	▲ High edge stability
▲ For high material removal rates	▲ Low tendency to edge chipping
▲ For slot milling, pocket milling, rough milling	
Helix angle with quick spiral	
▲ For soft steels, non ferrous metals, etc.	▲ Soft cut
▲ For low material removal rates	▲ Low cutting forces
▲ Typical for finishing processes	
Small rake angles are applied	
▲ For hard, brittle materials	▲ High edge stability
▲ For high material removal rates	▲ Low tendency to edge chipping
▲ For rough machining	
Large rake angles are applied	
▲ For soft materials	▲ Soft cut
▲ For low material removal rates	▲ Low cutting forces
▲ For finishing	▲ Favorable chip flow
	▲ Low tendency to stick

Correction factor for solid carbide milling cutters

Factors for cutting speed (v_c) and feed rate (f_z) in relation to the overhang length (LPR)

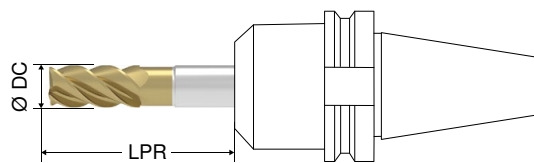

Length					
Overhang length (LPR)	1,5 x DC	4 x DC	8 x DC	12 x DC	> 12 x DC
Factor for v_c ($K_f v_c$)	1,0	1,0	0,9	0,85	0,7
Factor for f_z ($K_f f_z$)	1,2	1,0	0,8	0,7	0,5

Factors for cutting speed (v_c) and feed rate (f_z) in relation to the cutting depth (a_p) and cutting width (a_e)

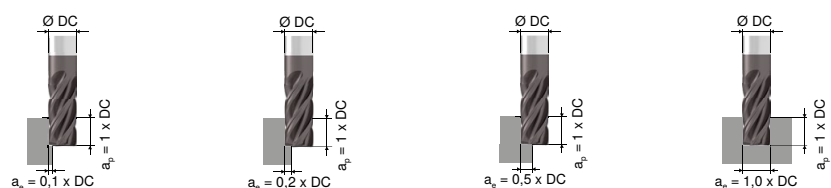

Factor for v_c ($K_f v_c$)	1,3	1,1	1,0	0,85
Factor for f_z ($K_f f_z$)	1,5	1,3	1,0	0,8

Calculation aid for copy milling

Theoretical surface roughness (R_{th}) and step over (b_r)

$$R_{th} = r - \sqrt{\frac{(r \times 2)^2 - b_r^2}{4}}$$

$$b_r = 2 \times \sqrt{R_{th} \times (r \times 2 - R_{th})}$$

$$R_{th} \approx R_a / 0,1$$

$$R_a \approx 0,1 \times R_{th}$$

When copy milling, in order to achieve as smooth a surface as possible, the step over b_r should be adapted to the cutter diameter DC.

The smaller the cutter diameter DC is, the smaller the step over b_r must be.

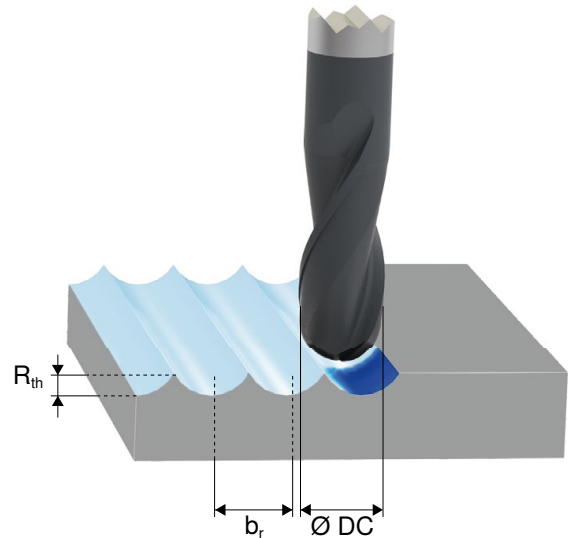

RPM correction factor ($K_f n$) for copy milling

$$n = \frac{v_c \times 1000}{DC \times \pi} \times K_f n$$

Rough machining

Peripheral and ball nose copy milling

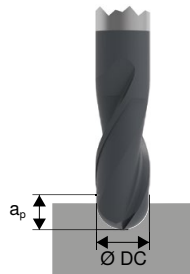

0,5 x DC

1 x DC

1

Ball nose copy milling

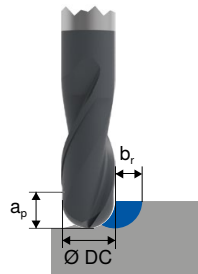

> 0,5 x DC

0,2 x DC – 0,5 x DC

1

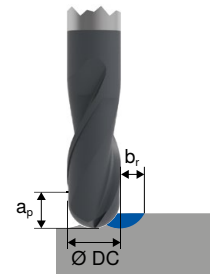

0,2 x DC – 0,5 x DC

0,2 x DC – 0,5 x DC

1,1

Axial milling depth a_p

Step over b_r

Correction factor ($K_f n$)

Ball nose copy milling

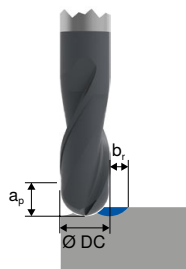

< 0,2 x DC

< 0,2 x DC

2

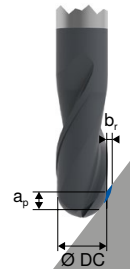

0,2 x DC – 0,5 x DC

< 0,2 x DC

1,3

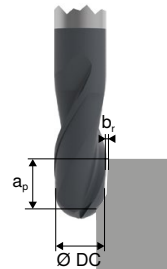

> 0,5 x DC

< 0,2 x DC

1

Finish milling

Axial milling depth a_p

Step over b_r

Correction factor ($K_f n$)

Calculation aid for copy milling

For peripheral milling or ball nosed copy milling at cutting depths of $a_p \geq 0.5 \times DC$ and $a_e = 0.2$ to $0.5 \times DC$ the rpm can be calculated with the following formula:

$$n = \frac{v_c \times 1000}{DC \times \pi}$$

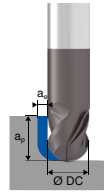

When ball milling the effective milling diameter $d_{eff.}$ must be determined using the following formula:

Ball nose milling cutters

$$d_{eff.} = 2 \times \sqrt{a_p \times (DC - a_p)}$$

$$d_{eff.} = DC \times \sin\left(\beta \pm \arccos\left(\frac{DC - 2a_p}{DC}\right)\right)$$

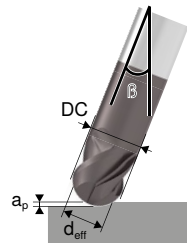
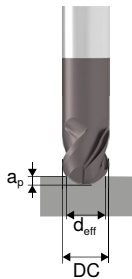

Torus end milling cutters

$$d_{eff.} = (DC - 2RE) + 2 \times \sqrt{a_p \times (2RE - a_p)}$$

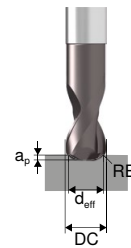

Information concerning plunge and draw milling

- ① When machining the profile flanks relatively high feed rates are possible as the cutting depth is relatively low (area highlighted in blue).
- ② A large increase in cutting depth occurs when the base of the profile is reached. Here the feed rate must be reduced as otherwise tool breakage can occur due to vibrations, misalignment or chattering.
- ③ As soon as the cutting depth decreases during the machining of the profile base, the feed rate can be increased again.

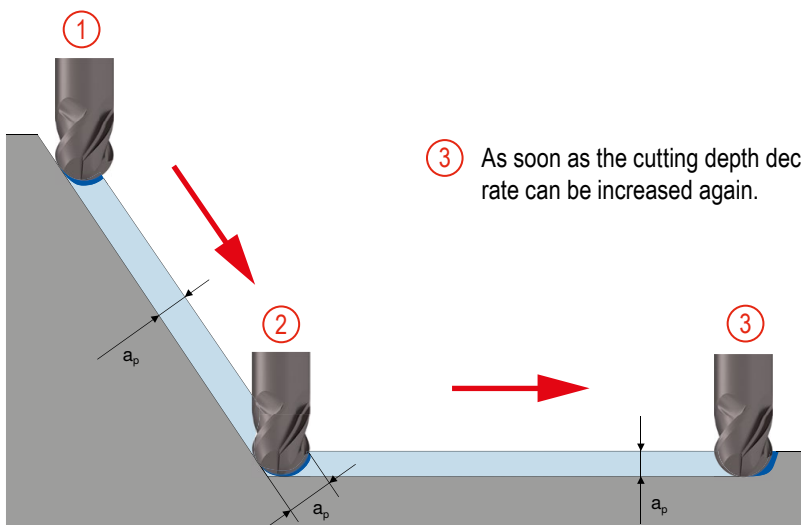

Rule:

The steeper the angle, the lower the feed rate. The shallower the angle, the larger the feed rate.

ⓘ When plunge or draw milling dies, the feed rate has to be adapted to the various milling positions. Otherwise the cutting edge can be damaged due to overload (vibrations, misalignment or chattering).

Version description

CCR AL	Circular Cutter – Non-ferrous metals	NR	For machining steel and cast materials, as well as stainless steels – with roughing profile
CCR H	Circular Cutter – Tempered steel	NTR	For machining steel and cast materials, as well as stainless steels – with trapezoidal chip breakers
CCR Ti	Circular Cutter – Heat-resistant alloys	SC UNI	Soft Cut – Universal
CCR UNI	Circular Cutter – Universal	SC NR	Soft Cut – with round cord profile
CCR VA	Circular Cutter – stainless steels	W	For soft materials and non-ferrous metals (aluminium, copper, brass)
H	For high-strength steels and tempered materials	WF	For soft materials and non-ferrous metals (aluminium, copper, brass) – with roughing-finishing profile
HR	For high-strength steels and tempered materials – with roughing profile	WR	For soft materials and non-ferrous metals (aluminium, copper, brass) – with roughing profile
N	For machining steel and cast materials, as well as stainless steels		

MonsterMill

FRP	Fibre Cutter	NCR	Nickel Alloy Cutter
FRP CR	Fibre cutter – with length-independent compression zone	PCR ALU	Plunging Cutter – Non-ferrous metals
HCR	Hard Cutter	PCR UNI	Plunging Cutter – Universal
ICR	Inox Cutter	SCR	Steel Cutter
MCR	Multi Cutter	TCR	Titanium Cutter

Deburring cutters

KEL	Round cone (shape L)	SPG	Ogival (shape G)
KSJ	Conical 60° (shape J)	TRE	Droplet (shape E)
KSK	Conical 90° (shape K)	WKN	Angular without spur gearing (shape N)
KUD	Spherical (shape D)	WRC	Round roller (shape C)
RBF	Round arch (shape F)	ZYA	Cylindrical without spur gearing (shape A)
SKM	Tapered cone (shape M)		

Coatings

APA72S	<ul style="list-style-type: none"> ▲ AlCrN multilayer coating ▲ $HV_{0.05} = 3500$ ▲ Coefficient of friction (against steel) = 0.35 ▲ Maximum application temperature: 1100 °C 	Ti28	<ul style="list-style-type: none"> ▲ Ti multilayer coating ▲ $HV_{0.05} = 2800$ ▲ Coefficient of friction (against steel) = 0.1 ▲ Maximum application temperature: 500 °C
APB72S	<ul style="list-style-type: none"> ▲ Special nanolayer coating ▲ $HV_{0.05} = 3300$ ▲ Coefficient of friction (against steel) = 0.6 ▲ Maximum application temperature: 900 °C 	Ti40	<ul style="list-style-type: none"> ▲ Ti monolayer coating ▲ $HV_{0.05} = 4000$ ▲ Maximum application temperature: 900 °C
APX72S	<ul style="list-style-type: none"> ▲ Special nanolayer coating ▲ $HV_{0.05} = 3800$ ▲ Coefficient of friction (against steel) = 0.4 ▲ Maximum application temperature: 1100 °C 	Ti400	<ul style="list-style-type: none"> ▲ Ti multilayer coating ▲ $HV_{0.05} = 3500$ ▲ Coefficient of friction (against steel) = 0.6 ▲ Maximum application temperature: 400 °C
CTC5240	<ul style="list-style-type: none"> ▲ TiB₂-based coating ▲ HIT 43 GPa ~ 4300 $HV_{0.05}$ ▲ Friction value against steel 0.3 ▲ Maximum application temperature 1000 °C 	Ti1000	<ul style="list-style-type: none"> ▲ Ti monolayer coating ▲ $HV_{0.05} = 3500$ ▲ Coefficient of friction (against steel) = 0.3 ▲ Maximum application temperature: 800 °C
CTPX225	<ul style="list-style-type: none"> ▲ AlTiN-based coating ▲ HIT 35 GPa ~ 3500 $HV_{0.05}$ ▲ Friction value against steel 0.5 ▲ Maximum application temperature 1000 °C 	Ti1001	<ul style="list-style-type: none"> ▲ Ti monolayer coating ▲ $HV_{0.05} = 3500$ ▲ Coefficient of friction (against steel) = 0.6 ▲ Maximum application temperature: 800 °C
DIAMOND	<ul style="list-style-type: none"> ▲ Diamond monolayer coating ▲ $HV_{0.025} = 10,000$ ▲ Coefficient of friction (against steel) = 0.2 ▲ Maximum application temperature: 700 °C 	Ti1050	<ul style="list-style-type: none"> ▲ Ti multilayer coating ▲ $HV_{0.005} = 3300$ ▲ Coefficient of friction (against steel) = 0.3-0.5 ▲ Maximum application temperature: 900 °C
DLC	<ul style="list-style-type: none"> ▲ Diamond-like carbon coating ▲ Specially for machining non-ferrous metals ▲ Maximum application temperature: 400 °C 	Ti1100	<ul style="list-style-type: none"> ▲ Ti multilayer coating ▲ $HV_{0.05} = 3200$ ▲ Coefficient of friction (against steel) = 0.35 ▲ Maximum application temperature: 1100 °C
DPA52S	<ul style="list-style-type: none"> ▲ Special nanolayer coating ▲ $HV_{0.05} = 3400$ ▲ Coefficient of friction (against steel) = 0.5 ▲ Maximum application temperature: 1100 °C 	Ti1200	<ul style="list-style-type: none"> ▲ Ti nanolayer coating ▲ Maximum application temperature: 1100-1200 °C
DPA72S	<ul style="list-style-type: none"> ▲ Special nanolayer coating ▲ $HV_{0.05} = 3200$ ▲ Coefficient of friction (against steel) = 0.5 ▲ Maximum application temperature: 1000 °C 	Ti1500	<ul style="list-style-type: none"> ▲ Ti nanolayer coating ▲ $HV_{0.05} = 3400$ ▲ Coefficient of friction (against steel) = 0.7 ▲ Maximum application temperature: 900 °C
DPB72S	<ul style="list-style-type: none"> ▲ TiAlCrN multilayer coating ▲ $HV_{0.05} = 3200$ ▲ Coefficient of friction (against steel) = 0.35 ▲ Maximum application temperature: 1000 °C 	Ti2000	<ul style="list-style-type: none"> ▲ Ti multilayer coating ▲ $HV_{0.05} = 3500$ ▲ Coefficient of friction (against steel) = 0.5 ▲ Maximum application temperature: 900 °C
DPX22S	<ul style="list-style-type: none"> ▲ TiSiXN multilayer coating ▲ Layer hardness: H_{IT} [GPa] 38 ▲ Maximum application temperature: 1100 °C 		
DPX52S	<ul style="list-style-type: none"> ▲ TiSiN multilayer coating ▲ $HV_{0.05} = 3500$ ▲ Coefficient of friction (against steel) = 0.4 ▲ Maximum application temperature: 1000 °C 		
DPX62S	<ul style="list-style-type: none"> ▲ TiAlN multilayer coating ▲ $HV_{0.05} = 3800$ ▲ Coefficient of friction (against steel) = 0.4 ▲ Maximum application temperature: 800 °C 		
DPX62U	<ul style="list-style-type: none"> ▲ Special TiAlN coating ▲ $HV_{0.05} = 4000$ ▲ Coefficient of friction (against steel) = 0.5 ▲ Maximum application temperature: 1150 °C 		
DPX72S	<ul style="list-style-type: none"> ▲ Special multilayer coating ▲ $HV_{0.05} = 3400$ ▲ Coefficient of friction (against steel) = 0.6 ▲ Maximum application temperature: 900 °C 		

