

New products for machining technicians

NEW WPC – Change



≤ 3xD

≤ 5xD

- ▲ The new modular WPC Change drilling system with replaceable cutting heads and thro' coolant enables cost-effective machining of even large holes with the performance of solid carbide drills. The drilling system is also characterised by its easy handling.



- ▲ Replaceable cutting head type UNI with wear-resistant TPX74S coating for usage on steel and cast iron materials.

→ Page [104+105](#)



Solid drilling and bore machining

1 HSS drilling

2 Solid carbide drilling

3 Indexable insert drilling

4 Reaming and Countersinking

5 Spindle Tooling

6 Taps and thread formers

Threading

7 Circular and Thread Milling

8 Thread turning

9 Turning Tools

Turning

10 Multifunctional Tools – EcoCut and FreeTurn

11 Grooving Tools

12 Miniature turning tools

13 HSS Milling Cutters

Milling

14 Solid Carbide milling cutters

15 Milling tools with indexable inserts

Clamping technology

16 Adaptors and Accessories

17 Workpiece clamping

18 Material examples and article no. Index

Table of contents

Symbol explanation	4
Toolfinder	5-7
List of contents	8-12
Product programme	13-107
Technical Information:	
Cutting Data	108-157
Type overview	158
Application notes: WTX drill, WTX – Change / WPC Change, WPC – Change, deep hole twist and micro drill	159-164
Coatings	165

WNT \ Performance

Premium quality tools for high performance.

The premium quality tools from the **WNT Performance** product line have been designed for specific applications and are distinguished by their outstanding performance. If you make high demands on the performance of your production and want to achieve the very best results, we recommend the Premium tools in this product line.

WNT \ Standard

Quality tools for standard applications.

The quality tools of the **WNT Standard** product line are high quality, powerful and reliable and enjoy the highest trust of our customers worldwide. Tools from this product line are the first choice for many standard applications and guarantee optimal results.

Symbol explanation

Shank

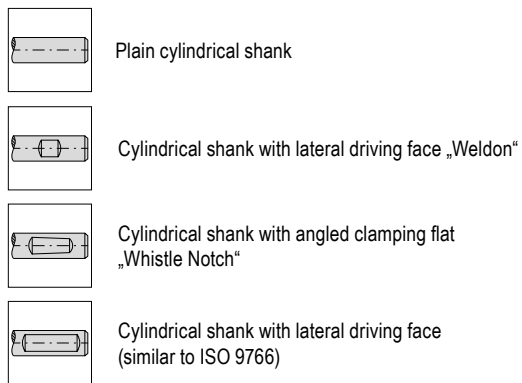

Tool types

HFDS An explanation of the tool types can be found on → **Page 158**.

Version

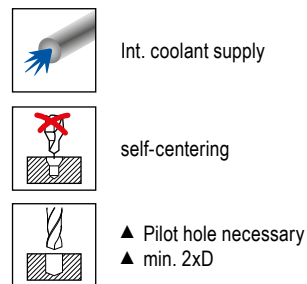











- = Main Application
- = Extended application



Recommended application – WTX Performance Tools

● = Main Application
○ = Extended application

WTX – Type		Solid drilling	Flat bottom hole	High-feed machining	High speed machining	Stack plate drilling	Drilling through a transverse hole	Angled hole entrance	Angled drill exit	Drilling a precise fit	deep holes	miniature holes
												
Monobloc Tool	WTX – UNI	●				●	●					
	WTX – Speed UNI	●			●	●						
	WTX – HFDS	●		●		●	●					
	WTX – Feed UNI	●		●		●	●	●	●			
	WTX – Speed VA	●			●							
	WTX – VA	●										
	WTX – Ti	●					●					
	WTX – AL	●										
	WTX – 180	●	●				●	●	●			
	WTX – Quattro 4F	●							○			
	WTX – Feed BR	●		●		○	○	○	○	●		
	WTX – H	●										
	WTX – TB	●									●	
	WTX – Micro	●									●	●
	WTX – Mini	●										●
Modular	WTX – Change Feed UNI	●		●				●	●			
	WTX – Change Drill heads	●										

Coolant diagram

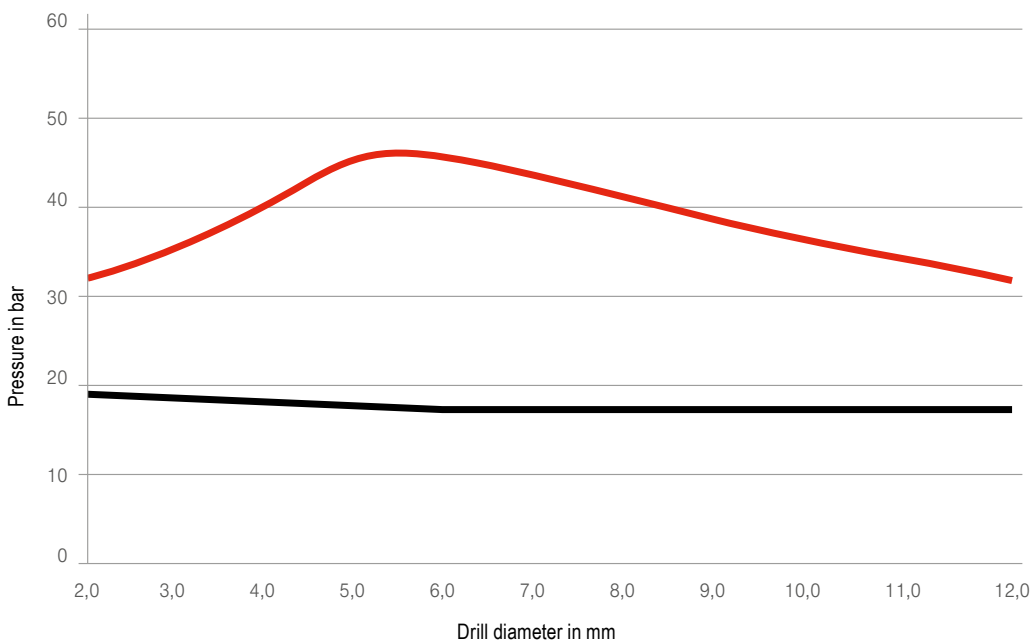

— Recommended coolant pressure
— Minimum coolant Pressure

 Additional application criteria for WTX drills can be found on → [page 159](#).

Toolfinder

Product name	Tool type	Description	Int. coolant supply	Replaceable cutting heads	1xD	3xD	5xD	8xD	12xD	Video
Solid carbide drilling										
WTX	UNI	▲ highest performance for all materials up to 1200 N/mm ² ▲ suitable for volume production	✗ ✓			13-17 24-27	36-39 42-46	60-63		▶
	UNI	▲ Quality tool for standard applications ▲ Attractive price-performance ratio	✗ ✓			18-21 28-31	40 51-54	64	72	▶
WTX	Speed UNI	▲ High-performance drill for high cutting speeds ▲ Innovative DPX14S Dragonskin ▲ New cutting edge geometry	✓			24-27	42-46	60-63		▶
WTX	HFDS	▲ High-feed drill with four cutting edges ▲ Innovative cutting edge geometry enables maximum positioning accuracy ▲ Optimal cooling with four spiral coolant holes	✓			35	59			▶
WTX	Feed UNI	▲ High-feed drill with three cutting edges ▲ Suitable for difficult drilling applications ▲ High positioning accuracy	✓				58	68	73	▶
WTX	Quattro 4F	▲ with additional guide land for best alignment accuracy, concentricity and positional accuracy	✓				42-46	60-63	69-71	
WTX	180	▲ for inclined surfaces up to 45° and flat bottom holes	✓			34	57			
	N	▲ uncoated solid carbide drills ▲ universal application	✗			23	41			
Mini-drill										
WTX	MINI	▲ Available from Ø 0.1 mm ▲ Standard shank Ø 3.0 mm for use in heat shrink adapters	✗				78			
WTX	MICRO	▲ Universal high-performance micro drill ▲ Specialised geometry and coating ▲ WTX – Micro (5xD) pilot drill for deep hole twist drill	✓				79	79	80	▶
Drill Reamers										
WTX	Feed BR/BR100	▲ solid carbide high performance drill reamer ▲ excellent surface quality ▲ for blind and through holes	✓			83+85	84+85			
Stepped drills										
WTX	SB	▲ Solid carbide short step drill for core hole plus countersink for thread cutting and thread forming	✗ ✓			86 87				
NC Spot Drill										
	NC-A	▲ spiral fluted ▲ 90°, 120°, 142°	✗		88+89					
Centre drills										
	ZB	▲ spiral fluted ▲ 120°	✗		90					
Drill with replaceable cutting heads										
WTX	Change Feed UNI	▲ three-edged exchangeable head drill with solid carbide drill head type Feed UNI from Ø 14.0 mm to 32.0 mm ▲ universal application (steel, cast iron)	✓	91+92	93	93	94			▶
WTX	Change UNI	▲ exchangeable head drill with type UNI solid carbide drill head from Ø 12.0 mm to 41.0 mm ▲ for steels <700 N/mm ²	✓	95-100	101	101	102	102	103	▶
WTX	Change P	▲ exchangeable head drill with type P solid carbide drill head from Ø 12.0 mm to 41.0 mm ▲ for steels >700 N/mm ²	✓	95-100	101	101	102	102	103	▶
WPC	Change UNI	▲ Indexable insert drill with solid carbide indexable insert type UNI from Ø 14.0 to 30.0 mm ▲ Universal application on steel and cast iron materials	✓	104	105	105				
Exchangeable head NC spot drill										
	NC-A	▲ NC spot drill – exchange head system ▲ 90°, 120°, 142°	✗	107						

✗ = without through coolant

✓ = with thro' coolant

Toolfinder

	Product name	Tool type	Description	Int. coolant supply	Replaceable cutting heads	1xD	3xD	5xD	8xD	12xD	Video
Solid carbide drilling											
Stainless steel	WTX	VA	<ul style="list-style-type: none"> ▲ highest performance for corrosion and acid resistant steels and aluminium ▲ for volume production 	✗		13-17	36-39				
				✓		24-27	47-50	65-67			
		VA	<ul style="list-style-type: none"> ▲ Quality tool for corrosion-resistant and acid-resistant steels and aluminium ▲ Attractive price-performance ratio 	✗		18-21					
				✓		28-31	51-54				
	WTX	Speed VA	<ul style="list-style-type: none"> ▲ double the cutting speed in corrosion and acid-resistant steels and aluminium 	✓			47-50			69-71	
Drill with replaceable cutting heads											
	WTX	Change VA	<ul style="list-style-type: none"> ▲ exchangeable head drill with solid carbide drill head type VA from Ø 12.0 mm to 32.0 mm 	✓	95-100	101	101	102	102	103	▶
Solid carbide drilling											
Cast iron	WTX	UNI	<ul style="list-style-type: none"> ▲ highest performance for all materials up to 1200 N/mm² ▲ suitable for volume production 	✗		13-17	36-39				▶
				✓		24-27	42-46	60-63			
Drill with replaceable cutting heads											
	WTX	Change GG	<ul style="list-style-type: none"> ▲ exchangeable head drill with solid carbide drill head type GG from Ø 12.0 mm to 32.0 mm 	✓	95-100	101	101	102	102	103	▶
Solid carbide drilling											
Non-ferrous metals	WTX	AL	<ul style="list-style-type: none"> ▲ solid carbide high performance drill, especially for the machining of aluminum, copper and brass ▲ for volume production 	✓			47-50	65-67	69-71		
	Drill with replaceable cutting heads										
	WTX	Change AL	<ul style="list-style-type: none"> ▲ exchangeable head drill with solid carbide drill head type AL from Ø 12.0 mm to 32.0 mm 	✓	95-100	101	101	102	102	103	▶
Solid carbide drilling											
Heat-resistant	WTX	Ti	<ul style="list-style-type: none"> ▲ highest performance in titanium, titanium alloys and heat resistant alloys 	✓		32+33	55+56				
Solid carbide drilling											
Tempered steel	WTX	H	<ul style="list-style-type: none"> ▲ highest performance in hardened steel from 46 to 70 HRC 	✗		22					▶
Deep Hole Drills											
	Product name	Tool type	Description	Int. coolant supply	16xD	20xD	25xD	30xD	40xD	50xD	Video
Steel/Universal	WTX	MICRO	<ul style="list-style-type: none"> ▲ Available from Ø 0.8 mm ▲ Universal high-performance micro deep hole twist drill ▲ Specialised geometry and coating ▲ Hole depths up to 30xD possible 	✓	80	81	81	82			▶
	WTX	CP 20 UNI	<ul style="list-style-type: none"> ▲ Ensures an even safer deep hole drilling process ▲ Excellent alignment precision ▲ For optimal guidance of the deep hole twist drill for hole depths > 30xD 	✓		74					
	WTX	TB UNI	<ul style="list-style-type: none"> ▲ solid carbide deep hole drill to 50xD without peck ▲ 4 facet geometry for excellent alignment accuracy 	✓	75	75	76	76	77	77	
Non-ferrous metals	WTX	TB ALU	<ul style="list-style-type: none"> ▲ solid carbide deep hole drills, up to 30xD without pecking ▲ 6-facet head geometry for excellent alignment accuracy 	✓	75	75	76	76			

✗ = without through coolant ✓ = with thro' coolant

Overview Solid Carbide Drills

Product name	Tool type	Boring depth	Diameter in mm Ø DC	Material compatibility	Coating	Performance	Standard	
				Steel (P) Stainless steel (M) Cast iron (K) Non-ferrous metals (N) Heat-resistant (S) Tempered steel (H) Non metal materials (O)	<input checked="" type="checkbox"/> coated <input type="checkbox"/> uncoated	WNT / Performance WNT / Standard	Page No.	
3xD without thro' coolant								
	WTX	UNI	≤ 3xD	3-25	<input checked="" type="checkbox"/>			13-17
	WTX	VA	≤ 3xD	2-20	<input checked="" type="checkbox"/>			13-17
		UNI	≤ 3xD	1-20	<input checked="" type="checkbox"/>			18-21
		VA	≤ 3xD	1-20	<input checked="" type="checkbox"/>			18-21
	WTX	H	≤ 3xD	2,55-14	<input checked="" type="checkbox"/>	up to 70 HRC		22
		N	≤ 3xD	0,5-20	<input type="checkbox"/>			23
3xD with thro' coolant								
	WTX	Speed UNI	≤ 3xD	3-20	<input checked="" type="checkbox"/>			24-27
	WTX	UNI	≤ 3xD	3-25	<input checked="" type="checkbox"/>			24-27
	WTX	VA	≤ 3xD	3-20	<input checked="" type="checkbox"/>			24-27
		UNI	≤ 3xD	1-20	<input checked="" type="checkbox"/>			28-31
		VA	≤ 3xD	1-20	<input checked="" type="checkbox"/>			28-31
	WTX	Ti	≤ 3xD	3-20	<input checked="" type="checkbox"/>			32+33
	WTX	180	≤ 3xD	3-20	<input checked="" type="checkbox"/>	180° Point angle		34
	WTX	HFDS	≤ 3xD	6-16	<input checked="" type="checkbox"/>	4 flute		35
5xD without thro' coolant								
	WTX	UNI	≤ 5xD	3-20	<input checked="" type="checkbox"/>			36-39
	WTX	VA	≤ 5xD	3-20	<input checked="" type="checkbox"/>			36-39
		UNI	≤ 5xD	3-20	<input checked="" type="checkbox"/>			40
		N	≤ 5xD	0,5-16	<input type="checkbox"/>			41

Overview Solid Carbide Drills

Product name	Tool type	Boring depth	Diameter in mm Ø DC	Material compatibility	Coating	Performance	Standard
				Steel Stainless steel Cast iron Non-ferrous metals Heat-resistant Tempered steel Non metal materials	<input checked="" type="checkbox"/> coated <input type="checkbox"/> uncoated	WNT / Performance WNT / Standard	Page No.
5xD with thro' coolant							
	WTX	Speed UNI	≤ 5xD	3-18	<input checked="" type="checkbox"/>		42-46
	WTX	UNI	≤ 5xD	3-25	<input checked="" type="checkbox"/>		42-46
	WTX	Quattro 4F	≤ 5xD	3-18	<input checked="" type="checkbox"/>		42-46
	WTX	Speed VA	≤ 5xD	3-20	<input checked="" type="checkbox"/>		47-50
	WTX	VA	≤ 5xD	3-20	<input checked="" type="checkbox"/>		47-50
	WTX	AL	≤ 5xD	2,5-20	<input checked="" type="checkbox"/>		47-50
		UNI	≤ 5xD	1-20	<input checked="" type="checkbox"/>		51-54
		VA	≤ 5xD	1-20	<input checked="" type="checkbox"/>		51-54
	WTX	Ti	≤ 5xD	3-20	<input checked="" type="checkbox"/>		55+56
	WTX	180	≤ 5xD	3-20	<input checked="" type="checkbox"/>	180° Point angle	57
	WTX	Feed UNI	≤ 5xD	4-20	<input checked="" type="checkbox"/>	3 flute	58
	WTX	HFDS	≤ 5xD	6-16	<input checked="" type="checkbox"/>	4 flute	59
8xD with thro' coolant							
	WTX	Speed UNI	≤ 8xD	3-18	<input checked="" type="checkbox"/>		60-63
	WTX	UNI	≤ 8xD	3-20	<input checked="" type="checkbox"/>		60-63
	WTX	Quattro 4F	≤ 8xD	3-18	<input checked="" type="checkbox"/>		60-63
		UNI	≤ 8xD	3-20	<input checked="" type="checkbox"/>		64
	WTX	VA	≤ 8xD	3-20	<input checked="" type="checkbox"/>		65-67
	WTX	AL	≤ 8xD	3-20	<input checked="" type="checkbox"/>		65-67
	WTX	Feed UNI	≤ 8xD	4-20	<input checked="" type="checkbox"/>	3 flute	68











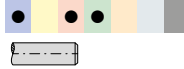

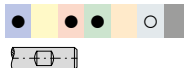

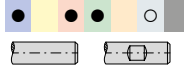













Overview Solid Carbide Drills

	Product name	Tool type	Boring depth	Diameter in mm Ø DC		<input checked="" type="checkbox"/> coated <input type="checkbox"/> uncoated	WNT / Performance WNT / Standard	Page No.
12xD with thro' coolant								
	WTX	Speed VA	≤ 12xD	3-17,5		<input checked="" type="checkbox"/>		69-71
	WTX	Quattro 4F	≤ 12xD	3-18		<input checked="" type="checkbox"/>		69-71
	WTX	AL	≤ 12xD	3-20		<input checked="" type="checkbox"/>		69-71
		UNI	≤ 12xD	3-20		<input checked="" type="checkbox"/>		72
	WTX	Feed UNI	≤ 12xD	4-20		<input checked="" type="checkbox"/>	3 flute	73
Deep hole twist drill 16xD to 50xD								
	WTX	CP 20 UNI	≤ 20xD	3-9		<input checked="" type="checkbox"/>	Co-pilot drill	74
	WTX	TB UNI	≤ 16xD ≤ 20xD	2-12		<input checked="" type="checkbox"/>		75
	WTX	TB UNI	≤ 25xD ≤ 30xD	2-12		<input checked="" type="checkbox"/>		76
	WTX	TB UNI	≤ 40xD	3-9		<input checked="" type="checkbox"/>		77
	WTX	TB UNI	≤ 50xD	3-6,8		<input checked="" type="checkbox"/>		77
	WTX	TB ALU	≤ 16xD ≤ 20xD	2-12		<input checked="" type="checkbox"/>		75
	WTX	TB ALU	≤ 25xD ≤ 30xD	2-12		<input checked="" type="checkbox"/>		76

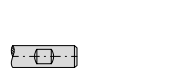
Overview Solid Carbide Drills

Product name	Tool type	Boring depth	Diameter in mm Ø DC	Material compatibility	Coating	Performance	Standard	
				Steel (P) Stainless steel (M) Cast iron (K) Non-ferrous metals (N) Heat-resistant (S) Tempered steel (H) Non metal materials (O)	<input checked="" type="checkbox"/> coated <input type="checkbox"/> uncoated	WNT / Performance WNT / Standard	Page No.	
Micro drill 5xD to 30xD								
	WTX	MINI	≤ 5xD	0,1–2,9	<input type="checkbox"/>			78
	WTX	MICRO	≤ 5xD	0,8–2,9	<input checked="" type="checkbox"/>	with thro' coolant		79
	WTX	MICRO	≤ 8xD	0,8–2,9	<input checked="" type="checkbox"/>	with thro' coolant		79
	WTX	MICRO	≤ 12xD	0,8–2,9	<input checked="" type="checkbox"/>	with thro' coolant		80
	WTX	MICRO	≤ 16xD	0,8–2,9	<input checked="" type="checkbox"/>	with thro' coolant		80
	WTX	MICRO	≤ 20xD	0,8–2,9	<input checked="" type="checkbox"/>	with thro' coolant		81
	WTX	MICRO	≤ 25xD	0,8–2,9	<input checked="" type="checkbox"/>	with thro' coolant		81
	WTX	MICRO	≤ 30xD	0,8–2,9	<input checked="" type="checkbox"/>	with thro' coolant		82
Drill Reamers								
	WTX	Feed BR100	≤ 3xD ≤ 5xD	3,97 12,02	<input checked="" type="checkbox"/>	1/100 3 flute		83+84
	WTX	Feed BR	≤ 3xD	4–16	<input checked="" type="checkbox"/>	Tolerance H7 3 flute		85
	WTX	Feed BR	≤ 5xD	4–20	<input checked="" type="checkbox"/>	Tolerance H7 3 flute		85
Stepped drills								
	WTX	SB		2,5–14	<input checked="" type="checkbox"/>	Thread cutting		86
	WTX	SB		2,8–15	<input checked="" type="checkbox"/>	Thread forming		86
	WTX	SB		3,3–14	<input checked="" type="checkbox"/>	Thread cutting with thro' coolant		87
	WTX	SB		3,7–15	<input checked="" type="checkbox"/>	Thread forming with thro' coolant		87

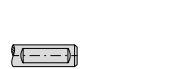
Overview Solid Carbide Drills

Product name	Tool type	Point angle	Diameter in mm	Material compatibility	Coating	Performance	Standard
SIG	Ø DC	90° 120° 142°	Steel Stainless steel Cast iron Non-ferrous metals Heat-resistant Tempered steel Non metal materials	coated uncoated	WNT / Performance WNT / Standard	Page No.	
NC Spot Drill							
	NC-A	90° 120° 142°	2-20		<input type="checkbox"/>		88
	NC-A	90° 120° 142°	2-20		<input checked="" type="checkbox"/>		88
	NC-A	90° 120° 142°	3-16		<input checked="" type="checkbox"/>	long version	89
Centre drills							
	ZB	120°	0,5-6,3		<input type="checkbox"/>		90
Drill with replaceable cutting heads							
Replaceable cutting heads							
	WTX	Change Feed	14-32		<input checked="" type="checkbox"/>	3 Edges	91+92
	WTX	Change UNI	12-41		<input checked="" type="checkbox"/>		95-100
	WTX	Change P	12-41		<input checked="" type="checkbox"/>		95-100
	WTX	Change VA	12-32		<input checked="" type="checkbox"/>		95-100
	WTX	Change GG	12-32		<input checked="" type="checkbox"/>		95-100
	WTX	Change ALU	12-32		<input checked="" type="checkbox"/>		95-100
	WPC	Change UNI	14-30		<input checked="" type="checkbox"/>		104
Tool holder							
	WTX	Change Feed	14-32			3xD / 5xD / 8xD	93+94
	WTX	Change	12-41			1xD / 3xD / 5xD / 8xD / 12xD	101-103
	WPC	Change	14-30			3xD / 5xD	105
MultiChange NC spot drill							
	NC-A	90° 120° 142°	8-20		<input checked="" type="checkbox"/>		107

WTX – High Performance Drill, DIN 6537

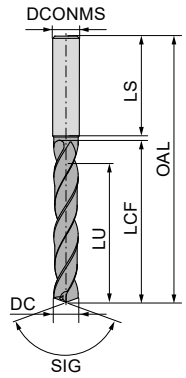
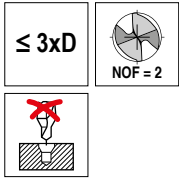

	UNI DPX74S DRAGONSKIN	UNI DPX74S DRAGONSKIN	UNI DPX74S DRAGONSKIN	VA Ti700
	SIG 140° Solid carbide	SIG 140° Solid carbide	SIG 140° Solid carbide	SIG 140° Solid carbide
	11 777 ...	11 778 ...	11 776 ...	10 731 ...
2,00				020
2,10				021
2,20				022
2,30				023
2,33				823
2,40				024
2,43				824
2,50				025
2,55				825
2,60				026
2,62				826
2,70				027
2,80				028
2,90				029
3,00	03000	03000	03000	030
3,10	03100	03100	03100	031
3,15	03150	03150	03150	831
3,20	03200	03200	03200	032
3,22	03220	03220	03220	832
3,25	03250	03250	03250	890
3,30	03300	03300	03300	033
3,40	03400	03400	03400	034
3,50	03500	03500	03500	035
3,60	03600	03600	03600	036
3,70	03700	03700	03700	037
3,80	03800	03800	03800	038
3,85	03850	03850	03850	838
3,90	03900	03900	03900	039
4,00	04000	04000	04000	040
4,10	04100	04100	04100	041
4,20	04200	04200	04200	042
4,25	04250	04250	04250	
4,30	04300	04300	04300	043
4,35	04350	04350	04350	843
4,40	04400	04400	04400	044
4,45	04450	04450	04450	844
4,50	04500	04500	04500	045
4,60	04600	04600	04600	046
4,65	04650	04650	04650	900
4,70	04700	04700	04700	047
4,80	04800	04800	04800	048
P	●	●	●	○
M				●
K	●	●	●	○
N				○
S				●
H	○	○	○	
O				

WTX – High Performance Drill, DIN 6537

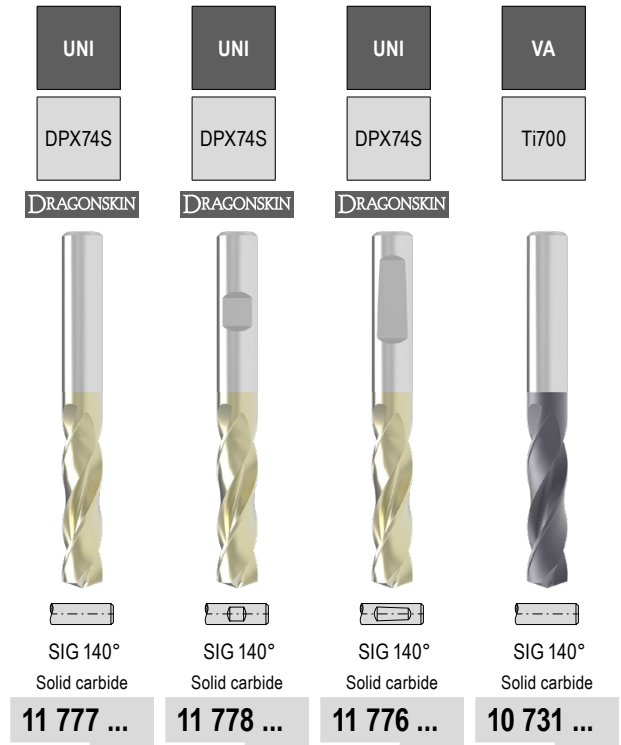
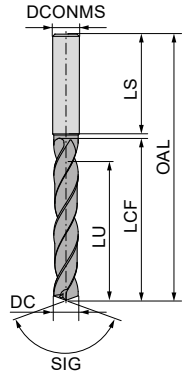
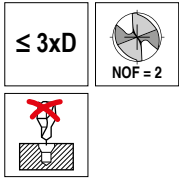

DC _{m7} mm	DCONMS _{h6} mm	OAL mm	LCF mm	LU mm	LS mm	11 777 ...	11 778 ...	11 776 ...	10 731 ...
4,90	6	66	28	20	36	04900	04900	04900	049
4,95	6	66	28	20	36	04950	04950	04950	
5,00	6	66	28	20	36	05000	05000	05000	050
5,05	6	66	28	20	36	05050	05050	05050	
5,10	6	66	28	20	36	05100	05100	05100	051
5,20	6	66	28	20	36	05200	05200	05200	052
5,30	6	66	28	20	36	05300	05300	05300	053
5,40	6	66	28	20	36	05400	05400	05400	054
5,50	6	66	28	20	36	05500	05500	05500	055
5,55	6	66	28	20	36	05550	05550	05550	092
5,60	6	66	28	20	36	05600	05600	05600	056
5,70	6	66	28	20	36	05700	05700	05700	057
5,75	6	66	28	20	36	05750	05750	05750	916
5,80	6	66	28	20	36	05800	05800	05800	058
5,90	6	66	28	20	36	05900	05900	05900	059
5,95	6	66	28	20	36	05950	05950	05950	959
6,00	6	66	28	20	36	06000	06000	06000	060
6,10	8	79	34	24	36	06100	06100	06100	061
6,20	8	79	34	24	36	06200	06200	06200	062
6,30	8	79	34	24	36	06300	06300	06300	063
6,40	8	79	34	24	36	06400	06400	06400	064
6,50	8	79	34	24	36	06500	06500	06500	065
6,60	8	79	34	24	36	06600	06600	06600	066
6,70	8	79	34	24	36	06700	06700	06700	067
6,80	8	79	34	24	36	06800	06800	06800	068
6,90	8	79	34	24	36	06900	06900	06900	069
7,00	8	79	34	24	36	07000	07000	07000	070
7,10	8	79	41	29	36	07100	07100	07100	071
7,20	8	79	41	29	36	07200	07200	07200	072
7,30	8	79	41	29	36	07300	07300	07300	073
7,40	8	79	41	29	36	07400	07400	07400	074
7,45	8	79	41	29	36	07450	07450	07450	924
7,50	8	79	41	29	36	07500	07500	07500	075
7,60	8	79	41	29	36	07600	07600	07600	076
7,70	8	79	41	29	36	07700	07700	07700	077
7,80	8	79	41	29	36	07800	07800	07800	078
7,90	8	79	41	29	36	07900	07900	07900	079
8,00	8	79	41	29	36	08000	08000	08000	080
8,10	10	89	47	35	40	08100	08100	08100	081
8,20	10	89	47	35	40	08200	08200	08200	082
8,30	10	89	47	35	40	08300	08300	08300	083
P						●	●	●	○
M									●
K						●	●	●	○
N									○
S									●
H						○	○	○	
O									

WTX – High Performance Drill, DIN 6537

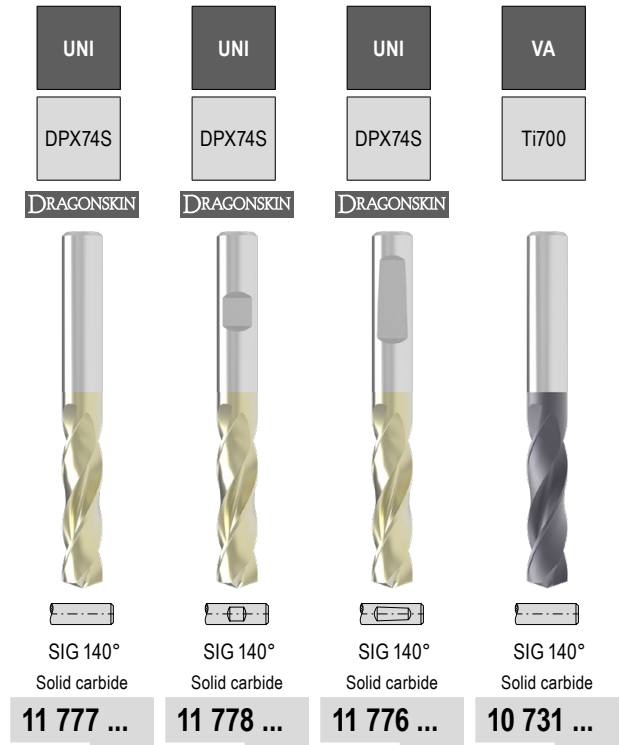
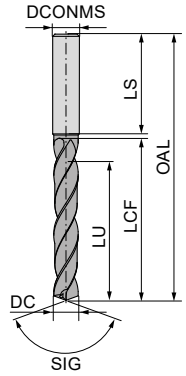
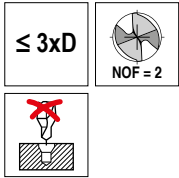

DC _{m7} mm	DCONMS _{h6} mm	OAL mm	LCF mm	LU mm	LS mm	11 777 ...	11 778 ...	11 776 ...	10 731 ...
8,40	10	89	47	35	40	08400	08400	08400	084
8,50	10	89	47	35	40	08500	08500	08500	085
8,60	10	89	47	35	40	08600	08600	08600	086
8,70	10	89	47	35	40	08700	08700	08700	087
8,80	10	89	47	35	40	08800	08800	08800	088
8,90	10	89	47	35	40	08900	08900	08900	089
9,00	10	89	47	35	40	09000	09000	09000	090
9,10	10	89	47	35	40	09100	09100	09100	091
9,20	10	89	47	35	40	09200	09200	09200	092
9,30	10	89	47	35	40	09300	09300	09300	093
9,35	10	89	47	35	40	09350	09350	09350	930
9,40	10	89	47	35	40	09400	09400	09400	094
9,45	10	89	47	35	40	09450	09450	09450	994
9,50	10	89	47	35	40	09500	09500	09500	095
9,60	10	89	47	35	40	09600	09600	09600	096
9,70	10	89	47	35	40	09700	09700	09700	097
9,80	10	89	47	35	40	09800	09800	09800	098
9,90	10	89	47	35	40	09900	09900	09900	099
10,00	10	89	47	35	40	10000	10000	10000	100
10,10	12	102	55	40	45	10100	10100	10100	101
10,20	12	102	55	40	45	10200	10200	10200	102
10,30	12	102	55	40	45	10300	10300	10300	103
10,40	12	102	55	40	45	10400	10400	10400	104
10,50	12	102	55	40	45	10500	10500	10500	105
10,55	12	102	55	40	45	10550	10550	10550	932
10,60	12	102	55	40	45	10600	10600	10600	106
10,70	12	102	55	40	45	10700	10700	10700	107
10,75	12	102	55	40	45	10750	10750	10750	
10,80	12	102	55	40	45	10800	10800	10800	108
10,90	12	102	55	40	45	10900	10900	10900	109
11,00	12	102	55	40	45	11000	11000	11000	110
11,10	12	102	55	40	45	11100	11100	11100	111
11,20	12	102	55	40	45	11200	11200	11200	112
11,25	12	102	55	40	45	11250	11250	11250	912
11,30	12	102	55	40	45	11300	11300	11300	113
11,35	12	102	55	40	45	11350	11350	11350	913
11,40	12	102	55	40	45	11400	11400	11400	114
11,45	12	102	55	40	45	11450	11450	11450	914
11,50	12	102	55	40	45	11500	11500	11500	115
11,60	12	102	55	40	45	11600	11600	11600	116
11,70	12	102	55	40	45	11700	11700	11700	117
P						●	●	●	○
M									●
K						●	●	●	○
N									○
S									●
H						○	○	○	
O									

WTX – High Performance Drill, DIN 6537

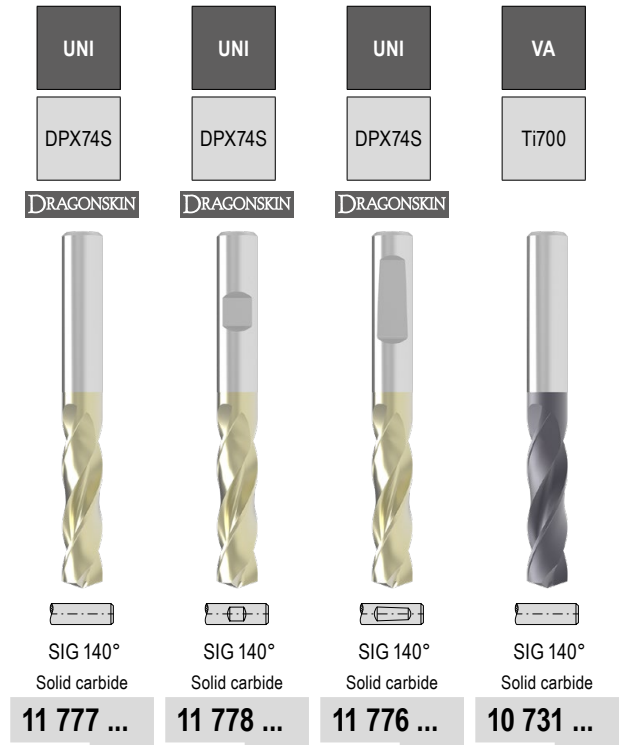
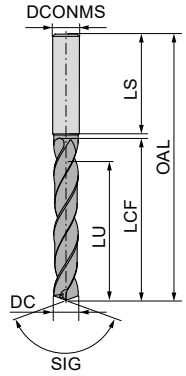
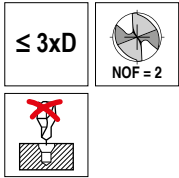

DC _{m7} mm	DCONMS _{h6} mm	OAL mm	LCF mm	LU mm	LS mm	11 777 ...	11 778 ...	11 776 ...	10 731 ...
11,80	12	102	55	40	45	11800	11800	11800	118
11,90	12	102	55	40	45	11900	11900	11900	119
12,00	12	102	55	40	45	12000	12000	12000	120
12,15	14	107	60	43	45	12150	12150	12150	921
12,25	14	107	60	43	45	12250	12250	12250	
12,50	14	107	60	43	45	12500	12500	12500	125
12,55	14	107	60	43	45	12550	12550	12550	925
12,70	14	107	60	43	45	12700	12700	12700	
12,80	14	107	60	43	45	12800	12800	12800	128
12,90	14	107	60	43	45	12900	12900	12900	
13,00	14	107	60	43	45	13000	13000	13000	130
13,10	14	107	60	43	45	13100	13100	13100	
13,30	14	107	60	43	45	13300	13300	13300	
13,35	14	107	60	43	45	13350	13350	13350	933
13,50	14	107	60	43	45	13500	13500	13500	135
13,70	14	107	60	43	45	13700	13700	13700	
13,80	14	107	60	43	45	13800	13800	13800	138
14,00	14	107	60	43	45	14000	14000	14000	140
14,20	16	115	65	45	48	14200	14200	14200	
14,50	16	115	65	45	48	14500	14500	14500	145
14,80	16	115	65	45	48	14800	14800	14800	148
15,00	16	115	65	45	48	15000	15000	15000	150
15,10	16	115	65	45	48	15100	15100	15100	
15,25	16	115	65	45	48	15250	15250	15250	
15,30	16	115	65	45	48	15300	15300	15300	
15,35	16	115	65	45	48	15350	15350	15350	953
15,50	16	115	65	45	48	15500	15500	15500	155
15,60	16	115	65	45	48	15600	15600	15600	
15,80	16	115	65	45	48	15800	15800	15800	158
16,00	16	115	65	45	48	16000	16000	16000	160
16,05	18	123	73	51	48	16050	16050	16050	960
16,50	18	123	73	51	48	16500	16500	16500	165
16,80	18	123	73	51	48	16800	16800	16800	168
16,90	18	123	73	51	48	16900	16900	16900	
17,00	18	123	73	51	48	17000	17000	17000	170
17,50	18	123	73	51	48	17500	17500	17500	175
17,60	18	123	73	51	48	17600	17600	17600	
17,80	18	123	73	51	48	17800	17800	17800	178
18,00	18	123	73	51	48	18000	18000	18000	180
18,50	20	131	79	55	50	18500	18500	18500	185
18,80	20	131	79	55	50	18800	18800	18800	188

P	●	●	●	○
M				●
K	●	●	●	○
N				○
S				●
H	○	○	○	
O				

WTX – High Performance Drill, DIN 6537

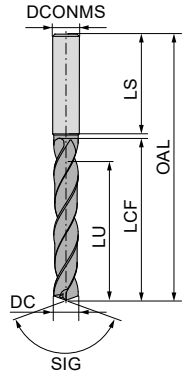
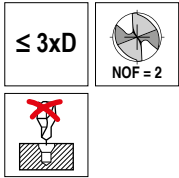

UNI	UNI	UNI	VA
DPX74S	DPX74S	DPX74S	Ti700
DRAGONSKIN	DRAGONSKIN	DRAGONSKIN	
SIG 140° Solid carbide	SIG 140° Solid carbide	SIG 140° Solid carbide	SIG 140° Solid carbide
11 777 ...	11 778 ...	11 776 ...	10 731 ...
18900	18900	18900	190
19000	19000	19000	993
19350	19350	19350	195
19500	19500	19500	198
19600	19600	19600	200
19800	19800	19800	
20000	20000	20000	
20500	20500	20500	
21000	21000	21000	
21500	21500	21500	
22000	22000	22000	
22500	22500	22500	
23000	23000	23000	
23500	23500	23500	
24000	24000	24000	
24500	24500	24500	
25000	25000	25000	

DC _{m7} mm	DCONMS _{h6} mm	OAL mm	LCF mm	LU mm	LS mm
18,90	20	131	79	55	50
19,00	20	131	79	55	50
19,35	20	131	79	55	50
19,50	20	131	79	55	50
19,60	20	131	79	55	50
19,80	20	131	79	55	50
20,00	20	131	79	55	50
20,50	25	151	93	66	56
21,00	25	151	93	66	56
21,50	25	151	93	66	56
22,00	25	151	93	66	56
22,50	25	153	96	72	56
23,00	25	153	96	72	56
23,50	25	153	96	72	56
24,00	25	153	96	72	56
24,50	25	153	96	75	56
25,00	25	153	96	75	56

P	●	●	●	○
M				●
K	●	●	●	○
N				○
S				●
H	○	○	○	
O				

→ v_c Page 110+112

High Performance Drill, DIN 6537

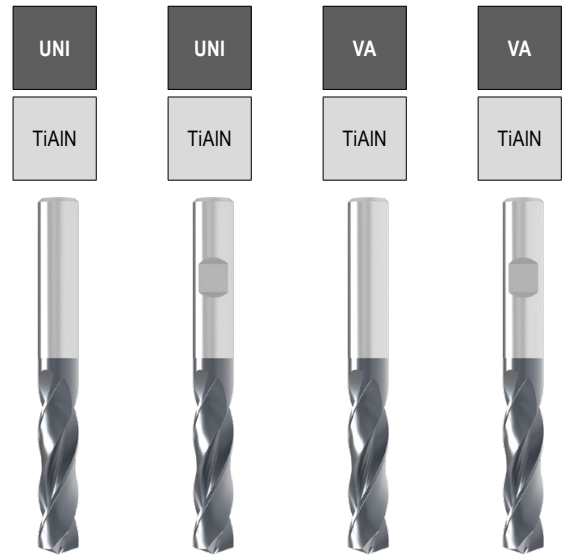
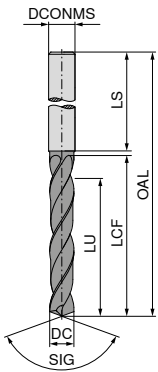

SIG 140° Solid carbide

11 706 ... 11 707 ... 11 711 ... 11 712 ...

DC _{m7} mm	DCONMS _{h6} mm	OAL mm	LCF mm	LU mm	LS mm				
1,00	4	45	7	5,5	28		01000		01000
1,10	4	45	7	5,3	28		01100		01100
1,20	4	45	7	5,2	28		01200		01200
1,30	4	45	7	5,0	28		01300		01300
1,40	4	45	7	4,9	28		01400		01400
1,50	4	55	14	11,7	28		01500		01500
1,60	4	55	14	11,6	28		01600		01600
1,70	4	55	14	11,4	28		01700		01700
1,80	4	55	14	11,3	28		01800		01800
1,90	4	55	14	11,1	28		01900		01900
2,00	4	55	20	17,0	28		02000		02000
2,10	4	55	20	16,8	28		02100		02100
2,20	4	55	20	16,7	28		02200		02200
2,30	4	55	20	16,5	28		02300		02300
2,40	4	55	20	16,4	28		02400		02400
2,50	4	55	20	16,2	28		02500		02500
2,60	4	55	20	16,1	28		02600		02600
2,70	4	55	20	15,9	28		02700		02700
2,80	4	55	20	15,8	28		02800		02800
2,90	4	55	20	15,6	28		02900		02900
3,00	6	62	20	15,5	36		03000	03000	03000
3,10	6	62	20	15,3	36		03100	03100	03100
3,20	6	62	20	15,2	36		03200	03200	03200
3,25	6	62	20	15,1	36		03250	03250	
3,30	6	62	20	15,0	36		03300	03300	03300
3,40	6	62	20	14,9	36		03400	03400	03400
3,50	6	62	20	14,7	36		03500	03500	03500
3,60	6	62	20	14,6	36		03600	03600	03600
3,70	6	62	20	14,4	36		03700	03700	03700
3,80	6	66	24	18,3	36		03800	03800	03800
3,90	6	66	24	18,1	36		03900	03900	03900
4,00	6	66	24	18,0	36		04000	04000	04000
4,10	6	66	24	17,8	36		04100	04100	04100
4,20	6	66	24	17,7	36		04200	04200	04200
4,30	6	66	24	17,5	36		04300	04300	04300
4,40	6	66	24	17,4	36		04400	04400	04400
4,50	6	66	24	17,2	36		04500	04500	04500
4,60	6	66	24	17,1	36		04600	04600	04600
4,65	6	66	24	17,0	36		04650	04650	04650
4,70	6	66	24	16,9	36		04700	04700	04700

P	●	●	○	○
M	●	●	●	●
K	●	●		
N			○	○
S			○	○
H				
O			○	○

→ v_c Page 128+132

Ø DC_{h7} for Type UNI / Ø DC_{m7} for Type VA

High Performance Drill, DIN 6537

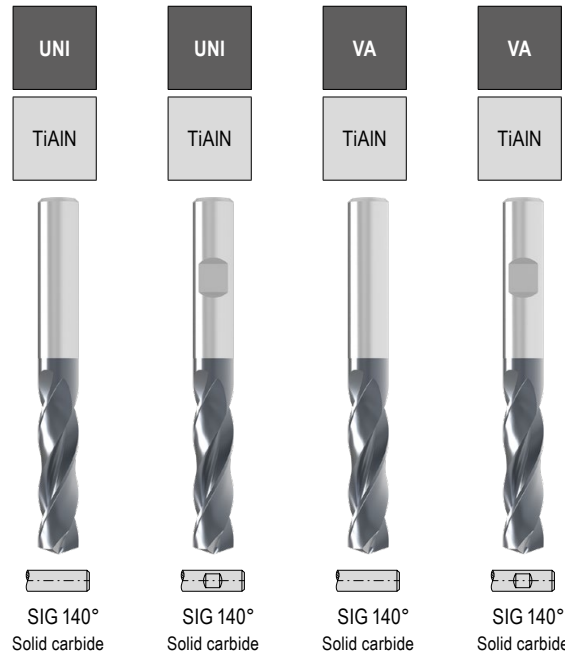
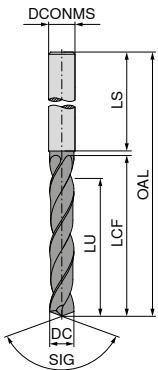

	11 706 ...	11 707 ...	11 711 ...	11 712 ...
04800	04800	04800	04800	04800
04900	04900	04900	04900	04900
05000	05000	05000	05000	05000
05100	05100	05100	05100	05100
05200	05200	05200	05200	05200
05300	05300	05300	05300	05300
05400	05400	05400	05400	05400
05500	05500	05500	05500	05500
05600	05600	05600	05600	05600
05650	05650	05650		
05700	05700	05700	05700	05700
05800	05800	05800	05800	05800
05900	05900	05900	05900	05900
06000	06000	06000	06000	06000
06100	06100	06100	06100	06100
06200	06200	06200	06200	06200
06300	06300	06300	06300	06300
06400	06400	06400	06400	06400
06500	06500	06500	06500	06500
06600	06600	06600	06600	06600
06700	06700	06700	06700	06700
06800	06800	06800	06800	06800
06900	06900	06900	06900	06900
07000	07000	07000	07000	07000
07100	07100	07100	07100	07100
07200	07200	07200	07200	07200
07300	07300	07300	07300	07300
07400	07400	07400	07400	07400
07500	07500	07500	07500	07500
07550	07550	07550		
07600	07600	07600	07600	07600
07650	07650	07650		
07700	07700	07700	07700	07700
07800	07800	07800	07800	07800
07900	07900	07900	07900	07900
08000	08000	08000	08000	08000
08100	08100	08100	08100	08100
08200	08200	08200	08200	08200
08300	08300	08300	08300	08300

DC _{m7} mm	DCONMS _{h6} mm	OAL mm	LCF mm	LU mm	LS mm
4,80	6	66	28	20,8	36
4,90	6	66	28	20,6	36
5,00	6	66	28	20,5	36
5,10	6	66	28	20,3	36
5,20	6	66	28	20,2	36
5,30	6	66	28	20,0	36
5,40	6	66	28	19,9	36
5,50	6	66	28	19,7	36
5,55	6	66	28	19,6	36
5,60	6	66	28	19,6	36
5,65	6	66	28	19,5	36
5,70	6	66	28	19,4	36
5,80	6	66	28	19,3	36
5,90	6	66	28	19,1	36
6,00	6	66	28	19,0	36
6,10	8	79	34	24,8	36
6,20	8	79	34	24,7	36
6,30	8	79	34	24,5	36
6,40	8	79	34	24,4	36
6,50	8	79	34	24,2	36
6,60	8	79	34	24,1	36
6,70	8	79	34	23,9	36
6,80	8	79	34	23,8	36
6,90	8	79	34	23,6	36
7,00	8	79	34	23,5	36
7,10	8	79	41	30,3	36
7,20	8	79	41	30,2	36
7,30	8	79	41	30,0	36
7,40	8	79	41	29,9	36
7,50	8	79	41	29,7	36
7,55	8	79	41	29,6	36
7,60	8	79	41	29,6	36
7,65	8	79	41	29,5	36
7,70	8	79	41	29,4	36
7,80	8	79	41	29,3	36
7,90	8	79	41	29,1	36
8,00	8	79	41	29,0	36
8,10	10	89	47	34,8	40
8,20	10	89	47	34,7	40
8,30	10	89	47	34,5	40

P	●	●	○	○
M	●	●	●	●
K	●	●		
N			○	○
S			○	○
H				
O			○	○

→ v_c Page 128+132

Ø DC_{h7} for Type UNI / Ø DC_{m7} for Type VA

High Performance Drill, DIN 6537

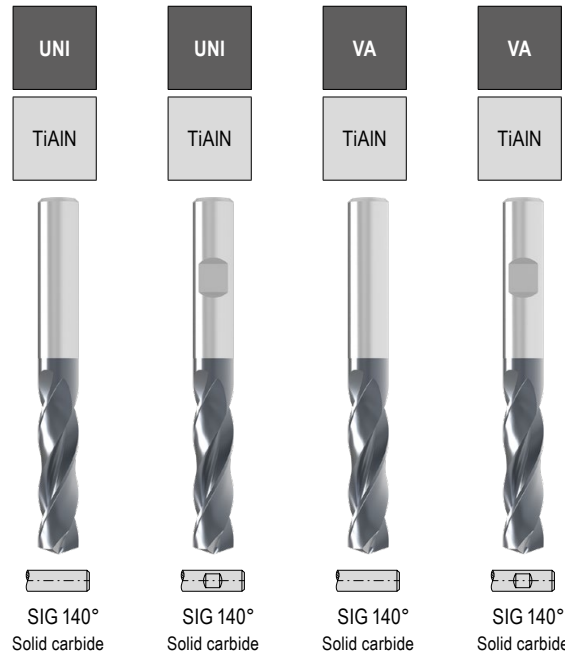
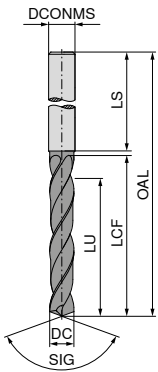

11 706 ... 11 707 ... 11 711 ... 11 712 ...

DC _{m7} mm	DCONMS _{h6} mm	OAL mm	LCF mm	LU mm	LS mm				
8,40	10	89	47	34,4	40	08400	08400	08400	08400
8,50	10	89	47	34,2	40	08500	08500	08500	08500
8,60	10	89	47	34,1	40	08600	08600	08600	08600
8,70	10	89	47	33,9	40	08700	08700	08700	08700
8,80	10	89	47	33,8	40	08800	08800	08800	08800
8,90	10	89	47	33,6	40	08900	08900	08900	08900
9,00	10	89	47	33,5	40	09000	09000	09000	09000
9,10	10	89	47	33,3	40	09100	09100	09100	09100
9,20	10	89	47	33,2	40	09200	09200	09200	09200
9,30	10	89	47	33,0	40	09300	09300	09300	09300
9,40	10	89	47	32,9	40	09400	09400	09400	09400
9,50	10	89	47	32,7	40	09500	09500	09500	09500
9,60	10	89	47	32,6	40	09600	09600	09600	09600
9,70	10	89	47	32,4	40	09700	09700	09700	09700
9,80	10	89	47	32,3	40	09800	09800	09800	09800
9,90	10	89	47	32,1	40	09900	09900	09900	09900
10,00	10	89	47	32,0	40	10000	10000	10000	10000
10,10	12	102	55	39,8	45	10100	10100	10100	10100
10,20	12	102	55	39,7	45	10200	10200	10200	10200
10,30	12	102	55	39,5	45	10300	10300	10300	10300
10,40	12	102	55	39,4	45	10400	10400	10400	10400
10,50	12	102	55	39,2	45	10500	10500	10500	10500
10,60	12	102	55	39,1	45	10600	10600	10600	10600
10,70	12	102	55	38,9	45	10700	10700	10700	10700
10,80	12	102	55	38,8	45	10800	10800	10800	10800
10,90	12	102	55	38,6	45	10900	10900	10900	10900
11,00	12	102	55	38,5	45	11000	11000	11000	11000
11,10	12	102	55	38,3	45	11100	11100	11100	11100
11,20	12	102	55	38,2	45	11200	11200	11200	11200
11,30	12	102	55	38,0	45	11300	11300	11300	11300
11,40	12	102	55	37,9	45	11400	11400	11400	11400
11,50	12	102	55	37,7	45	11500	11500	11500	11500
11,60	12	102	55	37,6	45	11600	11600	11600	11600
11,70	12	102	55	37,4	45	11700	11700	11700	11700
11,80	12	102	55	37,3	45	11800	11800	11800	11800
11,90	12	102	55	37,1	45	11900	11900	11900	11900
12,00	12	102	55	37,0	45	12000	12000	12000	12000
12,20	14	107	60	41,7	45	12200	12200	12200	12200
12,50	14	107	60	41,2	45	12500	12500	12500	12500
12,70	14	107	60	40,9	45	12700	12700	12700	12700

P	●	●	○	○
M	●	●	●	●
K	●	●	○	○
N	○	○	○	○
S	○	○	○	○
H	○	○	○	○
O	○	○	○	○

→ v_c Page 128+132

Ø DC_{h7} for Type UNI / Ø DC_{m7} for Type VA

High Performance Drill, DIN 6537

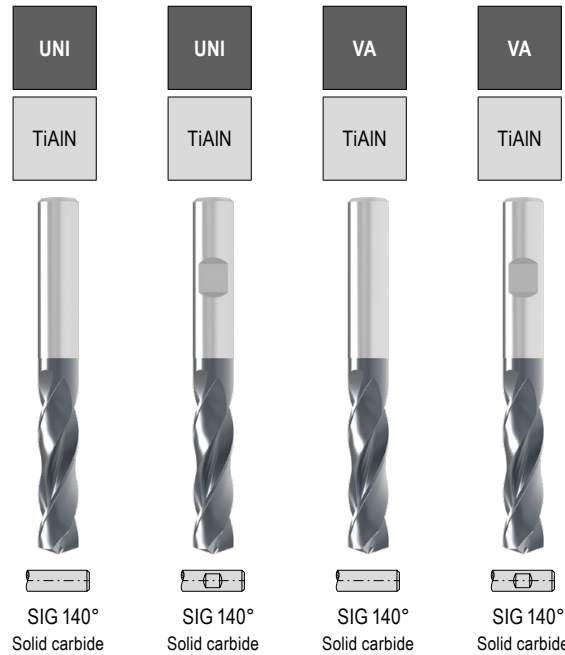
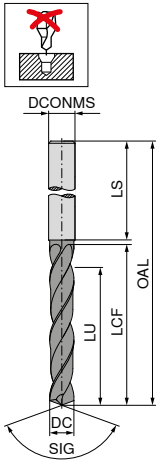

	11 706 ...	11 707 ...	11 711 ...	11 712 ...
12,80	12800	12800	12800	12800
13,00	13000	13000	13000	13000
13,10	13100	13100	13100	13100
13,50	13500	13500	13500	13500
13,70			13700	13700
13,80	13800	13800	13800	13800
14,00	14000	14000	14000	14000
14,20	14200	14200	14200	14200
14,40	14400	14400	14400	14400
14,50	14500	14500	14500	14500
14,70			14700	14700
14,80	14800	14800	14800	14800
15,00	15000	15000	15000	15000
15,10	15100	15100	15100	15100
15,20	15200	15200	15200	15200
15,50	15500	15500	15500	15500
15,70			15700	15700
15,80	15800	15800	15800	15800
16,00	16000	16000	16000	16000
16,50	16500	16500	16500	16500
17,00	17000	17000	17000	17000
17,50	17500	17500	17500	17500
18,00	18000	18000	18000	18000
18,50	18500	18500	18500	18500
18,90	18900	18900	18900	18900
19,00	19000	19000	19000	19000
19,50	19500	19500	19500	19500
20,00	20000	20000	20000	20000

DC _{m7/h7} mm	DCONMS _{h6} mm	OAL mm	LCF mm	LU mm	LS mm
12,80	14	107	60	40,8	45
13,00	14	107	60	40,5	45
13,10	14	107	60	40,3	45
13,50	14	107	60	39,7	45
13,70	14	107	60	39,4	45
13,80	14	107	60	39,3	45
14,00	14	107	60	39,0	45
14,20	16	115	65	43,7	48
14,40	16	115	65	43,4	48
14,50	16	115	65	43,2	48
14,70	16	115	65	42,9	48
14,80	16	115	65	42,8	48
15,00	16	115	65	42,5	48
15,10	16	115	65	42,3	48
15,20	16	115	65	42,2	48
15,50	16	115	65	41,7	48
15,70	16	115	65	41,4	48
15,80	16	115	65	41,3	48
16,00	16	115	65	41,0	48
16,50	18	123	73	48,2	48
17,00	18	123	73	47,5	48
17,50	18	123	73	46,7	48
18,00	18	123	73	46,0	48
18,50	20	131	79	51,2	50
18,90	20	131	79	50,6	50
19,00	20	131	79	50,5	50
19,50	20	131	79	49,7	50
20,00	20	131	79	49,0	50

P	●	●	○	○
M			●	●
K	●	●		
N			○	○
S			○	○
H				
O			○	○

→ v_c Page 128+132

Ø DC_{h7} for Type UNI / Ø DC_{m7} for Type VA

WTX – High Performance Drill, factory standard

- ▲ Special cutting edge geometry
 - ▲ Special flute geometry
 - ▲ Optimised core thickness
- ▲ 46 to 70 HRC

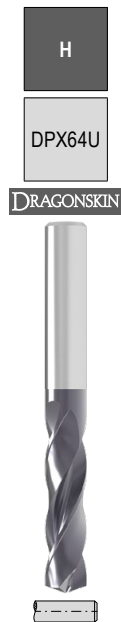
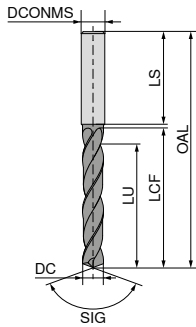
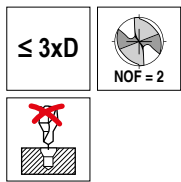

SIG 140°
Solid carbide

10 777 ...

DC _{h7} mm	DCONMS _{h6} mm	OAL mm	LCF mm	LU mm	LS mm	
2,55	4	55	20	16,1	28	02550
2,60	4	55	20	16,1	28	02600
2,70	4	55	20	15,9	28	02700
2,80	4	55	20	15,8	28	02800
2,90	4	55	20	15,6	28	02900
3,00	6	62	20	15,5	36	03000
3,10	6	62	20	15,3	36	03100
3,20	6	62	20	15,2	36	03200
3,30	6	62	20	15,0	36	03300
3,40	6	62	20	14,9	36	03400
3,50	6	62	20	14,7	36	03500
3,60	6	62	20	14,6	36	03600
3,70	6	62	20	14,4	36	03700
3,80	6	66	24	18,3	36	03800
3,90	6	66	24	18,1	36	03900
4,00	6	66	24	18,0	36	04000
4,10	6	66	24	17,8	36	04100
4,20	6	66	24	17,7	36	04200
4,30	6	66	24	17,5	36	04300
4,40	6	66	24	17,4	36	04400
4,50	6	66	24	17,2	36	04500
4,60	6	66	24	17,1	36	04600
4,70	6	66	24	16,9	36	04700
4,80	6	66	28	20,8	36	04800
4,90	6	66	28	20,6	36	04900
5,00	6	66	28	20,5	36	05000
5,10	6	66	28	20,3	36	05100
5,20	6	66	28	20,2	36	05200
5,30	6	66	28	20,0	36	05300
5,40	6	66	28	19,9	36	05400
5,50	6	66	28	19,7	36	05500
5,60	6	66	28	19,6	36	05600
5,70	6	66	28	19,4	36	05700
5,80	6	66	28	19,3	36	05800
5,90	6	66	28	19,1	36	05900
6,00	6	66	28	19,0	36	06000
6,10	8	79	34	24,8	36	06100
6,20	8	79	34	24,7	36	06200
6,30	8	79	34	24,5	36	06300
6,40	8	79	34	24,4	36	06400
6,50	8	79	34	24,2	36	06500
6,60	8	79	34	24,1	36	06600
6,70	8	79	34	23,9	36	06700
6,80	8	79	34	23,8	36	06800
6,90	8	79	34	23,6	36	06900
7,00	8	79	34	23,5	36	07000
7,10	8	79	41	30,3	36	07100
7,20	8	79	41	30,2	36	07200
7,30	8	79	41	30,0	36	07300
7,40	8	79	41	29,9	36	07400
7,50	8	79	41	29,7	36	07500

10 777 ...

DC _{h7} mm	DCONMS _{h6} mm	OAL mm	LCF mm	LU mm	LS mm	
7,60	8	79	41	29,6	36	07600
7,70	8	79	41	29,4	36	07700
7,80	8	79	41	29,3	36	07800
7,90	8	79	41	29,1	36	07900
8,00	8	79	41	29,0	36	08000
8,10	10	89	47	34,8	40	08100
8,20	10	89	47	34,7	40	08200
8,30	10	89	47	34,5	40	08300
8,40	10	89	47	34,4	40	08400
8,50	10	89	47	34,2	40	08500
8,60	10	89	47	34,1	40	08600
8,70	10	89	47	33,9	40	08700
8,80	10	89	47	33,8	40	08800
8,90	10	89	47	33,6	40	08900
9,00	10	89	47	33,5	40	09000
9,10	10	89	47	33,3	40	09100
9,20	10	89	47	33,2	40	09200
9,30	10	89	47	33,0	40	09300
9,40	10	89	47	32,9	40	09400
9,50	10	89	47	32,7	40	09500
9,60	10	89	47	32,6	40	09600
9,70	10	89	47	32,4	40	09700
9,80	10	89	47	32,3	40	09800
9,90	10	89	47	32,1	40	09900
10,00	10	89	47	32,0	40	10000
10,10	12	102	55	39,8	45	10100
10,20	12	102	55	39,7	45	10200
10,30	12	102	55	39,5	45	10300
10,40	12	102	55	39,4	45	10400
10,50	12	102	55	39,2	45	10500
10,60	12	102	55	39,1	45	10600
10,70	12	102	55	38,9	45	10700
10,80	12	102	55	38,8	45	10800
10,90	12	102	55	38,6	45	10900
11,00	12	102	55	38,5	45	11000
11,10	12	102	55	38,3	45	11100
11,20	12	102	55	38,2	45	11200
11,30	12	102	55	38,0	45	11300
11,40	12	102	55	37,9	45	11400
11,50	12	102	55	37,7	45	11500
11,60	12	102	55	37,6	45	11600
11,70	12	102	55	37,4	45	11700
11,80	12	102	55	37,3	45	11800
11,90	12	102	55	37,1	45	11900
12,00	12	102	55	37,0	45	12000
12,10	14	107	60	41,8	45	12100
12,20	14	107	60	41,7	45	12200
12,30	14	107	60	41,5	45	12300
12,40	14	107	60	41,4	45	12400
12,50	14	107	60	41,2	45	12500
12,60	14	107	60	41,1	45	12600
12,70	14	107	60	40,9	45	12700
12,80	14	107	60	40,8	45	12800
12,90	14	107	60	40,6	45	12900
13,00	14	107	60	40,5	45	13000
13,10	14	107	60	40,3	45	13100
13,20	14	107	60	40,2	45	13200
13,30	14	107	60	40,0	45	13300
13,40	14	107	60	39,9	45	13400
13,50	14	107	60	39,7	45	13500
13,60	14	107	60	39,6	45	13600
13,70	14	107	60	39,4	45	13700
13,80	14	107	60	39,3	45	13800
13,90	14	107	60	39,1	45	13900
14,00	14	107	60	39,0	45	14000

P	○
K	●
S	
H.1.1	●
H.1.2	●
H.1.3	●
H.1.4	●

→ v_c Page 119

Twist drill similar to DIN 1897

- ▲ Helix angle 30°
- ▲ Shank Ø h7

≤ 3xD

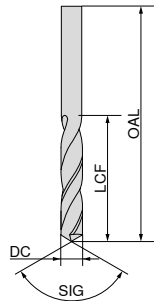

N



SIG 118°
Solid carbide
10 700 ...

DC _{h7} mm	OAL mm	LCF mm	
0,5	20	3,0	005
0,6	21	3,5	006
0,7	23	4,5	007
0,8	24	5,0	008
0,9	25	5,5	009
1,0	26	6,0	010
1,2	30	8,0	012
1,3	30	8,0	013
1,4	32	9,0	014
1,5	32	9,0	015
1,6	34	10,0	016
1,7	34	10,0	017
1,8	36	11,0	018
1,9	36	11,0	019
2,0	38	12,0	020
2,1	38	12,0	021
2,2	40	13,0	022
2,3	40	13,0	023
2,4	43	14,0	024
2,5	43	14,0	025
2,6	43	14,0	026
2,7	46	16,0	027
2,8	46	16,0	028
2,9	46	16,0	029
3,0	46	16,0	030
3,1	49	18,0	031
3,2	49	18,0	032
3,3	49	18,0	033
3,4	52	20,0	034
3,5	52	20,0	035
3,6	52	20,0	036
3,7	52	20,0	037
3,8	55	22,0	038
3,9	55	22,0	039
4,0	55	22,0	040
4,1	55	22,0	041
4,2	55	22,0	042
4,3	58	24,0	043
4,4	58	24,0	044
4,5	58	24,0	045
4,6	58	24,0	046
4,7	58	24,0	047
4,8	62	26,0	048
4,9	62	26,0	049
5,0	62	26,0	050
5,1	62	26,0	051
5,2	62	26,0	052
5,3	62	26,0	053
5,4	66	28,0	054
5,5	66	28,0	055
5,6	66	28,0	056
5,7	66	28,0	057

10 700 ...

DC _{h7} mm	OAL mm	LCF mm	
5,8	66	28,0	058
5,9	66	28,0	059
6,0	66	28,0	060
6,1	70	31,0	061
6,2	70	31,0	062
6,3	70	31,0	063
6,4	70	31,0	064
6,5	70	31,0	065
6,6	70	31,0	066
6,7	70	31,0	067
6,8	74	34,0	068
6,9	74	34,0	069
7,0	74	34,0	070
7,1	74	34,0	071
7,2	74	34,0	072
7,3	74	34,0	073
7,4	74	34,0	074
7,5	74	34,0	075
7,6	79	37,0	076
7,7	79	37,0	077
7,8	79	37,0	078
7,9	79	37,0	079
8,0	79	37,0	080
8,1	79	37,0	081
8,2	79	37,0	082
8,3	79	37,0	083
8,4	79	37,0	084
8,5	79	37,0	085
8,6	84	40,0	086
8,7	84	40,0	087
8,8	84	40,0	088
8,9	84	40,0	089
9,0	84	40,0	090
9,1	84	40,0	091
9,2	84	40,0	092
9,3	84	40,0	093
9,4	84	40,0	094
9,5	84	40,0	095
9,6	89	43,0	096
9,7	89	43,0	097
9,8	89	43,0	098
9,9	89	43,0	099
10,0	89	43,0	100
10,2	89	43,0	102
10,5	89	43,0	105
10,8	95	47,0	108
11,0	95	47,0	110
11,2	95	47,0	112
11,5	95	47,0	115
11,8	95	47,0	118
12,0	102	51,0	120
12,5	102	51,0	125
13,0	102	51,0	130
13,5	107	54,0	135
14,0	107	54,0	140
14,5	111	56,0	145
15,0	111	56,0	150
15,5	115	58,0	155
16,0	115	58,0	160
18,0	123	62,0	180
20,0	131	66,0	200

P	○
M	○
K	●
N	●
S	○
H	○
O	○

→ v. Page 134

WTX – High Performance Drill, DIN 6537

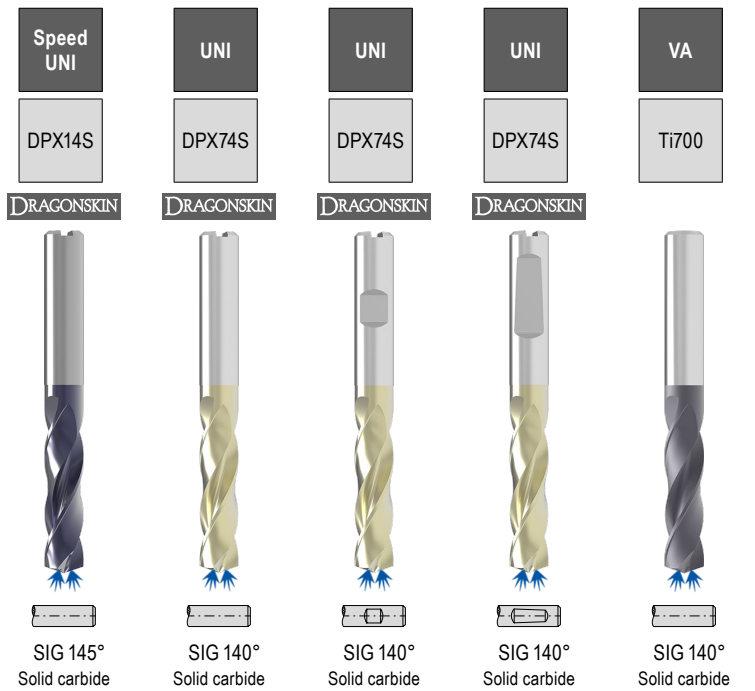
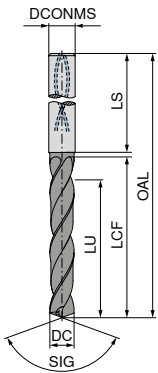
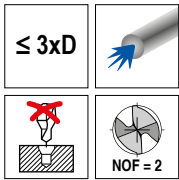

DC _{m7h7} mm	DCONMS _{h6} mm	OAL mm	LCF mm	LU mm	LS mm	10 781 ...	11 780 ...	11 781 ...	11 779 ...	10 734 ...
3,00	6	62	20	14	36	03000	03000	03000	03000	030
3,10	6	62	20	14	36	03100	03100	03100	03100	031
3,15	6	62	20	14	36		03150	03150	03150	831
3,20	6	62	20	14	36	03200	03200	03200	03200	032
3,22	6	62	20	14	36		03220	03220	03220	832
3,25	6	62	20	14	36		03250	03250	03250	890
3,30	6	62	20	14	36	03300	03300	03300	03300	033
3,40	6	62	20	14	36	03400	03400	03400	03400	034
3,50	6	62	20	14	36	03500	03500	03500	03500	035
3,60	6	62	20	14	36	03600	03600	03600	03600	036
3,70	6	62	20	14	36	03700	03700	03700	03700	037
3,80	6	66	24	17	36	03800	03800	03800	03800	038
3,85	6	66	24	17	36		03850	03850	03850	838
3,90	6	66	24	17	36	03900	03900	03900	03900	039
4,00	6	66	24	17	36	04000	04000	04000	04000	040
4,10	6	66	24	17	36	04100	04100	04100	04100	041
4,20	6	66	24	17	36	04200	04200	04200	04200	042
4,25	6	66	24	17	36		04250	04250	04250	
4,30	6	66	24	17	36	04300	04300	04300	04300	043
4,35	6	66	24	17	36		04350	04350	04350	843
4,40	6	66	24	17	36	04400	04400	04400	04400	044
4,45	6	66	24	17	36		04450	04450	04450	844
4,50	6	66	24	17	36	04500	04500	04500	04500	045
4,60	6	66	24	17	36	04600	04600	04600	04600	046
4,65	6	66	24	17	36	04650	04650	04650	04650	900
4,70	6	66	24	17	36	04700	04700	04700	04700	047
4,80	6	66	28	20	36	04800	04800	04800	04800	048
4,90	6	66	28	20	36	04900	04900	04900	04900	049
4,95	6	66	28	20	36		04950	04950	04950	
5,00	6	66	28	20	36	05000	05000	05000	05000	050
5,05	6	66	28	20	36		05050	05050	05050	
5,10	6	66	28	20	36	05100	05100	05100	05100	051
5,20	6	66	28	20	36	05200	05200	05200	05200	052
5,30	6	66	28	20	36	05300	05300	05300	05300	053
5,40	6	66	28	20	36	05400	05400	05400	05400	054
5,50	6	66	28	20	36	05500	05500	05500	05500	055
5,55	6	66	28	20	36	05550	05550	05550	05550	902
5,60	6	66	28	20	36	05600	05600	05600	05600	056
5,70	6	66	28	20	36	05700	05700	05700	05700	057
5,75	6	66	28	20	36		05750	05750	05750	916
5,80	6	66	28	20	36	05800	05800	05800	05800	058
5,90	6	66	28	20	36	05900	05900	05900	05900	059

P	●	●	●	●	○
M	●	●	●	●	●
K	●	●	●	●	○
N					○
S					●
H		○	○	○	
O					

→ v_c Page 110–114

Ø DC_{m7} for Type UNI and VA / Ø DC_{h7} for Type Speed UNI

WTX – High Performance Drill, DIN 6537

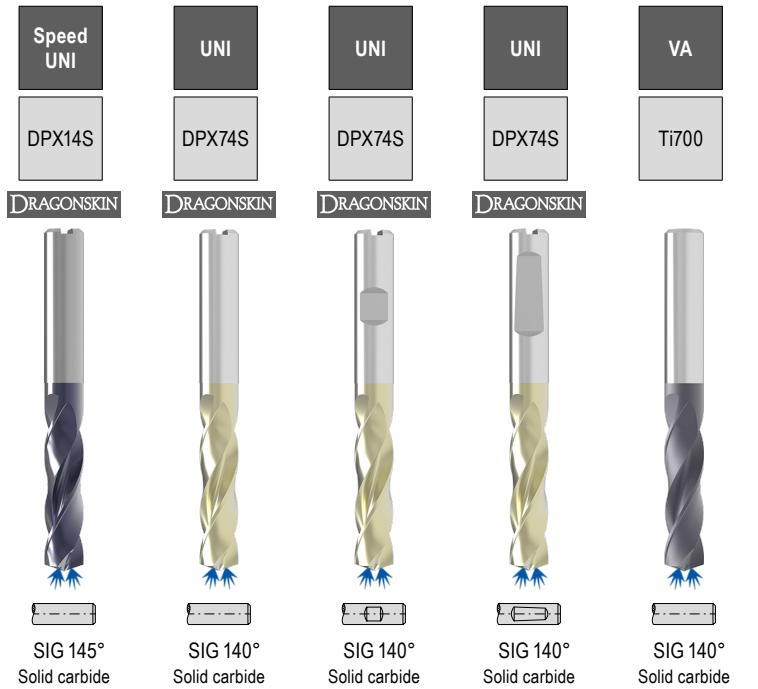
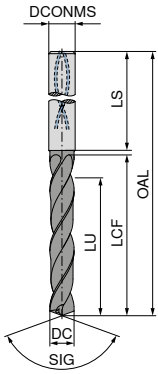
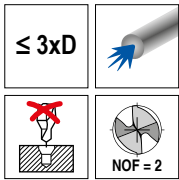

DC _{m7h7} mm	DCONMS _{h6} mm	OAL mm	LCF mm	LU mm	LS mm	10 781 ...	11 780 ...	11 781 ...	11 779 ...	10 734 ...
5,95	6	66	28	20	36					
6,00	6	66	28	20	36	06000	05950	05950	05950	959
6,10	8	79	34	24	36	06100	06100	06100	06100	060
6,20	8	79	34	24	36	06200	06200	06200	06200	061
6,30	8	79	34	24	36	06300	06300	06300	06300	062
6,40	8	79	34	24	36	06400	06400	06400	06400	063
6,50	8	79	34	24	36	06500	06500	06500	06500	064
6,60	8	79	34	24	36	06600	06600	06600	06600	065
6,70	8	79	34	24	36	06700	06700	06700	06700	066
6,80	8	79	34	24	36	06800	06800	06800	06800	067
6,90	8	79	34	24	36	06900	06900	06900	06900	068
7,00	8	79	34	24	36	07000	07000	07000	07000	069
7,10	8	79	41	29	36	07100	07100	07100	07100	070
7,20	8	79	41	29	36	07200	07200	07200	07200	071
7,30	8	79	41	29	36	07300	07300	07300	07300	072
7,40	8	79	41	29	36	07400	07400	07400	07400	073
7,45	8	79	41	29	36	07450	07450	07450	07450	074
7,50	8	79	41	29	36	07500	07500	07500	07500	075
7,60	8	79	41	29	36	07600	07600	07600	07600	076
7,70	8	79	41	29	36	07700	07700	07700	07700	077
7,80	8	79	41	29	36	07800	07800	07800	07800	078
7,90	8	79	41	29	36	07900	07900	07900	07900	079
8,00	8	79	41	29	36	08000	08000	08000	08000	080
8,10	10	89	47	35	40	08100	08100	08100	08100	081
8,20	10	89	47	35	40	08200	08200	08200	08200	082
8,30	10	89	47	35	40	08300	08300	08300	08300	083
8,40	10	89	47	35	40	08400	08400	08400	08400	084
8,50	10	89	47	35	40	08500	08500	08500	08500	085
8,60	10	89	47	35	40	08600	08600	08600	08600	086
8,70	10	89	47	35	40	08700	08700	08700	08700	087
8,80	10	89	47	35	40	08800	08800	08800	08800	088
8,90	10	89	47	35	40	08900	08900	08900	08900	089
9,00	10	89	47	35	40	09000	09000	09000	09000	090
9,10	10	89	47	35	40	09100	09100	09100	09100	091
9,20	10	89	47	35	40	09200	09200	09200	09200	092
9,30	10	89	47	35	40	09300	09300	09300	09300	093
9,35	10	89	47	35	40	09350	09350	09350	09350	094
9,40	10	89	47	35	40	09400	09400	09400	09400	095
9,45	10	89	47	35	40	09450	09450	09450	09450	096
9,50	10	89	47	35	40	09500	09500	09500	09500	097
9,60	10	89	47	35	40	09600	09600	09600	09600	
9,70	10	89	47	35	40	09700	09700	09700	09700	

P	●	●	●	●	○
M	●	●	●	●	●
K	●	●	●	●	○
N					○
S					●
H		○	○	○	
O					

→ v_c Page 110–114

Ø DC_{m7} for Type UNI and VA / Ø DC_{h7} for Type Speed UNI

WTX – High Performance Drill, DIN 6537

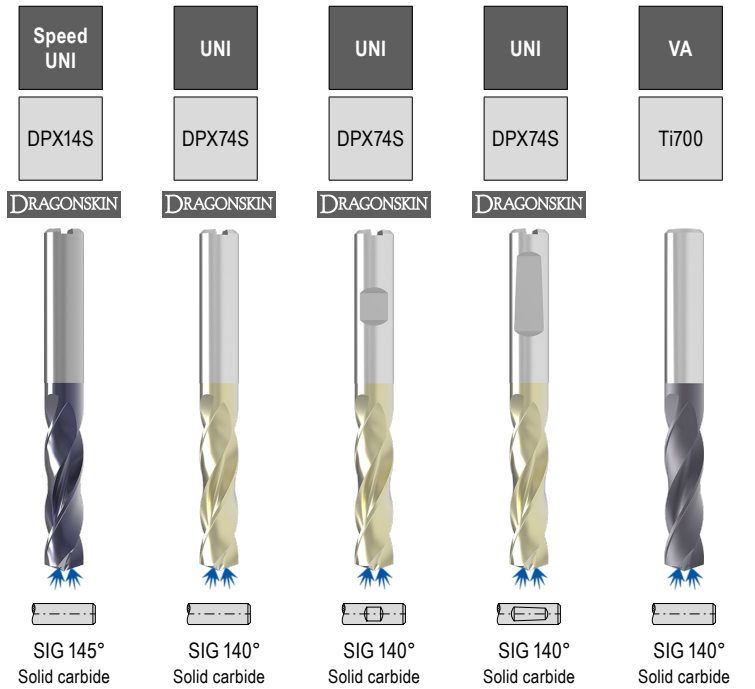
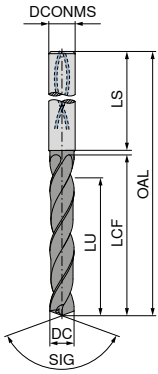
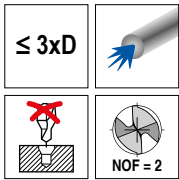

DC _{m7h7} mm	DCONMS _{h6} mm	OAL mm	LCF mm	LU mm	LS mm	10 781 ...	11 780 ...	11 781 ...	11 779 ...	10 734 ...
9,80	10	89	47	35	40	09800	09800	09800	09800	098
9,90	10	89	47	35	40	09900	09900	09900	09900	099
10,00	10	89	47	35	40	10000	10000	10000	10000	100
10,10	12	102	55	40	45	10100	10100	10100	10100	101
10,20	12	102	55	40	45	10200	10200	10200	10200	102
10,30	12	102	55	40	45	10300	10300	10300	10300	103
10,40	12	102	55	40	45	10400	10400	10400	10400	104
10,50	12	102	55	40	45	10500	10500	10500	10500	105
10,55	12	102	55	40	45	10550	10550	10550	10550	932
10,60	12	102	55	40	45	10600	10600	10600	10600	106
10,70	12	102	55	40	45	10700	10700	10700	10700	107
10,75	12	102	55	40	45	10750	10750	10750	10750	
10,80	12	102	55	40	45	10800	10800	10800	10800	108
10,90	12	102	55	40	45	10900	10900	10900	10900	109
11,00	12	102	55	40	45	11000	11000	11000	11000	110
11,10	12	102	55	40	45	11100	11100	11100	11100	111
11,20	12	102	55	40	45	11200	11200	11200	11200	112
11,25	12	102	55	40	45	11250	11250	11250	11250	912
11,30	12	102	55	40	45	11300	11300	11300	11300	113
11,35	12	102	55	40	45	11350	11350	11350	11350	913
11,40	12	102	55	40	45	11400	11400	11400	11400	114
11,45	12	102	55	40	45	11450	11450	11450	11450	914
11,50	12	102	55	40	45	11500	11500	11500	11500	115
11,60	12	102	55	40	45	11600	11600	11600	11600	116
11,70	12	102	55	40	45	11700	11700	11700	11700	117
11,80	12	102	55	40	45	11800	11800	11800	11800	118
11,90	12	102	55	40	45	11900	11900	11900	11900	119
12,00	12	102	55	40	45	12000	12000	12000	12000	120
12,15	14	107	60	43	45	12150	12150	12150	12150	921
12,25	14	107	60	43	45	12250	12250	12250	12250	
12,50	14	107	60	43	45	12500	12500	12500	12500	125
12,55	14	107	60	43	45	12550	12550	12550	12550	925
12,70	14	107	60	43	45	12700	12700	12700	12700	
12,80	14	107	60	43	45	12800	12800	12800	12800	128
12,90	14	107	60	43	45	12900	12900	12900	12900	
13,00	14	107	60	43	45	13000	13000	13000	13000	130
13,10	14	107	60	43	45	13100	13100	13100	13100	
13,30	14	107	60	43	45	13300	13300	13300	13300	
13,35	14	107	60	43	45	13350	13350	13350	13350	933
13,50	14	107	60	43	45	13500	13500	13500	13500	135
13,70	14	107	60	43	45	13700	13700	13700	13700	
13,80	14	107	60	43	45	13800	13800	13800	13800	138

P	●	●	●	●	○
M	●	●	●	●	●
K	●	●	●	●	○
N					○
S					●
H		○	○	○	
O					

→ v_e Page 110–114

Ø DC_{m7} for Type UNI and VA / Ø DC_{h7} for Type Speed UNI

WTX – High Performance Drill, DIN 6537

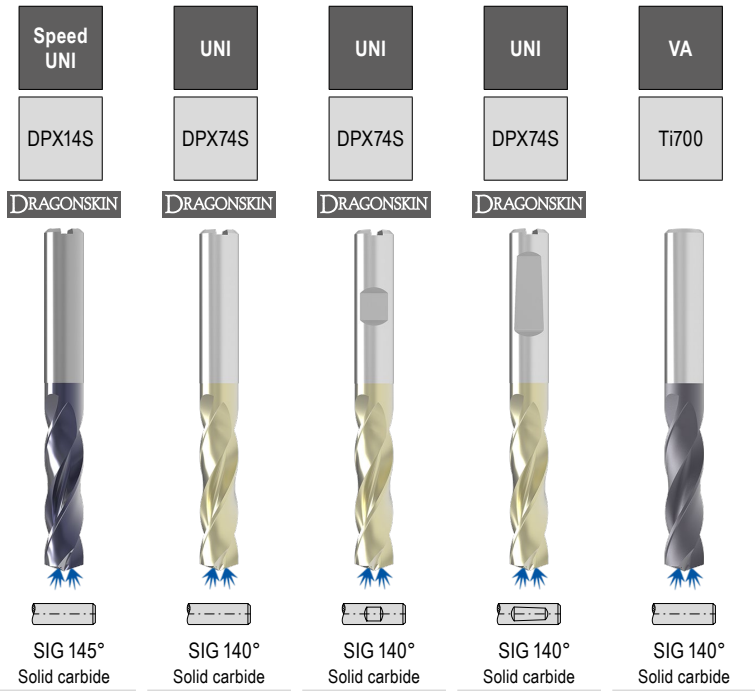
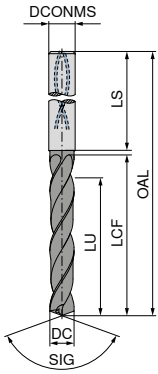
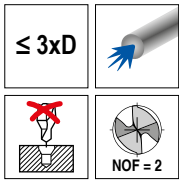

DC _{m7h7} mm	DCONMS _{h6} mm	OAL mm	LCF mm	LU mm	LS mm	10 781 ...	11 780 ...	11 781 ...	11 779 ...	10 734 ...
14,00	14	107	60	43	45	14000	14000	14000	14000	140
14,20	16	115	65	45	48		14200	14200	14200	
14,50	16	115	65	45	48	14500	14500	14500	14500	145
14,80	16	115	65	45	48	14800	14800	14800	14800	148
15,00	16	115	65	45	48	15000	15000	15000	15000	150
15,10	16	115	65	45	48		15100	15100	15100	
15,25	16	115	65	45	48		15250	15250	15250	
15,30	16	115	65	45	48		15300	15300	15300	
15,35	16	115	65	45	48		15350	15350	15350	
15,50	16	115	65	45	48	15500	15500	15500	15500	953
15,60	16	115	65	45	48		15600	15600	15600	
15,80	16	115	65	45	48	15800	15800	15800	15800	158
16,00	16	115	65	45	48	16000	16000	16000	16000	160
16,05	18	123	73	51	48		16050	16050	16050	
16,50	18	123	73	51	48	16500	16500	16500	16500	165
16,80	18	123	73	51	48	16800	16800	16800	16800	168
16,90	18	123	73	51	48		16900	16900	16900	
17,00	18	123	73	51	48	17000	17000	17000	17000	170
17,50	18	123	73	51	48	17500	17500	17500	17500	175
17,60	18	123	73	51	48		17600	17600	17600	
17,80	18	123	73	51	48	17800	17800	17800	17800	178
18,00	18	123	73	51	48	18000	18000	18000	18000	180
18,50	20	131	79	55	50	18500	18500	18500	18500	185
18,80	20	131	79	55	50	18800	18800	18800	18800	188
18,90	20	131	79	55	50		18900	18900	18900	
19,00	20	131	79	55	50	19000	19000	19000	19000	190
19,35	20	131	79	55	50		19350	19350	19350	
19,50	20	131	79	55	50	19500	19500	19500	19500	195
19,60	20	131	79	55	50		19600	19600	19600	
19,80	20	131	79	55	50	19800	19800	19800	19800	198
20,00	20	131	79	55	50	20000	20000	20000	20000	200
20,50	25	151	93	66	56		20500	20500	20500	
21,00	25	151	93	66	56		21000	21000	21000	
21,50	25	151	93	66	56		21500	21500	21500	
22,00	25	151	93	66	56		22000	22000	22000	
22,50	25	153	96	72	56		22500	22500	22500	
23,00	25	153	96	72	56		23000	23000	23000	
23,50	25	153	96	72	56		23500	23500	23500	
24,00	25	153	96	72	56		24000	24000	24000	
24,50	25	153	96	75	56		24500	24500	24500	
25,00	25	153	96	75	56		25000	25000	25000	

P	•	•	•	•	○
M	•	•	•	•	•
K	•	•	•	•	•
N					○
S					•
H		○	○	○	
O					

→ v_c Page 110-114

Ø DC_{m7} for Type UNI and VA / Ø DC_{h7} for Type Speed UNI

High Performance Drill, DIN 6537

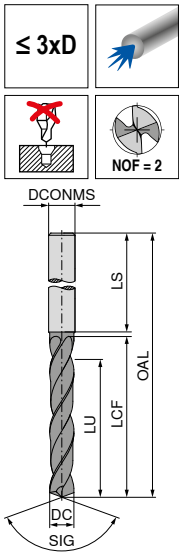

UNI	UNI	VA	VA
TiAlN	TiAlN	TiAlN	TiAlN
SIG 140° Solid carbide	SIG 140° Solid carbide	SIG 140° Solid carbide	SIG 140° Solid carbide
11 700 ...	11 701 ...	11 713 ...	11 714 ...
01000		01000	
01100		01100	
01200		01200	
01300		01300	
01400		01400	
01500		01500	
01600		01600	
01700		01700	
01800		01800	
01900		01900	
02000		02000	
02100		02100	
02200		02200	
02300		02300	
02400		02400	
02500		02500	
02600		02600	
02700		02700	
02800		02800	
02900		02900	
03000	03000	03000	03000
03100	03100	03100	03100
03200	03200	03200	03200
03250	03250		
03300	03300	03300	03300
03400	03400	03400	03400
03500	03500	03500	03500
03600	03600	03600	03600
03700	03700	03700	03700
03800	03800	03800	03800
03900	03900	03900	03900
04000	04000	04000	04000
04100	04100	04100	04100
04200	04200	04200	04200
04300	04300	04300	04300
04400	04400	04400	04400
04500	04500	04500	04500
04600	04600	04600	04600
04650	04650		
04700	04700	04700	04700
04800	04800	04800	04800

DC _{m7} mm	DCONMS _{h6} mm	OAL mm	LCF mm	LU mm	LS mm
1,00	4	45	7	5,5	28
1,10	4	45	7	5,3	28
1,20	4	45	7	5,2	28
1,30	4	45	7	5,0	28
1,40	4	45	7	4,9	28
1,50	4	55	14	11,7	28
1,60	4	55	14	11,6	28
1,70	4	55	14	11,4	28
1,80	4	55	14	11,3	28
1,90	4	55	14	11,1	28
2,00	4	55	20	17,0	28
2,10	4	55	20	16,8	28
2,20	4	55	20	16,7	28
2,30	4	55	20	16,5	28
2,40	4	55	20	16,4	28
2,50	4	55	20	16,2	28
2,60	4	55	20	16,1	28
2,70	4	55	20	15,9	28
2,80	4	55	20	15,8	28
2,90	4	55	20	15,6	28
3,00	6	62	20	15,5	36
3,10	6	62	20	15,3	36
3,20	6	62	20	15,2	36
3,25	6	62	20	15,1	36
3,30	6	62	20	15,0	36
3,40	6	62	20	14,9	36
3,50	6	62	20	14,7	36
3,60	6	62	20	14,6	36
3,70	6	62	20	14,4	36
3,80	6	66	24	18,3	36
3,90	6	66	24	18,1	36
4,00	6	66	24	18,0	36
4,10	6	66	24	17,8	36
4,20	6	66	24	17,7	36
4,30	6	66	24	17,5	36
4,40	6	66	24	17,4	36
4,50	6	66	24	17,2	36
4,60	6	66	24	17,1	36
4,65	6	66	24	17,0	36
4,70	6	66	24	16,9	36
4,80	6	66	28	20,8	36

P	●	●	○	○
M	●	●	●	●
K	●	●		
N	○	○	●	●
S			○	○
H				
O			○	○

→ v_c Page 129+133

Ø DC_{h7} for Type UNI / Ø DC_{m7} for Type VA

High Performance Drill, DIN 6537

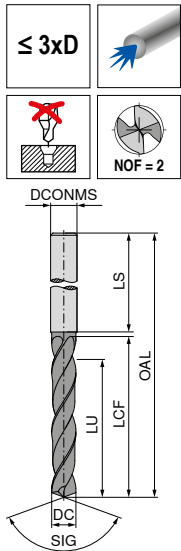

UNI	UNI	VA	VA
TiAlN	TiAlN	TiAlN	TiAlN
SIG 140° Solid carbide	SIG 140° Solid carbide	SIG 140° Solid carbide	SIG 140° Solid carbide
11 700 ...	11 701 ...	11 713 ...	11 714 ...
04900	04900	04900	04900
05000	05000	05000	05000
05100	05100	05100	05100
05200	05200	05200	05200
05300	05300	05300	05300
05400	05400	05400	05400
05500	05500	05500	05500
05600	05600	05600	05600
05650	05650		
05700	05700	05700	05700
05800	05800	05800	05800
05900	05900	05900	05900
06000	06000	06000	06000
06100	06100	06100	06100
06200	06200	06200	06200
06300	06300	06300	06300
06400	06400	06400	06400
06500	06500	06500	06500
06600	06600	06600	06600
06700	06700	06700	06700
06800	06800	06800	06800
06900	06900	06900	06900
07000	07000	07000	07000
07100	07100	07100	07100
07200	07200	07200	07200
07300	07300	07300	07300
07400	07400	07400	07400
07500	07500	07500	07500
07550	07550		
07600	07600	07600	07600
07650	07650		
07700	07700	07700	07700
07800	07800	07800	07800
07900	07900	07900	07900
08000	08000	08000	08000
08100	08100	08100	08100
08200	08200	08200	08200
08300	08300	08300	08300
08400	08400	08400	08400
08500	08500	08500	08500

DC _{mTn7}	DCONMS _{h6}	OAL	LCF	LU	LS
mm	mm	mm	mm	mm	mm
4,90	6	66	28	20,6	36
5,00	6	66	28	20,5	36
5,10	6	66	28	20,3	36
5,20	6	66	28	20,2	36
5,30	6	66	28	20,0	36
5,40	6	66	28	19,9	36
5,50	6	66	28	19,7	36
5,55	6	66	28	19,6	36
5,60	6	66	28	19,6	36
5,65	6	66	28	19,5	36
5,70	6	66	28	19,4	36
5,80	6	66	28	19,3	36
5,90	6	66	28	19,1	36
6,00	6	66	28	19,0	36
6,10	8	79	34	24,8	36
6,20	8	79	34	24,7	36
6,30	8	79	34	24,5	36
6,40	8	79	34	24,4	36
6,50	8	79	34	24,2	36
6,60	8	79	34	24,1	36
6,70	8	79	34	23,9	36
6,80	8	79	34	23,8	36
6,90	8	79	34	23,6	36
7,00	8	79	34	23,5	36
7,10	8	79	41	30,3	36
7,20	8	79	41	30,2	36
7,30	8	79	41	30,0	36
7,40	8	79	41	29,9	36
7,50	8	79	41	29,7	36
7,55	8	79	41	29,6	36
7,60	8	79	41	29,6	36
7,65	8	79	41	29,5	36
7,70	8	79	41	29,4	36
7,80	8	79	41	29,3	36
7,90	8	79	41	29,1	36
8,00	8	79	41	29,0	36
8,10	10	89	47	34,8	40
8,20	10	89	47	34,7	40
8,30	10	89	47	34,5	40
8,40	10	89	47	34,4	40
8,50	10	89	47	34,2	40

P	●	●	○	○
M	●	●	●	●
K	●	●		
N	○	○	●	●
S			○	○
H				
O			○	○

→ v_c Page 129+133

Ø DC_{h7} for Type UNI / Ø DC_{m7} for Type VA

High Performance Drill, DIN 6537

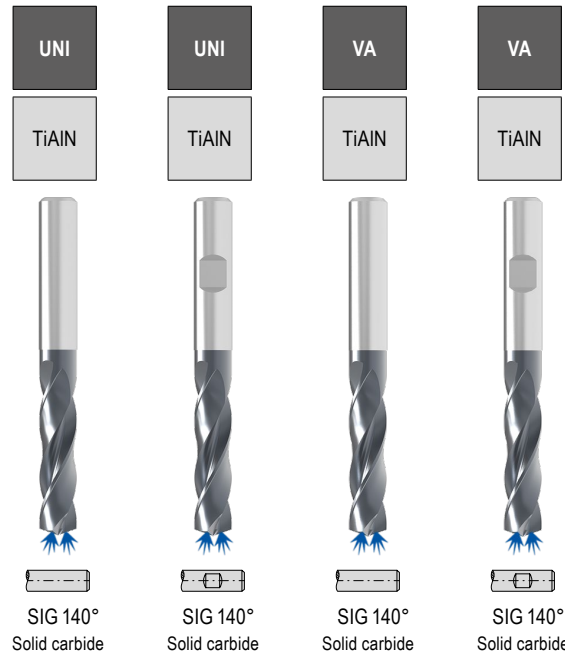
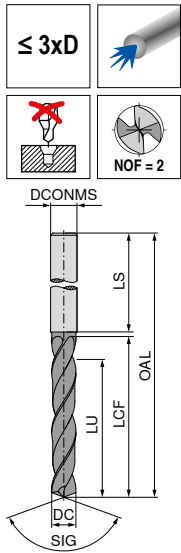

DC _{m7h7} mm	DCONMS _{h6} mm	OAL mm	LCF mm	LU mm	LS mm
8,60	10	89	47	34,1	40
8,70	10	89	47	33,9	40
8,80	10	89	47	33,8	40
8,90	10	89	47	33,6	40
9,00	10	89	47	33,5	40
9,10	10	89	47	33,3	40
9,20	10	89	47	33,2	40
9,30	10	89	47	33,0	40
9,40	10	89	47	32,9	40
9,50	10	89	47	32,7	40
9,60	10	89	47	32,6	40
9,70	10	89	47	32,4	40
9,80	10	89	47	32,3	40
9,90	10	89	47	32,1	40
10,00	10	89	47	32,0	40
10,10	12	102	55	39,8	45
10,20	12	102	55	39,7	45
10,30	12	102	55	39,5	45
10,40	12	102	55	39,4	45
10,50	12	102	55	39,2	45
10,60	12	102	55	39,1	45
10,70	12	102	55	38,9	45
10,80	12	102	55	38,8	45
10,90	12	102	55	38,6	45
11,00	12	102	55	38,5	45
11,10	12	102	55	38,3	45
11,20	12	102	55	38,2	45
11,30	12	102	55	38,0	45
11,40	12	102	55	37,9	45
11,50	12	102	55	37,7	45
11,60	12	102	55	37,6	45
11,70	12	102	55	37,4	45
11,80	12	102	55	37,3	45
11,90	12	102	55	37,1	45
12,00	12	102	55	37,0	45
12,20	14	107	60	41,7	45
12,30	14	107	60	41,5	45
12,50	14	107	60	41,2	45
12,70	14	107	60	40,9	45
12,80	14	107	60	40,8	45
12,90	14	107	60	40,6	45

11 700 ...	11 701 ...	11 713 ...	11 714 ...
08600	08600	08600	08600
08700	08700	08700	08700
08800	08800	08800	08800
08900	08900	08900	08900
09000	09000	09000	09000
09100	09100	09100	09100
09200	09200	09200	09200
09300	09300	09300	09300
09400	09400	09400	09400
09500	09500	09500	09500
09600	09600	09600	09600
09700	09700	09700	09700
09800	09800	09800	09800
09900	09900	09900	09900
10000	10000	10000	10000
10100	10100	10100	10100
10200	10200	10200	10200
10300	10300	10300	10300
10400	10400	10400	10400
10500	10500	10500	10500
10600	10600	10600	10600
10700	10700	10700	10700
10800	10800	10800	10800
10900	10900	10900	10900
11000	11000	11000	11000
11100	11100	11100	11100
11200	11200	11200	11200
11300	11300	11300	11300
11400	11400	11400	11400
11500	11500	11500	11500
11600	11600	11600	11600
11700	11700	11700	11700
11800	11800	11800	11800
11900	11900	11900	11900
12000	12000	12000	12000
12200	12200	12200	12200
12300	12300	12300	12300
12500	12500	12500	12500
12700	12700	12700	12700
12800	12800	12800	12800
12900	12900	12900	12900

P	●	●	○	○
M	●	●	●	●
K	●	●	○	○
N	○	○	●	●
S	○	○	○	○
H				
O			○	○

→ v_c Page 129+133

Ø DC_{h7} for Type UNI / Ø DC_{m7} for Type VA

High Performance Drill, DIN 6537

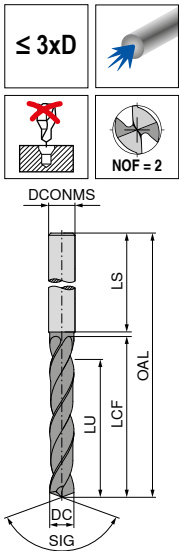

	UNI TiAlN	UNI TiAlN	VA TiAlN	VA TiAlN
	SIG 140° Solid carbide	SIG 140° Solid carbide	SIG 140° Solid carbide	SIG 140° Solid carbide
	11 700 ...	11 701 ...	11 713 ...	11 714 ...
	13000	13000	13000	13000
	13500	13500	13500	13500
	13700	13700	13700	13700
	13800	13800	13800	13800
	14000	14000	14000	14000
	14200	14200	14200	14200
	14400	14400	14400	14400
	14500	14500	14500	14500
	14700	14700	14700	14700
	14800	14800	14800	14800
	15000	15000	15000	15000
	15100	15100	15100	15100
	15200	15200	15200	15200
	15500	15500	15500	15500
	15700	15700	15700	15700
	15800	15800	15800	15800
	16000	16000	16000	16000
	16500	16500	16500	16500
	17000	17000	17000	17000
	17500	17500	17500	17500
	18000	18000	18000	18000
	18500	18500	18500	18500
	18900	18900	18900	18900
	19000	19000	19000	19000
	19300	19300	19300	19300
	19500	19500	19500	19500
	20000	20000	20000	20000

DC _{m7} mm	DCONMS _{h6} mm	OAL mm	LCF mm	LU mm	LS mm
13,00	14	107	60	40,5	45
13,50	14	107	60	39,7	45
13,70	14	107	60	39,4	45
13,80	14	107	60	39,3	45
14,00	14	107	60	39,0	45
14,20	16	115	65	43,7	48
14,40	16	115	65	43,4	48
14,50	16	115	65	43,2	48
14,70	16	115	65	42,9	48
14,80	16	115	65	42,8	48
15,00	16	115	65	42,5	48
15,10	16	115	65	42,3	48
15,20	16	115	65	42,2	48
15,50	16	115	65	41,7	48
15,70	16	115	65	41,4	48
15,80	16	115	65	41,3	48
16,00	16	115	65	41,0	48
16,50	18	123	73	48,2	48
17,00	18	123	73	47,5	48
17,50	18	123	73	46,7	48
18,00	18	123	73	46,0	48
18,50	20	131	79	51,2	50
18,90	20	131	79	50,6	50
19,00	20	131	79	50,5	50
19,30	20	131	79	50,0	50
19,50	20	131	79	49,7	50
20,00	20	131	79	49,0	50

P	●	●	○	○
M	●	●	●	●
K	●	●	○	○
N	○	○	●	●
S	○	○	○	○
H	○	○	○	○
O	○	○	○	○

→ v_c Page 129+133

Ø DC_{h7} for Type UNI / Ø DC_{m7} for Type VA

WTX – High-performance drill, DIN 6537

▲ Specialist for difficult to machine materials

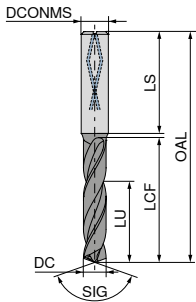
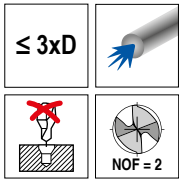

Ti
DPA54
DRAGONSKIN



SIG 140°
Solid carbide

10 786 ...

DC _{m7} mm	DCONMS _{h6} mm	OAL mm	LCF mm	LU mm	LS mm	
3,00	6	62	20	14	36	030
3,10	6	62	20	14	36	031
3,20	6	62	20	14	36	032
3,30	6	62	20	14	36	033
3,40	6	62	20	14	36	034
3,50	6	62	20	14	36	035
3,60	6	62	20	14	36	036
3,70	6	62	20	14	36	037
3,80	6	66	24	17	36	038
3,90	6	66	24	17	36	039
3,97	6	66	24	17	36	900
4,00	6	66	24	17	36	040
4,10	6	66	24	17	36	041
4,20	6	66	24	17	36	042
4,23	6	66	24	17	36	901
4,30	6	66	24	17	36	043
4,40	6	66	24	17	36	044
4,50	6	66	24	17	36	045
4,60	6	66	24	17	36	046
4,70	6	66	24	17	36	047
4,80	6	66	28	20	36	048
4,90	6	66	28	20	36	049
5,00	6	66	28	20	36	050
5,10	6	66	28	20	36	051
5,20	6	66	28	20	36	052
5,30	6	66	28	20	36	053
5,40	6	66	28	20	36	054
5,50	6	66	28	20	36	055
5,56	6	66	28	20	36	902
5,60	6	66	28	20	36	056
5,70	6	66	28	20	36	057
5,80	6	66	28	20	36	058
5,90	6	66	28	20	36	059
6,00	6	66	28	20	36	060
6,10	8	79	34	24	36	061
6,20	8	79	34	24	36	062
6,30	8	79	34	24	36	063
6,35	8	79	34	24	36	903
6,40	8	79	34	24	36	064
6,50	8	79	34	24	36	065
6,60	8	79	34	24	36	066
6,70	8	79	34	24	36	067
6,80	8	79	34	24	36	068
6,90	8	79	34	24	36	069
7,00	8	79	34	24	36	070
7,10	8	79	41	29	36	071
7,20	8	79	41	29	36	072
7,30	8	79	41	29	36	073
7,40	8	79	41	29	36	074
7,50	8	79	41	29	36	075
7,60	8	79	41	29	36	076

10 786 ...

DC _{m7} mm	DCONMS _{h6} mm	OAL mm	LCF mm	LU mm	LS mm	
7,70	8	79	41	29	36	077
7,80	8	79	41	29	36	078
7,90	8	79	41	29	36	079
7,94	8	79	41	29	36	904
8,00	8	79	41	29	36	080
8,10	10	89	47	35	40	081
8,20	10	89	47	35	40	082
8,30	10	89	47	35	40	083
8,40	10	89	47	35	40	084
8,50	10	89	47	35	40	085
8,60	10	89	47	35	40	086
8,70	10	89	47	35	40	087
8,80	10	89	47	35	40	088
8,90	10	89	47	35	40	089
9,00	10	89	47	35	40	090
9,10	10	89	47	35	40	091
9,20	10	89	47	35	40	092
9,30	10	89	47	35	40	093
9,40	10	89	47	35	40	094
9,50	10	89	47	35	40	095
9,53	10	89	47	35	40	905
9,60	10	89	47	35	40	096
9,70	10	89	47	35	40	097
9,80	10	89	47	35	40	098
9,90	10	89	47	35	40	099
10,00	10	89	47	35	40	100
10,10	12	102	55	40	45	101
10,20	12	102	55	40	45	102
10,30	12	102	55	40	45	103
10,40	12	102	55	40	45	104
10,50	12	102	55	40	45	105
10,60	12	102	55	40	45	106
10,70	12	102	55	40	45	107
10,80	12	102	55	40	45	108
10,90	12	102	55	40	45	109
11,00	12	102	55	40	45	110
11,10	12	102	55	40	45	111
11,11	12	102	55	40	45	906
11,20	12	102	55	40	45	112
11,30	12	102	55	40	45	113
11,40	12	102	55	40	45	114
11,50	12	102	55	40	45	115
11,60	12	102	55	40	45	116
11,70	12	102	55	40	45	117
11,80	12	102	55	40	45	118
11,90	12	102	55	40	45	119
12,00	12	102	55	40	45	120
12,10	14	107	60	43	45	121
12,20	14	107	60	43	45	122
12,30	14	107	60	43	45	123
12,40	14	107	60	43	45	124
12,50	14	107	60	43	45	125
12,60	14	107	60	43	45	126
12,70	14	107	60	43	45	907
12,80	14	107	60	43	45	128
12,90	14	107	60	43	45	129
13,00	14	107	60	43	45	130
13,10	14	107	60	43	45	131
13,20	14	107	60	43	45	132
13,30	14	107	60	43	45	133
13,40	14	107	60	43	45	134
13,50	14	107	60	43	45	135
13,60	14	107	60	43	45	136
13,70	14	107	60	43	45	137
13,80	14	107	60	43	45	138
13,90	14	107	60	43	45	139

P	○
M	●
K	
N	
S	●
H	
O	

→ v. Page 109

WTX – High-performance drill, DIN 6537

▲ Specialist for difficult to machine materials

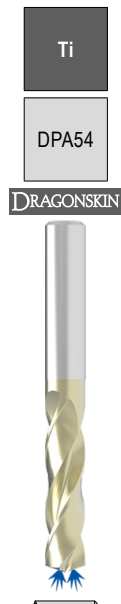
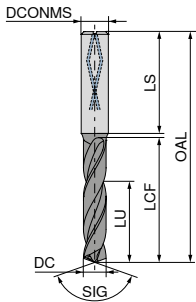
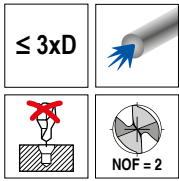

SIG 140°
Solid carbide

10 786 ...

DC _{m7} mm	DCONMS _{h6} mm	OAL mm	LCF mm	LU mm	LS mm	
19,1	20	131	79	55	50	191
19,2	20	131	79	55	50	192
19,3	20	131	79	55	50	193
19,4	20	131	79	55	50	194
19,5	20	131	79	55	50	195
19,6	20	131	79	55	50	196
19,7	20	131	79	55	50	197
19,8	20	131	79	55	50	198
19,9	20	131	79	55	50	199
20,0	20	131	79	55	50	200

P	○
M	●
K	
N	
S	●
H	
O	

→ v_c Page 109

10 786 ...

DC _{m7} mm	DCONMS _{h6} mm	OAL mm	LCF mm	LU mm	LS mm	
14,0	14	107	60	43	45	140
14,1	16	115	65	45	48	141
14,2	16	115	65	45	48	142
14,3	16	115	65	45	48	143
14,4	16	115	65	45	48	144
14,5	16	115	65	45	48	145
14,6	16	115	65	45	48	146
14,7	16	115	65	45	48	147
14,8	16	115	65	45	48	148
14,9	16	115	65	45	48	149
15,0	16	115	65	45	48	150
15,1	16	115	65	45	48	151
15,2	16	115	65	45	48	152
15,3	16	115	65	45	48	153
15,4	16	115	65	45	48	154
15,5	16	115	65	45	48	155
15,6	16	115	65	45	48	156
15,7	16	115	65	45	48	157
15,8	16	115	65	45	48	158
15,9	16	115	65	45	48	159
16,0	16	115	65	45	48	160
16,1	18	123	73	51	48	161
16,2	18	123	73	51	48	162
16,3	18	123	73	51	48	163
16,4	18	123	73	51	48	164
16,5	18	123	73	51	48	165
16,6	18	123	73	51	48	166
16,7	18	123	73	51	48	167
16,8	18	123	73	51	48	168
16,9	18	123	73	51	48	169
17,0	18	123	73	51	48	170
17,1	18	123	73	51	48	171
17,2	18	123	73	51	48	172
17,3	18	123	73	51	48	173
17,4	18	123	73	51	48	174
17,5	18	123	73	51	48	175
17,6	18	123	73	51	48	176
17,7	18	123	73	51	48	177
17,8	18	123	73	51	48	178
17,9	18	123	73	51	48	179
18,0	18	123	73	51	48	180
18,1	20	131	79	55	50	181
18,2	20	131	79	55	50	182
18,3	20	131	79	55	50	183
18,4	20	131	79	55	50	184
18,5	20	131	79	55	50	185
18,6	20	131	79	55	50	186
18,7	20	131	79	55	50	187
18,8	20	131	79	55	50	188
18,9	20	131	79	55	50	189
19,0	20	131	79	55	50	190

WTX – High Performance Drill, DIN 6537

▲ universal application
▲ four guidance lands

▲ polished chip flutes
▲ Type ALU 3xD on request

▲ PL = corner chamfers

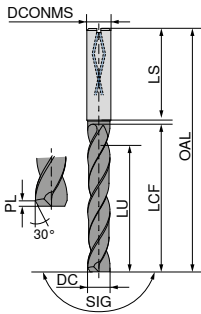
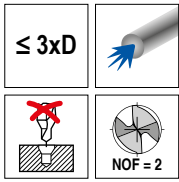

180
Ti800



SIG 180°
Solid carbide

10 720 ...

DC _{m7} mm	DCONMS _{h6} mm	OAL mm	LCF mm	LU mm	LS mm	PL mm	
3,00	6	62	20	14	36	0,15	030
3,10	6	62	20	14	36	0,16	031
3,20	6	62	20	14	36	0,16	032
3,30	6	62	20	14	36	0,17	033
3,40	6	62	20	14	36	0,17	034
3,50	6	62	20	14	36	0,18	035
3,60	6	62	20	14	36	0,18	036
3,70	6	62	20	14	36	0,19	037
3,80	6	66	24	17	36	0,19	038
3,90	6	66	24	17	36	0,20	039
4,00	6	66	24	17	36	0,20	040
4,10	6	66	24	17	36	0,21	041
4,20	6	66	24	17	36	0,21	042
4,30	6	66	24	17	36	0,22	043
4,40	6	66	24	17	36	0,22	044
4,50	6	66	24	17	36	0,23	045
4,60	6	66	24	17	36	0,23	046
4,65	6	66	24	17	36	0,23	900
4,70	6	66	24	17	36	0,24	047
4,80	6	66	28	20	36	0,24	048
4,90	6	66	28	20	36	0,25	049
5,00	6	66	28	20	36	0,25	050
5,10	6	66	28	20	36	0,26	051
5,20	6	66	28	20	36	0,26	052
5,30	6	66	28	20	36	0,27	053
5,40	6	66	28	20	36	0,27	054
5,50	6	66	28	20	36	0,28	055
5,55	6	66	28	20	36	0,28	902
5,60	6	66	28	20	36	0,28	056
5,70	6	66	28	20	36	0,29	057
5,80	6	66	28	20	36	0,29	058
5,90	6	66	28	20	36	0,30	059
6,00	6	66	28	20	36	0,30	060
6,10	8	79	34	24	36	0,31	061
6,20	8	79	34	24	36	0,31	062
6,30	8	79	34	24	36	0,32	063
6,40	8	79	34	24	36	0,32	064
6,50	8	79	34	24	36	0,33	065
6,60	8	79	34	24	36	0,33	066
6,70	8	79	34	24	36	0,34	067
6,80	8	79	34	24	36	0,34	068
6,90	8	79	34	24	36	0,35	069
7,00	8	79	34	24	36	0,35	070
7,10	8	79	41	29	36	0,36	071
7,20	8	79	41	29	36	0,36	072
7,30	8	79	41	29	36	0,37	073
7,40	8	79	41	29	36	0,37	074
7,50	8	79	41	29	36	0,38	075
7,60	8	79	41	29	36	0,38	076
7,70	8	79	41	29	36	0,39	077
7,80	8	79	41	29	36	0,39	078
7,90	8	79	41	29	36	0,40	079
8,00	8	79	41	29	36	0,40	080
8,10	10	89	47	35	40	0,41	081

10 720 ...

DC _{m7} mm	DCONMS _{h6} mm	OAL mm	LCF mm	LU mm	LS mm	PL mm	
8,20	10	89	47	35	40	0,41	082
8,30	10	89	47	35	40	0,42	083
8,40	10	89	47	35	40	0,42	084
8,50	10	89	47	35	40	0,43	085
8,60	10	89	47	35	40	0,43	086
8,70	10	89	47	35	40	0,44	087
8,80	10	89	47	35	40	0,44	088
8,90	10	89	47	35	40	0,45	089
9,00	10	89	47	35	40	0,45	090
9,10	10	89	47	35	40	0,46	091
9,20	10	89	47	35	40	0,46	092
9,30	10	89	47	35	40	0,47	093
9,40	10	89	47	35	40	0,47	094
9,50	10	89	47	35	40	0,48	095
9,60	10	89	47	35	40	0,48	096
9,70	10	89	47	35	40	0,49	097
9,80	10	89	47	35	40	0,49	098
9,90	10	89	47	35	40	0,50	099
10,00	10	89	47	35	40	0,50	100
10,10	12	100	53	38	45	0,51	101
10,20	12	100	53	38	45	0,51	102
10,30	12	100	53	38	45	0,52	103
10,40	12	100	53	38	45	0,52	104
10,50	12	100	53	38	45	0,53	105
10,60	12	100	53	38	45	0,53	106
10,70	12	100	53	38	45	0,54	107
10,80	12	100	53	38	45	0,54	108
10,90	12	100	53	38	45	0,55	109
11,00	12	100	53	38	45	0,55	110
11,10	12	100	53	38	45	0,56	111
11,20	12	100	53	38	45	0,56	112
11,30	12	100	53	38	45	0,57	113
11,40	12	100	53	38	45	0,57	114
11,50	12	100	53	38	45	0,58	115
11,60	12	100	53	38	45	0,58	116
11,70	12	100	53	38	45	0,59	117
11,80	12	100	53	38	45	0,59	118
11,90	12	100	53	38	45	0,60	119
12,00	12	100	53	38	45	0,60	120
12,50	14	105	58	41	45	0,63	125
12,80	14	105	58	41	45	0,64	128
13,00	14	105	58	41	45	0,65	130
13,50	14	105	58	41	45	0,68	135
13,80	14	105	58	41	45	0,69	138
14,00	14	105	58	41	45	0,70	140
14,50	16	113	63	43	48	0,73	145
14,80	16	113	63	43	48	0,74	148
15,00	16	113	63	43	48	0,75	150
15,50	16	113	63	43	48	0,78	155
15,80	16	113	63	43	48	0,79	158
16,00	16	113	63	43	48	0,80	160
16,50	18	121	71	49	48	0,83	165
16,80	18	121	71	49	48	0,84	168
17,00	18	121	71	49	48	0,85	170
17,50	18	121	71	49	48	0,88	175
17,80	18	121	71	49	48	0,89	178
18,00	18	121	71	49	48	0,90	180
18,50	20	129	77	53	50	0,93	185
18,80	20	129	77	53	50	0,94	188
19,00	20	129	77	53	50	0,95	190
19,50	20	129	77	53	50	0,98	195
19,80	20	129	77	53	50	0,99	198
20,00	20	129	77	53	50	1,00	200

P	●
M	●
K	●
N	
S	
H	
O	

→ v_c Page 126

→ Machining information: Page 127

WTX – High Speed Drill, DIN 6537

- ▲ Four fluted high-feed drill
- ▲ Specially designed for steel and cast iron machining

- ▲ Has four spiral coolant holes
- ▲ Innovative cutting edge geometry guarantees high positioning accuracy

- ▲ Outstanding drilling quality in terms of tolerance, surface finish and position

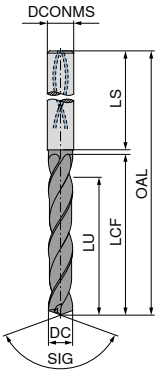
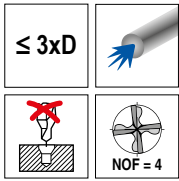

HFDS
DPX14S
DRAGONSKIN



SIG 130°
Solid carbide

10 797 ...

DC _{m7} mm	DCONMS _{h6} mm	OAL mm	LCF mm	LU mm	LS mm	
6,0	8	79	41	29	36	06000
6,1	10	89	47	35	40	06100
6,2	10	89	47	35	40	06200
6,3	10	89	47	35	40	06300
6,4	10	89	47	35	40	06400
6,5	10	89	47	35	40	06500
6,6	10	89	47	35	40	06600
6,7	10	89	47	35	40	06700
6,8	10	89	47	35	40	06800
6,9	10	89	47	35	40	06900
7,0	10	89	47	35	40	07000
7,1	10	89	47	35	40	07100
7,2	10	89	47	35	40	07200
7,3	10	89	47	35	40	07300
7,4	10	89	47	35	40	07400
7,5	10	89	47	35	40	07500
7,6	10	89	47	35	40	07600
7,7	10	89	47	35	40	07700
7,8	10	89	47	35	40	07800
7,9	10	89	47	35	40	07900
8,0	10	89	47	35	40	08000
8,1	12	102	55	40	45	08100
8,2	12	102	55	40	45	08200
8,3	12	102	55	40	45	08300
8,4	12	102	55	40	45	08400
8,5	12	102	55	40	45	08500
8,6	12	102	55	40	45	08600
8,7	12	102	55	40	45	08700
8,8	12	102	55	40	45	08800
8,9	12	102	55	40	45	08900
9,0	12	102	55	40	45	09000
9,1	12	102	55	40	45	09100
9,2	12	102	55	40	45	09200
9,3	12	102	55	40	45	09300
9,4	12	102	55	40	45	09400
9,5	12	102	55	40	45	09500
9,6	12	102	55	40	45	09600
9,7	12	102	55	40	45	09700
9,8	12	102	55	40	45	09800
9,9	12	102	55	40	45	09900
10,0	12	102	55	40	45	10000
10,2	14	107	60	43	45	10200
10,5	14	107	60	43	45	10500
11,0	14	107	60	43	45	11000
11,5	14	107	60	43	45	11500
12,0	14	107	60	43	45	12000
12,5	16	115	65	45	48	12500
13,0	16	115	65	45	48	13000

DC _{m7} mm	DCONMS _{h6} mm	OAL mm	LCF mm	LU mm	LS mm	
14,0	16	115	65	45	48	14000
14,3	18	123	73	51	48	14300
14,5	18	123	73	51	48	14500
15,0	18	123	73	51	48	15000
16,0	18	123	73	51	48	16000

10 797 ...

P	●
M	○
K	●
N	○
S	○
H	○
O	○

→ v_c Page 125

WTX – High Performance Drill, DIN 6537

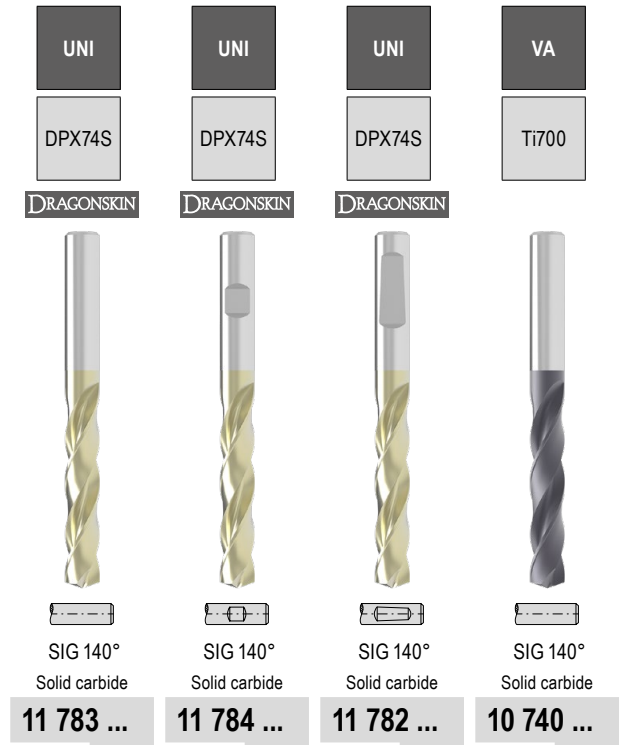
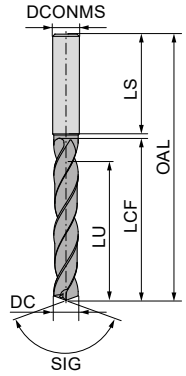
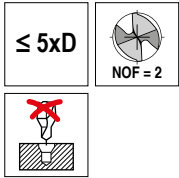

DC _{m7} mm	DCONMS _{h6} mm	OAL mm	LCF mm	LU mm	LS mm	11 783 ...	11 784 ...	11 782 ...	10 740 ...
3,00	6	66	28	23	36	03000	03000	03000	030
3,10	6	66	28	23	36	03100	03100	03100	031
3,15	6	66	28	23	36	03150	03150	03150	031
3,20	6	66	28	23	36	03200	03200	03200	032
3,22	6	66	28	23	36	03220	03220	03220	032
3,25	6	66	28	23	36	03250	03250	03250	032
3,30	6	66	28	23	36	03300	03300	03300	033
3,40	6	66	28	23	36	03400	03400	03400	034
3,50	6	66	28	23	36	03500	03500	03500	035
3,60	6	66	28	23	36	03600	03600	03600	036
3,70	6	66	28	23	36	03700	03700	03700	037
3,80	6	74	36	29	36	03800	03800	03800	038
3,85	6	74	36	29	36	03850	03850	03850	038
3,90	6	74	36	29	36	03900	03900	03900	039
4,00	6	74	36	29	36	04000	04000	04000	040
4,10	6	74	36	29	36	04100	04100	04100	041
4,20	6	74	36	29	36	04200	04200	04200	042
4,25	6	74	36	29	36	04250	04250	04250	042
4,30	6	74	36	29	36	04300	04300	04300	043
4,35	6	74	36	29	36	04350	04350	04350	043
4,40	6	74	36	29	36	04400	04400	04400	044
4,45	6	74	36	29	36	04450	04450	04450	044
4,50	6	74	36	29	36	04500	04500	04500	045
4,60	6	74	36	29	36	04600	04600	04600	046
4,65	6	74	36	29	36	04650	04650	04650	046
4,70	6	74	36	29	36	04700	04700	04700	047
4,80	6	82	44	35	36	04800	04800	04800	048
4,90	6	82	44	35	36	04900	04900	04900	049
4,95	6	82	44	35	36	04950	04950	04950	049
5,00	6	82	44	35	36	05000	05000	05000	050
5,05	6	82	44	35	36	05050	05050	05050	050
5,10	6	82	44	35	36	05100	05100	05100	051
5,20	6	82	44	35	36	05200	05200	05200	052
5,30	6	82	44	35	36	05300	05300	05300	053
5,40	6	82	44	35	36	05400	05400	05400	054
5,50	6	82	44	35	36	05500	05500	05500	055
5,55	6	82	44	35	36	05550	05550	05550	055
5,60	6	82	44	35	36	05600	05600	05600	056
5,70	6	82	44	35	36	05700	05700	05700	057
5,75	6	82	44	35	36	05750	05750	05750	057
5,80	6	82	44	35	36	05800	05800	05800	058
5,90	6	82	44	35	36	05900	05900	05900	059

P	●	●	●	○
M				●
K	●	●	●	○
N				○
S				●
H	○	○	○	
O				

WTX – High Performance Drill, DIN 6537

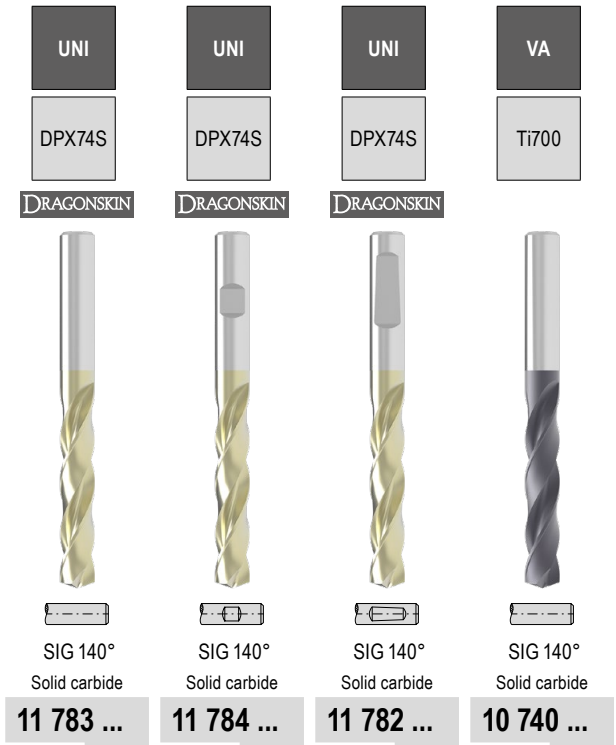
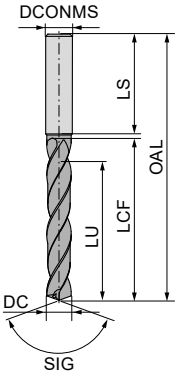
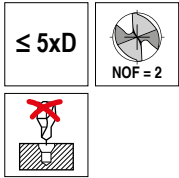

DC _{m7} mm	DCONMS _{h6} mm	OAL mm	LCF mm	LU mm	LS mm	11 783 ...	11 784 ...	11 782 ...	10 740 ...
5,95	6	82	44	35	36	05950	05950	05950	
6,00	6	82	44	35	36	06000	06000	06000	060
6,10	8	91	53	43	36	06100	06100	06100	061
6,20	8	91	53	43	36	06200	06200	06200	062
6,30	8	91	53	43	36	06300	06300	06300	063
6,40	8	91	53	43	36	06400	06400	06400	064
6,50	8	91	53	43	36	06500	06500	06500	065
6,60	8	91	53	43	36	06600	06600	06600	066
6,70	8	91	53	43	36	06700	06700	06700	067
6,80	8	91	53	43	36	06800	06800	06800	068
6,90	8	91	53	43	36	06900	06900	06900	069
7,00	8	91	53	43	36	07000	07000	07000	070
7,10	8	91	53	43	36	07100	07100	07100	071
7,20	8	91	53	43	36	07200	07200	07200	072
7,30	8	91	53	43	36	07300	07300	07300	073
7,40	8	91	53	43	36	07400	07400	07400	074
7,45	8	91	53	43	36	07450	07450	07450	
7,50	8	91	53	43	36	07500	07500	07500	075
7,60	8	91	53	43	36	07600	07600	07600	076
7,70	8	91	53	43	36	07700	07700	07700	077
7,80	8	91	53	43	36	07800	07800	07800	078
7,90	8	91	53	43	36	07900	07900	07900	079
8,00	8	91	53	43	36	08000	08000	08000	080
8,10	10	103	61	49	40	08100	08100	08100	081
8,20	10	103	61	49	40	08200	08200	08200	082
8,30	10	103	61	49	40	08300	08300	08300	083
8,40	10	103	61	49	40	08400	08400	08400	084
8,50	10	103	61	49	40	08500	08500	08500	085
8,60	10	103	61	49	40	08600	08600	08600	086
8,70	10	103	61	49	40	08700	08700	08700	087
8,80	10	103	61	49	40	08800	08800	08800	088
8,90	10	103	61	49	40	08900	08900	08900	089
9,00	10	103	61	49	40	09000	09000	09000	090
9,10	10	103	61	49	40	09100	09100	09100	091
9,20	10	103	61	49	40	09200	09200	09200	092
9,30	10	103	61	49	40	09300	09300	09300	093
9,35	10	103	61	49	40	09350	09350	09350	
9,40	10	103	61	49	40	09400	09400	09400	094
9,45	10	103	61	49	40	09450	09450	09450	
9,50	10	103	61	49	40	09500	09500	09500	095
9,60	10	103	61	49	40	09600	09600	09600	096
9,70	10	103	61	49	40	09700	09700	09700	097

P	●	●	●	○
M				●
K	●	●	●	○
N				○
S				●
H	○	○	○	
O				

→ v_c Page 111+112

WTX – High Performance Drill, DIN 6537

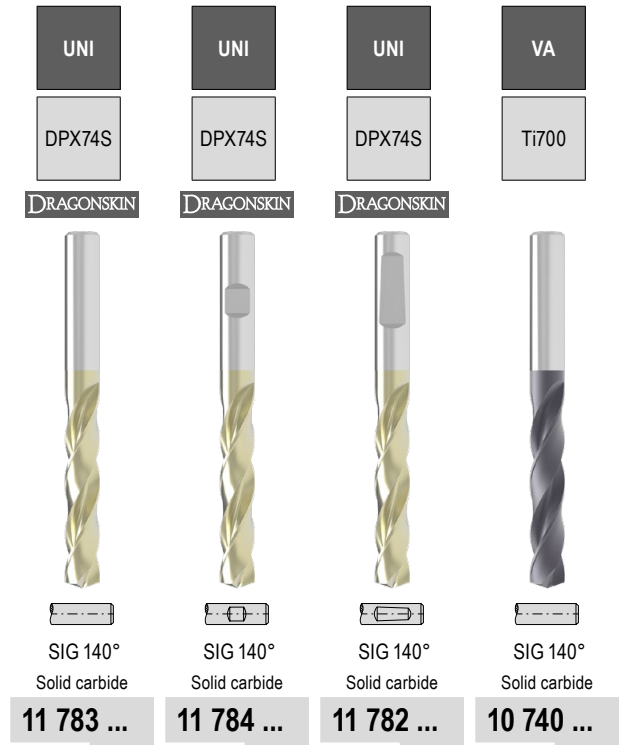
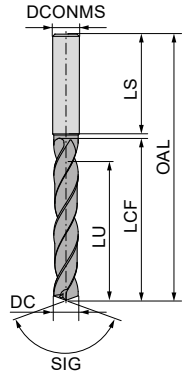
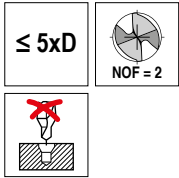

DC _{m7} mm	DCONMS _{h6} mm	OAL mm	LCF mm	LU mm	LS mm	11 783 ...	11 784 ...	11 782 ...	10 740 ...
9,80	10	103	61	49	40	09800	09800	09800	098
9,90	10	103	61	49	40	09900	09900	09900	099
10,00	10	103	61	49	40	10000	10000	10000	100
10,10	12	118	71	56	45	10100	10100	10100	101
10,20	12	118	71	56	45	10200	10200	10200	102
10,30	12	118	71	56	45	10300	10300	10300	103
10,40	12	118	71	56	45	10400	10400	10400	104
10,50	12	118	71	56	45	10500	10500	10500	105
10,55	12	118	71	56	45	10550	10550	10550	
10,60	12	118	71	56	45	10600	10600	10600	106
10,70	12	118	71	56	45	10700	10700	10700	107
10,75	12	118	71	56	45	10750	10750	10750	
10,80	12	118	71	56	45	10800	10800	10800	108
10,90	12	118	71	56	45	10900	10900	10900	109
11,00	12	118	71	56	45	11000	11000	11000	110
11,10	12	118	71	56	45	11100	11100	11100	111
11,20	12	118	71	56	45	11200	11200	11200	112
11,25	12	118	71	56	45	11250	11250	11250	
11,30	12	118	71	56	45	11300	11300	11300	113
11,35	12	118	71	56	45	11350	11350	11350	
11,40	12	118	71	56	45	11400	11400	11400	114
11,45	12	118	71	56	45	11450	11450	11450	
11,50	12	118	71	56	45	11500	11500	11500	115
11,60	12	118	71	56	45	11600	11600	11600	116
11,70	12	118	71	56	45	11700	11700	11700	117
11,80	12	118	71	56	45	11800	11800	11800	118
11,90	12	118	71	56	45	11900	11900	11900	119
12,00	12	118	71	56	45	12000	12000	12000	120
12,15	14	124	77	60	45	12150	12150	12150	
12,25	14	124	77	60	45	12250	12250	12250	
12,50	14	124	77	60	45	12500	12500	12500	125
12,55	14	124	77	60	45	12550	12550	12550	
12,70	14	124	77	60	45	12700	12700	12700	
12,80	14	124	77	60	45	12800	12800	12800	128
12,90	14	124	77	60	45	12900	12900	12900	
13,00	14	124	77	60	45	13000	13000	13000	130
13,10	14	124	77	60	45	13100	13100	13100	
13,30	14	124	77	60	45	13300	13300	13300	
13,35	14	124	77	60	45	13350	13350	13350	
13,50	14	124	77	60	45	13500	13500	13500	135
13,70	14	124	77	60	45	13700	13700	13700	
13,80	14	124	77	60	45	13800	13800	13800	138

P	●	●	●	○
M				●
K	●	●	●	○
N				○
S				●
H	○	○	○	
O				

WTX – High Performance Drill, DIN 6537

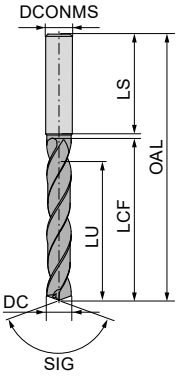
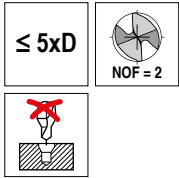

	UNI DPX74S DRAGONSKIN	UNI DPX74S DRAGONSKIN	UNI DPX74S DRAGONSKIN	VA Ti700
	SIG 140° Solid carbide	SIG 140° Solid carbide	SIG 140° Solid carbide	SIG 140° Solid carbide
	11 783 ...	11 784 ...	11 782 ...	10 740 ...
DC_{m7} mm				
14,00	14000	14000	14000	140
14,20	14200	14200	14200	
14,50	14500	14500	14500	145
14,80	14800	14800	14800	148
15,00	15000	15000	15000	150
15,10	15100	15100	15100	
15,25	15250	15250	15250	
15,30	15300	15300	15300	
15,35	15350	15350	15350	
15,50	15500	15500	15500	155
15,60	15600	15600	15600	
15,80	15800	15800	15800	158
16,00	16000	16000	16000	160
16,05	16050	16050	16050	
16,50	16500	16500	16500	165
16,80	16800	16800	16800	168
16,90	16900	16900	16900	
17,00	17000	17000	17000	170
17,50	17500	17500	17500	175
17,60	17600	17600	17600	
17,80	17800	17800	17800	178
18,00	18000	18000	18000	180
18,50	18500	18500	18500	185
18,80	18800	18800	18800	188
18,90	18900	18900	18900	
19,00	19000	19000	19000	190
19,35	19350	19350	19350	
19,50	19500	19500	19500	195
19,60	19600	19600	19600	
19,80	19800	19800	19800	198
20,00	20000	20000	20000	200
P	●	●	●	○
M				●
K	●	●	●	○
N				○
S				●
H	○	○	○	
O				

→ v_c Page 111+112

High Performance Drill, DIN 6537

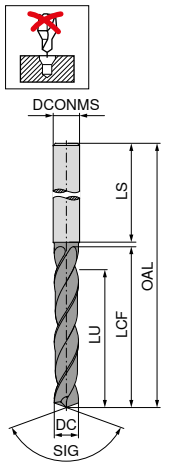

DC _{h7} mm	DCONMS _{h6} mm	OAL mm	LCF mm	LU mm	LS mm	11 710 ...	11 709 ...
3,00	6	66	28	23,5	36	03000	03000
3,10	6	66	28	23,3	36	03100	03100
3,20	6	66	28	23,2	36	03200	03200
3,25	6	66	28	23,1	36	03250	03250
3,30	6	66	28	23,0	36	03300	03300
3,40	6	66	28	22,9	36	03400	03400
3,50	6	66	28	22,7	36	03500	03500
3,60	6	66	28	22,6	36	03600	03600
3,70	6	66	28	22,4	36	03700	03700
3,80	6	74	36	30,3	36	03800	03800
3,90	6	74	36	30,1	36	03900	03900
4,00	6	74	36	30,0	36	04000	04000
4,10	6	74	36	29,8	36	04100	04100
4,20	6	74	36	29,7	36	04200	04200
4,30	6	74	36	29,5	36	04300	04300
4,40	6	74	36	29,4	36	04400	04400
4,50	6	74	36	29,2	36	04500	04500
4,60	6	74	36	29,1	36	04600	04600
4,65	6	74	36	29,0	36	04650	04650
4,70	6	74	36	28,9	36	04700	04700
4,80	6	82	44	36,8	36	04800	04800
4,90	6	82	44	36,6	36	04900	04900
5,00	6	82	44	36,5	36	05000	05000
5,10	6	82	44	36,3	36	05100	05100
5,20	6	82	44	36,2	36	05200	05200
5,30	6	82	44	36,0	36	05300	05300
5,40	6	82	44	35,9	36	05400	05400
5,50	6	82	44	35,7	36	05500	05500
5,55	6	82	44	35,6	36	05550	05550
5,60	6	82	44	35,6	36	05600	05600
5,65	6	82	44	35,5	36	05650	05650
5,70	6	82	44	35,4	36	05700	05700
5,80	6	82	44	35,3	36	05800	05800
5,90	6	82	44	35,1	36	05900	05900
6,00	6	82	44	35,0	36	06000	06000
6,10	8	91	53	43,8	36	06100	06100
6,20	8	91	53	43,7	36	06200	06200
6,30	8	91	53	43,5	36	06300	06300
6,40	8	91	53	43,4	36	06400	06400
6,50	8	91	53	43,2	36	06500	06500
6,60	8	91	53	43,1	36	06600	06600
6,70	8	91	53	42,9	36	06700	06700
6,80	8	91	53	42,8	36	06800	06800
6,90	8	91	53	42,6	36	06900	06900
7,00	8	91	53	42,5	36	07000	07000
7,10	8	91	53	42,3	36	07100	07100
7,20	8	91	53	42,2	36	07200	07200
7,30	8	91	53	42,0	36	07300	07300
7,40	8	91	53	41,9	36	07400	07400
7,50	8	91	53	41,7	36	07500	07500
7,55	8	91	53	41,6	36	07550	07550
7,60	8	91	53	41,6	36	07600	07600
7,65	8	91	53	41,5	36	07650	07650
7,70	8	91	53	41,4	36	07700	07700
7,80	8	91	53	41,3	36	07800	07800
7,90	8	91	53	41,1	36	07900	07900
8,00	8	91	53	41,0	36	08000	08000
8,10	10	103	61	48,8	40	08100	08100

DC _{h7} mm	DCONMS _{h6} mm	OAL mm	LCF mm	LU mm	LS mm	11 710 ...	11 709 ...
8,20	10	103	61	48,7	40	08200	08200
8,30	10	103	61	48,5	40	08300	08300
8,40	10	103	61	48,4	40	08400	08400
8,50	10	103	61	48,2	40	08500	08500
8,60	10	103	61	48,1	40	08600	08600
8,70	10	103	61	47,9	40	08700	08700
8,80	10	103	61	47,8	40	08800	08800
8,90	10	103	61	47,6	40	08900	08900
9,00	10	103	61	47,5	40	09000	09000
9,10	10	103	61	47,3	40	09100	09100
9,20	10	103	61	47,2	40	09200	09200
9,30	10	103	61	47,0	40	09300	09300
9,40	10	103	61	46,9	40	09400	09400
9,50	10	103	61	46,7	40	09500	09500
9,60	10	103	61	46,6	40	09600	09600
9,70	10	103	61	46,4	40	09700	09700
9,80	10	103	61	46,3	40	09800	09800
9,90	10	103	61	46,1	40	09900	09900
10,00	10	103	61	46,0	40	10000	10000
10,10	12	118	71	55,8	45	10100	10100
10,20	12	118	71	55,7	45	10200	10200
10,30	12	118	71	55,5	45	10300	10300
10,40	12	118	71	55,4	45	10400	10400
10,50	12	118	71	55,2	45	10500	10500
10,60	12	118	71	55,1	45	10600	10600
10,70	12	118	71	54,9	45	10700	10700
10,80	12	118	71	54,8	45	10800	10800
10,90	12	118	71	54,6	45	10900	10900
11,00	12	118	71	54,5	45	11000	11000
11,10	12	118	71	54,3	45	11100	11100
11,20	12	118	71	54,2	45	11200	11200
11,30	12	118	71	54,0	45	11300	11300
11,40	12	118	71	53,9	45	11400	11400
11,50	12	118	71	53,7	45	11500	11500
11,60	12	118	71	53,6	45	11600	11600
11,70	12	118	71	53,4	45	11700	11700
11,80	12	118	71	53,3	45	11800	11800
11,90	12	118	71	53,1	45	11900	11900
12,00	12	118	71	53,0	45	12000	12000
12,10	14	124	77	58,8	45	12100	12100
12,20	14	124	77	58,7	45	12200	12200
12,50	14	124	77	58,2	45	12500	12500
12,70	14	124	77	57,9	45	12700	12700
12,80	14	124	77	57,8	45	12800	12800
13,00	14	124	77	57,5	45	13000	13000
13,20	14	124	77	57,2	45	13200	13200
13,50	14	124	77	56,7	45	13500	13500
13,80	14	124	77	56,3	45	13800	13800
14,00	14	124	77	56,0	45	14000	14000
14,20	16	133	83	61,7	48	14200	14200
14,40	16	133	83	61,4	48	14400	14400
14,50	16	133	83	61,2	48	14500	14500
14,80	16	133	83	60,8	48	14800	14800
15,00	16	133	83	60,5	48	15000	15000
15,20	16	133	83	60,2	48	15200	15200
15,50	16	133	83	59,7	48	15500	15500
15,80	16	133	83	59,3	48	15800	15800
16,00	16	133	83	59,0	48	16000	16000
16,50	18	143	93	68,2	48	16500	16500
17,00	18	143	93	67,5	48	17000	17000
17,50	18	143	93	66,7	48	17500	17500
18,00	18	143	93	66,0	48	18000	18000
18,50	20	153	101	73,2	50	18500	18500
18,90	20	153	101	72,6	50	18900	18900
19,00	20	153	101	72,5	50	19000	19000
19,50	20	153	101	71,7	50	19500	19500
20,00	20	153	101	71,0	50	20000	20000

P	●	●
M		
K	●	●
N		
S		
H		
O		

Twist drill similar to DIN 338

- ▲ Helix angle 30°
- ▲ Shank Ø h7

≤ 5xD

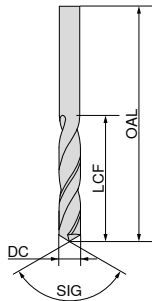

N



SIG 118°
Solid carbide

10 710 ...

DC _{h7} mm	OAL mm	LCF mm	
0,5	22	6	005
0,6	24	7	006
0,7	28	9	007
0,8	30	10	008
0,9	32	11	009
1,0	34	12	010
1,1	36	14	011
1,2	38	16	012
1,3	38	16	013
1,4	40	18	014
1,5	40	18	015
1,6	43	20	016
1,7	43	20	017
1,8	46	22	018
1,9	46	22	019
2,0	49	24	020
2,1	49	24	021
2,2	53	27	022
2,3	53	27	023
2,4	57	30	024
2,5	57	30	025
2,6	57	30	026
2,7	61	33	027
2,8	61	33	028
2,9	61	33	029
3,0	61	33	030
3,1	65	36	031
3,2	65	36	032
3,3	65	36	033
3,4	70	39	034
3,5	70	39	035
3,6	70	39	036
3,7	70	39	037
3,8	75	43	038
3,9	75	43	039
4,0	75	43	040
4,1	75	43	041
4,2	75	43	042
4,3	80	47	043
4,4	80	47	044
4,5	80	47	045
4,6	80	47	046
4,7	80	47	047
4,8	86	52	048
4,9	86	52	049
5,0	86	52	050
5,1	86	52	051
5,2	86	52	052
5,3	86	52	053

10 710 ...

DC _{h7} mm	OAL mm	LCF mm	
5,4	93	57	054
5,5	93	57	055
5,6	93	57	056
5,7	93	57	057
5,8	93	57	058
5,9	93	57	059
6,0	93	57	060
6,1	101	63	061
6,2	101	63	062
6,3	101	63	063
6,4	101	63	064
6,5	101	63	065
6,6	109	69	066
6,8	109	69	068
7,0	109	69	070
7,5	109	69	075
7,8	117	75	078
8,0	117	75	080
8,5	117	75	085
8,8	125	81	088
9,0	125	81	090
9,5	125	81	095
9,8	133	87	098
10,0	133	87	100
10,2	133	87	102
10,5	133	87	105
11,0	142	94	110
11,5	142	94	115
12,0	151	101	120
13,0	151	101	130
14,0	160	108	140
16,0	178	120	160

P	○
M	○
K	●
N	●
S	○
H	○
O	○

→ v_c Page 134

WTX – High Performance Drill, DIN 6537

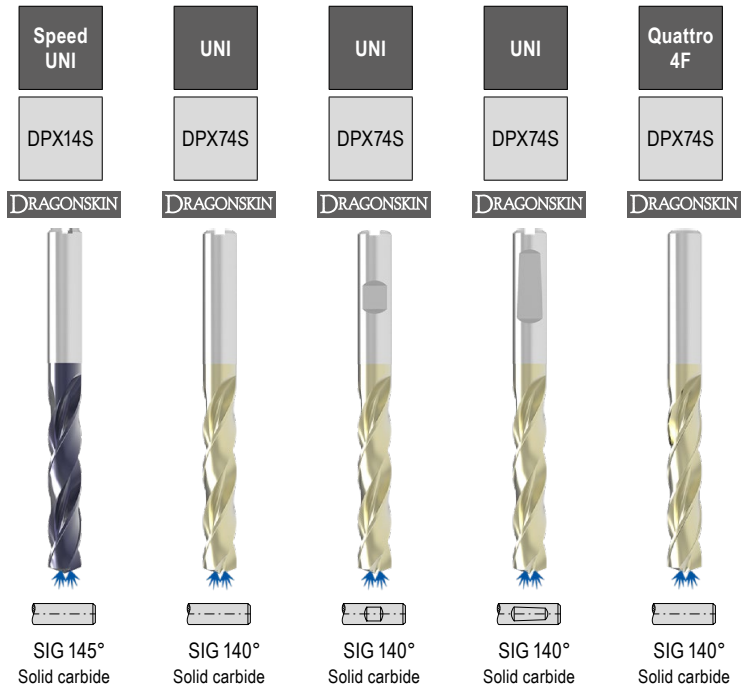
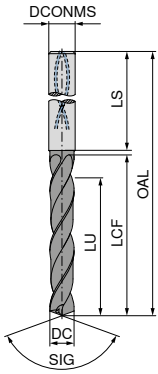
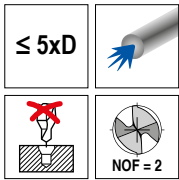

DC _{m7n7} mm	DCONMS _{h6} mm	OAL mm	LCF mm	LU mm	LS mm
3,00	6	66	28	23	36
3,10	6	66	28	23	36
3,15	6	66	28	23	36
3,20	6	66	28	23	36
3,22	6	66	28	23	36
3,25	6	66	28	23	36
3,30	6	66	28	23	36
3,40	6	66	28	23	36
3,50	6	66	28	23	36
3,60	6	66	28	23	36
3,70	6	66	28	23	36
3,80	6	74	36	29	36
3,85	6	74	36	29	36
3,90	6	74	36	29	36
4,00	6	74	36	29	36
4,10	6	74	36	29	36
4,20	6	74	36	29	36
4,25	6	74	36	29	36
4,30	6	74	36	29	36
4,35	6	74	36	29	36
4,40	6	74	36	29	36
4,45	6	74	36	29	36
4,50	6	74	36	29	36
4,60	6	74	36	29	36
4,65	6	74	36	29	36
4,70	6	74	36	29	36
4,80	6	82	44	35	36
4,90	6	82	44	35	36
4,95	6	82	44	35	36
5,00	6	82	44	35	36
5,05	6	82	44	35	36
5,10	6	82	44	35	36
5,20	6	82	44	35	36
5,30	6	82	44	35	36

10 771 ...	11 786 ...	11 787 ...	11 785 ...	10 735 ...
03000	03000	03000	03000	03000
03100	03100	03100	03100	03100
03150	03150	03150	03150	03150
03200	03200	03200	03200	03200
03220	03220	03220	03220	03220
03250	03250	03250	03250	03250
03300	03300	03300	03300	03300
03400	03400	03400	03400	03400
03500	03500	03500	03500	03500
03600	03600	03600	03600	03600
03700	03700	03700	03700	03700
03800	03800	03800	03800	03800
03850	03850	03850	03850	03850
03900	03900	03900	03900	03900
04000	04000	04000	04000	04000
04100	04100	04100	04100	04100
04200	04200	04200	04200	04200
04250	04250	04250	04250	04250
04300	04300	04300	04300	04300
04350	04350	04350	04350	04350
04400	04400	04400	04400	04400
04450	04450	04450	04450	04450
04500	04500	04500	04500	04500
04600	04600	04600	04600	04600
04650	04650	04650	04650	04650
04700	04700	04700	04700	04700
04800	04800	04800	04800	04800
04900	04900	04900	04900	04900
04950	04950	04950	04950	04950
05000	05000	05000	05000	05000
05050	05050	05050	05050	05050
05100	05100	05100	05100	05100
05200	05200	05200	05200	05200
05300	05300	05300	05300	05300

P	●	●	●	●	●
M	●	●	●	●	●
K	●	●	●	●	●
N					
S					
H		○	○	○	○
O					

→ v_e Page 111-120

Ø DC_{m7} for Type UNI and Quattro 4F/ Ø DC_{n7} for Type Speed UNI

WTX – High Performance Drill, DIN 6537

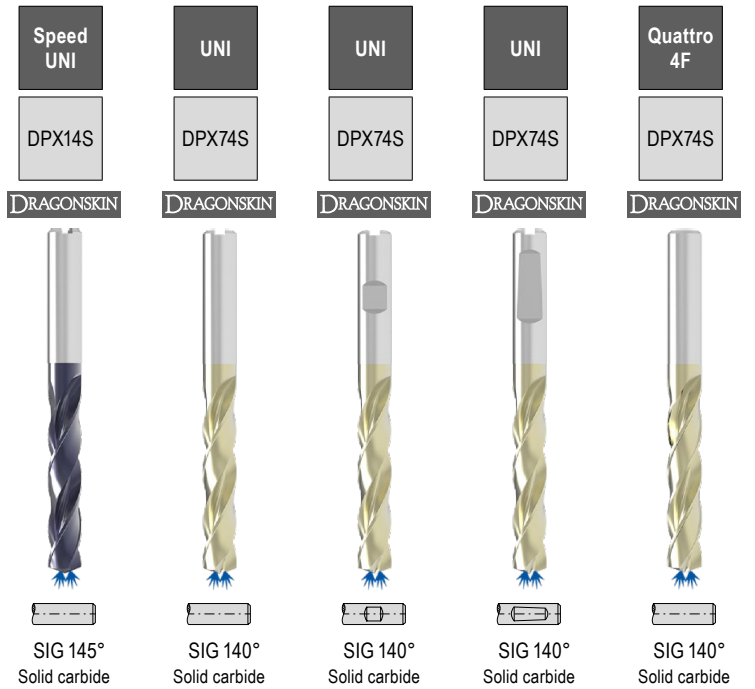
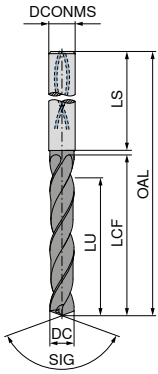
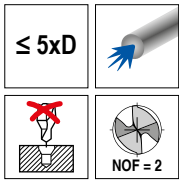

10 771 ... 11 786 ... 11 787 ... 11 785 ... 10 735 ...

DC _{m7h7} mm	DCONMS _{h6} mm	OAL mm	LCF mm	LU mm	LS mm					
5,40	6	82	44	35	36		05400			05400
5,50	6	82	44	35	36		05500			05500
5,55	6	82	44	35	36		05550			05550
5,60	6	82	44	35	36		05600			05600
5,70	6	82	44	35	36		05700			05700
5,75	6	82	44	35	36					
5,80	6	82	44	35	36		05800			05800
5,90	6	82	44	35	36		05900			05900
5,95	6	82	44	35	36					
6,00	6	82	44	35	36		06000			06000
6,10	8	91	53	43	36		06100			06100
6,20	8	91	53	43	36		06200			06200
6,30	8	91	53	43	36		06300			06300
6,40	8	91	53	43	36		06400			06400
6,50	8	91	53	43	36		06500			06500
6,60	8	91	53	43	36		06600			06600
6,70	8	91	53	43	36		06700			06700
6,80	8	91	53	43	36		06800			06800
6,90	8	91	53	43	36		06900			06900
7,00	8	91	53	43	36		07000			07000
7,10	8	91	53	43	36		07100			07100
7,20	8	91	53	43	36		07200			07200
7,30	8	91	53	43	36		07300			07300
7,40	8	91	53	43	36		07400			07400
7,45	8	91	53	43	36					
7,50	8	91	53	43	36		07500			07500
7,60	8	91	53	43	36		07600			07600
7,70	8	91	53	43	36		07700			07700
7,80	8	91	53	43	36		07800			07800
7,90	8	91	53	43	36		07900			07900
8,00	8	91	53	43	36		08000			08000
8,10	10	103	61	49	40		08100			08100
8,20	10	103	61	49	40		08200			08200
8,30	10	103	61	49	40		08300			08300

P	●	●	●	●	●
M	●	●	●	●	●
K	●	●	●	●	●
N					
S					
H		○	○	○	○
O					

→ v_c Page 111-120

Ø DC_{m7} for Type UNI and Quattro 4F/ Ø DC_{h7} for Type Speed UNI

WTX – High Performance Drill, DIN 6537

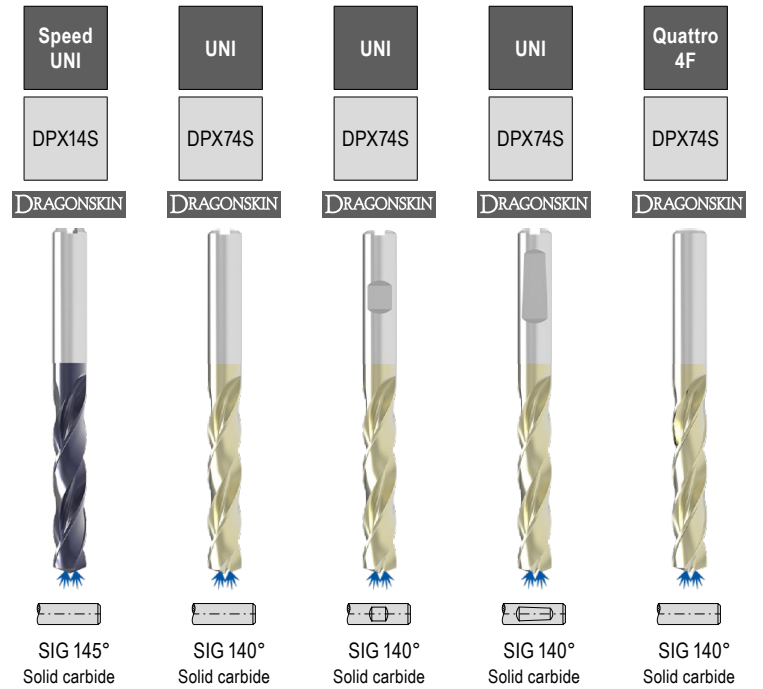
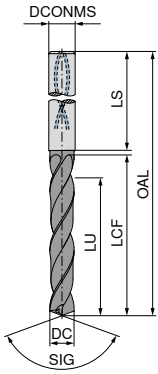
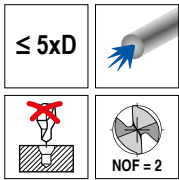

10 771 ... 11 786 ... 11 787 ... 11 785 ... 10 735 ...

DC _{m7h7} mm	DCONMS _{h6} mm	OAL mm	LCF mm	LU mm	LS mm	10 771 ...	11 786 ...	11 787 ...	11 785 ...	10 735 ...
8,40	10	103	61	49	40	08400	08400	08400	08400	08400
8,50	10	103	61	49	40	08500	08500	08500	08500	08500
8,60	10	103	61	49	40	08600	08600	08600	08600	08600
8,70	10	103	61	49	40	08700	08700	08700	08700	08700
8,80	10	103	61	49	40	08800	08800	08800	08800	08800
8,90	10	103	61	49	40	08900	08900	08900	08900	08900
9,00	10	103	61	49	40	09000	09000	09000	09000	09000
9,10	10	103	61	49	40	09100	09100	09100	09100	09100
9,20	10	103	61	49	40	09200	09200	09200	09200	09200
9,30	10	103	61	49	40	09300	09300	09300	09300	09300
9,35	10	103	61	49	40		09350	09350	09350	
9,40	10	103	61	49	40	09400	09400	09400	09400	09400
9,45	10	103	61	49	40		09450	09450	09450	
9,50	10	103	61	49	40	09500	09500	09500	09500	09500
9,60	10	103	61	49	40	09600	09600	09600	09600	09600
9,70	10	103	61	49	40	09700	09700	09700	09700	09700
9,80	10	103	61	49	40	09800	09800	09800	09800	09800
9,90	10	103	61	49	40	09900	09900	09900	09900	09900
10,00	10	103	61	49	40	10000	10000	10000	10000	10000
10,10	12	118	71	56	45	10100	10100	10100	10100	10100
10,20	12	118	71	56	45	10200	10200	10200	10200	10200
10,30	12	118	71	56	45	10300	10300	10300	10300	10300
10,40	12	118	71	56	45	10400	10400	10400	10400	10400
10,50	12	118	71	56	45	10500	10500	10500	10500	10500
10,55	12	118	71	56	45		10550	10550	10550	
10,60	12	118	71	56	45	10600	10600	10600	10600	10600
10,70	12	118	71	56	45	10700	10700	10700	10700	10700
10,75	12	118	71	56	45		10750	10750	10750	
10,80	12	118	71	56	45	10800	10800	10800	10800	10800
10,90	12	118	71	56	45	10900	10900	10900	10900	10900
11,00	12	118	71	56	45	11000	11000	11000	11000	11000
11,10	12	118	71	56	45	11100	11100	11100	11100	11100
11,20	12	118	71	56	45	11200	11200	11200	11200	11200
11,25	12	118	71	56	45		11250	11250	11250	

P	●	●	●	●	●
M	●	●	●	●	●
K	●	●	●	●	●
N					
S					
H		○	○	○	○
O					

→ v_c Page 111-120

Ø DC_{m7} for Type UNI and Quattro 4F/ Ø DC_{h7} for Type Speed UNI

WTX – High Performance Drill, DIN 6537

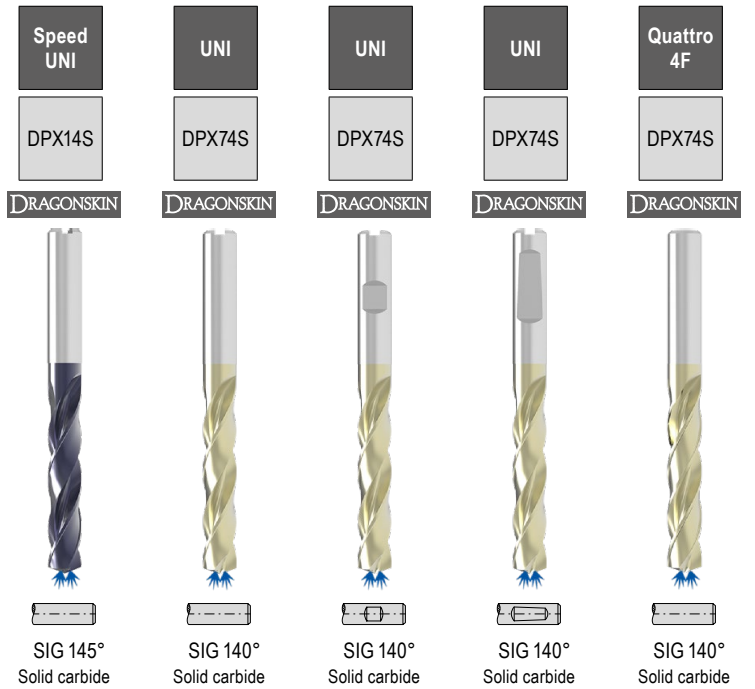
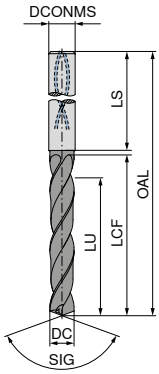
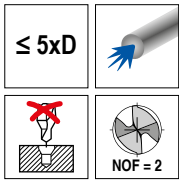

DC _{m7h7} mm	DCONMS _{h6} mm	OAL mm	LCF mm	LU mm	LS mm	10 771 ...	11 786 ...	11 787 ...	11 785 ...	10 735 ...
11,30	12	118	71	56	45	11300	11300	11300	11300	11300
11,35	12	118	71	56	45		11350	11350	11350	
11,40	12	118	71	56	45	11400	11400	11400	11400	11400
11,45	12	118	71	56	45		11450	11450	11450	
11,50	12	118	71	56	45	11500	11500	11500	11500	11500
11,60	12	118	71	56	45	11600	11600	11600	11600	11600
11,70	12	118	71	56	45	11700	11700	11700	11700	11700
11,80	12	118	71	56	45	11800	11800	11800	11800	11800
11,90	12	118	71	56	45	11900	11900	11900	11900	11900
12,00	12	118	71	56	45	12000	12000	12000	12000	12000
12,15	14	124	77	60	45		12150	12150	12150	
12,20	14	124	77	60	45	12200				
12,25	14	124	77	60	45		12250	12250	12250	
12,50	14	124	77	60	45	12500	12500	12500	12500	12500
12,55	14	124	77	60	45		12550	12550	12550	
12,70	14	124	77	60	45		12700	12700	12700	
12,80	14	124	77	60	45	12800	12800	12800	12800	12800
12,90	14	124	77	60	45		12900	12900	12900	
13,00	14	124	77	60	45	13000	13000	13000	13000	13000
13,10	14	124	77	60	45		13100	13100	13100	
13,30	14	124	77	60	45		13300	13300	13300	
13,35	14	124	77	60	45		13350	13350	13350	
13,50	14	124	77	60	45	13500	13500	13500	13500	13500
13,70	14	124	77	60	45		13700	13700	13700	
13,80	14	124	77	60	45	13800	13800	13800	13800	13800
14,00	14	124	77	60	45	14000	14000	14000	14000	14000
14,20	16	133	83	63	48	14200	14200	14200	14200	
14,50	16	133	83	63	48	14500	14500	14500	14500	14500
14,80	16	133	83	63	48	14800	14800	14800	14800	14800
15,00	16	133	83	63	48	15000	15000	15000	15000	15000
15,10	16	133	83	63	48		15100	15100	15100	
15,20	16	133	83	63	48	15200				
15,25	16	133	83	63	48		15250	15250	15250	
15,30	16	133	83	63	48		15300	15300	15300	

P	●	●	●	●	●
M	●	●	●	●	●
K	●	●	●	●	●
N					
S					
H		○	○	○	○
O					

→ v_c Page 111-120

Ø DC_{m7} for Type UNI and Quattro 4F/ Ø DC_{h7} for Type Speed UNI

WTX – High Performance Drill, DIN 6537

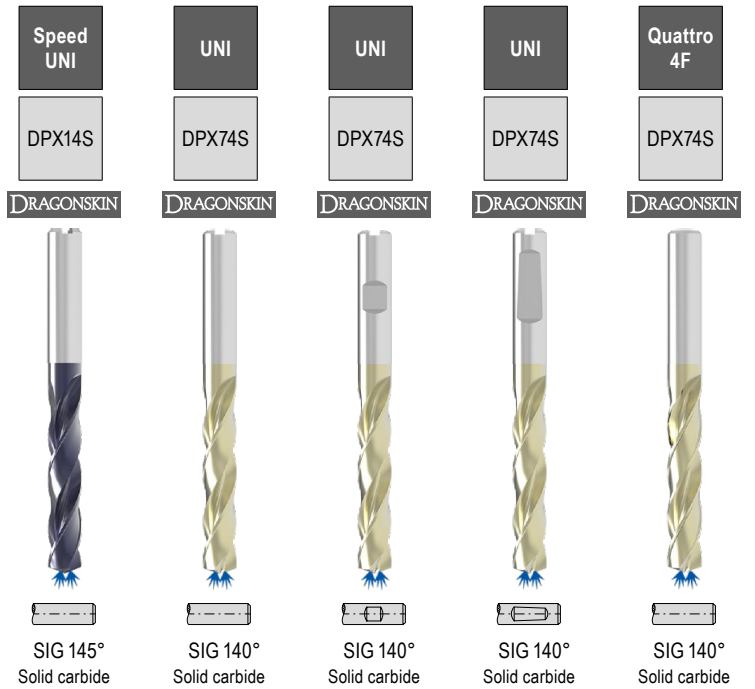
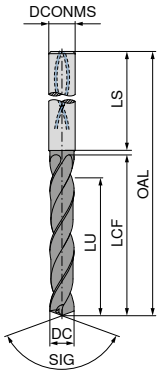
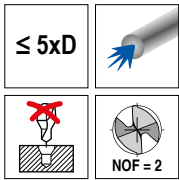

10 771 ... 11 786 ... 11 787 ... 11 785 ... 10 735 ...

DC _{m7h7} mm	DCONMS _{h6} mm	OAL mm	LCF mm	LU mm	LS mm	10 771 ...	11 786 ...	11 787 ...	11 785 ...	10 735 ...
15,35	16	133	83	63	48					
15,50	16	133	83	63	48	15500	15350	15350	15350	15500
15,60	16	133	83	63	48		15600	15600	15600	
15,80	16	133	83	63	48	15800	15800	15800	15800	15800
16,00	16	133	83	63	48	16000	16000	16000	16000	16000
16,05	18	143	93	71	48		16050	16050	16050	
16,50	18	143	93	71	48	16500	16500	16500	16500	16500
16,80	18	143	93	71	48	16800	16800	16800	16800	16800
16,90	18	143	93	71	48		16900	16900	16900	
17,00	18	143	93	71	48	17000	17000	17000	17000	17000
17,50	18	143	93	71	48	17500	17500	17500	17500	17500
17,60	18	143	93	71	48		17600	17600	17600	
17,80	18	143	93	71	48	17800	17800	17800	17800	17800
18,00	18	143	93	71	48	18000	18000	18000	18000	18000
18,50	20	153	101	77	50		18500	18500	18500	
18,80	20	153	101	77	50		18800	18800	18800	
18,90	20	153	101	77	50		18900	18900	18900	
19,00	20	153	101	77	50		19000	19000	19000	
19,35	20	153	101	77	50		19350	19350	19350	
19,50	20	153	101	77	50		19500	19500	19500	
19,60	20	153	101	77	50		19600	19600	19600	
19,80	20	153	101	77	50		19800	19800	19800	
20,00	20	153	101	77	50		20000	20000	20000	
20,50	25	200	135	110	56		20500	20500	20500	
21,00	25	200	135	110	56		21000	21000	21000	
21,50	25	200	135	110	56		21500	21500	21500	
22,00	25	200	135	110	56		22000	22000	22000	
22,50	25	200	140	120	56		22500	22500	22500	
23,00	25	200	140	120	56		23000	23000	23000	
23,50	25	200	140	120	56		23500	23500	23500	
24,00	25	200	140	120	56		24000	24000	24000	
24,50	25	200	140	120	56		24500	24500	24500	
25,00	25	200	140	120	56		25000	25000	25000	

P	•	•	•	•	•
M	•	•	•	•	•
K	•	•	•	•	•
N					
S					
H		○	○	○	○
O					

→ v_c Page 111–120

Ø DC_{m7} for Type UNI and Quattro 4F/ Ø DC_{m7} for Type Speed UNI

WTX – High Performance Drill, DIN 6537

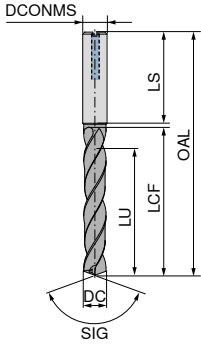
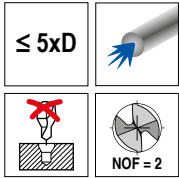

DC _{h7/m7} mm	DCONMS _{h6} mm	OAL mm	LCF mm	LU mm	LS mm
2,50	4	57	21	17	28
2,60	4	57	21	17	28
2,70	4	57	21	17	28
2,80	4	57	21	17	28
2,90	4	57	21	17	28
3,00	6	66	28	23	36
3,10	6	66	28	23	36
3,15	6	66	28	23	36
3,20	6	66	28	23	36
3,22	6	66	28	23	36
3,25	6	66	28	23	36
3,30	6	66	28	23	36
3,40	6	66	28	23	36
3,50	6	66	28	23	36
3,60	6	66	28	23	36
3,70	6	66	28	23	36
3,80	6	74	36	29	36
3,85	6	74	36	29	36
3,90	6	74	36	29	36
4,00	6	74	36	29	36
4,10	6	74	36	29	36
4,20	6	74	36	29	36
4,30	6	74	36	29	36
4,35	6	74	36	29	36
4,40	6	74	36	29	36
4,45	6	74	36	29	36
4,50	6	74	36	29	36
4,60	6	74	36	29	36
4,65	6	74	36	29	36
4,70	6	74	36	29	36
4,80	6	82	44	35	36
4,90	6	82	44	35	36
5,00	6	82	44	35	36
5,10	6	82	44	35	36
5,20	6	82	44	35	36
5,30	6	82	44	35	36
5,40	6	82	44	35	36

10 773 ...	10 745 ...	10 791 ...
		02500
		02600
		02700
		02800
		02900
030	030	03000
031	031	03100
	831	
032	032	03200
	832	
	890	
033	033	03300
034	034	03400
035	035	03500
036	036	03600
037	037	03700
038	038	03800
	838	
039	039	03900
040	040	04000
041	041	04100
042	042	04200
043	043	04300
	843	
044	044	04400
	844	
045	045	04500
046	046	04600
900	900	
047	047	04700
048	048	04800
049	049	04900
050	050	05000
051	051	05100
052	052	05200
053	053	05300
054	054	05400

P	●	○	
M	●	●	
K	●	○	
N	○	○	●
S	●	●	
H			
O			

→ v_c Page 112–122

Ø DC_{m7} for Type VA / Ø DC_{h7} for Type Speed VA and AL

WTX – High Performance Drill, DIN 6537

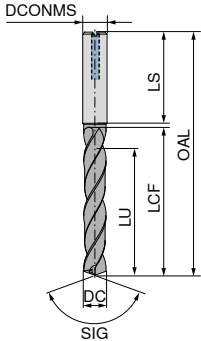
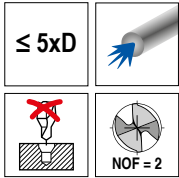

DC _{h7/m7} mm	DCONMS _{h6} mm	OAL mm	LCF mm	LU mm	LS mm	10 773 ...	10 745 ...	10 791 ...
5,50	6	82	44	35	36	055	055	05500
5,55	6	82	44	35	36	902		
5,60	6	82	44	35	36	056	056	05600
5,70	6	82	44	35	36	057	057	05700
5,75	6	82	44	35	36		916	
5,80	6	82	44	35	36	058	058	05800
5,90	6	82	44	35	36	059	059	05900
5,95	6	82	44	35	36		959	
6,00	6	82	44	35	36	060	060	06000
6,10	8	91	53	43	36	061	061	06100
6,20	8	91	53	43	36	062	062	06200
6,30	8	91	53	43	36	063	063	06300
6,40	8	91	53	43	36	064	064	06400
6,50	8	91	53	43	36	065	065	06500
6,60	8	91	53	43	36	066	066	06600
6,70	8	91	53	43	36	067	067	06700
6,80	8	91	53	43	36	068	068	06800
6,90	8	91	53	43	36	069	069	06900
7,00	8	91	53	43	36	070	070	07000
7,10	8	91	53	43	36	071	071	07100
7,20	8	91	53	43	36	072	072	07200
7,30	8	91	53	43	36	073	073	07300
7,40	8	91	53	43	36	074	074	07400
7,45	8	91	53	43	36		924	
7,50	8	91	53	43	36	075	075	07500
7,60	8	91	53	43	36	076	076	07600
7,70	8	91	53	43	36	077	077	07700
7,80	8	91	53	43	36	078	078	07800
7,90	8	91	53	43	36	079	079	07900
8,00	8	91	53	43	36	080	080	08000
8,10	10	103	61	49	40	081	081	08100
8,20	10	103	61	49	40	082	082	08200
8,30	10	103	61	49	40	083	083	08300
8,40	10	103	61	49	40	084	084	08400
8,50	10	103	61	49	40	085	085	08500
8,60	10	103	61	49	40	086	086	08600
8,70	10	103	61	49	40	087	087	08700

P	●	○	
M	●	●	
K	●	○	
N	○	○	●
S	●	●	
H			
O			

→ v_c Page 112-122

Ø DC_{m7} for Type VA / Ø DC_{h7} for Type Speed VA and AL

WTX – High Performance Drill, DIN 6537

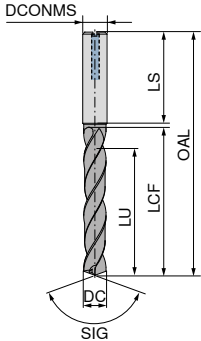
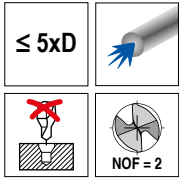

DC $h7/m7$	DCONMS $h6$	OAL	LCF	LU	LS	10 773 ...	10 745 ...	10 791 ...
8,80	10	103	61	49	40	088	088	08800
8,90	10	103	61	49	40	089	089	08900
9,00	10	103	61	49	40	090	090	09000
9,10	10	103	61	49	40	091	091	09100
9,20	10	103	61	49	40	092	092	09200
9,30	10	103	61	49	40	093	093	09300
9,35	10	103	61	49	40		930	
9,40	10	103	61	49	40	094	094	09400
9,45	10	103	61	49	40		994	
9,50	10	103	61	49	40	095	095	09500
9,60	10	103	61	49	40	096	096	09600
9,70	10	103	61	49	40	097	097	09700
9,80	10	103	61	49	40	098	098	09800
9,90	10	103	61	49	40	099	099	09900
10,00	10	103	61	49	40	100	100	10000
10,10	12	118	71	56	45	101	101	10100
10,20	12	118	71	56	45	102	102	10200
10,30	12	118	71	56	45	103	103	10300
10,40	12	118	71	56	45	104	104	10400
10,50	12	118	71	56	45	105	105	10500
10,55	12	118	71	56	45		932	
10,60	12	118	71	56	45	106	106	10600
10,70	12	118	71	56	45	107	107	10700
10,80	12	118	71	56	45	108	108	10800
10,90	12	118	71	56	45	109	109	
11,00	12	118	71	56	45	110	110	11000
11,10	12	118	71	56	45	111	111	11100
11,20	12	118	71	56	45	112	112	11200
11,25	12	118	71	56	45		912	
11,30	12	118	71	56	45	113	113	11300
11,35	12	118	71	56	45		913	
11,40	12	118	71	56	45	114	114	11400
11,45	12	118	71	56	45		914	
11,50	12	118	71	56	45	115	115	11500
11,60	12	118	71	56	45	116	116	
11,70	12	118	71	56	45	117	117	11700
11,80	12	118	71	56	45	118	118	11800

P	●	○	
M	●	●	
K	●	○	
N	○	○	●
S	●	●	
H			
O			

→ v_c Page 112-122

1 Ø DC_{m7} for Type VA / Ø DC_{n7} for Type Speed VA and AL

WTX – High Performance Drill, DIN 6537

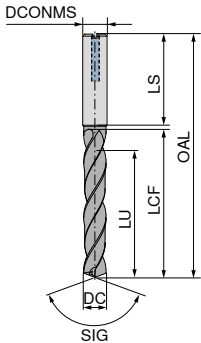
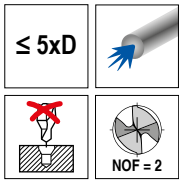

DC _{h7/m7} mm	DCONMS _{h6} mm	OAL mm	LCF mm	LU mm	LS mm	10 773 ... Solid carbide	10 745 ... Solid carbide	10 791 ... Solid carbide
11,90	12	118	71	56	45	119	119	
12,00	12	118	71	56	45	120	120	12000
12,15	14	124	77	60	45		921	
12,20	14	124	77	60	45	12200		12200
12,50	14	124	77	60	45	125	125	12500
12,55	14	124	77	60	45		925	
12,60	14	124	77	60	45			12600
12,80	14	124	77	60	45	128	128	12800
13,00	14	124	77	60	45	130	130	13000
13,35	14	124	77	60	45		933	
13,50	14	124	77	60	45	135	135	13500
13,80	14	124	77	60	45	138	138	13800
14,00	14	124	77	60	45	140	140	14000
14,20	16	133	83	63	48			14200
14,50	16	133	83	63	48	145	145	14500
14,80	16	133	83	63	48	148	148	14800
15,00	16	133	83	63	48	150	150	15000
15,20	16	133	83	63	48			15200
15,35	16	133	83	63	48		953	
15,50	16	133	83	63	48	155	155	15500
15,80	16	133	83	63	48	158	158	15800
16,00	16	133	83	63	48	160	160	16000
16,05	18	143	93	71	48		960	
16,50	18	143	93	71	48	165	165	16500
16,80	18	143	93	71	48	168	168	
17,00	18	143	93	71	48	170	170	17000
17,50	18	143	93	71	48	175	175	17500
17,80	18	143	93	71	48	178	178	
18,00	18	143	93	71	48	180	180	18000
18,50	20	153	101	77	50	185	185	18500
18,80	20	153	101	77	50	188	188	
19,00	20	153	101	77	50	190	190	19000
19,35	20	153	101	77	50		993	
19,50	20	153	101	77	50	195	195	19500
19,80	20	153	101	77	50	198	198	
20,00	20	153	101	77	50	200	200	20000

P	●	○	
M	●	●	
K	●	○	
N	○	○	●
S	●	●	
H			
O			

→ v_c Page 112-122

Ø DC_{m7} for Type VA / Ø DC_{h7} for Type Speed VA and AL

High Performance Drill, DIN 6537

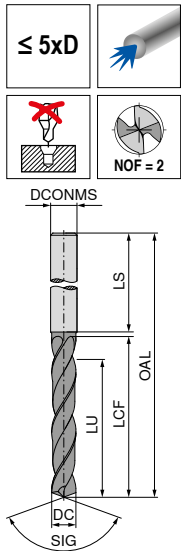

UNI	UNI	VA	VA
TiAlN	TiAlN	TiAlN	TiAlN
SIG 140° Solid carbide	SIG 140° Solid carbide	SIG 140° Solid carbide	SIG 140° Solid carbide
11 702 ...	11 703 ...	11 715 ...	11 716 ...
01000		01000	
01100		01100	
01200		01200	
01300		01300	
01400		01400	
01500		01500	
01600		01600	
01700		01700	
01800		01800	
01900		01900	
02000		02000	
02100		02100	
02200		02200	
02300		02300	
02400		02400	
02500		02500	
02600		02600	
02700		02700	
02800		02800	
02900		02900	
03000	03000	03000	03000
03100	03100	03100	03100
03200	03200	03200	03200
03250	03250		
03300	03300	03300	03300
03400	03400	03400	03400
03500	03500	03500	03500
03600	03600	03600	03600
03700	03700	03700	03700
03800	03800	03800	03800
03850	03850		
03900	03900	03900	03900
04000	04000	04000	04000
04100	04100	04100	04100
04200	04200	04200	04200
04300	04300	04300	04300
04400	04400	04400	04400
04500	04500	04500	04500
04600	04600	04600	04600
04650	04650		
04700	04700	04700	04700
04800	04800	04800	04800
04900	04900	04900	04900
05000	05000	05000	05000
05100	05100	05100	05100

DC _{m7} mm	DCONMS _{h6} mm	OAL mm	LCF mm	LU mm	LS mm
1,00	4	55	8	6,5	28
1,10	4	55	12	10,3	28
1,20	4	55	12	10,2	28
1,30	4	55	12	10,0	28
1,40	4	55	12	9,9	28
1,50	4	55	12	9,7	28
1,60	4	55	16	13,6	28
1,70	4	55	16	13,4	28
1,80	4	55	16	13,3	28
1,90	4	55	16	13,1	28
2,00	4	57	21	18,0	28
2,10	4	57	21	17,8	28
2,20	4	57	21	17,7	28
2,30	4	57	21	17,5	28
2,40	4	57	21	17,4	28
2,50	4	57	21	17,2	28
2,60	4	57	21	17,1	28
2,70	4	57	21	16,9	28
2,80	4	57	21	16,8	28
2,90	4	57	21	16,6	28
3,00	6	66	28	23,5	36
3,10	6	66	28	23,3	36
3,20	6	66	28	23,2	36
3,25	6	66	28	23,1	36
3,30	6	66	28	23,0	36
3,40	6	66	28	22,9	36
3,50	6	66	28	22,7	36
3,60	6	66	28	22,6	36
3,70	6	66	28	22,4	36
3,80	6	74	36	30,3	36
3,85	6	74	36	30,2	36
3,90	6	74	36	30,1	36
4,00	6	74	36	30,0	36
4,10	6	74	36	29,8	36
4,20	6	74	36	29,7	36
4,30	6	74	36	29,5	36
4,40	6	74	36	29,4	36
4,50	6	74	36	29,2	36
4,60	6	74	36	29,1	36
4,65	6	74	36	29,0	36
4,70	6	74	36	28,9	36
4,80	6	82	44	36,8	36
4,90	6	82	44	36,6	36
5,00	6	82	44	36,5	36
5,10	6	82	44	36,3	36

P	●	●	○	○
M	●	●	●	●
K	●	●		
N	○	○	●	●
S			○	○
H				
O			○	○

→ v_c Page 129+133

Ø DC_{h7} for Type UNI / Ø DC_{m7} for Type VA

High Performance Drill, DIN 6537

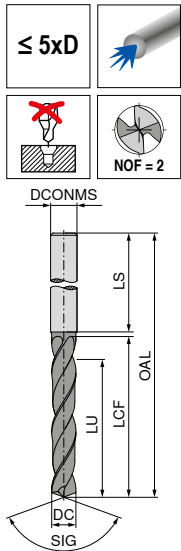

	UNI TiAlN	UNI TiAlN	VA TiAlN	VA TiAlN
	SIG 140° Solid carbide	SIG 140° Solid carbide	SIG 140° Solid carbide	SIG 140° Solid carbide
	11 702 ...	11 703 ...	11 715 ...	11 716 ...
	05200	05200	05200	05200
	05300	05300	05300	05300
	05400	05400	05400	05400
	05500	05500	05500	05500
	05550	05550		
	05600	05600	05600	05600
	05650	05650		
	05700	05700	05700	05700
	05800	05800	05800	05800
	05900	05900	05900	05900
	06000	06000	06000	06000
	06100	06100	06100	06100
	06200	06200	06200	06200
	06300	06300	06300	06300
	06400	06400	06400	06400
	06500	06500	06500	06500
	06600	06600	06600	06600
	06700	06700	06700	06700
	06800	06800	06800	06800
	06900	06900	06900	06900
	07000	07000	07000	07000
	07100	07100	07100	07100
	07200	07200	07200	07200
	07300	07300	07300	07300
	07400	07400	07400	07400
	07450	07450	07450	07450
	07500	07500	07500	07500
	07550	07550	07550	07550
	07600	07600	07600	07600
	07650	07650		
	07700	07700	07700	07700
	07800	07800	07800	07800
	07900	07900	07900	07900
	08000	08000	08000	08000
	08100	08100	08100	08100
	08200	08200	08200	08200
	08300	08300	08300	08300
	08400	08400	08400	08400
	08500	08500	08500	08500
	08600	08600	08600	08600
	08700	08700	08700	08700
	08800	08800	08800	08800
	08900	08900	08900	08900
	09000	09000	09000	09000
	09100	09100	09100	09100

DC _{mTn7} mm	DCONMS _{h6} mm	OAL mm	LCF mm	LU mm	LS mm
5,20	6	82	44	36,2	36
5,30	6	82	44	36,0	36
5,40	6	82	44	35,9	36
5,50	6	82	44	35,7	36
5,55	6	82	44	35,6	36
5,60	6	82	44	35,6	36
5,65	6	82	44	35,5	36
5,70	6	82	44	35,4	36
5,80	6	82	44	35,3	36
5,90	6	82	44	35,1	36
6,00	6	82	44	35,0	36
6,10	8	91	53	43,8	36
6,20	8	91	53	43,7	36
6,30	8	91	53	43,5	36
6,40	8	91	53	43,4	36
6,50	8	91	53	43,2	36
6,60	8	91	53	43,1	36
6,70	8	91	53	42,9	36
6,80	8	91	53	42,8	36
6,90	8	91	53	42,6	36
7,00	8	91	53	42,5	36
7,10	8	91	53	42,3	36
7,20	8	91	53	42,2	36
7,30	8	91	53	42,0	36
7,40	8	91	53	41,9	36
7,45	8	91	53	41,8	36
7,50	8	91	53	41,7	36
7,55	8	91	53	41,6	36
7,60	8	91	53	41,6	36
7,65	8	91	53	41,5	36
7,70	8	91	53	41,4	36
7,80	8	91	53	41,3	36
7,90	8	91	53	41,1	36
8,00	8	91	53	41,0	36
8,10	10	103	61	48,8	40
8,20	10	103	61	48,7	40
8,30	10	103	61	48,5	40
8,40	10	103	61	48,4	40
8,50	10	103	61	48,2	40
8,60	10	103	61	48,1	40
8,70	10	103	61	47,9	40
8,80	10	103	61	47,8	40
8,90	10	103	61	47,6	40
9,00	10	103	61	47,5	40
9,10	10	103	61	47,3	40

P	●	●	○	○
M	●	●	●	●
K	●	●		
N	○	○	●	●
S			○	○
H				
O			○	○

→ v_c Page 129+133

Ø DC_{h7} for Type UNI / Ø DC_{m7} for Type VA

High Performance Drill, DIN 6537

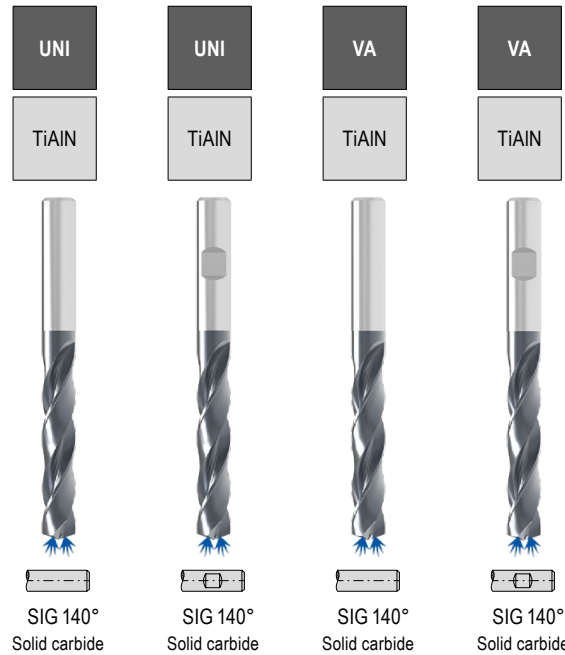
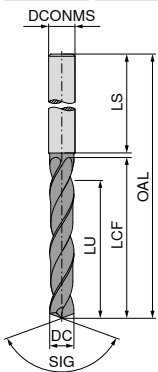
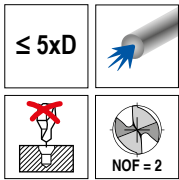

11 702 ... 11 703 ... 11 715 ... 11 716 ...

DC _{mTn7} mm	DCONMS _{h6} mm	OAL mm	LCF mm	LU mm	LS mm				
9,20	10	103	61	47,2	40		09200		09200
9,30	10	103	61	47,0	40		09300		09300
9,40	10	103	61	46,9	40		09400		09400
9,50	10	103	61	46,7	40		09500		09500
9,55	10	103	61	46,6	40		09550		09550
9,60	10	103	61	46,6	40		09600		09600
9,70	10	103	61	46,4	40		09700		09700
9,80	10	103	61	46,3	40		09800		09800
9,90	10	103	61	46,1	40		09900		09900
10,00	10	103	61	46,0	40		10000		10000
10,10	12	118	71	55,8	45		10100		10100
10,20	12	118	71	55,7	45		10200		10200
10,30	12	118	71	55,5	45		10300		10300
10,40	12	118	71	55,4	45		10400		10400
10,50	12	118	71	55,2	45		10500		10500
10,60	12	118	71	55,1	45		10600		10600
10,70	12	118	71	54,9	45		10700		10700
10,80	12	118	71	54,8	45		10800		10800
10,90	12	118	71	54,6	45		10900		10900
11,00	12	118	71	54,5	45		11000		11000
11,10	12	118	71	54,3	45		11100		11100
11,20	12	118	71	54,2	45		11200		11200
11,30	12	118	71	54,0	45		11300		11300
11,40	12	118	71	53,9	45		11400		11400
11,50	12	118	71	53,7	45		11500		11500
11,60	12	118	71	53,6	45		11600		11600
11,70	12	118	71	53,4	45		11700		11700
11,80	12	118	71	53,3	45		11800		11800
11,90	12	118	71	53,1	45		11900		11900
12,00	12	118	71	53,0	45		12000		12000
12,10	14	124	77	58,8	45		12100		12100
12,20	14	124	77	58,7	45		12200		12200
12,40	14	124	77	58,4	45		12400		12400
12,50	14	124	77	58,2	45		12500		12500
12,60	14	124	77	58,1	45		12600		12600
12,70	14	124	77	57,9	45		12700		12700
12,80	14	124	77	57,8	45		12800		12800
13,00	14	124	77	57,5	45		13000		13000
13,10	14	124	77	57,3	45		13100		13100
13,20	14	124	77	57,2	45		13200		13200
13,30	14	124	77	57,0	45		13300		13300
13,50	14	124	77	56,7	45		13500		13500
13,70	14	124	77	56,4	45				13700
13,80	14	124	77	56,3	45		13800		13800
14,00	14	124	77	56,0	45		14000		14000

P	●	●	○	○
M	●	●	●	●
K	●	●		
N	○	○	●	●
S			○	○
H				
O			○	○

→ v_c Page 129+133

Ø DC_{h7} for Type UNI / Ø DC_{m7} for Type VA

High Performance Drill, DIN 6537

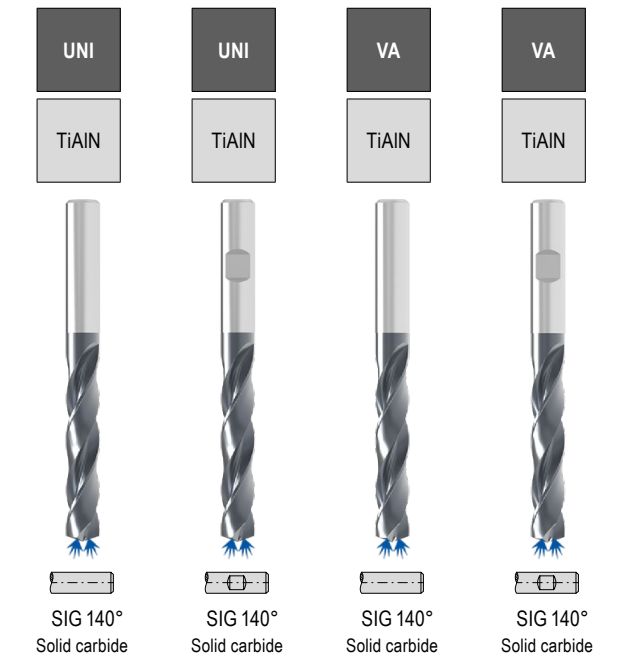
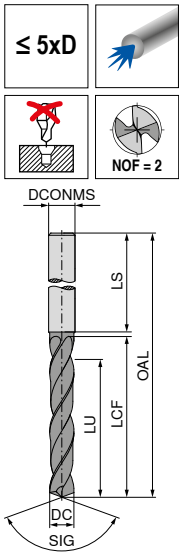

	11 702 ...	11 703 ...	11 715 ...	11 716 ...
14,20	14200	14200	14200	14200
14,30	14300	14300	14300	14300
14,40	14400	14400	14400	14400
14,50	14500	14500	14500	14500
14,70			14700	14700
14,80	14800	14800	14800	14800
15,00	15000	15000	15000	15000
15,10	15100	15100	15100	15100
15,20	15200	15200	15200	15200
15,25	15250	15250		
15,30	15300	15300	15300	15300
15,50	15500	15500	15500	15500
15,70			15700	15700
15,80	15800	15800	15800	15800
16,00	16000	16000	16000	16000
16,20	16200	16200	16200	16200
16,30	16300	16300	16300	16300
16,50	16500	16500	16500	16500
16,80	16800	16800	16800	16800
17,00	17000	17000	17000	17000
17,30	17300	17300	17300	17300
17,50	17500	17500	17500	17500
18,00	18000	18000	18000	18000
18,50	18500	18500	18500	18500
18,90	18900	18900	18900	18900
19,00	19000	19000	19000	19000
19,20	19200	19200	19200	19200
19,30	19300	19300	19300	19300
19,50	19500	19500	19500	19500
19,70	19700	19700	19700	19700
20,00	20000	20000	20000	20000

DC _{mTn7} mm	DCONMS _{h6} mm	OAL mm	LCF mm	LU mm	LS mm
14,20	16	133	83	61,7	48
14,30	16	133	83	61,5	48
14,40	16	133	83	61,4	48
14,50	16	133	83	61,2	48
14,70	16	133	83	60,9	48
14,80	16	133	83	60,8	48
15,00	16	133	83	60,5	48
15,10	16	133	83	60,3	48
15,20	16	133	83	60,2	48
15,25	16	133	83	60,1	48
15,30	16	133	83	60,0	48
15,50	16	133	83	59,7	48
15,70	16	133	83	59,4	48
15,80	16	133	83	59,3	48
16,00	16	133	83	59,0	48
16,20	18	143	93	68,7	48
16,30	18	143	93	68,5	48
16,50	18	143	93	68,2	48
16,80	18	143	93	67,8	48
17,00	18	143	93	67,5	48
17,30	18	143	93	67,0	48
17,50	18	143	93	66,7	48
18,00	18	143	93	66,0	48
18,50	20	153	101	73,2	50
18,90	20	153	101	72,6	50
19,00	20	153	101	72,5	50
19,20	20	153	101	72,2	50
19,30	20	153	101	72,0	50
19,50	20	153	101	71,7	50
19,70	20	153	101	71,4	50
20,00	20	153	101	71,0	50

P	●	●	○	○
M	●	●	●	●
K	●	●		
N	○	○	●	●
S			○	○
H				
O			○	○

→ v_c Page 129+133

Ø DC_{h7} for Type UNI / Ø DC_{m7} for Type VA

WTX – High-performance drill, DIN 6537

▲ Specialist for difficult to machine materials

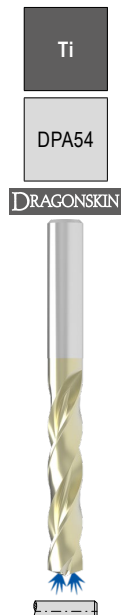
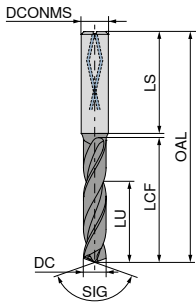
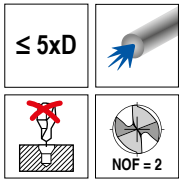

SIG 140°
Solid carbide

10 787 ...

DC _{m7} mm	DCONMS _{h6} mm	OAL mm	LCF mm	LU mm	LS mm	
3,00	6	66	28	23	36	030
3,10	6	66	28	23	36	031
3,20	6	66	28	23	36	032
3,30	6	66	28	23	36	033
3,40	6	66	28	23	36	034
3,50	6	66	28	23	36	035
3,60	6	66	28	23	36	036
3,70	6	66	28	23	36	037
3,80	6	74	36	29	36	038
3,90	6	74	36	29	36	039
3,97	6	74	36	29	36	900
4,00	6	74	36	29	36	040
4,10	6	74	36	29	36	041
4,20	6	74	36	29	36	042
4,23	6	74	36	29	36	901
4,30	6	74	36	29	36	043
4,40	6	74	36	29	36	044
4,50	6	74	36	29	36	045
4,60	6	74	36	29	36	046
4,70	6	74	36	29	36	047
4,80	6	82	44	35	36	048
4,90	6	82	44	35	36	049
5,00	6	82	44	35	36	050
5,10	6	82	44	35	36	051
5,20	6	82	44	35	36	052
5,30	6	82	44	35	36	053
5,40	6	82	44	35	36	054
5,50	6	82	44	35	36	055
5,56	6	82	44	35	36	902
5,60	6	82	44	35	36	056
5,70	6	82	44	35	36	057
5,80	6	82	44	35	36	058
5,90	6	82	44	35	36	059
6,00	6	82	44	35	36	060
6,10	8	91	53	43	36	061
6,20	8	91	53	43	36	062
6,30	8	91	53	43	36	063
6,35	8	91	53	43	36	903
6,40	8	91	53	43	36	064
6,50	8	91	53	43	36	065
6,60	8	91	53	43	36	066
6,70	8	91	53	43	36	067
6,80	8	91	53	43	36	068
6,90	8	91	53	43	36	069
7,00	8	91	53	43	36	070
7,10	8	91	53	43	36	071
7,20	8	91	53	43	36	072
7,30	8	91	53	43	36	073
7,40	8	91	53	43	36	074
7,50	8	91	53	43	36	075
7,60	8	91	53	43	36	076

10 787 ...

DC _{m7} mm	DCONMS _{h6} mm	OAL mm	LCF mm	LU mm	LS mm	
7,70	8	91	53	43	36	077
7,80	8	91	53	43	36	078
7,90	8	91	53	43	36	079
7,94	8	91	53	43	36	904
8,00	8	91	53	43	36	080
8,10	10	103	61	49	40	081
8,20	10	103	61	49	40	082
8,30	10	103	61	49	40	083
8,40	10	103	61	49	40	084
8,50	10	103	61	49	40	085
8,60	10	103	61	49	40	086
8,70	10	103	61	49	40	087
8,80	10	103	61	49	40	088
8,90	10	103	61	49	40	089
9,00	10	103	61	49	40	090
9,10	10	103	61	49	40	091
9,20	10	103	61	49	40	092
9,30	10	103	61	49	40	093
9,40	10	103	61	49	40	094
9,50	10	103	61	49	40	095
9,53	10	103	61	49	40	905
9,60	10	103	61	49	40	096
9,70	10	103	61	49	40	097
9,80	10	103	61	49	40	098
9,90	10	103	61	49	40	099
10,00	10	103	61	49	40	100
10,10	12	118	71	54	45	101
10,20	12	118	71	54	45	102
10,30	12	118	71	54	45	103
10,40	12	118	71	54	45	104
10,50	12	118	71	54	45	105
10,60	12	118	71	54	45	106
10,70	12	118	71	54	45	107
10,80	12	118	71	54	45	108
10,90	12	118	71	54	45	109
11,00	12	118	71	54	45	110
11,10	12	118	71	54	45	111
11,11	12	118	71	54	45	906
11,20	12	118	71	54	45	112
11,30	12	118	71	54	45	113
11,40	12	118	71	54	45	114
11,50	12	118	71	54	45	115
11,60	12	118	71	54	45	116
11,70	12	118	71	54	45	117
11,80	12	118	71	54	45	118
11,90	12	118	71	54	45	119
12,00	12	118	71	54	45	120
12,10	14	124	77	58	45	121
12,20	14	124	77	58	45	122
12,30	14	124	77	58	45	123
12,40	14	124	77	58	45	124
12,50	14	124	77	58	45	125
12,60	14	124	77	58	45	126
12,70	14	124	77	58	45	907
12,80	14	124	77	58	45	128
12,90	14	124	77	58	45	129
13,00	14	124	77	58	45	130
13,10	14	124	77	58	45	131
13,20	14	124	77	58	45	132
13,30	14	124	77	58	45	133
13,40	14	124	77	58	45	134
13,50	14	124	77	58	45	135
13,60	14	124	77	58	45	136
13,70	14	124	77	58	45	137
13,80	14	124	77	58	45	138
13,90	14	124	77	58	45	139

P	○
M	●
K	
N	
S	●
H	
O	

→ v_c Page 109

WTX – High-performance drill, DIN 6537

▲ Specialist for difficult to machine materials

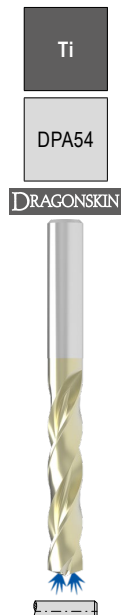
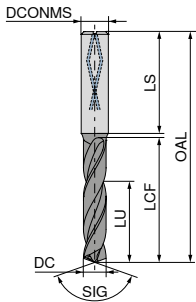
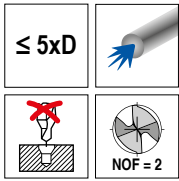

SIG 140°
Solid carbide

10 787 ...

DC _{m7} mm	DCONMS _{h6} mm	OAL mm	LCF mm	LU mm	LS mm	
19,1	20	153	101	75	50	191
19,2	20	153	101	75	50	192
19,3	20	153	101	75	50	193
19,4	20	153	101	75	50	194
19,5	20	153	101	75	50	195
19,6	20	153	101	75	50	196
19,7	20	153	101	75	50	197
19,8	20	153	101	75	50	198
19,9	20	153	101	75	50	199
20,0	20	153	101	75	50	200

P	○
M	●
K	
N	
S	●
H	
O	

→ v_c Page 109

10 787 ...

DC _{m7} mm	DCONMS _{h6} mm	OAL mm	LCF mm	LU mm	LS mm	
14,0	14	124	77	58	45	140
14,1	16	133	83	61	48	141
14,2	16	133	83	61	48	142
14,3	16	133	83	61	48	143
14,4	16	133	83	61	48	144
14,5	16	133	83	61	48	145
14,6	16	133	83	61	48	146
14,7	16	133	83	61	48	147
14,8	16	133	83	61	48	148
14,9	16	133	83	61	48	149
15,0	16	133	83	61	48	150
15,1	16	133	83	61	48	151
15,2	16	133	83	61	48	152
15,3	16	133	83	61	48	153
15,4	16	133	83	61	48	154
15,5	16	133	83	61	48	155
15,6	16	133	83	61	48	156
15,7	16	133	83	61	48	157
15,8	16	133	83	61	48	158
15,9	16	133	83	61	48	159
16,0	16	133	83	61	48	160
16,1	18	143	93	69	48	161
16,2	18	143	93	69	48	162
16,3	18	143	93	69	48	163
16,4	18	143	93	69	48	164
16,5	18	143	93	69	48	165
16,6	18	143	93	69	48	166
16,7	18	143	93	69	48	167
16,8	18	143	93	69	48	168
16,9	18	143	93	69	48	169
17,0	18	143	93	69	48	170
17,1	18	143	93	69	48	171
17,2	18	143	93	69	48	172
17,3	18	143	93	69	48	173
17,4	18	143	93	69	48	174
17,5	18	143	93	69	48	175
17,6	18	143	93	69	48	176
17,7	18	143	93	69	48	177
17,8	18	143	93	69	48	178
17,9	18	143	93	69	48	179
18,0	18	143	93	69	48	180
18,1	20	153	101	75	50	181
18,2	20	153	101	75	50	182
18,3	20	153	101	75	50	183
18,4	20	153	101	75	50	184
18,5	20	153	101	75	50	185
18,6	20	153	101	75	50	186
18,7	20	153	101	75	50	187
18,8	20	153	101	75	50	188
18,9	20	153	101	75	50	189
19,0	20	153	101	75	50	190

WTX – High Performance Drill, DIN 6537

- ▲ universal application
- ▲ four guidance lands

- ▲ polished chip flutes
- ▲ Type ALU 5xD on request

- ▲ PL = corner chamfers

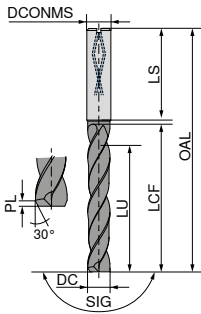
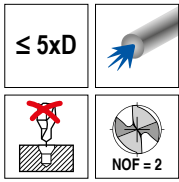

180
Ti800



SIG 180°
Solid carbide

10 721 ...

DC _{m7} mm	DCONMS _{h6} mm	OAL mm	LCF mm	LU mm	LS mm	PL mm	
3,00	6	66	28	23	36	0,15	030
3,10	6	66	28	23	36	0,16	031
3,20	6	66	28	23	36	0,16	032
3,30	6	66	28	23	36	0,17	033
3,40	6	66	28	23	36	0,17	034
3,50	6	66	28	23	36	0,18	035
3,60	6	66	28	23	36	0,18	036
3,70	6	66	28	23	36	0,19	037
3,80	6	74	36	29	36	0,19	038
3,90	6	74	36	29	36	0,20	039
4,00	6	74	36	29	36	0,20	040
4,10	6	74	36	29	36	0,21	041
4,20	6	74	36	29	36	0,21	042
4,30	6	74	36	29	36	0,22	043
4,40	6	74	36	29	36	0,22	044
4,50	6	74	36	29	36	0,23	045
4,60	6	74	36	29	36	0,23	046
4,65	6	74	36	29	36	0,23	900
4,70	6	74	36	29	36	0,24	047
4,80	6	82	44	35	36	0,24	048
4,90	6	82	44	35	36	0,25	049
5,00	6	82	44	35	36	0,25	050
5,10	6	82	44	35	36	0,26	051
5,20	6	82	44	35	36	0,26	052
5,30	6	82	44	35	36	0,27	053
5,40	6	82	44	35	36	0,27	054
5,50	6	82	44	35	36	0,28	055
5,55	6	82	44	35	36	0,28	902
5,60	6	82	44	35	36	0,28	056
5,70	6	82	44	35	36	0,29	057
5,80	6	82	44	35	36	0,29	058
5,90	6	82	44	35	36	0,30	059
6,00	6	82	44	35	36	0,30	060
6,10	8	91	53	43	36	0,31	061
6,20	8	91	53	43	36	0,31	062
6,30	8	91	53	43	36	0,32	063
6,40	8	91	53	43	36	0,32	064
6,50	8	91	53	43	36	0,33	065
6,60	8	91	53	43	36	0,33	066
6,70	8	91	53	43	36	0,34	067
6,80	8	91	53	43	36	0,34	068
6,90	8	91	53	43	36	0,35	069
7,00	8	91	53	43	36	0,35	070
7,10	8	91	53	43	36	0,36	071
7,20	8	91	53	43	36	0,36	072
7,30	8	91	53	43	36	0,37	073
7,40	8	91	53	43	36	0,37	074
7,50	8	91	53	43	36	0,38	075
7,60	8	91	53	43	36	0,38	076
7,70	8	91	53	43	36	0,39	077
7,80	8	91	53	43	36	0,39	078
7,90	8	91	53	43	36	0,40	079
8,00	8	91	53	43	36	0,40	080
8,10	10	103	61	49	40	0,41	081

DC _{m7} mm	DCONMS _{h6} mm	OAL mm	LCF mm	LU mm	LS mm	PL mm	10 721 ...
8,20	10	103	61	49	40	0,41	082
8,30	10	103	61	49	40	0,42	083
8,40	10	103	61	49	40	0,42	084
8,50	10	103	61	49	40	0,43	085
8,60	10	103	61	49	40	0,43	086
8,70	10	103	61	49	40	0,44	087
8,80	10	103	61	49	40	0,44	088
8,90	10	103	61	49	40	0,45	089
9,00	10	103	61	49	40	0,45	090
9,10	10	103	61	49	40	0,46	091
9,20	10	103	61	49	40	0,46	092
9,30	10	103	61	49	40	0,47	093
9,40	10	103	61	49	40	0,47	094
9,50	10	103	61	49	40	0,48	095
9,60	10	103	61	49	40	0,48	096
9,70	10	103	61	49	40	0,49	097
9,80	10	103	61	49	40	0,49	098
9,90	10	103	61	49	40	0,50	099
10,00	10	103	61	49	40	0,50	100
10,10	12	116	69	54	45	0,51	101
10,20	12	116	69	54	45	0,51	102
10,30	12	116	69	54	45	0,52	103
10,40	12	116	69	54	45	0,52	104
10,50	12	116	69	54	45	0,53	105
10,60	12	116	69	54	45	0,53	106
10,70	12	116	69	54	45	0,54	107
10,80	12	116	69	54	45	0,54	108
10,90	12	116	69	54	45	0,55	109
11,00	12	116	69	54	45	0,55	110
11,10	12	116	69	54	45	0,56	111
11,20	12	116	69	54	45	0,56	112
11,30	12	116	69	54	45	0,57	113
11,40	12	116	69	54	45	0,57	114
11,50	12	116	69	54	45	0,58	115
11,60	12	116	69	54	45	0,58	116
11,70	12	116	69	54	45	0,59	117
11,80	12	116	69	54	45	0,59	118
11,90	12	116	69	54	45	0,60	119
12,00	12	116	69	54	45	0,60	120
12,50	14	122	75	58	45	0,63	125
12,80	14	122	75	58	45	0,64	128
13,00	14	122	75	58	45	0,65	130
13,50	14	122	75	58	45	0,68	135
13,80	14	122	75	58	45	0,69	138
14,00	14	122	75	58	45	0,70	140
14,50	16	131	81	61	48	0,73	145
14,80	16	131	81	61	48	0,74	148
15,00	16	131	81	61	48	0,75	150
15,50	16	131	81	61	48	0,78	155
15,80	16	131	81	61	48	0,79	158
16,00	16	131	81	61	48	0,80	160
16,50	18	141	91	69	48	0,83	165
16,80	18	141	91	69	48	0,84	168
17,00	18	141	91	69	48	0,85	170
17,50	18	141	91	69	48	0,88	175
17,80	18	141	91	69	48	0,89	178
18,00	18	141	91	69	48	0,90	180
18,50	20	151	99	75	50	0,93	185
18,80	20	151	99	75	50	0,94	188
19,00	20	151	99	75	50	0,95	190
19,50	20	151	99	75	50	0,98	195
19,80	20	151	99	75	50	0,99	198
20,00	20	151	99	75	50	1,00	200

P	●
M	●
K	●
N	
S	
H	
O	

→ v_c Page 127
→ Machining information: Page 127

WTX – High Feed Drill, factory standard

- ▲ Three fluted high-feed drill
- ▲ Universal application

- ▲ High positioning accuracy
- ▲ Suitable for difficult drilling applications

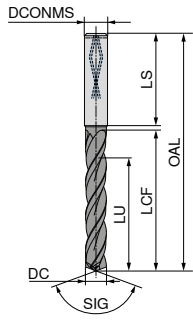
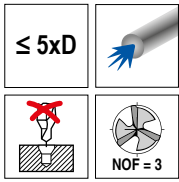

Feed UNI
DPX74S
DRAGONSKIN



SIG 140°
Solid carbide
10 789 ...

DC _{m7} mm	DCONMS _{h6} mm	OAL mm	LCF mm	LU mm	LS mm	
4,00	6	74	36	29	36	04000
4,10	6	74	36	29	36	04100
4,20	6	74	36	29	36	04200
4,30	6	74	36	29	36	04300
4,40	6	74	36	29	36	04400
4,50	6	74	36	29	36	04500
4,60	6	74	36	29	36	04600
4,70	6	74	36	29	36	04700
4,80	6	82	44	35	36	04800
4,90	6	82	44	35	36	04900
5,00	6	82	44	35	36	05000
5,10	6	82	44	35	36	05100
5,20	6	82	44	35	36	05200
5,30	6	82	44	35	36	05300
5,40	6	82	44	35	36	05400
5,50	6	82	44	35	36	05500
5,55	6	82	44	35	36	05550
5,60	6	82	44	35	36	05600
5,70	6	82	44	35	36	05700
5,80	6	82	44	35	36	05800
5,90	6	82	44	35	36	05900
6,00	6	82	44	35	36	06000
6,10	8	91	53	43	36	06100
6,20	8	91	53	43	36	06200
6,30	8	91	53	43	36	06300
6,40	8	91	53	43	36	06400
6,50	8	91	53	43	36	06500
6,60	8	91	53	43	36	06600
6,70	8	91	53	43	36	06700
6,80	8	91	53	43	36	06800
6,90	8	91	53	43	36	06900
7,00	8	91	53	43	36	07000
7,10	8	91	53	43	36	07100
7,20	8	91	53	43	36	07200
7,30	8	91	53	43	36	07300
7,40	8	91	53	43	36	07400
7,50	8	91	53	43	36	07500
7,60	8	91	53	43	36	07600
7,70	8	91	53	43	36	07700
7,80	8	91	53	43	36	07800
7,90	8	91	53	43	36	07900
8,00	8	91	53	43	36	08000
8,10	10	103	61	49	40	08100
8,20	10	103	61	49	40	08200
8,30	10	103	61	49	40	08300
8,40	10	103	61	49	40	08400
8,50	10	103	61	49	40	08500
8,60	10	103	61	49	40	08600
8,70	10	103	61	49	40	08700
8,80	10	103	61	49	40	08800
8,90	10	103	61	49	40	08900
9,00	10	103	61	49	40	09000

10 789 ...

DC _{m7} mm	DCONMS _{h6} mm	OAL mm	LCF mm	LU mm	LS mm	
9,10	10	103	61	49	40	09100
9,20	10	103	61	49	40	09200
9,30	10	103	61	49	40	09300
9,40	10	103	61	49	40	09400
9,50	10	103	61	49	40	09500
9,60	10	103	61	49	40	09600
9,70	10	103	61	49	40	09700
9,80	10	103	61	49	40	09800
9,90	10	103	61	49	40	09900
10,00	10	103	61	49	40	10000
10,10	12	118	71	56	45	10100
10,20	12	118	71	56	45	10200
10,30	12	118	71	56	45	10300
10,40	12	118	71	56	45	10400
10,50	12	118	71	56	45	10500
10,60	12	118	71	56	45	10600
10,70	12	118	71	56	45	10700
10,80	12	118	71	56	45	10800
10,90	12	118	71	56	45	10900
11,00	12	118	71	56	45	11000
11,10	12	118	71	56	45	11100
11,20	12	118	71	56	45	11200
11,30	12	118	71	56	45	11300
11,40	12	118	71	56	45	11400
11,50	12	118	71	56	45	11500
11,60	12	118	71	56	45	11600
11,70	12	118	71	56	45	11700
11,80	12	118	71	56	45	11800
11,90	12	118	71	56	45	11900
12,00	12	118	71	56	45	12000
12,20	14	124	77	60	45	12200
12,50	14	124	77	60	45	12500
12,80	14	124	77	60	45	12800
13,00	14	124	77	60	45	13000
13,50	14	124	77	60	45	13500
13,80	14	124	77	60	45	13800
14,00	14	124	77	60	45	14000
14,50	16	133	83	63	48	14500
14,80	16	133	83	63	48	14800
15,00	16	133	83	63	48	15000
15,50	16	133	83	63	48	15500
15,80	16	133	83	63	48	15800
16,00	16	133	83	63	48	16000
16,50	18	143	93	71	48	16500
16,80	18	143	93	71	48	16800
17,00	18	143	93	71	48	17000
17,50	18	143	93	71	48	17500
17,80	18	143	93	71	48	17800
18,00	18	143	93	71	48	18000
18,50	20	153	101	77	50	18500
18,80	20	153	101	77	50	18800
19,00	20	153	101	77	50	19000
19,50	20	153	101	77	50	19500
19,80	20	153	101	77	50	19800
20,00	20	153	101	77	50	20000

P	●
M	●
K	●
N	○
S	
H	
O	

→ v. Page 116

WTX – High Speed Drill, DIN 6537

- ▲ Four fluted high-feed drill
- ▲ Specially designed for steel and cast iron machining

- ▲ Has four spiral coolant holes
- ▲ Innovative cutting edge geometry guarantees high positioning accuracy

- ▲ Outstanding drilling quality in terms of tolerance, surface finish and position

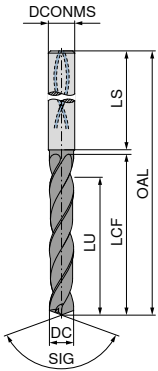
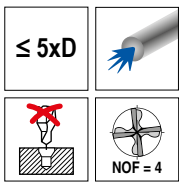

HFDS
DPX14S
DRAGONSKIN



SIG 130°
Solid carbide

10 798 ...

DC _{m7} mm	DCONMS _{h6} mm	OAL mm	LCF mm	LU mm	LS mm	
6,0	8	89	51	40	36	06000
6,1	10	102	59	47	40	06100
6,2	10	102	59	47	40	06200
6,3	10	102	59	47	40	06300
6,4	10	102	59	47	40	06400
6,5	10	102	59	47	40	06500
6,6	10	102	59	47	40	06600
6,7	10	102	59	47	40	06700
6,8	10	102	59	47	40	06800
6,9	10	102	59	47	40	06900
7,0	10	102	59	47	40	07000
7,1	10	102	59	47	40	07100
7,2	10	102	59	47	40	07200
7,3	10	102	59	47	40	07300
7,4	10	102	59	47	40	07400
7,5	10	102	59	47	40	07500
7,6	10	102	59	47	40	07600
7,7	10	102	59	47	40	07700
7,8	10	102	59	47	40	07800
7,9	10	102	59	47	40	07900
8,0	10	102	59	47	40	08000
8,1	12	118	70	55	45	08100
8,2	12	118	70	55	45	08200
8,3	12	118	70	55	45	08300
8,4	12	118	70	55	45	08400
8,5	12	118	70	55	45	08500
8,6	12	118	70	55	45	08600
8,7	12	118	70	55	45	08700
8,8	12	118	70	55	45	08800
8,9	12	118	70	55	45	08900
9,0	12	118	70	55	45	09000
9,1	12	118	70	55	45	09100
9,2	12	118	70	55	45	09200
9,3	12	118	70	55	45	09300
9,4	12	118	70	55	45	09400
9,5	12	118	70	55	45	09500
9,6	12	118	70	55	45	09600
9,7	12	118	70	55	45	09700
9,8	12	118	70	55	45	09800
9,9	12	118	70	55	45	09900
10,0	12	118	70	55	45	10000
10,2	14	124	76	60	45	10200
10,5	14	124	76	60	45	10500
11,0	14	124	76	60	45	11000
11,5	14	124	76	60	45	11500
12,0	14	124	76	60	45	12000
12,5	16	142	91	73	48	12500
13,0	16	142	91	73	48	13000

DC _{m7} mm	DCONMS _{h6} mm	OAL mm	LCF mm	LU mm	LS mm	
14,0	16	142	91	73	48	14000
14,3	16	142	91	73	48	14300
14,5	16	142	91	73	48	14500
15,0	18	142	91	73	48	15000
16,0	18	142	91	73	48	16000

10 798 ...

P	●
M	○
K	●
N	○
S	○
H	○
O	○

→ v_c Page 125

WTX – High Performance Drill, factory standard

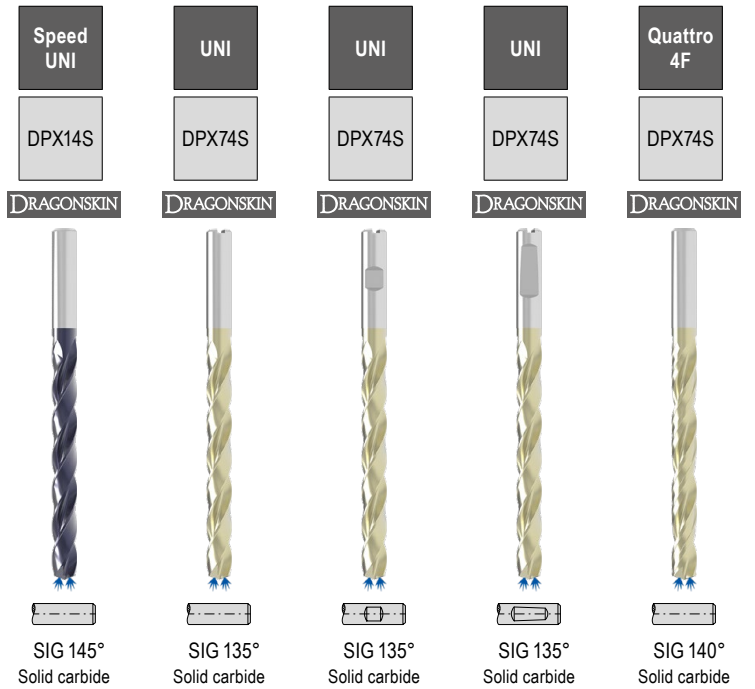
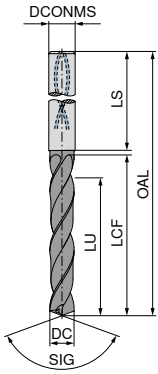
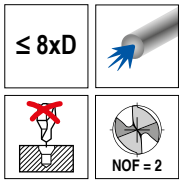

SIG 145° Solid carbide SIG 135° Solid carbide SIG 135° Solid carbide SIG 135° Solid carbide SIG 140° Solid carbide

DC _{m7h7} mm	DCONMS _{h6} mm	OAL mm	LCF mm	LU mm	LS mm	10 782 ...	11 789 ...	11 790 ...	11 788 ...	10 736 ...
3,00	6	72	34	29	36	03000	030	030	030	03000
3,10	6	72	34	29	36	03100	031	031	031	03100
3,20	6	72	34	29	36	03200	032	032	032	03200
3,30	6	72	34	29	36	03300	033	033	033	03300
3,40	6	72	34	29	36	03400	034	034	034	03400
3,50	6	72	34	29	36	03500	035	035	035	03500
3,60	6	72	34	29	36	03600	036	036	036	03600
3,70	6	72	34	29	36	03700	037	037	037	03700
3,80	6	81	43	36	36	03800	038	038	038	03800
3,90	6	81	43	36	36	03900	039	039	039	03900
4,00	6	81	43	36	36	04000	040	040	040	04000
4,10	6	81	43	36	36	04100	041	041	041	04100
4,20	6	81	43	36	36	04200	042	042	042	04200
4,30	6	81	43	36	36	04300	043	043	043	04300
4,40	6	81	43	36	36	04400	044	044	044	04400
4,50	6	81	43	36	36	04500	045	045	045	04500
4,60	6	81	43	36	36	04600	046	046	046	04600
4,65	6	81	43	36	36	04650				
4,70	6	81	43	36	36	04700	047	047	047	04700
4,80	6	95	57	48	36	04800	048	048	048	04800
4,90	6	95	57	48	36	04900	049	049	049	04900
5,00	6	95	57	48	36	05000	050	050	050	05000
5,10	6	95	57	48	36	05100	051	051	051	05100
5,20	6	95	57	48	36	05200	052	052	052	05200
5,30	6	95	57	48	36	05300	053	053	053	05300
5,40	6	95	57	48	36	05400	054	054	054	05400
5,50	6	95	57	48	36	05500	055	055	055	05500
5,55	6	95	57	48	36	05550				
5,60	6	95	57	48	36	05600	056	056	056	05600
5,70	6	95	57	48	36	05700	057	057	057	05700
5,80	6	95	57	48	36	05800	058	058	058	05800
5,90	6	95	57	48	36	05900	059	059	059	05900
6,00	6	95	57	48	36	06000	060	060	060	06000
6,10	8	114	76	64	36	06100	061	061	061	06100

P	●	●	●	●	●
M	●	●	●	●	●
K	●	●	●	●	●
N					
S					
H		○	○	○	○
O					

→ v_c Page 115–120

Ø DC_{m7} for Type UNI and Quattro 4F / Ø DC_{h7} for Type Speed UNI

WTX – High Performance Drill, factory standard

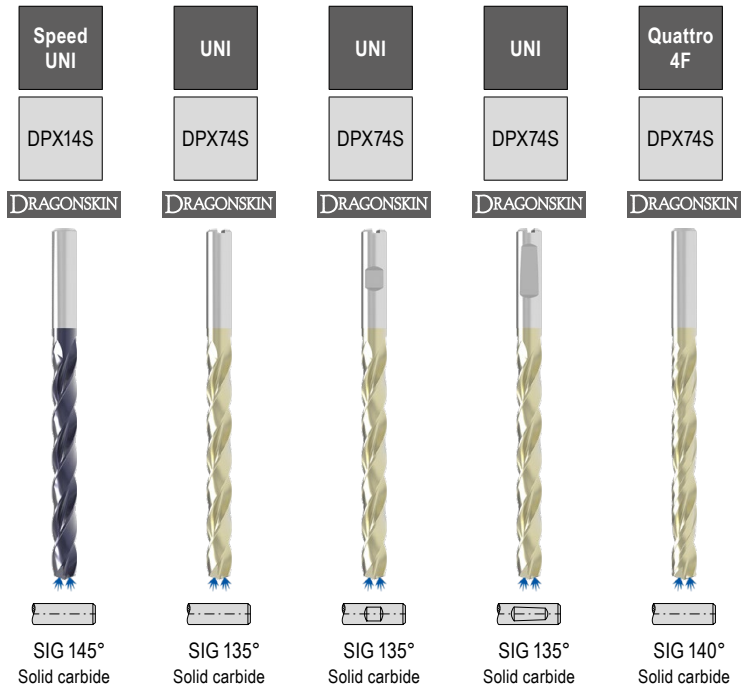
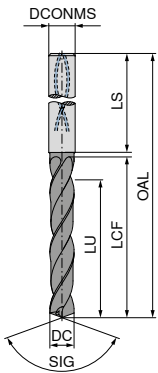
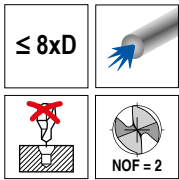

SIG 145° Solid carbide SIG 135° Solid carbide SIG 135° Solid carbide SIG 135° Solid carbide SIG 140° Solid carbide

DC _{m7h7} mm	DCONMS _{h6} mm	OAL mm	LCF mm	LU mm	LS mm	10 782 ...	11 789 ...	11 790 ...	11 788 ...	10 736 ...
6,20	8	114	76	64	36	06200	062	062	062	06200
6,30	8	114	76	64	36	06300	063	063	063	06300
6,40	8	114	76	64	36	06400	064	064	064	06400
6,50	8	114	76	64	36	06500	065	065	065	06500
6,60	8	114	76	64	36	06600	066	066	066	06600
6,70	8	114	76	64	36	06700	067	067	067	06700
6,80	8	114	76	64	36	06800	068	068	068	06800
6,90	8	114	76	64	36	06900	069	069	069	06900
7,00	8	114	76	64	36	07000	070	070	070	07000
7,10	8	114	76	64	36	07100	071	071	071	07100
7,20	8	114	76	64	36	07200	072	072	072	07200
7,30	8	114	76	64	36	07300	073	073	073	07300
7,40	8	114	76	64	36	07400	074	074	074	07400
7,50	8	114	76	64	36	07500	075	075	075	07500
7,60	8	114	76	64	36	07600	076	076	076	07600
7,70	8	114	76	64	36	07700	077	077	077	07700
7,80	8	114	76	64	36	07800	078	078	078	07800
7,90	8	114	76	64	36	07900	079	079	079	07900
8,00	8	114	76	64	36	08000	080	080	080	08000
8,10	10	142	95	80	40	08100	081	081	081	08100
8,20	10	142	95	80	40	08200	082	082	082	08200
8,30	10	142	95	80	40	08300	083	083	083	08300
8,40	10	142	95	80	40	08400	084	084	084	08400
8,50	10	142	95	80	40	08500	085	085	085	08500
8,60	10	142	95	80	40	08600	086	086	086	08600
8,70	10	142	95	80	40	08700	087	087	087	08700
8,80	10	142	95	80	40	08800	088	088	088	08800
8,90	10	142	95	80	40	08900	089	089	089	08900
9,00	10	142	95	80	40	09000	090	090	090	09000
9,10	10	142	95	80	40	09100	091	091	091	09100
9,20	10	142	95	80	40	09200	092	092	092	09200
9,30	10	142	95	80	40	09300	093	093	093	09300
9,40	10	142	95	80	40	09400	094	094	094	09400
9,50	10	142	95	80	40	09500	095	095	095	09500

P	•	•	•	•	•
M	•	•	•	•	•
K	•	•	•	•	•
N					
S					
H		○	○	○	○
O					

→ v_c Page 115–120

Ø DC_{m7} for Type UNI and Quattro 4F / Ø DC_{h7} for Type Speed UNI

WTX – High Performance Drill, factory standard

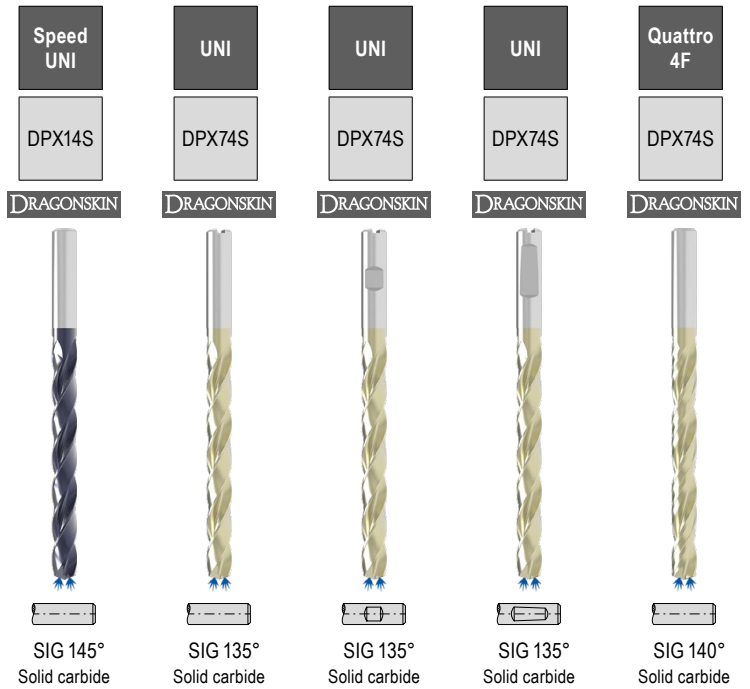
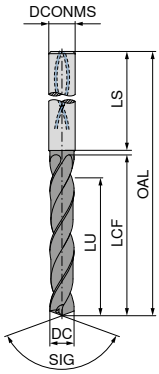
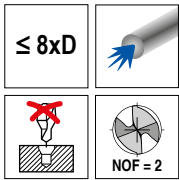

DC _{mTn7} mm	DCONMS _{h6} mm	OAL mm	LCF mm	LU mm	LS mm	10 782 ...	11 789 ...	11 790 ...	11 788 ...	10 736 ...
9,60	10	142	95	80	40	09600	096	096	096	09600
9,70	10	142	95	80	40	09700	097	097	097	09700
9,80	10	142	95	80	40	09800	098	098	098	09800
9,90	10	142	95	80	40	09900	099	099	099	09900
10,00	10	142	95	80	40	10000	100	100	100	10000
10,10	12	162	114	96	45	10100	101	101	101	10100
10,20	12	162	114	96	45	10200	102	102	102	10200
10,30	12	162	114	96	45	10300	103	103	103	10300
10,40	12	162	114	96	45	10400	104	104	104	10400
10,50	12	162	114	96	45	10500	105	105	105	10500
10,60	12	162	114	96	45	10600	106	106	106	10600
10,70	12	162	114	96	45	10700	107	107	107	10700
10,80	12	162	114	96	45	10800	108	108	108	10800
10,90	12	162	114	96	45	10900	109	109	109	10900
11,00	12	162	114	96	45	11000	110	110	110	11000
11,10	12	162	114	96	45	11100	111	111	111	11100
11,20	12	162	114	96	45	11200	112	112	112	11200
11,30	12	162	114	96	45	11300	113	113	113	11300
11,40	12	162	114	96	45	11400	114	114	114	11400
11,50	12	162	114	96	45	11500	115	115	115	11500
11,60	12	162	114	96	45	11600	116	116	116	11600
11,70	12	162	114	96	45	11700	117	117	117	11700
11,80	12	162	114	96	45	11800	118	118	118	11800
11,90	12	162	114	96	45	11900	119	119	119	11900
12,00	12	162	114	96	45	12000	120	120	120	12000
12,50	14	178	131	112	45	12500	125	125	125	12500
12,80	14	178	131	112	45	12800	128	128	128	12800
13,00	14	178	131	112	45	13000	130	130	130	13000
13,50	14	178	131	112	45	13500	135	135	135	13500
13,80	14	178	131	112	45	13800	138	138	138	13800
14,00	14	178	131	112	45	14000	140	140	140	14000
14,50	16	203	152	128	48	14500	145	145	145	14500
14,80	16	203	152	128	48	14800	148	148	148	14800
15,00	16	203	152	128	48	15000	150	150	150	15000

P	●	●	●	●	●
M	●	●	●	●	●
K	●	●	●	●	●
N					
S					
H		○	○	○	○
O					

→ v_c Page 115–120

Ø DC_{m7} for Type UNI and Quattro 4F / Ø DC_{h7} for Type Speed UNI

WTX – High Performance Drill, factory standard

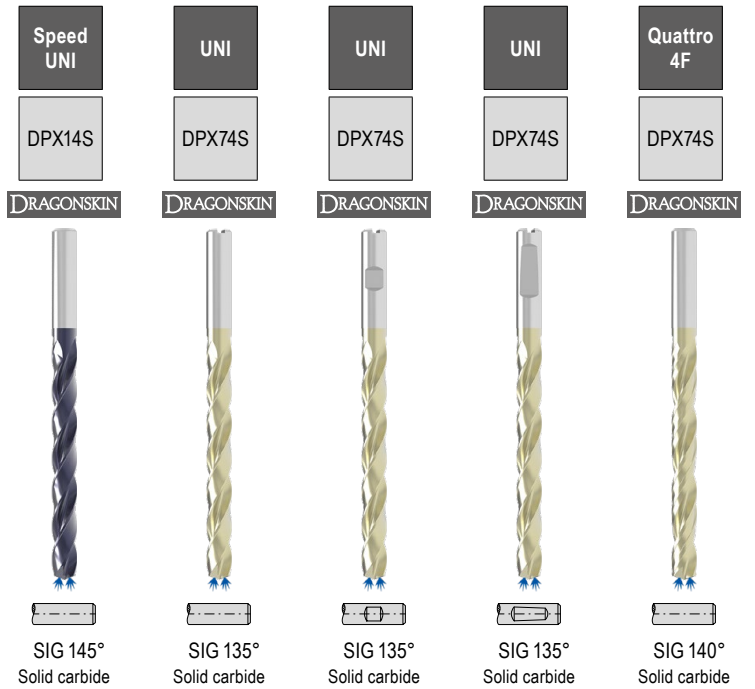
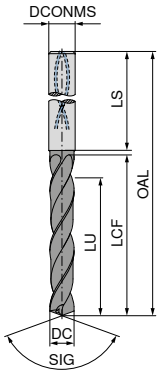
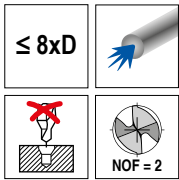

DC _{m7h7} mm	DCONMS _{h6} mm	OAL mm	LCF mm	LU mm	LS mm
15,50	16	203	152	128	48
15,80	16	203	152	128	48
16,00	16	203	152	128	48
16,50	18	222	171	144	48
16,80	18	222	171	144	48
17,00	18	222	171	144	48
17,50	18	222	171	144	48
17,80	18	222	171	144	48
18,00	18	222	171	144	48
18,50	20	243	190	160	50
18,80	20	243	190	160	50
19,00	20	243	190	160	50
19,50	20	243	190	160	50
19,80	20	243	190	160	50
20,00	20	243	190	160	50

10 782 ...	11 789 ...	11 790 ...	11 788 ...	10 736 ...
15500	155	155	155	15500
15800	158	158	158	15800
16000	160	160	160	16000
16500	165	165	165	16500
16800	168	168	168	16800
17000	170	170	170	17000
17500	175	175	175	17500
17800	178	178	178	17800
18000	180	180	180	18000
	185	185	185	
	188	188	188	
	190	190	190	
	195	195	195	
	198	198	198	
	200	200	200	

P	●	●	●	●	●
M	●				
K	●	●	●	●	●
N					
S					
H		○	○	○	○
O					

→ v_c Page 115–120

Ø DC_{m7} for Type UNI and Quattro 4F / Ø DC_{h7} for Type Speed UNI

High Performance Drill, factory standard

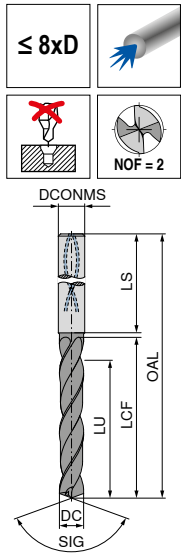

UNI
TiAlN



SIG 135°
Solid carbide
11 704 ...

DC _{h7} mm	DCONMS _{h6} mm	OAL mm	LCF mm	LU mm	LS mm	
3,0	6	72	34	29,5	36	03000
3,1	6	72	34	29,3	36	03100
3,2	6	72	34	29,2	36	03200
3,3	6	72	34	29,0	36	03300
3,4	6	72	34	28,9	36	03400
3,5	6	72	34	28,7	36	03500
3,6	6	72	34	28,6	36	03600
3,7	6	72	34	28,4	36	03700
3,8	6	81	43	37,3	36	03800
3,9	6	81	43	37,1	36	03900
4,0	6	81	43	37,0	36	04000
4,1	6	81	43	36,8	36	04100
4,2	6	81	43	36,7	36	04200
4,3	6	81	43	36,5	36	04300
4,4	6	81	43	36,4	36	04400
4,5	6	81	43	36,2	36	04500
4,6	6	81	43	36,1	36	04600
4,7	6	81	43	35,9	36	04700
4,8	6	95	57	49,8	36	04800
4,9	6	95	57	49,6	36	04900
5,0	6	95	57	49,5	36	05000
5,1	6	95	57	49,3	36	05100
5,2	6	95	57	49,2	36	05200
5,3	6	95	57	49,0	36	05300
5,4	6	95	57	48,9	36	05400
5,5	6	95	57	48,7	36	05500
5,6	6	95	57	48,6	36	05600
5,7	6	95	57	48,4	36	05700
5,8	6	95	57	48,3	36	05800
5,9	6	95	57	48,1	36	05900
6,0	6	95	57	48,0	36	06000
6,1	8	114	76	66,8	36	06100
6,2	8	114	76	66,7	36	06200
6,3	8	114	76	66,5	36	06300
6,4	8	114	76	66,4	36	06400
6,5	8	114	76	66,2	36	06500
6,6	8	114	76	66,1	36	06600
6,7	8	114	76	65,9	36	06700
6,8	8	114	76	65,8	36	06800
6,9	8	114	76	65,6	36	06900
7,0	8	114	76	65,5	36	07000
7,1	8	114	76	65,3	36	07100
7,2	8	114	76	65,2	36	07200
7,3	8	114	76	65,0	36	07300
7,4	8	114	76	64,9	36	07400
7,5	8	114	76	64,7	36	07500
7,6	8	114	76	64,6	36	07600
7,7	8	114	76	64,4	36	07700
7,8	8	114	76	64,3	36	07800
7,9	8	114	76	64,1	36	07900
8,0	8	114	76	64,0	36	08000
8,1	10	142	95	82,8	40	08100

11 704 ...

DC _{h7} mm	DCONMS _{h6} mm	OAL mm	LCF mm	LU mm	LS mm	
8,2	10	142	95	82,7	40	08200
8,3	10	142	95	82,5	40	08300
8,4	10	142	95	82,4	40	08400
8,5	10	142	95	82,2	40	08500
8,6	10	142	95	82,1	40	08600
8,7	10	142	95	81,9	40	08700
8,8	10	142	95	81,8	40	08800
8,9	10	142	95	81,6	40	08900
9,0	10	142	95	81,5	40	09000
9,1	10	142	95	81,3	40	09100
9,2	10	142	95	81,2	40	09200
9,3	10	142	95	81,0	40	09300
9,4	10	142	95	80,9	40	09400
9,5	10	142	95	80,7	40	09500
9,6	10	142	95	80,6	40	09600
9,7	10	142	95	80,4	40	09700
9,8	10	142	95	80,3	40	09800
9,9	10	142	95	80,1	40	09900
10,0	10	142	95	80,0	40	10000
10,2	12	162	114	98,7	45	10200
10,5	12	162	114	98,2	45	10500
10,8	12	162	114	97,8	45	10800
11,0	12	162	114	97,5	45	11000
11,5	12	162	114	96,7	45	11500
11,8	12	162	114	96,3	45	11800
12,0	12	162	114	96,0	45	12000
12,2	14	178	131	112,7	45	12200
12,5	14	178	131	112,2	45	12500
12,7	14	178	131	111,9	45	12700
13,0	14	178	131	111,5	45	13000
13,5	14	178	131	110,7	45	13500
14,0	14	178	131	110,0	45	14000
14,5	16	203	152	130,2	48	14500
15,0	16	203	152	129,5	48	15000
15,5	16	203	152	128,7	48	15500
16,0	16	203	152	128,0	48	16000
16,5	18	222	171	146,2	48	16500
17,0	18	222	171	145,5	48	17000
17,5	18	222	171	144,7	48	17500
18,0	18	222	171	144,0	48	18000
18,5	20	243	190	162,2	50	18500
19,0	20	243	190	161,5	50	19000
19,5	20	243	190	160,7	50	19500
20,0	20	243	190	160,0	50	20000

P	●
M	●
K	●
N	
S	
H	
O	

→ v_c Page 130

WTX – High Performance Drill, factory standard

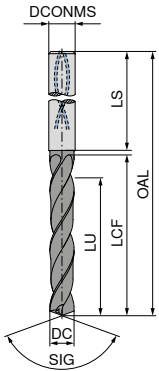
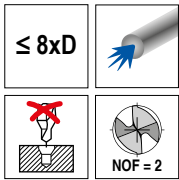

DC _{m7} mm	DCONMS _{h6} mm	OAL mm	LCF mm	LU mm	LS mm
3,0	6	72	34	29	36
3,1	6	72	34	29	36
3,2	6	72	34	29	36
3,3	6	72	34	29	36
3,4	6	72	34	29	36
3,5	6	72	34	29	36
3,6	6	72	34	29	36
3,7	6	72	34	29	36
3,8	6	81	43	36	36
3,9	6	81	43	36	36
4,0	6	81	43	36	36
4,1	6	81	43	36	36
4,2	6	81	43	36	36
4,3	6	81	43	36	36
4,4	6	81	43	36	36
4,5	6	81	43	36	36
4,6	6	81	43	36	36
4,7	6	81	43	36	36
4,8	6	95	57	48	36
4,9	6	95	57	48	36
5,0	6	95	57	48	36
5,1	6	95	57	48	36
5,2	6	95	57	48	36
5,3	6	95	57	48	36
5,4	6	95	57	48	36
5,5	6	95	57	48	36
5,6	6	95	57	48	36
5,7	6	95	57	48	36
5,8	6	95	57	48	36
5,9	6	95	57	48	36
6,0	6	95	57	48	36
6,1	8	114	76	64	36
6,2	8	114	76	64	36
6,3	8	114	76	64	36
6,4	8	114	76	64	36
6,5	8	114	76	64	36
6,6	8	114	76	64	36
6,7	8	114	76	64	36
6,8	8	114	76	64	36
6,9	8	114	76	64	36
7,0	8	114	76	64	36
7,1	8	114	76	64	36
7,2	8	114	76	64	36
7,3	8	114	76	64	36
7,4	8	114	76	64	36

10 770 ...	10 792 ...
030	03000
031	03100
032	03200
033	03300
034	03400
035	03500
036	03600
037	03700
038	03800
039	03900
040	04000
041	04100
042	04200
043	04300
044	04400
045	04500
046	04600
047	04700
048	04800
049	04900
050	05000
051	05100
052	05200
053	05300
054	05400
055	05500
056	05600
057	05700
058	05800
059	05900
060	06000
061	06100
062	06200
063	06300
064	06400
065	06500
066	06600
067	06700
068	06800
069	06900
070	07000
071	07100
072	07200
073	07300
074	07400

P	○	
M	●	
K	○	
N	○	●
S	●	
H		
O		

→ v_c Page 113+123

Ø DC_{m7} for Type VA / Ø DC_{h7} for Type AL

WTX – High Performance Drill, factory standard

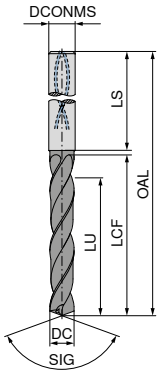
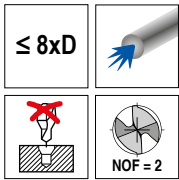

DC _{m7} mm	DCONMS _{h6} mm	OAL mm	LCF mm	LU mm	LS mm
7,5	8	114	76	64	36
7,6	8	114	76	64	36
7,7	8	114	76	64	36
7,8	8	114	76	64	36
7,9	8	114	76	64	36
8,0	8	114	76	64	36
8,1	10	142	95	80	40
8,2	10	142	95	80	40
8,3	10	142	95	80	40
8,4	10	142	95	80	40
8,5	10	142	95	80	40
8,6	10	142	95	80	40
8,7	10	142	95	80	40
8,8	10	142	95	80	40
8,9	10	142	95	80	40
9,0	10	142	95	80	40
9,1	10	142	95	80	40
9,2	10	142	95	80	40
9,3	10	142	95	80	40
9,4	10	142	95	80	40
9,5	10	142	95	80	40
9,6	10	142	95	80	40
9,7	10	142	95	80	40
9,8	10	142	95	80	40
9,9	10	142	95	80	40
10,0	10	142	95	80	40
10,1	12	162	114	96	45
10,2	12	162	114	96	45
10,3	12	162	114	96	45
10,4	12	162	114	96	45
10,5	12	162	114	96	45
10,6	12	162	114	96	45
10,7	12	162	114	96	45
10,8	12	162	114	96	45
10,9	12	162	114	96	45
11,0	12	162	114	96	45
11,1	12	162	114	96	45
11,2	12	162	114	96	45
11,3	12	162	114	96	45
11,4	12	162	114	96	45
11,5	12	162	114	96	45
11,6	12	162	114	96	45
11,7	12	162	114	96	45
11,8	12	162	114	96	45
11,9	12	162	114	96	45

10 770 ...	10 792 ...
075	07500
076	07600
077	07700
078	07800
079	07900
080	08000
081	08100
082	08200
083	08300
084	08400
085	08500
086	08600
087	08700
088	08800
089	08900
090	09000
091	09100
092	09200
093	09300
094	09400
095	09500
096	09600
097	09700
098	09800
099	09900
100	10000
101	
102	10200
103	10300
104	10400
105	10500
106	
107	10700
108	10800
109	
110	11000
111	
112	11200
113	
114	
115	11500
116	11600
117	
118	11800
119	

P	○	
M	●	
K	○	
N	○	●
S	●	
H		
O		

→ v_c Page 113+123

Ø DC_{m7} for Type VA / Ø DC_{h7} for Type AL

WTX – High Performance Drill, factory standard

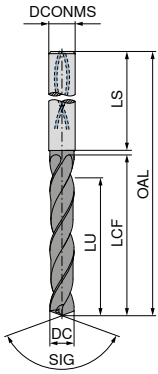
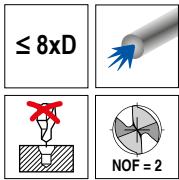

DC _{m7}	DCONMS _{h6}	OAL	LCF	LU	LS
mm	mm	mm	mm	mm	mm
12,0	12	162	114	96	45
12,2	14	178	131	112	45
12,5	14	178	133	112	45
12,5	14	178	131	112	45
12,8	14	178	133	112	45
12,8	14	178	131	112	45
13,0	14	178	133	112	45
13,0	14	178	131	112	45
13,2	14	178	131	112	45
13,5	14	178	131	112	45
13,5	14	178	133	112	45
13,8	14	178	131	112	45
13,8	14	178	133	112	45
14,0	14	178	133	112	45
14,0	14	178	131	112	45
14,2	16	203	152	128	48
14,5	16	203	152	128	48
14,8	16	203	152	128	48
15,0	16	203	152	128	48
15,2	16	203	152	128	48
15,5	16	203	152	128	48
15,8	16	203	152	128	48
16,0	16	203	152	128	48
16,2	18	222	171	144	48
16,5	18	222	171	144	48
16,8	18	222	171	144	48
17,0	18	222	171	144	48
17,2	18	222	171	144	48
17,5	18	222	171	144	48
17,8	18	222	171	144	48
18,0	18	222	171	144	48
18,2	20	243	190	160	50
18,5	20	243	190	160	50
18,8	20	243	190	160	50
19,0	20	243	190	160	50
19,1	20	243	190	160	50
19,2	20	243	190	160	50
19,5	20	243	190	160	50
19,8	20	243	190	160	50
20,0	20	243	190	160	50

10 770 ...	10 792 ...
120	12000
125	12200
128	12500
130	12800
135	13000
135	13200
135	13500
138	13800
140	14000
145	14200
148	14500
150	14800
150	15000
155	15200
158	15500
160	15800
160	16000
165	16200
168	16500
170	16800
170	17000
175	17200
178	17500
180	17800
180	18000
185	18200
188	18500
190	18800
190	19000
195	19100
195	19200
198	19500
198	19800
200	20000

P	○	
M	●	
K	○	
N	○	●
S	●	
H		
O		

→ v_c Page 113+123

Ø DC_{m7} for Type VA / Ø DC_{n7} for Type AL

WTX – High Feed Drill, factory standard

- ▲ Three fluted high-feed drill
- ▲ Universal application

- ▲ High positioning accuracy
- ▲ Suitable for difficult drilling applications

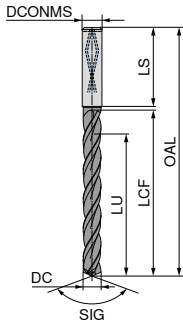
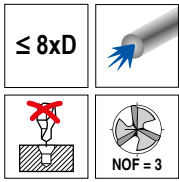

Feed UNI
DPX74S

DRAGONSKIN



SIG 135°
Solid carbide
10 794 ...

DC _{m7} mm	DCONMS _{h6} mm	OAL mm	LCF mm	LU mm	LS mm	
4,00	6	81	43	36	36	04000
4,10	6	81	43	36	36	04100
4,20	6	81	43	36	36	04200
4,30	6	81	43	36	36	04300
4,40	6	81	43	36	36	04400
4,50	6	81	43	36	36	04500
4,60	6	81	43	36	36	04600
4,70	6	81	43	36	36	04700
4,80	6	95	57	48	36	04800
4,90	6	95	57	48	36	04900
5,00	6	95	57	48	36	05000
5,10	6	95	57	48	36	05100
5,20	6	95	57	48	36	05200
5,30	6	95	57	48	36	05300
5,40	6	95	57	48	36	05400
5,50	6	95	57	48	36	05500
5,55	6	95	57	48	36	05550
5,60	6	95	57	48	36	05600
5,70	6	95	57	48	36	05700
5,80	6	95	57	48	36	05800
5,90	6	95	57	48	36	05900
6,00	6	95	57	48	36	06000
6,10	8	114	76	64	36	06100
6,20	8	114	76	64	36	06200
6,30	8	114	76	64	36	06300
6,40	8	114	76	64	36	06400
6,50	8	114	76	64	36	06500
6,60	8	114	76	64	36	06600
6,70	8	114	76	64	36	06700
6,80	8	114	76	64	36	06800
6,90	8	114	76	64	36	06900
7,00	8	114	76	64	36	07000
7,10	8	114	76	64	36	07100
7,20	8	114	76	64	36	07200
7,30	8	114	76	64	36	07300
7,40	8	114	76	64	36	07400
7,50	8	114	76	64	36	07500
7,60	8	114	76	64	36	07600
7,70	8	114	76	64	36	07700
7,80	8	114	76	64	36	07800
7,90	8	114	76	64	36	07900
8,00	8	114	76	64	36	08000
8,10	10	142	95	80	40	08100
8,20	10	142	95	80	40	08200
8,30	10	142	95	80	40	08300
8,40	10	142	95	80	40	08400
8,50	10	142	95	80	40	08500
8,60	10	142	95	80	40	08600
8,70	10	142	95	80	40	08700
8,80	10	142	95	80	40	08800
8,90	10	142	95	80	40	08900
9,00	10	142	95	80	40	09000

10 794 ...

DC _{m7} mm	DCONMS _{h6} mm	OAL mm	LCF mm	LU mm	LS mm	
9,10	10	142	95	80	40	09100
9,20	10	142	95	80	40	09200
9,30	10	142	95	80	40	09300
9,40	10	142	95	80	40	09400
9,50	10	142	95	80	40	09500
9,60	10	142	95	80	40	09600
9,70	10	142	95	80	40	09700
9,80	10	142	95	80	40	09800
9,90	10	142	95	80	40	09900
10,00	10	142	95	80	40	10000
10,10	12	162	114	96	45	10100
10,20	12	162	114	96	45	10200
10,30	12	162	114	96	45	10300
10,40	12	162	114	96	45	10400
10,50	12	162	114	96	45	10500
10,60	12	162	114	96	45	10600
10,70	12	162	114	96	45	10700
10,80	12	162	114	96	45	10800
10,90	12	162	114	96	45	10900
11,00	12	162	114	96	45	11000
11,10	12	162	114	96	45	11100
11,20	12	162	114	96	45	11200
11,30	12	162	114	96	45	11300
11,40	12	162	114	96	45	11400
11,50	12	162	114	96	45	11500
11,60	12	162	114	96	45	11600
11,70	12	162	114	96	45	11700
11,80	12	162	114	96	45	11800
11,90	12	162	114	96	45	11900
12,00	12	162	114	96	45	12000
12,20	14	178	131	112	45	12200
12,50	14	178	131	112	45	12500
12,80	14	178	131	112	45	12800
13,00	14	178	131	112	45	13000
13,50	14	178	131	112	45	13500
13,80	14	178	131	112	45	13800
14,00	14	178	131	112	45	14000
14,50	16	203	152	128	48	14500
14,80	16	203	152	128	48	14800
15,00	16	203	152	128	48	15000
15,50	16	203	152	128	48	15500
15,80	16	203	152	128	48	15800
16,00	16	203	152	128	48	16000
16,50	18	222	171	144	48	16500
16,80	18	222	171	144	48	16800
17,00	18	222	171	144	48	17000
17,50	18	222	171	144	48	17500
17,80	18	222	171	144	48	17800
18,00	18	222	171	144	48	18000
18,50	20	243	190	160	50	18500
18,80	20	243	190	160	50	18800
19,00	20	243	190	160	50	19000
19,50	20	243	190	160	50	19500
19,80	20	243	190	160	50	19800
20,00	20	243	190	160	50	20000

P	●
M	●
K	●
N	○
S	
H	
O	

→ v. Page 117

WTX – High Performance Drill, factory standard

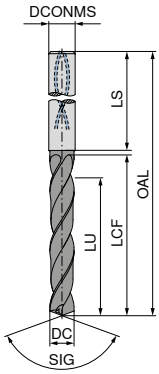
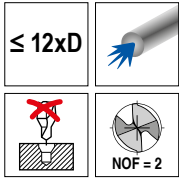

DC _{h7/m7} mm	DCONMS _{h6} mm	OAL mm	LCF mm	LU mm	LS mm
3,0	6	92	54	48	36
3,1	6	92	54	48	36
3,2	6	92	54	48	36
3,3	6	92	54	48	36
3,4	6	92	54	48	36
3,5	6	92	54	48	36
3,6	6	92	54	48	36
3,7	6	92	54	48	36
3,8	6	102	64	58	36
3,9	6	102	64	58	36
4,0	6	102	64	58	36
4,1	6	102	64	58	36
4,2	6	102	64	58	36
4,3	6	102	64	58	36
4,4	6	102	64	58	36
4,5	6	102	64	58	36
4,6	6	102	64	58	36
4,7	6	102	64	58	36
4,8	6	116	78	70	36
4,9	6	116	78	70	36
5,0	6	116	78	70	36
5,1	6	116	78	70	36
5,2	6	116	78	70	36
5,3	6	116	78	70	36
5,4	6	116	78	70	36
5,5	6	116	78	70	36
5,6	6	116	78	70	36
5,7	6	116	78	70	36
5,8	6	116	78	70	36
5,9	6	116	78	70	36
6,0	6	116	78	70	36
6,1	8	146	108	94	36
6,2	8	146	108	94	36
6,3	8	146	108	94	36
6,4	8	146	108	94	36
6,5	8	146	108	94	36
6,6	8	146	108	94	36
6,7	8	146	108	94	36
6,8	8	146	108	94	36
6,9	8	146	108	94	36
7,0	8	146	108	94	36
7,1	8	146	108	94	36
7,2	8	146	108	94	36

10 774 ...	10 737 ...	10 793 ...
03000	03000	03000
03100	03100	03100
03200	03200	03200
03300	03300	03300
03400	03400	03400
03500	03500	03500
03600	03600	03600
03700	03700	03700
03800	03800	03800
03900	03900	03900
04000	04000	04000
04100	04100	04100
04200	04200	04200
04300	04300	04300
04400	04400	04400
04500	04500	04500
04600	04600	04600
04700	04700	04700
04800	04800	04800
04900	04900	04900
05000	05000	05000
05100	05100	05100
05200	05200	05200
05300	05300	05300
05400	05400	05400
05500	05500	05500
05600	05600	05600
05700	05700	05700
05800	05800	05800
05900	05900	05900
06000	06000	06000
06100	06100	06100
06200	06200	06200
06300	06300	06300
06400	06400	06400
06500	06500	06500
06600	06600	06600
06700	06700	06700
06800	06800	06800
06900	06900	06900
07000	07000	07000
07100	07100	07100
07200	07200	07200

P	●	●	
M	●		
K	●	●	
N	○		●
S	●		
H		○	
O			

→ v_c Page 118-124

Ø DC_{h7} for Type Speed VA and AL / Ø DC_{m7} for Type Quattro 4F

WTX – High Performance Drill, factory standard

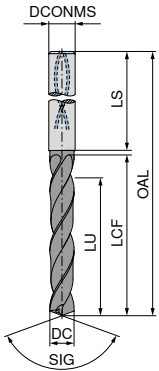
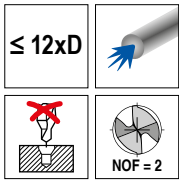

DC _{h7/m7}	DCONMS _{h6}	OAL	LCF	LU	LS	10 774 ...	10 737 ...	10 793 ...
mm	mm	mm	mm	mm	mm			
7,3	8	146	108	94	36	07300	07300	07300
7,4	8	146	108	94	36	07400	07400	07400
7,5	8	146	108	94	36	07500	07500	07500
7,6	8	146	108	94	36	07600	07600	07600
7,7	8	146	108	94	36	07700	07700	07700
7,8	8	146	108	94	36	07800	07800	07800
7,9	8	146	108	94	36	07900	07900	07900
8,0	8	146	108	94	36	08000	08000	08000
8,1	10	162	120	110	40	08100	08100	08100
8,2	10	162	120	110	40	08200	08200	08200
8,3	10	162	120	110	40	08300	08300	08300
8,4	10	162	120	110	40	08400	08400	08400
8,5	10	162	120	110	40	08500	08500	08500
8,6	10	162	120	110	40	08600	08600	08600
8,7	10	162	120	110	40	08700	08700	08700
8,8	10	162	120	110	40	08800	08800	08800
8,9	10	162	120	110	40	08900	08900	08900
9,0	10	162	120	110	40	09000	09000	09000
9,1	10	162	120	110	40	09100	09100	09100
9,2	10	162	120	110	40	09200	09200	09200
9,3	10	162	120	110	40	09300	09300	09300
9,4	10	162	120	110	40	09400	09400	09400
9,5	10	162	120	110	40	09500	09500	09500
9,6	10	162	120	110	40	09600	09600	09600
9,7	10	162	120	110	40	09700	09700	09700
9,8	10	162	120	110	40	09800	09800	09800
9,9	10	162	120	110	40	09900	09900	09900
10,0	10	162	120	110	40	10000	10000	10000
10,1	12	204	156	142	45	10100	10100	10100
10,2	12	204	156	142	45	10200	10200	10200
10,3	12	204	156	142	45	10300	10300	10300
10,4	12	204	156	142	45	10400	10400	10400
10,5	12	204	156	142	45	10500	10500	10500
10,6	12	204	156	142	45	10600	10600	10600
10,7	12	204	156	142	45	10700	10700	10700
10,8	12	204	156	142	45	10800	10800	10800
10,9	12	204	156	142	45	10900	10900	10900
11,0	12	204	156	142	45	11000	11000	11000
11,1	12	204	156	142	45	11100	11100	11100
11,2	12	204	156	142	45	11200	11200	11200
11,3	12	204	156	142	45	11300	11300	11300
11,4	12	204	156	142	45	11400	11400	11400
11,5	12	204	156	142	45	11500	11500	11500
P						●	●	
M						●		
K						●	●	
N						○		●
S						●		
H							○	
O								

→ v_c Page 118–124

Ø DC_{h7} for Type Speed VA and AL / Ø DC_{m7} for Type Quattro 4F

WTX – High Performance Drill, factory standard

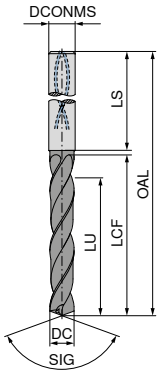
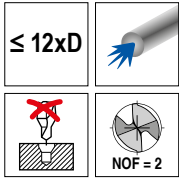

DC _{h7/m7} mm	DCONMS _{h6} mm	OAL mm	LCF mm	LU mm	LS mm	10 774 ... Solid carbide	10 737 ... Solid carbide	10 793 ... Solid carbide
11,6	12	204	156	142	45	11600	11600	
11,7	12	204	156	142	45	11700	11700	
11,8	12	204	156	142	45	11800	11800	
11,9	12	204	156	142	45	11900	11900	11800
12,0	12	204	156	142	45	12000	12000	12000
12,1	14	230	182	166	45			12100
12,2	14	230	182	166	45	12200		12200
12,5	14	230	182	166	45	12500	12500	12500
12,8	14	230	182	166	45	12800	12800	12800
13,0	14	230	182	166	45	13000	13000	13000
13,2	14	230	182	166	45			13200
13,5	14	230	182	166	45	13500	13500	13500
13,8	14	230	182	166	45	13800	13800	13800
14,0	14	230	182	166	45	14000	14000	14000
14,2	16	260	208	192	48	14200		14200
14,5	16	260	208	192	48	14500	14500	14500
14,7	16	260	208	192	48			14700
14,8	16	260	208	192	48		14800	14800
15,0	16	260	208	192	48	15000	15000	15000
15,1	16	260	208	192	48	15100		
15,2	16	260	208	192	48	15200		15200
15,5	16	260	208	192	48	15500	15500	15500
15,7	16	260	208	192	48			15700
15,8	16	260	208	192	48	15800	15800	15800
16,0	16	260	208	192	48	16000	16000	16000
16,2	18	285	234	216	48			16200
16,5	18	285	234	216	48		16500	16500
16,8	18	285	234	216	48		16800	16800
17,0	18	285	234	216	48	17000	17000	17000
17,2	18	285	234	216	48			17200
17,5	18	285	234	216	48	17500	17500	17500
17,8	18	285	234	216	48		17800	17800
18,0	18	285	234	216	48		18000	18000
18,2	20	310	258	240	50			18200
18,5	20	310	258	240	50			18500
18,7	20	310	258	240	50			18700
18,8	20	310	258	240	50			18800
19,0	20	310	258	240	50			19000
19,2	20	310	258	240	50			19200
19,5	20	310	258	240	50			19500
19,8	20	310	258	240	50			19800
20,0	20	310	258	240	50			20000

P	●	●	
M	●		
K	●	●	
N	○		●
S	●		
H		○	
O			

→ v_c Page 118-124

Ø DC_{h7} for Type Speed VA and AL / Ø DC_{m7} for Type Quattro 4F

High Performance Drill, factory standard

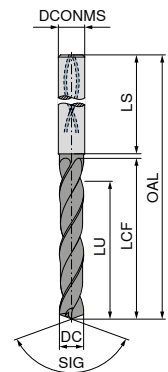
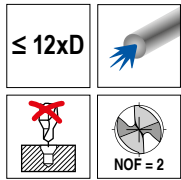

UNI
TiAlN



SIG 135°
Solid carbide

11 705 ...

DC _{h7} mm	DCONMS _{h6} mm	OAL mm	LCF mm	LU mm	LS mm	
3,0	6	92	54	49,5	36	03000
3,1	6	92	54	49,3	36	03100
3,2	6	92	54	49,2	36	03200
3,3	6	92	54	49,0	36	03300
3,4	6	92	54	48,9	36	03400
3,5	6	92	54	48,7	36	03500
3,6	6	92	54	48,6	36	03600
3,7	6	92	54	48,4	36	03700
3,8	6	102	64	58,3	36	03800
3,9	6	102	64	58,1	36	03900
4,0	6	102	64	58,0	36	04000
4,1	6	102	64	57,8	36	04100
4,2	6	102	64	57,7	36	04200
4,3	6	102	64	57,5	36	04300
4,4	6	102	64	57,4	36	04400
4,5	6	102	64	57,2	36	04500
4,6	6	102	64	57,1	36	04600
4,7	6	102	64	56,9	36	04700
4,8	6	116	78	70,8	36	04800
4,9	6	116	78	70,6	36	04900
5,0	6	116	78	70,5	36	05000
5,1	6	116	78	70,3	36	05100
5,2	6	116	78	70,2	36	05200
5,3	6	116	78	70,0	36	05300
5,4	6	116	78	69,9	36	05400
5,5	6	116	78	69,7	36	05500
5,6	6	116	78	69,6	36	05600
5,7	6	116	78	69,4	36	05700
5,8	6	116	78	69,3	36	05800
5,9	6	116	78	69,1	36	05900
6,0	6	116	78	69,0	36	06000
6,1	8	146	108	98,8	36	06100
6,2	8	146	108	98,7	36	06200
6,3	8	146	108	98,5	36	06300
6,4	8	146	108	98,4	36	06400
6,5	8	146	108	98,2	36	06500
6,6	8	146	108	98,1	36	06600
6,7	8	146	108	97,9	36	06700
6,8	8	146	108	97,8	36	06800
6,9	8	146	108	97,6	36	06900
7,0	8	146	108	97,5	36	07000
7,1	8	146	108	97,3	36	07100
7,2	8	146	108	97,2	36	07200
7,3	8	146	108	97,0	36	07300
7,4	8	146	108	96,9	36	07400
7,5	8	146	108	96,7	36	07500

11 705 ...

DC _{h7} mm	DCONMS _{h6} mm	OAL mm	LCF mm	LU mm	LS mm	
7,6	8	146	108	96,6	36	07600
7,7	8	146	108	96,4	36	07700
7,8	8	146	108	96,3	36	07800
7,9	8	146	108	96,1	36	07900
8,0	8	146	108	96,0	36	08000
8,1	10	162	120	107,8	40	08100
8,2	10	162	120	107,7	40	08200
8,3	10	162	120	107,5	40	08300
8,4	10	162	120	107,4	40	08400
8,5	10	162	120	107,2	40	08500
8,6	10	162	120	107,1	40	08600
8,7	10	162	120	106,9	40	08700
8,8	10	162	120	106,8	40	08800
8,9	10	162	120	106,6	40	08900
9,0	10	162	120	106,5	40	09000
9,1	10	162	120	106,3	40	09100
9,2	10	162	120	106,2	40	09200
9,3	10	162	120	106,0	40	09300
9,4	10	162	120	105,9	40	09400
9,5	10	162	120	105,7	40	09500
9,6	10	162	120	105,6	40	09600
9,7	10	162	120	105,4	40	09700
9,8	10	162	120	105,3	40	09800
9,9	10	162	120	105,1	40	09900
10,0	10	162	120	105,0	40	10000
10,2	12	204	156	140,7	45	10200
10,5	12	204	156	140,2	45	10500
10,8	12	204	156	139,8	45	10800
11,0	12	204	156	139,5	45	11000
11,5	12	204	156	138,7	45	11500
11,8	12	204	156	138,3	45	11800
12,0	12	204	156	138,0	45	12000
12,5	14	230	182	163,2	45	12500
12,7	14	230	182	162,9	45	12700
12,8	14	230	182	162,8	45	12800
13,0	14	230	182	162,5	45	13000
13,5	14	230	182	161,7	45	13500
13,8	14	230	182	161,3	45	13800
14,0	14	230	182	161,0	45	14000
14,5	16	260	208	186,2	48	14500
14,8	16	260	208	185,8	48	14800
15,0	16	260	208	185,5	48	15000
15,5	16	260	208	184,7	48	15500
15,8	16	260	208	184,3	48	15800
16,0	16	260	208	184,0	48	16000
16,5	18	285	234	209,2	48	16500
17,0	18	285	234	208,5	48	17000
17,5	18	285	234	207,7	48	17500
18,0	18	285	234	207,0	48	18000
18,5	20	310	258	230,2	50	18500
19,0	20	310	258	229,5	50	19000
19,5	20	310	258	228,7	50	19500
20,0	20	310	258	228,0	50	20000

P	●
M	●
K	●
N	
S	
H	
O	

→ v_c Page 131

WTX – High Feed Drill, factory standard

- ▲ Three fluted high-feed drill
- ▲ Universal application

- ▲ High positioning accuracy
- ▲ Suitable for difficult drilling applications

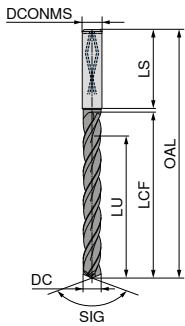
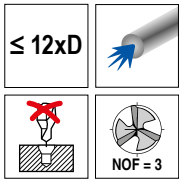

Feed UNI
DPX74S
DRAGONSKIN



SIG 135°
Solid carbide
10 796 ...

DC _{m7} mm	DCONMS _{h6} mm	OAL mm	LCF mm	LU mm	LS mm	
4,0	6	102	64	58	36	04000
4,1	6	102	64	58	36	04100
4,2	6	102	64	58	36	04200
4,3	6	102	64	58	36	04300
4,4	6	102	64	58	36	04400
4,5	6	102	64	58	36	04500
4,6	6	102	64	58	36	04600
4,7	6	102	64	58	36	04700
4,8	6	116	78	70	36	04800
4,9	6	116	78	70	36	04900
5,0	6	116	78	70	36	05000
5,1	6	116	78	70	36	05100
5,2	6	116	78	70	36	05200
5,3	6	116	78	70	36	05300
5,4	6	116	78	70	36	05400
5,5	6	116	78	70	36	05500
5,6	6	116	78	70	36	05600
5,7	6	116	78	70	36	05700
5,8	6	116	78	70	36	05800
5,9	6	116	78	70	36	05900
6,0	6	116	78	70	36	06000
6,1	8	146	108	94	36	06100
6,2	8	146	108	94	36	06200
6,3	8	146	108	94	36	06300
6,4	8	146	108	94	36	06400
6,5	8	146	108	94	36	06500
6,6	8	146	108	94	36	06600
6,7	8	146	108	94	36	06700
6,8	8	146	108	94	36	06800
6,9	8	146	108	94	36	06900
7,0	8	146	108	94	36	07000
7,1	8	146	108	94	36	07100
7,2	8	146	108	94	36	07200
7,3	8	146	108	94	36	07300
7,4	8	146	108	94	36	07400
7,5	8	146	108	94	36	07500
7,6	8	146	108	94	36	07600
7,7	8	146	108	94	36	07700
7,8	8	146	108	94	36	07800
7,9	8	146	108	94	36	07900
8,0	8	146	108	94	36	08000
8,1	10	162	120	110	40	08100
8,2	10	162	120	110	40	08200
8,3	10	162	120	110	40	08300
8,4	10	162	120	110	40	08400
8,5	10	162	120	110	40	08500
8,6	10	162	120	110	40	08600
8,7	10	162	120	110	40	08700
8,8	10	162	120	110	40	08800
8,9	10	162	120	110	40	08900
9,0	10	162	120	110	40	09000
9,1	10	162	120	110	40	09100

10 796 ...

DC _{m7} mm	DCONMS _{h6} mm	OAL mm	LCF mm	LU mm	LS mm	
9,2	10	162	120	110	40	09200
9,3	10	162	120	110	40	09300
9,4	10	162	120	110	40	09400
9,5	10	162	120	110	40	09500
9,6	10	162	120	110	40	09600
9,7	10	162	120	110	40	09700
9,8	10	162	120	110	40	09800
9,9	10	162	120	110	40	09900
10,0	10	162	120	110	40	10000
10,1	12	204	156	142	45	10100
10,2	12	204	156	142	45	10200
10,3	12	204	156	142	45	10300
10,4	12	204	156	142	45	10400
10,5	12	204	156	142	45	10500
10,6	12	204	156	142	45	10600
10,7	12	204	156	142	45	10700
10,8	12	204	156	142	45	10800
10,9	12	204	156	142	45	10900
11,0	12	204	156	142	45	11000
11,1	12	204	156	142	45	11100
11,2	12	204	156	142	45	11200
11,3	12	204	156	142	45	11300
11,4	12	204	156	142	45	11400
11,5	12	204	156	142	45	11500
11,6	12	204	156	142	45	11600
11,7	12	204	156	142	45	11700
11,8	12	204	156	142	45	11800
11,9	12	204	156	142	45	11900
12,0	12	204	156	142	45	12000
12,2	14	230	182	166	45	12200
12,5	14	230	182	166	45	12500
12,8	14	230	182	166	45	12800
13,0	14	230	182	166	45	13000
13,5	14	230	182	166	45	13500
13,8	14	230	182	166	45	13800
14,0	14	230	182	166	45	14000
14,5	16	260	208	192	48	14500
14,8	16	260	208	192	48	14800
15,0	16	260	208	192	48	15000
15,5	16	260	208	192	48	15500
15,8	16	260	208	192	48	15800
16,0	16	260	208	192	48	16000
16,5	18	285	234	216	48	16500
16,8	18	285	234	216	48	16800
17,0	18	285	234	216	48	17000
17,5	18	285	234	216	48	17500
17,8	18	285	234	216	48	17800
18,0	18	285	234	216	48	18000
18,5	20	310	258	240	50	18500
18,8	20	310	258	240	50	18800
19,0	20	310	258	240	50	19000
19,5	20	310	258	240	50	19500
19,8	20	310	258	240	50	19800
20,0	20	310	258	240	50	20000

P	●
M	●
K	●
N	○
S	
H	
O	

→ v_c Page 117

WTX – Co-pilot deep hole twist drills

- ▲ Cutting tolerance j6 optimally coordinated as an intermediate tolerance between the pilot drill and deep hole twist drill
- ▲ For optimal guidance and reduction of the cutting time of the deep hole twist drill for hole depths > 30xD
- ▲ Pilot hole necessary
- ▲ up to 20xD without peck drilling
- ▲ Excellent alignment precision
- ▲ Reliable chip removal

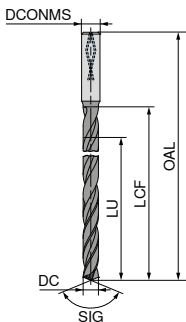
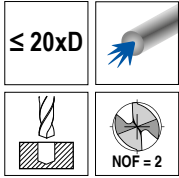

CP 20
UNI
TiAlN



SIG 137°
Solid carbide

11 018 ...

DC j6 mm	DCONMS _{HS} mm	OAL mm	LCF mm	LU mm	
3,0	6	120	80	60	03000
4,0	6	130	90	80	04000
4,2	6	160	110	84	04200
4,5	6	160	110	90	04500
4,8	6	160	120	96	04800
5,0	6	160	120	100	05000
5,5	6	185	140	110	05500
5,8	6	185	140	116	05800
6,0	6	185	140	120	06000
6,5	8	210	160	130	06500
6,8	8	210	160	136	06800
7,0	8	210	160	140	07000
7,5	8	230	180	150	07500
7,8	8	230	180	156	07800
8,0	8	230	180	160	08000
8,5	10	260	195	170	08500
8,8	10	290	230	176	08800
9,0	10	290	230	180	09000

P	●
M	●
K	●
N	●
S	○
H	○
O	○

Tolerances and angles

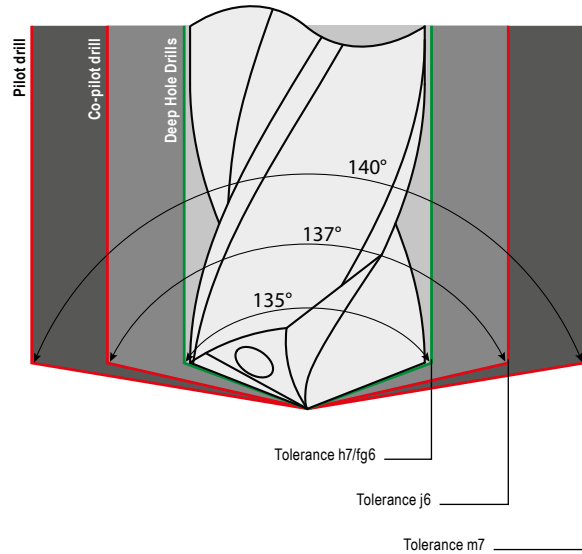

Tolerance table

ISO tolerances for shafts and holes

of Ø	3	6	10	18	
up to and including	6	10	18	30	
p6	20	24	29	35	
	12	15	18	22	
h7	0	0	0	0	Deep hole twist drill 16xD to 30xD
	-12	-15	-18	-21	
j6	6	7	8	9	Co-pilot drill
	-2	-2	-3	-4	
fg6	-6	-8			Deep hole twist drill > 30xD
	-14	-17			
m6	12	15	18	21	
	4	6	7	8	
m7	16	21	25	29	WTX UNI / WTX VA
	4	6	7	8	



Pilot drill for WTX deep hole twist drill:

- ▲ WTX-TB UNI: WTX-UNI 3xD / 5xD
- ▲ WTX-TB ALU: WTX-VA 3xD / 5xD

WTX – High performance deep hole drills

- ▲ up to 16xD without peck drilling
- ▲ pilot hole necessary
- ▲ excellent alignment precision
- ▲ secure chip evacuation

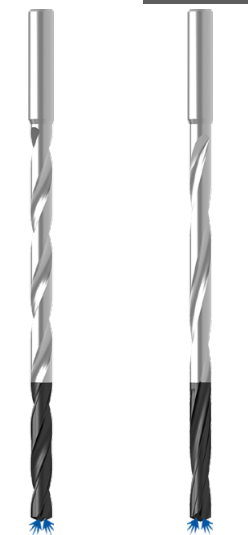
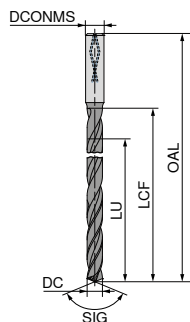
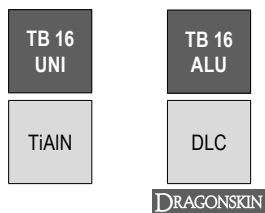
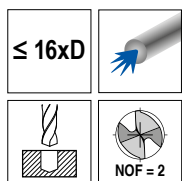

SIG 135°
Solid carbide

11 016 ... 11 017 ...

DC _{h7} mm	DCONMS _{h6} mm	OAL mm	LCF mm	LU mm
2,0	4	84	42	39
2,2	4	84	42	39
2,3	4	84	42	39
2,4	4	96	54	50
2,5	4	96	54	50
2,7	4	96	54	50
2,8	4	96	54	50
3,0	6	100	60	55
3,2	6	100	60	55
3,3	6	100	60	55
3,5	6	100	60	55
3,8	6	115	75	69
4,0	6	115	75	69
4,2	6	115	75	69
4,5	6	130	90	83
4,8	6	130	90	83
5,0	6	130	90	83
5,5	6	150	108	99
5,8	6	150	108	99
6,0	6	150	108	99
6,5	8	165	125	115
6,8	8	165	125	115
7,0	8	165	125	115
7,5	8	180	140	128
7,8	8	180	140	128
8,0	8	180	140	128
8,5	10	205	160	147
8,8	10	205	160	147
9,0	10	205	160	147
9,8	10	225	180	165
10,0	10	225	180	165
10,2	12	240	190	174
10,8	12	240	190	174
11,8	12	265	215	197
12,0	12	265	215	197

P	●
M	●
K	●
N	●
S	○
H	
O	

→ v_c Page 143+146
→ Machining information: Page 160

WTX – High performance deep hole drills

- ▲ up to 20xD without peck drilling
- ▲ pilot hole necessary
- ▲ excellent alignment precision
- ▲ secure chip evacuation

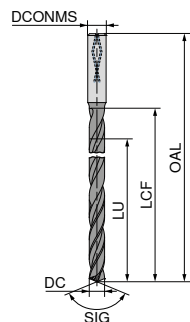
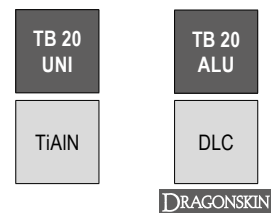
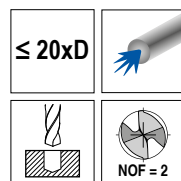

SIG 135°
Solid carbide

11 020 ... 11 021 ...

DC _{h7} mm	DCONMS _{h6} mm	OAL mm	LCF mm	LU mm
2,0	4	92	50	47
2,2	4	92	50	47
2,3	4	92	50	47
2,4	4	112	70	66
2,5	4	112	70	66
2,7	4	112	70	66
2,8	4	112	70	66
3,0	6	120	80	75
3,2	6	120	80	75
3,3	6	120	80	75
3,5	6	120	80	75
3,8	6	130	90	84
4,0	6	130	90	84
4,2	6	160	110	103
4,5	6	160	110	103
4,8	6	160	120	113
5,0	6	160	120	113
5,5	6	185	140	131
5,8	6	185	140	131
6,0	6	185	140	131
6,5	8	210	160	150
6,8	8	210	160	150
7,0	8	210	160	150
7,5	8	230	180	168
7,8	8	230	180	168
8,0	8	230	180	168
8,5	10	260	195	182
8,8	10	290	230	216
9,0	10	290	230	216
9,8	10	290	230	216
10,0	10	290	230	216
10,2	12	315	268	251
10,8	12	315	268	251
11,8	12	315	268	251
12,0	12	315	268	251

P	●
M	●
K	●
N	●
S	○
H	
O	

→ v_c Page 143+146
→ Machining information: Page 160

WTX – High performance deep hole drills

- ▲ up to 25xD without peck drilling
- ▲ pilot hole necessary
- ▲ excellent alignment precision
- ▲ secure chip evacuation

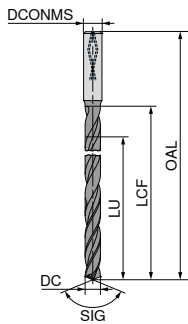
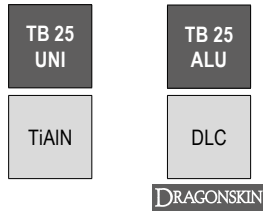
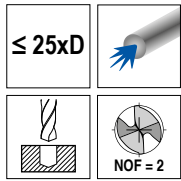

SIG 135°
Solid carbide

11 025 ... 11 026 ...

DC _{h7} mm	DCONMS _{h6} mm	OAL mm	LCF mm	LU mm
2,0	4	104	60	57
2,2	4	104	60	57
2,3	4	104	60	57
2,4	4	125	80	76
2,5	4	125	80	76
2,7	4	125	80	76
2,8	4	125	80	76
3,0	6	135	98	93
3,2	6	135	98	93
3,3	6	150	110	105
3,5	6	150	110	105
3,8	6	160	120	114
4,0	6	160	120	114
4,2	6	160	120	114
4,5	6	180	135	128
4,8	6	180	135	128
5,0	6	180	135	128
5,5	6	205	168	159
5,8	6	205	168	159
6,0	6	205	168	159
6,5	8	240	200	190
6,8	8	240	200	190
7,0	8	240	200	190
7,5	8	260	220	208
7,8	8	260	220	208
8,0	8	260	220	208
8,5	10	285	240	227
8,8	10	310	268	254
9,0	10	310	268	254
9,8	10	310	268	254
10,0	10	310	268	254
10,2	12	375	325	308
10,8	12	375	325	308
11,8	12	375	325	308
12,0	12	375	325	308

P	●
M	●
K	●
N	●
S	○
H	
O	

→ v_c Page 144+147
→ Machining information: Page 160

WTX – High performance deep hole drills

- ▲ up to 30xD without peck drilling
- ▲ pilot hole necessary
- ▲ excellent alignment precision
- ▲ secure chip evacuation

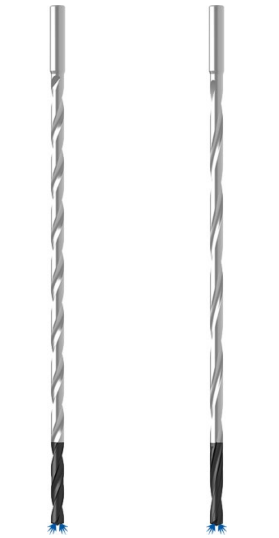
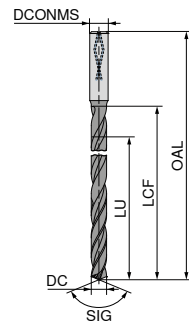
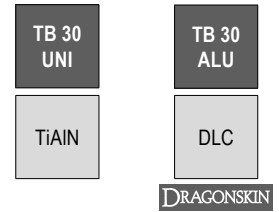
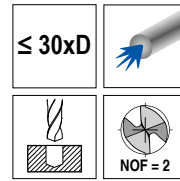

SIG 135°
Solid carbide

11 030 ... 11 031 ...

DC _{h7} mm	DCONMS _{h6} mm	OAL mm	LCF mm	LU mm
2,0	4	115	70	67
2,2	4	115	70	67
2,3	4	115	70	67
2,4	4	138	90	86
2,5	4	138	90	86
2,7	4	138	90	86
2,8	4	138	90	86
3,0	6	150	105	100
3,2	6	150	105	100
3,3	6	185	135	130
3,5	6	185	135	130
3,8	6	185	135	130
4,0	6	185	135	130
4,2	6	185	135	130
4,5	6	215	165	158
4,8	6	215	165	158
5,0	6	215	165	158
5,5	6	230	180	171
5,8	6	230	180	171
6,0	6	230	180	171
6,5	8	280	215	205
6,8	8	280	230	220
7,0	8	280	230	220
7,5	8	280	230	220
7,8	8	315	265	253
8,0	8	315	265	253
8,5	10	350	295	282
8,8	10	380	330	316
9,0	10	380	330	316
9,8	10	380	330	316
10,0	10	380	330	316
10,2	12	430	380	365
10,8	12	430	380	365
11,8	12	430	380	365
12,0	12	430	380	365

P	●
M	●
K	●
N	●
S	○
H	
O	

→ v_c Page 144+147
→ Machining information: Page 160

WTX – High performance deep hole drills

- ▲ up to 40xD without peck drilling
- ▲ pilot hole necessary
- ▲ excellent alignment precision
- ▲ secure chip evacuation

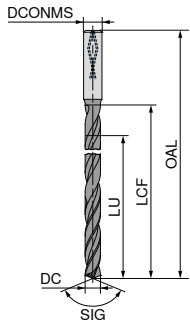
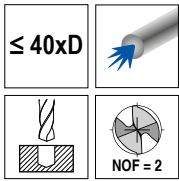

SIG 135°
Solid carbide

11 040 ...

DC _{fg6} mm	DCONMS _{h6} mm	OAL mm	LCF mm	LU mm	
3,0	6	195	150	146	030
4,0	6	220	175	169	040
4,2	6	245	200	194	042
4,5	6	245	200	194	045
4,8	6	275	230	223	048
5,0	6	275	230	223	050
5,5	6	305	260	251	055
5,8	6	305	260	251	058
6,0	6	305	260	251	060
6,5	8	345	300	290	065
6,8	8	345	300	290	068
7,0	8	345	300	290	070
7,5	8	385	340	328	075
7,8	8	385	340	328	078
8,0	8	385	340	328	080
8,5	10	430	380	367	085
8,8	10	430	380	367	088
9,0	10	430	380	367	090

P	●
M	●
K	●
N	●
S	○
H	
O	

→ v_c Page 145
→ Machining information: Page 160

WTX – High performance deep hole drills

- ▲ up to 50xD without peck drilling
- ▲ pilot hole necessary
- ▲ excellent alignment precision
- ▲ secure chip evacuation

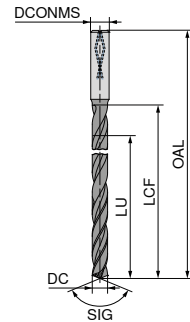
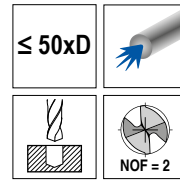

SIG 135°
Solid carbide

11 050 ...

DC _{fg6} mm	DCONMS _{h6} mm	OAL mm	LCF mm	LU mm	
3,0	6	220	175	170	030
4,0	6	265	220	214	040
4,2	6	290	245	238	042
4,5	6	290	245	238	045
4,8	6	320	275	268	048
5,0	6	320	275	268	050
5,5	6	355	310	302	055
5,8	6	355	315	306	058
6,0	6	355	315	306	060
6,5	8	395	350	340	065
6,8	8	425	380	370	068

P	●
M	●
K	●
N	●
S	○
H	
O	

→ v_c Page 145
→ Machining information: Page 160

The deep hole twist drills are also available in other dimensions on request.

WTX – High Performance Drills

▲ standard shank Ø 3 mm h6 for use
in heat shrink adapters

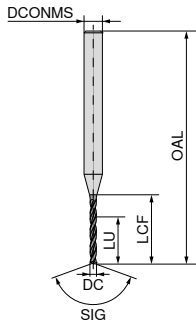
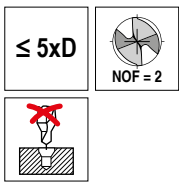

MINI
TiAIN

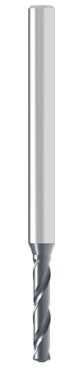

SIG 140°
Solid carbide

11 770 ...

DC ^{+0,004} mm	DCONMS _{h6} mm	OAL mm	LCF mm	LU mm	
0,10	3	38	1,2	1,0	00100
0,15	3	38	2,0	1,7	00150
0,20	3	38	3,5	3,0	00200
0,25	3	38	3,5	3,0	00250
0,30	3	38	5,5	5,0	00300
0,35	3	38	5,5	5,0	00350
0,40	3	38	7,0	6,0	00400
0,45	3	38	7,0	6,0	00450
0,50	3	38	7,0	6,0	00500
0,55	3	38	7,0	6,0	00550
0,60	3	38	7,0	6,0	00600
0,65	3	38	7,0	6,0	00650
0,70	3	38	10,5	8,0	00700
0,75	3	38	10,5	8,0	00750
0,80	3	38	10,5	8,0	00800
0,85	3	38	10,5	8,0	00850
0,90	3	38	10,5	8,0	00900
0,95	3	38	10,5	8,0	00950
0,97	3	38	10,5	8,0	00970
0,98	3	38	10,5	8,0	00980
0,99	3	38	10,5	8,0	00990
1,00	3	38	10,5	8,0	01000
1,01	3	38	10,5	8,0	01010
1,02	3	38	10,5	8,0	01020
1,03	3	38	10,5	8,0	01030
1,05	3	38	10,5	8,0	01050
1,10	3	38	10,5	8,0	01100
1,15	3	38	10,5	8,0	01150
1,20	3	38	10,5	8,0	01200
1,25	3	38	10,5	8,0	01250
1,30	3	38	10,5	8,0	01300
1,35	3	38	10,5	8,0	01350
1,40	3	38	10,5	8,0	01400
1,45	3	38	10,5	8,0	01450
1,47	3	38	10,5	8,0	01470
1,48	3	38	10,5	8,0	01480
1,49	3	38	10,5	8,0	01490
1,50	3	38	10,5	8,0	01500
1,51	3	38	10,5	8,0	01510
1,52	3	38	10,5	8,0	01520
1,53	3	38	10,5	8,0	01530
1,55	3	38	10,5	8,0	01550
1,60	3	38	10,5	8,0	01600
1,65	3	38	10,5	8,0	01650
1,70	3	38	10,5	8,0	01700
1,75	3	38	10,5	8,0	01750

11 770 ...

DC ^{+0,004} mm	DCONMS _{h6} mm	OAL mm	LCF mm	LU mm	
1,80	3	38	10,5	8,0	01800
1,85	3	38	12,0	8,0	01850
1,90	3	38	12,0	8,0	01900
1,95	3	38	12,0	8,0	01950
1,97	3	38	12,0	8,0	01970
1,98	3	38	12,0	8,0	01980
1,99	3	38	12,0	8,0	01990
2,00	3	42	13,0	9,0	02000
2,01	3	42	13,0	9,0	02010
2,02	3	42	13,0	9,0	02020
2,03	3	42	13,0	9,0	02030
2,05	3	42	13,0	9,0	02050
2,10	3	42	13,0	9,0	02100
2,15	3	42	13,0	9,0	02150
2,20	3	46	15,0	10,0	02200
2,25	3	46	15,0	10,0	02250
2,30	3	46	15,0	10,0	02300
2,35	3	46	15,0	10,0	02350
2,40	3	46	15,0	10,0	02400
2,45	3	46	15,0	10,0	02450
2,47	3	46	15,0	10,0	02470
2,48	3	46	15,0	10,0	02480
2,49	3	46	15,0	10,0	02490
2,50	3	46	15,0	10,0	02500
2,51	3	46	15,0	10,0	02510
2,52	3	46	15,0	10,0	02520
2,53	3	46	15,0	10,0	02530
2,60	3	46	15,0	10,0	02600
2,70	3	46	15,0	10,0	02700
2,80	3	46	15,0	10,0	02800
2,90	3	46	15,0	10,0	02900

P	○
M	
K	●
N	●
S	○
H	
O	

→ v. Page 136

WTX – High Performance Drills

- ▲ Specialised micro drill
- ▲ Universal application
- ▲ Extremely high process security
- ▲ Pilot drill for WTX Micro – high-performance deep hole drill

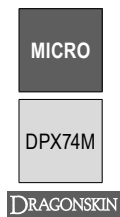
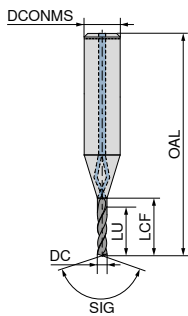
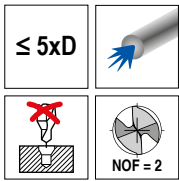

SIG 135°
Solid carbide

10 693 ...

DC _{ms} mm	DCONMS _{hs} mm	OAL mm	LCF mm	LU mm	
0,8	3	39	5,6	4,0	00800
0,9	3	39	6,3	4,5	00900
1,0	3	40	7,0	5,0	01000
1,1	3	41	7,7	5,5	01100
1,2	3	41	8,4	6,0	01200
1,3	3	42	9,1	6,5	01300
1,4	3	42	9,8	7,0	01400
1,5	3	43	10,5	7,5	01500
1,6	3	44	11,2	8,0	01600
1,7	3	44	11,9	8,5	01700
1,8	3	45	12,6	9,0	01800
1,9	3	45	13,3	9,5	01900
2,0	3	46	14,0	10,0	02000
2,1	3	47	14,7	10,5	02100
2,2	3	47	15,4	11,0	02200
2,3	3	48	16,1	11,5	02300
2,4	3	48	16,8	12,0	02400
2,5	3	49	17,5	12,5	02500
2,6	3	50	18,2	13,0	02600
2,7	3	50	18,9	13,5	02700
2,8	3	51	19,6	14,0	02800
2,9	3	51	20,3	14,5	02900

P	●
M	●
K	●
N	●
S	○
H	
O	

→ v_c Page 137
→ Machining information: Page 161

Minimum coolant pressure: 30 bar

WTX – High Performance Drills

- ▲ Specialised micro drill
- ▲ Universal application
- ▲ Extremely high process security

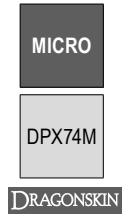
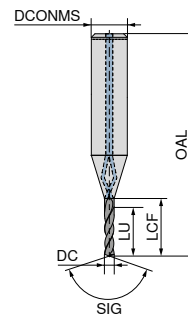
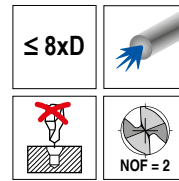

SIG 128°
Solid carbide

10 694 ...

DC _{hs} mm	DCONMS _{hs} mm	OAL mm	LCF mm	LU mm	
0,8	3	41	8	6,4	00800
0,9	3	42	9	7,2	00900
1,0	3	43	10	8,0	01000
1,1	3	44	11	8,8	01100
1,2	3	45	12	9,6	01200
1,3	3	46	13	10,4	01300
1,4	3	47	14	11,2	01400
1,5	3	47	15	12,0	01500
1,6	3	48	16	12,8	01600
1,7	3	49	17	13,6	01700
1,8	3	50	18	14,4	01800
1,9	3	51	19	15,2	01900
2,0	3	52	20	16,0	02000
2,1	3	53	21	16,8	02100
2,2	3	54	22	17,6	02200
2,3	3	55	23	18,4	02300
2,4	3	56	24	19,2	02400
2,5	3	56	25	20,0	02500
2,6	3	57	26	20,8	02600
2,7	3	58	27	21,6	02700
2,8	3	59	28	22,4	02800
2,9	3	60	29	23,2	02900

P	●
M	●
K	●
N	●
S	○
H	
O	

→ v_c Page 138
→ Machining information: Page 161

Minimum coolant pressure: 30 bar

WTX – High Performance Drills

- ▲ Specialised micro drill
- ▲ Universal application
- ▲ Extremely high process security
- ▲ Pilot drill: 5xD WTX Micro – high-performance drill

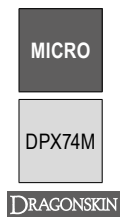
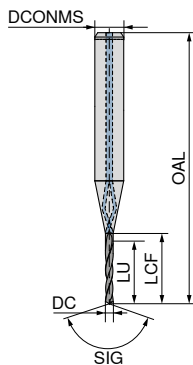
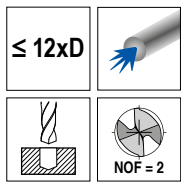

SIG 128°
Solid carbide

10 695 ...

DC _{h6} mm	DCONMS _{h6} mm	OAL mm	LCF mm	LU mm	
0,8	3	44	11,2	9,6	00800
0,9	3	46	12,6	10,8	00900
1,0	3	47	14,0	12,0	01000
1,1	3	48	15,4	13,2	01100
1,2	3	50	16,8	14,4	01200
1,3	3	51	18,2	15,6	01300
1,4	3	52	19,6	16,8	01400
1,5	3	53	21,0	18,0	01500
1,6	3	55	22,4	19,2	01600
1,7	3	56	23,8	20,4	01700
1,8	3	57	25,2	21,6	01800
1,9	3	59	26,6	22,8	01900
2,0	3	60	28,0	24,0	02000
2,1	3	61	29,4	25,2	02100
2,2	3	63	30,8	26,4	02200
2,3	3	64	32,2	27,6	02300
2,4	3	65	33,6	28,8	02400
2,5	3	67	35,0	30,0	02500
2,6	3	68	36,4	31,2	02600
2,7	3	69	37,8	32,4	02700
2,8	3	70	39,2	33,6	02800
2,9	3	72	40,6	34,8	02900

P	●
M	●
K	●
N	●
S	○
H	
O	

→ v_c Page 138
→ Machining information: Page 161

WTX – High performance deep hole drills

- ▲ Specialised micro deep hole drill
- ▲ Universal application
- ▲ Extremely high process security
- ▲ Pilot drill: 5xD WTX Micro – high-performance drill

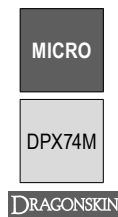
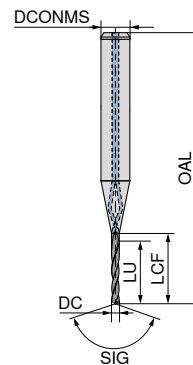
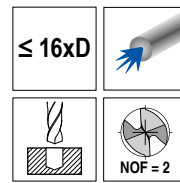

SIG 128°
Solid carbide

10 696 ...

DC _{h6} mm	DCONMS _{h6} mm	OAL mm	LCF mm	LU mm	
0,8	3	48	14,4	12,8	00800
0,9	3	49	16,2	14,4	00900
1,0	3	51	18,0	16,0	01000
1,1	3	53	19,8	17,6	01100
1,2	3	54	21,6	19,2	01200
1,3	3	56	23,4	20,8	01300
1,4	3	58	25,2	22,4	01400
1,5	3	60	27,0	24,0	01500
1,6	3	61	28,8	25,6	01600
1,7	3	63	30,6	27,2	01700
1,8	3	65	32,4	28,8	01800
1,9	3	66	34,2	30,4	01900
2,0	3	68	36,0	32,0	02000
2,1	3	70	37,8	33,6	02100
2,2	3	71	39,6	35,2	02200
2,3	3	73	41,4	36,8	02300
2,4	3	75	43,2	38,4	02400
2,5	3	77	45,0	40,0	02500
2,6	3	78	46,8	41,6	02600
2,7	3	80	48,6	43,2	02700
2,8	3	82	50,4	44,8	02800
2,9	3	83	52,2	46,4	02900

P	●
M	●
K	●
N	●
S	○
H	
O	

→ v_c Page 139
→ Machining information: Page 161

Minimum coolant pressure: 30 bar

Minimum coolant pressure: 30 bar

WTX – High performance deep hole drills

- ▲ Specialised micro deep hole drill
- ▲ Universal application
- ▲ Extremely high process security
- ▲ Pilot drill: 5xD WTX Micro – high-performance drill

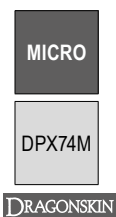
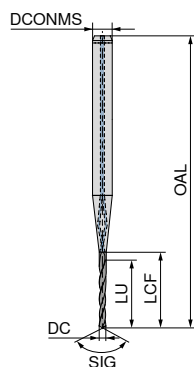
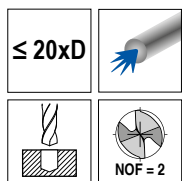

SIG 128°
Solid carbide

10 697 ...

DC _{h6} mm	DCONMS _{h6} mm	OAL mm	LCF mm	LU mm	
0,8	3	51	17,6	16	00800
0,9	3	53	19,8	18	00900
1,0	3	55	22,0	20	01000
1,1	3	57	24,2	22	01100
1,2	3	59	26,4	24	01200
1,3	3	61	28,6	26	01300
1,4	3	63	30,8	28	01400
1,5	3	66	33,0	30	01500
1,6	3	68	35,2	32	01600
1,7	3	70	37,4	34	01700
1,8	3	72	39,6	36	01800
1,9	3	74	41,8	38	01900
2,0	3	76	44,0	40	02000
2,1	3	78	46,2	42	02100
2,2	3	80	48,4	44	02200
2,3	3	82	50,6	46	02300
2,4	3	85	52,8	48	02400
2,5	3	87	55,0	50	02500
2,6	3	89	57,2	52	02600
2,7	3	91	59,4	54	02700
2,8	3	93	61,6	56	02800
2,9	3	95	63,8	58	02900

P	●
M	●
K	●
N	
S	
H	
O	

→ v_c Page 139
→ Machining information: Page 161

Minimum coolant pressure: 30 bar

WTX – High performance deep hole drills

- ▲ Specialised micro deep hole drill
- ▲ Universal application
- ▲ Extremely high process security
- ▲ Pilot drill: 5xD WTX Micro – high-performance drill

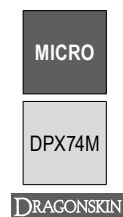
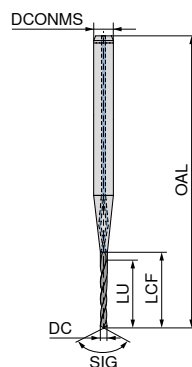
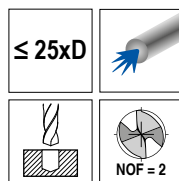

SIG 128°
Solid carbide

10 698 ...

DC _{h6} mm	DCONMS _{h6} mm	OAL mm	LCF mm	LU mm	
0,8	3	54	21,6	16,0	00800
0,9	3	57	24,3	20,5	00900
1,0	3	60	27,0	25,0	01000
1,1	3	63	29,7	27,5	01100
1,2	3	65	32,4	30,0	01200
1,3	3	68	35,1	32,5	01300
1,4	3	71	37,8	35,0	01400
1,5	3	73	40,5	37,5	01500
1,6	3	76	43,2	40,0	01600
1,7	3	78	45,9	42,5	01700
1,8	3	81	48,6	45,0	01800
1,9	3	84	51,3	47,5	01900
2,0	3	86	54,0	50,0	02000
2,1	3	89	56,7	52,5	02100
2,2	3	91	59,4	55,0	02200
2,3	3	94	62,1	57,5	02300
2,4	3	97	64,8	60,0	02400
2,5	3	99	67,5	62,5	02500
2,6	3	102	70,2	65,0	02600
2,7	3	104	72,9	67,5	02700
2,8	3	107	75,6	70,0	02800
2,9	3	110	78,3	72,5	02900

P	●
M	●
K	●
N	
S	
H	
O	

→ v_c Page 139
→ Machining information: Page 161

Minimum coolant pressure: 30 bar

WTX – High performance deep hole drills

- ▲ Specialised micro deep hole drill
- ▲ Universal application
- ▲ Extremely high process security
- ▲ Pilot drill: 5xD WTX Micro – high-performance drill

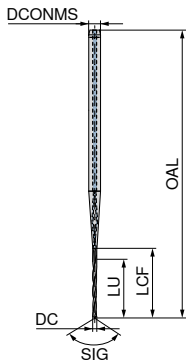
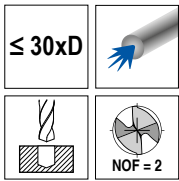

Tolerances and angles

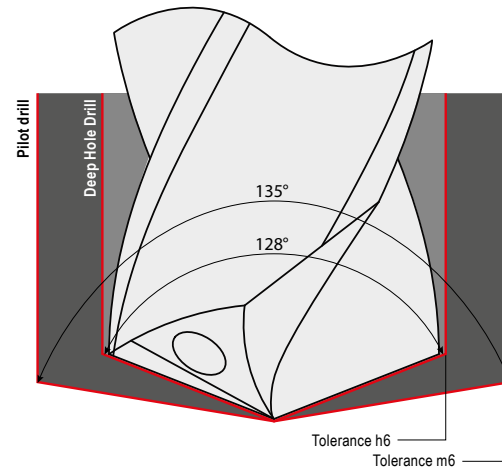

DC _{h6} mm	DCONMS _{h6} mm	OAL mm	LCF mm	LU mm	
0,8	3	59	25,6	19,2	00800
0,9	3	62	28,8	24,5	00900
1,0	3	65	32,0	30,0	01000
1,1	3	68	35,2	33,0	01100
1,2	3	71	38,4	36,0	01200
1,3	3	74	41,6	39,0	01300
1,4	3	78	44,8	42,0	01400
1,5	3	81	48,0	45,0	01500
1,6	3	84	51,2	48,0	01600
1,7	3	87	54,4	51,0	01700
1,8	3	90	57,6	54,0	01800
1,9	3	93	60,8	57,0	01900
2,0	3	96	64,0	60,0	02000
2,1	3	99	67,2	63,0	02100
2,2	3	102	70,4	66,0	02200
2,3	3	106	73,6	69,0	02300
2,4	3	109	76,8	72,0	02400
2,5	3	112	80,0	75,0	02500
2,6	3	115	83,2	78,0	02600
2,7	3	118	86,4	81,0	02700
2,8	3	121	89,6	84,0	02800
2,9	3	124	92,8	87,0	02900

P	●
M	●
K	●
N	
S	
H	
O	

→ v_c Page 139

→ Machining information: Page 161

Coolant transfer pipe with strainer HSK-A 63 / HSK-A 100



With the help of the new coolant transfer pipe, it is possible to filter very small chips and impurities out of the coolant. More information on this can be found in the
→ **Catalogue Clamping Technology, chapter 16, page 156.**

Minimum coolant pressure: 30 bar

WTX – Drill-Reamer 1/100

- ▲ Solid carbide high-performance drill-reaming tool
- ▲ Drilling and reaming in one operation
- ▲ 3 drilling edges
- ▲ 6 reaming edges
- ▲ High feeds
- ▲ Good surface quality
- ▲ For blind holes and through holes

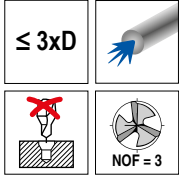

Feed
BR100

DPX14S

DRAGONSKIN

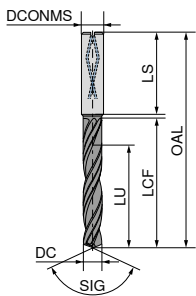

SIG 140°

Solid carbide

10 707 ...

DC $\pm 0,003$	DCONMS h_6	OAL	LCF	LU	LS	
mm	mm	mm	mm	mm	mm	
3,97	6	66	24	17	36	03970
3,98	6	66	24	17	36	03980
3,99	6	66	24	17	36	03990
4,00	6	66	24	17	36	04000
4,01	6	66	24	17	36	04010
4,02	6	66	24	17	36	04020
4,97	6	66	28	20	36	04970
4,98	6	66	28	20	36	04980
4,99	6	66	28	20	36	04990
5,00	6	66	28	20	36	05000
5,01	6	66	28	20	36	05010
5,02	6	66	28	20	36	05020
5,97	6	66	28	20	36	05970
5,98	6	66	28	20	36	05980
5,99	6	66	28	20	36	05990
6,00	6	66	28	20	36	06000
6,01	6	66	28	20	36	06010
6,02	6	66	28	20	36	06020
7,97	8	79	41	29	36	07970
7,98	8	79	41	29	36	07980
7,99	8	79	41	29	36	07990
8,00	8	79	41	29	36	08000
8,01	8	79	41	29	36	08010
8,02	8	79	41	29	36	08020
9,97	10	89	47	35	40	09970
9,98	10	89	47	35	40	09980
9,99	10	89	47	35	40	09990
10,00	10	89	47	35	40	10000
10,01	10	89	47	35	40	10010
10,02	10	89	47	35	40	10020
11,97	12	102	55	40	45	11970
11,98	12	102	55	40	45	11980
11,99	12	102	55	40	45	11990
12,00	12	102	55	40	45	12000
12,01	12	102	55	40	45	12010
12,02	12	102	55	40	45	12020

P	●
M	●
K	●
N	●
S	●
H	●
O	●

		Tolerances					
		e.g. Ø 8 F7 = 8.02 mm					
Ø 4	3,97	U 7	X 7				
	3,98	N 10	N 11	R 7			
	3,99	M 8	N 7	N 8	N 9		
	4,00	J 7	J 8	JS 7	JS 8	JS 9	
	4,01	G 7	H 8				
	4,02	F 8	H 9				
Ø 5	4,97	U 7	X 7				
	4,98	N 10	N 11	R 7			
	4,99	M 8	N 7	N 8	N 9		
	5,00	J 7	J 8	JS 7	JS 8	JS 9	
	5,01	G 7	H 8				
	5,02	F 8	H 9				
Ø 6	5,97	U 7	X 7				
	5,98	N 10	N 11	R 7			
	5,99	M 8	N 7	N 8	N 9		
	6,00	J 7	J 8	JS 7	JS 8	JS 9	
	6,01	G 7	H 8				
	6,02	F 8	H 9				
Ø 8	7,97	S 7	U 7				
	7,98	N 8	N 10	N 11	P 7	R 7	
	7,99	K 8	M 6	M 7	M 8	N 9	
	8,00	J 7	J 8	JS 7	JS 8	JS 9	
	8,01	G 7	H 8				
	8,02	F 7	F 8	H 9			
Ø 10	9,97	S 7	U 7				
	9,98	N 8	N 10	N 11	P 7	R 7	
	9,99	K 8	M 6	M 7	M 8	N 9	
	10,00	J 7	J 8	JS 7	JS 8	JS 9	
	10,01	G 7	H 8				
	10,02	F 7	F 8	H 9			
Ø 12	11,97	N 11	R 7	S 7			
	11,98	N 8	N 9	N 10	P 7		
	11,99	K 8	M 6	M 7	M 8	N 7	
	12,00	J 7	J 8	JS 7	JS 8		
	12,01	G 6	H 7	H 8	JS 9		
	12,02	F 7					

Tolerance classes written in standard print are not optimally positioned in the tolerance field.

WTX – Drill-Reamer 1/100

- ▲ Solid carbide high-performance drill-reaming tool
- ▲ Drilling and reaming in one operation
- ▲ 3 drilling edges
- ▲ 6 reaming edges
- ▲ High feeds
- ▲ Good surface quality
- ▲ For blind holes and through holes

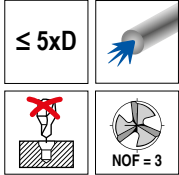

Feed
BR100

DPX14S

DRAGONSKIN

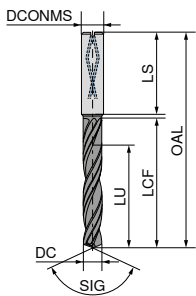

SIG 140°
Solid carbide

10 713 ...

DC _{±0,003}	DCONMS _{h6}	OAL	LCF	LU	LS	
mm	mm	mm	mm	mm	mm	
3,97	6	74	36	29	36	03970
3,98	6	74	36	29	36	03980
3,99	6	74	36	29	36	03990
4,00	6	74	36	29	36	04000
4,01	6	74	36	29	36	04010
4,02	6	74	36	29	36	04020
4,97	6	82	44	35	36	04970
4,98	6	82	44	35	36	04980
4,99	6	82	44	35	36	04990
5,00	6	82	44	35	36	05000
5,01	6	82	44	35	36	05010
5,02	6	82	44	35	36	05020
5,97	6	82	44	35	36	05970
5,98	6	82	44	35	36	05980
5,99	6	82	44	35	36	05990
6,00	6	82	44	35	36	06000
6,01	6	82	44	35	36	06010
6,02	6	82	44	35	36	06020
7,97	8	91	53	43	36	07970
7,98	8	91	53	43	36	07980
7,99	8	91	53	43	36	07990
8,00	8	91	53	43	36	08000
8,01	8	91	53	43	36	08010
8,02	8	91	53	43	36	08020
9,97	10	103	61	49	40	09970
9,98	10	103	61	49	40	09980
9,99	10	103	61	49	40	09990
10,00	10	103	61	49	40	10000
10,01	10	103	61	49	40	10010
10,02	10	103	61	49	40	10020
11,97	12	118	71	56	45	11970
11,98	12	118	71	56	45	11980
11,99	12	118	71	56	45	11990
12,00	12	118	71	56	45	12000
12,01	12	118	71	56	45	12010
12,02	12	118	71	56	45	12020

P	●
M	●
K	●
N	●
S	●
H	●
O	●

		Tolerances					
		e.g. Ø 8 F7 = 8.02 mm					
Ø 4	3,97	U 7	X 7				
	3,98	N 10	N 11	R 7			
	3,99	M 8	N 7	N 8	N 9		
	4,00	J 7	J 8	JS 7	JS 8	JS 9	
	4,01	G 7	H 8				
	4,02	F 8	H 9				
Ø 5	4,97	U 7	X 7				
	4,98	N 10	N 11	R 7			
	4,99	M 8	N 7	N 8	N 9		
	5,00	J 7	J 8	JS 7	JS 8	JS 9	
	5,01	G 7	H 8				
	5,02	F 8	H 9				
Ø 6	5,97	U 7	X 7				
	5,98	N 10	N 11	R 7			
	5,99	M 8	N 7	N 8	N 9		
	6,00	J 7	J 8	JS 7	JS 8	JS 9	
	6,01	G 7	H 8				
	6,02	F 8	H 9				
Ø 8	7,97	S 7	U 7				
	7,98	N 8	N 10	N 11	P 7	R 7	
	7,99	K 8	M 6	M 7	M 8	N 9	
	8,00	J 7	J 8	JS 7	JS 8	JS 9	
	8,01	G 7	H 8				
	8,02	F 7	F 8	H 9			
Ø 10	9,97	S 7	U 7				
	9,98	N 8	N 10	N 11	P 7	R 7	
	9,99	K 8	M 6	M 7	M 8	N 9	
	10,00	J 7	J 8	JS 7	JS 8	JS 9	
	10,01	G 7	H 8				
	10,02	F 7	F 8	H 9			
Ø 12	11,97	N 11	R 7	S 7			
	11,98	N 8	N 9	N 10	P 7		
	11,99	K 8	M 6	M 7	M 8	N 7	
	12,00	J 7	J 8	JS 7	JS 8		
	12,01	G 6	H 7	H 8	JS 9		
	12,02	F 7					

Tolerance classes written in standard print are not optimally positioned in the tolerance field.

WTX – Drill-Reamer H7

- ▲ Solid carbide high-performance drill-reaming tool
- ▲ Drilling and reaming to tolerance H7 in one operation
- ▲ 3 drilling edges
- ▲ 6 reaming edges
- ▲ High feeds
- ▲ Good surface quality
- ▲ For blind holes and through holes
- ▲ Optimum roundness – tolerance H7

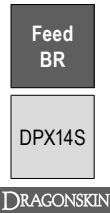
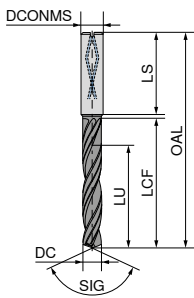
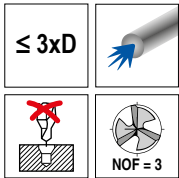

SIG 140°
Solid carbide

10 711 ...

DC _{H7} mm	DCONMS _{h6} mm	OAL mm	LCF mm	LU mm	LS mm	
4	6	66	24	17	36	04000
5	6	66	28	20	36	05000
6	6	66	28	20	36	06000
8	8	79	41	29	36	08000
10	10	89	47	35	40	10000
12	12	102	55	40	45	12000
14	14	107	60	43	45	14000
16	16	115	65	45	48	16000

P	●
M	●
K	●
N	
S	
H	
O	

→ v_c Page 140

Special dimensions available upon request

WTX – Drill-Reamer H7

- ▲ Solid carbide high-performance drill-reaming tool
- ▲ Drilling and reaming to tolerance H7 in one operation
- ▲ 3 drilling edges
- ▲ 6 reaming edges
- ▲ High feeds
- ▲ Good surface quality
- ▲ For blind holes and through holes
- ▲ Optimum roundness – tolerance H7

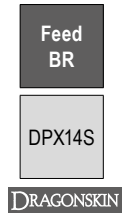
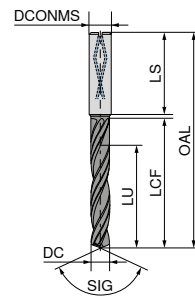
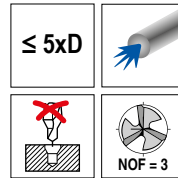

SIG 140°
Solid carbide

10 719 ...

DC _{H7} mm	DCONMS _{h6} mm	OAL mm	LCF mm	LU mm	LS mm	
4	6	74	36	29	36	04000
5	6	82	44	35	36	05000
6	6	82	44	35	36	06000
8	8	91	53	43	36	08000
10	10	103	61	49	40	10000
12	12	118	71	56	45	12000
14	14	124	77	60	45	14000
16	16	133	83	63	48	16000
18	18	143	93	71	48	18000
20	20	153	101	77	50	20000

P	●
M	●
K	●
N	
S	
H	
O	

→ v_c Page 141

Special dimensions available upon request

WTX – Short 90° step drill

▲ for core hole plus countersink for thread cutting

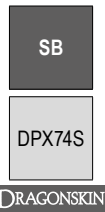
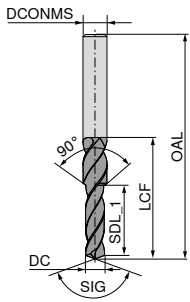
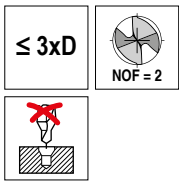

SIG 140°

Solid carbide

10 767 ...

For threads	DC _{m7} mm	DCONMS _{h6} mm	OAL mm	SDL_1 mm	LCF mm	
M3	2,5	6	62	8,8	20	02500
M4	3,3	6	62	11,4	24	03300
M5	4,2	6	66	13,6	28	04200
M6	5,0	8	79	16,5	34	05000
M8	6,8	10	89	21,0	47	06800
M10	8,5	12	102	25,5	55	08500
M12	10,2	14	107	30,0	60	10200
M14	12,0	16	115	34,5	65	12000
M16	14,0	18	123	38,5	73	14000

P	●
M	
K	●
N	
S	
H	○
O	

→ v_c Page 135

WTX – Short 90° step drill

▲ for core hole plus countersink for thread forming

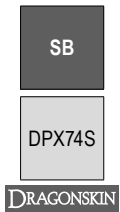
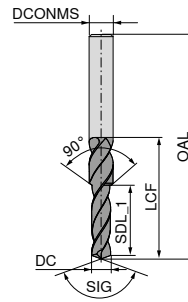
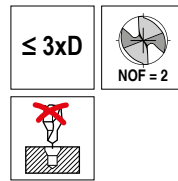

SIG 140°

Solid carbide

10 772 ...

For threads	DC _{m7} mm	DCONMS _{h6} mm	OAL mm	SDL_1 mm	LCF mm	
M3	2,80	6	62	8,8	20	02800
M4	3,70	6	62	11,4	24	03700
M5	4,65	6	66	13,6	28	04650
M6	5,55	8	79	16,5	34	05550
M8	7,45	10	89	21,0	47	07450
M10	9,30	12	102	25,5	55	09300
M12	11,20	14	107	30,0	60	11200
M14	13,00	16	115	34,5	65	13000
M16	15,00	18	123	38,5	73	15000

P	●
M	
K	●
N	
S	
H	○
O	

→ v_c Page 135

WTX – Short 90° step drill

▲ for core hole plus countersink for thread cutting

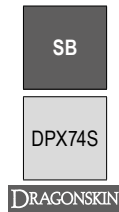
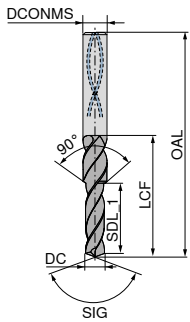
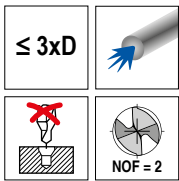

SIG 140°
Solid carbide

10 783 ...

For threads	DC _{m7} mm	DCONMS _{h6} mm	OAL mm	SDL_1 mm	LCF mm	
M4	3,3	6	62	11,4	24	03300
M5	4,2	6	66	13,6	28	04200
M6	5,0	8	79	16,5	34	05000
M8	6,8	10	89	21,0	47	06800
M10	8,5	12	102	25,5	55	08500
M12	10,2	14	107	30,0	60	10200
M14	12,0	16	115	34,5	65	12000
M16	14,0	18	123	38,5	73	14000

P	●
M	
K	●
N	
S	
H	○
O	

→ v_c Page 135

WTX – Short 90° step drill

▲ for core hole plus countersink for thread forming

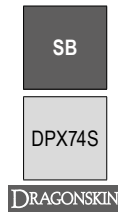
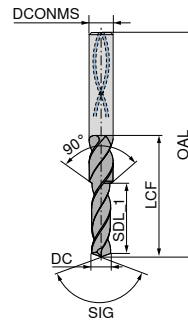
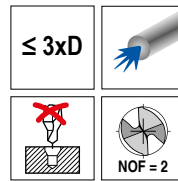

SIG 140°
Solid carbide

10 788 ...

For threads	DC _{m7} mm	DCONMS _{h6} mm	OAL mm	SDL_1 mm	LCF mm	
M4	3,70	6	62	11,4	24	03700
M5	4,65	6	66	13,6	28	04650
M6	5,55	8	79	16,5	34	05550
M8	7,45	10	89	21,0	47	07450
M10	9,30	12	102	25,5	55	09300
M12	11,20	14	107	30,0	60	11200
M14	13,00	16	115	34,5	65	13000
M16	15,00	18	123	38,5	73	15000

P	●
M	
K	●
N	
S	
H	○
O	

→ v_c Page 135

NC Spot Drill, factory standard

▲ spiral flute

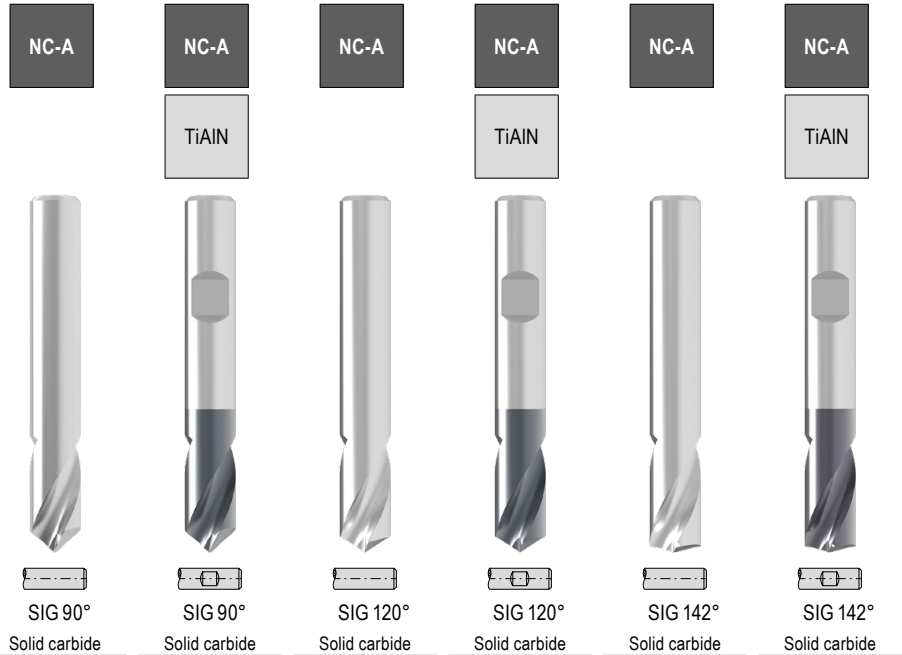
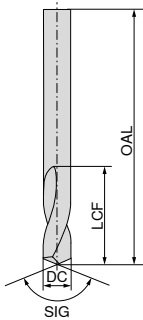

DC _{js8} mm	OAL mm	LCF mm	10 702 ...	10 716 ...	10 703 ...	10 717 ...	10 704 ...	10 718 ...
2	32	6	002	002 ¹⁾	002	002 ¹⁾	002	002 ¹⁾
3	32	8	003	003 ¹⁾	003	003 ¹⁾	003	003 ¹⁾
4	40	10	004	004 ¹⁾	004	004 ¹⁾	004	004 ¹⁾
5	50	13	005	005 ¹⁾	005	005 ¹⁾	005	005 ¹⁾
6	50	13	006	006	006	006	006	006
8	60	23	008	008	008	008	008	008
10	70	24	010	010	010	010	010	010
12	70	24	012	012	012	012	012	012
14	75	26	014	014	014	014	014	014
16	75	29	016	016	016	016	016	016
18	100	35	018	018	018	018	018	018
20	100	35	020	020	020	020	020	020
P			●	●	●	●	●	●
M								
K			●	●	●	●	●	●
N			●	●	●	●	●	●
S								
H				○		○		○
O								

1) DIN 6535 HA Shank

NC Spot Drill, factory standard, long

▲ spiral flutes

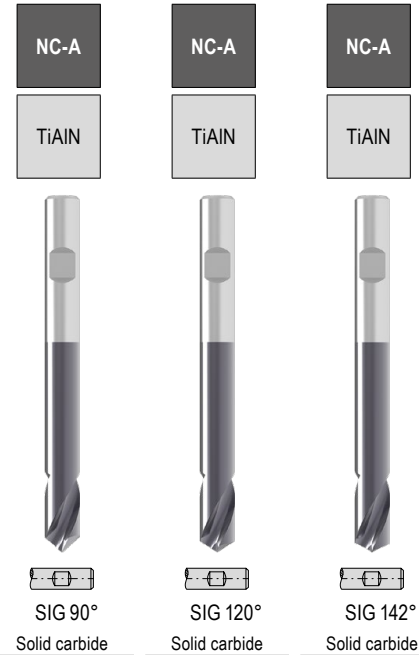
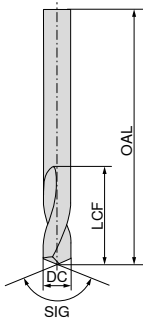

DC _{js8} mm	OAL mm	LCF mm
3	66	8
4	74	10
6	82	13
8	91	23
10	103	24
12	118	24
16	133	29

10 724 ...	10 726 ...	10 727 ...
003 ¹⁾	003 ¹⁾	003 ¹⁾
004 ¹⁾	004 ¹⁾	004 ¹⁾
006	006	006
008	008	008
010	010	010
012	012	012
016	016	016

P	●	●	●
M	●	●	●
K	●	●	●
N	●	●	●
S	●	●	●
H	○	○	○
O			

1) DIN 6535 HA Shank

Centre drills, DIN 333, form A

- ▲ Spiral-fluted
- ▲ Up to and including diameter DC of 0.8 mm suitable for use on one side only

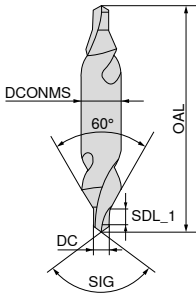

SIG 120°
Solid carbide

10 708 ...

DC _{k13} mm	DCONMS _{h6} mm	OAL mm	SDL_1 mm	
0,50	3,15	20,0	0,76	050 ¹⁾
0,80	3,15	20,0	1,07	080 ¹⁾
1,00	3,15	31,5	1,31	100
1,25	3,15	31,5	1,54	125
1,60	4,00	35,5	1,94	160
2,00	5,00	40,0	2,32	200
2,50	6,30	45,0	2,88	250
3,15	8,00	50,0	3,49	315
4,00	10,00	56,0	4,45	400
5,00	12,50	63,0	5,46	500
6,30	16,00	71,0	6,78	630

P	●
M	
K	●
N	●
S	
H	
O	

1) Single ended

WTX – Drilling Head for Exchangeable drills

- ▲ extra long head type
- ▲ three-edged

Scope of supply:

Drill head incl. differential screw

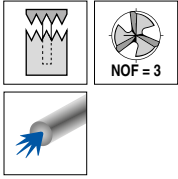

Change Feed UNI
Ti750

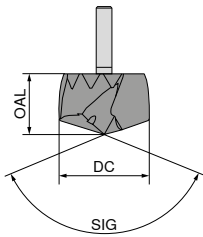

SIG 140°
Solid carbide

DC _{m7} mm	OAL mm	10 925 ...
14,0	13,5	140
14,1	13,5	141
14,2	13,5	142
14,3	13,5	143
14,4	13,5	144
14,5	14,0	145
14,6	14,0	146
14,7	14,0	147
14,8	14,0	148
14,9	14,0	149
15,0	14,4	150
15,1	14,4	151
15,2	14,4	152
15,3	14,4	153
15,4	14,4	154
15,5	15,4	155
15,6	15,4	156
15,7	15,4	157
15,8	15,4	158
15,9	15,4	159
16,0	15,4	160
16,1	15,4	161
16,2	15,4	162
16,3	15,4	163
16,4	15,4	164
16,5	16,3	165
16,6	16,3	166
16,7	16,3	167
16,8	16,3	168
16,9	16,3	169
17,0	16,3	170
17,1	16,3	171
17,2	16,3	172
17,3	16,3	173
17,4	16,3	174
17,5	17,2	175
17,6	17,2	176
17,7	17,2	177
17,8	17,2	178
17,9	17,2	179
18,0	17,2	180
18,1	17,2	181
18,2	17,2	182
18,3	17,2	183
18,4	17,2	184
18,5	18,2	185
18,6	18,2	186
18,7	18,2	187
18,8	18,2	188
18,9	18,2	189

DC _{m7} mm	OAL mm	10 925 ...
19,0	18,2	190
19,1	18,2	191
19,2	18,2	192
19,3	18,2	193
19,4	18,2	194
19,5	19,1	195
19,6	19,1	196
19,7	19,1	197
19,8	19,1	198
19,9	19,1	199
20,0	19,1	200
20,1	19,1	201
20,2	19,1	202
20,3	19,1	203
20,4	19,1	204
20,5	20,0	205
20,6	20,0	206
20,7	20,0	207
20,8	20,0	208
20,9	20,0	209
21,0	20,0	210
21,1	20,0	211
21,2	20,0	212
21,3	20,0	213
21,4	20,0	214
21,5	21,0	215
21,6	21,0	216
21,7	21,0	217
21,8	21,0	218
21,9	21,0	219
22,0	21,0	220
22,1	21,0	221
22,2	21,0	222
22,3	21,0	223
22,4	21,0	224
22,5	21,9	225
22,6	21,9	226
22,7	21,9	227
22,8	21,9	228
22,9	21,9	229
23,0	21,9	230
23,1	21,9	231
23,2	21,9	232
23,3	21,9	233
23,4	21,9	234
23,5	22,8	235
23,6	22,8	236
23,7	22,8	237
23,8	22,8	238
23,9	22,8	239
24,0	22,8	240
24,1	22,8	241
24,2	22,8	242
24,3	22,8	243
24,4	22,8	244
24,5	23,8	245
24,6	23,8	246
24,7	23,8	247
24,8	23,8	248
24,9	23,8	249
25,0	23,8	250

P	●
M	
K	●
N	
S	
H	
O	

→ v_c Page 156
→ Application recommendation on page 162

When changing the head, please observe the specified tightening torque.

WTX – Drilling Head for Exchangeable drills

- ▲ extra long head type
- ▲ three-edged

Scope of supply:

Drill head incl. differential screw

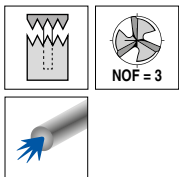

Change Feed UNI
Ti750

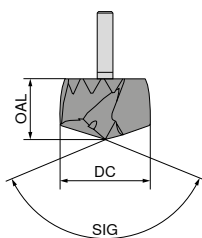

SIG 140°
Solid carbide

10 925 ...

DC _{m7} mm	OAL mm	
25,1	23,8	251
25,2	23,8	252
25,3	23,8	253
25,4	23,8	254
25,5	24,7	255
25,6	24,7	256
25,7	24,7	257
25,8	24,7	258
25,9	24,7	259
26,0	24,7	260
26,1	24,7	261
26,2	24,7	262
26,3	24,7	263
26,4	24,7	264
26,5	25,6	265
26,6	25,6	266
26,7	25,6	267
26,8	25,6	268
26,9	25,6	269
27,0	25,6	270
27,1	25,6	271
27,2	25,6	272
27,3	25,6	273
27,4	25,6	274
27,5	26,6	275
27,6	26,6	276
27,7	26,6	277
27,8	26,6	278
27,9	26,6	279
28,0	26,6	280
28,1	26,6	281
28,2	26,6	282
28,3	26,6	283
28,4	26,6	284
28,5	27,5	285
28,6	27,5	286
28,7	27,5	287
28,8	27,5	288
28,9	27,5	289
29,0	27,5	290
29,1	27,5	291
29,2	27,5	292
29,3	27,5	293
29,4	27,5	294
29,5	28,4	295
29,6	28,4	296
29,7	28,4	297
29,8	28,4	298
29,9	28,4	299
30,0	28,4	300

10 925 ...

DC _{m7} mm	OAL mm	
30,1	28,4	301
30,2	28,4	302
30,3	28,4	303
30,4	28,4	304
30,5	29,3	305
30,6	29,3	306
30,7	29,3	307
30,8	29,3	308
30,9	29,3	309
31,0	29,3	310
31,1	29,3	311
31,2	29,3	312
31,3	29,3	313
31,4	29,3	314
31,5	30,3	315
31,6	30,3	316
31,7	30,3	317
31,8	30,3	318
31,9	30,3	319
32,0	30,3	320

P	●
M	
K	●
N	
S	
H	
O	

→ v_c Page 156

→ Application recommendation on page 162



When changing the head, please observe the specified tightening torque.

WTX – Holder for Exchangeable drills

Scope of supply:

Holder incl. blade holder and interchangeable blade

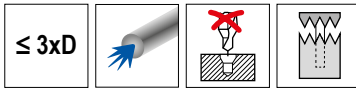

Change Feed

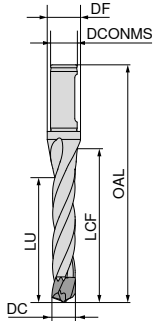

10 914 ...

DC mm	DCONMS _{h6} mm	OAL mm	LCF mm	LU mm	DF mm	torque moment Nm	
14,00 - 14,49	16	120	72	48	20	0,7	140
14,50 - 14,99	16	122	74	49	20	0,7	145
15,00 - 15,49	16	124	76	51	25	0,7	150
15,50 - 16,49	20	131	81	54	25	0,7	155
16,50 - 17,49	20	135	85	58	25	0,7	165
17,50 - 18,49	20	140	90	61	25	1,3	175
18,50 - 19,49	25	150	94	64	31	1,3	185
19,50 - 20,49	25	155	99	68	31	2,0	195
20,50 - 21,49	25	159	103	71	31	2,0	205
21,50 - 22,49	25	164	108	74	31	2,0	215
22,50 - 23,49	25	168	112	78	31	2,0	225
23,50 - 24,49	25	173	117	81	31	2,0	235
24,50 - 25,49	32	182	122	84	38	3,1	245
25,50 - 26,49	32	186	126	87	38	3,1	255
26,50 - 27,49	32	191	131	91	38	3,1	265
27,50 - 28,49	32	195	135	94	38	3,1	275
28,50 - 29,49	32	200	140	97	38	5,6	285
29,50 - 30,49	32	204	144	101	38	5,6	295
30,50 - 31,49	32	209	149	104	38	5,6	305
31,50 - 32,49	32	213	153	107	38	5,6	315

WTX – Holder for Exchangeable drills

Scope of supply:

Holder incl. blade holder and interchangeable blade

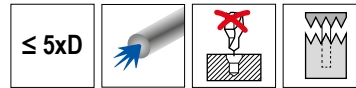

Change Feed

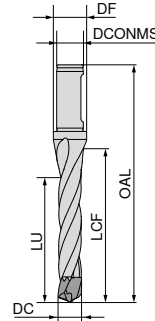

10 916 ...

DC mm	DCONMS _{h6} mm	OAL mm	LCF mm	LU mm	DF mm	torque moment Nm	
14,00 - 14,49	16	149	101	77	20	0,7	140
14,50 - 14,99	16	152	104	79	20	0,7	145
15,00 - 15,49	16	155	107	82	25	0,7	150
15,50 - 16,49	20	164	114	87	25	0,7	155
16,50 - 17,49	20	170	120	93	25	0,7	165
17,50 - 18,49	20	177	127	98	25	1,3	175
18,50 - 19,49	25	189	133	103	31	1,3	185
19,50 - 20,49	25	196	140	109	31	2,0	195
20,50 - 21,49	25	202	146	114	31	2,0	205
21,50 - 22,49	25	209	153	119	31	2,0	215
22,50 - 23,49	25	215	159	124	31	2,0	225
23,50 - 24,49	25	222	166	130	31	2,0	235
24,50 - 25,49	32	233	173	135	38	3,1	245
25,50 - 26,49	32	239	179	140	38	3,1	255
26,50 - 27,49	32	246	186	146	38	3,1	265
27,50 - 28,49	32	252	192	151	38	3,1	275
28,50 - 29,49	32	259	199	156	38	5,6	285
29,50 - 30,49	32	265	205	162	38	5,6	295
30,50 - 31,49	32	272	212	167	38	5,6	305
31,50 - 32,49	32	278	218	172	38	5,6	315

Spare parts

DC	80 022 ...	80 020 ...	80 023 ...	10 950 ...
14,00 - 14,49	007	025	012	064
14,50 - 14,99	007	025	012	064
15,00 - 15,49	007	025	012	064
15,50 - 16,49	007	025	012	064
16,50 - 17,49	007	025	012	064
17,50 - 18,49	008	025	060	065
18,50 - 19,49	008	025	060	065
19,50 - 20,49	010	025	060	066
20,50 - 21,49	010	025	060	066
21,50 - 22,49	010	025	060	066
22,50 - 23,49	010	025	060	066
23,50 - 24,49	010	025	060	066
24,50 - 25,49	015	025	060	067
25,50 - 26,49	015	025	060	067
26,50 - 27,49	015	025	060	067
27,50 - 28,49	015	025	060	067
28,50 - 29,49	015	025	060	068
29,50 - 30,49	015	025	060	068
30,50 - 31,49	015	025	060	068
31,50 - 32,49	015	025	060	068

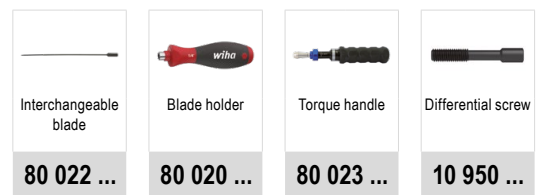

WTX – Holder for Exchangeable drills

Scope of supply:

Holder incl. blade holder and interchangeable blade

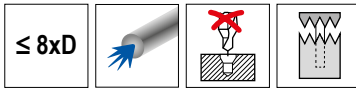

Change Feed

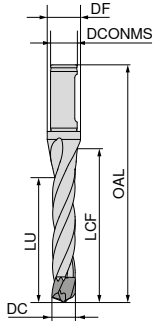

10 917 ...

DC mm	DCONMS _{h6} mm	OAL mm	LCF mm	LU mm	DF mm	torque moment Nm	
14,00 - 14,49	16	192	144	120	20	0,7	14000
14,50 - 14,99	16	197	149	124	20	0,7	14500
15,00 - 15,49	16	202	154	129	25	0,7	15000
15,50 - 16,49	20	213	163	137	25	0,7	15500
16,50 - 17,49	20	223	173	145	25	0,7	16500
17,50 - 18,49	20	232	182	153	25	1,3	17500
18,50 - 19,49	25	248	192	162	31	1,3	18500
19,50 - 20,49	25	257	201	170	31	2,0	19500
20,50 - 21,49	25	267	211	178	31	2,0	20500
21,50 - 22,49	25	276	220	187	31	2,0	21500
22,50 - 23,49	25	286	230	195	31	2,0	22500
23,50 - 24,49	25	295	239	203	31	2,0	23500
24,50 - 25,49	32	309	249	212	38	3,1	24500
25,50 - 26,49	32	319	259	220	38	3,1	25500
26,50 - 27,49	32	328	268	228	38	3,1	26500
27,50 - 28,49	32	338	278	236	38	3,1	27500
28,50 - 29,49	32	342	282	245	38	5,6	28500
29,50 - 30,49	32	352	292	253	38	5,6	29500
30,50 - 31,49	32	361	301	261	38	5,6	30500
31,50 - 32,49	32	371	311	270	38	5,6	31500

Interchangeable blade	Blade holder	Torque handle	Differential screw	
80 022 ...	80 020 ...	80 023 ...	10 950 ...	
DC				
14,00 - 14,49	007	025	012	064
14,50 - 14,99	007	025	012	064
15,00 - 15,49	007	025	012	064
15,50 - 16,49	007	025	012	064
16,50 - 17,49	007	025	012	064
17,50 - 18,49	008	025	060	065
18,50 - 19,49	008	025	060	065
19,50 - 20,49	010	025	060	066
20,50 - 21,49	010	025	060	066
21,50 - 22,49	010	025	060	066
22,50 - 23,49	010	025	060	066
23,50 - 24,49	010	025	060	066
24,50 - 25,49	015	025	060	067
25,50 - 26,49	015	025	060	067
26,50 - 27,49	015	025	060	067
27,50 - 28,49	015	025	060	067
28,50 - 29,49	015	025	060	068
29,50 - 30,49	015	025	060	068
30,50 - 31,49	015	025	060	068
31,50 - 32,49	015	025	060	068

Spare parts

DC

WTX – Drilling Head for Exchangeable drills

▲ extra long head type

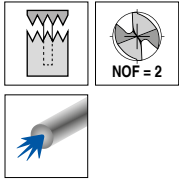

Change UNI	Change P	Change VA	Change GG	Change AL
DPX74S	Ti750	Ti700	TiSi	TiB
DRAGONSKIN				

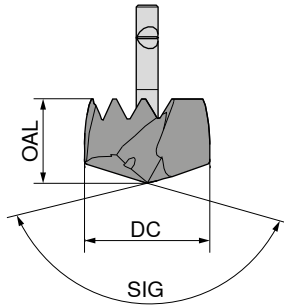

DC _{h7/m7} mm	OAL mm	SIG 140° Solid carbide		SIG 138° Solid carbide		SIG 138° Solid carbide		SIG 140° Solid carbide		SIG 140° Solid carbide	
		10 919 ...	12000	10 923 ...	120	10 921 ...	120	10 924 ...	120	10 922 ...	120
12,0	10,7	12000	120	12000	120	12000	120	12000	120	12000	120
12,1	10,7	12100	121	12100	121	12100	121	12100	121	12100	121
12,2	10,7	12200	122	12200	122	12200	122	12200	122	12200	122
12,3	10,7	12300	123	12300	123	12300	123	12300	123	12300	123
12,4	10,7	12400	124	12400	124	12400	124	12400	124	12400	124
12,5	10,7	12500	125	12500	125	12500	125	12500	125	12500	125
12,6	10,7	12600	126	12600	126	12600	126	12600	126	12600	126
12,7	10,7	12700	127	12700	127	12700	127	12700	127	12700	127
12,8	10,7	12800	128	12800	128	12800	128	12800	128	12800	128
12,9	10,7	12900	129	12900	129	12900	129	12900	129	12900	129
13,0	10,7	13000	130	13000	130	13000	130	13000	130	13000	130
13,1	10,7	13100	131	13100	131	13100	131	13100	131	13100	131
13,2	10,7	13200	132	13200	132	13200	132	13200	132	13200	132
13,3	10,7	13300	133	13300	133	13300	133	13300	133	13300	133
13,4	10,7	13400	134	13400	134	13400	134	13400	134	13400	134
13,5	11,3	13500	135	13500	135	13500	135	13500	135	13500	135
13,6	11,3	13600	136	13600	136	13600	136	13600	136	13600	136
13,7	11,3	13700	137	13700	137	13700	137	13700	137	13700	137
13,8	11,3	13800	138	13800	138	13800	138	13800	138	13800	138
13,9	11,3	13900	139	13900	139	13900	139	13900	139	13900	139
14,0	11,3	14000	140	14000	140	14000	140	14000	140	14000	140
14,1	11,3	14100	141	14100	141	14100	141	14100	141	14100	141
14,2	11,3	14200	142	14200	142	14200	142	14200	142	14200	142
14,3	11,3	14300	143	14300	143	14300	143	14300	143	14300	143
14,4	11,3	14400	144	14400	144	14400	144	14400	144	14400	144
14,5	11,3	14500	145	14500	145	14500	145	14500	145	14500	145
14,6	11,3	14600	146	14600	146	14600	146	14600	146	14600	146
14,7	11,3	14700	147	14700	147	14700	147	14700	147	14700	147
14,8	11,3	14800	148	14800	148	14800	148	14800	148	14800	148
14,9	11,3	14900	149	14900	149	14900	149	14900	149	14900	149
15,0	11,3	15000	150	15000	150	15000	150	15000	150	15000	150
15,1	11,3	15100	151	15100	151	15100	151	15100	151	15100	151
15,2	11,3	15200	152	15200	152	15200	152	15200	152	15200	152
15,3	11,3	15300	153	15300	153	15300	153	15300	153	15300	153
15,4	11,3	15400	154	15400	154	15400	154	15400	154	15400	154
15,5	11,9	15500	155	15500	155	15500	155	15500	155	15500	155
15,6	11,9	15600	156	15600	156	15600	156	15600	156	15600	156
15,7	11,9	15700	157	15700	157	15700	157	15700	157	15700	157

P	●	●	○		
M			●		
K	●	●	●	●	
N					●
S			●		
H					
O					

→ v_c Page 152–155

→ Application recommendation on page 162

Ø DC_{m7} for Type UNI, P, GG und AL / Ø DC_{h7} for Type VA

WTX – Drilling Head for Exchangeable drills

▲ extra long head type

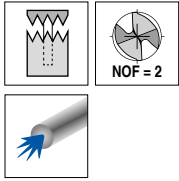

Change UNI	Change P	Change VA	Change GG	Change AL
DPX74S	Ti750	Ti700	TiSi	TiB
DRAGONSKIN				

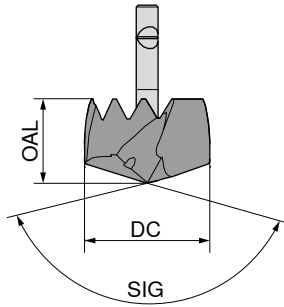

DC _{h7/m7} mm	OAL mm	SIG 140° Solid carbide		SIG 138° Solid carbide		SIG 138° Solid carbide		SIG 140° Solid carbide		SIG 140° Solid carbide	
		10 919 ...	15800	10 923 ...	158	10 921 ...	158	10 924 ...	158	10 922 ...	158
15,8	11,9		15800		158		158				158
15,9	11,9		15900		159		159				159
16,0	11,9		16000		160		160				160
16,1	11,9		16100		161		161				161
16,2	11,9		16200		162		162				162
16,3	11,9		16300		163		163				163
16,4	11,9		16400		164		164				164
16,5	13,4		16500		165		165				165
16,6	13,4		16600		166		166				166
16,7	13,4		16700		167		167				167
16,8	13,4		16800		168		168				168
16,9	13,4		16900		169		169				169
17,0	13,4		17000		170		170				170
17,1	13,4		17100		171		171				171
17,2	13,4		17200		172		172				172
17,3	13,4		17300		173		173				173
17,4	13,4		17400		174		174				174
17,5	13,4		17500		175		175				175
17,6	13,4		17600		176		176				176
17,7	13,4		17700		177		177				177
17,8	13,4		17800		178		178				178
17,9	13,4		17900		179		179				179
18,0	13,4		18000		180		180				180
18,1	13,4		18100		181		181				181
18,2	13,4		18200		182		182				182
18,3	13,4		18300		183		183				183
18,4	13,4		18400		184		184				184
18,5	13,4		18500		185		185				185
18,6	13,4		18600		186		186				186
18,7	13,4		18700		187		187				187
18,8	13,4		18800		188		188				188
18,9	13,4		18900		189		189				189
19,0	13,4		19000		190		190				190
19,1	13,4		19100		191		191				191
19,2	13,4		19200		192		192				192
19,3	13,4		19300		193		193				193
19,4	13,4		19400		194		194				194
19,5	13,4		19500		195		195				195
P			●	●		○					
M						●					
K			●	●		●		●			
N											●
S							●				
H											
O											

→ v_c Page 152–155

→ Application recommendation on page 162

Ø DC_{m7} for Type UNI, P, GG und AL / Ø DC_{h7} for Type VA

WTX – Drilling Head for Exchangeable drills

▲ extra long head type

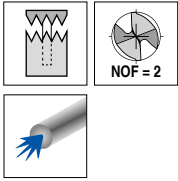

Change UNI	Change P	Change VA	Change GG	Change AL
DPX74S	Ti750	Ti700	TiSi	TiB
DRAGONSKIN				

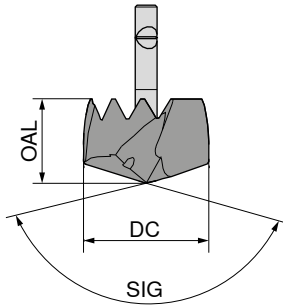

DC _{h7/m7} mm	OAL mm	SIG 140° Solid carbide		SIG 138° Solid carbide		SIG 138° Solid carbide		SIG 140° Solid carbide		SIG 140° Solid carbide	
		10 919 ...	10 923 ...	10 923 ...	10 921 ...	10 921 ...	10 924 ...	10 924 ...	10 922 ...	10 922 ...	
19,6	13,4	19600	196	196	196	196	196	196	196	196	
19,7	13,4	19700	197	197	197	197	197	197	197	197	
19,8	13,4	19800	198	198	198	198	198	198	198	198	
19,9	13,4	19900	199	199	199	199	199	199	199	199	
20,0	13,4	20000	200	200	200	200	200	200	200	200	
20,1	13,4	20100	201	201	201	201	201	201	201	201	
20,2	13,4	20200	202	202	202	202	202	202	202	202	
20,3	13,4	20300	203	203	203	203	203	203	203	203	
20,4	13,4	20400	204	204	204	204	204	204	204	204	
20,5	15,4	20500	205	205	205	205	205	205	205	205	
20,6	15,4	20600	206	206	206	206	206	206	206	206	
20,7	15,4	20700	207	207	207	207	207	207	207	207	
20,8	15,4	20800	208	208	208	208	208	208	208	208	
20,9	15,4	20900	209	209	209	209	209	209	209	209	
21,0	15,4	21000	210	210	210	210	210	210	210	210	
21,1	15,4	21100	211	211	211	211	211	211	211	211	
21,2	15,4	21200	212	212	212	212	212	212	212	212	
21,3	15,4	21300	213	213	213	213	213	213	213	213	
21,4	15,4	21400	214	214	214	214	214	214	214	214	
21,5	15,4	21500	215	215	215	215	215	215	215	215	
21,6	15,4	21600	216	216	216	216	216	216	216	216	
21,7	15,4	21700	217	217	217	217	217	217	217	217	
21,8	15,4	21800	218	218	218	218	218	218	218	218	
21,9	15,4	21900	219	219	219	219	219	219	219	219	
22,0	15,4	22000	220	220	220	220	220	220	220	220	
22,1	15,4	22100	221	221	221	221	221	221	221	221	
22,2	15,4	22200	222	222	222	222	222	222	222	222	
22,3	15,4	22300	223	223	223	223	223	223	223	223	
22,4	15,4	22400	224	224	224	224	224	224	224	224	
22,5	15,4	22500	225	225	225	225	225	225	225	225	
22,6	15,4	22600	226	226	226	226	226	226	226	226	
22,7	15,4	22700	227	227	227	227	227	227	227	227	
22,8	15,4	22800	228	228	228	228	228	228	228	228	
22,9	15,4	22900	229	229	229	229	229	229	229	229	
23,0	15,4	23000	230	230	230	230	230	230	230	230	
23,1	15,4	23100	231	231	231	231	231	231	231	231	
23,2	15,4	23200	232	232	232	232	232	232	232	232	
23,3	15,4	23300	233	233	233	233	233	233	233	233	
P		●	●	○							
M					●						
K		●	●	●	●		●				
N										●	
S					●						
H											
O											

→ v_c Page 152–155

→ Application recommendation on page 162

Ø DC_{m7} for Type UNI, P, GG und AL / Ø DC_{h7} for Type VA

WTX – Drilling Head for Exchangeable drills

▲ extra long head type

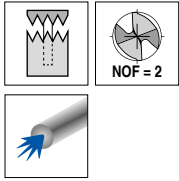

Change UNI	Change P	Change VA	Change GG	Change AL
DPX74S	Ti750	Ti700	TiSi	TiB
DRAGONSKIN				

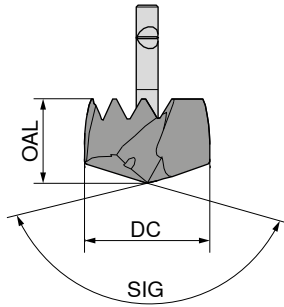

DC _{h7/m7} mm	OAL mm	SIG 140° Solid carbide		SIG 138° Solid carbide		SIG 138° Solid carbide		SIG 140° Solid carbide		SIG 140° Solid carbide	
		10 919 ...	23400	10 923 ...	234	10 921 ...	234	10 924 ...	234	10 922 ...	234
23,4	15,4		23400		234		234		234		234
23,5	15,4		23500		235		235		235		235
23,6	15,4		23600		236		236		236		236
23,7	15,4		23700		237		237		237		237
23,8	15,4		23800		238		238		238		238
23,9	15,4		23900		239		239		239		239
24,0	15,4		24000		240		240		240		240
24,1	15,4		24100		241		241		241		241
24,2	15,4		24200		242		242		242		242
24,3	15,4		24300		243		243		243		243
24,4	15,4		24400		244		244		244		244
24,5	17,4		24500		245		245		245		245
24,6	17,4		24600		246		246		246		246
24,7	17,4		24700		247		247		247		247
24,8	17,4		24800		248		248		248		248
24,9	17,4		24900		249		249		249		249
25,0	17,4		25000		250		250		250		250
25,1	17,4		25100		251		251		251		251
25,2	17,4		25200		252		252		252		252
25,3	17,4		25300		253		253		253		253
25,4	17,4		25400		254		254		254		254
25,5	17,4		25500		255		255		255		255
25,6	17,4		25600		256		256		256		256
25,7	17,4		25700		257		257		257		257
25,8	17,4		25800		258		258		258		258
25,9	17,4		25900		259		259		259		259
26,0	17,4		26000		260		260		260		260
26,1	17,4		26100		261		261		261		261
26,2	17,4		26200		262		262		262		262
26,3	17,4		26300		263		263		263		263
26,4	17,4		26400		264		264		264		264
26,5	17,4		26500		265		265		265		265
26,6	17,4		26600		266		266		266		266
26,7	17,4		26700		267		267		267		267
26,8	17,4		26800		268		268		268		268
26,9	17,4		26900		269		269		269		269
27,0	17,4		27000		270		270		270		270
27,1	17,4		27100		271		271		271		271
P			●	●		○					
M						●					
K			●	●		●	●				
N										●	
S						●					
H											
O											

→ v_c Page 152–155

→ Application recommendation on page 162

Ø DC_{m7} for Type UNI, P, GG und AL / Ø DC_{h7} for Type VA

WTX – Drilling Head for Exchangeable drills

▲ extra long head type

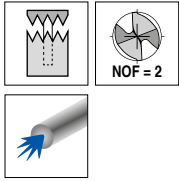

Change UNI	Change P	Change VA	Change GG	Change AL
DPX74S	Ti750	Ti700	TiSi	TiB
DRAGONSKIN				

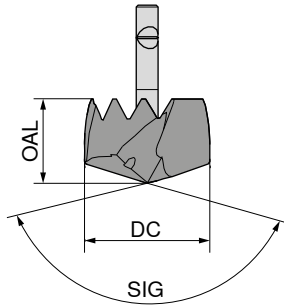

DC _{h7/m7} mm	OAL mm	SIG 140° Solid carbide		SIG 138° Solid carbide		SIG 138° Solid carbide		SIG 140° Solid carbide		SIG 140° Solid carbide	
		10 919 ...	27200	10 923 ...	272	10 921 ...	272	10 924 ...	272	10 922 ...	272
27,2	17,4		27200		272		272				272
27,3	17,4		27300		273		273				273
27,4	17,4		27400		274		274				274
27,5	17,4		27500		275		275				275
27,6	17,4		27600		276		276				276
27,7	17,4		27700		277		277				277
27,8	17,4		27800		278		278				278
27,9	17,4		27900		279		279				279
28,0	17,4		28000		280		280				280
28,1	17,4		28100		281		281				281
28,2	17,4		28200		282		282				282
28,3	17,4		28300		283		283				283
28,4	17,4		28400		284		284				284
28,5	18,4		28500		285		285				285
28,6	18,4		28600		286		286				286
28,7	18,4		28700		287		287				287
28,8	18,4		28800		288		288				288
28,9	18,4		28900		289		289				289
29,0	18,4		29000		290		290				290
29,1	18,4		29100		291		291				291
29,2	18,4		29200		292		292				292
29,3	18,4		29300		293		293				293
29,4	18,4		29400		294		294				294
29,5	18,4		29500		295		295				295
29,6	18,4		29600		296		296				296
29,7	18,4		29700		297		297				297
29,8	18,4		29800		298		298				298
29,9	18,4		29900		299		299				299
30,0	18,4		30000		300		300				300
30,1	18,4		30100		301		301				301
30,2	18,4		30200		302		302				302
30,3	18,4		30300		303		303				303
30,4	18,4		30400		304		304				304
30,5	18,4		30500		305		305				305
30,6	18,4		30600		306		306				306
30,7	18,4		30700		307		307				307
30,8	18,4		30800		308		308				308
30,9	18,4		30900		309		309				309
P			●	●		○					
M						●					
K			●	●		●		●			
N											●
S							●				
H											
O											

→ v_c Page 152–155

→ Application recommendation on page 162



Ø DC_{m7} for Type UNI, P, GG und AL / Ø DC_{h7} for Type VA

WTX – Drilling Head for Exchangeable drills

▲ extra long head type

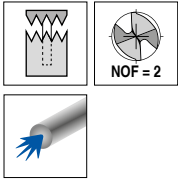

Change UNI	Change P	Change VA	Change GG	Change AL
DPX74S	Ti750	Ti700	TiSi	TiB

DRAGONSKIN

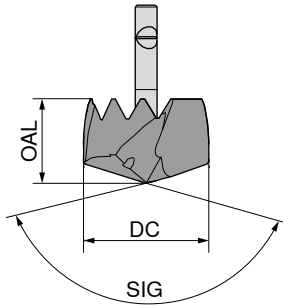

DC _{h7/m7} mm	OAL mm	SIG 140° Solid carbide		SIG 138° Solid carbide		SIG 138° Solid carbide		SIG 140° Solid carbide		SIG 140° Solid carbide	
		10 919 ...	31000	10 923 ...	310	10 921 ...	310	10 924 ...	310	10 922 ...	310
31,0	18,4		31000		310		310				310
31,1	18,4		31100		311		311				311
31,2	18,4		31200		312		312				312
31,3	18,4		31300		313		313				313
31,4	18,4		31400		314		314				314
31,5	18,4		31500		315		315				315
31,6	18,4		31600		316		316				316
31,7	18,4		31700		317		317				317
31,8	18,4		31800		318		318				318
31,9	18,4		31900		319		319				319
32,0	18,4		32000		320		320				320
32,5	24,3		32500		325						
33,0	24,3		33000		330						
33,5	24,3		33500		335						
34,0	24,3		34000		340						
34,5	24,3		34500		345						
35,0	24,3		35000		350						
35,5	26,3		35500		355						
36,0	26,3		36000		360						
36,5	26,3		36500		365						
37,0	26,3		37000		370						
37,5	26,3		37500		375						
38,0	26,3		38000		380						
38,5	26,3		38500		385						
39,0	26,3		39000		390						
39,5	26,3		39500		395						
40,0	26,3		40000		400						
40,5	26,3		40500		405						
41,0	26,3		41000		410						
P			●	●	○						
M					●						
K			●	●	●		●				
N											●
S						●					
H											
O											

→ v_c Page 152–155

→ Application recommendation on page 162

Ø DC_{m7} for Type UNI, P, GG und AL / Ø DC_{h7} for Type VA

When changing the head, please observe the specified tightening torque.

WTX – Holder for Exchangeable drills

▲ with radial teeth

Scope of supply:

Holder incl. screw driver

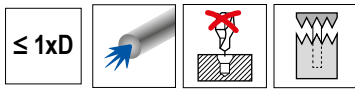

Change

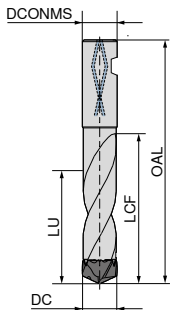

10 911 ...

DC mm	DCONMS _{h6} mm	OAL mm	LCF mm	LU mm	torque moment Nm	
12,00 - 12,49	14	81	29	12,5	1,0	120
12,50 - 12,99	14	81	29	13,0	1,0	125
13,00 - 13,49	14	81	31	13,5	1,0	130
13,50 - 13,99	16	86	32	14,0	1,3	135
14,00 - 14,49	16	86	33	14,5	1,3	140
14,50 - 14,99	16	91	34	15,0	1,3	145
15,00 - 15,49	16	91	36	15,5	1,3	150
15,50 - 16,49	20	97	38	16,5	1,3	161
16,50 - 17,49	18	92	38	16,5	1,3	160
16,50 - 17,49	20	99	40	17,5	3,5	166
16,50 - 17,49	18	94	40	17,5	3,5	165
17,50 - 18,49	20	104	43	18,5	3,5	176
17,50 - 18,49	18	99	43	18,5	3,5	175
18,50 - 19,49	20	99	45	19,5	3,5	185
19,50 - 20,49	20	104	47	20,5	3,5	195
20,50 - 21,49	25	111	49	21,5	3,5	205
21,50 - 22,49	25	116	52	22,5	3,5	215
22,50 - 23,49	25	116	54	23,5	3,5	225
23,50 - 24,49	25	121	56	24,5	4,0	235
24,50 - 25,49	25	123	59	25,5	4,0	245
25,50 - 26,49	25	123	61	26,5	4,0	255
26,50 - 27,49	25	128	63	27,5	4,0	265
27,50 - 28,49	25	128	66	28,5	4,0	275
28,50 - 29,49	32	134	68	29,5	4,0	285
29,50 - 30,49	32	139	70	30,5	4,0	295
30,50 - 31,49	32	139	75	31,5	4,0	305
31,50 - 32,49	32	139	75	32,5	4,0	315
32,50 - 33,49	32	150	78	33,5	6,0	325
33,50 - 34,49	32	150	79	34,5	6,0	335
34,50 - 35,49	32	150	82	35,5	6,0	345
35,50 - 37,49	32	152	86	37,5	6,0	355
37,50 - 39,49	32	157	91	39,5	6,0	375
39,50 - 41,00	32	167	95	41,5	6,0	395

WTX – Holder for Exchangeable drills

▲ with radial teeth

Scope of supply:

Holder incl. screw driver

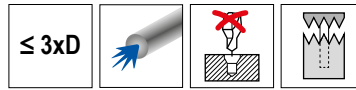

Change

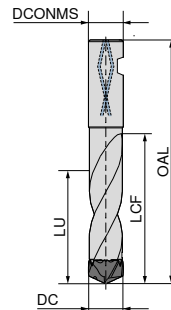

10 913 ...

DC mm	DCONMS _{h6} mm	OAL mm	LCF mm	LU mm	torque moment Nm	
12,00 - 12,49	14	100	53	38,0	1,0	120
12,50 - 12,99	14	105	55	39,0	1,0	125
13,00 - 13,49	14	105	57	40,0	1,0	130
13,50 - 13,99	16	110	59	42,0	1,3	135
14,00 - 14,49	16	115	61	43,0	1,3	140
14,50 - 14,99	16	115	63	45,0	1,3	145
15,00 - 15,49	16	115	65	46,0	1,3	150
15,50 - 16,49	18	120	70	50,0	1,3	160
15,50 - 16,49	20	125	70	50,0	1,3	161
16,50 - 17,49	18	125	74	53,0	3,5	165
16,50 - 17,49	20	130	74	50,0	3,5	166
17,50 - 18,49	18	130	78	55,0	3,5	175
17,50 - 18,49	20	135	78	50,0	3,5	176
18,50 - 19,49	20	135	82	58,0	3,5	185
19,50 - 20,49	20	140	87	62,0	3,5	195
20,50 - 21,49	25	150	91	65,0	3,5	205
21,50 - 22,49	25	155	95	67,0	3,5	215
22,50 - 23,49	25	160	99	70,0	3,5	225
23,50 - 24,49	25	165	103	73,0	3,5	235
24,50 - 25,49	25	165	108	77,0	4,0	245
25,50 - 26,49	25	175	112	80,0	4,0	255
26,50 - 27,49	25	175	116	82,0	4,0	265
27,50 - 28,49	25	180	120	85,0	4,0	275
28,50 - 29,49	32	190	124	88,0	4,0	285
29,50 - 30,49	32	195	129	92,0	4,0	295
30,50 - 31,49	32	195	133	94,0	4,0	305
31,50 - 32,49	32	200	137	97,0	4,0	315
32,50 - 33,49	32	210	144	100,5	6,0	325
33,50 - 34,49	32	215	148	103,5	6,0	335
34,50 - 35,49	32	220	153	106,5	6,0	345
35,50 - 37,49	32	227	161	112,5	6,0	355
37,50 - 39,49	32	237	170	118,5	6,0	375
39,50 - 41,00	32	247	178	124,5	6,0	395



Screw driver

80 950 ...



Screw driver

80 950 ...



Grub screw

10 950 ...

Spare parts

DC				
12,00 - 12,49	SW 1,3	132	M2,5 x 0,45 x 5	025
12,50 - 13,49	SW 1,3	132	M2,5 x 0,45 x 6	026
13,50 - 14,49			M3 x 0,5 x 6	031
14,50 - 16,49		SW 1,5	M3 x 0,5 x 7	030
16,50 - 20,49		SW 2	M4 x 0,5 x 7,5	040
20,50 - 24,49		SW 2	M4 x 0,5 x 10	041
24,50 - 28,49		SW 2,5	M5 x 0,5 x 11	050
28,50 - 32,49		SW 2,5	M5 x 0,5 x 14	051
32,50 - 35,49		SW 3	M6 x 0,5 x 16	060
35,50 - 39,49		SW 3	M6 x 0,5 x 18	061
39,50 - 41,00		SW 3	M6 x 0,5 x 20	062

WTX – Holder for Exchangeable drills

▲ with radial teeth

Scope of supply:

Holder incl. screw driver

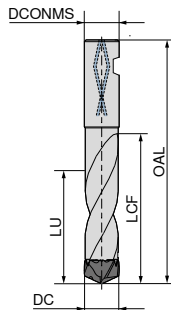
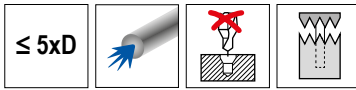

10 915 ...

DC mm	DCONMS _{h6} mm	OAL mm	LCF mm	LU mm	torque moment Nm	
12,00 - 12,49	14	125	78	62,0	1,0	120
12,50 - 12,99	14	130	81	65,0	1,0	125
13,00 - 13,49	14	130	84	67,0	1,0	130
13,50 - 13,99	16	140	88	70,0	1,3	135
14,00 - 14,49	16	140	90	72,0	1,3	140
14,50 - 14,99	16	145	94	75,0	1,3	145
15,00 - 15,49	16	145	96	77,0	1,3	150
15,50 - 16,49	18	155	103	82,0	1,3	160
15,50 - 16,49	20	160	103	82,0	1,3	161
16,50 - 17,49	18	160	109	87,0	3,5	165
16,50 - 17,49	20	165	109	87,0	3,5	166
17,50 - 18,49	18	165	115	92,0	3,5	175
17,50 - 18,49	20	170	115	92,0	3,5	176
18,50 - 19,49	20	175	121	97,0	3,5	185
19,50 - 20,49	20	180	128	102,0	3,5	195
20,50 - 21,49	25	195	134	107,0	3,5	205
21,50 - 22,49	25	200	140	112,0	3,5	215
22,50 - 23,49	25	205	146	117,0	3,5	225
23,50 - 24,49	25	210	152	122,0	3,5	235
24,50 - 25,49	25	220	159	127,0	4,0	245
25,50 - 26,49	25	225	165	132,0	4,0	255
26,50 - 27,49	25	230	171	137,0	4,0	265
27,50 - 28,49	25	240	177	142,0	4,0	275
28,50 - 29,49	32	250	183	146,0	4,0	285
29,50 - 30,49	32	255	190	152,0	4,0	295
30,50 - 31,49	32	260	196	157,0	4,0	305
31,50 - 32,49	32	265	202	162,0	4,0	315
32,50 - 33,49	32	275	210	167,5	6,0	325
33,50 - 34,49	32	285	217	172,5	6,0	335
34,50 - 35,49	32	290	224	177,5	6,0	345
35,50 - 37,49	32	302	236	187,5	6,0	355
37,50 - 39,49	32	317	249	197,5	6,0	375
39,50 - 41,00	32	327	261	207,5	6,0	395

WTX – Holder for Exchangeable drills

▲ Pilot hole is recommended

▲ With radial teeth

Scope of supply:

Holder incl. screw driver

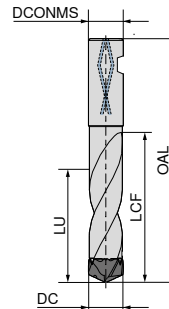
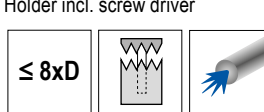

10 918 ...

DC mm	DCONMS _{h6} mm	OAL mm	LCF mm	LU mm	torque moment Nm	
12,00 - 12,49	14	165	116	100	1,0	120
12,50 - 12,99	14	170	121	104	1,0	125
13,00 - 13,49	14	175	126	108	1,0	130
13,50 - 13,99	16	180	129	111	1,3	135
14,00 - 14,49	16	185	134	115	1,3	140
14,50 - 14,99	16	190	139	120	1,3	145
15,00 - 15,49	16	195	144	124	1,3	150
15,50 - 16,49	18	205	152	131	1,3	160
15,50 - 16,49	20	210	152	131	1,3	161
16,50 - 17,49	18	215	161	138	3,5	165
16,50 - 17,49	20	220	161	138	3,5	166
17,50 - 18,49	18	220	171	147	3,5	175
17,50 - 18,49	20	225	171	147	3,5	176
18,50 - 19,49	20	235	180	155	3,5	185
19,50 - 20,49	20	240	189	163	3,5	195
20,50 - 21,49	25	260	198	170	3,5	205
21,50 - 22,49	25	270	207	178	3,5	215
22,50 - 23,49	25	275	217	187	3,5	225
23,50 - 24,49	25	285	226	194	3,5	235
24,50 - 25,49	25	295	235	202	4,0	245
25,50 - 26,49	25	305	244	210	4,0	255
26,50 - 27,49	25	315	253	218	4,0	265
27,50 - 28,49	25	325	263	226	4,0	275
28,50 - 29,49	32	340	272	234	4,0	285
29,50 - 30,49	32	345	281	242	4,0	295
30,50 - 31,49	32	355	290	249	4,0	305
31,50 - 32,00	32	360	299	257	4,0	315

Spare parts

DC	Screw driver	Grub screw
12,00 - 12,49	SW 1,3	M2,5 x 0,45 x 5
12,50 - 13,49	SW 1,3	M2,5 x 0,45 x 6
13,50 - 14,49		M3 x 0,5 x 6
14,50 - 16,49	SW 1,5	M3 x 0,5 x 7
16,50 - 20,49	SW 2	M4 x 0,5 x 7,5
20,50 - 24,49	SW 2	M4 x 0,5 x 10
24,50 - 28,49	SW 2,5	M5 x 0,5 x 11
28,50 - 32,49	SW 2,5	M5 x 0,5 x 14
32,50 - 35,49	SW 3	M6 x 0,5 x 16
35,50 - 39,49	SW 3	M6 x 0,5 x 18
39,50 - 41,00	SW 3	M6 x 0,5 x 20

Screw driver

80 950 ...

Screw driver

80 950 ...

Grub screw

10 950 ...

WTX – Holder for Exchangeable drills

- ▲ Pilot hole is recommended
- ▲ With radial teeth

Scope of supply:

Holder incl. screw driver

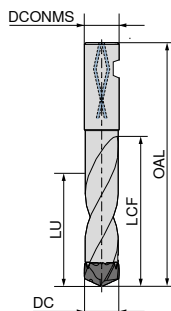
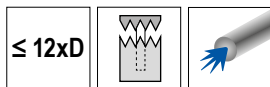

10 912 ...

DC mm	DCONMS _{h6} mm	OAL mm	LCF mm	LU mm	torque moment Nm	
12,00 - 12,49	14	210	162	150	1,0	12000
12,50 - 12,99	14	216	168	156	1,0	12500
13,00 - 13,49	14	223	175	162	1,0	13000
13,50 - 13,99	16	235	182	168	1,3	13500
14,00 - 14,49	16	242	189	174	1,3	14000
14,50 - 14,99	16	248	195	180	1,3	14500
15,00 - 15,49	16	255	202	186	1,3	15000
15,50 - 16,49	18	262	209	198	1,3	15500
16,50 - 17,49	18	275	222	210	3,5	16500
17,50 - 18,49	18	289	236	222	3,5	17500
18,50 - 19,49	20	304	249	234	3,5	18500
19,50 - 20,49	20	318	263	246	3,5	19500
20,50 - 21,49	25	337	276	258	3,5	20500
21,50 - 22,49	25	351	290	270	3,5	21500
22,50 - 23,49	25	364	303	282	3,5	22500
23,50 - 24,49	25	378	317	294	3,5	23500
24,50 - 25,49	25	391	330	306	4,0	24500
25,50 - 26,49	25	405	344	318	4,0	25500
26,50 - 27,49	25	418	357	330	4,0	26500
27,50 - 28,49	25	432	371	342	4,0	27500
28,50 - 29,49	32	449	384	354	4,0	28500
29,50 - 30,49	32	463	398	366	4,0	29500
30,50 - 31,49	32	476	411	378	4,0	30500
31,50 - 32,00	32	490	425	390	4,0	31500

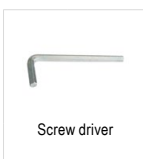

80 950 ...

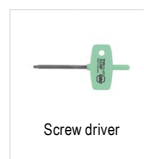

80 950 ...

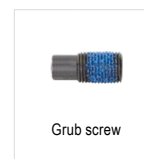

10 950 ...

Spare parts

DC				
12,00 - 12,49	SW 1,3	132		M2,5 x 0,45 x 5 025
12,50 - 13,49	SW 1,3	132		M2,5 x 0,45 x 6 026
13,50 - 14,49			SW 1,5	M3 x 0,5 x 6 031
14,50 - 16,49			SW 1,5	M3 x 0,5 x 7 030
16,50 - 20,49			SW 2	M4 x 0,5 x 7,5 040
20,50 - 24,49			SW 2	M4 x 0,5 x 10 041
24,50 - 28,49			SW 2,5	M5 x 0,5 x 11 050
28,50 - 32,49			SW 2,5	M5 x 0,5 x 14 051
32,50 - 35,49			SW 3	M6 x 0,5 x 16 060
35,50 - 39,49			SW 3	M6 x 0,5 x 18 061
39,50 - 41,00			SW 3	M6 x 0,5 x 20 062

WPC – Indexable insert for indexable insert drill

Scope of supply:

Indexable insert (clamping screws can be ordered separately, if necessary)



NEW
Change UNI
TPX74S

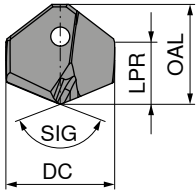

SIG 135°
HM

11 910 ...

DC _{m7} mm	OAL mm	LPR mm	S mm	
14,0	12,8	7,73	5,00	14000
14,1	12,8	7,73	5,00	14100
14,2	12,8	7,73	5,00	14200
14,3	12,8	7,73	5,00	14300
14,4	12,8	7,73	5,00	14400
14,5	13,1	7,84	5,00	14500
14,6	13,1	7,84	5,00	14600
14,7	13,1	7,84	5,00	14700
14,8	13,1	7,84	5,00	14800
14,9	13,1	7,84	5,00	14900
15,0	13,4	7,95	5,00	15000
15,1	13,4	7,95	5,00	15100
15,2	13,4	7,95	5,00	15200
15,3	13,4	7,95	5,00	15300
15,4	13,4	7,95	5,00	15400
15,5	13,7	8,05	5,00	15500
15,6	13,7	8,05	5,00	15600
15,7	13,7	8,05	5,00	15700
15,8	13,7	8,05	5,00	15800
15,9	13,7	8,05	5,00	15900
16,0	14,4	9,06	5,80	16000
16,1	14,4	9,06	5,80	16100
16,2	14,4	9,06	5,80	16200
16,3	14,4	9,06	5,80	16300
16,4	14,4	9,06	5,80	16400
16,5	14,7	9,17	5,80	16500
16,6	14,7	9,17	5,80	16600
16,7	14,7	9,17	5,80	16700
16,8	14,7	9,17	5,80	16800
16,9	14,7	9,17	5,80	16900
17,0	15,0	9,28	5,80	17000
17,1	15,0	9,28	5,80	17100
17,2	15,0	9,28	5,80	17200
17,3	15,0	9,28	5,80	17300
17,4	15,0	9,28	5,80	17400
17,5	15,3	9,39	5,80	17500
17,6	15,3	9,39	5,80	17600
17,7	15,3	9,39	5,80	17700
17,8	15,3	9,39	5,80	17800
17,9	15,3	9,39	5,80	17900
18,0	16,3	10,19	6,50	18000
18,1	16,3	10,19	6,50	18100
18,2	16,3	10,19	6,50	18200
18,3	16,3	10,19	6,50	18300
18,4	16,3	10,19	6,50	18400
18,5	16,6	10,30	6,50	18500
18,6	16,6	10,30	6,50	18600
18,7	16,6	10,30	6,50	18700
18,8	16,6	10,30	6,50	18800
18,9	16,6	10,30	6,50	18900
19,0	16,9	10,41	6,50	19000
19,1	16,9	10,41	6,50	19100
19,2	16,9	10,41	6,50	19200
19,3	16,9	10,41	6,50	19300
19,4	16,9	10,41	6,50	19400
19,5	17,2	10,52	6,50	19500
19,6	17,2	10,52	6,50	19600
19,7	17,2	10,52	6,50	19700
19,8	17,2	10,52	6,50	19800
19,9	17,2	10,52	6,50	19900

11 910 ...

DC _{m7} mm	OAL mm	LPR mm	S mm	
20,0	18,2	11,33	7,20	20000
20,1	18,2	11,33	7,20	20100
20,2	18,2	11,33	7,20	20200
20,3	18,2	11,33	7,20	20300
20,4	18,2	11,33	7,20	20400
20,5	18,5	11,43	7,20	20500
20,6	18,5	11,43	7,20	20600
20,7	18,5	11,43	7,20	20700
20,8	18,5	11,43	7,20	20800
20,9	18,5	11,43	7,20	20900
21,0	18,8	11,54	7,20	21000
21,1	18,8	11,54	7,20	21100
21,2	18,8	11,54	7,20	21200
21,3	18,8	11,54	7,20	21300
21,4	18,8	11,54	7,20	21400
21,5	19,1	11,65	7,20	21500
21,6	19,1	11,65	7,20	21600
21,7	19,1	11,65	7,20	21700
21,8	19,1	11,65	7,20	21800
21,9	19,1	11,65	7,20	21900
22,0	20,2	12,56	7,90	22000
22,1	20,2	12,56	7,90	22100
22,2	20,2	12,56	7,90	22200
22,3	20,2	12,56	7,90	22300
22,4	20,2	12,56	7,90	22400
22,5	20,5	12,67	7,90	22500
22,6	20,5	12,67	7,90	22600
22,7	20,5	12,67	7,90	22700
22,8	20,5	12,67	7,90	22800
22,9	20,5	12,67	7,90	22900
23,0	20,8	12,78	7,90	23000
23,1	20,8	12,78	7,90	23100
23,2	20,8	12,78	7,90	23200
23,3	20,8	12,78	7,90	23300
23,4	20,8	12,78	7,90	23400
23,5	21,1	12,88	7,90	23500
23,6	21,1	12,88	7,90	23600
23,7	21,1	12,88	7,90	23700
23,8	21,1	12,88	7,90	23800
23,9	21,1	12,88	7,90	23900
24,0	22,1	13,69	8,60	24000
24,1	22,1	13,69	8,60	24100
24,2	22,1	13,69	8,60	24200
24,3	22,1	13,69	8,60	24300
24,4	22,1	13,69	8,60	24400
24,5	22,4	13,80	8,60	24500
24,6	22,4	13,80	8,60	24600
24,7	22,4	13,80	8,60	24700
24,8	22,4	13,80	8,60	24800
24,9	22,4	13,80	8,60	24900
25,0	22,7	13,91	8,60	25000
25,1	22,7	13,91	8,60	25100
25,2	22,7	13,91	8,60	25200
25,3	22,7	13,91	8,60	25300
25,4	22,7	13,91	8,60	25400
25,5	23,0	14,02	8,60	25500
25,6	23,0	14,02	8,60	25600
25,7	23,0	14,02	8,60	25700
25,8	23,0	14,02	8,60	25800
25,9	23,0	14,02	8,60	25900
26,0	24,1	14,92	9,40	26000
26,5	24,4	15,03	9,40	26500
27,0	24,7	15,14	9,40	27000
27,5	25,0	15,25	9,40	27500
28,0	25,3	15,36	9,40	28000
28,5	25,6	15,47	9,40	28500
29,0	25,9	15,57	9,40	29000
29,5	26,2	15,68	9,40	29500
30,0	26,2	15,49	9,40	30000

P	●
M	
K	●
N	
S	
H	
O	

→ v. Page 157

→ Application recommendation on page 163



When changing inserts, please observe the specified tightening torque.

WPC – Holder for indexable insert drill

- ▲ Easy handling
- ▲ Insert can be changed in the machine
- ▲ Precise and stable insert seat, clamping via Torx Plus® screw

Scope of supply:

Holder incl. clamping screw

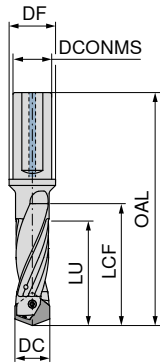
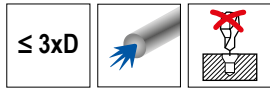

11 903 ...

DC mm	DCONMS mm	OAL mm	LCF mm	LU mm	DF mm	torque moment Nm	
14,00 - 14,49	16	108,9	50,8	43,5	20	0,9	14000
14,50 - 14,99	16	111,0	52,5	45,0	20	0,9	14500
15,00 - 15,49	20	115,1	54,3	46,5	25	0,9	15000
15,50 - 15,99	20	117,2	56,0	48,0	25	0,9	15500
16,00 - 16,49	20	119,3	57,8	49,5	25	1,2	16000
16,50 - 16,99	20	121,4	59,5	51,0	25	1,2	16500
17,00 - 17,49	20	123,5	61,3	52,5	25	1,2	17000
17,50 - 17,99	20	125,6	63,0	54,0	25	1,2	17500
18,00 - 18,49	20	127,7	64,8	55,5	25	2,2	18000
18,50 - 18,99	20	129,8	66,5	57,0	25	2,2	18500
19,00 - 19,49	25	137,9	68,3	58,5	30	2,2	19000
19,50 - 19,99	25	140,0	70,0	60,0	30	2,2	19500
20,00 - 20,49	25	142,1	71,8	61,5	30	2,2	20000
20,50 - 20,99	25	144,2	73,5	63,0	30	2,2	20500
21,00 - 21,49	25	146,3	75,3	64,5	30	2,2	21000
21,50 - 21,99	25	148,4	77,0	66,0	30	2,2	21500
22,00 - 22,49	25	150,5	78,8	67,5	30	3,2	22000
22,50 - 22,99	25	152,6	80,5	69,0	30	3,2	22500
23,00 - 23,49	25	154,7	82,3	70,5	30	3,2	23000
23,50 - 23,99	25	156,8	84,0	72,0	30	3,2	23500
24,00 - 24,49	32	162,9	85,8	73,5	39	5	24000
24,50 - 24,99	32	165,0	87,5	75,0	39	5	24500
25,00 - 25,49	32	167,1	89,3	76,5	39	5	25000
25,50 - 25,99	32	169,2	91,0	78,0	39	5	25500
26,00 - 26,49	32	171,3	92,8	79,5	39	6	26000
26,50 - 26,99	32	173,4	94,5	81,0	39	6	26500
27,00 - 27,49	32	175,5	96,3	82,5	39	6	27000
27,50 - 27,99	32	177,6	98,0	84,0	39	6	27500
28,00 - 28,49	32	179,7	99,8	85,5	39	6	28000
28,50 - 28,99	32	181,8	101,5	87,0	39	6	28500
29,00 - 29,49	32	183,9	103,3	88,5	39	6	29000
29,50 - 30,00	32	186,0	105,0	90,0	39	6	29500

WPC – Holder for indexable insert drill

- ▲ Easy handling
- ▲ Insert can be changed in the machine
- ▲ Precise and stable insert seat, clamping via Torx Plus® screw

Scope of supply:

Holder incl. clamping screw

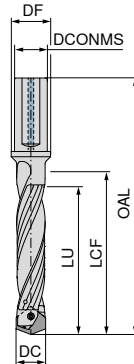
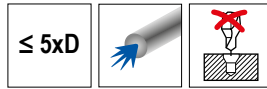

11 905 ...

DC mm	DCONMS mm	OAL mm	LCF mm	LU mm	DF mm	torque moment Nm	
14,00 - 14,49	16	137,9	79,8	72,5	20	0,9	14000
14,50 - 14,99	16	141,0	82,5	75,0	20	0,9	14500
15,00 - 15,49	20	146,1	85,3	77,5	25	0,9	15000
15,50 - 15,99	20	149,2	88,0	80,0	25	0,9	15500
16,00 - 16,49	20	152,3	90,8	82,5	25	1,2	16000
16,50 - 16,99	20	155,4	93,5	85,0	25	1,2	16500
17,00 - 17,49	20	158,5	96,3	87,5	25	1,2	17000
17,50 - 17,99	20	161,6	99,0	90,0	25	1,2	17500
18,00 - 18,49	20	164,7	101,8	92,5	25	2,2	18000
18,50 - 18,99	20	167,8	104,5	95,0	25	2,2	18500
19,00 - 19,49	25	176,9	107,3	97,5	30	2,2	19000
19,50 - 19,99	25	180,0	110,0	100,0	30	2,2	19500
20,00 - 20,49	25	183,1	112,8	102,5	30	2,2	20000
20,50 - 20,99	25	186,2	115,5	105,0	30	2,2	20500
21,00 - 21,49	25	189,3	118,3	107,5	30	2,2	21000
21,50 - 21,99	25	192,4	121,0	110,0	30	2,2	21500
22,00 - 22,49	25	195,5	123,8	112,5	30	3,2	22000
22,50 - 22,99	25	198,6	126,5	115,0	30	3,2	22500
23,00 - 23,49	25	201,7	129,3	117,5	30	3,2	23000
23,50 - 23,99	25	204,8	132,0	120,0	30	3,2	23500
24,00 - 24,49	32	211,9	134,8	122,5	39	5	24000
24,50 - 24,99	32	215,0	137,5	125,0	39	5	24500
25,00 - 25,49	32	218,1	140,3	127,5	39	5	25000
25,50 - 25,99	32	221,2	143,0	130,0	39	5	25500
26,00 - 26,49	32	224,3	145,8	132,5	39	6	26000
26,50 - 26,99	32	227,4	148,5	135,0	39	6	26500
27,00 - 27,49	32	230,5	151,3	137,5	39	6	27000
27,50 - 27,99	32	233,6	154,0	140,0	39	6	27500
28,00 - 28,49	32	236,7	156,8	142,5	39	6	28000
28,50 - 28,99	32	239,8	159,5	145,0	39	6	28500
29,00 - 29,49	32	242,9	162,3	147,5	39	6	29000
29,50 - 30,00	32	246,0	165,0	150,0	39	6	29500

Screwdriver

80 950 ...

Replaceable Blade for TORX PLUS®

80 950 ...

Torque screwdrivers

80 950 ...

Clamping screw

11 950 ...

Spare parts

DC							
14,00 - 15,99	T08 - IP	060	T08 - IP	043	0,5 - 2,0 Nm	191	
16,00 - 17,99	T08 - IP	060	T08 - IP	043	0,5 - 2,0 Nm	191	
18,00 - 21,99	T10 - IP	062	T10 - IP	053	2,0 - 7,0 Nm	193	
22,00 - 23,99	T10 - IP	062	T10 - IP	053	2,0 - 7,0 Nm	193	
24,00 - 25,99	T15 - IP	063	T15 - IP	054	2,0 - 7,0 Nm	193	
26,00 - 30,00	T20 - IP	064	T20 - IP	055	2,0 - 7,0 Nm	193	
						M2,2x13 - 08IP	00100
						M2,5x15 - 08IP	00200
						M3,0x17 - 10IP	00300
						M3,5x21 - 10IP	00400
						M4,0x23 - 15IP	00500
						M4,5x25 - 20IP	00600

MultiChange – Programme Overview

The "MultiChange" interchangeable head system enables an extremely fast and problem free tool change. Provides quick changeover and concentricity with the highest stability at the same time. For a multitude of applications, the suitable interchangeable heads are available in the following chapters.

Exchangeable heads	
<p>→ Chapter 2, Solid carbide drilling</p> <p>Solid Carbide NC Spot Drills</p> <p>Ø 8, 10, 12, 16, 20 mm NOF 2</p>	<p>Page No. 2 107</p> <p>SIG 90° SIG 120° SIG 142°</p>
<p>→ Chapter 4, Reaming and countersinking</p> <p>Replaceable reaming heads</p> <p>Ø 8,00 – 30,20 mm</p> <p>Ø 12,20 – 30,20 mm</p>	<p>Page No. 4 18 + 4 19</p> <p>Through hole</p> <p>Blind hole</p>
<p>→ Chapter 14, Solid carbide milling cutters</p> <p>Solid carbide shoulder mills</p> <p>Ø 8, 10, 12, 16, 20 mm / ZEFP 3+4</p> <p>Solid carbide torus bull nose milling cutters</p> <p>Ø 8, 10, 12, 16, 20 mm / ZEFP 3+4</p> <p>Solid carbide rough and finish milling cutters</p> <p>Ø 8, 10, 12, 16, 20 mm / ZEFP 4+6</p> <p>Solid carbide finish milling cutters</p> <p>Ø 8, 10, 12, 16, 20 mm / ZEFP 6</p> <p>Solid carbide ball-nosed end mills</p> <p>Ø 10, 12, 16, 20 mm / ZEFP 4</p> <p>Solid carbide high-feed cutters</p> <p>Ø 8, 10, 12, 16, 20 mm / ZEFP 6</p> <p>Solid carbide quarter round cutter</p> <p>Ø 8, 10, 12, 16, 20 mm / ZEFP 6</p> <p>Solid carbide deburring cutters</p> <p>Ø 10, 12, 16, 20 mm / ZEFP 4+6</p> <p>NOF / ZEFP = Number of cutting edges</p>	<p>Page No. 14 198 – 14 202</p> <p>Type PCR-UNI Type PCR-ALU Type N</p> <p>Type W Type N</p> <p>Type NF</p> <p>Type N</p> <p>Type N</p> <p>Type N</p> <p>Type N</p> <p>Type N</p> <p>Type N</p> <p>Type N</p> <p>Type N</p>

Tool holder	
<p>→ Catalogue – Clamping technology, Chapter 16 Accessories</p> <p>OAL 60 – 90 mm</p> <p>Tapered 87° / Steel Cylindrical* / Steel</p>	<p>Page No. 16 259 – 16 261</p>
<p>OAL 85 – 120 mm</p> <p>Tapered 87° / Steel Cylindrical* / Steel</p>	
<p>Tapered 87° / Solid carbide Cylindrical* / Solid carbide</p>	
<p>OAL 150 – 200 mm</p> <p>Tapered 87° / Solid carbide Cylindrical* / Steel</p>	
<p>Cylindrical* / Solid carbide</p>	
<p>OAL 200 – 250 mm</p> <p>Cylindrical* / Steel</p>	
<p>Cylindrical* / Solid carbide</p>	
<p>* only conditionally suitable for milling</p>	

MultiChange – NC Spot Drill

- ▲ SZID = Coupling Size
- ▲ NOF = No. of cutting edges

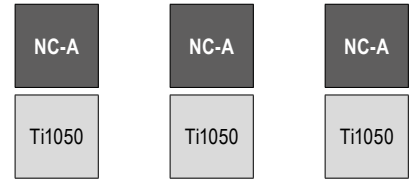
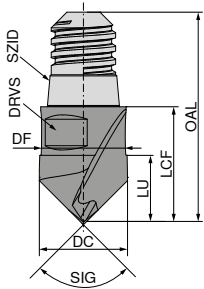

SIG 90° Solid carbide	SIG 120° Solid carbide	SIG 142° Solid carbide
10 709 ...	10 712 ...	10 714 ...
080	080	080
100	100	100
120	120	120
160	160	160
200	200	200

DC mm	SZID	LU mm	DF mm	LCF mm	OAL mm	NOF	DRVS mm	torque moment Nm	a _{p max} mm
8	06	6,0	7,8	11	20,4	2	6	5	4
10	08	7,5	9,8	13	26,9	2	8	12,5	5
12	10	9,0	11,8	16	30,1	2	10	15	6
16	12	12,0	15,8	20	37,3	2	13	20	8
20	16	15,0	19,8	25	47,2	2	16	25	10

P	●	●	●
M	●	●	●
K	●	●	●
N	●	●	●
S			
H			
O			

→ v. Page 148

Torque wrench should be used for coupling sizes 06 and 08
For unstable applications, the cutting data should be reduced.

Material examples for cutting data tables

	Material sub-group	Index	Composition / Structure / Heat treatment	Tensile strength N/mm ² / HB / HRC	Material number	Material designation	Material number	Material designation
P	Unalloyed steel	P.1.1	< 0,15 % C Annealed	420 N/mm ² / 125 HB	1.0401	C15	1.1141	Ck15
		P.1.2	< 0,45 % C Annealed	640 N/mm ² / 190 HB	1.1191	C45E	1.0718	9SMnPb28
		P.1.3	< 0,45 % C Tempered	840 N/mm ² / 250 HB	1.1191	C45E	1.0535	C55
		P.1.4	< 0,75 % C Annealed	910 N/mm ² / 270 HB	1.1223	C60R	1.0535	C55
		P.1.5	< 0,75 % C Tempered	1010 N/mm ² / 300 HB	1.1223	C60R	1.0727	45S20
	Low-alloy steel	P.2.1	Annealed	610 N/mm ² / 180 HB	1.7131	16MnCr5	1.6587	17CrNiMo6
		P.2.2	Tempered	930 N/mm ² / 275 HB	1.7131	16MnCr5	1.6587	17CrNiMo6
		P.2.3	Tempered	1010 N/mm ² / 300 HB	1.7225	42CrMo4	1.3505	100Cr6
		P.2.4	Tempered	1200 N/mm ² / 375 HB	1.7225	42CrMo4	1.3505	100Cr6
	High-alloy steel and high-alloy tool steel	P.3.1	Annealed	680 N/mm ² / 200 HB	1.4021	X20Cr13	1.4034	X46Cr13
		P.3.2	Hardened and tempered	1100 N/mm ² / 300 HB	1.2343	X38CrMoV5-1	1.4034	X46Cr13
		P.3.3	Hardened and tempered	1300 N/mm ² / 400 HB	1.2343	X38CrMoV5-1	1.4034	X46Cr13
	Stainless steel	P.4.1	Ferritic / martensitic Annealed	680 N/mm ² / 200 HB	1.4016	X6Cr17	1.2316	X36CrMo16
		P.4.2	Martensitic Tempered	1010 N/mm ² / 300 HB	1.4112	X90CrMoV18	1.2316	X36CrMo16
M	Stainless steel	M.1.1	Austenitic / austenitic-ferritic Quenched	610 N/mm ² / 180 HB	1.4301	X5CrNi18-10	1.4571	X6CrNiMoTi17-12-2
		M.2.1	Austenitic Tempered	300 HB	1.4841	X15CrNiSi25-21	1.4539	X1NiCrMoCu25-20-5
		M.3.1	Austenitic / ferritic (Duplex)	780 N/mm ² / 230 HB	1.4462	X2CrNiMoN22-5-3	1.4501	X2CrNiMoCuWN25-7-4
K	Grey cast iron	K.1.1	Pearlitic / ferritic	350 N/mm ² / 180 HB	0.6010	GG-10	0.6025	GG-25
		K.1.2	Pearlitic (martensitic)	500 N/mm ² / 260 HB	0.6030	GG-30	0.6045	GG-45
	Spherulitic graphite cast iron	K.2.1	Ferritic	540 N/mm ² / 160 HB	0.7040	GGG-40	0.7060	GGG-60
		K.2.2	Pearlitic	845 N/mm ² / 250 HB	0.7070	GGG-70	0.7080	GGG-80
	Malleable iron	K.3.1	Ferritic	440 N/mm ² / 130 HB	0.8035	GTW-35-04	0.8045	GTW-45
		K.3.2	Pearlitic	780 N/mm ² / 230 HB	0.8165	GTS-65-02	0.8170	GTS-70-02
N	Aluminium wrought alloy	N.1.1	Non-hardenable	60 HB	3.0255	Al99,5	3.3315	AlMg1
		N.1.2	Hardenable Age-hardened	340 N/mm ² / 100 HB	3.1355	AlCuMg2	3.2315	AlMgSi1
	Cast aluminium alloy	N.2.1	≤ 12 % Si, non-hardenable	250 N/mm ² / 75 HB	3.2581	G-AlSi12	3.2163	G-AlSi9Cu3
		N.2.2	≤ 12 % Si, hardenable Age-hardened	300 N/mm ² / 90 HB	3.2134	G-AlSi5Cu1Mg	3.2373	G-AlSi9Mg
		N.2.3	> 12 % Si, non-hardenable	440 N/mm ² / 130 HB		G-AlSi17Cu4Mg		G-AlSi18CuNiMg
	Copper and copper alloys (bronze/brass)	N.3.1	Free-machining alloys, PB > 1 %	375 N/mm ² / 110 HB	2.0380	CuZn39Pb2 (Ms58)	2.0410	CuZn44Pb2
		N.3.2	CuZn, CuSnZn	300 N/mm ² / 90 HB	2.0331	CuZn15	2.4070	CuZn28Sn1As
		N.3.3	CuSn, lead-free copper and electrolytic copper	340 N/mm ² / 100 HB	2.0060	E-Cu57	2.0590	CuZn40Fe
	Magnesium alloys	N.4.1	Magnesium and magnesium alloys	70 HB	3.5612	MgAl6Zn	3.5312	MgAl3Zn
	S	Heat-resistant alloys	S.1.1	Fe - basis Annealed	680 N/mm ² / 200 HB	1.4864	X12NiCrSi 36-16	1.4865
S.1.2			Fe - basis Age-hardened	950 N/mm ² / 280 HB	1.4980	X6NiCrTiMoVB25-15-2	1.4876	X10NiCrAlTi32-20
S.2.1			Ni or Co basis Annealed	840 N/mm ² / 250 HB	2.4631	NiCr20TiAl (Nimonic80A)	3.4856	NiCr22Mo9Nb
S.2.2			Ni or Co basis Age-hardened	1180 N/mm ² / 350 HB	2.4668	NiCr19Nb5Mo3 (Inconel 718)	2.4955	NiFe25Cr20NbTi
S.2.3			Ni or Co basis Cast	1080 N/mm ² / 320 HB	2.4765	CoCr20W15Ni	1.3401	G-X120Mn12
Titanium alloys		S.3.1	Pure titanium	400 N/mm ²	3.7025	Ti99,8	3.7034	Ti99,7
		S.3.2	Alpha + beta alloys Age-hardened	1050 N/mm ² / 320 HB	3.7165	TiAl6V4	Ti-6246	Ti-6Al-2Sn-4Zr-6Mo
		S.3.3	Beta alloys	1400 N/mm ² / 410 HB	Ti555.3	Ti-5Al-5V-5Mo-3Cr	R56410	Ti-10V-2Fe-3Al
H	Hardened steel	H.1.1	Hardened and tempered	46–55 HRC				
		H.1.2	Hardened and tempered	56–60 HRC				
		H.1.3	Hardened and tempered	61–65 HRC				
		H.1.4	Hardened and tempered	66–70 HRC				
	Chilled iron	H.2.1	Cast	400 HB				
Hardened cast iron	H.3.1	Hardened and tempered	55 HRC					
O	Non-metal materials	O.1.1	Plastics, duroplastic	≤ 150 N/mm ²				
		O.1.2	Plastics, thermoplastic	≤ 100 N/mm ²				
		O.2.1	Aramid fibre-reinforced	≤ 1000 N/mm ²				
		O.2.2	Glass/carbon-fibre reinforced	≤ 1000 N/mm ²				
		O.3.1	Graphite					

* Tensile strength

Cutting data standard values – WTX – Ti

Index	10 786 ..., 10 787 ...											
	3xD / 5xD											
	with through coolant v _c (m/min)	> Ø 2,5-3	> Ø 3-4	> Ø 4-5	> Ø 5-6	> Ø 6-8	> Ø 8-10	> Ø 10-12	> Ø 12-14	> Ø 14-16	> Ø 16-18	> Ø 18-20
	f (mm/rev)											
P.1.1												
P.1.2	130	0,08	0,10	0,13	0,15	0,18	0,20	0,23	0,26	0,30	0,34	0,38
P.1.3	130	0,08	0,10	0,13	0,15	0,18	0,20	0,23	0,26	0,30	0,34	0,38
P.1.4	115	0,08	0,10	0,13	0,15	0,18	0,20	0,23	0,26	0,30	0,34	0,38
P.1.5	115	0,08	0,10	0,13	0,15	0,18	0,20	0,23	0,26	0,30	0,34	0,38
P.2.1												
P.2.2												
P.2.3	115	0,08	0,10	0,13	0,15	0,18	0,20	0,23	0,26	0,30	0,34	0,38
P.2.4	90	0,08	0,10	0,13	0,15	0,18	0,20	0,23	0,26	0,30	0,34	0,38
P.3.1												
P.3.2												
P.3.3	55	0,08	0,10	0,13	0,15	0,18	0,20	0,23	0,26	0,30	0,34	0,38
P.4.1	75	0,05	0,06	0,08	0,10	0,12	0,14	0,15	0,18	0,20	0,23	0,25
P.4.2	65	0,05	0,06	0,08	0,10	0,12	0,14	0,15	0,18	0,20	0,23	0,25
M.1.1	70	0,05	0,06	0,08	0,10	0,12	0,14	0,15	0,18	0,20	0,23	0,25
M.2.1	70	0,05	0,06	0,08	0,10	0,12	0,14	0,15	0,18	0,20	0,23	0,25
M.3.1	70	0,05	0,06	0,08	0,10	0,12	0,14	0,15	0,18	0,20	0,23	0,25
K.1.1												
K.1.2												
K.2.1												
K.2.2												
K.3.1												
K.3.2												
N.1.1												
N.1.2												
N.2.1												
N.2.2												
N.2.3												
N.3.1												
N.3.2												
N.3.3												
N.4.1												
S.1.1	45	0,02	0,04	0,05	0,07	0,09	0,11	0,13	0,16	0,18	0,20	0,22
S.1.2	45	0,02	0,04	0,05	0,07	0,09	0,11	0,13	0,16	0,18	0,20	0,22
S.2.1	40	0,02	0,04	0,05	0,07	0,09	0,11	0,13	0,16	0,18	0,20	0,22
S.2.2	40	0,02	0,04	0,05	0,07	0,09	0,11	0,13	0,16	0,18	0,20	0,22
S.2.3	40	0,02	0,04	0,05	0,07	0,09	0,11	0,13	0,16	0,18	0,20	0,22
S.3.1	55	0,02	0,04	0,05	0,07	0,09	0,11	0,13	0,16	0,18	0,20	0,22
S.3.2	45	0,02	0,04	0,05	0,07	0,09	0,11	0,13	0,16	0,18	0,20	0,22
S.3.3												
H.1.1												
H.1.2												
H.1.3												
H.1.4												
H.2.1												
H.3.1												
O.1.1												
O.1.2												
O.2.1												
O.2.2												
O.3.1												



The cutting data depends extremely on the external conditions, the material and machine type.
The indicated values are possible values which have to be increased or reduced according to the application conditions.

Cutting data standard values – WTX – UNI

Index	11 776 ..., 11 777 ..., 11 778 ..., 11 779 ..., 11 780 ..., 11 781 ...							
			3xD					
	without through coolant	with through coolant	Ø 3–5	Ø 5–8	Ø 8–12	Ø 12–16	Ø 16–20	Ø 20–25
	v _c (m/min)		f (mm/rev)					
P.1.1	110	120	0,13	0,18	0,25	0,30	0,34	0,37
P.1.2	105	115	0,12	0,18	0,24	0,29	0,33	0,36
P.1.3	100	110	0,12	0,17	0,23	0,28	0,31	0,34
P.1.4	95	105	0,11	0,16	0,21	0,26	0,30	0,32
P.1.5	90	100	0,11	0,15	0,20	0,25	0,28	0,30
P.2.1	105	120	0,15	0,22	0,29	0,36	0,41	0,44
P.2.2	95	110	0,14	0,20	0,27	0,33	0,37	0,40
P.2.3	85	100	0,13	0,18	0,24	0,29	0,33	0,36
P.2.4	65	75	0,12	0,16	0,21	0,26	0,29	0,32
P.3.1	70	85	0,12	0,18	0,24	0,29	0,33	0,36
P.3.2	60	65	0,11	0,15	0,20	0,24	0,27	0,29
P.3.3	50	65	0,09	0,12	0,15	0,19	0,21	0,23
P.4.1	50	65	0,08	0,12	0,16	0,19	0,22	0,24
P.4.2	50	65	0,08	0,12	0,16	0,19	0,22	0,24
M.1.1								
M.2.1								
M.3.1								
K.1.1	85	120	0,17	0,26	0,36	0,45	0,52	0,56
K.1.2	75	100	0,15	0,22	0,29	0,36	0,41	0,45
K.2.1	100	160	0,17	0,25	0,34	0,42	0,48	0,52
K.2.2	75	100	0,15	0,22	0,29	0,36	0,41	0,45
K.3.1	80	90	0,16	0,23	0,32	0,39	0,44	0,48
K.3.2	70	80	0,14	0,19	0,25	0,31	0,35	0,38
N.1.1								
N.1.2								
N.2.1								
N.2.2								
N.2.3								
N.3.1								
N.3.2								
N.3.3								
N.4.1								
S.1.1								
S.1.2								
S.2.1								
S.2.2								
S.2.3								
S.3.1								
S.3.2								
S.3.3								
H.1.1	25	25	0,06	0,08	0,11	0,14	0,15	0,17
H.1.2								
H.1.3								
H.1.4								
H.2.1	35	35	0,08	0,11	0,14	0,18	0,20	0,22
H.3.1								
O.1.1								
O.1.2								
O.2.1								
O.2.2								
O.3.1								



The cutting data depends extremely on the external conditions, the material and machine type.
The indicated values are possible values which have to be increased or reduced according to the application conditions.

Index	11 782 ..., 11 783 ..., 11 784 ..., 11 785 ..., 11 786 ..., 11 787 ...									11 788 ..., 11 789 ..., 11 790 ...						
			5xD									8xD				
	without coolant	with coolant	Ø 3-5	Ø 5-8	Ø 8-12	Ø 12-16	Ø 16-20	Ø 20-25	with coolant	Ø 3-5	Ø 5-8	Ø 8-12	Ø 12-16	Ø 16-20		
	v _c (m/min)		f (mm/rev)							v _c (m/min)		f (mm/rev)				
P.1.1	110	120	0,13	0,18	0,25	0,30	0,34	0,37	110	0,13	0,18	0,25	0,30	0,34		
P.1.2	105	115	0,12	0,18	0,24	0,29	0,33	0,36	105	0,12	0,18	0,24	0,29	0,33		
P.1.3	100	110	0,12	0,17	0,23	0,28	0,31	0,34	100	0,12	0,17	0,23	0,28	0,31		
P.1.4	95	105	0,11	0,16	0,21	0,26	0,30	0,32	95	0,11	0,16	0,21	0,26	0,30		
P.1.5	90	100	0,11	0,15	0,20	0,25	0,28	0,30	90	0,11	0,15	0,20	0,25	0,28		
P.2.1	105	120	0,15	0,22	0,29	0,36	0,41	0,44	105	0,15	0,22	0,29	0,36	0,41		
P.2.2	95	110	0,14	0,20	0,27	0,33	0,37	0,40	95	0,14	0,20	0,27	0,33	0,37		
P.2.3	85	100	0,13	0,18	0,24	0,29	0,33	0,36	85	0,13	0,18	0,24	0,29	0,33		
P.2.4	65	75	0,12	0,16	0,21	0,26	0,29	0,32	65	0,12	0,16	0,21	0,26	0,29		
P.3.1	70	85	0,12	0,18	0,24	0,29	0,33	0,36	70	0,12	0,18	0,24	0,29	0,33		
P.3.2	60	65	0,11	0,15	0,20	0,24	0,27	0,29	60	0,11	0,15	0,20	0,24	0,27		
P.3.3	50	65	0,09	0,12	0,15	0,19	0,21	0,23	50	0,09	0,12	0,15	0,19	0,21		
P.4.1	50	65	0,08	0,12	0,16	0,19	0,22	0,24	50	0,08	0,12	0,16	0,19	0,22		
P.4.2	50	65	0,08	0,12	0,16	0,19	0,22	0,24	50	0,08	0,12	0,16	0,19	0,22		
M.1.1																
M.2.1																
M.3.1																
K.1.1	85	120	0,17	0,26	0,36	0,45	0,52	0,56	85	0,17	0,26	0,36	0,45	0,52		
K.1.2	75	100	0,15	0,22	0,29	0,36	0,41	0,45	75	0,15	0,22	0,29	0,36	0,41		
K.2.1	100	160	0,17	0,25	0,34	0,42	0,48	0,52	100	0,17	0,25	0,34	0,42	0,48		
K.2.2	75	100	0,15	0,22	0,29	0,36	0,41	0,45	75	0,15	0,22	0,29	0,36	0,41		
K.3.1	80	90	0,16	0,23	0,32	0,39	0,44	0,48	80	0,16	0,23	0,32	0,39	0,44		
K.3.2	70	80	0,14	0,19	0,25	0,31	0,35	0,38	70	0,14	0,19	0,25	0,31	0,35		
N.1.1																
N.1.2																
N.2.1																
N.2.2																
N.2.3																
N.3.1																
N.3.2																
N.3.3																
N.4.1																
S.1.1																
S.1.2																
S.2.1																
S.2.2																
S.2.3																
S.3.1																
S.3.2																
S.3.3																
H.1.1	25	25	0,06	0,08	0,11	0,14	0,15	0,17	25	0,06	0,08	0,11	0,14	0,15		
H.1.2																
H.1.3																
H.1.4																
H.2.1	35	35	0,08	0,11	0,14	0,18	0,20	0,22	35	0,08	0,11	0,14	0,18	0,20		
H.3.1																
O.1.1																
O.1.2																
O.2.1																
O.2.2																
O.3.1																

Cutting data standard values – WTX – VA

Index	10 731 ..., 10 734 ...							10 740 ..., 10 745 ...						
			3xD							5xD				
	without through coolant	with through coolant	Ø 2-5	Ø 5-8	Ø 8-12	Ø 12-16	Ø 16-20	without through coolant	with through coolant	Ø 2-5	Ø 5-8	Ø 8-12	Ø 12-16	Ø 16-20
	v _c (m/min)		f (mm/rev)					v _c (m/min)		f (mm/rev)				
P.1.1	100	110	0,09	0,13	0,18	0,22	0,25	100	110	0,09	0,13	0,18	0,22	0,25
P.1.2	95	105	0,09	0,13	0,17	0,21	0,24	95	105	0,09	0,13	0,17	0,21	0,24
P.1.3	90	100	0,09	0,12	0,16	0,20	0,23	90	100	0,09	0,12	0,16	0,20	0,23
P.1.4	85	95	0,08	0,12	0,16	0,19	0,22	85	95	0,08	0,12	0,16	0,19	0,22
P.1.5	80	90	0,08	0,11	0,15	0,18	0,20	80	90	0,08	0,11	0,15	0,18	0,20
P.2.1	95	110	0,11	0,16	0,21	0,26	0,29	95	110	0,11	0,16	0,21	0,26	0,29
P.2.2	85	100	0,10	0,14	0,19	0,24	0,27	85	100	0,10	0,14	0,19	0,24	0,27
P.2.3	75	90	0,09	0,13	0,17	0,21	0,24	75	90	0,09	0,13	0,17	0,21	0,24
P.2.4	60	70	0,09	0,12	0,16	0,19	0,21	60	70	0,09	0,12	0,16	0,19	0,21
P.3.1	65	75	0,09	0,13	0,17	0,21	0,24	65	75	0,09	0,13	0,17	0,21	0,24
P.3.2	55	60	0,08	0,11	0,14	0,17	0,20	55	60	0,08	0,11	0,14	0,17	0,20
P.3.3	45	60	0,06	0,09	0,11	0,14	0,15	45	60	0,06	0,09	0,11	0,14	0,15
P.4.1	45	60	0,06	0,09	0,11	0,14	0,16	45	60	0,06	0,09	0,11	0,14	0,16
P.4.2	45	60	0,06	0,09	0,11	0,14	0,16	45	60	0,06	0,09	0,11	0,14	0,16
M.1.1	35	55	0,08	0,11	0,14	0,18	0,20	35	55	0,08	0,11	0,14	0,18	0,20
M.2.1	30	50	0,06	0,09	0,12	0,15	0,17	30	50	0,06	0,09	0,12	0,15	0,17
M.3.1	30	50	0,06	0,09	0,12	0,15	0,17	30	50	0,06	0,09	0,12	0,15	0,17
K.1.1	85	120	0,15	0,24	0,33	0,41	0,47	85	120	0,15	0,24	0,33	0,41	0,47
K.1.2	75	100	0,14	0,20	0,27	0,33	0,37	75	100	0,14	0,20	0,27	0,33	0,37
K.2.1	100	160	0,15	0,22	0,31	0,38	0,43	100	160	0,15	0,22	0,31	0,38	0,43
K.2.2	75	100	0,14	0,20	0,27	0,33	0,37	75	100	0,14	0,20	0,27	0,33	0,37
K.3.1	80	90	0,15	0,21	0,29	0,35	0,40	80	90	0,15	0,21	0,29	0,35	0,40
K.3.2	70	80	0,12	0,17	0,23	0,28	0,32	70	80	0,12	0,17	0,23	0,28	0,32
N.1.1	220	330	0,10	0,16	0,22	0,30	0,33	220	330	0,10	0,16	0,22	0,30	0,33
N.1.2	200	300	0,09	0,12	0,20	0,25	0,30	200	300	0,09	0,12	0,20	0,25	0,30
N.2.1	180	250	0,11	0,15	0,26	0,33	0,39	180	250	0,11	0,15	0,26	0,33	0,39
N.2.2	150	220	0,11	0,15	0,26	0,33	0,39	150	220	0,11	0,15	0,26	0,33	0,39
N.2.3	120	180	0,11	0,15	0,26	0,33	0,39	120	180	0,11	0,15	0,26	0,33	0,39
N.3.1	160	200	0,15	0,24	0,33	0,41	0,47	160	200	0,15	0,24	0,33	0,41	0,47
N.3.2	90	120	0,14	0,20	0,27	0,33	0,37	90	120	0,14	0,20	0,27	0,33	0,37
N.3.3	100	140	0,12	0,15	0,21	0,25	0,28	100	140	0,12	0,15	0,21	0,25	0,28
N.4.1														
S.1.1	20	30	0,06	0,09	0,11	0,14	0,16	20	30	0,06	0,09	0,11	0,14	0,16
S.1.2	15	20	0,04	0,06	0,08	0,10	0,11	15	20	0,04	0,06	0,08	0,10	0,11
S.2.1	15	20	0,04	0,06	0,08	0,10	0,11	15	20	0,04	0,06	0,08	0,10	0,11
S.2.2	10	15	0,05	0,08	0,10	0,13	0,14	10	15	0,05	0,08	0,10	0,13	0,14
S.2.3	10	15	0,04	0,06	0,08	0,10	0,11	10	15	0,04	0,06	0,08	0,10	0,11
S.3.1														
S.3.2	20	30	0,06	0,09	0,12	0,15	0,17	20	30	0,06	0,09	0,12	0,15	0,17
S.3.3	15	25	0,05	0,08	0,10	0,13	0,14	15	25	0,05	0,08	0,10	0,13	0,14
H.1.1														
H.1.2														
H.1.3														
H.1.4														
H.2.1														
H.3.1														
O.1.1														
O.1.2														
O.2.1														
O.2.2														
O.3.1														

 The cutting data depends extremely on the external conditions, the material and machine type.
The indicated values are possible values which have to be increased or reduced according to the application conditions.

Index	10 770 ...					
	with through coolant v _c (m/min)	8xD				
		Ø 3-5	Ø 5-8	Ø 8-12	Ø 12-16	Ø 16-20
		f (mm/rev)				
P.1.1	110	0,09	0,13	0,18	0,22	0,25
P.1.2	105	0,09	0,13	0,17	0,21	0,24
P.1.3	100	0,09	0,12	0,16	0,20	0,23
P.1.4	95	0,08	0,12	0,16	0,19	0,22
P.1.5	90	0,08	0,11	0,15	0,18	0,20
P.2.1	110	0,11	0,16	0,21	0,26	0,29
P.2.2	100	0,10	0,14	0,19	0,24	0,27
P.2.3	90	0,09	0,13	0,17	0,21	0,24
P.2.4	70	0,09	0,12	0,16	0,19	0,21
P.3.1	75	0,09	0,13	0,17	0,21	0,24
P.3.2	60	0,08	0,11	0,14	0,17	0,20
P.3.3	60	0,06	0,09	0,11	0,14	0,15
P.4.1	60	0,06	0,09	0,11	0,14	0,16
P.4.2	60	0,06	0,09	0,11	0,14	0,16
M.1.1	55	0,08	0,11	0,14	0,18	0,20
M.2.1	50	0,06	0,09	0,12	0,15	0,17
M.3.1	50	0,06	0,09	0,12	0,15	0,17
K.1.1	120	0,15	0,24	0,33	0,41	0,47
K.1.2	100	0,14	0,20	0,27	0,33	0,37
K.2.1	160	0,15	0,22	0,31	0,38	0,43
K.2.2	100	0,14	0,20	0,27	0,33	0,37
K.3.1	90	0,15	0,21	0,29	0,35	0,40
K.3.2	80	0,12	0,17	0,23	0,28	0,32
N.1.1	330	0,10	0,16	0,22	0,30	0,33
N.1.2	300	0,09	0,12	0,20	0,25	0,30
N.2.1	250	0,11	0,15	0,26	0,33	0,39
N.2.2	220	0,11	0,15	0,26	0,33	0,39
N.2.3	180	0,11	0,15	0,26	0,33	0,39
N.3.1	200	0,15	0,24	0,33	0,41	0,47
N.3.2	120	0,14	0,20	0,27	0,33	0,37
N.3.3	140	0,12	0,15	0,21	0,25	0,28
N.4.1						
S.1.1	30	0,06	0,09	0,11	0,14	0,16
S.1.2	20	0,04	0,06	0,08	0,10	0,11
S.2.1	20	0,04	0,06	0,08	0,10	0,11
S.2.2	15	0,05	0,08	0,10	0,13	0,14
S.2.3	15	0,04	0,06	0,08	0,10	0,11
S.3.1						
S.3.2	30	0,06	0,09	0,12	0,15	0,17
S.3.3	25	0,05	0,08	0,10	0,13	0,14
H.1.1						
H.1.2						
H.1.3						
H.1.4						
H.2.1						
H.3.1						
O.1.1						
O.1.2						
O.2.1						
O.2.2						
O.3.1						

Cutting data standard values – WTX – Speed UNI

Index	10 781 ...						10 771 ...					
	with through coolant v _c (m/min)	3xD					with through coolant v _c (m/min)	5xD				
		Ø 3–5	Ø 5–8	Ø 8–12	Ø 12–16	Ø 16–20		Ø 3–5	Ø 5–8	Ø 8–12	Ø 12–16	Ø 16–20
		f (mm/rev)						f (mm/rev)				
P.1.1	185	0,17	0,24	0,33	0,40	0,45	185	0,17	0,24	0,33	0,40	0,45
P.1.2	180	0,16	0,23	0,31	0,38	0,43	180	0,16	0,23	0,31	0,38	0,43
P.1.3	170	0,16	0,22	0,30	0,36	0,41	170	0,16	0,22	0,30	0,36	0,41
P.1.4	160	0,15	0,21	0,28	0,35	0,39	160	0,15	0,21	0,28	0,35	0,39
P.1.5	155	0,14	0,20	0,27	0,33	0,37	155	0,14	0,20	0,27	0,33	0,37
P.2.1	185	0,20	0,29	0,39	0,47	0,53	185	0,20	0,29	0,39	0,47	0,53
P.2.2	170	0,18	0,26	0,35	0,43	0,49	170	0,18	0,26	0,35	0,43	0,49
P.2.3	155	0,17	0,24	0,32	0,39	0,44	155	0,17	0,24	0,32	0,39	0,44
P.2.4	120	0,16	0,21	0,28	0,34	0,38	120	0,16	0,21	0,28	0,34	0,38
P.3.1	130	0,16	0,23	0,32	0,39	0,44	130	0,16	0,23	0,32	0,39	0,44
P.3.2	100	0,14	0,20	0,26	0,32	0,36	100	0,14	0,20	0,26	0,32	0,36
P.3.3	100	0,12	0,16	0,20	0,25	0,28	100	0,12	0,16	0,20	0,25	0,28
P.4.1	100	0,11	0,16	0,21	0,25	0,29	100	0,11	0,16	0,21	0,25	0,29
P.4.2	100	0,11	0,16	0,21	0,25	0,29	100	0,11	0,16	0,21	0,25	0,29
M.1.1	65	0,08	0,12	0,16	0,19	0,22	65	0,08	0,12	0,16	0,19	0,22
M.2.1	60	0,07	0,10	0,14	0,17	0,19	60	0,07	0,10	0,14	0,17	0,19
M.3.1	60	0,07	0,10	0,14	0,17	0,19	60	0,07	0,10	0,14	0,17	0,19
K.1.1	150	0,18	0,28	0,40	0,49	0,56	150	0,18	0,28	0,40	0,49	0,56
K.1.2	125	0,16	0,24	0,32	0,39	0,45	125	0,16	0,24	0,32	0,39	0,45
K.2.1	200	0,18	0,27	0,37	0,46	0,52	200	0,18	0,27	0,37	0,46	0,52
K.2.2	125	0,16	0,24	0,32	0,39	0,45	125	0,16	0,24	0,32	0,39	0,45
K.3.1	115	0,18	0,25	0,34	0,42	0,48	115	0,18	0,25	0,34	0,42	0,48
K.3.2	100	0,15	0,21	0,28	0,34	0,38	100	0,15	0,21	0,28	0,34	0,38
N.1.1												
N.1.2												
N.2.1												
N.2.2												
N.2.3												
N.3.1												
N.3.2												
N.3.3												
N.4.1												
S.1.1												
S.1.2												
S.2.1												
S.2.2												
S.2.3												
S.3.1												
S.3.2												
S.3.3												
H.1.1												
H.1.2												
H.1.3												
H.1.4												
H.2.1												
H.3.1												
O.1.1												
O.1.2												
O.2.1												
O.2.2												
O.3.1												



The cutting data depends extremely on the external conditions, the material and machine type.
The indicated values are possible values which have to be increased or reduced according to the application conditions.

Index	10 782 ...						
	8xD						
	with through coolant v _c (m/min)	Ø 3-5	Ø 5-8	Ø 8-12	Ø 12-16	Ø 16-20	
	f (mm/rev)						
P.1.1	185	0,17	0,24	0,33	0,40	0,45	
P.1.2	180	0,16	0,23	0,31	0,38	0,43	
P.1.3	170	0,16	0,22	0,30	0,36	0,41	
P.1.4	160	0,15	0,21	0,28	0,35	0,39	
P.1.5	155	0,14	0,20	0,27	0,33	0,37	
P.2.1	185	0,20	0,29	0,39	0,47	0,53	
P.2.2	170	0,18	0,26	0,35	0,43	0,49	
P.2.3	155	0,17	0,24	0,32	0,39	0,44	
P.2.4	120	0,16	0,21	0,28	0,34	0,38	
P.3.1	130	0,16	0,23	0,32	0,39	0,44	
P.3.2	100	0,14	0,20	0,26	0,32	0,36	
P.3.3	100	0,12	0,16	0,20	0,25	0,28	
P.4.1	100	0,11	0,16	0,21	0,25	0,29	
P.4.2	100	0,11	0,16	0,21	0,25	0,29	
M.1.1	65	0,08	0,12	0,16	0,19	0,22	
M.2.1	60	0,07	0,10	0,14	0,17	0,19	
M.3.1	60	0,07	0,10	0,14	0,17	0,19	
K.1.1	150	0,18	0,28	0,40	0,49	0,56	
K.1.2	125	0,16	0,24	0,32	0,39	0,45	
K.2.1	200	0,18	0,27	0,37	0,46	0,52	
K.2.2	125	0,16	0,24	0,32	0,39	0,45	
K.3.1	115	0,18	0,25	0,34	0,42	0,48	
K.3.2	100	0,15	0,21	0,28	0,34	0,38	
N.1.1							
N.1.2							
N.2.1							
N.2.2							
N.2.3							
N.3.1							
N.3.2							
N.3.3							
N.4.1							
S.1.1							
S.1.2							
S.2.1							
S.2.2							
S.2.3							
S.3.1							
S.3.2							
S.3.3							
H.1.1							
H.1.2							
H.1.3							
H.1.4							
H.2.1							
H.3.1							
O.1.1							
O.1.2							
O.2.1							
O.2.2							
O.3.1							

Cutting data standard values – WTX – Feed UNI

Index	10 789 ...								
	with through coolant v _c (m/min)	5xD							
		Ø 4–6	Ø 6–7	Ø 7–8	Ø 8–10	Ø 10–12	Ø 12–15	Ø 15–17	Ø 17–20
f (mm/rev)									
P.1.1	125	0,28	0,34	0,37	0,42	0,48	0,54	0,59	0,63
P.1.2	120	0,27	0,32	0,35	0,40	0,46	0,52	0,56	0,60
P.1.3	115	0,25	0,31	0,34	0,38	0,44	0,49	0,54	0,57
P.1.4	110	0,24	0,29	0,32	0,36	0,41	0,47	0,51	0,54
P.1.5	105	0,23	0,27	0,30	0,34	0,39	0,44	0,48	0,52
P.2.1	125	0,33	0,40	0,44	0,50	0,57	0,64	0,70	0,75
P.2.2	115	0,30	0,36	0,40	0,45	0,51	0,58	0,63	0,68
P.2.3	105	0,27	0,32	0,36	0,41	0,46	0,52	0,57	0,61
P.2.4	80	0,25	0,29	0,32	0,36	0,41	0,46	0,50	0,54
P.3.1	85	0,27	0,32	0,36	0,41	0,46	0,52	0,57	0,61
P.3.2	70	0,23	0,27	0,30	0,33	0,38	0,43	0,47	0,50
P.3.3	70	0,18	0,22	0,24	0,26	0,30	0,33	0,36	0,38
P.4.1	70	0,18	0,21	0,24	0,27	0,30	0,34	0,38	0,40
P.4.2	70	0,18	0,21	0,24	0,27	0,30	0,34	0,38	0,40
M.1.1	55	0,13	0,16	0,18	0,20	0,23	0,26	0,28	0,30
M.2.1	50	0,11	0,14	0,15	0,17	0,20	0,22	0,24	0,26
M.3.1	50	0,11	0,14	0,15	0,17	0,20	0,22	0,24	0,26
K.1.1	140	0,38	0,47	0,53	0,61	0,70	0,80	0,89	0,95
K.1.2	115	0,32	0,39	0,44	0,50	0,57	0,64	0,70	0,75
K.2.1	185	0,37	0,45	0,50	0,57	0,66	0,75	0,82	0,88
K.2.2	115	0,32	0,39	0,44	0,50	0,57	0,64	0,70	0,75
K.3.1	105	0,35	0,42	0,47	0,53	0,61	0,69	0,76	0,81
K.3.2	90	0,29	0,35	0,38	0,43	0,49	0,55	0,60	0,64
N.1.1	380	0,28	0,34	0,37	0,42	0,48	0,54	0,59	0,63
N.1.2	345	0,25	0,31	0,34	0,38	0,44	0,49	0,54	0,57
N.2.1	290	0,32	0,39	0,44	0,50	0,57	0,64	0,70	0,75
N.2.2	255	0,32	0,39	0,44	0,50	0,57	0,64	0,70	0,75
N.2.3	205	0,32	0,39	0,44	0,50	0,57	0,64	0,70	0,75
N.3.1	230	0,38	0,47	0,53	0,61	0,70	0,80	0,89	0,95
N.3.2	140	0,24	0,29	0,33	0,37	0,43	0,48	0,53	0,57
N.3.3									
N.4.1									
S.1.1									
S.1.2									
S.2.1									
S.2.2									
S.2.3									
S.3.1									
S.3.2									
S.3.3									
H.1.1									
H.1.2									
H.1.3									
H.1.4									
H.2.1									
H.3.1									
O.1.1									
O.1.2									
O.2.1									
O.2.2									
O.3.1									

 The cutting data depends extremely on the external conditions, the material and machine type.
The indicated values are possible values which have to be increased or reduced according to the application conditions.

Index	10 794 ..., 10 796 ...									
	8xD / 12xD									
	with through coolant v _c (m/min)	Ø 4-6	Ø 6-7	Ø 7-8	Ø 8-10	Ø 10-12	Ø 12-15	Ø 15-17	Ø 17-20	
	f (mm/rev)									
P.1.1	125	0,28	0,34	0,37	0,42	0,48	0,54	0,59	0,63	
P.1.2	120	0,27	0,32	0,35	0,40	0,46	0,52	0,56	0,60	
P.1.3	115	0,25	0,31	0,34	0,38	0,44	0,49	0,54	0,57	
P.1.4	110	0,24	0,29	0,32	0,36	0,41	0,47	0,51	0,54	
P.1.5	105	0,23	0,27	0,30	0,34	0,39	0,44	0,48	0,52	
P.2.1	125	0,33	0,40	0,44	0,50	0,57	0,64	0,70	0,75	
P.2.2	115	0,30	0,36	0,40	0,45	0,51	0,58	0,63	0,68	
P.2.3	105	0,27	0,32	0,36	0,41	0,46	0,52	0,57	0,61	
P.2.4	80	0,25	0,29	0,32	0,36	0,41	0,46	0,50	0,54	
P.3.1	85	0,27	0,32	0,36	0,41	0,46	0,52	0,57	0,61	
P.3.2	70	0,23	0,27	0,30	0,33	0,38	0,43	0,47	0,50	
P.3.3	70	0,18	0,22	0,24	0,26	0,30	0,33	0,36	0,38	
P.4.1	70	0,18	0,21	0,24	0,27	0,30	0,34	0,38	0,40	
P.4.2	70	0,18	0,21	0,24	0,27	0,30	0,34	0,38	0,40	
M.1.1	55	0,13	0,16	0,18	0,20	0,23	0,26	0,28	0,30	
M.2.1	50	0,11	0,14	0,15	0,17	0,20	0,22	0,24	0,26	
M.3.1	50	0,11	0,14	0,15	0,17	0,20	0,22	0,24	0,26	
K.1.1	140	0,38	0,47	0,53	0,61	0,70	0,80	0,89	0,95	
K.1.2	115	0,32	0,39	0,44	0,50	0,57	0,64	0,70	0,75	
K.2.1	185	0,37	0,45	0,50	0,57	0,66	0,75	0,82	0,88	
K.2.2	115	0,32	0,39	0,44	0,50	0,57	0,64	0,70	0,75	
K.3.1	105	0,35	0,42	0,47	0,53	0,61	0,69	0,76	0,81	
K.3.2	90	0,29	0,35	0,38	0,43	0,49	0,55	0,60	0,64	
N.1.1	380	0,28	0,34	0,37	0,42	0,48	0,54	0,59	0,63	
N.1.2	345	0,25	0,31	0,34	0,38	0,44	0,49	0,54	0,57	
N.2.1	290	0,32	0,39	0,44	0,50	0,57	0,64	0,70	0,75	
N.2.2	255	0,32	0,39	0,44	0,50	0,57	0,64	0,70	0,75	
N.2.3	205	0,32	0,39	0,44	0,50	0,57	0,64	0,70	0,75	
N.3.1	230	0,38	0,47	0,53	0,61	0,70	0,80	0,89	0,95	
N.3.2	140	0,24	0,29	0,33	0,37	0,43	0,48	0,53	0,57	
N.3.3										
N.4.1										
S.1.1										
S.1.2										
S.2.1										
S.2.2										
S.2.3										
S.3.1										
S.3.2										
S.3.3										
H.1.1										
H.1.2										
H.1.3										
H.1.4										
H.2.1										
H.3.1										
O.1.1										
O.1.2										
O.2.1										
O.2.2										
O.3.1										

Cutting data standard values – WTX – Speed VA

Index	10 773 ...						10 774 ...					
	with through coolant v_c (m/min)	5xD					with through coolant v_c (m/min)	12xD				
		Ø 3–5	Ø 5–8	Ø 8–12	Ø 12–16	Ø 16–20		Ø 3–5	Ø 5–8	Ø 8–12	Ø 12–16	Ø 16–20
		f (mm/rev)						f (mm/rev)				
P.1.1	165	0,12	0,17	0,23	0,28	0,31	110	0,09	0,13	0,18	0,22	0,25
P.1.2	160	0,11	0,16	0,22	0,26	0,30	105	0,09	0,13	0,17	0,21	0,24
P.1.3	150	0,11	0,15	0,20	0,25	0,28	100	0,09	0,12	0,16	0,20	0,23
P.1.4	145	0,10	0,15	0,19	0,24	0,27	95	0,08	0,12	0,16	0,19	0,22
P.1.5	135	0,10	0,14	0,18	0,23	0,26	90	0,08	0,11	0,15	0,18	0,20
P.2.1	165	0,14	0,20	0,27	0,33	0,37	110	0,11	0,16	0,21	0,26	0,29
P.2.2	150	0,13	0,18	0,24	0,30	0,34	100	0,10	0,14	0,19	0,24	0,27
P.2.3	135	0,11	0,16	0,22	0,27	0,30	90	0,09	0,13	0,17	0,21	0,24
P.2.4	105	0,11	0,15	0,19	0,24	0,27	70	0,09	0,12	0,16	0,19	0,21
P.3.1	115	0,11	0,16	0,22	0,27	0,30	75	0,09	0,13	0,17	0,21	0,24
P.3.2	90	0,10	0,13	0,18	0,22	0,25	60	0,08	0,11	0,14	0,17	0,20
P.3.3	90	0,08	0,11	0,14	0,17	0,19	60	0,06	0,09	0,11	0,14	0,15
P.4.1	70	0,08	0,11	0,14	0,18	0,20	60	0,06	0,09	0,11	0,14	0,16
P.4.2	70	0,08	0,11	0,14	0,18	0,20	60	0,06	0,09	0,11	0,14	0,16
M.1.1	80	0,09	0,13	0,18	0,22	0,25	55	0,08	0,11	0,14	0,18	0,20
M.2.1	75	0,08	0,11	0,15	0,19	0,21	50	0,06	0,09	0,12	0,15	0,17
M.3.1	75	0,08	0,11	0,15	0,19	0,21	50	0,06	0,09	0,12	0,15	0,17
K.1.1	150	0,15	0,24	0,33	0,41	0,47	120	0,15	0,24	0,33	0,41	0,47
K.1.2	125	0,14	0,20	0,27	0,33	0,37	100	0,14	0,20	0,27	0,33	0,37
K.2.1	200	0,15	0,22	0,31	0,38	0,43	160	0,15	0,22	0,31	0,38	0,43
K.2.2	125	0,14	0,20	0,27	0,33	0,37	100	0,14	0,20	0,27	0,33	0,37
K.3.1	115	0,15	0,21	0,29	0,35	0,40	90	0,15	0,21	0,29	0,35	0,40
K.3.2	100	0,12	0,17	0,23	0,28	0,32	80	0,12	0,17	0,23	0,28	0,32
N.1.1												
N.1.2												
N.2.1												
N.2.2												
N.2.3												
N.3.1							200	0,15	0,24	0,33	0,41	0,47
N.3.2	145	0,14	0,20	0,27	0,33	0,37	120	0,14	0,20	0,27	0,33	0,37
N.3.3												
N.4.1												
S.1.1	35	0,07	0,10	0,14	0,17	0,19	30	0,06	0,09	0,11	0,14	0,16
S.1.2	25	0,05	0,07	0,10	0,12	0,14	20	0,04	0,06	0,08	0,10	0,11
S.2.1	25	0,05	0,07	0,10	0,12	0,14	20	0,04	0,06	0,08	0,10	0,11
S.2.2	20	0,06	0,09	0,12	0,15	0,17	15	0,05	0,08	0,10	0,13	0,14
S.2.3	20	0,05	0,07	0,10	0,12	0,14	15	0,04	0,06	0,08	0,10	0,11
S.3.1												
S.3.2	35	0,08	0,11	0,15	0,18	0,20	30	0,06	0,09	0,12	0,15	0,17
S.3.3	30	0,06	0,09	0,12	0,15	0,17	25	0,05	0,08	0,10	0,13	0,14
H.1.1												
H.1.2												
H.1.3												
H.1.4												
H.2.1												
H.3.1												
O.1.1												
O.1.2												
O.2.1												
O.2.2												
O.3.1												



The cutting data depends extremely on the external conditions, the material and machine type.
The indicated values are possible values which have to be increased or reduced according to the application conditions.

Cutting data standard values – WTX – H

Index	10 777 ...								
	without through coolant v_c (m/min)	3xD							
		\varnothing 2-3	\varnothing 3-4	\varnothing 4-5	\varnothing 5-6	\varnothing 6-8	\varnothing 8-10	\varnothing 10-12	\varnothing 12-14
		f (mm/rev)							
P.1.1	80	0,05	0,07	0,08	0,10	0,14	0,18	0,21	0,24
P.1.2	70	0,04	0,05	0,07	0,08	0,12	0,15	0,18	0,21
P.1.3	70	0,04	0,05	0,07	0,08	0,12	0,15	0,18	0,21
P.1.4	70	0,04	0,05	0,07	0,08	0,12	0,15	0,18	0,21
P.1.5	80	0,05	0,07	0,08	0,10	0,14	0,18	0,21	0,24
P.2.1	75	0,05	0,07	0,08	0,10	0,14	0,18	0,21	0,24
P.2.2	70	0,05	0,06	0,08	0,09	0,13	0,16	0,19	0,22
P.2.3	70	0,04	0,05	0,07	0,08	0,12	0,15	0,18	0,21
P.2.4	70	0,04	0,05	0,07	0,08	0,12	0,15	0,18	0,21
P.3.1									
P.3.2									
P.3.3									
P.4.1									
P.4.2									
M.1.1									
M.2.1									
M.3.1									
K.1.1	85	0,08	0,10	0,13	0,15	0,19	0,23	0,27	0,34
K.1.2	80	0,08	0,10	0,13	0,15	0,19	0,23	0,27	0,34
K.2.1	85	0,06	0,08	0,10	0,13	0,16	0,18	0,22	0,25
K.2.2	80	0,06	0,08	0,10	0,13	0,16	0,18	0,22	0,25
K.3.1	85	0,06	0,08	0,10	0,13	0,16	0,18	0,22	0,25
K.3.2	80	0,06	0,08	0,10	0,13	0,16	0,18	0,22	0,25
N.1.1									
N.1.2									
N.2.1									
N.2.2									
N.2.3									
N.3.1									
N.3.2									
N.3.3									
N.4.1									
S.1.1									
S.1.2									
S.2.1									
S.2.2									
S.2.3									
S.3.1									
S.3.2									
S.3.3									
H.1.1	30	0,04	0,05	0,05	0,06	0,07	0,08	0,09	0,10
H.1.2	15	0,04	0,05	0,05	0,06	0,07	0,08	0,09	0,10
H.1.3	10	0,03	0,04	0,04	0,05	0,06	0,06	0,07	0,07
H.1.4	10	0,03	0,04	0,04	0,05	0,06	0,06	0,07	0,07
H.2.1									
H.3.1									
O.1.1									
O.1.2									
O.2.1									
O.2.2									
O.3.1									



The cutting data depends extremely on the external conditions, the material and machine type.
The indicated values are possible values which have to be increased or reduced according to the application conditions.

Cutting data standard values – WTX – Quattro 4F

Index	10 735 ...						10 736 ...					
	with through coolant v_c (m/min)	5xD					with through coolant v_c (m/min)	8xD				
		Ø 3–5	Ø 5–8	Ø 8–12	Ø 12–16	Ø 16–20		Ø 3–5	Ø 5–8	Ø 8–12	Ø 12–16	Ø 16–20
		f (mm/rev)						f (mm/rev)				
P.1.1	110	0,12	0,17	0,23	0,28	0,31	110	0,12	0,17	0,23	0,28	0,31
P.1.2	105	0,11	0,16	0,22	0,26	0,30	105	0,11	0,16	0,22	0,26	0,30
P.1.3	100	0,11	0,15	0,20	0,25	0,28	100	0,11	0,15	0,20	0,25	0,28
P.1.4	95	0,10	0,15	0,19	0,24	0,27	95	0,10	0,15	0,19	0,24	0,27
P.1.5	90	0,10	0,14	0,18	0,23	0,26	90	0,10	0,14	0,18	0,23	0,26
P.2.1	110	0,14	0,20	0,27	0,33	0,37	110	0,14	0,20	0,27	0,33	0,37
P.2.2	100	0,13	0,18	0,24	0,30	0,34	100	0,13	0,18	0,24	0,30	0,34
P.2.3	90	0,11	0,16	0,22	0,27	0,30	90	0,11	0,16	0,22	0,27	0,30
P.2.4	70	0,11	0,15	0,19	0,24	0,27	70	0,11	0,15	0,19	0,24	0,27
P.3.1	75	0,11	0,16	0,22	0,27	0,30	75	0,11	0,16	0,22	0,27	0,30
P.3.2	60	0,10	0,13	0,18	0,22	0,25	60	0,10	0,13	0,18	0,22	0,25
P.3.3	60	0,08	0,11	0,14	0,17	0,19	60	0,08	0,11	0,14	0,17	0,19
P.4.1	60	0,08	0,11	0,14	0,18	0,20	60	0,08	0,11	0,14	0,18	0,20
P.4.2	60	0,08	0,11	0,14	0,18	0,20	60	0,08	0,11	0,14	0,18	0,20
M.1.1												
M.2.1												
M.3.1												
K.1.1	120	0,15	0,24	0,33	0,41	0,47	120	0,15	0,24	0,33	0,41	0,47
K.1.2	100	0,14	0,20	0,27	0,33	0,37	100	0,14	0,20	0,27	0,33	0,37
K.2.1	160	0,15	0,22	0,31	0,38	0,43	160	0,15	0,22	0,31	0,38	0,43
K.2.2	100	0,14	0,20	0,27	0,33	0,37	100	0,14	0,20	0,27	0,33	0,37
K.3.1	90	0,15	0,21	0,29	0,35	0,40	90	0,15	0,21	0,29	0,35	0,40
K.3.2	80	0,12	0,17	0,23	0,28	0,32	80	0,12	0,17	0,23	0,28	0,32
N.1.1												
N.1.2												
N.2.1												
N.2.2												
N.2.3												
N.3.1												
N.3.2												
N.3.3												
N.4.1												
S.1.1												
S.1.2												
S.2.1												
S.2.2												
S.2.3												
S.3.1												
S.3.2												
S.3.3												
H.1.1	25	0,05	0,07	0,09	0,12	0,13	25	0,05	0,07	0,09	0,12	0,13
H.1.2												
H.1.3												
H.1.4												
H.2.1	30	0,06	0,09	0,12	0,15	0,17	30	0,06	0,09	0,12	0,15	0,17
H.3.1												
O.1.1												
O.1.2												
O.2.1												
O.2.2												
O.3.1												



The cutting data depends extremely on the external conditions, the material and machine type.
The indicated values are possible values which have to be increased or reduced according to the application conditions.

Index	10 737 ...						
	with through coolant v _c (m/min)	12xD					Ø 16-20
		Ø 3-5	Ø 5-8	Ø 8-12	Ø 12-16	f (mm/rev)	
P.1.1	110	0,12	0,17	0,23	0,28	0,31	
P.1.2	105	0,11	0,16	0,22	0,26	0,30	
P.1.3	100	0,11	0,15	0,20	0,25	0,28	
P.1.4	95	0,10	0,15	0,19	0,24	0,27	
P.1.5	90	0,10	0,14	0,18	0,23	0,26	
P.2.1	110	0,14	0,20	0,27	0,33	0,37	
P.2.2	100	0,13	0,18	0,24	0,30	0,34	
P.2.3	90	0,11	0,16	0,22	0,27	0,30	
P.2.4	70	0,11	0,15	0,19	0,24	0,27	
P.3.1	75	0,11	0,16	0,22	0,27	0,30	
P.3.2	60	0,10	0,13	0,18	0,22	0,25	
P.3.3	60	0,08	0,11	0,14	0,17	0,19	
P.4.1	60	0,08	0,11	0,14	0,18	0,20	
P.4.2	60	0,08	0,11	0,14	0,18	0,20	
M.1.1							
M.2.1							
M.3.1							
K.1.1	120	0,15	0,24	0,33	0,41	0,47	
K.1.2	100	0,14	0,20	0,27	0,33	0,37	
K.2.1	160	0,15	0,22	0,31	0,38	0,43	
K.2.2	100	0,14	0,20	0,27	0,33	0,37	
K.3.1	90	0,15	0,21	0,29	0,35	0,40	
K.3.2	80	0,12	0,17	0,23	0,28	0,32	
N.1.1							
N.1.2							
N.2.1							
N.2.2							
N.2.3							
N.3.1							
N.3.2							
N.3.3							
N.4.1							
S.1.1							
S.1.2							
S.2.1							
S.2.2							
S.2.3							
S.3.1							
S.3.2							
S.3.3							
H.1.1	25	0,05	0,07	0,09	0,12	0,13	
H.1.2							
H.1.3							
H.1.4							
H.2.1	30	0,06	0,09	0,12	0,15	0,17	
H.3.1							
O.1.1							
O.1.2							
O.2.1							
O.2.2							
O.3.1							

Cutting data standard values – WTX – AL

Index	10 791 ...											
	with through coolant v _c (m/min)	5xD										
		Ø 2-3	Ø 3-4	Ø 4-5	Ø 5-6	Ø 6-8	Ø 8-10	Ø 10-12	Ø 12-14	Ø 14-16	Ø 16-18	Ø 18-20
f (mm/rev)												
P.1.1												
P.1.2												
P.1.3												
P.1.4												
P.1.5												
P.2.1												
P.2.2												
P.2.3												
P.2.4												
P.3.1												
P.3.2												
P.3.3												
P.4.1												
P.4.2												
M.1.1												
M.2.1												
M.3.1												
K.1.1												
K.1.2												
K.2.1												
K.2.2												
K.3.1												
K.3.2												
N.1.1	360	0,15	0,20	0,23	0,25	0,29	0,32	0,35	0,40	0,45	0,50	0,55
N.1.2	400	0,15	0,20	0,23	0,25	0,29	0,32	0,35	0,40	0,45	0,50	0,55
N.2.1	360	0,20	0,23	0,25	0,28	0,32	0,35	0,38	0,45	0,50	0,55	0,60
N.2.2	400	0,20	0,23	0,25	0,28	0,32	0,35	0,38	0,45	0,50	0,55	0,60
N.2.3	350	0,15	0,20	0,23	0,25	0,29	0,32	0,35	0,40	0,45	0,50	0,55
N.3.1	200	0,08	0,11	0,13	0,15	0,19	0,23	0,26	0,30	0,34	0,38	0,42
N.3.2	200	0,08	0,11	0,13	0,15	0,19	0,23	0,26	0,30	0,34	0,38	0,42
N.3.3	160	0,08	0,11	0,13	0,15	0,19	0,23	0,26	0,30	0,34	0,38	0,42
N.4.1												
S.1.1												
S.1.2												
S.2.1												
S.2.2												
S.2.3												
S.3.1												
S.3.2												
S.3.3												
H.1.1												
H.1.2												
H.1.3												
H.1.4												
H.2.1												
H.3.1												
O.1.1												
O.1.2												
O.2.1												
O.2.2												
O.3.1												

 The cutting data depends extremely on the external conditions, the material and machine type.
The indicated values are possible values which have to be increased or reduced according to the application conditions.

Index	10 792 ...											
	with through coolant v _c (m/min)	8xD										
		Ø 3-4	Ø 4-5	Ø 5-6	Ø 6-8	Ø 8-10	Ø 10-12	Ø 12-14	Ø 14-16	Ø 16-18	Ø 18-20	
		f (mm/rev)										
P.1.1												
P.1.2												
P.1.3												
P.1.4												
P.1.5												
P.2.1												
P.2.2												
P.2.3												
P.2.4												
P.3.1												
P.3.2												
P.3.3												
P.4.1												
P.4.2												
M.1.1												
M.2.1												
M.3.1												
K.1.1												
K.1.2												
K.2.1												
K.2.2												
K.3.1												
K.3.2												
N.1.1	320	0,20	0,23	0,25	0,29	0,32	0,35	0,40	0,45	0,50	0,55	0,55
N.1.2	360	0,20	0,23	0,25	0,29	0,32	0,35	0,40	0,45	0,50	0,55	0,55
N.2.1	320	0,23	0,25	0,28	0,32	0,35	0,38	0,45	0,50	0,55	0,60	0,60
N.2.2	360	0,23	0,25	0,28	0,32	0,35	0,38	0,45	0,50	0,55	0,60	0,60
N.2.3	310	0,20	0,23	0,25	0,29	0,32	0,35	0,40	0,45	0,50	0,55	0,55
N.3.1	160	0,11	0,13	0,15	0,19	0,23	0,26	0,30	0,34	0,38	0,42	0,42
N.3.2	160	0,11	0,13	0,15	0,19	0,23	0,26	0,30	0,34	0,38	0,42	0,42
N.3.3	140	0,11	0,13	0,15	0,19	0,23	0,26	0,30	0,34	0,38	0,42	0,42
N.4.1												
S.1.1												
S.1.2												
S.2.1												
S.2.2												
S.2.3												
S.3.1												
S.3.2												
S.3.3												
H.1.1												
H.1.2												
H.1.3												
H.1.4												
H.2.1												
H.3.1												
O.1.1												
O.1.2												
O.2.1												
O.2.2												
O.3.1												

Cutting data standard values – WTX – AL

Index	10 793 ...										
	with through coolant v_c (m/min)	12xD									
		Ø 3–4	Ø 4–5	Ø 5–6	Ø 6–8	Ø 8–10	Ø 10–12	Ø 12–14	Ø 14–16	Ø 16–18	Ø 18–20
		f (mm/rev)									
P.1.1											
P.1.2											
P.1.3											
P.1.4											
P.1.5											
P.2.1											
P.2.2											
P.2.3											
P.2.4											
P.3.1											
P.3.2											
P.3.3											
P.4.1											
P.4.2											
M.1.1											
M.2.1											
M.3.1											
K.1.1											
K.1.2											
K.2.1											
K.2.2											
K.3.1											
K.3.2											
N.1.1	250	0,20	0,23	0,25	0,29	0,32	0,35	0,40	0,45	0,50	0,55
N.1.2	280	0,20	0,23	0,25	0,29	0,32	0,35	0,40	0,45	0,50	0,55
N.2.1	250	0,23	0,25	0,28	0,32	0,35	0,38	0,45	0,50	0,55	0,60
N.2.2	280	0,23	0,25	0,28	0,32	0,35	0,38	0,45	0,50	0,55	0,60
N.2.3	245	0,20	0,23	0,25	0,29	0,32	0,35	0,40	0,45	0,50	0,55
N.3.1	150	0,11	0,13	0,15	0,19	0,23	0,26	0,30	0,34	0,38	0,42
N.3.2	150	0,11	0,13	0,15	0,19	0,23	0,26	0,30	0,34	0,38	0,42
N.3.3	120	0,11	0,13	0,15	0,19	0,23	0,26	0,30	0,34	0,38	0,42
N.4.1											
S.1.1											
S.1.2											
S.2.1											
S.2.2											
S.2.3											
S.3.1											
S.3.2											
S.3.3											
H.1.1											
H.1.2											
H.1.3											
H.1.4											
H.2.1											
H.3.1											
O.1.1											
O.1.2											
O.2.1											
O.2.2											
O.3.1											



The cutting data depends extremely on the external conditions, the material and machine type.
The indicated values are possible values which have to be increased or reduced according to the application conditions.

Cutting data standard values – WTX – HFDS – high-feed drill

Index	10 797 ...						10 798 ...					
	with through coolant v _c (m/min)	3xD					with through coolant v _c (m/min)	5xD				
		Ø 6–8	Ø 8–10	Ø 10–12	Ø 12–14	Ø 14–16		Ø 6–8	Ø 8–10	Ø 10–12	Ø 12–14	Ø 14–16
		f (mm/rev)						f (mm/rev)				
P.1.1	100	0,3–0,4	0,5–0,6	0,7–0,8	0,8–0,9	0,8–0,9	100	0,3–0,4	0,5–0,6	0,7–0,8	0,8–0,9	0,8–0,9
P.1.2	100	0,3–0,4	0,5–0,6	0,7–0,8	0,8–0,9	0,8–0,9	100	0,3–0,4	0,5–0,6	0,7–0,8	0,8–0,9	0,8–0,9
P.1.3	100	0,3–0,4	0,5–0,6	0,7–0,8	0,8–0,9	0,8–0,9	100	0,3–0,4	0,5–0,6	0,7–0,8	0,8–0,9	0,8–0,9
P.1.4	100	0,3–0,4	0,5–0,6	0,7–0,8	0,8–0,9	0,8–0,9	100	0,3–0,4	0,5–0,6	0,7–0,8	0,8–0,9	0,8–0,9
P.1.5	100	0,3–0,4	0,5–0,6	0,7–0,8	0,8–0,9	0,8–0,9	100	0,3–0,4	0,5–0,6	0,7–0,8	0,8–0,9	0,8–0,9
P.2.1	100	0,3–0,4	0,5–0,6	0,7–0,8	0,8–0,9	0,8–0,9	100	0,3–0,4	0,5–0,6	0,7–0,8	0,8–0,9	0,8–0,9
P.2.2	100	0,3–0,4	0,5–0,6	0,7–0,8	0,8–0,9	0,8–0,9	100	0,3–0,4	0,5–0,6	0,7–0,8	0,8–0,9	0,8–0,9
P.2.3	90	0,3–0,4	0,5–0,6	0,7–0,8	0,8–0,9	0,8–0,9	90	0,3–0,4	0,5–0,6	0,7–0,8	0,8–0,9	0,8–0,9
P.2.4	90	0,3–0,4	0,5–0,6	0,7–0,8	0,8–0,9	0,8–0,9	90	0,3–0,4	0,5–0,6	0,7–0,8	0,8–0,9	0,8–0,9
P.3.1	85	0,2–0,3	0,3–0,4	0,5–0,6	0,6–0,7	0,6–0,7	85	0,2–0,3	0,3–0,4	0,5–0,6	0,6–0,7	0,6–0,7
P.3.2	70	0,2–0,3	0,3–0,4	0,5–0,6	0,6–0,7	0,6–0,7	70	0,2–0,3	0,3–0,4	0,5–0,6	0,6–0,7	0,6–0,7
P.3.3	70	0,2–0,3	0,3–0,4	0,5–0,6	0,6–0,7	0,6–0,7	70	0,2–0,3	0,3–0,4	0,5–0,6	0,6–0,7	0,6–0,7
P.4.1	65	0,2–0,3	0,3–0,4	0,5–0,6	0,6–0,7	0,6–0,7	65	0,2–0,3	0,3–0,4	0,5–0,6	0,6–0,7	0,6–0,7
P.4.2	65	0,2–0,3	0,3–0,4	0,5–0,6	0,6–0,7	0,6–0,7	65	0,2–0,3	0,3–0,4	0,5–0,6	0,6–0,7	0,6–0,7
M.1.1	65	0,2–0,25	0,3–0,4	0,5–0,6	0,6–0,6	0,6–0,6	65	0,2–0,25	0,3–0,4	0,5–0,6	0,6–0,6	0,6–0,6
M.2.1	65	0,2–0,25	0,3–0,4	0,5–0,6	0,6–0,6	0,6–0,6	65	0,2–0,25	0,3–0,4	0,5–0,6	0,6–0,6	0,6–0,6
M.3.1	55	0,2–0,25	0,3–0,4	0,5–0,6	0,6–0,6	0,6–0,6	55	0,2–0,25	0,3–0,4	0,5–0,6	0,6–0,6	0,6–0,6
K.1.1	130	0,4–0,6	0,5–0,7	0,6–0,8	0,7–0,9	0,7–0,9	130	0,4–0,6	0,5–0,7	0,6–0,8	0,7–0,9	0,7–0,9
K.1.2	130	0,4–0,6	0,5–0,7	0,6–0,8	0,7–0,9	0,7–0,9	130	0,4–0,6	0,5–0,7	0,6–0,8	0,7–0,9	0,7–0,9
K.2.1	130	0,4–0,6	0,5–0,7	0,6–0,8	0,7–0,9	0,7–0,9	130	0,4–0,6	0,5–0,7	0,6–0,8	0,7–0,9	0,7–0,9
K.2.2	130	0,4–0,6	0,5–0,7	0,6–0,8	0,7–0,9	0,7–0,9	130	0,4–0,6	0,5–0,7	0,6–0,8	0,7–0,9	0,7–0,9
K.3.1	130	0,4–0,6	0,5–0,7	0,6–0,8	0,7–0,9	0,7–0,9	130	0,4–0,6	0,5–0,7	0,6–0,8	0,7–0,9	0,7–0,9
K.3.2	130	0,4–0,6	0,5–0,7	0,6–0,8	0,7–0,9	0,7–0,9	130	0,4–0,6	0,5–0,7	0,6–0,8	0,7–0,9	0,7–0,9
N.1.1												
N.1.2												
N.2.1												
N.2.2												
N.2.3												
N.3.1	130	0,4–0,6	0,5–0,7	0,6–0,8	0,7–0,9	0,7–0,9	130	0,4–0,6	0,5–0,7	0,6–0,8	0,7–0,9	0,7–0,9
N.3.2	130	0,4–0,6	0,5–0,7	0,6–0,8	0,7–0,9	0,7–0,9	130	0,4–0,6	0,5–0,7	0,6–0,8	0,7–0,9	0,7–0,9
N.3.3	130	0,4–0,6	0,5–0,7	0,6–0,8	0,7–0,9	0,7–0,9	130	0,4–0,6	0,5–0,7	0,6–0,8	0,7–0,9	0,7–0,9
N.4.1	130	0,4–0,6	0,5–0,7	0,6–0,8	0,7–0,9	0,7–0,9	130	0,4–0,6	0,5–0,7	0,6–0,8	0,7–0,9	0,7–0,9
S.1.1												
S.1.2												
S.2.1												
S.2.2												
S.2.3												
S.3.1												
S.3.2												
S.3.3												
H.1.1												
H.1.2												
H.1.3												
H.1.4												
H.2.1												
H.3.1												
O.1.1												
O.1.2												
O.2.1												
O.2.2												
O.3.1	110	0,6	0,6	0,8	0,9	1,0	110	0,6	0,6	0,8	0,9	1,0



The cutting data depends extremely on the external conditions, the material and machine type.
The indicated values are possible values which have to be increased or reduced according to the application conditions.

Cutting data standard values – WTX – 180

Index	10 720 ...					
	3xD					
	with through coolant	Ø 3–5	Ø 5–8	Ø 8–12	Ø 12–16	Ø 16–20
	v_c (m/min)	f (mm/rev)				
P.1.1	90	0,09	0,13	0,18	0,22	0,25
P.1.2	85	0,09	0,13	0,17	0,21	0,24
P.1.3	80	0,09	0,12	0,16	0,20	0,23
P.1.4	75	0,08	0,12	0,16	0,19	0,22
P.1.5	70	0,08	0,11	0,15	0,18	0,20
P.2.1	90	0,11	0,16	0,21	0,26	0,29
P.2.2	80	0,10	0,14	0,19	0,24	0,27
P.2.3	70	0,09	0,13	0,17	0,21	0,24
P.2.4	55	0,09	0,12	0,16	0,19	0,21
P.3.1	60	0,09	0,13	0,17	0,21	0,24
P.3.2	50	0,08	0,11	0,14	0,17	0,20
P.3.3	50	0,06	0,09	0,11	0,14	0,15
P.4.1	50	0,06	0,09	0,11	0,14	0,16
P.4.2	50	0,06	0,09	0,11	0,14	0,16
M.1.1	45	0,06	0,09	0,11	0,14	0,16
M.2.1	40	0,05	0,07	0,10	0,12	0,14
M.3.1	40	0,05	0,07	0,10	0,12	0,14
K.1.1	95	0,12	0,19	0,26	0,33	0,38
K.1.2	80	0,11	0,16	0,21	0,26	0,30
K.2.1	130	0,12	0,18	0,25	0,30	0,35
K.2.2	80	0,11	0,16	0,21	0,26	0,30
K.3.1	70	0,12	0,17	0,23	0,28	0,32
K.3.2	65	0,10	0,14	0,18	0,22	0,25
N.1.1						
N.1.2						
N.2.1						
N.2.2						
N.2.3						
N.3.1						
N.3.2						
N.3.3						
N.4.1						
S.1.1						
S.1.2						
S.2.1						
S.2.2						
S.2.3						
S.3.1						
S.3.2						
S.3.3						
H.1.1						
H.1.2						
H.1.3						
H.1.4						
H.2.1						
H.3.1						
O.1.1						
O.1.2						
O.2.1						
O.2.2						
O.3.1						

Index	10 721 ...					
	with through coolant v _c (m/min)	5xD				
		Ø 3-5	Ø 5-8	Ø 8-12	Ø 12-16	Ø 16-20
f (mm/rev)						
P.1.1	90	0,09	0,13	0,18	0,22	0,25
P.1.2	85	0,09	0,13	0,17	0,21	0,24
P.1.3	80	0,09	0,12	0,16	0,20	0,23
P.1.4	75	0,08	0,12	0,16	0,19	0,22
P.1.5	70	0,08	0,11	0,15	0,18	0,20
P.2.1	90	0,11	0,16	0,21	0,26	0,29
P.2.2	80	0,10	0,14	0,19	0,24	0,27
P.2.3	70	0,09	0,13	0,17	0,21	0,24
P.2.4	55	0,09	0,12	0,16	0,19	0,21
P.3.1	60	0,09	0,13	0,17	0,21	0,24
P.3.2	50	0,08	0,11	0,14	0,17	0,20
P.3.3	50	0,06	0,09	0,11	0,14	0,15
P.4.1	50	0,06	0,09	0,11	0,14	0,16
P.4.2	50	0,06	0,09	0,11	0,14	0,16
M.1.1	45	0,06	0,09	0,11	0,14	0,16
M.2.1	40	0,05	0,07	0,10	0,12	0,14
M.3.1	40	0,05	0,07	0,10	0,12	0,14
K.1.1	95	0,12	0,19	0,26	0,33	0,38
K.1.2	80	0,11	0,16	0,21	0,26	0,30
K.2.1	130	0,12	0,18	0,25	0,30	0,35
K.2.2	80	0,11	0,16	0,21	0,26	0,30
K.3.1	70	0,12	0,17	0,23	0,28	0,32
K.3.2	65	0,10	0,14	0,18	0,22	0,25
N.1.1						
N.1.2						
N.2.1						
N.2.2						
N.2.3						
N.3.1						
N.3.2						
N.3.3						
N.4.1						
S.1.1						
S.1.2						
S.2.1						
S.2.2						
S.2.3						
S.3.1						
S.3.2						
S.3.3						
H.1.1						
H.1.2						
H.1.3						
H.1.4						
H.2.1						
H.3.1						
O.1.1						
O.1.2						
O.2.1						
O.2.2						
O.3.1						



Application Note:

Spot drilling with reduced feedrate

1. Feedrate f [mm/U] should be multiplied by correction factor A_k
2. Drill with reduced feed rate until tool is fully engaged in workpiece by approximately 0.25 x D
3. Retract from the hole at double the feed rate f in mm/U – only with inclined surfaces

This operation is necessary in order to achieve maximum performance of the drill!
4. Drill the hole with feed rate f [mm/U] without pecking for chip evacuation

Correction factor A _k for f [mm/U] when spot drilling		
Inclination workpiece surface	A _k to 3xD (10 720 ...)	A _k to 5xD (10 721 ...)
15°	0,5	0,25
30°	0,4	not recommended
45°	0,25	not recommended



For drilling on flat surfaces (inclination 0 °) with the WTX – 180 5xD, we recommend the use of a pilot drill. (WTX – UNI 3xD)

Cutting data standard values – type UNI

Index	11 706 ..., 11 707 ..., 11 709 ..., 11 710 ...																
	without through coolant v_c (m/min)	3xD / 5xD															
		$\leq \emptyset 1$	$\emptyset 1-1,25$	$\emptyset 1,25-1,5$	$\emptyset 1,5-2$	$\emptyset 2-2,5$	$\emptyset 2,5-3$	$\emptyset 3-4$	$\emptyset 4-5$	$\emptyset 5-6$	$\emptyset 6-8$	$\emptyset 8-10$	$\emptyset 10-12$	$\emptyset 12-14$	$\emptyset 14-16$	$\emptyset 16-18$	$\emptyset 18-20$
		f (mm/rev)															
P.1.1	90	0,03	0,04	0,05	0,06	0,08	0,09	0,13	0,16	0,19	0,22	0,25	0,28	0,31	0,34	0,36	0,38
P.1.2	75	0,03	0,03	0,04	0,05	0,07	0,08	0,12	0,15	0,18	0,21	0,24	0,27	0,30	0,32	0,35	0,37
P.1.3	75	0,03	0,03	0,04	0,05	0,07	0,08	0,12	0,15	0,18	0,21	0,24	0,27	0,30	0,32	0,35	0,37
P.1.4	70	0,02	0,02	0,03	0,03	0,04	0,05	0,06	0,08	0,10	0,12	0,14	0,15	0,18	0,20	0,23	0,25
P.1.5	70	0,02	0,02	0,03	0,03	0,04	0,05	0,06	0,08	0,10	0,12	0,14	0,15	0,18	0,20	0,23	0,25
P.2.1	80	0,03	0,04	0,05	0,06	0,08	0,09	0,13	0,16	0,19	0,22	0,25	0,28	0,31	0,34	0,36	0,38
P.2.2	70	0,03	0,03	0,04	0,05	0,07	0,08	0,12	0,15	0,18	0,21	0,24	0,27	0,30	0,32	0,35	0,37
P.2.3	70	0,02	0,02	0,03	0,03	0,04	0,05	0,06	0,08	0,10	0,12	0,14	0,15	0,18	0,20	0,23	0,25
P.2.4	55	0,02	0,02	0,03	0,03	0,04	0,05	0,06	0,08	0,10	0,12	0,14	0,15	0,18	0,20	0,23	0,25
P.3.1	70	0,02	0,02	0,03	0,03	0,04	0,05	0,06	0,08	0,10	0,12	0,14	0,15	0,18	0,20	0,23	0,25
P.3.2	55	0,02	0,02	0,03	0,03	0,04	0,05	0,06	0,08	0,10	0,12	0,14	0,15	0,18	0,20	0,23	0,25
P.3.3																	
P.4.1																	
P.4.2																	
M.1.1																	
M.2.1																	
M.3.1																	
K.1.1	90	0,04	0,05	0,06	0,08	0,10	0,13	0,16	0,18	0,22	0,25	0,29	0,33	0,37	0,40	0,43	0,46
K.1.2	75	0,04	0,05	0,06	0,08	0,10	0,13	0,16	0,18	0,22	0,25	0,29	0,33	0,37	0,40	0,43	0,46
K.2.1	75	0,03	0,03	0,04	0,05	0,06	0,08	0,10	0,13	0,15	0,18	0,20	0,23	0,26	0,30	0,34	0,38
K.2.2	70	0,03	0,03	0,04	0,05	0,06	0,08	0,10	0,13	0,15	0,18	0,20	0,23	0,26	0,30	0,34	0,38
K.3.1	75	0,03	0,03	0,04	0,05	0,06	0,08	0,10	0,13	0,15	0,18	0,20	0,23	0,26	0,30	0,34	0,38
K.3.2	70	0,03	0,03	0,04	0,05	0,06	0,08	0,10	0,13	0,15	0,18	0,20	0,23	0,26	0,30	0,34	0,38
N.1.1																	
N.1.2																	
N.2.1																	
N.2.2																	
N.2.3																	
N.3.1																	
N.3.2																	
N.3.3																	
N.4.1																	
S.1.1																	
S.1.2																	
S.2.1																	
S.2.2																	
S.2.3																	
S.3.1																	
S.3.2																	
S.3.3																	
H.1.1																	
H.1.2																	
H.1.3																	
H.1.4																	
H.2.1																	
H.3.1																	
O.1.1																	
O.1.2																	
O.2.1																	
O.2.2																	
O.3.1																	



The cutting data is strongly influenced by external conditions, such as the stability of the tool and workpiece clamping, material and type of machine. The specified values represent guideline cutting data that must be corrected according to the usage conditions.

Index	11 700 ..., 11 701 ..., 11 702 ..., 11 703 ...																	
	with through coolant v _c (m/min)	3xD / 5xD																
		≤ Ø 1	Ø 1-1,25	Ø 1,25-1,5	Ø 1,5-2	Ø 2-2,5	Ø 2,5-3	Ø 3-4	Ø 4-5	Ø 5-6	Ø 6-8	Ø 8-10	Ø 10-12	Ø 12-14	Ø 14-16	Ø 16-18	Ø 18-20	
		f (mm/rev)																
P.1.1	115	0,03	0,04	0,05	0,06	0,08	0,09	0,13	0,16	0,19	0,22	0,25	0,28	0,31	0,34	0,36	0,38	
P.1.2	95	0,03	0,03	0,04	0,05	0,07	0,08	0,12	0,15	0,18	0,21	0,24	0,27	0,30	0,32	0,35	0,37	
P.1.3	95	0,03	0,03	0,04	0,05	0,07	0,08	0,12	0,15	0,18	0,21	0,24	0,27	0,30	0,32	0,35	0,37	
P.1.4	85	0,02	0,02	0,03	0,03	0,04	0,05	0,06	0,08	0,10	0,12	0,14	0,15	0,18	0,20	0,23	0,25	
P.1.5	85	0,02	0,02	0,03	0,03	0,04	0,05	0,06	0,08	0,10	0,12	0,14	0,15	0,18	0,20	0,23	0,25	
P.2.1	95	0,03	0,04	0,05	0,06	0,08	0,09	0,13	0,16	0,19	0,22	0,25	0,28	0,31	0,34	0,36	0,38	
P.2.2	85	0,03	0,03	0,04	0,05	0,07	0,08	0,12	0,15	0,18	0,21	0,24	0,27	0,30	0,32	0,35	0,37	
P.2.3	85	0,02	0,02	0,03	0,03	0,04	0,05	0,06	0,08	0,10	0,12	0,14	0,15	0,18	0,20	0,23	0,25	
P.2.4	70	0,02	0,02	0,03	0,03	0,04	0,05	0,06	0,08	0,10	0,12	0,14	0,15	0,18	0,20	0,23	0,25	
P.3.1	85	0,02	0,02	0,03	0,03	0,04	0,05	0,06	0,08	0,10	0,12	0,14	0,15	0,18	0,20	0,23	0,25	
P.3.2	70	0,02	0,02	0,03	0,03	0,04	0,05	0,06	0,08	0,10	0,12	0,14	0,15	0,18	0,20	0,23	0,25	
P.3.3	40	0,02	0,02	0,03	0,03	0,04	0,05	0,06	0,08	0,10	0,12	0,14	0,15	0,18	0,20	0,23	0,25	
P.4.1	50	0,02	0,02	0,03	0,03	0,04	0,05	0,06	0,08	0,10	0,12	0,14	0,15	0,18	0,20	0,23	0,25	
P.4.2	30	0,02	0,02	0,03	0,03	0,04	0,05	0,06	0,08	0,10	0,12	0,14	0,15	0,18	0,20	0,23	0,25	
M.1.1	35	0,02	0,02	0,03	0,03	0,04	0,05	0,06	0,08	0,10	0,12	0,14	0,15	0,18	0,20	0,23	0,25	
M.2.1	35	0,02	0,02	0,03	0,03	0,04	0,05	0,06	0,08	0,10	0,12	0,14	0,15	0,18	0,20	0,23	0,25	
M.3.1	35	0,02	0,02	0,03	0,03	0,04	0,05	0,06	0,08	0,10	0,12	0,14	0,15	0,18	0,20	0,23	0,25	
K.1.1	115	0,04	0,05	0,06	0,08	0,10	0,13	0,16	0,18	0,22	0,25	0,29	0,33	0,37	0,40	0,43	0,46	
K.1.2	95	0,04	0,05	0,06	0,08	0,10	0,13	0,16	0,18	0,22	0,25	0,29	0,33	0,37	0,40	0,43	0,46	
K.2.1	95	0,03	0,03	0,04	0,05	0,06	0,08	0,10	0,13	0,15	0,18	0,20	0,23	0,26	0,30	0,34	0,38	
K.2.2	90	0,03	0,03	0,04	0,05	0,06	0,08	0,10	0,13	0,15	0,18	0,20	0,23	0,26	0,30	0,34	0,38	
K.3.1	95	0,03	0,03	0,04	0,05	0,06	0,08	0,10	0,13	0,15	0,18	0,20	0,23	0,26	0,30	0,34	0,38	
K.3.2	90	0,03	0,03	0,04	0,05	0,06	0,08	0,10	0,13	0,15	0,18	0,20	0,23	0,26	0,30	0,34	0,38	
N.1.1	200	0,03	0,03	0,04	0,05	0,07	0,08	0,12	0,15	0,18	0,21	0,24	0,27	0,30	0,32	0,35	0,37	
N.1.2	200	0,03	0,03	0,04	0,05	0,07	0,08	0,12	0,15	0,18	0,21	0,24	0,27	0,30	0,32	0,35	0,37	
N.2.1	160	0,03	0,03	0,04	0,05	0,06	0,08	0,10	0,11	0,13	0,15	0,18	0,20	0,23	0,26	0,29	0,33	
N.2.2	160	0,03	0,03	0,04	0,05	0,06	0,08	0,10	0,11	0,13	0,15	0,18	0,20	0,23	0,26	0,29	0,33	
N.2.3	140	0,02	0,02	0,03	0,03	0,04	0,05	0,06	0,08	0,10	0,12	0,14	0,15	0,18	0,20	0,23	0,25	
N.3.1	120	0,02	0,02	0,03	0,03	0,04	0,05	0,07	0,08	0,10	0,11	0,12	0,13	0,14	0,15	0,16	0,18	
N.3.2	120	0,02	0,02	0,03	0,03	0,04	0,05	0,07	0,08	0,10	0,11	0,12	0,13	0,14	0,15	0,16	0,18	
N.3.3	100	0,02	0,02	0,03	0,03	0,04	0,05	0,07	0,08	0,10	0,11	0,12	0,13	0,14	0,15	0,16	0,18	
N.4.1																		
S.1.1																		
S.1.2																		
S.2.1																		
S.2.2																		
S.2.3																		
S.3.1																		
S.3.2																		
S.3.3																		
H.1.1																		
H.1.2																		
H.1.3																		
H.1.4																		
H.2.1																		
H.3.1																		
O.1.1																		
O.1.2																		
O.2.1																		
O.2.2																		
O.3.1																		

Cutting data standard values – type UNI

Index	11 704 ...										
	with through coolant v_c (m/min)	8xD									
		\varnothing 3–4	\varnothing 4–5	\varnothing 5–6	\varnothing 6–8	\varnothing 8–10	\varnothing 10–12	\varnothing 12–14	\varnothing 14–16	\varnothing 16–18	\varnothing 18–20
		f (mm/rev)									
P.1.1	100	0,13	0,16	0,19	0,22	0,25	0,28	0,31	0,34	0,36	0,38
P.1.2	80	0,12	0,15	0,18	0,21	0,24	0,27	0,30	0,32	0,35	0,37
P.1.3	80	0,12	0,15	0,18	0,21	0,24	0,27	0,30	0,32	0,35	0,37
P.1.4	75	0,06	0,08	0,10	0,12	0,14	0,15	0,18	0,20	0,23	0,25
P.1.5	75	0,06	0,08	0,10	0,12	0,14	0,15	0,18	0,20	0,23	0,25
P.2.1	80	0,13	0,16	0,19	0,22	0,25	0,28	0,31	0,34	0,36	0,38
P.2.2	75	0,12	0,15	0,18	0,21	0,24	0,27	0,30	0,32	0,35	0,37
P.2.3	75	0,06	0,08	0,10	0,12	0,14	0,15	0,18	0,20	0,23	0,25
P.2.4	60	0,06	0,08	0,10	0,12	0,14	0,15	0,18	0,20	0,23	0,25
P.3.1	75	0,06	0,08	0,10	0,12	0,14	0,15	0,18	0,20	0,23	0,25
P.3.2	60	0,06	0,08	0,10	0,12	0,14	0,15	0,18	0,20	0,23	0,25
P.3.3	35	0,06	0,08	0,10	0,12	0,14	0,15	0,18	0,20	0,23	0,25
P.4.1	40	0,06	0,08	0,10	0,12	0,14	0,15	0,18	0,20	0,23	0,25
P.4.2	25	0,06	0,08	0,10	0,12	0,14	0,15	0,18	0,20	0,23	0,25
M.1.1	30	0,06	0,08	0,10	0,12	0,14	0,15	0,18	0,20	0,23	0,25
M.2.1	30	0,06	0,08	0,10	0,12	0,14	0,15	0,18	0,20	0,23	0,25
M.3.1	30	0,06	0,08	0,10	0,12	0,14	0,15	0,18	0,20	0,23	0,25
K.1.1	100	0,16	0,18	0,22	0,25	0,29	0,33	0,37	0,40	0,43	0,46
K.1.2	80	0,16	0,18	0,22	0,25	0,29	0,33	0,37	0,40	0,43	0,46
K.2.1	80	0,10	0,13	0,15	0,18	0,20	0,23	0,26	0,30	0,34	0,38
K.2.2	75	0,10	0,13	0,15	0,18	0,20	0,23	0,26	0,30	0,34	0,38
K.3.1	80	0,10	0,13	0,15	0,18	0,20	0,23	0,26	0,30	0,34	0,38
K.3.2	75	0,10	0,13	0,15	0,18	0,20	0,23	0,26	0,30	0,34	0,38
N.1.1											
N.1.2											
N.2.1											
N.2.2											
N.2.3											
N.3.1											
N.3.2											
N.3.3											
N.4.1											
S.1.1											
S.1.2											
S.2.1											
S.2.2											
S.2.3											
S.3.1											
S.3.2											
S.3.3											
H.1.1											
H.1.2											
H.1.3											
H.1.4											
H.2.1											
H.3.1											
O.1.1											
O.1.2											
O.2.1											
O.2.2											
O.3.1											

 The cutting data is highly dependent on external conditions, such as stability of the tool and workpiece clamping, material and machine type!
The values indicated represent possible cutting data which may need to be corrected depending on operating conditions !

Index	11 705 ...											
	with through coolant v _c (m/min)	12xD										
		Ø 3-4	Ø 4-5	Ø 5-6	Ø 6-8	Ø 8-10	Ø 10-12	Ø 12-14	Ø 14-16	Ø 16-18	Ø 18-20	
		f (mm/rev)										
P.1.1	90	0,13	0,16	0,19	0,22	0,25	0,28	0,31	0,34	0,36	0,38	
P.1.2	75	0,12	0,15	0,18	0,21	0,24	0,27	0,30	0,32	0,35	0,37	
P.1.3	75	0,12	0,15	0,18	0,21	0,24	0,27	0,30	0,32	0,35	0,37	
P.1.4	70	0,06	0,08	0,10	0,12	0,14	0,15	0,18	0,20	0,23	0,25	
P.1.5	70	0,06	0,08	0,10	0,12	0,14	0,15	0,18	0,20	0,23	0,25	
P.2.1	80	0,13	0,16	0,19	0,22	0,25	0,28	0,31	0,34	0,36	0,38	
P.2.2	70	0,12	0,15	0,18	0,21	0,24	0,27	0,30	0,32	0,35	0,37	
P.2.3	70	0,06	0,08	0,10	0,12	0,14	0,15	0,18	0,20	0,23	0,25	
P.2.4	55	0,06	0,08	0,10	0,12	0,14	0,15	0,18	0,20	0,23	0,25	
P.3.1	70	0,06	0,08	0,10	0,12	0,14	0,15	0,18	0,20	0,23	0,25	
P.3.2	55	0,06	0,08	0,10	0,12	0,14	0,15	0,18	0,20	0,23	0,25	
P.3.3	35	0,06	0,08	0,10	0,12	0,14	0,15	0,18	0,20	0,23	0,25	
P.4.1	40	0,06	0,08	0,10	0,12	0,14	0,15	0,18	0,20	0,23	0,25	
P.4.2	25	0,06	0,08	0,10	0,12	0,14	0,15	0,18	0,20	0,23	0,25	
M.1.1	30	0,06	0,08	0,10	0,12	0,14	0,15	0,18	0,20	0,23	0,25	
M.2.1	30	0,06	0,08	0,10	0,12	0,14	0,15	0,18	0,20	0,23	0,25	
M.3.1	30	0,06	0,08	0,10	0,12	0,14	0,15	0,18	0,20	0,23	0,25	
K.1.1	90	0,16	0,18	0,22	0,25	0,29	0,33	0,37	0,40	0,43	0,46	
K.1.2	75	0,16	0,18	0,22	0,25	0,29	0,33	0,37	0,40	0,43	0,46	
K.2.1	75	0,10	0,13	0,15	0,18	0,20	0,23	0,26	0,30	0,34	0,38	
K.2.2	70	0,10	0,13	0,15	0,18	0,20	0,23	0,26	0,30	0,34	0,38	
K.3.1	75	0,10	0,13	0,15	0,18	0,20	0,23	0,26	0,30	0,34	0,38	
K.3.2	70	0,10	0,13	0,15	0,18	0,20	0,23	0,26	0,30	0,34	0,38	
N.1.1												
N.1.2												
N.2.1												
N.2.2												
N.2.3												
N.3.1												
N.3.2												
N.3.3												
N.4.1												
S.1.1												
S.1.2												
S.2.1												
S.2.2												
S.2.3												
S.3.1												
S.3.2												
S.3.3												
H.1.1												
H.1.2												
H.1.3												
H.1.4												
H.2.1												
H.3.1												
O.1.1												
O.1.2												
O.2.1												
O.2.2												
O.3.1												

Cutting data standard values – type VA

Index	11 711 ..., 11 712 ...																
	without through coolant v_c (m/min)	3xD															
		$\leq \varnothing 1$	$\varnothing 1-1,25$	$\varnothing 1,25-1,5$	$\varnothing 1,5-2$	$\varnothing 2-2,5$	$\varnothing 2,5-3$	$\varnothing 3-4$	$\varnothing 4-5$	$\varnothing 5-6$	$\varnothing 6-8$	$\varnothing 8-10$	$\varnothing 10-12$	$\varnothing 12-14$	$\varnothing 14-16$	$\varnothing 16-18$	$\varnothing 18-20$
		f (mm/rev)															
P.1.1	75	0,03	0,03	0,04	0,05	0,07	0,08	0,10	0,11	0,12	0,15	0,18	0,20	0,23	0,24	0,26	0,27
P.1.2																	
P.1.3																	
P.1.4																	
P.1.5																	
P.2.1	65	0,03	0,03	0,04	0,05	0,07	0,08	0,10	0,11	0,12	0,15	0,18	0,20	0,23	0,24	0,26	0,27
P.2.2	60	0,03	0,03	0,04	0,05	0,07	0,08	0,10	0,11	0,12	0,15	0,18	0,20	0,23	0,24	0,26	0,27
P.2.3																	
P.2.4																	
P.3.1																	
P.3.2																	
P.3.3																	
P.4.1	45	0,03	0,03	0,04	0,05	0,07	0,08	0,10	0,11	0,12	0,15	0,18	0,20	0,23	0,24	0,26	0,27
P.4.2	30	0,01	0,02	0,02	0,03	0,04	0,05	0,06	0,08	0,09	0,11	0,13	0,15	0,17	0,19	0,20	0,21
M.1.1	35	0,01	0,02	0,02	0,03	0,04	0,05	0,06	0,08	0,09	0,11	0,13	0,15	0,17	0,19	0,20	0,21
M.2.1	35	0,01	0,02	0,02	0,03	0,04	0,05	0,06	0,08	0,09	0,11	0,13	0,15	0,17	0,19	0,20	0,21
M.3.1	35	0,01	0,02	0,02	0,03	0,04	0,05	0,06	0,08	0,09	0,11	0,13	0,15	0,17	0,19	0,20	0,21
K.1.1																	
K.1.2																	
K.2.1																	
K.2.2																	
K.3.1																	
K.3.2																	
N.1.1	160	0,04	0,05	0,06	0,08	0,09	0,11	0,13	0,15	0,16	0,20	0,24	0,27	0,31	0,32	0,34	0,36
N.1.2	160	0,04	0,05	0,06	0,08	0,09	0,11	0,13	0,15	0,16	0,20	0,24	0,27	0,31	0,32	0,34	0,36
N.2.1	130	0,04	0,05	0,06	0,08	0,09	0,11	0,13	0,15	0,16	0,20	0,24	0,27	0,31	0,32	0,34	0,36
N.2.2	130	0,04	0,05	0,06	0,08	0,09	0,11	0,13	0,15	0,16	0,20	0,24	0,27	0,31	0,32	0,34	0,36
N.2.3	110	0,03	0,04	0,04	0,05	0,07	0,08	0,10	0,11	0,12	0,15	0,18	0,20	0,23	0,24	0,26	0,27
N.3.1	160	0,04	0,05	0,06	0,08	0,09	0,11	0,13	0,15	0,16	0,20	0,24	0,27	0,31	0,32	0,34	0,36
N.3.2	160	0,04	0,05	0,06	0,08	0,09	0,11	0,13	0,15	0,16	0,20	0,24	0,27	0,31	0,32	0,34	0,36
N.3.3	225	0,03	0,04	0,04	0,05	0,07	0,08	0,10	0,11	0,12	0,15	0,18	0,20	0,23	0,24	0,26	0,27
N.4.1																	
S.1.1																	
S.1.2																	
S.2.1																	
S.2.2																	
S.2.3																	
S.3.1	30	0,002	0,004	0,01	0,01	0,01	0,02	0,03	0,03	0,04	0,06	0,07	0,09	0,10	0,11	0,12	0,12
S.3.2	20	0,002	0,004	0,01	0,01	0,01	0,02	0,03	0,03	0,04	0,06	0,07	0,09	0,10	0,11	0,12	0,12
S.3.3																	
H.1.1																	
H.1.2																	
H.1.3																	
H.1.4																	
H.2.1																	
H.3.1																	
O.1.1	100	0,01	0,02	0,02	0,03	0,04	0,05	0,06	0,08	0,09	0,11	0,13	0,15	0,17	0,19	0,2	0,21
O.1.2	80	0,002	0,004	0,01	0,01	0,02	0,02	0,03	0,04	0,05	0,07	0,09	0,11	0,13	0,13	0,14	0,15
O.2.1																	
O.2.2																	
O.3.1																	



The cutting data is strongly influenced by external conditions, such as the stability of the tool and workpiece clamping, material and type of machine. The specified values represent guideline cutting data that must be corrected according to the usage conditions.

Index	11 713 ..., 11 714 ..., 11 715 ..., 11 716 ...																	
	with through coolant v _c (m/min)	3xD / 5xD																
		≤ Ø 1	Ø 1-1,25	Ø 1,25-1,5	Ø 1,5-2	Ø 2-2,5	Ø 2,5-3	Ø 3-4	Ø 4-5	Ø 5-6	Ø 6-8	Ø 8-10	Ø 10-12	Ø 12-14	Ø 14-16	Ø 16-18	Ø 18-20	
		f (mm/rev)																
P.1.1	85	0,03	0,03	0,04	0,05	0,07	0,08	0,10	0,11	0,12	0,15	0,18	0,20	0,23	0,24	0,26	0,27	
P.1.2																		
P.1.3																		
P.1.4																		
P.1.5																		
P.2.1	75	0,03	0,03	0,04	0,05	0,07	0,08	0,10	0,11	0,12	0,15	0,18	0,20	0,23	0,24	0,26	0,27	
P.2.2	65	0,03	0,03	0,04	0,05	0,07	0,08	0,10	0,11	0,12	0,15	0,18	0,20	0,23	0,24	0,26	0,27	
P.2.3																		
P.2.4																		
P.3.1																		
P.3.2																		
P.3.3																		
P.4.1	55	0,03	0,03	0,04	0,05	0,07	0,08	0,10	0,11	0,12	0,15	0,18	0,20	0,23	0,24	0,26	0,27	
P.4.2	40	0,01	0,02	0,02	0,03	0,04	0,05	0,06	0,08	0,09	0,11	0,13	0,15	0,17	0,19	0,20	0,21	
M.1.1	45	0,01	0,02	0,02	0,03	0,04	0,05	0,06	0,08	0,09	0,11	0,13	0,15	0,17	0,19	0,20	0,21	
M.2.1	45	0,01	0,02	0,02	0,03	0,04	0,05	0,06	0,08	0,09	0,11	0,13	0,15	0,17	0,19	0,20	0,21	
M.3.1	45	0,01	0,02	0,02	0,03	0,04	0,05	0,06	0,08	0,09	0,11	0,13	0,15	0,17	0,19	0,20	0,21	
K.1.1																		
K.1.2																		
K.2.1																		
K.2.2																		
K.3.1																		
K.3.2																		
N.1.1	200	0,04	0,05	0,06	0,08	0,09	0,11	0,13	0,15	0,16	0,20	0,24	0,27	0,31	0,32	0,34	0,36	
N.1.2	200	0,04	0,05	0,06	0,08	0,09	0,11	0,13	0,15	0,16	0,20	0,24	0,27	0,31	0,32	0,34	0,36	
N.2.1	160	0,04	0,05	0,06	0,08	0,09	0,11	0,13	0,15	0,16	0,20	0,24	0,27	0,31	0,32	0,34	0,36	
N.2.2	160	0,04	0,05	0,06	0,08	0,09	0,11	0,13	0,15	0,16	0,20	0,24	0,27	0,31	0,32	0,34	0,36	
N.2.3	140	0,03	0,03	0,04	0,05	0,07	0,08	0,10	0,11	0,12	0,15	0,18	0,2	0,23	0,24	0,26	0,27	
N.3.1	200	0,04	0,05	0,06	0,08	0,09	0,11	0,13	0,15	0,16	0,20	0,24	0,27	0,31	0,32	0,34	0,36	
N.3.2	200	0,04	0,05	0,06	0,08	0,09	0,11	0,13	0,15	0,16	0,20	0,24	0,27	0,31	0,32	0,34	0,36	
N.3.3	280	0,03	0,03	0,04	0,05	0,07	0,08	0,10	0,11	0,12	0,15	0,18	0,20	0,23	0,24	0,26	0,27	
N.4.1																		
S.1.1																		
S.1.2																		
S.2.1	15	0,002	0,004	0,01	0,01	0,01	0,02	0,03	0,03	0,04	0,06	0,07	0,09	0,10	0,11	0,12	0,12	
S.2.2	15	0,002	0,004	0,01	0,01	0,01	0,02	0,03	0,03	0,04	0,06	0,07	0,09	0,10	0,11	0,12	0,12	
S.2.3	15	0,002	0,004	0,01	0,01	0,01	0,02	0,03	0,03	0,04	0,06	0,07	0,09	0,10	0,11	0,12	0,12	
S.3.1	35	0,002	0,004	0,01	0,01	0,01	0,02	0,03	0,03	0,04	0,06	0,07	0,09	0,10	0,11	0,12	0,12	
S.3.2	25	0,002	0,004	0,01	0,01	0,01	0,02	0,03	0,03	0,04	0,06	0,07	0,09	0,10	0,11	0,12	0,12	
S.3.3																		
H.1.1																		
H.1.2																		
H.1.3																		
H.1.4																		
H.2.1																		
H.3.1																		
O.1.1	120	0,01	0,02	0,02	0,03	0,04	0,05	0,06	0,08	0,09	0,11	0,13	0,15	0,17	0,19	0,20	0,21	
O.1.2	100	0,002	0,004	0,01	0,01	0,02	0,02	0,03	0,04	0,05	0,07	0,09	0,11	0,13	0,13	0,14	0,15	
O.2.1																		
O.2.2																		
O.3.1																		

Cutting data standard values – Type N – Twist drills

Index	10 700 ..., 10 710 ...														
	without through coolant v _c (m/min)	3xD / 5xD													
		≤ Ø 1	Ø 1–1,5	Ø 1,5–2	Ø 2–3	Ø 3–4	Ø 4–5	Ø 5–6	Ø 6–8	Ø 8–10	Ø 10–12	Ø 12–14	Ø 14–16	Ø 16–18	Ø 18–20
f (mm/rev)															
P.1.1	75	0,03	0,05	0,07	0,10	0,12	0,14	0,16	0,2	0,24	0,28	0,31	0,35	0,40	0,45
P.1.2	65	0,03	0,05	0,07	0,10	0,12	0,14	0,16	0,2	0,24	0,28	0,31	0,35	0,40	0,45
P.1.3	65	0,03	0,05	0,07	0,10	0,12	0,14	0,16	0,2	0,24	0,28	0,31	0,35	0,40	0,45
P.1.4	65	0,03	0,04	0,05	0,08	0,10	0,11	0,13	0,15	0,18	0,20	0,23	0,26	0,29	0,33
P.1.5	65	0,03	0,04	0,05	0,08	0,10	0,11	0,13	0,15	0,18	0,20	0,23	0,26	0,29	0,33
P.2.1	70	0,03	0,05	0,07	0,10	0,12	0,14	0,16	0,20	0,24	0,28	0,31	0,35	0,40	0,45
P.2.2	65	0,03	0,04	0,05	0,08	0,10	0,11	0,13	0,15	0,18	0,20	0,23	0,26	0,29	0,33
P.2.3	65	0,03	0,04	0,05	0,08	0,10	0,11	0,13	0,15	0,18	0,20	0,23	0,26	0,29	0,33
P.2.4	50	0,03	0,04	0,05	0,08	0,10	0,11	0,13	0,15	0,18	0,20	0,23	0,26	0,29	0,33
P.3.1	65	0,03	0,04	0,05	0,08	0,10	0,11	0,13	0,15	0,18	0,20	0,23	0,26	0,29	0,33
P.3.2	50	0,03	0,04	0,05	0,08	0,10	0,11	0,13	0,15	0,18	0,20	0,23	0,26	0,29	0,33
P.3.3															
P.4.1															
P.4.2															
M.1.1															
M.2.1															
M.3.1															
K.1.1	70	0,03	0,04	0,05	0,08	0,10	0,11	0,13	0,15	0,18	0,20	0,23	0,26	0,29	0,33
K.1.2	70	0,03	0,04	0,05	0,08	0,10	0,11	0,13	0,15	0,18	0,20	0,23	0,26	0,29	0,33
K.2.1	70	0,03	0,04	0,05	0,08	0,10	0,11	0,13	0,15	0,18	0,20	0,23	0,26	0,29	0,33
K.2.2	70	0,03	0,04	0,05	0,08	0,10	0,11	0,13	0,15	0,18	0,20	0,23	0,26	0,29	0,33
K.3.1	70	0,03	0,04	0,05	0,08	0,10	0,11	0,13	0,15	0,18	0,20	0,23	0,26	0,29	0,33
K.3.2	70	0,03	0,04	0,05	0,08	0,10	0,11	0,13	0,15	0,18	0,20	0,23	0,26	0,29	0,33
N.1.1	200	0,01	0,01	0,01	0,02	0,03	0,04	0,05	0,07	0,09	0,11	0,13	0,15	0,18	0,20
N.1.2	200	0,01	0,01	0,01	0,02	0,03	0,04	0,05	0,07	0,09	0,11	0,13	0,15	0,18	0,20
N.2.1	160	0,01	0,01	0,01	0,02	0,03	0,04	0,05	0,07	0,09	0,11	0,13	0,15	0,18	0,20
N.2.2	160	0,01	0,01	0,01	0,02	0,03	0,04	0,05	0,07	0,09	0,11	0,13	0,15	0,18	0,20
N.2.3	130	0,01	0,01	0,01	0,02	0,03	0,04	0,05	0,07	0,09	0,11	0,13	0,15	0,18	0,20
N.3.1	160	0,003	0,01	0,01	0,01	0,02	0,03	0,04	0,06	0,09	0,11	0,14	0,16	0,18	0,20
N.3.2	160	0,003	0,01	0,01	0,01	0,02	0,03	0,04	0,06	0,09	0,11	0,14	0,16	0,18	0,20
N.3.3	100	0,003	0,01	0,01	0,01	0,02	0,03	0,04	0,06	0,09	0,11	0,14	0,16	0,18	0,20
N.4.1	200	0,01	0,01	0,01	0,02	0,03	0,04	0,05	0,07	0,09	0,11	0,13	0,15	0,18	0,20
S.1.1															
S.1.2															
S.2.1															
S.2.2															
S.2.3															
S.3.1	30	0,002	0,003	0,003	0,01	0,01	0,02	0,03	0,04	0,05	0,06	0,07	0,08	0,09	0,10
S.3.2	20	0,002	0,003	0,003	0,01	0,01	0,02	0,03	0,04	0,05	0,06	0,07	0,08	0,09	0,10
S.3.3															
H.1.1															
H.1.2															
H.1.3															
H.1.4															
H.2.1															
H.3.1															
O.1.1															
O.1.2															
O.2.1															
O.2.2															
O.3.1															



The cutting data is highly dependent on external conditions, such as stability of the tool and workpiece clamping, material and machine type!
The values indicated represent possible cutting data which may need to be corrected depending on operating conditions !

Cutting data standard values – WTX – SB

Index	10 767 ..., 10 772 ..., 10 783 ..., 10 788 ...					
			3xD			
	without through coolant	with through coolant	Ø 2–5	Ø 5–8	Ø 8–12	Ø 12–16
	v _c (m/min)		f (mm/rev)			
P.1.1	110	120	0,13	0,18	0,25	0,30
P.1.2	105	115	0,12	0,18	0,24	0,29
P.1.3	100	110	0,12	0,17	0,23	0,28
P.1.4	95	105	0,11	0,16	0,21	0,26
P.1.5	90	100	0,11	0,15	0,20	0,25
P.2.1	105	120	0,15	0,22	0,29	0,36
P.2.2	95	110	0,14	0,20	0,27	0,33
P.2.3	85	100	0,13	0,18	0,24	0,29
P.2.4	65	75	0,12	0,16	0,21	0,26
P.3.1	70	85	0,12	0,18	0,24	0,29
P.3.2	60	65	0,11	0,15	0,20	0,24
P.3.3	50	65	0,09	0,12	0,15	0,19
P.4.1	50	65	0,08	0,12	0,16	0,19
P.4.2	50	65	0,08	0,12	0,16	0,19
M.1.1						
M.2.1						
M.3.1						
K.1.1	85	120	0,17	0,26	0,36	0,45
K.1.2	75	100	0,15	0,22	0,29	0,36
K.2.1	100	160	0,17	0,25	0,34	0,42
K.2.2	75	100	0,15	0,22	0,29	0,36
K.3.1	80	90	0,16	0,23	0,32	0,39
K.3.2	70	80	0,14	0,19	0,25	0,31
N.1.1						
N.1.2						
N.2.1						
N.2.2						
N.2.3						
N.3.1						
N.3.2						
N.3.3						
N.4.1						
S.1.1						
S.1.2						
S.2.1						
S.2.2						
S.2.3						
S.3.1						
S.3.2						
S.3.3						
H.1.1	25	25	0,06	0,08	0,11	0,14
H.1.2						
H.1.3						
H.1.4						
H.2.1	35	35	0,08	0,11	0,14	0,18
H.3.1						
O.1.1						
O.1.2						
O.2.1						
O.2.2						
O.3.1						



The cutting data depends extremely on the external conditions, the material and machine type.
The indicated values are possible values which have to be increased or reduced according to the application conditions.

Cutting data standard values – WTX – Mini

Index	11 770 ...				
	without through coolant v_c (m/min)	5xD			
		$\leq \varnothing 1,0$	$> \varnothing 1,0-1,5$	$> \varnothing 1,5-2,0$	$> \varnothing 2,0-2,9$
		f (mm/rev)			
P.1.1	75	0,01	0,01	0,013	0,015
P.1.2	65	0,02	0,02	0,025	0,03
P.1.3	65	0,01	0,01	0,013	0,015
P.1.4	65	0,01	0,01	0,013	0,015
P.1.5	70	0,01	0,01	0,013	0,015
P.2.1	70	0,01	0,01	0,013	0,015
P.2.2	65	0,01	0,01	0,013	0,015
P.2.3	65	0,02	0,02	0,025	0,03
P.2.4	65	0,01	0,01	0,013	0,015
P.3.1					
P.3.2					
P.3.3					
P.4.1					
P.4.2					
M.1.1					
M.2.1					
M.3.1					
K.1.1	70	0,01	0,01	0,013	0,015
K.1.2	70	0,01	0,01	0,013	0,015
K.2.1	70	0,01	0,01	0,013	0,015
K.2.2	70	0,01	0,01	0,013	0,015
K.3.1	70	0,01	0,01	0,013	0,015
K.3.2	70	0,01	0,01	0,013	0,015
N.1.1	200	0,01	0,01	0,013	0,015
N.1.2	200	0,01	0,01	0,013	0,015
N.2.1	160	0,01	0,01	0,013	0,015
N.2.2	180	0,01	0,01	0,013	0,015
N.2.3	130	0,01	0,01	0,013	0,015
N.3.1	160	0,01	0,01	0,013	0,015
N.3.2	160	0,01	0,01	0,013	0,015
N.3.3	100	0,01	0,01	0,013	0,015
N.4.1	200	0,01	0,01	0,013	0,015
S.1.1					
S.1.2					
S.2.1					
S.2.2					
S.2.3					
S.3.1	30	0,01	0,01	0,013	0,015
S.3.2	20	0,01	0,01	0,013	0,015
S.3.3					
H.1.1					
H.1.2					
H.1.3					
H.1.4					
H.2.1					
H.3.1					
O.1.1					
O.1.2					
O.2.1					
O.2.2					
O.3.1					



The cutting data depends extremely on the external conditions, the material and machine type.
The indicated values are possible values which have to be increased or reduced according to the application conditions.

Cutting data standard values – WTX – Micro

2

Index	10 693 ...							
	with through coolant v _c (m/min)	MMS	5xD					
			≤ Ø 1,0	> Ø 1,0–1,25	> Ø 1,25–1,5	> Ø 1,5–2,0	> Ø 2,0–2,5	> Ø 2,5–3,0
			f (mm/rev)					
P.1.1	70	51	0,028	0,034	0,045	0,070	0,095	0,115
P.1.2	60	43	0,028	0,034	0,045	0,070	0,095	0,115
P.1.3	60	43	0,028	0,034	0,045	0,070	0,095	0,115
P.1.4	60	43	0,028	0,034	0,045	0,070	0,095	0,115
P.1.5	60	43	0,028	0,034	0,045	0,070	0,095	0,115
P.2.1	70	51	0,028	0,034	0,045	0,070	0,095	0,115
P.2.2	60	43	0,028	0,034	0,045	0,070	0,095	0,115
P.2.3	60	43	0,028	0,034	0,045	0,070	0,095	0,115
P.2.4								
P.3.1	60	43	0,028	0,034	0,045	0,070	0,095	0,115
P.3.2	50	34	0,028	0,034	0,045	0,070	0,095	0,115
P.3.3								
P.4.1	50		0,015	0,018	0,024	0,040	0,060	0,080
P.4.2	35		0,015	0,018	0,024	0,040	0,060	0,080
M.1.1	40		0,015	0,018	0,024	0,040	0,060	0,080
M.2.1	40		0,015	0,018	0,024	0,040	0,060	0,080
M.3.1	40		0,015	0,018	0,024	0,040	0,060	0,080
K.1.1	70	51	0,028	0,034	0,045	0,070	0,095	0,115
K.1.2	70	51	0,028	0,034	0,045	0,070	0,095	0,115
K.2.1	70	51	0,028	0,034	0,045	0,070	0,095	0,115
K.2.2	70	51	0,028	0,034	0,045	0,070	0,095	0,115
K.3.1	70	51	0,028	0,034	0,045	0,070	0,095	0,115
K.3.2	70	51	0,028	0,034	0,045	0,070	0,095	0,115
N.1.1								
N.1.2								
N.2.1								
N.2.2								
N.2.3								
N.3.1								
N.3.2								
N.3.3								
N.4.1								
S.1.1	15		0,015	0,018	0,024	0,040	0,060	0,080
S.1.2	15		0,015	0,018	0,024	0,040	0,060	0,080
S.2.1	10		0,015	0,018	0,024	0,040	0,060	0,080
S.2.2	10		0,015	0,018	0,024	0,040	0,060	0,080
S.2.3								
S.3.1	30		0,015	0,018	0,024	0,040	0,060	0,080
S.3.2	20		0,015	0,018	0,024	0,040	0,060	0,080
S.3.3								
H.1.1								
H.1.2								
H.1.3								
H.1.4								
H.2.1								
H.3.1								
O.1.1								
O.1.2								
O.2.1								
O.2.2								
O.3.1								

Cutting data standard values – WTX – Micro

Index	10 694 ..., 10 695 ...							
	8xD / 12xD							
	with through coolant	MMS	≤ Ø 1,0	> Ø 1,0–1,25	> Ø 1,25–1,5	> Ø 1,5–2,0	> Ø 2,0–2,5	> Ø 2,5–3,0
	v_c (m/min)		f (mm/rev)					
P.1.1	70	51	0,028	0,034	0,045	0,070	0,095	0,115
P.1.2	60	43	0,028	0,034	0,045	0,070	0,095	0,115
P.1.3	60	43	0,028	0,034	0,045	0,070	0,095	0,115
P.1.4	60	43	0,028	0,034	0,045	0,070	0,095	0,115
P.1.5	60	43	0,028	0,034	0,045	0,070	0,095	0,115
P.2.1	70	51	0,028	0,034	0,045	0,070	0,095	0,115
P.2.2	60	43	0,028	0,034	0,045	0,070	0,095	0,115
P.2.3	60	43	0,028	0,034	0,045	0,070	0,095	0,115
P.2.4								
P.3.1	60	43	0,028	0,034	0,045	0,070	0,095	0,115
P.3.2	50	34	0,028	0,034	0,045	0,070	0,095	0,115
P.3.3								
P.4.1	50		0,015	0,018	0,024	0,040	0,060	0,080
P.4.2	35		0,015	0,018	0,024	0,040	0,060	0,080
M.1.1	40		0,015	0,018	0,024	0,040	0,060	0,080
M.2.1	40		0,015	0,018	0,024	0,040	0,060	0,080
M.3.1	40		0,015	0,018	0,024	0,040	0,060	0,080
K.1.1	70	51	0,028	0,034	0,045	0,070	0,095	0,115
K.1.2	70	51	0,028	0,034	0,045	0,070	0,095	0,115
K.2.1	70	51	0,028	0,034	0,045	0,070	0,095	0,115
K.2.2	70	51	0,028	0,034	0,045	0,070	0,095	0,115
K.3.1	70	51	0,028	0,034	0,045	0,070	0,095	0,115
K.3.2	70	51	0,028	0,034	0,045	0,070	0,095	0,115
N.1.1								
N.1.2								
N.2.1								
N.2.2								
N.2.3								
N.3.1								
N.3.2								
N.3.3								
N.4.1								
S.1.1	15		0,015	0,018	0,024	0,040	0,060	0,080
S.1.2	15		0,015	0,018	0,024	0,040	0,060	0,080
S.2.1	10		0,015	0,018	0,024	0,040	0,060	0,080
S.2.2	10		0,015	0,018	0,024	0,040	0,060	0,080
S.2.3								
S.3.1	30		0,015	0,018	0,024	0,040	0,060	0,080
S.3.2	20		0,015	0,018	0,024	0,040	0,060	0,080
S.3.3								
H.1.1								
H.1.2								
H.1.3								
H.1.4								
H.2.1								
H.3.1								
O.1.1								
O.1.2								
O.2.1								
O.2.2								
O.3.1								



The cutting data depends extremely on the external conditions, the material and machine type.
The indicated values are possible values which have to be increased or reduced according to the application conditions.

Index	10 696 ..., 10 697 ..., 10 698 ..., 10 699 ...							
	16xD / 20xD / 25xD / 30xD							
	with through coolant v _c (m/min)	≤ Ø 1,0	> Ø 1,0–1,25	> Ø 1,25–1,5	> Ø 1,5–2,0	> Ø 2,0–2,5	> Ø 2,5–3,0	
	f (mm/rev)							
P.1.1	58	0,028	0,034	0,045	0,070	0,095	0,115	
P.1.2	50	0,028	0,034	0,045	0,070	0,095	0,115	
P.1.3	50	0,028	0,034	0,045	0,070	0,095	0,115	
P.1.4	50	0,028	0,034	0,045	0,070	0,095	0,115	
P.1.5	50	0,028	0,034	0,045	0,070	0,095	0,115	
P.2.1	58	0,028	0,034	0,045	0,070	0,095	0,115	
P.2.2	50	0,028	0,034	0,045	0,070	0,095	0,115	
P.2.3	50	0,028	0,034	0,045	0,070	0,095	0,115	
P.2.4								
P.3.1	50	0,028	0,034	0,045	0,070	0,095	0,115	
P.3.2	42	0,028	0,034	0,045	0,070	0,095	0,115	
P.3.3								
P.4.1	42	0,015	0,018	0,024	0,040	0,060	0,080	
P.4.2	30	0,015	0,018	0,024	0,040	0,060	0,080	
M.1.1	34	0,015	0,018	0,024	0,040	0,060	0,080	
M.2.1	34	0,015	0,018	0,024	0,040	0,060	0,080	
M.3.1	34	0,015	0,018	0,024	0,040	0,060	0,080	
K.1.1	58	0,028	0,034	0,045	0,070	0,095	0,115	
K.1.2	58	0,028	0,034	0,045	0,070	0,095	0,115	
K.2.1	58	0,028	0,034	0,045	0,070	0,095	0,115	
K.2.2	58	0,028	0,034	0,045	0,070	0,095	0,115	
K.3.1	58	0,028	0,034	0,045	0,070	0,095	0,115	
K.3.2	58	0,028	0,034	0,045	0,070	0,095	0,115	
N.1.1								
N.1.2								
N.2.1								
N.2.2								
N.2.3								
N.3.1								
N.3.2								
N.3.3								
N.4.1								
S.1.1								
S.1.2								
S.2.1								
S.2.2								
S.2.3								
S.3.1								
S.3.2								
S.3.3								
H.1.1								
H.1.2								
H.1.3								
H.1.4								
H.2.1								
H.3.1								
O.1.1								
O.1.2								
O.2.1								
O.2.2								
O.3.1								

 Pilot hole required for WTX – Micro deep hole twist drill – see recommended application for WTX – Micro on → page 161

Cutting data standard values – WTX – Feed BR

Index	10 707 ..., 10 711 ...										
	with through coolant	With external coolant <i>v_c</i> (m/min)	MMS	3xD							
				Ø 4	Ø 5	Ø 6	Ø 8	Ø 10	Ø 12	Ø 14	Ø 16
				f (mm/rev)							
P.1.1	75	70	70	0,19	0,22	0,25	0,31	0,36	0,40	0,44	0,47
P.1.2	75	65	65	0,18	0,21	0,24	0,30	0,34	0,39	0,42	0,45
P.1.3	70	65	65	0,17	0,20	0,23	0,28	0,33	0,37	0,40	0,43
P.1.4	65	60	60	0,16	0,19	0,22	0,27	0,31	0,35	0,38	0,41
P.1.5	65	55	55	0,16	0,18	0,21	0,25	0,29	0,33	0,36	0,39
P.2.1	75	65	65	0,22	0,26	0,30	0,37	0,43	0,48	0,52	0,56
P.2.2	70	60	60	0,20	0,24	0,27	0,33	0,39	0,43	0,47	0,51
P.2.3	65	55	55	0,18	0,22	0,25	0,30	0,35	0,39	0,43	0,46
P.2.4	50	40	40	0,17	0,20	0,22	0,27	0,31	0,35	0,38	0,40
P.3.1	55	45	45	0,18	0,21	0,24	0,30	0,35	0,39	0,43	0,46
P.3.2	40	40	40	0,15	0,18	0,20	0,25	0,29	0,32	0,35	0,37
P.3.3	40	30	35	0,13	0,15	0,16	0,20	0,23	0,25	0,27	0,29
P.4.1	40	30	35	0,12	0,14	0,16	0,20	0,23	0,26	0,28	0,30
P.4.2	40	30	35	0,12	0,14	0,16	0,20	0,23	0,26	0,28	0,30
M.1.1	40	25	25	0,09	0,11	0,12	0,15	0,17	0,19	0,21	0,23
M.2.1	35	20	20	0,08	0,09	0,10	0,13	0,15	0,17	0,18	0,19
M.3.1	35	20	20	0,08	0,09	0,10	0,13	0,15	0,17	0,18	0,19
K.1.1	100	70	70	0,25	0,30	0,35	0,45	0,53	0,60	0,66	0,71
K.1.2	85	65	65	0,22	0,26	0,30	0,37	0,43	0,48	0,53	0,56
K.2.1	135	85	100	0,24	0,29	0,34	0,42	0,49	0,56	0,61	0,66
K.2.2	85	65	65	0,22	0,26	0,30	0,37	0,43	0,48	0,53	0,56
K.3.1	75	70	70	0,23	0,28	0,32	0,39	0,46	0,52	0,57	0,61
K.3.2	70	60	60	0,20	0,23	0,26	0,32	0,37	0,41	0,45	0,48
N.1.1											
N.1.2											
N.2.1											
N.2.2											
N.2.3											
N.3.1											
N.3.2											
N.3.3											
N.4.1											
S.1.1											
S.1.2											
S.2.1											
S.2.2											
S.2.3											
S.3.1											
S.3.2											
S.3.3											
H.1.1											
H.1.2											
H.1.3											
H.1.4											
H.2.1											
H.3.1											
O.1.1											
O.1.2											
O.2.1											
O.2.2											
O.3.1											



The cutting data is highly dependent on external conditions, such as stability of the tool and workpiece clamping, material and machine type!
The values indicated represent possible cutting data which may need to be corrected depending on operating conditions !

Index	10 713 ..., 10 719 ...													
	5xD													
	with through coolant	With external coolant v _c (m/min)	MMS	Ø 4	Ø 5	Ø 6	Ø 8	Ø 10	Ø 12	Ø 14	Ø 16	Ø 18	Ø 20	
	f (mm/rev)													
P.1.1	75	70	70	0,19	0,22	0,25	0,31	0,36	0,40	0,44	0,47	0,50	0,52	
P.1.2	75	65	65	0,18	0,21	0,24	0,30	0,34	0,39	0,42	0,45	0,48	0,50	
P.1.3	70	65	65	0,17	0,20	0,23	0,28	0,33	0,37	0,40	0,43	0,45	0,47	
P.1.4	65	60	60	0,16	0,19	0,22	0,27	0,31	0,35	0,38	0,41	0,43	0,45	
P.1.5	65	55	55	0,16	0,18	0,21	0,25	0,29	0,33	0,36	0,39	0,41	0,43	
P.2.1	75	65	65	0,22	0,26	0,30	0,37	0,43	0,48	0,52	0,56	0,59	0,62	
P.2.2	70	60	60	0,20	0,24	0,27	0,33	0,39	0,43	0,47	0,51	0,54	0,56	
P.2.3	65	55	55	0,18	0,22	0,25	0,30	0,35	0,39	0,43	0,46	0,48	0,50	
P.2.4	50	40	40	0,17	0,20	0,22	0,27	0,31	0,35	0,38	0,40	0,42	0,44	
P.3.1	55	45	45	0,18	0,21	0,24	0,30	0,35	0,39	0,43	0,46	0,48	0,50	
P.3.2	40	40	40	0,15	0,18	0,20	0,25	0,29	0,32	0,35	0,37	0,39	0,41	
P.3.3	40	30	35	0,13	0,15	0,16	0,20	0,23	0,25	0,27	0,29	0,30	0,32	
P.4.1	40	30	35	0,12	0,14	0,16	0,20	0,23	0,26	0,28	0,30	0,32	0,33	
P.4.2	40	30	35	0,12	0,14	0,16	0,20	0,23	0,26	0,28	0,30	0,32	0,33	
M.1.1	40	25	25	0,09	0,11	0,12	0,15	0,17	0,19	0,21	0,23	0,24	0,25	
M.2.1	35	20	20	0,08	0,09	0,10	0,13	0,15	0,17	0,18	0,19	0,20	0,21	
M.3.1	35	20	20	0,08	0,09	0,10	0,13	0,15	0,17	0,18	0,19	0,20	0,21	
K.1.1	100	70	70	0,25	0,30	0,35	0,45	0,53	0,60	0,66	0,71	0,75	0,79	
K.1.2	85	65	65	0,22	0,26	0,30	0,37	0,43	0,48	0,53	0,56	0,60	0,62	
K.2.1	135	85	100	0,24	0,29	0,34	0,42	0,49	0,56	0,61	0,66	0,69	0,72	
K.2.2	85	65	65	0,22	0,26	0,30	0,37	0,43	0,48	0,53	0,56	0,60	0,62	
K.3.1	75	70	70	0,23	0,28	0,32	0,39	0,46	0,52	0,57	0,61	0,64	0,67	
K.3.2	70	60	60	0,20	0,23	0,26	0,32	0,37	0,41	0,45	0,48	0,51	0,53	
N.1.1														
N.1.2														
N.2.1														
N.2.2														
N.2.3														
N.3.1														
N.3.2														
N.3.3														
N.4.1														
S.1.1														
S.1.2														
S.2.1														
S.2.2														
S.2.3														
S.3.1														
S.3.2														
S.3.3														
H.1.1														
H.1.2														
H.1.3														
H.1.4														
H.2.1														
H.3.1														
O.1.1														
O.1.2														
O.2.1														
O.2.2														
O.3.1														

Cutting data standard values – WTX – Co-pilot deep hole twist drills

Index	11 018 ...					
	20xD					
	with through coolant	Ø 3-4	Ø > 4-5	Ø > 5-6	Ø > 6-8	Ø > 8-10
	v _c (m/min)	f (mm/rev)				
P.1.1	100	0,07	0,08	0,10	0,12	0,14
P.1.2	90	0,07	0,08	0,10	0,12	0,14
P.1.3	90	0,05	0,06	0,08	0,10	0,11
P.1.4	90	0,05	0,06	0,08	0,10	0,11
P.1.5	95	0,05	0,06	0,08	0,10	0,11
P.2.1	95	0,07	0,08	0,10	0,12	0,14
P.2.2	90	0,05	0,06	0,08	0,10	0,11
P.2.3	90	0,07	0,08	0,10	0,12	0,14
P.2.4	90	0,05	0,06	0,08	0,10	0,11
P.3.1	45	0,03	0,04	0,05	0,06	0,08
P.3.2	70	0,05	0,06	0,08	0,10	0,11
P.3.3	70	0,05	0,06	0,08	0,10	0,11
P.4.1	70	0,03	0,04	0,05	0,06	0,08
P.4.2	45	0,03	0,04	0,05	0,06	0,08
M.1.1	50	0,03	0,04	0,05	0,06	0,08
M.2.1	50	0,03	0,04	0,05	0,06	0,08
M.3.1	50	0,03	0,04	0,05	0,06	0,08
K.1.1	100	0,10	0,13	0,15	0,19	0,23
K.1.2	95	0,10	0,13	0,15	0,19	0,23
K.2.1	100	0,08	0,10	0,13	0,16	0,18
K.2.2	95	0,08	0,10	0,13	0,16	0,18
K.3.1	100	0,08	0,10	0,13	0,16	0,18
K.3.2	95	0,08	0,10	0,13	0,16	0,18
N.1.1						
N.1.2						
N.2.1						
N.2.2						
N.2.3						
N.3.1						
N.3.2						
N.3.3						
N.4.1						
S.1.1						
S.1.2						
S.2.1						
S.2.2						
S.2.3	70	0,05	0,06	0,08	0,10	0,11
S.3.1	30	0,01	0,02	0,02	0,03	0,04
S.3.2	20	0,01	0,02	0,02	0,03	0,04
S.3.3						
H.1.1						
H.1.2						
H.1.3						
H.1.4						
H.2.1						
H.3.1						
O.1.1						
O.1.2						
O.2.1						
O.2.2						
O.3.1						



The cutting data depends extremely on the external conditions, the material and machine type.
The indicated values are possible values which have to be increased or reduced according to the application conditions.

Cutting data standard values – WTX – TB UNI

Index	11 016 ...									11 020 ...								
	with through coolant v _c (m/min)	16xD								with through coolant v _c (m/min)	20xD							
		∅ 2-3	∅ > 3-4	∅ > 4-5	∅ > 5-6	∅ > 6-8	∅ > 8-10	∅ > 10-12	∅ 2-3		∅ > 3-4	∅ > 4-5	∅ > 5-6	∅ > 6-8	∅ > 8-10	∅ > 10-12		
f (mm/rev)																		
P.1.1	105	0,05	0,07	0,08	0,10	0,12	0,14	0,16	100	0,05	0,07	0,08	0,10	0,12	0,14	0,16		
P.1.2	95	0,05	0,07	0,08	0,10	0,12	0,14	0,16	90	0,05	0,07	0,08	0,10	0,12	0,14	0,16		
P.1.3	95	0,04	0,05	0,06	0,08	0,10	0,11	0,13	90	0,04	0,05	0,06	0,08	0,10	0,11	0,13		
P.1.4	95	0,04	0,05	0,06	0,08	0,10	0,11	0,13	90	0,04	0,05	0,06	0,08	0,10	0,11	0,13		
P.1.5	100	0,04	0,05	0,06	0,01	0,10	0,11	0,13	95	0,04	0,05	0,06	0,08	0,10	0,11	0,13		
P.2.1	100	0,05	0,07	0,08	0,10	0,12	0,14	0,16	95	0,05	0,07	0,08	0,10	0,12	0,14	0,16		
P.2.2	95	0,04	0,05	0,06	0,10	0,10	0,11	0,13	90	0,04	0,05	0,06	0,08	0,10	0,11	0,13		
P.2.3	95	0,05	0,07	0,08	0,10	0,12	0,14	0,16	90	0,05	0,07	0,08	0,10	0,12	0,14	0,16		
P.2.4	95	0,04	0,05	0,06	0,10	0,10	0,11	0,13	90	0,04	0,05	0,06	0,08	0,10	0,11	0,13		
P.3.1	50	0,03	0,03	0,04	0,05	0,06	0,08	0,10	45	0,03	0,03	0,04	0,05	0,06	0,08	0,10		
P.3.2	75	0,04	0,05	0,06	0,10	0,10	0,11	0,13	70	0,04	0,05	0,06	0,08	0,10	0,11	0,13		
P.3.3	75	0,04	0,05	0,06	0,10	0,10	0,11	0,13	70	0,04	0,05	0,06	0,08	0,10	0,11	0,13		
P.4.1	75	0,03	0,03	0,04	0,05	0,06	0,08	0,10	70	0,03	0,03	0,04	0,05	0,06	0,08	0,10		
P.4.2	50	0,03	0,03	0,04	0,05	0,06	0,08	0,10	45	0,03	0,03	0,04	0,05	0,06	0,08	0,10		
M.1.1	55	0,03	0,03	0,04	0,05	0,06	0,08	0,10	50	0,03	0,03	0,04	0,05	0,06	0,08	0,10		
M.2.1	55	0,03	0,03	0,04	0,05	0,06	0,08	0,10	50	0,03	0,03	0,04	0,05	0,06	0,08	0,10		
M.3.1	55	0,03	0,03	0,04	0,05	0,06	0,08	0,10	50	0,03	0,03	0,04	0,05	0,06	0,08	0,10		
K.1.1	105	0,08	0,10	0,13	0,15	0,19	0,23	0,27	100	0,08	0,10	0,13	0,15	0,19	0,23	0,27		
K.1.2	100	0,08	0,10	0,13	0,15	0,19	0,23	0,27	95	0,08	0,10	0,13	0,15	0,19	0,23	0,27		
K.2.1	105	0,06	0,08	0,10	0,13	0,16	0,18	0,22	100	0,06	0,08	0,10	0,13	0,16	0,18	0,22		
K.2.2	100	0,06	0,08	0,10	0,13	0,16	0,18	0,22	95	0,06	0,08	0,10	0,13	0,16	0,18	0,22		
K.3.1	105	0,06	0,08	0,10	0,13	0,16	0,18	0,22	100	0,06	0,08	0,10	0,13	0,16	0,18	0,22		
K.3.2	100	0,06	0,08	0,10	0,13	0,16	0,18	0,22	95	0,06	0,08	0,10	0,13	0,16	0,18	0,22		
N.1.1																		
N.1.2																		
N.2.1																		
N.2.2																		
N.2.3																		
N.3.1																		
N.3.2																		
N.3.3																		
N.4.1																		
S.1.1																		
S.1.2																		
S.2.1																		
S.2.2																		
S.2.3	75	0,04	0,05	0,06	0,08	0,10	0,11	0,13	70	0,04	0,05	0,06	0,08	0,10	0,11	0,13		
S.3.1	35	0,01	0,01	0,02	0,02	0,03	0,04	0,05	30	0,01	0,01	0,02	0,02	0,03	0,04	0,05		
S.3.2	25	0,01	0,01	0,02	0,02	0,03	0,04	0,05	20	0,01	0,01	0,02	0,02	0,03	0,04	0,05		
S.3.3																		
H.1.1																		
H.1.2																		
H.1.3																		
H.1.4																		
H.2.1																		
H.3.1																		
O.1.1																		
O.1.2																		
O.2.1																		
O.2.2																		
O.3.1																		



All solid carbide WTX deep hole drills must be used with a pilot bore. The tool must never be run at high speed while not engaged in a material. Please refer to the strategy for the production of deep holes on → Page 160.

Cutting data standard values – WTX – TB UNI

Index	11 025 ...								11 030 ...							
	with through coolant v _c (m/min)	25xD							with through coolant v _c (m/min)	30xD						
		∅ 2-3	∅ >3-4	∅ >4-5	∅ >5-6	∅ >6-8	∅ >8-10	∅ >10-12		∅ 2-3	∅ >3-4	∅ >4-5	∅ >5-6	∅ >6-8	∅ >8-10	∅ >10-12
f (mm/rev)																
P.1.1	90	0,05	0,07	0,09	0,10	0,12	0,14	0,16	85	0,05	0,07	0,09	0,10	0,12	0,14	0,16
P.1.2	80	0,05	0,07	0,09	0,10	0,12	0,14	0,16	75	0,05	0,07	0,09	0,10	0,12	0,14	0,16
P.1.3	80	0,04	0,05	0,06	0,08	0,10	0,11	0,13	75	0,04	0,05	0,06	0,08	0,10	0,11	0,13
P.1.4	80	0,04	0,05	0,06	0,08	0,10	0,11	0,13	75	0,04	0,05	0,06	0,08	0,10	0,11	0,13
P.1.5	85	0,04	0,05	0,06	0,08	0,10	0,11	0,13	80	0,04	0,05	0,06	0,08	0,10	0,11	0,13
P.2.1	85	0,05	0,07	0,09	0,10	0,12	0,14	0,16	80	0,05	0,07	0,09	0,10	0,12	0,14	0,16
P.2.2	80	0,04	0,05	0,06	0,08	0,10	0,11	0,13	75	0,04	0,05	0,06	0,08	0,10	0,11	0,13
P.2.3	80	0,05	0,07	0,09	0,10	0,12	0,14	0,16	75	0,05	0,07	0,09	0,10	0,12	0,14	0,16
P.2.4	80	0,04	0,05	0,06	0,08	0,10	0,11	0,13	75	0,04	0,05	0,06	0,08	0,10	0,11	0,13
P.3.1	45	0,03	0,03	0,04	0,05	0,06	0,08	0,10	40	0,03	0,03	0,04	0,05	0,06	0,08	0,10
P.3.2	65	0,04	0,05	0,06	0,08	0,10	0,11	0,13	60	0,04	0,05	0,06	0,08	0,10	0,11	0,13
P.3.3	65	0,04	0,05	0,06	0,08	0,10	0,11	0,13	60	0,04	0,05	0,06	0,08	0,10	0,11	0,13
P.4.1	65	0,03	0,03	0,04	0,05	0,06	0,08	0,10	60	0,03	0,03	0,04	0,05	0,06	0,08	0,10
P.4.2	45	0,03	0,03	0,04	0,05	0,06	0,08	0,10	40	0,03	0,03	0,04	0,05	0,06	0,08	0,10
M.1.1	50	0,03	0,03	0,04	0,05	0,06	0,08	0,10	45	0,03	0,03	0,04	0,05	0,06	0,08	0,10
M.2.1	50	0,03	0,03	0,04	0,05	0,06	0,08	0,10	45	0,03	0,03	0,04	0,05	0,06	0,08	0,10
M.3.1	50	0,03	0,03	0,04	0,05	0,06	0,08	0,10	45	0,03	0,03	0,04	0,05	0,06	0,08	0,10
K.1.1	90	0,08	0,10	0,13	0,15	0,19	0,23	0,27	85	0,08	0,10	0,13	0,15	0,19	0,23	0,27
K.1.2	85	0,08	0,10	0,13	0,15	0,19	0,23	0,27	80	0,08	0,10	0,13	0,15	0,19	0,23	0,27
K.2.1	90	0,06	0,08	0,10	0,13	0,16	0,18	0,22	85	0,06	0,08	0,10	0,13	0,16	0,18	0,22
K.2.2	85	0,06	0,08	0,10	0,13	0,16	0,18	0,22	80	0,06	0,08	0,10	0,13	0,16	0,18	0,22
K.3.1	90	0,06	0,08	0,10	0,13	0,16	0,18	0,22	85	0,06	0,08	0,10	0,13	0,16	0,18	0,22
K.3.2	85	0,06	0,08	0,10	0,13	0,16	0,18	0,22	80	0,06	0,08	0,10	0,13	0,16	0,18	0,22
N.1.1																
N.1.2																
N.2.1																
N.2.2																
N.2.3																
N.3.1																
N.3.2																
N.3.3																
N.4.1																
S.1.1																
S.1.2																
S.2.1																
S.2.2																
S.2.3	65	0,04	0,05	0,06	0,08	0,10	0,11	0,13	60	0,04	0,05	0,06	0,08	0,10	0,11	0,13
S.3.1																
S.3.2																
S.3.3																
H.1.1																
H.1.2																
H.1.3																
H.1.4																
H.2.1																
H.3.1																
O.1.1																
O.1.2																
O.2.1																
O.2.2																
O.3.1																



The cutting data depends extremely on the external conditions, the material and machine type.
The indicated values are possible values which have to be increased or reduced according to the application conditions.

Index	11 040 ...							11 050 ...				
	40xD							50xD				
	with through coolant	Ø 3-4	Ø > 4-5	Ø > 5-6	Ø > 6-8	Ø > 8-10	with through coolant	Ø 3-4	Ø > 4-5	Ø > 5-6	Ø > 6-8	
	v _c (m/min)	f (mm/rev)						v _c (m/min)	f (mm/rev)			
P.1.1	70	0,05	0,06	0,08	0,10	0,11	70	0,05	0,06	0,08	0,10	
P.1.2	60	0,05	0,06	0,08	0,10	0,11	60	0,05	0,06	0,08	0,10	
P.1.3	60	0,03	0,04	0,05	0,06	0,08	60	0,03	0,04	0,05	0,06	
P.1.4	60	0,03	0,04	0,05	0,06	0,08	60	0,03	0,04	0,05	0,06	
P.1.5	65	0,03	0,04	0,05	0,06	0,08	65	0,03	0,04	0,05	0,06	
P.2.1	65	0,05	0,06	0,08	0,10	0,11	65	0,05	0,06	0,08	0,10	
P.2.2	60	0,03	0,04	0,05	0,06	0,08	60	0,03	0,04	0,05	0,06	
P.2.3	60	0,05	0,06	0,08	0,10	0,11	60	0,05	0,06	0,08	0,10	
P.2.4	60	0,03	0,04	0,05	0,06	0,08	60	0,03	0,04	0,05	0,06	
P.3.1	35	0,03	0,03	0,04	0,05	0,06	35	0,03	0,03	0,04	0,05	
P.3.2	50	0,03	0,04	0,05	0,06	0,08	50	0,03	0,04	0,05	0,06	
P.3.3	50	0,03	0,04	0,05	0,06	0,08	50	0,03	0,04	0,05	0,06	
P.4.1	50	0,03	0,03	0,04	0,05	0,06	50	0,03	0,03	0,04	0,05	
P.4.2	35	0,03	0,03	0,04	0,05	0,06	35	0,03	0,03	0,04	0,05	
M.1.1	40	0,03	0,03	0,04	0,05	0,06	40	0,03	0,03	0,04	0,05	
M.2.1	40	0,03	0,03	0,04	0,05	0,06	40	0,03	0,03	0,04	0,05	
M.3.1	40	0,03	0,03	0,04	0,05	0,06	40	0,03	0,03	0,04	0,05	
K.1.1	70	0,08	0,10	0,13	0,16	0,18	70	0,08	0,10	0,13	0,16	
K.1.2	65	0,08	0,10	0,13	0,16	0,18	65	0,08	0,10	0,13	0,16	
K.2.1	70	0,07	0,09	0,10	0,12	0,14	70	0,07	0,09	0,10	0,12	
K.2.2	65	0,07	0,09	0,10	0,12	0,14	65	0,07	0,09	0,10	0,12	
K.3.1	70	0,07	0,09	0,10	0,12	0,14	70	0,07	0,09	0,10	0,12	
K.3.2	65	0,07	0,09	0,10	0,12	0,14	65	0,07	0,09	0,10	0,12	
N.1.1												
N.1.2												
N.2.1												
N.2.2												
N.2.3												
N.3.1												
N.3.2												
N.3.3												
N.4.1												
S.1.1												
S.1.2												
S.2.1												
S.2.2												
S.2.3	50	0,03	0,04	0,05	0,06	0,08	50	0,03	0,04	0,05	0,06	
S.3.1												
S.3.2												
S.3.3												
H.1.1												
H.1.2												
H.1.3												
H.1.4												
H.2.1												
H.3.1												
O.1.1												
O.1.2												
O.2.1												
O.2.2												
O.3.1												



All solid carbide WTX deep hole drills must be used with a pilot bore. The tool must never be run at high speed while not engaged in a material. Please refer to the strategy for the production of deep holes on → Page 160.

Cutting data standard values – WTX – TB ALU

Index	11 017 ...								11 021 ...							
	with through coolant v_c (m/min)	16xD							with through coolant v_c (m/min)	20xD						
		\emptyset 2-3	\emptyset > 3-4	\emptyset > 4-5	\emptyset > 5-6	\emptyset > 6-8	\emptyset > 8-10	\emptyset > 10-12		\emptyset 2-3	\emptyset > 3-4	\emptyset > 4-5	\emptyset > 5-6	\emptyset > 6-8	\emptyset > 8-10	\emptyset > 10-12
f (mm/rev)								f (mm/rev)								
P.1.1																
P.1.2																
P.1.3																
P.1.4																
P.1.5																
P.2.1																
P.2.2																
P.2.3																
P.2.4																
P.3.1																
P.3.2																
P.3.3																
P.4.1																
P.4.2																
M.1.1																
M.2.1																
M.3.1																
K.1.1																
K.1.2																
K.2.1																
K.2.2																
K.3.1																
K.3.2																
N.1.1	160	0,06	0,08	0,10	0,13	0,16	0,18	0,22	150	0,06	0,08	0,10	0,13	0,16	0,18	0,22
N.1.2	180	0,06	0,08	0,10	0,13	0,16	0,18	0,22	170	0,06	0,08	0,10	0,13	0,16	0,18	0,22
N.2.1	160	0,08	0,11	0,13	0,15	0,19	0,23	0,26	150	0,08	0,11	0,13	0,15	0,19	0,23	0,26
N.2.2	190	0,08	0,11	0,13	0,15	0,19	0,23	0,26	180	0,08	0,11	0,13	0,15	0,19	0,23	0,26
N.2.3	140	0,06	0,08	0,10	0,13	0,16	0,18	0,22	130	0,06	0,08	0,10	0,13	0,16	0,18	0,22
N.3.1	115	0,06	0,08	0,10	0,13	0,16	0,18	0,22	100	0,06	0,08	0,10	0,13	0,16	0,18	0,22
N.3.2	115	0,06	0,08	0,10	0,13	0,16	0,18	0,22	100	0,06	0,08	0,10	0,13	0,16	0,18	0,22
N.3.3	90	0,06	0,08	0,10	0,13	0,16	0,18	0,22	80	0,06	0,08	0,10	0,13	0,16	0,18	0,22
N.4.1																
S.1.1																
S.1.2																
S.2.1																
S.2.2																
S.2.3																
S.3.1																
S.3.2																
S.3.3																
H.1.1																
H.1.2																
H.1.3																
H.1.4																
H.2.1																
H.3.1																
O.1.1																
O.1.2																
O.2.1																
O.2.2																
O.3.1																

 The cutting data depends extremely on the external conditions, the material and machine type.
The indicated values are possible values which have to be increased or reduced according to the application conditions.

Index	11 026 ...									11 031 ...								
	with through coolant v _c (m/min)	25xD								with through coolant v _c (m/min)	30xD							
		∅ 2-3	∅ >3-4	∅ >4-5	∅ >5-6	∅ >6-8	∅ >8-10	∅ >10-12	∅ 2-3		∅ >3-4	∅ >4-5	∅ >5-6	∅ >6-8	∅ >8-10	∅ >10-12		
f (mm/rev)																		
P.1.1																		
P.1.2																		
P.1.3																		
P.1.4																		
P.1.5																		
P.2.1																		
P.2.2																		
P.2.3																		
P.2.4																		
P.3.1																		
P.3.2																		
P.3.3																		
P.4.1																		
P.4.2																		
M.1.1																		
M.2.1																		
M.3.1																		
K.1.1																		
K.1.2																		
K.2.1																		
K.2.2																		
K.3.1																		
K.3.2																		
N.1.1	130	0,06	0,08	0,10	0,13	0,16	0,18	0,22	120	0,04	0,05	0,07	0,08	0,12	0,15	0,18		
N.1.2	150	0,06	0,08	0,10	0,13	0,16	0,18	0,22	140	0,04	0,05	0,07	0,08	0,12	0,15	0,18		
N.2.1	130	0,08	0,11	0,13	0,15	0,19	0,23	0,26	120	0,08	0,11	0,13	0,15	0,19	0,23	0,26		
N.2.2	160	0,08	0,11	0,13	0,15	0,19	0,23	0,26	150	0,08	0,11	0,13	0,15	0,19	0,23	0,26		
N.2.3	120	0,06	0,08	0,10	0,13	0,16	0,18	0,22	110	0,04	0,05	0,07	0,08	0,12	0,15	0,18		
N.3.1	90	0,06	0,08	0,10	0,13	0,16	0,18	0,22	80	0,04	0,05	0,07	0,08	0,12	0,15	0,18		
N.3.2	90	0,06	0,08	0,10	0,13	0,16	0,18	0,22	80	0,04	0,05	0,07	0,08	0,12	0,15	0,18		
N.3.3	75	0,06	0,08	0,10	0,13	0,16	0,18	0,22	70	0,01	0,01	0,02	0,02	0,03	0,04	0,05		
N.4.1																		
S.1.1																		
S.1.2																		
S.2.1																		
S.2.2																		
S.2.3																		
S.3.1																		
S.3.2																		
S.3.3																		
H.1.1																		
H.1.2																		
H.1.3																		
H.1.4																		
H.2.1																		
H.3.1																		
O.1.1																		
O.1.2																		
O.2.1																		
O.2.2																		
O.3.1																		



All solid carbide WTX deep hole drills must be used with a pilot bore. The tool must never be run at high speed while not engaged in a material. Please refer to the strategy for the production of deep holes on → Page 160.

		10 702 ..., 10 703 ..., 10 704 ...											
Index	without through coolant v _c (m/min)	NC-A											
		Ø 2-3	Ø 3-4	Ø 4-5	Ø 5-6	Ø 6-8	Ø 8-10	Ø 10-12	Ø 12-14	Ø 14-16	Ø 16-18	Ø 18-20	
		f (mm/rev)											
P.1.1	75	0,05	0,07	0,08	0,10	0,12	0,14	0,16	0,20	0,24	0,28	0,31	
P.1.2	65	0,05	0,07	0,08	0,10	0,12	0,14	0,16	0,20	0,24	0,28	0,31	
P.1.3	65	0,04	0,05	0,06	0,08	0,10	0,11	0,13	0,15	0,18	0,20	0,23	
P.1.4	65	0,04	0,05	0,06	0,08	0,10	0,11	0,13	0,15	0,18	0,20	0,23	
P.1.5	70	0,04	0,05	0,06	0,08	0,10	0,11	0,13	0,15	0,18	0,20	0,23	
P.2.1	70	0,05	0,07	0,08	0,10	0,12	0,14	0,16	0,20	0,24	0,28	0,31	
P.2.2	65	0,04	0,05	0,06	0,08	0,10	0,11	0,13	0,15	0,18	0,20	0,23	
P.2.3	65	0,05	0,07	0,08	0,10	0,12	0,14	0,16	0,20	0,24	0,28	0,31	
P.2.4	65	0,04	0,05	0,06	0,08	0,10	0,11	0,13	0,15	0,18	0,20	0,23	
P.3.1													
P.3.2													
P.3.3													
P.4.1													
P.4.2													
M.1.1													
M.2.1													
M.3.1													
K.1.1	70	0,04	0,05	0,06	0,08	0,10	0,13	0,15	0,18	0,20	0,23	0,27	
K.1.2	70	0,04	0,05	0,06	0,08	0,10	0,11	0,13	0,15	0,18	0,20	0,23	
K.2.1	70	0,04	0,05	0,06	0,08	0,10	0,11	0,13	0,15	0,18	0,20	0,23	
K.2.2	70	0,04	0,05	0,06	0,08	0,10	0,11	0,13	0,15	0,18	0,20	0,23	
K.3.1	70	0,04	0,05	0,06	0,08	0,10	0,11	0,13	0,15	0,18	0,20	0,23	
K.3.2	70	0,04	0,05	0,06	0,08	0,10	0,11	0,13	0,15	0,18	0,20	0,23	
N.1.1	200	0,01	0,01	0,02	0,02	0,03	0,04	0,05	0,07	0,09	0,11	0,13	
N.1.2	200	0,01	0,01	0,02	0,02	0,03	0,04	0,05	0,07	0,09	0,11	0,13	
N.2.1	160	0,01	0,01	0,02	0,02	0,03	0,04	0,05	0,07	0,09	0,11	0,13	
N.2.2	180	0,01	0,01	0,02	0,02	0,03	0,04	0,05	0,07	0,09	0,11	0,13	
N.2.3	130	0,01	0,01	0,02	0,02	0,03	0,04	0,05	0,07	0,09	0,11	0,13	
N.3.1	160	0,01	0,01	0,01	0,01	0,02	0,03	0,04	0,06	0,09	0,11	0,14	
N.3.2	160	0,01	0,01	0,01	0,01	0,02	0,03	0,04	0,06	0,09	0,11	0,14	
N.3.3	100	0,01	0,01	0,01	0,01	0,02	0,03	0,04	0,06	0,09	0,11	0,14	
N.4.1													
S.1.1													
S.1.2													
S.2.1													
S.2.2													
S.2.3													
S.3.1													
S.3.2													
S.3.3													
H.1.1													
H.1.2													
H.1.3													
H.1.4													
H.2.1													
H.3.1													
O.1.1													
O.1.2													
O.2.1													
O.2.2													
O.3.1													

Cutting data standard values – Solid Carbide NC-A TiAlN

Index	10 716 ..., 10 717 ..., 10 718 ...											
	NC-A TiAlN											
	without through coolant v _c (m/min)	Ø 2-3	Ø 3-4	Ø 4-5	Ø 5-6	Ø 6-8	Ø 8-10	Ø 10-12	Ø 12-14	Ø 14-16	Ø 16-18	Ø 18-20
	f (mm/rev)											
P.1.1	75	0,05	0,07	0,08	0,10	0,12	0,14	0,16	0,20	0,24	0,28	0,31
P.1.2	65	0,05	0,07	0,08	0,10	0,12	0,14	0,16	0,20	0,24	0,28	0,31
P.1.3	65	0,04	0,05	0,06	0,08	0,10	0,11	0,13	0,15	0,18	0,20	0,23
P.1.4	65	0,04	0,05	0,06	0,08	0,10	0,11	0,13	0,15	0,18	0,20	0,23
P.1.5	70	0,04	0,05	0,06	0,08	0,10	0,11	0,13	0,15	0,18	0,20	0,23
P.2.1	70	0,05	0,07	0,08	0,10	0,12	0,14	0,16	0,20	0,24	0,28	0,31
P.2.2	65	0,04	0,05	0,06	0,08	0,10	0,11	0,13	0,15	0,18	0,20	0,23
P.2.3	65	0,05	0,07	0,08	0,10	0,12	0,14	0,16	0,20	0,24	0,28	0,31
P.2.4	65	0,04	0,05	0,06	0,08	0,10	0,11	0,13	0,15	0,18	0,20	0,23
P.3.1												
P.3.2												
P.3.3												
P.4.1												
P.4.2												
M.1.1												
M.2.1												
M.3.1												
K.1.1	70	0,04	0,05	0,06	0,08	0,10	0,13	0,15	0,18	0,20	0,23	0,26
K.1.2	70	0,04	0,05	0,06	0,08	0,10	0,11	0,13	0,15	0,18	0,20	0,23
K.2.1	70	0,04	0,05	0,06	0,08	0,10	0,11	0,13	0,15	0,18	0,20	0,23
K.2.2	70	0,04	0,05	0,06	0,08	0,10	0,11	0,13	0,15	0,18	0,20	0,23
K.3.1	70	0,04	0,05	0,06	0,08	0,10	0,11	0,13	0,15	0,18	0,20	0,23
K.3.2	70	0,04	0,05	0,06	0,08	0,10	0,11	0,13	0,15	0,18	0,20	0,23
N.1.1	200	0,01	0,01	0,02	0,02	0,03	0,04	0,05	0,07	0,09	0,11	0,13
N.1.2	200	0,01	0,01	0,02	0,02	0,03	0,04	0,05	0,07	0,09	0,11	0,13
N.2.1	160	0,01	0,01	0,02	0,02	0,03	0,04	0,05	0,07	0,09	0,11	0,13
N.2.2	180	0,01	0,01	0,02	0,02	0,03	0,04	0,05	0,07	0,09	0,11	0,13
N.2.3	130	0,01	0,01	0,02	0,02	0,03	0,04	0,05	0,07	0,09	0,11	0,13
N.3.1	160	0,01	0,01	0,01	0,01	0,02	0,03	0,04	0,06	0,09	0,11	0,14
N.3.2	160	0,01	0,01	0,01	0,01	0,02	0,03	0,04	0,06	0,09	0,11	0,14
N.3.3	100	0,01	0,01	0,01	0,01	0,02	0,03	0,04	0,06	0,09	0,11	0,14
N.4.1												
S.1.1												
S.1.2												
S.2.1												
S.2.2												
S.2.3												
S.3.1												
S.3.2												
S.3.3												
H.1.1	28	0,02	0,03	0,04	0,04	0,05	0,06	0,06	0,07	0,07	0,08	0,08
H.1.2	16	0,02	0,03	0,04	0,04	0,05	0,06	0,06	0,07	0,07	0,08	0,08
H.1.3												
H.1.4												
H.2.1												
H.3.1												
O.1.1												
O.1.2												
O.2.1												
O.2.2												
O.3.1												



The cutting data is highly dependent on external conditions, such as stability of the tool and workpiece clamping, material and machine type!
The values indicated represent possible cutting data which may need to be corrected depending on operating conditions !

Index	10 724 ..., 10 726 ..., 10 727 ...									
	NC-A TiAlN									
	without through coolant v _c (m/min)	Ø 3-4	Ø 4-5	Ø 5-6	Ø 6-8	Ø 8-10	Ø 10-12	Ø 12-14	Ø 14-16	
	f (mm/rev)									
P.1.1	75	0,07	0,08	0,10	0,12	0,14	0,16	0,20	0,24	
P.1.2	65	0,07	0,08	0,10	0,12	0,14	0,16	0,20	0,24	
P.1.3	65	0,05	0,06	0,08	0,10	0,11	0,13	0,15	0,18	
P.1.4	65	0,05	0,06	0,08	0,10	0,11	0,13	0,15	0,18	
P.1.5	70	0,05	0,06	0,08	0,10	0,11	0,13	0,15	0,18	
P.2.1	70	0,07	0,08	0,10	0,12	0,14	0,16	0,20	0,24	
P.2.2	65	0,05	0,06	0,08	0,10	0,11	0,13	0,15	0,18	
P.2.3	65	0,07	0,08	0,10	0,12	0,14	0,16	0,20	0,24	
P.2.4	65	0,05	0,06	0,08	0,10	0,11	0,13	0,15	0,18	
P.3.1										
P.3.2										
P.3.3										
P.4.1										
P.4.2										
M.1.1										
M.2.1										
M.3.1										
K.1.1	70	0,05	0,06	0,08	0,10	0,13	0,15	0,18	0,20	
K.1.2	70	0,05	0,06	0,08	0,10	0,11	0,13	0,15	0,18	
K.2.1	70	0,05	0,06	0,08	0,10	0,11	0,13	0,15	0,18	
K.2.2	70	0,05	0,06	0,08	0,10	0,11	0,13	0,15	0,18	
K.3.1	70	0,05	0,06	0,08	0,10	0,11	0,13	0,15	0,18	
K.3.2	70	0,05	0,06	0,08	0,10	0,11	0,13	0,15	0,18	
N.1.1	200	0,01	0,02	0,02	0,03	0,04	0,05	0,07	0,09	
N.1.2	200	0,01	0,02	0,02	0,03	0,04	0,05	0,07	0,09	
N.2.1	160	0,01	0,02	0,02	0,03	0,04	0,05	0,07	0,09	
N.2.2	180	0,01	0,02	0,02	0,03	0,04	0,05	0,07	0,09	
N.2.3	130	0,01	0,02	0,02	0,03	0,04	0,05	0,07	0,09	
N.3.1	160	0,01	0,01	0,01	0,02	0,03	0,04	0,06	0,09	
N.3.2	160	0,01	0,01	0,01	0,02	0,03	0,04	0,06	0,09	
N.3.3	100	0,01	0,01	0,01	0,02	0,03	0,04	0,06	0,09	
N.4.1										
S.1.1										
S.1.2										
S.2.1										
S.2.2										
S.2.3										
S.3.1										
S.3.2										
S.3.3										
H.1.1	30	0,03	0,04	0,04	0,05	0,06	0,06	0,07	0,07	
H.1.2	15	0,03	0,04	0,04	0,05	0,06	0,06	0,07	0,07	
H.1.3										
H.1.4										
H.2.1										
H.3.1										
O.1.1										
O.1.2										
O.2.1										
O.2.2										
O.3.1										

Cutting data standard values – WTX – Change

Index	10 919 ...					
	v _c (m/min)	UNI				
		≥ Ø 12–15,7	> Ø 15,7–20	> Ø 20–25	> Ø 25–32	> Ø 32–41
		f (mm/rev)				
P.1.1	120	0,27	0,31	0,34	0,36	0,36
P.1.2	115	0,26	0,30	0,32	0,34	0,35
P.1.3	110	0,25	0,28	0,31	0,32	0,33
P.1.4	105	0,24	0,27	0,29	0,31	0,31
P.1.5	100	0,22	0,25	0,28	0,29	0,30
P.2.1	120	0,32	0,37	0,40	0,42	0,43
P.2.2	110	0,29	0,33	0,36	0,38	0,39
P.2.3	100	0,26	0,30	0,33	0,35	0,35
P.2.4	75	0,23	0,26	0,29	0,30	0,31
P.3.1	85	0,26	0,30	0,33	0,35	0,35
P.3.2	65	0,22	0,25	0,27	0,28	0,29
P.3.3	65	0,17	0,19	0,21	0,22	0,22
P.4.1	65	0,17	0,20	0,22	0,23	0,23
P.4.2	65	0,17	0,20	0,22	0,23	0,23
M.1.1						
M.2.1						
M.3.1						
K.1.1	110	0,37	0,42	0,46	0,49	0,50
K.1.2	90	0,29	0,33	0,36	0,38	0,39
K.2.1	145	0,34	0,39	0,42	0,45	0,46
K.2.2	90	0,29	0,33	0,36	0,38	0,39
K.3.1	80	0,35	0,40	0,44	0,46	0,47
K.3.2	70	0,28	0,32	0,34	0,36	0,37
N.1.1						
N.1.2						
N.2.1						
N.2.2						
N.2.3						
N.3.1						
N.3.2						
N.3.3						
N.4.1						
S.1.1						
S.1.2						
S.2.1						
S.2.2						
S.2.3						
S.3.1						
S.3.2						
S.3.3						
H.1.1						
H.1.2						
H.1.3						
H.1.4						
H.2.1						
H.3.1						
O.1.1						
O.1.2						
O.2.1						
O.2.2						
O.3.1						



The cutting data is highly dependent on external conditions, such as stability of the tool and workpiece clamping, material and machine type!
The values indicated represent possible cutting data which may need to be corrected depending on operating conditions !

		10 923 ...				
Index	v _c (m/min)	P				
		≥ Ø 12–15,7	> Ø 15,7–20	> Ø 20–25	> Ø 25–32	> Ø 32–41
		f (mm/rev)				
P.1.1	120	0,32	0,36	0,39	0,41	0,42
P.1.2	115	0,30	0,34	0,37	0,39	0,40
P.1.3	110	0,29	0,32	0,35	0,37	0,38
P.1.4	105	0,27	0,31	0,34	0,35	0,36
P.1.5	100	0,26	0,29	0,32	0,34	0,34
P.2.1	120	0,37	0,42	0,46	0,49	0,49
P.2.2	110	0,34	0,38	0,42	0,44	0,45
P.2.3	100	0,30	0,35	0,38	0,40	0,40
P.2.4	75	0,27	0,30	0,33	0,35	0,35
P.3.1	85	0,30	0,35	0,38	0,40	0,40
P.3.2	65	0,25	0,28	0,31	0,32	0,33
P.3.3	65	0,19	0,22	0,24	0,25	0,25
P.4.1	65	0,20	0,23	0,25	0,26	0,27
P.4.2	65	0,20	0,23	0,25	0,26	0,27
M.1.1						
M.2.1						
M.3.1						
K.1.1	110	0,41	0,47	0,51	0,54	0,55
K.1.2	90	0,33	0,37	0,41	0,43	0,43
K.2.1	145	0,38	0,43	0,47	0,50	0,51
K.2.2	90	0,33	0,37	0,41	0,43	0,43
K.3.1	80	0,35	0,40	0,44	0,46	0,47
K.3.2	70	0,28	0,32	0,34	0,36	0,37
N.1.1						
N.1.2						
N.2.1						
N.2.2						
N.2.3						
N.3.1						
N.3.2						
N.3.3						
N.4.1						
S.1.1						
S.1.2						
S.2.1						
S.2.2						
S.2.3						
S.3.1						
S.3.2						
S.3.3						
H.1.1						
H.1.2						
H.1.3						
H.1.4						
H.2.1						
H.3.1						
O.1.1						
O.1.2						
O.2.1						
O.2.2						
O.3.1						



For through holes, the feed must be reduced by approx. 30% when exiting the hole. For more accurate positioning, precentre with a 142° NC spot drill. With Type VA 5xD and 8xD, enter the hole with reduced feed of 0.05 – 0.06 mm/revolution.

Cutting data standard values – WTX – Change

Index	10 921 ...					10 924 ...				
	VA					GG				
	v _c (m/min)	≥ Ø 12–15,7	> Ø 15,7–20	> Ø 20–25	> Ø 25–32	v _c (m/min)	≥ Ø 12–15,7	> Ø 15,7–20	> Ø 20–25	> Ø 25–32
		f (mm/rev)					f (mm/rev)			
P.1.1	110	0,25	0,28	0,30	0,32					
P.1.2	105	0,24	0,27	0,29	0,31					
P.1.3	100	0,22	0,25	0,28	0,29					
P.1.4	95	0,21	0,24	0,26	0,28					
P.1.5	90	0,20	0,23	0,25	0,26					
P.2.1	110	0,29	0,33	0,36	0,38					
P.2.2	100	0,26	0,30	0,33	0,35					
P.2.3	90	0,24	0,27	0,29	0,31					
P.2.4	70	0,21	0,24	0,26	0,27					
P.3.1	75	0,24	0,27	0,30	0,31					
P.3.2	60	0,19	0,22	0,24	0,25					
P.3.3	60	0,15	0,17	0,18	0,19					
P.4.1	60	0,16	0,18	0,19	0,20					
P.4.2	60	0,16	0,18	0,19	0,20					
M.1.1	55	0,20	0,23	0,25	0,26					
M.2.1	50	0,17	0,19	0,21	0,22					
M.3.1	50	0,17	0,19	0,21	0,22					
K.1.1	95	0,37	0,42	0,46	0,49	120	0,49	0,56	0,62	0,65
K.1.2	80	0,29	0,33	0,36	0,38	100	0,39	0,45	0,49	0,51
K.2.1	130	0,34	0,39	0,42	0,45	160	0,45	0,52	0,57	0,60
K.2.2	80	0,29	0,33	0,36	0,38	100	0,39	0,45	0,49	0,51
K.3.1	70	0,32	0,36	0,39	0,41	90	0,42	0,48	0,52	0,55
K.3.2	65	0,25	0,28	0,31	0,33	80	0,34	0,38	0,41	0,44
N.1.1										
N.1.2										
N.2.1										
N.2.2										
N.2.3										
N.3.1										
N.3.2										
N.3.3										
N.4.1										
S.1.1	30	0,14	0,16	0,17	0,18					
S.1.2	20	0,10	0,11	0,12	0,13					
S.2.1	20	0,10	0,11	0,12	0,13					
S.2.2	15	0,12	0,14	0,15	0,16					
S.2.3	15	0,10	0,11	0,12	0,13					
S.3.1	40	0,17	0,20	0,22	0,23					
S.3.2	30	0,15	0,17	0,18	0,19					
S.3.3	25	0,12	0,14	0,15	0,16					
H.1.1										
H.1.2										
H.1.3										
H.1.4										
H.2.1										
H.3.1										
O.1.1										
O.1.2										
O.2.1										
O.2.2										
O.3.1										



The cutting data is highly dependent on external conditions, such as stability of the tool and workpiece clamping, material and machine type!
The values indicated represent possible cutting data which may need to be corrected depending on operating conditions !

Index	10 922 ...				
	AL				
	v _c (m/min)	≥ Ø 12-15,7	> Ø 15,7-20	> Ø 20-25	> Ø 25-32
f (mm/rev)					
P.1.1					
P.1.2					
P.1.3					
P.1.4					
P.1.5					
P.2.1					
P.2.2					
P.2.3					
P.2.4					
P.3.1					
P.3.2					
P.3.3					
P.4.1					
P.4.2					
M.1.1					
M.2.1					
M.3.1					
K.1.1					
K.1.2					
K.2.1					
K.2.2					
K.3.1					
K.3.2					
N.1.1	330	0,27	0,31	0,34	0,36
N.1.2	300	0,25	0,28	0,31	0,32
N.2.1	250	0,33	0,37	0,41	0,43
N.2.2	220	0,33	0,37	0,41	0,43
N.2.3	180	0,33	0,37	0,41	0,43
N.3.1	200	0,41	0,47	0,51	0,54
N.3.2	120	0,33	0,37	0,41	0,43
N.3.3	140	0,25	0,28	0,31	0,32
N.4.1					
S.1.1					
S.1.2					
S.2.1					
S.2.2					
S.2.3					
S.3.1					
S.3.2					
S.3.3					
H.1.1					
H.1.2					
H.1.3					
H.1.4					
H.2.1					
H.3.1					
O.1.1					
O.1.2					
O.2.1					
O.2.2					
O.3.1					

 With through-holes the feedrate should be reduced at the break out by approx. 30 %. Use 142° NC Spot Drill to ensure positional accuracy. Use reduced feedrate of 0.05 – 0.06 mm/U when using type VA 5xD and 8xD drill.

Cutting data standard values – WTX – Change Feed

Index	10 925 ...							
	UNI							
	with through coolant	With external coolant v_c (m/min)	MMS	$\geq \varnothing 14,0$	$> \varnothing 17,5$	$> \varnothing 21,5$	$> \varnothing 26,0$	$\varnothing 32,0$
	f (mm/rev)							
P.1.1	100	90	90	0,45	0,51	0,55	0,58	0,60
P.1.2	95	85	85	0,43	0,48	0,53	0,55	0,57
P.1.3	90	80	80	0,41	0,46	0,50	0,53	0,54
P.1.4	85	75	75	0,39	0,44	0,48	0,50	0,51
P.1.5	80	75	75	0,37	0,42	0,45	0,47	0,49
P.2.1	100	85	85	0,54	0,60	0,65	0,69	0,71
P.2.2	90	75	75	0,49	0,55	0,59	0,62	0,64
P.2.3	80	70	70	0,44	0,49	0,53	0,56	0,58
P.2.4	65	55	55	0,39	0,43	0,47	0,49	0,51
P.3.1	70	60	60	0,44	0,49	0,53	0,56	0,58
P.3.2	55	50	50	0,36	0,40	0,43	0,46	0,47
P.3.3	55	40	45	0,28	0,31	0,33	0,35	0,36
P.4.1	55	40	45	0,29	0,32	0,35	0,37	0,38
P.4.2	55	40	45	0,29	0,32	0,35	0,37	0,38
M.1.1								
M.2.1								
M.3.1								
K.1.1	110	75	75	0,68	0,77	0,83	0,88	0,90
K.1.2	90	70	70	0,54	0,61	0,66	0,69	0,71
K.2.1	145	90	110	0,63	0,71	0,77	0,81	0,83
K.2.2	90	70	70	0,54	0,61	0,66	0,69	0,71
K.3.1	80	70	70	0,58	0,65	0,71	0,75	0,77
K.3.2	70	65	65	0,46	0,52	0,56	0,59	0,61
N.1.1								
N.1.2								
N.2.1								
N.2.2								
N.2.3								
N.3.1								
N.3.2								
N.3.3								
N.4.1								
S.1.1								
S.1.2								
S.2.1								
S.2.2								
S.2.3								
S.3.1								
S.3.2								
S.3.3								
H.1.1								
H.1.2								
H.1.3								
H.1.4								
H.2.1								
H.3.1								
O.1.1								
O.1.2								
O.2.1								
O.2.2								
O.3.1								



The cutting data is highly dependent on external conditions, such as stability of the tool and workpiece clamping, material and machine type!
The values indicated represent possible cutting data which may need to be corrected depending on operating conditions !

Cutting data standard values – WPC – Change

Index	11 910 ...				
	UNI				
	v _c (m/min)	Ø 14–16	> Ø 16–20	> Ø 20–25	> Ø 25–30
		f (mm/rev)			
P.1.1	100	0,22	0,25	0,28	0,32
P.1.2	100	0,27	0,31	0,35	0,39
P.1.3	100	0,27	0,31	0,35	0,39
P.1.4	90	0,25	0,28	0,32	0,35
P.1.5	90	0,25	0,28	0,32	0,35
P.2.1	100	0,25	0,28	0,32	0,35
P.2.2	100	0,25	0,28	0,32	0,35
P.2.3	100	0,25	0,28	0,32	0,35
P.2.4	80	0,21	0,24	0,27	0,30
P.3.1	70	0,20	0,22	0,25	0,28
P.3.2	70	0,18	0,21	0,24	0,26
P.3.3	60	0,17	0,19	0,22	0,24
P.4.1	55	0,17	0,19	0,22	0,24
P.4.2	55	0,17	0,19	0,22	0,24
M.1.1					
M.2.1					
M.3.1					
K.1.1	110	0,37	0,42	0,47	0,53
K.1.2	100	0,31	0,35	0,39	0,44
K.2.1	100	0,37	0,42	0,47	0,53
K.2.2	90	0,31	0,35	0,39	0,44
K.3.1	100	0,37	0,42	0,47	0,53
K.3.2	90	0,31	0,35	0,39	0,44
N.1.1					
N.1.2					
N.2.1					
N.2.2					
N.2.3					
N.3.1					
N.3.2					
N.3.3					
N.4.1					
S.1.1					
S.1.2					
S.2.1					
S.2.2					
S.2.3					
S.3.1					
S.3.2					
S.3.3					
H.1.1					
H.1.2					
H.1.3					
H.1.4					
H.2.1					
H.3.1					
O.1.1					
O.1.2					
O.2.1					
O.2.2					
O.3.1					







The cutting data is highly dependent on external conditions, such as stability of the tool and workpiece clamping, material and machine type!
The values indicated represent possible cutting data which may need to be corrected depending on operating conditions!

Type overview – WTX High performance drilling tools

- ▲ good self-centring
- ▲ optimum swarf control
- ▲ precise radial run-out
- ▲ excellent alignment precision
- ▲ high-quality surface finish
- ▲ close drilling tolerances
- ▲ limited hardening of peripheral zones of the material
- ▲ good chip evacuation even with large drilling depths

 For all products that are marked with the video icon, a relevant product video can be viewed at cuttingtools.int/en/type-overview-wtx

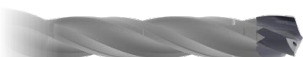

UNI		<ul style="list-style-type: none"> ▲ high-performance solid carbide drill for universal application, for all materials up to 1200 N/mm² 	DRAGONSKIN	
Feed UNI		<ul style="list-style-type: none"> ▲ solid carbide high feed drills with 3 cutting edges ▲ very good positional accuracy 	DRAGONSKIN	
Speed UNI		<ul style="list-style-type: none"> ▲ for double the cutting speed ▲ asymmetric point geometry permits performance improvement when drilling steel and cast iron by up to 60 % 	DRAGONSKIN	
Quattro 4F		<ul style="list-style-type: none"> ▲ with additional guide land for best alignment accuracy, concentricity and positional accuracy 	DRAGONSKIN	
180		<ul style="list-style-type: none"> ▲ for inclined surfaces up to 45° and flat bottom holes 		
TB		<ul style="list-style-type: none"> ▲ solid carbide deep hole drill, up to 50xD without peck drilling ▲ 4 or 6 facet head geometry for excellent alignment accuracy 		
CP		<ul style="list-style-type: none"> ▲ Ensures an even safer deep hole drilling process ▲ For optimal guidance of the deep hole twist drill for hole depths > 30xD 		
VA		<ul style="list-style-type: none"> ▲ first choice for corrosion and acid resistant steels ▲ for volume production 		
Speed VA		<ul style="list-style-type: none"> ▲ Designed for high cutting speeds in corrosion and acid-resistant steels 		
AL		<ul style="list-style-type: none"> ▲ solid carbide high performance drill specially for the machining of aluminium, copper and brass ▲ 6 facet geometry for excellent hole quality 	DRAGONSKIN	
Ti		<ul style="list-style-type: none"> ▲ Specialist for the cost-effective machining of titanium, titanium alloys and heat-resistant alloys ▲ Also suitable for machining corrosion-resistant and acid-resistant steels 	DRAGONSKIN	
H		<ul style="list-style-type: none"> ▲ high-performance drill for hardened steels from 45 to 70 HRC 	DRAGONSKIN	
HFDS		<ul style="list-style-type: none"> ▲ Four fluted high-feed drill ▲ Specially designed for steel processing ▲ Innovative cutting edge geometry guarantees high positioning accuracy 	DRAGONSKIN	
MINI		<ul style="list-style-type: none"> ▲ solid carbide micro drill for the precise manufacture of very small holes from Ø 0.1 to 2.9 mm 		
MICRO		<ul style="list-style-type: none"> ▲ Universal high-performance micro drill ▲ Specialised geometry and coating ▲ Pilot drill for WTX Micro deep hole twist drill 	DRAGONSKIN	
Change		<ul style="list-style-type: none"> ▲ replaceable head drills with the performance level of a solid carbide drill, from Ø 12.0 mm to 41.0 mm 		
Change Feed		<ul style="list-style-type: none"> ▲ exchangeable head drill with three cutting edges for even greater performance, from Ø 14.0 mm to 32.0 mm 		
Feed BR		<ul style="list-style-type: none"> ▲ Solid carbide high-performance drill reamer ▲ Drilling and reaming in one operation ▲ Three drilling edges and six reaming edges 	DRAGONSKIN	
SB		<ul style="list-style-type: none"> ▲ Solid carbide short step drill for steels and cast iron materials ▲ For core hole plus countersink for thread cutting and forming 	DRAGONSKIN	

Important application criteria for WTX drills

Offset

The axial run-out of the axis between a rotating work piece and a stationary tool must not exceed 0.04 mm. A larger run-out reduces tool life and drilling quality and can lead to tool breakage.

Run-out

The concentricity error when the tool is rotating should not exceed 0.015 mm.

Cooling lubricant

With internally cooled tools the coolant pressure should be min. 20 bar.

High-quality semi-synthetic or emulsion coolants with min. 10 % oil content and EP additives are recommended. This allows better life, and achieves higher tolerance accuracy and better surface quality. A fine filter system is recommended to prevent possible clogging of the coolant channels.

Drilling into full material

Due to the geometric design of the solid carbide drills, they are suitable for drilling into solid material.

With solid carbide drills $\leq 12xD$ drilling can be carried out in solid material without the need for centering and spot drilling operations.

Flute run-out

When using WTX drills a safety margin of at least 1 to 1.5 x D must be maintained between the work piece and the flute outlet groove of the drill to ensure optimum chip evacuation and prevent chip clogging and tool fracture.

Peck drilling

Pecking should be avoided as there is a very high risk of fracture caused by chips left behind or flushed into the hole.

Secondary tools

If a smaller diameter WTX drill is used as a following tool in the same hole, it should have a smaller drill point angle to ensure that it centres properly.

Interrupted cut

Reduce the feedrate on entry to and from cross holes

Drill exit

To avoid severe burr formation, reduce v_c and f .

Workpiece clamping

To avoid tool breakages, care must be taken to ensure a proper workpiece clamping without vibration or workpiece deflection.

Tool Clamping

With optimum clamping high alignment accuracy and tolerances (IT7-8) are possible.

Due to the high surface quality reaming operations can often be dispensed with.

Machine Requirements

Please note the performance diagram

Cutting data table

To control the chip length (comma chip) the feed rates should be no lower than the lower limits quoted in the cutting data table.

Feed rate f in mm/rev.

Drilling capacity relative to the diameter: $v_c = 80$ m/min.

Tensile strength of the material = 600 N/mm²

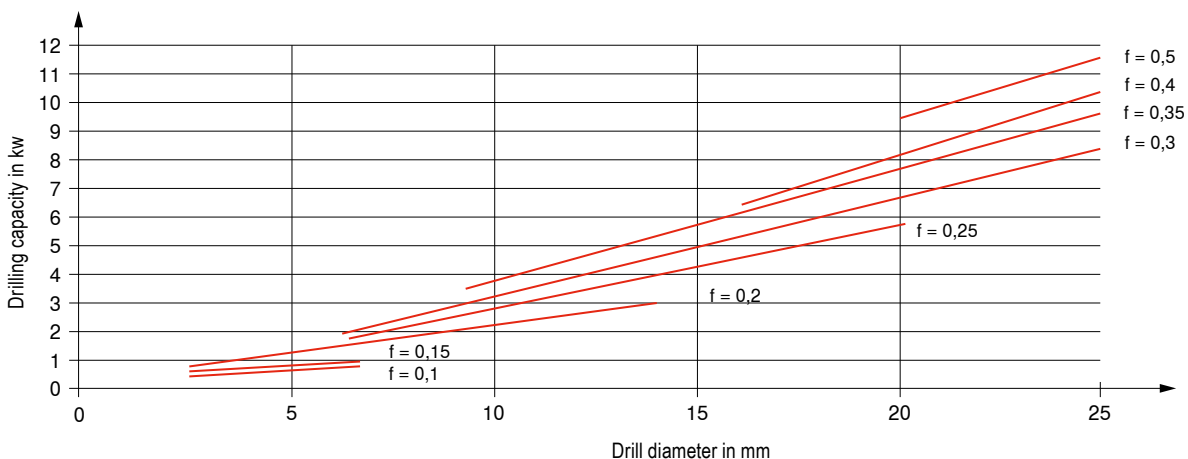

Strategy for the production of deep holes with the WTX solid carbide deep hole drill

1 Producing the pilot hole

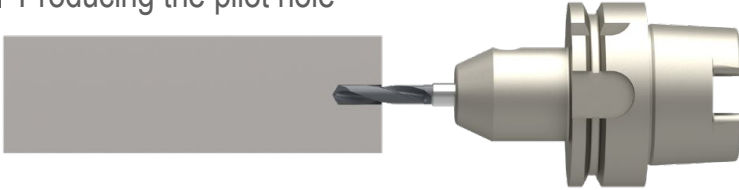

- ▲ For the pilot hole, we recommend a WTX drill 3xD / 5xD with the same nominal diameter
- ▲ The pilot hole should be 0.01–0.03 mm larger in diameter and at least 3xD deep.
- ▲ It is essential to ensure that the point angle of the pilot drill is bigger than the point angle of the deep hole drill.
- ▲ From a hole depth of 40xD, we recommend a pilot hole with our Co-Pilot deep hole twist drill CP 20 UNI.

2 Movement of the deep hole drill into the pilot hole



- ▲ Move the WTX deep hole drill without coolant pressure and with reduced speed ($n = 200\text{--}300$ 1/min) into the pilot hole at a feed of $v_f = 1.000$ mm/min
- ▲ Approx. 2 mm before reaching the bottom of the hole (end of the pilot hole), stop the feed, switch on the coolant and wait for a short time until the recommended pressure is reached. Then increase the spindle speed to the recommended speed as smoothly as possible.

3 Drilling to required depth without pecking

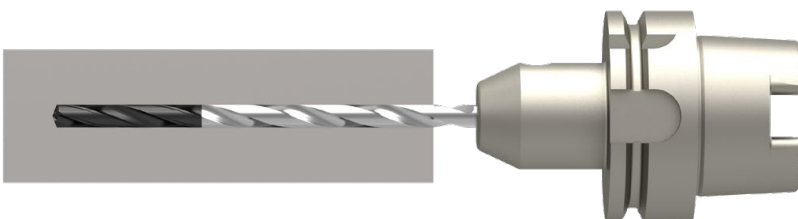

- ▲ Reduce feed rate for cross holes and at drill exit by 50%

4 Retracting the drill

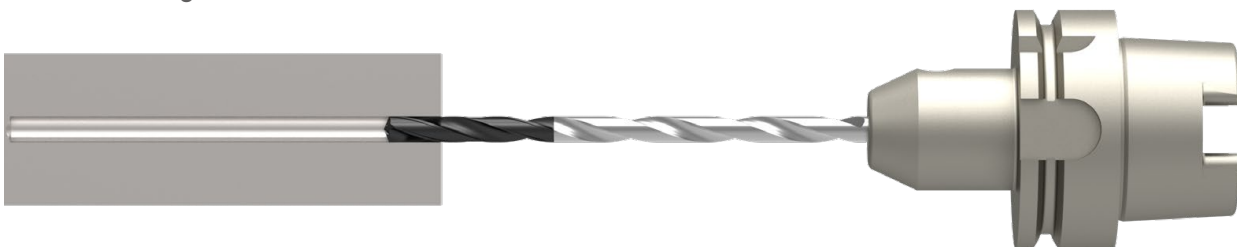

- ▲ Retract the drill to approximately the depth of the pilot hole.
- ▲ Reduce the rpm to a low speed ($n = 200\text{--}300$ 1/min).
- ▲ Use normal rapid feed ($V_f = 3.000$ mm/min) when exiting the hole.



For horizontal deep drilling operations from 40xD, move the deep hole drill into the hole counter-clockwise at 200 1/min. This prevents sagging of the deep hole drill.



It is essential to ensure that deep hole drills **never** run unsupported at full speed in the machine !

WTX – Micro – recommended application

General references

- ▲ During vertical machining, a pilot hole is not required for regular and straight surfaces from Ø 1.0 mm up to a length of 12xD due to the excellent self-centring. During horizontal drilling, a pilot drill must be used for irregular and angled surfaces.
The WTX Micro 5xD is recommended as a pilot drill.
- ▲ To guarantee problem-free insertion of the deep hole twist drill in the pilot hole, during horizontal machining 90° countersinking with suitable NC countersink is recommended.
- ▲ During vertical machining, drills from Ø 1.0 mm up to a length of 12xD can also be operated outside the pilot hole without a reduction in speed.
- ▲ For through holes, the feed per revolution must be reduced by 50% before exiting the hole.
- ▲ For long-chipping materials, pecking may be required every 3xD from a hole depth of 10xD. Peck drilling (retraction) should occur at the pilot hole depth.
- ▲ Due to the small thro' coolant Ø during micro drilling, effective filtration of the cooling medium is of the utmost importance.
Drill < Ø 2.0 mm Filter ≤ 0.010 mm
Drill < Ø 3.0 mm Filter ≤ 0.020 mm
- ▲ The longer the coolant is in the machine, suspended particles and particulate matter in the cooling medium prevent effective coolant flow. Regular replacement of the coolant is therefore recommended.
- ▲ A suitable clamping device with maximum radial run-out accuracy and balance quality is required for process-secure production.
Radial run-out accuracy ≤ 0.003 mm
Suitable for high-speed areas
- ▲ To guarantee a process-secure drilling process, a minimum pressure of 30 bar must be present.

1 Producing the pilot hole



- ▲ Pilot hole depth: min. 3xD
- ▲ It must be ensured that the prepared pilot hole is free from chips to avoid blocking of the micro deep hole twist drill cutting edges

2 Entering the pilot hole with a deep hole twist drill



- ▲ Speed 300 1/min (reverse rotation sometimes possible)
- ▲ Entry speed approx. 1.000 mm/min
- ▲ Switch on cooling
- ▲ Increase parameters 0.5–1.0 mm before reaching the bottom of the pilot hole

3 Deep hole drilling



- ▲ At hole depth without pecking

4 Retracting the drill



- ▲ Retract drill approx. 1xD
- ▲ Reduce speed to 300 1/min
- ▲ Exit speed approx. 1.000 mm/min
- ▲ Switch off emulsion before exiting the hole

Tolerances and angles

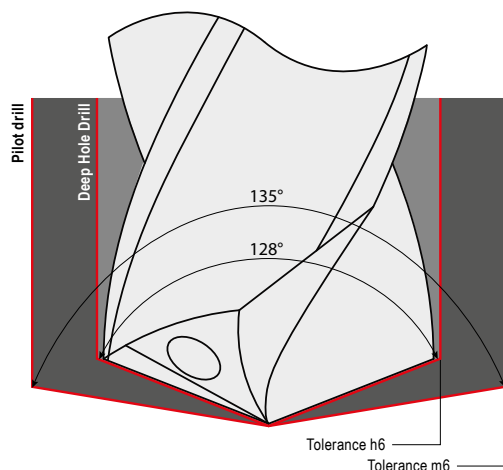

The following must apply to use the pilot and deep hole twist drill consecutively and without collisions:
 $\Delta D = \text{ØD (pilot hole)} - \text{ØD (deep hole)} > 0$

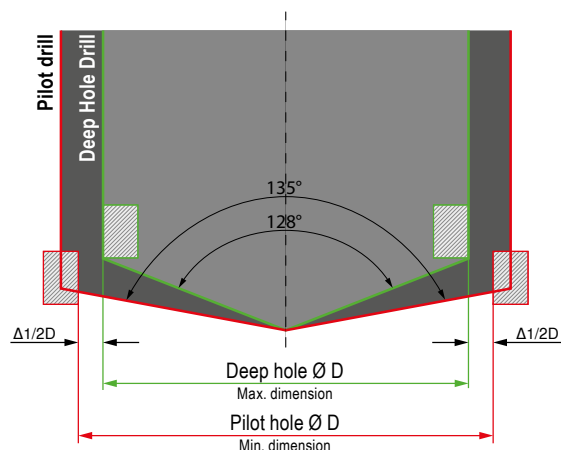

Application notes for WTX – Change Feed and WTX – Change exchangeable head drills

Coolant conditions

Coolant pressure dependent on drilling depth:

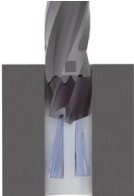
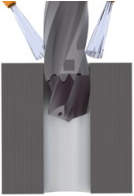
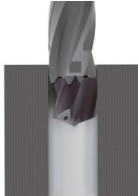
with thro' coolant	with external cooling	without coolant supply
		
1xD: 8 bar ✓	1xD: 8 bar ✓	max. bore depth: 3xD
3xD: 8 bar ✓	3xD: 8 bar ✓	
5xD: 12 bar ✓	5xD: 12 bar ✗	
8xD: 25 bar ✓	8xD: 25 bar ✗	
12xD: 25 bar ✓	12xD: 25 bar ✗	

Runout accuracy

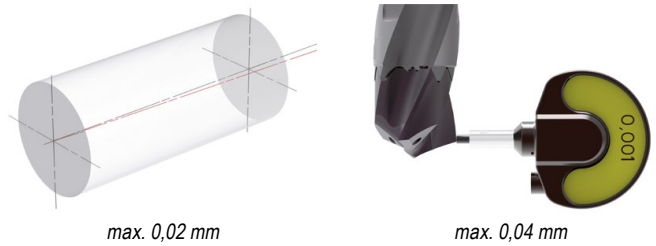

Max. entry and exit angle for the WTX – Change Feed

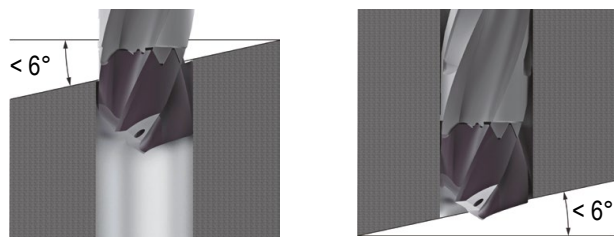

When entering and exiting angled surfaces, reduce v_f by 50 %.

Max. entry and exit angle for the WTX – Change

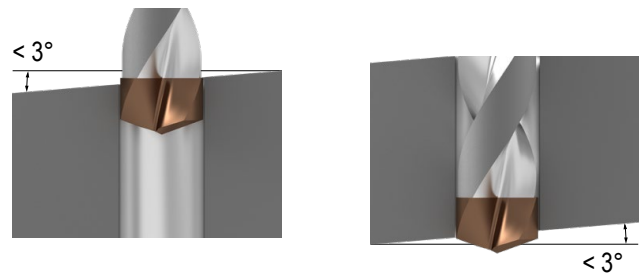

When entering and exiting angled surfaces, reduce v_f by 50 %.

Exiting a through hole

▲ WTX – Change Feed and WTX – Change

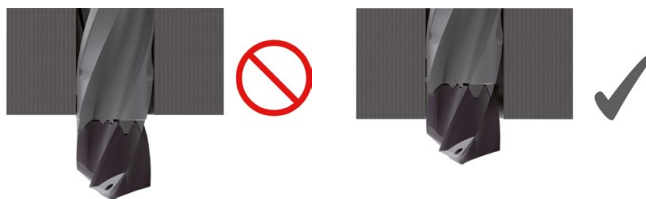

For through holes, it must be ensured that the exchangeable head does not fully protrude from the hole.

Do not retract at rapid feedrate

For withdrawal, a rate of 5 times the value of the feed rate is recommended.

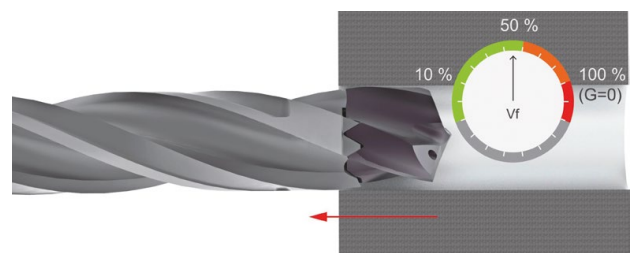

Machining situations

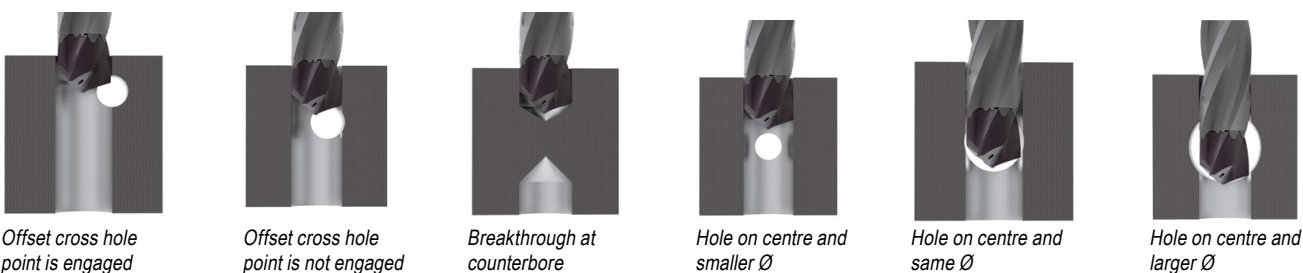

WTX – Change Feed ✓	WTX – Change Feed ✗	WTX – Change Feed ✓	WTX – Change Feed ✓	WTX – Change Feed ✗	WTX – Change Feed ✗
WTX – Change ✓	WTX – Change ✗	WTX – Change ✗	WTX – Change ✓	WTX – Change ✗	WTX – Change ✗

Application notes for WPC – Change indexable insert drill

Assembly of the indexable insert

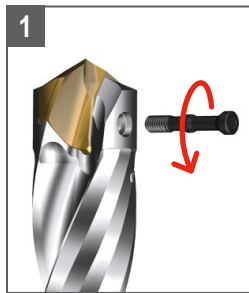

1
Loosen the clamping screw anti-clockwise using a TORX PLUS® screwdriver (screwdriver not included in the scope of supply).

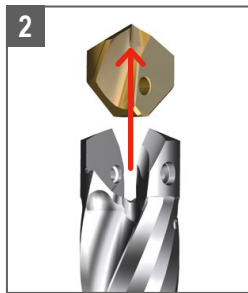

2
Remove the indexable insert from the insert seat.

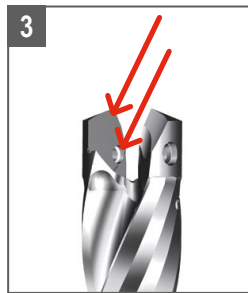

3
Clean the insert seat and screw thread with compressed air.

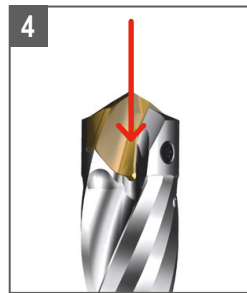

4
Insert the new indexable insert in the insert seat.

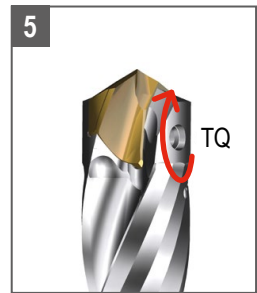

5
Insert clamping screw from correct side and tighten clockwise with the specified torque. Observe the change interval of the clamping screw!

Notes

- ▲ Only insert indexable inserts in the diameter range designated for the respective holder.
- ▲ The clamping screw must also be replaced upon every fifth replacement of the indexable insert.
- ▲ The tightening torque and item number of the clamping screw are labelled on the holder.
- ▲ Use only original spare parts.

Clamping screws and tightening torques

Diameter range	Article no. Clamping screw	Drive	Torque moment TQ
14,00–15,99 mm	11 950 00100	08IP	0,9 Nm
16,00–17,99 mm	11 950 00200	08IP	1,2 Nm
18,00–21,99 mm	11 950 00300	10IP	2,2 Nm
22,00–23,99 mm	11 950 00400	10IP	3,2 Nm
24,00–25,99 mm	11 950 00500	15IP	5,0 Nm
26,00–30,00 mm	11 950 00600	20IP	6,0 Nm

Notes on drilling technology



Solid drilling



Stack plate drilling: stable clamping of closely spaced stack plates required.



When drilling into angled surfaces $< 3^\circ$, reduce the feed by approx. 50%.
For an angled drill entrance $> 3^\circ$, prior spot facing is required.



When exiting at an angle $< 3^\circ$, reduce the feed by approx. 50%.
Machining angled drill exits $> 3^\circ$ is not recommended.

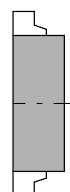

When machining with a stationary tool (turning machines), a precise centre position of the tool in relation to the rotational axis of the workpiece must be ensured. Maximum permissible offset ± 0.02 mm.



To achieve the optimal results, it is recommended to use the tool with thro' coolant only.
The recommended minimum coolant pressure should be 12 bar.

Recommendations for solid carbide drilling operations

Reasons for ...

Solutions ...

... Built-up edge

v_c too low
Too much material taken off at main cutting edge
Uncoated cutting edge



Increase v_c
Reduce cut
Coating

... Corners broken off

Unstable conditions
Run out too high
Interrupted cut



Change clamping
Optimise runout
Reduce feed

... Heavy flank wear

v_c too low
Feed rate too low
Clearance angle too small



Reduce v_c
Increase feed rate
Increase clearance angle

... Scoring on the tool flanks

Unstable conditions
Run out too high
Interrupted cut
Abrasive materials



Change clamping
Correct runout
Reduce feed
Thicker emulsion or oil

... Round chamfer wear

Unstable conditions
Run out too high
Back taper too small
Wrong emulsion or too thin emulsion



More stable clamping
Check radial run-out
Increase back taper
Thicker emulsion or oil

... Material broken off at main cutting edge

Unstable conditions
Interrupted cut
Wrong type of tool
Max. tool life has been exceeded



More stable clamping
Reduce feed
Optimise tool
Change tool earlier

... Heavy wear at chisel edge

v_c too low
Feed rate too high
Too much material taken off at main cutting edge



Increase v_c
Reduce feed
Optimise cutting edge

... Material broken off at intersections, drill point and main cutting edge

Clearance angle too small
Too much material taken off at main cutting edge
Wrong tool



Increase clearance angle
Optimize cutting edge
Other tool

... Plastic deformation of cutting corner

v_c too high
Insufficient emulsion
Wrong or no corner chamfer



Reduce v_c
Increase amount of coolant
Correct corner chamfer

... Poor surface quality

Excessive runout error
Cooling too low
Unstable conditions



Check radial run-out
More emulsion
Change toolholding

... Heavy burring on hole exit

Feed too high
Excessive honing of main cutting edge



Reduce feed
Minimise cutting edge

Further information

cuttingtools.int/en/tips-solid-carbide-drilling



Coatings

Ti800

- ▲ AlTiN nanolayer coating
- ▲ Maximum application temperature: 1100 °C

Ti700

- ▲ TiAlN multilayer coating
- ▲ Maximum application temperature: 1100 °C

TiAlN

- ▲ TiAlN multilayer coating
- ▲ Maximum application temperature: 900 °C

TiB

- ▲ TiB monolayer coating
- ▲ Specially for aluminium machining
- ▲ Maximum application temperature: 900 °C

TiSi

- ▲ TiSi multilayer coating
- ▲ Maximum application temperature: 800 °C

Ti1050

- ▲ Ti multilayer coating
- ▲ $HV_{0.005} = 3300$
- ▲ Coefficient of friction (against steel) = 0.3 – 0.5
- ▲ Maximum application temperature: 900 °C

Ti750

- ▲ TiAlN nanolayer coating
- ▲ Maximum application temperature: 1000 °C

TPX74S

- ▲ TiAlN-based PVD multilayer coating
- ▲ Universally applicable grade with high wear-resistance
- ▲ Maximum application temperature: 900 °C

DPX74S

- ▲ Special TiAlN nanolayer coating
- ▲ Maximum application temperature: 1000 °C

DRAGONSKIN

DPA54

- ▲ Special multilayer coating
- ▲ High hardness and heat resistance
- ▲ Maximum application temperature: 800 °C

DRAGONSKIN

DLC

- ▲ Diamond-like carbon coating
- ▲ Specially for machining non-ferrous metals
- ▲ Maximum application temperature: 400 °C

DRAGONSKIN

DPX14S

- ▲ TiAlN nanolayer coating
- ▲ Coefficient of friction (dry, against steel) = 0.35
- ▲ Maximum application temperature: 1000 °C

DRAGONSKIN

DPX64U

- ▲ Special TiAlN monolayer coating
- ▲ Perfected for hardened materials
- ▲ Optimised coating and surface structure
- ▲ Maximum application temperature: 800 °C

DRAGONSKIN

DPX74M

- ▲ Universal AlCrN-based monolayer coating developed for micro tools
- ▲ High oxidation, heat and wear resistance
- ▲ Maximum application temperature 1100 °C

DRAGONSKIN