

New products for machining technicians

NEW Precision adjustment head hi.flex micro



- ▲ The continuation of the hi.flex system success story: the ultimate milestone in terms of precision, flexibility and user-friendliness is now getting a well-deserved "little brother". With a boring range of \varnothing 0.5 mm – 60 mm, it covers a very wide range of all upcoming spindle machining operations.

→ Page 19–21

NEW UltraMini/EcoCut boring bar adapter



- ▲ The new boring bar adapter can be used in all heads with a clamping diameter of 12 mm or 16 mm such as both sizes of the hi.flex micro precision adjustment head (and BluFlex 2). Using the UltraMini and EcoCut boring bars makes particular sense here since the adapter is also suitable for boring bars with a thro' coolant supply.

DCONMS 12 → Page 20
DCONMS 16 → Page 14

NEW MicroKom – Precision spindle set



- ▲ New: the MicroKom precision adjustment heads BluFlex 2, hi.flex and hi.flex micro are also available as a set
- | | |
|---------------|-----------|
| BluFlex 2 | → Page 12 |
| hi.flex | → Page 13 |
| hi.flex micro | → Page 19 |

NEW Interface adapter



- ▲ Total freedom in tool selection: thanks to the new interface adapters, ABS tools in STM base holders and STM tools in ABS base holders can be accommodated reliably and precisely.

→ Page 56

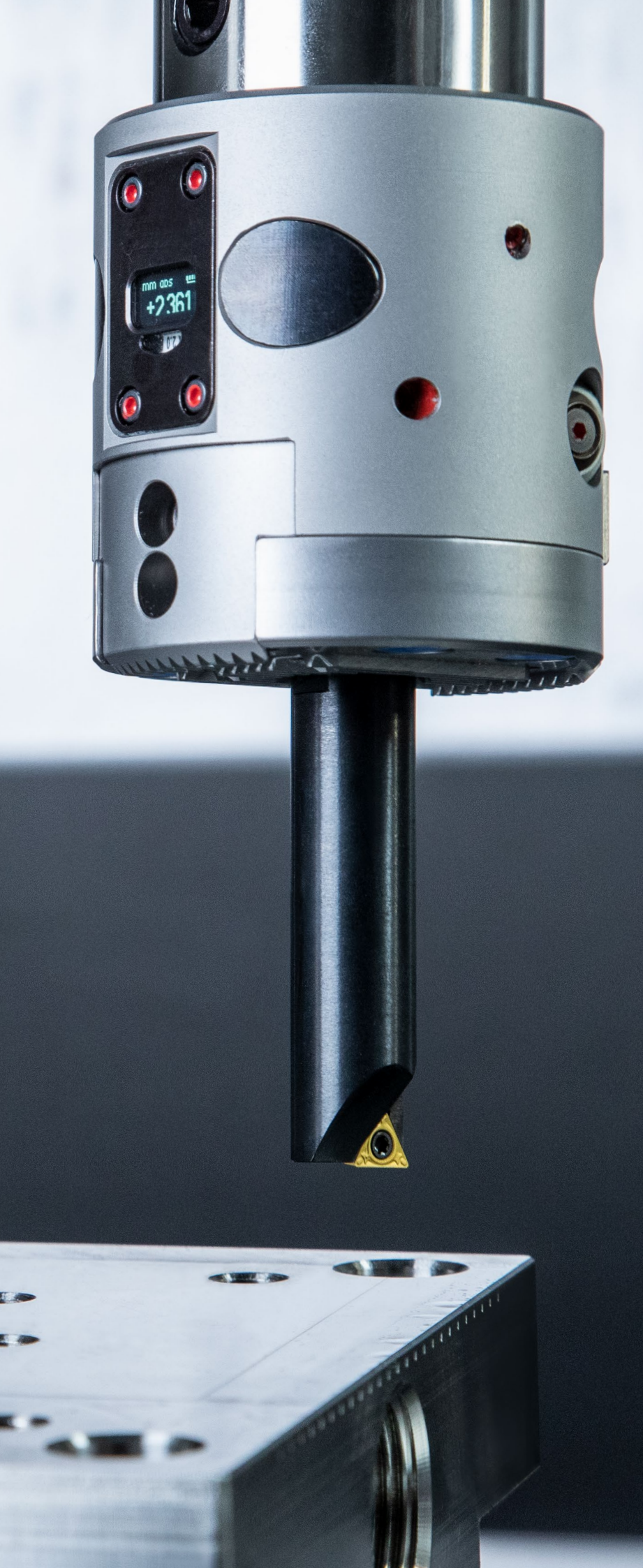

Solid drilling and bore machining

- 1 HSS drilling
- 2 Solid carbide drilling
- 3 Indexable insert drilling
- 4 Reaming and Countersinking

5 Spindle Tooling

5

Threading

- 6 Taps and thread formers
- 7 Circular and Thread Milling
- 8 Thread turning

Turning

- 9 Turning Tools
- 10 Multifunctional Tools – EcoCut and FreeTurn
- 11 Grooving Tools
- 12 Miniature turning tools

Milling

- 13 HSS Milling Cutters
- 14 Solid Carbide milling cutters
- 15 Milling tools with indexable inserts

Clamping technology

- 16 Adaptors and Accessories
- 17 Workpiece clamping

- 18 Material examples and article no. Index

Table of contents

Symbol explanation	4
Toolfinder	5–10
Contents Overview Accessories	11
Product programme	12–63
Cutting Data	64–71
Technical Information	
Fine boring tools	72+73
Counterboring tools	74
Insert	75
Notes on drilling technology	76
Problems / possible causes / solutions	77
Types of wear	78
Chip breakers	79
Grades / coatings	80+81

KOMET \ Performance

Premium quality tools for high performance.

The premium quality tools from the **KOMET Performance** product line have been designed for specific applications and are distinguished by their outstanding performance. If you make high demands on the performance of your production and want to achieve the very best results, we recommend the Premium tools in this product line.

KOMET \ Standard

Quality tools for standard applications.

The quality tools of the **KOMET Standard** product line are high quality, high performance, reliable and enjoy the highest level of trust among our customers worldwide. Tools from this product line are the first choice for many standard applications and guarantee optimal results.

Symbol explanation

F	Fine Machining
M	Medium Machining
R	Rough Machining

	Smooth cut
	Irregular cutting depth
	Interrupted cut

ABS KOMET ABS – modular coupling system for rotating and stationary tools

STM Modular SpinTools interface

ER 32 System-independent ER 32 interface

Coolant supply central
Steep taper Form AD



hi.flex / hi.flex micro

- ▲ The precision adjustment heads are characterised by their high precision, absolute reliability and enormous flexibility
- ▲ Available as analogue and digital variants (hi.flex: analogue + digital, hi.flex micro: analogue)
- ▲ Comprehensive accessories offer maximum flexibility (hi.flex: diameter range 0.5 – 365 mm, hi.flex micro: diameter range 0.5 – 60 mm)
- ▲ Higher RPMs can be reached thanks to the symmetrically balanced design (hi.flex: 17,500 rpm, hi.flex micro: 30,000 rpm)
- ▲ The sensitive adjustment for μ -precise width of cut
- ▲ With thro' coolant supply
- ▲ Universal ABS interface

Toolfinder

Machining	Diameter range per system in mm																System + quantity of counterboring or fine boring heads to cover the diameter range	Digital	Analogue	ABS Modular	STM Modular	ER 32 Modular	Monoblock	Through spindle	Tolerance zone	Case set	Page No.				
	5	10	15	20	25	50	100	150	200	300	400	500	600	...	2200																
Finishing	0,5 – 365																BluFlex 2 1 Precision adjustment heads	✓		✓				✓ > Ø 65	≧ IT 7	✓	12				
	0,5 – 365																hi.flex 1 Precision adjustment heads	✓	✓	✓				✓ > Ø 60	≧ IT 7	✓	13				
	0,5 – 60																hi.flex micro 1 Precision adjustment heads		✓	✓				✓ > Ø 36	≧ IT 7	✓	19				
					24,8 – 206												M03 Speed 9 Precision adjustment heads		✓	✓			✓	≤ IT 7		22					
						29,5 – 199												15 FF precision adjustment heads			✓	✓		✓	≧ IT 7		24				
	0,3 – 19,1																2 Micro boring heads	✓	✓						≧ IT 7		26				
				14,7 – 24,1												3 Fine boring heads		✓				✓	≧ IT 7		28						
	3 – 320																1 Multi-Head – Fine boring head		✓		✓	✓	✓ > Ø 63	≧ IT 7	✓	30					
	3 – 88,1																1 Single point boring head	✓	✓		✓	✓	✓	✓ > Ø 55	≧ IT 7	✓	32+33				
					23,9 – 154,1												6 Single point finish boring heads	✓	✓		✓		✓	≧ IT 7		38					
					86 – 402												1 Single point finish boring head		✓	✓		✓	≧ IT 7	✓	42						
Roughing and Finishing						150 – 655												1 Console tool with baseplate	✓	✓			✓			62 402 ... 					
												650 – 2205												1 Console tool with slide	✓	✓			✓		
Roughing					24 – 215												TwinKom 8 Twin cutters		✓	✓			✓			44					
				23,5 – 87,5												5 Boring heads for roughing with 2 cutting edges		✓		✓		✓			47						

This article can be found in our online shop at cuttingtools.ceratizit.com

Overview – Fine boring systems

MicroKom

BluFlex 2 / hi.flex

Ø 0,5 – 365 mm

BluFlex 2



Digital
12

hi.flex



Analogue / digital
13

ABS

hi.flex micro

Ø 0,5 – 60 mm

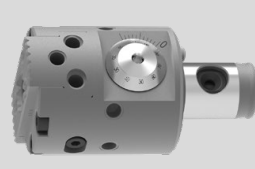

Analogue
19

ABS

Ø 0,5 – 26 mm

- Ø 0,5 – 8 mm

UltraMini + EcoCut
→ Chapters 10 + 12



Adapter
14
- Ø 5,6 – 24 mm



Boring Bar
18

Adapter
17
- Ø 5,6 – 11 mm



Boring bar, vibration-optimised
17
- Ø 13 – 26 mm



Boring bar
17
- Ø 6 – 22 mm *



Steel boring bar
14
- Ø 7,9 – 23,9 mm



ABS32 boring bar
18

Ø 25 – 365 mm

- Ø 25 – 44 mm



Insert holder
15

Serrated body
15
- Ø 44 – 63 mm



Insert holder
15

Filling piece
16
- Ø 63 – 93 mm



Insert holder
15

Filling piece
16
- Ø 90 – 365 mm



Insert holder
15

Bridge
16

Filling piece
16
- Ø 5 – 70 mm

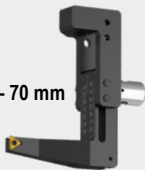

Spindle tool for external machining
16

Ø 0,5 – 25 mm

- Ø 0,5 – 8 mm

UltraMini + EcoCut
→ Chapters 10 + 12



Adapter
20
- Ø 8 – 13,8 mm

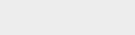

Boring Bar
20
- Ø 13,8 – 19,8 mm



Boring Bar
20
- Ø 19,8 – 25 mm



Boring Bar
20

Ø 25 – 60 mm

- Ø 25 – 44,8 mm



Insert holder
21

Serrated body
21
- Ø 44,8 – 60 mm



Insert holder
21

Filling piece
21



TO.X
58+59



WOHX *
57

* Used for steel boring bars Ø 6 – 8 mm

necessary ———
optional - - - - -

SpinTools

Multi-Head boring and fine boring head

Ø 3 – 320 mm

HSK-A SK MAS BT STM

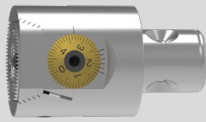

Analogue
30

Single point finish boring head

Ø 3 – 88,1 mm

HSK-A SK MAS BT STM ER 32

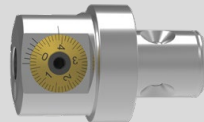

Analogue / digital
32+33

Micro Boring Head

Ø 0,3 – 19,1 mm

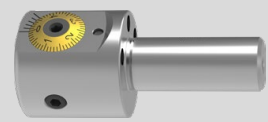

Analogue / digital
26

Ø 3 – 53,1 mm

- Ø 3 – 12 mm
Boring steel 35
Reduction sleeve 36
- Ø 5,8 – 13,2 mm
Boring bar 36
Reduction sleeve 36
- Ø 8,75 – 40,1 mm
High-speed boring head + boring shank 37
- Ø 9,75 – 53,1 mm
Steel boring bar 35
Boring tool extension 36

Ø 29,75 – 320 mm

- Ø 29,75 – 88,1 mm
Insert holder 35
Adjustable boring bar 35
- Ø 86 – 320 mm
Counterweight 31
Bridge 31
Insert holder 31

Ø 3 – 53,1 mm

- Ø 3 – 12 mm
Boring steel 35
Reduction sleeve 36
- Ø 5,8 – 13,2 mm
Boring bar 36
Reduction sleeve 36
- Ø 8,75 – 40,1 mm
High-speed boring head + boring shank 37
- Ø 9,75 – 53,1 mm
Steel boring bar 35
Boring tool extension 36

Ø 29,75 – 88,1 mm

- Insert holder 35
Adjustable boring bar 35

Ø 0,3 – 7,1 mm

- Solid carbide cutting insert 27
Adapter 27

Ø 5,2 – 8,1 mm









- Solid carbide cutting insert 27

Ø 0,3 – 19,1 mm

- Ø 6,9 – 19,1 mm
Solid carbide insert 27
Tool holder 27

CC..
63

Overview – Fine boring tools

MicroKom	
M03 Speed Analogue Ø 24,8 – 206 mm	FF precision adjustment head Analogue Ø 29,5 – 199 mm
ABS	ABS
<p>Precision adjustment heads 22</p> <p>Ø 24,8 – 39 mm</p>  <p>Insert holder 23</p>  <p>Precision adjustment heads 22</p> <p>Ø 38 – 103 mm</p>  <p>Insert holder 23</p>  <p>Interchangeable bridge 23</p> <p>Precision adjustment heads 22</p> <p>Ø 38 – 206 mm</p>  <p>Insert holder 23</p> 	<p>Precision adjustment heads 24</p>  <p>Precision turning insert 25</p> 



TO.X
58+59

necessary ———
optional - - - - -

SpinTools

Single point finish boring head
Analogue / digital





Ø 23,9 – 154,1 mm

STM

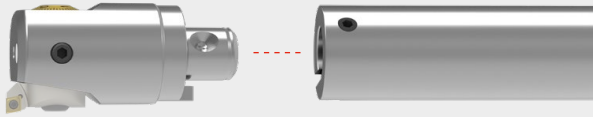
Single point finish boring head
Analogue / digital
38

High-speed boring shank
39



-  Insert holder, 90°, extended
39
-  Insert holder, 90°
39
-  Insert holder, 95°
39
-  Reverse adapters for back boring
40

Fine boring head
Analogue

Ø 14,7 – 24,1 mm

Fine boring head
28

High-speed boring shank
29

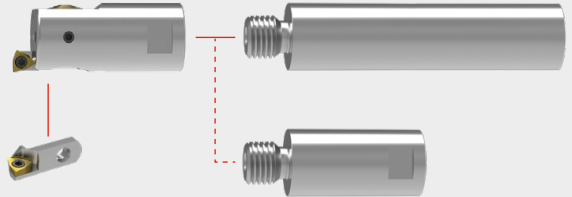

Insert holder, 90°
28

Shank extension
29

Ø 86 – 402 mm

STM

Insert holder
43

Single point finish boring head
Analogue
42

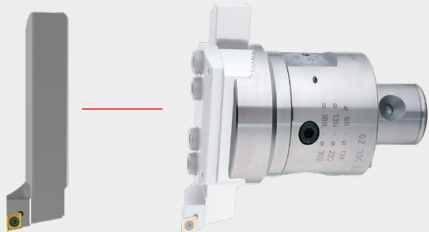

CC..
63



WC..
62

Overview – Counterboring and console tools

necessary ———
optional - - - - -

TwinKom

Twin cutter Analogue

Ø 24 – 215 mm

Tool holder 90°
radially adjustable
45



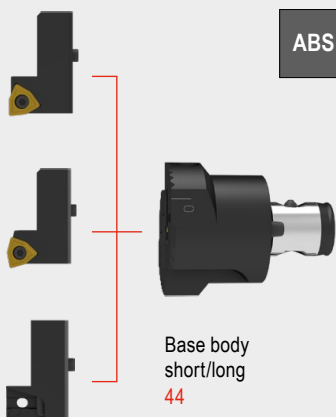

ABS

Tool holder 80°
radially adjustable
45



Basic tool holder,
radially + axially adjustable
46



Base body
short/long
44

Indexable insert 90°
46



Indexable insert 80°
46



SpinTools

Twin rough boring head Analogue

Ø 23,5 – 87,5 mm

Pair of insert
holders,
Standard 90°
48



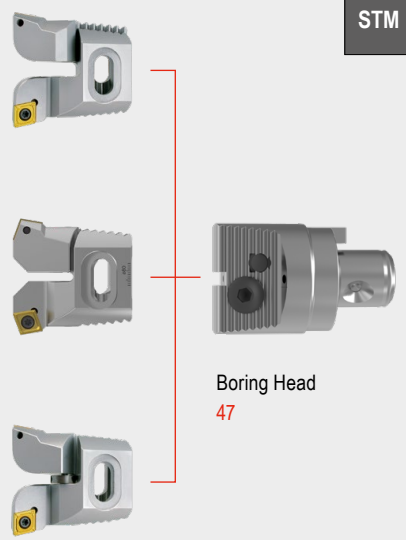

STM

Pair of insert
holders,
Standard 70°
48



Pair of insert
holders,
Synchro 90°
49



Boring Head
47



WO..
60+61



CC.. / CN..
63

SpinTools

Console tool Analogue / digital



Ø 150 – 2205 mm

Rough boring block
90° (CC..)
62 412 ...



Rough boring block
90° (CN..)
62 413 ...



Rough boring block
70° (CN..)
62 414 ...



Finish boring block
analogue / digital
62 410 ... / 62 409 ...



Insert holder
90° / 95°
62 318 ... / 62 320 ...



Base plates
62 402 ...



Ø 650 – 2205 mm
Elongation console

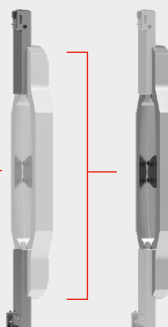

Counterweight
62 427 ...



Slide
62 406 ...



Basis
62 405 ...



Base adapter
62 392 ...

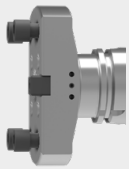

Ø 60 mm
DIN 6357



HSK-A

SK



MAS
BT

SK

MAS
BT







Overview of base adapters and accessories

						
System	ISO 7388-1		ISO 7388-2		ISO 12164	ISO 26623-1
	SK	SK-FC	MAS-BT	MAS-BT-FC	HSK-A	HSK-E

Base adapter		ABS	→ Clamping technology catalogue, Chapter 16, Adapters and accessories					
			16 43	16 45	16 88	16 108	16 141	16 170
		STM	50		51		52	

5

Accessories

Extension		ABS	→ Clamping technology catalogue, Chapter 16, Adapters and accessories						
			16 187						
		STM	55						
Reduction		ABS	→ Clamping technology catalogue, Chapter 16, Adapters and accessories						
			16 191						
		STM	53						
Interface adapter	ABS → STM		ABS	56					
	STM → ABS		STM	56					

 Additional accessories available on request, such as balancing rings, axial grooving holders (UltraMini) and counterboring insert holders (0.4 mm offset) for SpinTools systems.

MicroKom – BluFlex 2 – precision adjustment head

- ▲ Via the free app (Android/iOS), an extended display can be transferred to a standard smartphone (62 840 16097)
- ▲ For MicroKom boring bars with Ø 16 or with ABS 32, MicroKom bridges, and serrated body
- ▲ With thro' coolant supply
- ▲ LSCX = Recess depth of boring bar

Scope of supply:

incl. Battery

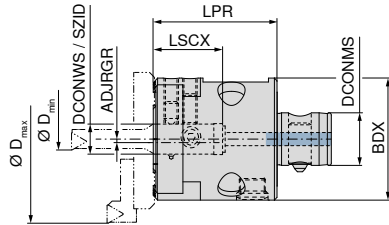

without Bluetooth with Bluetooth

D _{min} - D _{max} mm	KOMET no.	Adapter	DCONWS mm	SZID	DCONMS mm	BDX mm	LPR mm	LSCX mm	ADJRGR mm	WT kg	62 820 ... EUR W4/6A	62 840 ... EUR W4/6A
0,5 - 365	M04 30100	ABS 50	16	ABS 32	28	65	71	38	-0,2 - 2,3	1,45	2.765,00	16097
0,5 - 365	M04 30000	ABS 50	16	ABS 32	28	65	71	38	-0,2 - 2,3	1,45	2.765,00	16097

Spare parts for Article no.	62 820 16097	62 840 16097	62 950 ... EUR XX	62 950 ... EUR W7/6B	62 950 ... EUR W7/6B	62 950 ... EUR W7/6B	62 950 ... EUR W7/6B
M8x1x12/SW4	12,08	13989	M8x1x20/SW4	2,03	13700	M5x14/SW4	2,94
M8x1x12/SW4	12,08	13989	M8x1x20/SW4	2,03	13700	M5x14/SW4	2,94

- A detailed operating manual is available for download in the online shop next to the product.
- Suitable ABS adapters can be found in → **Catalogue – Clamping technology, Chapter 16, Adaptors and Accessories.**
- **Page 6**
Here you will find a detailed system overview.

MicroKom – Precision spindle set BluFlex 2

Scope of supply:

- ▲ 1 plastic case
- ▲ 1 precision adjustment head
- ▲ 5 boring bars
 - 62 850 00600 Ø 6 mm
 - 62 850 01000 Ø 10 mm
 - 62 850 01400 Ø 14 mm
 - 62 850 01800 Ø 18 mm
 - 62 850 02200 Ø 22 mm
- ▲ 2 insert holders
 - 62 863 04400 Ø 25 – Ø 44 mm
 - 62 863 12500 Ø 44 – Ø 63 mm (– Ø 125 mm)
- ▲ 1 bridge
 - 62 860 12500 Ø 90 – Ø 125 mm
- ▲ 1 serrated body
 - 62 861 06300 Ø 25 – Ø 63 mm
- ▲ 1 filling piece
 - 62 862 09300 Ø 16x35 mm
- ▲ 10 indexable inserts
 - 2 pieces 62 600 00102 – WOHX02T001EL-G12 BK8440
 - 4 pieces 62 601 90206 – TOGX06T102EN-14 BK60
 - 4 pieces 62 601 70409 – TOGX090204EN-14 BK60
- ▲ 5 cylindrical screws
 - 62 950 00000 M5x16 mm
- ▲ 5 screwdrivers
 - 5IP, 6IP, 8IP, SW3, SW4

NEW

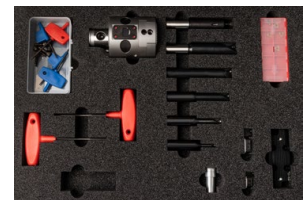

D _{min} - D _{max} mm	6 - 125	without Bluetooth EUR W4/6A	with Bluetooth EUR W4/6A
		4.217,00	99997
		4.217,00	99997

MicroKom – hi.flex – precision adjustment head

- ▲ For MicroKom boring bars with Ø 16 mm or ABS 32, MicroKom bridges and serrated bodies
- ▲ With thro' coolant supply
- ▲ LSCX = Recess depth of boring bar
- ▲ Digital variant: please order the digital stick separately

ABS

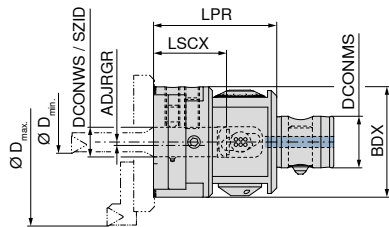

D _{min} - D _{max} mm	KOMET no.	Adapter	DCONWS mm	SZID mm	DCONMS mm	BDX mm	LPR mm	LSCX mm	ADJRGR mm	WT kg	Analogue		Digital	
											62 800 ...	62 800 ...	62 800 ...	62 800 ...
0,5 - 365	M05 01000	ABS 50	16	ABS 32	28	60	67	39,7	-0,25 - 5	1,23	EUR W4/6A 1.433,00	16097	EUR W4/6A 1.720,00	16197
0,5 - 365	M04 10040	ABS 50	16	ABS 32	28	60	67	39,7	-0,25 - 5	1,23				

Spare parts for Article no.	62 950 ...		62 950 ...		62 950 ...	
	EUR W7/6B	14700	EUR XX	13989	EUR W7/6B	13700
62 800 16097		M8x8 - SW4	2,03	14700	M8x1x12/SW4	12,08 13989
62 800 16197		M8x8 - SW4	2,03	14700	M8x1x12/SW4	12,08 13989

- A detailed operating manual is available for download in the online shop next to the product.
- Suitable ABS adapters can be found in → **Catalogue – Clamping technology, Chapter 16, Adaptors and Accessories.**
- **Page 6**
Here you will find a detailed system overview.
- **Page 26**
Here you will find the SpinTools – Digital Stick.

MicroKom – Precision spindle set hi.flex

Scope of supply:

- ▲ 1 plastic case
- ▲ 1 precision adjustment head
- ▲ 5 boring bars
 - 62 850 00600 Ø 6 mm
 - 62 850 01000 Ø 10 mm
 - 62 850 01400 Ø 14 mm
 - 62 850 01800 Ø 18 mm
 - 62 850 02200 Ø 22 mm
- ▲ 2 insert holders
 - 62 863 04400 Ø 25 – Ø 44 mm
 - 62 863 12500 Ø 44 – Ø 63 mm (– Ø 125 mm)
- ▲ 1 bridge
 - 62 860 12500 Ø 90 – Ø 125 mm
- ▲ 1 serrated body
 - 62 861 06300 Ø 25 – Ø 63 mm
- ▲ 1 filling piece
 - 62 862 09300 Ø 16x35 mm
- ▲ 10 indexable inserts
 - 2 pieces 62 600 00102 – WOHX02T001EL-G12 BK8440
 - 4 pieces 62 601 90206 – TOGX06T102EN-14 BK60
 - 4 pieces 62 601 70409 – TOGX090204EN-14 BK60
- ▲ 5 cylindrical screws
 - 62 950 00000 M5x16 mm
- ▲ 5 screwdrivers
 - 5IP, 6IP, 8IP, SW3, SW4

NEW

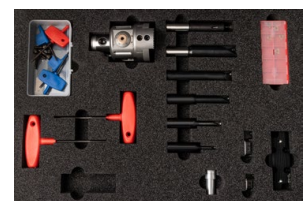

D _{min} - D _{max} mm	Analogue		Digital	
	62 800 ...	62 800 ...	62 800 ...	62 800 ...
6 - 125	EUR W4/6A 3.068,00	99997	EUR W4/6A 3.326,00	99897

MicroKom – UltraMini / EcoCut boring bar adapter

- ▲ for hi.flex and BluFlex 2
- ▲ 4 clamping flats (offset by 90°) on Ø DCONMS
- ▲ with thro' coolant supply

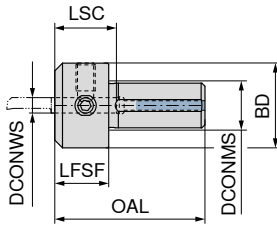

NEW

62 851 ...

DCONWS mm	KOMET no.	OAL mm	BD mm	LFSF mm	LSC mm	DCONMS mm	EUR W4/6A	
4	M05 90950	39	22	14	18	16	152,70	16499
5	M05 90960	39	22	14	18	16	152,70	16599
6	M05 90970	39	22	14	18	16	152,70	16699
7	M05 90980	39	25	14	18	16	152,70	16799
8	M05 90990	39	25	14	18	16	152,70	16899

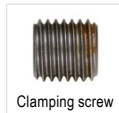

70 950 ...

Spare parts	DCONWS	EUR 2A/28	
4 - 5		3,84	867
6 - 8		3,84	123

Suitable UltraMini / EcoCut tools can be found in → **Chapters 10 and 12.**

MicroKom – Steel boring bar for hi.flex, BluFlex 2

- ▲ with thro' coolant

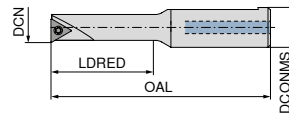

62 850 ...

DCN mm	KOMET no.	OAL mm	LDRED mm	DCONMS mm	Insert	EUR W4/6A	
6	B05 20100	71,7	21,0	16	WO.. 02T0	154,20	00600
8	B05 20120	77,4	28,0	16	TO.. 06T1	159,40	00800
10	B05 20140	81,8	34,0	16	TO.. 0902	152,70	01000
12	B05 20160	88,2	42,0	16	TO.. 0902	166,10	01200
14	B05 20180	94,4	50,0	16	TO.. 0902	164,20	01400
18	B05 20220	100,0	60,0	16	TO.. 0902	174,40	01800
22	B05 20260	108,0	68,5	16	TO.. 1403	199,50	02200



62 950 ...

Spare parts	Insert	EUR W7/6B	
	WO.. 02T0	3,05	11800
	TO.. 06T1	3,50	12800
	TO.. 0902	3,05	12000
	TO.. 1403	3,05	12600

→ **Page 57–59**
Find suitable indexable inserts here.

MicroKom – Serrated body for hi.flex, BluFlex 2

▲ with thro' coolant

Scope of supply:
without insert holder

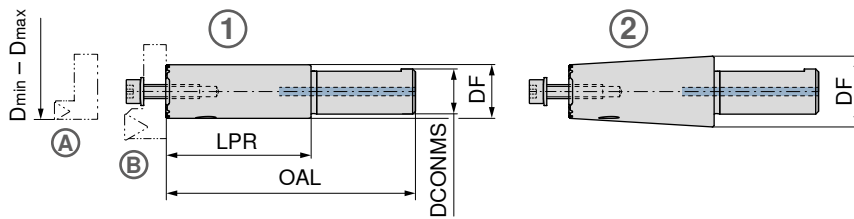

62 861 ...

EUR
W4/6A
181,00 06300
181,00 16300

D _{min} - D _{max} mm	KOMET no.	DCONMS mm	OAL mm	LPR mm	DF mm	Fig.
25 - 63	M05 90100	16	89,12	52,12	19	1
25 - 63	M05 90110	16	128,39	91,93	24	2

5

Spare parts
DCONMS
16



Cylindrical screw



Disk spring

62 950 ...

EUR
W7/6B
1,13 00000

62 950 ...

EUR
W7/6B
2,03 19100

M5x16

10x5,2x0,3

MicroKom – Insert holder for hi.flex, BluFlex 2

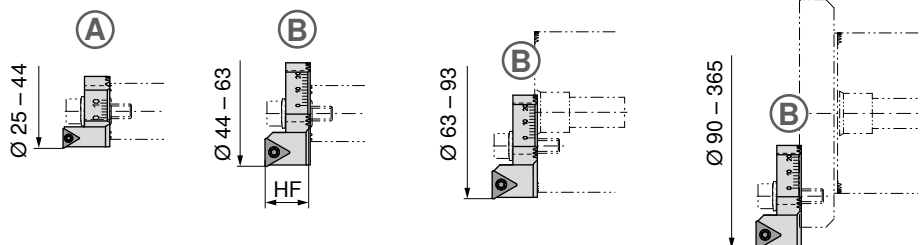

62 863 ...

EUR
W4/6A
177,60 04400
181,00 12500

DCN mm	DCX mm	KOMET no.	HF mm	Insert	Fig.
25	44	M05 20101	13,5	TO.. 06T1	A
44	365	M05 20151	13,5	TO.. 0902	B



TORX® Screws

62 950 ...

EUR
W7/6B
3,50 09700
3,05 09900

Spare parts
Insert
TO.. 06T1
TO.. 0902

M2x4,9/IP6

M2,6x6,2 - 08IP

→ Page 58+59
Find suitable indexable inserts here.

MicroKom – Bridge for hi.flex, BluFlex 2

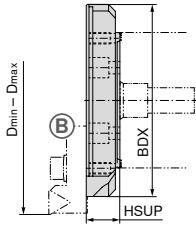

62 860 ...

D _{min} - D _{max} mm	KOMET no.	BDX mm	HSUP mm	WT kg	EUR W4/6A
90 - 125	M05 80101	85	14,89	0,147	249,90 12500
120 - 155	M05 80200	115	16,89	0,107	300,40 15500
150 - 185	M05 80300	145	18,89	0,152	340,60 18500
180 - 215	M05 80400	175	21,89	0,229	378,10 21500
210 - 245	M05 80500	205	25,00	0,309	525,60 24500
240 - 275	M05 80510	235	25,00	0,349	569,90 27500
270 - 305	M05 80520	265	25,00	0,394	589,90 30500
300 - 335	M05 80530	295	25,00	0,435	634,20 33500
330 - 365	M05 80540	325	25,00	0,478	683,80 36500



Cylindrical screw

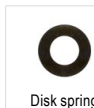

Disk spring

62 950 ...

EUR
W7/6B

1,13 00000

62 950 ...

EUR
W7/6B

2,03 19100

Spare parts
BDX
85 - 325

MicroKom – Spindle tool for external machining

▲ for hi.flex and BluFlex 2

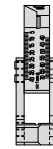
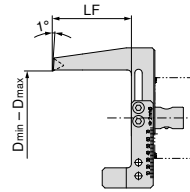

62 866 ...

D _{min} - D _{max} mm	KOMET no.	LF mm	Adapter	WT kg	Insert	EUR W4/6A
5 - 70	M05 90300	58	ABS 32	0,377	TO.X 0902..	509,60 07000



Cylindrical screw



TORX® Screws

62 950 ...

EUR
W7/6B

1,13 26800

62 950 ...

EUR
W7/6B

3,05 12000

Spare parts
Insert

TO.X 0902..



→ Page 58+59

Find suitable indexable inserts here.



A detailed operating manual is available for download in the online shop next to the product.

MicroKom – Filling piece for hi.flex, BluFlex 2

▲ For targeted redirecting of the thro' coolant to the cutting edge when using bridges or insert holders with diameters from 63 mm

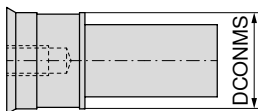

62 862 ...

DCONMS mm	KOMET no.	EUR W4/6A
16	M05 90501	24,13 09300

MicroKom – Adapter

▲ for 62 852 ..., 62 853 ..., 62 856 ... (essential for using the boring bar)

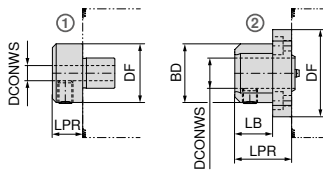

							62 851 ...
DCONWS	KOMET no.	DF	BD	LPR	LB	Fig.	EUR
mm		mm	mm	mm	mm		W4/6A
6	M05 90200	31		16		1	138,10 00600
8	M05 90210	31		16		1	138,10 00800
10	M05 90220	46	31	25	15	2	173,00 01000
12	M05 90230	46	31	25	15	2	173,00 01200
16	M05 90240	46	31	30	20	2	173,00 01600



Cylindrical screw

Clamping screw

Spare parts

DCONWS	EUR	EUR
	W7/6B	W7/6B
6 - 8		2,03 44800
10 - 12	1,13 00000	2,03 44800
16	1,13 00000	2,03 14700



A detailed operating manual is available for download in the online shop next to the product.

MicroKom – Boring bar, vibration-optimised

▲ can only be used with adapter 62 851 ...
▲ with internal coolant supply

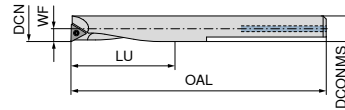

							62 852 ...
DCN	KOMET no.	WF	LU	OAL	DCONMS	Insert	EUR
mm		mm	mm	mm	mm		W4/6A
5,6	B00 30280	2,80	22	65	6	WOHX 02T0..	202,40 10600
6,9	B00 30290	3,45	36	80	6	WOHX 02T0..	202,40 00600 ¹⁾
9,0	B00 00680	4,45	48	90	8	TO.X 06T1..	347,40 00800 ¹⁾
11,0	B00 00690	5,45	60	95	10	TO.X 06T1..	367,50 01000 ¹⁾

1) Carbide version



TORX® Screws

Spare parts

Insert	EUR
	W7/6B
WOHX 02T0..	3,05 11800
TO.X 06T1..	3,50 09700



→ Page 57–59
Find suitable indexable inserts here.

MicroKom – Carbide boring shank

▲ for boring head 62 854 ...
▲ can only be used with adapter 62 851 ...
▲ with internal coolant supply

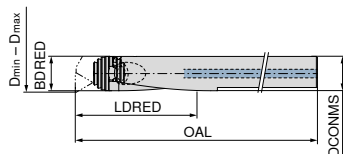

						62 853 ...
D _{min} - D _{max}	KOMET no.	OAL	BDRED	LDRED	DCONMS	EUR
mm		mm	mm	mm	mm	W4/6A
13 - 17	G10 12060	120	12	75	12	410,30 01300
17 - 22	G10 12070	140	16	100	16	494,80 01700
22 - 26	G10 12080	140	16	100	16	494,80 02200



Fixing screw

Spare parts

DCONMS	EUR
	W7/6B
12	5,74 19700
16	5,74 19800

MicroKom – Boring head

▲ for boring shank 62 853 ...

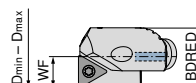

					62 854 ...
D _{min} - D _{max}	KOMET no.	WF	BDRED	Insert	EUR
mm		mm	mm		W4/6A
13 - 15	G10 12621	6,45	12	TO.X 0902..	191,80 01300
15 - 17	G10 12841	7,45	12	TO.X 0902..	195,80 01500
17 - 19	G10 12711	8,45	16	TO.X 0902..	207,80 01700
19 - 22	G10 12861	9,45	16	TO.X 0902..	214,60 01900
22 - 26	G10 12731	10,95	16	TO.X 0902..	214,60 02200

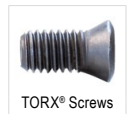

TORX® Screws

Spare parts

Insert	EUR
	W7/6B
TO.X 0902..	3,05 12000



→ Page 58+59
Find suitable indexable inserts here.

MicroKom – Boring bar

- ▲ can only be used with adapter 62 851 ...
- ▲ with internal coolant supply

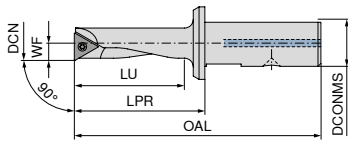

62 856 ...

DCN mm	KOMET no.	OAL mm	LPR mm	LU mm	DCONMS mm	WF mm	Insert	EUR W4/6A
5,6	B00 37010	48	26	20	8	2,75	WOHX 02T0..	194,40 05600
6,5	B00 37020	52	30	24	8	3,20	WOHX 02T0..	187,80 06500
8,0	B00 15510	57	35	28	8	3,95	TO.X 06T1..	183,80 08000
8,0	B00 15610	75	35	28	16	3,95	TO.X 06T1..	186,40 00800
10,0	B00 15620	80	40	33	16	4,95	TO.X 06T1..	187,80 01000
11,0	B00 15710	85	45	38	16	5,45	TO.X 0902..	191,80 01100
12,0	B00 15530	67	45	39	8	5,95	TO.X 0902..	194,40 11200
12,0	B00 15630	85	45	38	16	5,95	TO.X 0902..	194,40 01200
14,0	B00 15640	90	50	43	16	6,95	TO.X 0902..	197,20 01400
16,0	B00 15650	95	55	49	16	7,95	TO.X 0902..	207,80 01600
18,0	B00 15661	100	60	54	16	8,95	TO.X 0902..	215,80 01800
19,0	B00 15751	105	65	59	16	9,45	TO.X 0902..	215,80 01900
20,0	B00 15671	105	65	59	16	9,95	TO.X 0902..	217,30 02000
22,0	B00 15681	105	65	59	16	10,95	TO.X 0902..	234,70 02200
24,0	B00 15691	105	65	60	16	11,95	TO.X 0902..	236,00 02400



TORX® Screws

62 950 ...

DCN	EUR W7/6B
5,6 - 6,5	3,05 11800
8 - 10	3,50 12800
11 - 24	3,05 12000

→ Page 57-59
Find suitable indexable inserts here.

MicroKom – Boring bar

- ▲ with thro' coolant

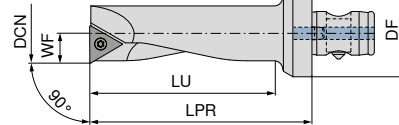

62 857 ...

DCN mm	KOMET no.	WF mm	DF mm	LU mm	LPR mm	Insert	EUR W4/6A
8	B00 25610	3,95	32	26	42	TO.X 06T1..	317,80 07989
9	B00 25700	4,45	32	32	48	TO.X 06T1..	320,60 21989
10	B00 25620	4,95	32	32	48	TO.X 06T1..	320,60 08989
11	B00 25710	5,45	32	41	57	TO.X 06T1..	329,80 23989
12	B00 25630	5,95	32	41	57	TO.X 0902..	328,50 09989
14	B00 25640	6,95	32	49	64	TO.X 0902..	331,20 10989
16	B00 25650	7,95	32	57	72	TO.X 0902..	340,60 11989
18	B00 25661	8,95	32	57	72	TO.X 0902..	349,90 13989
20	B00 25671	9,95	32	67	82	TO.X 0902..	355,40 15989
22	B00 25681	10,95	32	68	82	TO.X 0902..	363,40 17989
24	B00 25691	11,95	32	68	82	TO.X 0902..	370,00 19989



TORX® Screws

62 950 ...

Insert	EUR W7/6B
TO.X 06T1..	3,50 12800
TO.X 0902..	3,05 12000

→ Page 58+59
Find suitable indexable inserts here.

MicroKom – hi.flex micro – precision adjustment head

- ▲ for MicroKom boring bars and serrated bodies with DCONMS = 12 mm
- ▲ with thro' coolant supply
- ▲ LSCX = Recess depth of boring bar
- ▲ max. speed 30,000 rpm with slide in centre position
- ▲ UltraMini / EcoCut boring bar adapter for diameters from 0.5 mm

ABS

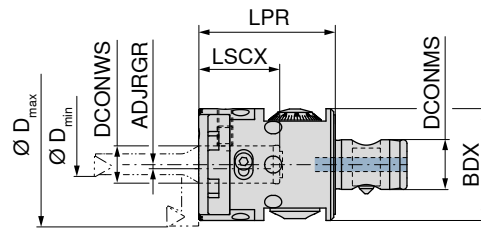

NEW
Analogue
62 800 ...
EUR
W4/6A
1.196,00 06089

D _{min} - D _{max} mm	KOMET no.	Adapter	DCONWS mm	DCONMS mm	BDX mm	LPR mm	LSCX mm	ADJRGR mm	WT kg
0,5 - 60	M05 03000	ABS 32	12	16	36	44	26	-0,25 - 2,5	0,3

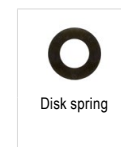

62 950 ... EUR W7/6B 6,34 53700	62 950 ... EUR W7/6B 1,13 53500
---	---

Spare parts
for Article no.
62 800 06089

Ø5,5x1,0

M5x8 DIN913

A detailed operating manual is available for download in the online shop next to the product.

Suitable ABS adapters can be found in → **Catalogue – Clamping technology, Chapter 16, Adaptors and Accessories.**

→ **Page 6**
Here you will find a detailed system overview.

MicroKom – Precision spindle set hi.flex micro

Scope of supply:

- ▲ 1 plastic case
- ▲ 1 precision adjustment head
- ▲ 1 insert holder
 - 62 863 14400 Ø 25 – Ø 44 mm
- ▲ 3 boring bars
 - 62 845 00800 Ø 8 mm
 - 62 845 01400 Ø 14 mm
 - 62 845 02000 Ø 20 mm
- ▲ 2 adapters
 - 62 851 12499 Ø 4 mm
 - 62 851 12699 Ø 6 mm
- ▲ 1 serrated body
 - 62 861 04400 Ø 25 – Ø 44 mm
- ▲ 1 filling piece
 - 62 862 01200 Ø 12x24 mm
- ▲ 10 indexable inserts
 - 5 pieces 62 601 90206 – TOGX06T102EN-14 BK60
 - 5 pieces 62 601 70409 – TOGX090204EN-14 BK60
- ▲ 1 cylindrical screw
 - 62 950 53600 M5x16 mm
- ▲ 1 screwdriver
 - SW2,5

NEW



D _{min} - D _{max} mm
8 - 60

62 800 ...
EUR
W4/6A
2.120,00 99989

MicroKom – UltraMini / EcoCut boring bar adapter

- ▲ for hi.flex micro
- ▲ 4 clamping flats (offset by 90°) on Ø DCONMS
- ▲ with thro' coolant supply

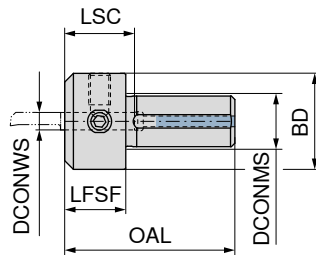

NEW

62 851 ...

EUR	W4/6A
152,70	12499
152,70	12599
152,70	12699
152,70	12799
152,70	12899

DCONWS	KOMET no.	OAL	BD	LFSF	LSC	DCONMS
mm		mm	mm	mm	mm	mm
4	M05 90900	39	22	14	18	12
5	M05 90910	39	22	14	18	12
6	M05 90920	39	22	14	18	12
7	M05 90930	39	25	14	18	12
8	M05 90940	39	25	14	18	12



70 950 ...

EUR	2A/28
3,84	867
3,84	123

Spare parts

DCONWS

4 - 5	M5x10 ISO 4026	3,84	867
6 - 8	M8x1x8 - SW4	3,84	123

Suitable UltraMini / EcoCut tools can be found in → Chapters 10 and 12.

MicroKom – Boring bar for hi.flex micro

- ▲ with thro' coolant

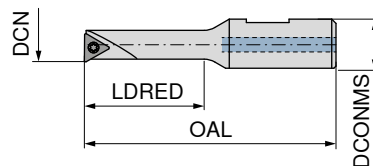

NEW

62 845 ...

EUR	W4/6A
104,60	00800
104,60	01400
104,60	02000

DCN	KOMET no.	OAL	LDRED	DCONMS	Insert
mm		mm	mm	mm	
8	B05 80080	58,88	28,0	12	TO.X 06T1..
14	B05 80140	70,00	39,5	12	TO.X 0902..
20	B05 80200	85,00	54,4	12	TO.X 0902..



62 950 ...

EUR	W7/6B
3,50	12800
3,05	12000

Spare parts

Insert

TO.X 06T1..	M2x3,8/IP6	3,50	12800
TO.X 0902..	M2,6x5,2 - 08IP	3,05	12000

MicroKom – Serrated body for hi.flex micro

▲ with thro' coolant

Scope of supply:
without insert holder

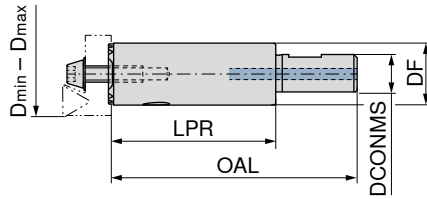

NEW

62 861 ...

EUR
W4/6A

72,36 04400

D _{min} - D _{max} mm	KOMET no.	DCONMS mm	OAL mm	LPR mm	DF mm
25 - 44	M05 90120	12	76,39	51,39	19



Cylindrical screw



Disk spring

62 950 ...

EUR
W7/6B

2,89 53600

62 950 ...

EUR
W7/6B

2,03 19100

Spare parts
DCONMS

12

M5x16

10x5,2x0,3

MicroKom – Insert holder for hi.flex micro

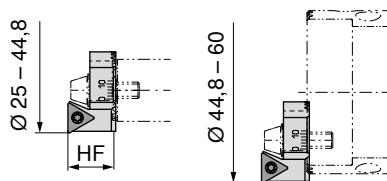

NEW

62 863 ...

EUR
W4/6A

160,90 14400

DCN mm	DCX mm	KOMET no.	HF mm	Insert
25	60	M05 20110	14,48	TO.. 0902



TORX® Screws

62 950 ...

EUR
W7/6B

3,05 09900

Spare parts
Insert

TO.. 0902

MicroKom – Filling piece for hi.flex micro

▲ For targeted redirecting of the thro' coolant to the cutting edge when using insert holders with diameters from 45 mm

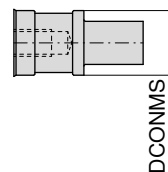

NEW

62 862 ...

EUR
W4/6A

10,83 01200

DCONMS mm	KOMET no.
12	M05 90700

→ Page 58+59
Find suitable indexable inserts here.

MicroKom – M03Speed – precision adjustment head

Scope of supply:

Precision adjustment head with clamping screw

Please order insert holder and indexable insert separately

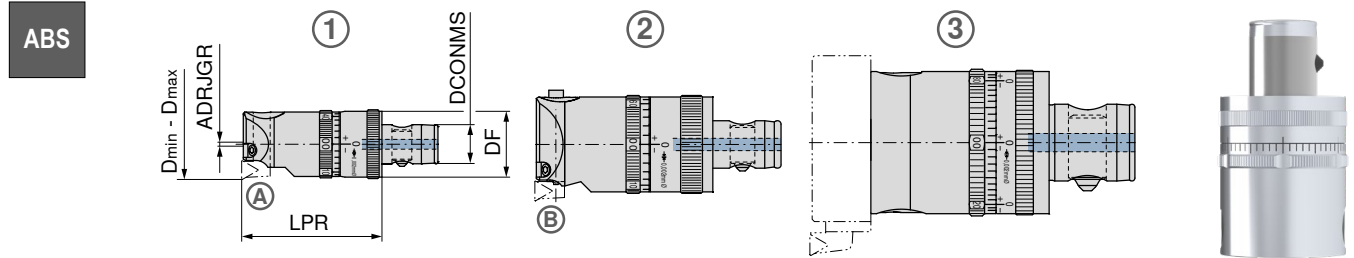

D _{min} - D _{max} mm	KOMET no.	Adapter	DCONMS mm	DF mm	LPR mm	Fig.	Suitable insert holders	ADJRGR mm	WT kg	62 815 ... EUR W4/6A	
24,8 - 33,0	M03 00115	ABS 25	13	25	50	1	62 864 03300	0,25 Ø	0,15	1.986,00	03390
29 - 39	M03 00515	ABS 25	13	25	50	1	62 864 03900	0,4 Ø	0,17	2.029,00	03990
38 - 50	M03 01025	ABS 32	16	32	60	2	62 864 05000	0,4 Ø	0,35	2.129,00	05089 ¹⁾
49 - 63	M03 01535	ABS 40	20	40	70	2	62 864 08000	0,4 Ø	0,63	2.398,00	06388 ¹⁾
62 - 80	M03 02045	ABS 50	28	50	75	2	62 864 08000	0,6 Ø	1,12	2.555,00	08097 ¹⁾
79 - 103	M03 02555	ABS 63	34	63	80	2	62 864 10300	0,6 Ø	1,91	2.808,00	10396 ¹⁾
38 - 63	M03 20170	ABS 32	16	32	81	3		0,4 Ø	0,35	2.117,00	06389 ²⁾
62 - 103	M03 20140	ABS 50	28	50	103	3		0,6 Ø	1,30	2.117,00	10397 ²⁾
100 - 206	M03 20090	ABS 63	34	63	106	3		0,6 Ø	1,91	2.117,00	20696 ²⁾

1) With dynamic balancing compensation

2) With dynamic balancing compensation / can only be used with interchangeable bridge (Art. No. 62 865 ...)

Spare parts for Article no.	TORX® Screws		Clamping screw		Grub screw	
	62 950 ... EUR W7/6B		62 950 ... EUR W7/6B		10 950 ... EUR W7/6B	
62 815 03390					M4x0,5	2,03 15600
62 815 03990					M4x0,5	2,03 15600
62 815 05089	M3,5x7,3 - 10IP	3,05 12600			M4x0,5	2,03 15600
62 815 06388	M3,5x7,3 - 10IP	3,05 12600			M5x0,5	2,03 15700
62 815 08097	M3,5x7,3 - 10IP	3,05 12600			M5x0,5	2,03 15700
62 815 10396	M5x9,4/IP6	3,05 45400			M6x8 - SW3	1,11 11300
62 815 06389			M8x10	8,99 37400		
62 815 10397			M8x10	8,99 37400		
62 815 20696	M5x9,4/IP6	3,05 45400	M8x10	8,99 37400		

- The TORX® screws 62 950 12600 / 62 950 45400 are designed for mounting the insert holder on the precision adjustment head.
- A detailed operating manual is available for download in the online shop next to the product.
- Suitable ABS adapters can be found in → **Catalogue – Clamping technology, Chapter 16, Adaptors and Accessories.**
- **Page 8**
Here you will find a detailed system overview.

MicroKom – M03Speed – Insert holder

Scope of supply:
without inserts
incl. mounting screws

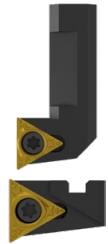
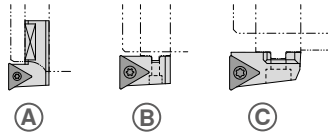

62 864 ...

For precision adjustment head	For precision adjustment head (with interchangeable bridge)	KOMET no.	Insert	Fig.	EUR W4/6A
62 815 03390		M03 10011	TO.. 06T1	A	177,00 03300
62 815 03990		M03 10021	TO.. 06T1	A	177,00 03900
62 815 05089	62 815 06389 (62 865 05100 / 62 865 06300)	M03 10033	TO.. 06T1	B	145,90 05000
62 815 06388 / 62 815 08097	62 815 10397 (62 865 08300 / 62 865 10300)	M03 10043	TO.. 0902	B	145,90 08000
62 815 10396		M03 10063	TO.. 0902	B	155,00 10300
	62 815 20696 (62 865 13000 / 62 865 16800 / 62 865 20600)	M03 10070	TO.. 0902	C	155,00 20600



62 950 ...

Spare parts	Insert	EUR W7/6B
TO.. 06T1	M2x4,9/IP6	3,50 09700
TO.. 0902	M2,6x5,2 - 08IP	3,05 12000

→ Page 58+59
Find suitable indexable inserts here.

MicroKom – M03Speed – Interchangeable bridge

Scope of supply:
without insert holder

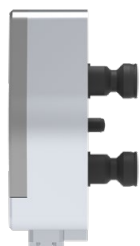
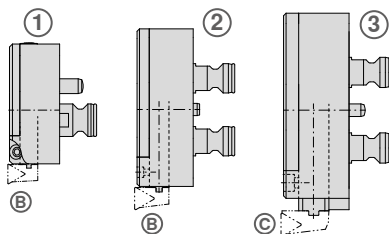

62 865 ...

D _{min} - D _{max} mm	KOMET no.	Fig.	WT kg	For precision adjustment head	Suitable insert holders	EUR W4/6A
38 - 51	M03 20180	1	0,06	62 815 06389	62 864 05000	724,20 05100
50 - 63	M03 20190	1	0,08	62 815 06389	62 864 05000	745,10 06300
62 - 83	M03 20150	2	0,20	62 815 10397	62 864 08000	776,30 08300
82 - 103	M03 20160	2	0,24	62 815 10397	62 864 08000	778,90 10300
100 - 130	M03 20100	3	0,39	62 815 20696	62 864 20600	853,10 13000
128 - 168	M03 20110	3	0,49	62 815 20696	62 864 20600	978,10 16800
166 - 206	M03 20120	3	0,59	62 815 20696	62 864 20600	1.128,00 20600

MicroKom – FF precision adjustment head

Scope of supply:

Head with clamping screw
Without precision turning insert

ABS

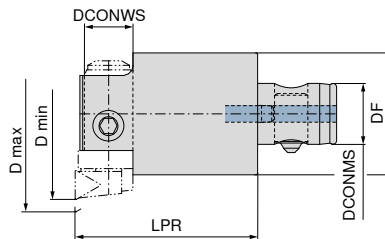

62 810 ...

D _{min} - D _{max} mm	KOMET no.	Adapter	DCONWS mm	DCONMS mm	DF mm	LPR mm	WT kg	EUR W4/6A
29,5 - 36	B30 11010	ABS 25	10	13	25	50	0,17	317,80 03690
35,5 - 42	B30 11020	ABS 25	10	13	25	50	0,18	317,80 04290
39 - 45	B30 12010	ABS 32	12	16	32	60	0,35	331,20 04589
44 - 50	B30 12020	ABS 32	12	16	32	60	0,35	331,20 05089
47 - 57	B30 13010	ABS 40	16	20	40	60	0,52	351,40 05788
56 - 66	B30 13020	ABS 40	16	20	40	60	0,52	351,40 06688
58 - 71	B30 14010	ABS 50	20	28	50	70	0,97	388,90 07197
70 - 83	B30 14020	ABS 50	20	28	50	70	1,05	388,90 08397
79 - 94	B30 15010	ABS 63	25	34	63	70	1,58	450,50 09496
93 - 108	B30 15020	ABS 63	25	34	63	70	1,61	450,50 10896
100 - 121	B30 16010	ABS 80	32	46	80	90	3,33	539,00 12192
120 - 141	B30 16020	ABS 80	32	46	80	90	3,37	539,00 14192
138 - 159	B30 17010	ABS 100	32	56	100	90	6,56	623,50 15991
158 - 179	B30 17020	ABS 100	32	56	100	90	6,80	623,50 17991
178 - 199	B30 17030	ABS 100	32	56	100	90	6,61	623,50 19991



62 950 ...

Spare parts for Article no.	EUR W7/6B
62 810 03690	M6x6/SW3 1,13 44700
62 810 04290	M6x6/SW3 1,13 44700
62 810 04589	M8x8 - SW4 2,03 14700
62 810 05089	M8x10 - SW4 2,03 44800
62 810 05788	M10x10/SW5 2,03 44900
62 810 06688	M10x10/SW5 2,03 44900
62 810 07197	M12x12/SW6 1,13 45000
62 810 08397	M12x12/SW6 1,13 45000
62 810 09496	M16x16/SW8 1,13 45100
62 810 10896	M16x16/SW8 1,13 45100
62 810 12192	M20x20 - SW10 2,25 45200
62 810 14192	M20x20 - SW10 2,25 45200
62 810 15991	M20x30/SW10 2,58 45300
62 810 17991	M20x20 - SW10 2,25 45200
62 810 19991	M20x20 - SW10 2,25 45200

Suitable ABS adapters can be found in → **Catalogue – Clamping technology, Chapter 16, Adaptors and Accessories.**

→ **Page 8**
Here you will find a detailed system overview.

MicroKom – FF precision turning insert

Scope of supply:

Precision turning insert with fixing screw
Please order indexable insert separately

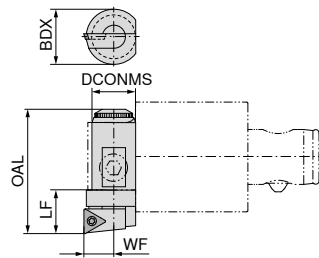

62 855 ...

for	DCONMS mm	KOMET no.	LF mm	WF mm	BDX mm	OAL mm	Insert	EUR W4/6A
62 810 03690 / 62 810 04290	10	M30 20011	11,0	7,5	14	28,5	TO.. 06T1	399,60 03000
62 810 04589 / 62 810 05089	12	M30 20021	12,5	9,0	16	37,5	TO.. 06T1	445,20 03900
62 810 05788 / 62 810 06688	16	M30 20031	16,0	11,0	20	45,0	TO.. 0902	488,20 04700
62 810 07197 / 62 810 08397	20	M30 20041	18,0	14,5	25	56,0	TO.. 0902	564,40 05800
62 810 09496 / 62 810 10896	25	M30 20051	21,6	16,0	32	77,5	TO.. 1403	614,10 07900
62 810 12192 / 62 810 14192	32	M30 20061	25,5	19,0	40	97,0	TO.. 1403	722,80 10000
62 810 15991 / 62 810 17991 / 62 810 19991	32	M30 20071	25,5	19,0	40	131,0	TO.. 1403	776,40 13800

5

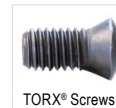

TORX® Screws

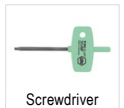

Screwdriver

62 950 ...

80 950 ...

Spare parts DCONMS		EUR W7/6B	EUR Y7
10	M2x3,8/IP6	3,50 12800	
12	M2x3,8/IP6	3,50 12800	
16	M2,6x5,2 - 08IP	3,05 12000	T08 - IP 7,61 060
20	M2,6x6,2 - 08IP	3,05 09900	T08 - IP 7,61 060
25	M3,5x7,3 - 10IP	3,05 12600	T10 - IP 8,19 062
32	M3,5x7,3 - 10IP	3,05 12600	T10 - IP 8,19 062

→ Page 58+59
Find suitable indexable inserts here.

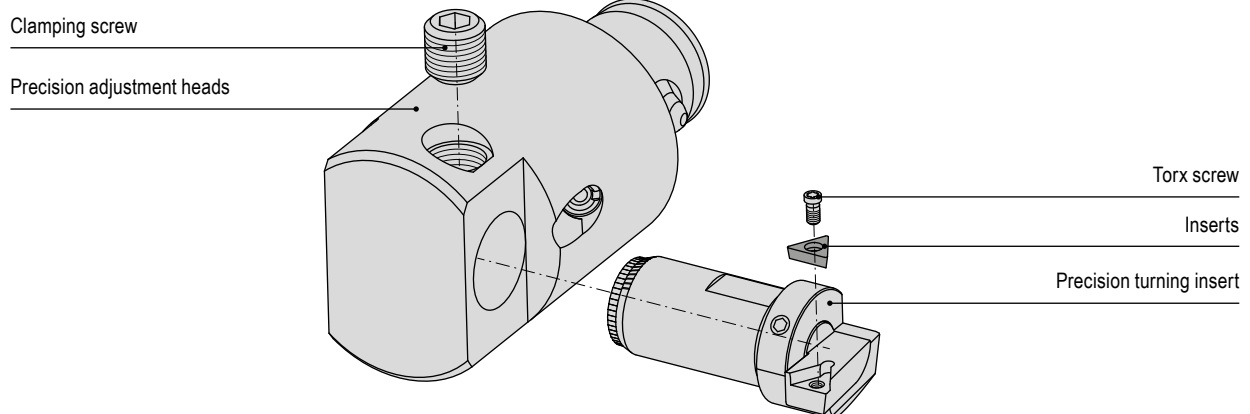

SpinTools – Micro-Boring Head

▲ max. speed 30,000 U/min

▲ Digital variant: please order the digital stick separately

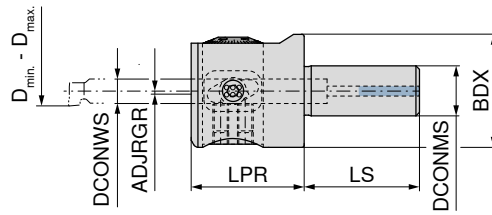

D _{min} - D _{max} mm	BDX mm	DCONWS mm	DCONMS mm	LPR mm	LS mm	ADJRGR mm	WT kg	Analogue		Digital	
								62 382 ...		62 386 ...	
0,3 - 7,1	25	4	10	25	25	0 - 1,7	0,10	EUR W4 1.279,00	025	EUR W4 1.527,00	025
0,3 - 19,1	32	7	16	32	40	0 - 2,75	0,25	1.327,00	032	1.581,00	032



Clamping screw
ST



Locking screw

Spare parts for Article no.

62 382 025 / 62 386 025	M5x4	EUR W7 1,55	214	M4x8	EUR W7 1,32	228
62 382 032 / 62 386 032	M6x5	1,55	215	M6x10	1,32	229

A detailed operating manual is available for download in the online shop next to the product.

→ Page 7
Here you will find a detailed system overview.

SpinTools – Digital Stick

▲ suitable for all SpinTools digital heads as well as for hi.flex Digital

▲ revised software for even more precise adjustment

Scope of supply:

incl. AAA Battery



62 309 ...
EUR W4 317,10
00100

A detailed operating manual is available for download in the online shop next to the product.

SpinTools – Solid carbide boring bar

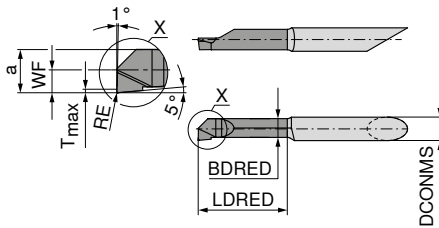

62 383 ...

D _{min} - D _{max} mm	DCONMS mm	LDRED mm	RE mm	a mm	BDRED mm	WF mm	T _{max} mm	EUR W4	
0,3 - 0,7	4	1,2		0,25	0,15	0,15	0,03	59,81	003
0,6 - 1,1	4	2,5		0,55	0,46	0,30	0,05	59,81	006
1,0 - 2,3	4	4,0	0,05	0,95	0,65	0,50	0,10	60,25	010
2,2 - 3,3	4	6,0	0,05	2,00	1,55	1,10	0,20	50,99	022
3,2 - 4,3	4	10,2	0,05	3,00	2,55	1,60	0,20	52,14	032
3,9 - 7,1	4	15,2	0,05	3,70	3,45	1,95	0,30	55,91	039
5,2 - 6,3	7	20,3	0,05	5,00	4,25	2,60	0,50	78,07	052
6,2 - 7,3	7	20,3	0,05	6,00	5,25	3,10	0,50	78,07	062
6,9 - 8,1	7	25,4	0,20	6,70	6,25	3,45	0,50	70,70	069

P	●
M	●
K	●
N	●
S	●
H	○
O	●

→ v_c Page 66

SpinTools – Carbide inserts

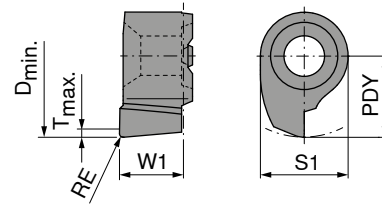

62 384 ...

D _{min} - D _{max} mm	RE mm	PDY mm	S1 mm	W1 mm	T _{max} mm	EUR W4	
6,9 - 8,1	0,2	3,45	4,8	3,5	1	28,23	069
7,9 - 9,1	0,2	3,95	4,8	3,5	1	28,23	079
8,9 - 10,1	0,2	4,45	4,8	3,5	1	28,23	089
9,9 - 12,1	0,2	4,95	7,0	3,9	1	29,98	099
11,9 - 14,1	0,2	5,95	7,0	3,9	1	29,98	119
13,9 - 19,1	0,2	6,95	7,0	3,9	1	29,98	139

P	●
M	●
K	●
N	●
S	●
H	○
O	●

→ v_c Page 66

SpinTools – Adapter

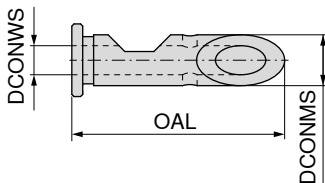

62 335 ...

DCONMS mm	DCONWS mm	OAL mm	EUR W4	
7	4	30	92,78	407

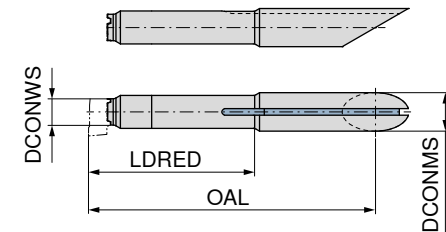

62 385 ...

DCONMS mm	LDRED mm	DCONWS mm	OAL mm	EUR W4	
7	30	4,8	56	251,50	330
7	35	7,0	61	266,50	350



TORX® Screws

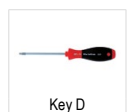

Key D

62 950 ...

EUR
W7

80 950 ...

EUR
Y7

Spare parts
for Article no.

62 385 330	7,39	007	13,18	124
62 385 350	7,39	094	14,50	126

SpinTools – Precision boring head

▲ with thro' coolant

Scope of supply:

Fine boring head without shank, without insert holder

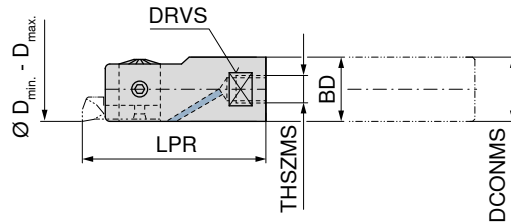

BD	D _{min} - D _{max}	THSZMS	DCONMS	LPR	DRVS	WT
mm	mm		mm	mm	mm	kg
14	14,7 - 17,1	M6	14	39,8	12	0,05
16	16,7 - 20,1	M10	16	39,8	14	0,07
19	19,7 - 24,1	M10	18	39,8	16	0,09

62 304 ...

EUR	
W4	
1.081,00	017
1.081,00	020
1.081,00	024



TORX® Screws

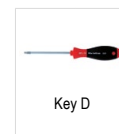

Key D



Clamping screw
ST

62 950 ...

80 950 ...

62 950 ...

Spare parts for Article no.

Article no.	Part	EUR	Part	EUR	Part	EUR
62 304 017	M2,5x6	4,16	T07	10,05	M3x2	2,61
62 304 020	M2,5x6	4,16	T07	10,05	M3x2,5	2,61
62 304 024	M2,5x6	4,16	T07	10,05	M3x4	2,61

→ Page 73
Here you will find information about the working length.

→ Page 9
Here you will find a detailed system overview.

SpinTools – Insert holder, 90°

Scope of supply:

without insert

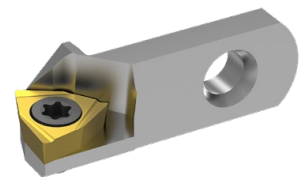
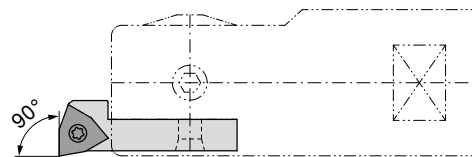

62 317 ...

EUR	
W4	
188,50	024

Insert

WC.. 0201..



TORX® Screws

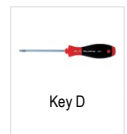

Key D

62 950 ...

80 950 ...

Spare parts Insert

Article no.	Part	EUR	Part	EUR
WC.. 0201..	M2x3,7	4,16	T06	10,87

→ Page 62
Find suitable indexable inserts here.

SpinTools – High-speed carbide boring bars

- ▲ with threaded mounting stud made of high quality steel
- ▲ with thro' coolant
- ▲ Shank clamping length 35 mm
- ▲ Boring shanks with DCONMS Ø 18 mm are for use in collet chuck or hydraulic chuck

Scope of supply:

boring shank, without boring head

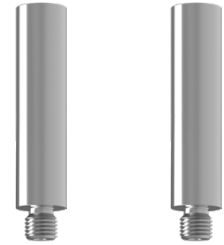
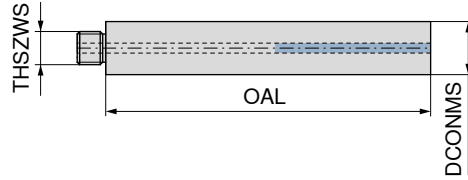

5

DCONMS mm	OAL mm	THSZWS
14	110	M6
16	120	M10
18	100	M10
18	140	M10
18	180	M10

62 353 ...	62 353 ...
EUR W4	EUR W4
488,90	
547,40	
	014
	016
	579,60 018
	798,20 118
	1.032,00 218

→ Page 73
Here you will find information about the working length.

SpinTools – Shank extensions (tempered steel)

- ▲ with thro' coolant

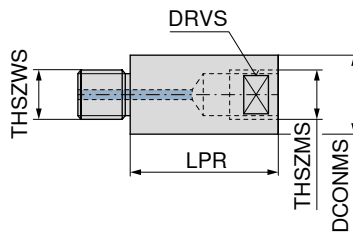

DCONMS mm	LPR mm	THSZWS	THSZMS	DRVS mm
16	32	M10	M10	14
16	64	M10	M10	14

62 349 ...
EUR W4
86,09 732
97,42 764

SpinTools – Multi-Head – boring and fine boring head

- ▲ For boring bars \varnothing 16 mm and bridges
- ▲ With internal coolant supply
- ▲ LSCX = Boring depth

Scope of supply:

without boring bar, bridge and insert holder

D _{min} - D _{max} mm	Adapter	DCONMS mm	BDX mm	LPR mm	LB mm	LSCX mm	ADJRGR mm	WT kg	62 372 ... EUR W4	62 373 ... EUR W4	62 373 ... EUR W4	62 373 ... EUR W4
3 - 320	STM 36	36	63	71,6	111,6	0 - 2,7	1,69	1.527,00	653			
3 - 320	SK 40		63	91,6	72,5	0 - 2,7	1,90				1.868,00	153
3 - 320	BT 40		63	91,6	69,0	0 - 2,7	2,20				1.868,00	453
3 - 320	HSK-A 63		63	96,6	70,6	0 - 2,7	1,90		1.868,00	653		

Spare parts

D _{min} - D _{max}	62 950 ... EUR W7	62 950 ... EUR W7	62 950 ... EUR W7	62 950 ... EUR W7	62 950 ... EUR W7
3 - 320	1,32 227	1,55 167	51,09 040	2,33 226	3,79 225

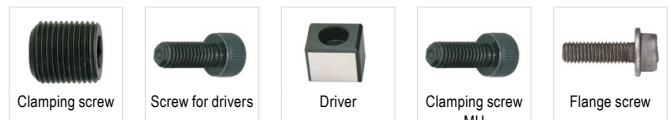

A detailed operating manual is available for download in the online shop next to the product.

→ Page 50–56
Here you will find the suitable base adaptors.

→ Page 7
Here you will find a detailed system overview.

SpinTools – Multi-Head – Boring and Fine Boring Head Set

▲ suitable for \varnothing 3 – \varnothing 320 mm

Scope of supply:

- ▲ 1 Tool Kit
- ▲ 1 Multi-Head-Boring- and Fine Boring Head (depending on selection)
- ▲ 4 Boring bars
 - 62 345 015 \varnothing 9.75 – \varnothing 15.1 mm
 - 62 345 020 \varnothing 14.75 – \varnothing 20.1 mm
 - 62 345 024 \varnothing 19.75 – \varnothing 25.1 mm
 - 62 345 029 \varnothing 24.75 – \varnothing 30.1 mm
- ▲ 2 Boring tools, adjustable
 - 62 375 048 \varnothing 29.75 – \varnothing 48.1 mm
 - 62 375 088 \varnothing 47.75 – \varnothing 88.1 mm
- ▲ incl. insert holder
 - 62 377 048 CC.. 0602
 - 62 377 088 CC.. 0602
- ▲ 1 Bridge
 - 62 376 164 \varnothing 86 – \varnothing 164 mm
- ▲ 1 Torx-Key – T7
- ▲ 1 6-adjustment key – SW5



D _{min} - D _{max} mm	Adapter	STM Modular 62 374 ... EUR W4	HSK-A 62 379 ... EUR W4	SK 62 379 ... EUR W4	MAS-BT 62 379 ... EUR W4
9,75 - 164	HSK-A 63		2.940,00 996		2.940,00 993
9,75 - 164	BT 40				
9,75 - 164	SK 40			2.940,00 990	
9,75 - 164	STM 36	2.640,00 999			

SpinTools – Bridge for Multi-Head

- ▲ Ø adjustable
- ▲ With internal coolant supply

Scope of supply:
without tool holder
including fixation screws

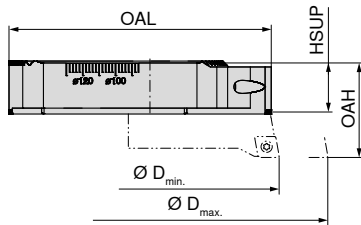

62 376 ...			
D _{min} - D _{max} mm	OAL mm	HSUP mm	OAH mm
86 - 164	80	15	29
162 - 320	158	15	29

EUR W4
353,90 164
530,10 320

SpinTools – Tool holder for boring bar and bridge Multi-Head

Scope of supply:
without inserts
incl. mounting screws

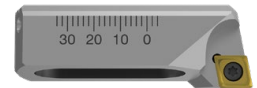
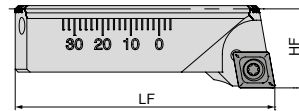

62 377 ...			
for	LF mm	HF mm	Insert
62 375 048	28,2	12	CC.. 0602
62 375 088 / 62 376 ...	46,0	14	CC.. 0602
62 375 088 / 62 376 ...	46,0	14	CC.. 09T3

EUR W4
258,20 048
284,30 088
296,40 089

SpinTools – Counterweight

Scope of supply:
Including fixation screw

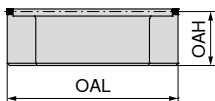
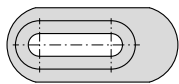

62 378 ...			
for	OAL mm	OAH mm	
62 376 ...	38	12	

EUR W4
100,60 320

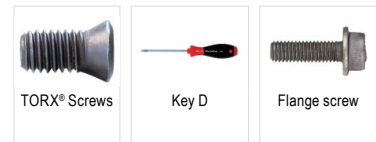

62 950 ...			80 950 ...			62 950 ...		
Spare parts for Article no.	EUR W7		EUR Y7		EUR W7			
62 377 048 / 62 377 088	4,16	022	10,05	109	3,79	225		
62 377 089	5,04	023	11,96	113	3,79	225		

→ Page 63
Find suitable indexable inserts here.

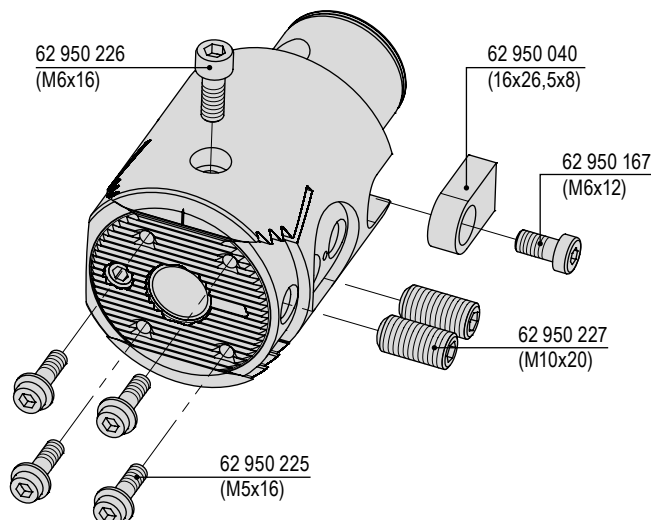

SpinTools – Single point boring heads – Modular system

- ▲ LSCX = Recess depth of boring bar
- ▲ With thro' coolant supply
- ▲ Digital variant: please order the digital stick separately

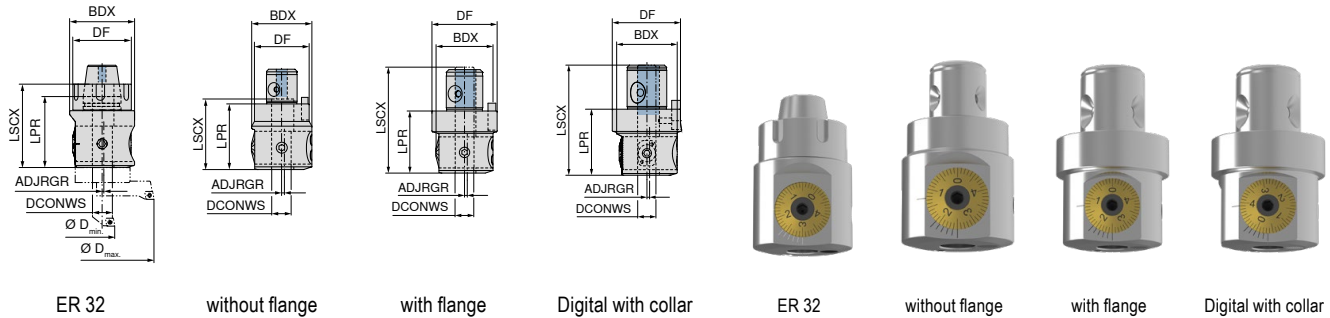

D _{min} - D _{max} mm	Adapter	BDX mm	DF mm	DCONWS mm	LPR mm	LSCX mm	ADJRGR mm	WT kg	62 332 ... EUR W4	62 332 ... EUR W4	62 332 ... EUR W4	62 326 ... EUR W4
3,0 - 88,1	ER 32	55	49,5	16	60	86,5	0 - 2,7	0,43	1.220,00	732		
3,0 - 88,1	STM 28	55	50,0	16	60	62,0	0 - 2,7	0,98		1.226,00	553	
3,0 - 88,1	STM 36	55	63,0	16	60	101,0	0 - 2,7	1,26			1.226,00	653
3,0 - 88,1	STM 36	55	63,0	16	60	106,0	0 - 2,7	0,43				1.317,00

Spare parts for Article no.	Clamping screw	Screw for drivers	Driver	Clamping screw ST
	62 950 ... EUR W7	62 950 ... EUR W7	62 950 ... EUR W7	62 950 ... EUR W7
62 332 732	M10x16	1,55	047	
62 332 553	M10x16	1,55	047	M5x10
62 332 653	M10x16	1,55	047	M6x12
62 326 036	M10x16	1,55	047	M6x12
				12x20x6
				16x26,5x8
				16x26,5x8
				16x26,5x8
				40,31
				039
				51,09
				040
				51,09
				040
				M10x8
				M10x8
				M10x8
				M10x8
				1,55
				046
				1,55
				046
				1,55
				046

- A detailed operating manual is available for download in the online shop next to the product.
- Page 50–56
Here you will find the suitable base adaptors.
- Page 7
Here you will find a detailed system overview.

SpinTools – Digital Stick

- ▲ suitable for all SpinTools digital heads as well as for hi.flex Digital
- ▲ revised software for even more precise adjustment

Scope of supply:
incl. AAA Battery



62 309 ... EUR W4 317,10	00100
-----------------------------------	-------

- A detailed operating manual is available for download in the online shop next to the product.

SpinTools – Single point boring head – Monoblock analogue

- ▲ LSCX = Boring depth
- ▲ With internal coolant supply

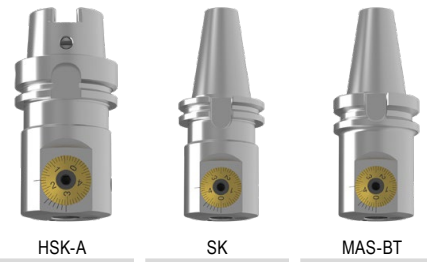
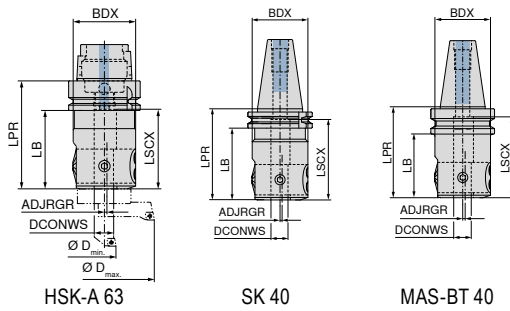

D _{min} - D _{max} mm	Adapter	BDX mm	DCONWS mm	LPR mm	LB mm	LSCX mm	ADJRGR mm	WT kg
3,0 - 88,1	HSK-A 63	55	16	95	69	70	0 - 2,7	1,66
3,0 - 88,1	SK 40	55	16	90	70	80	0 - 2,7	1,83
3,0 - 88,1	BT 40	55	16	90	63	80	0 - 2,7	1,90

HSK-A	SK	MAS-BT
62 333 ...	62 333 ...	62 333 ...
EUR W4	EUR W4	EUR W4
1.556,00 653	1.556,00 153	1.556,00 453

Spare parts

D _{min} - D _{max}
3,0 - 88,1

Clamping screw	Clamping screw ST
62 950 ...	62 950 ...
EUR W7	EUR W7
M10x16 1,55 047	M10x8 1,55 046

SpinTools – Single point boring head – Monoblock digital

- ▲ LSCX = Recess depth of boring bar
- ▲ With thro' coolant supply
- ▲ Digital variant: please order the digital stick separately

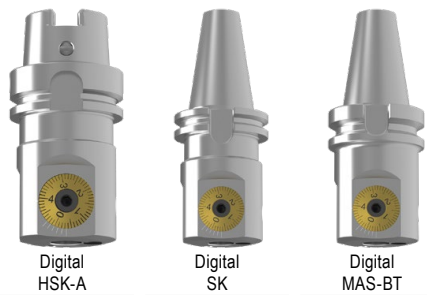
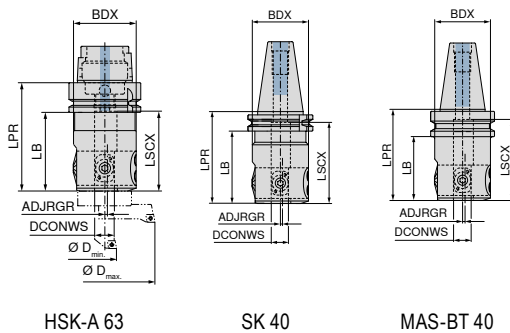

D _{min} - D _{max} mm	Adapter	BDX mm	DCONWS mm	LPR mm	LB mm	LSCX mm	ADJRGR mm	WT kg
3,0 - 88,1	HSK-A 63	55	16	95	70	70	0 - 2,7	1,66
3,0 - 88,1	SK 40	55	16	90	71	80	0 - 2,7	1,83
3,0 - 88,1	BT 40	55	16	90	59	80	0 - 2,7	1,90

Digital HSK-A	Digital SK	Digital MAS-BT
62 363 ...	62 363 ...	62 363 ...
EUR W4	EUR W4	EUR W4
1.883,00 688	1.883,00 188	1.883,00 488

Spare parts

D _{min} - D _{max}
3,0 - 88,1

Clamping screw	Clamping screw ST
62 950 ...	62 950 ...
EUR W7	EUR W7
M10x16 1,55 047	M10x8 1,55 046

A detailed operating manual is available for download in the online shop next to the product.

SpinTools – Single point boring heads Set 1

- ▲ suitable for $\varnothing 3 - \varnothing 88.1$ mm
- ▲ supplied with $\varnothing 9.75 - \varnothing 30.1$ or $\varnothing 9.75 - \varnothing 40.1$ mm
- ▲ with thro' coolant

Scope of supply:

- ▲ 1 Tool Kit
- ▲ 1 single point boring head (depending on selection)
- ▲ 4 Boring bars (SK40- and MAS-BT-Set)
 - 62 345 015 $\varnothing 9.75 - \varnothing 15.1$ mm
 - 62 345 020 $\varnothing 14.75 - \varnothing 20.1$ mm
 - 62 345 024 $\varnothing 19.75 - \varnothing 25.1$ mm
 - 62 345 029 $\varnothing 24.75 - \varnothing 30.1$ mm
- ▲ 8 Boring bars (Modular-Set)
 - 62 345 015 $\varnothing 9.75 - \varnothing 15.1$ mm
 - 62 345 019 $\varnothing 13.75 - \varnothing 19.1$ mm
- 62 345 023 $\varnothing 17.75 - \varnothing 23.1$ mm
- 62 345 027 $\varnothing 21.75 - \varnothing 27.1$ mm
- 62 345 030 $\varnothing 24.75 - \varnothing 30.1$ mm
- 62 345 033 $\varnothing 27.75 - \varnothing 33.1$ mm
- 62 345 037 $\varnothing 31.75 - \varnothing 37.1$ mm
- 62 345 040 $\varnothing 34.75 - \varnothing 40.1$ mm
- ▲ 1 6-adjustment key – SW5
- ▲ 1 Torx-Key – T7



D _{min} - D _{max} mm	Adapter
9,75 - 30,1	SK 40
9,75 - 30,1	BT 40
9,75 - 40,1	STM 36

STM Modular	SK	MAS-BT
62 334 ...	62 345 ...	62 345 ...
EUR W4	EUR W4	EUR W4
2.526,00 999	1.993,00 990	1.993,00 993

SpinTools – Single point boring heads Set 2

- ▲ suitable for $\varnothing 3 - \varnothing 88.1$ mm
- ▲ Supplied with $\varnothing 9.75 - \varnothing 88.1$ mm
- ▲ with thro' coolant

Scope of supply:

- ▲ 1 Tool Kit
- ▲ 1 Fine boring head (depending on selection)
- ▲ 4 Boring bars
 - 62 345 015 $\varnothing 9.75 - \varnothing 15.1$ mm
 - 62 345 020 $\varnothing 14.75 - \varnothing 20.1$ mm
 - 62 345 024 $\varnothing 19.75 - \varnothing 25.1$ mm
 - 62 345 029 $\varnothing 24.75 - \varnothing 30.1$ mm
- ▲ 2 Boring tools, adjustable
 - 62 375 048 $\varnothing 29.75 - \varnothing 48.1$ mm
 - 62 375 088 $\varnothing 47.75 - \varnothing 88.1$ mm
- ▲ incl. insert holder
 - 62 377 048 CC.. 0602
 - 62 377 088 CC.. 0602
- ▲ 1 Torx key – T7
- ▲ 1 6-adjustment key – SW5



D _{min} - D _{max} mm	Adapter
9,75 - 88,1	HSK-A 63
9,75 - 88,1	BT 40
9,75 - 88,1	SK 40
9,75 - 88,1	STM 36

STM Modular	HSK-A	SK	MAS-BT
62 334 ...	62 345 ...	62 345 ...	62 345 ...
EUR W4	EUR W4	EUR W4	EUR W4
2.739,00 997	3.075,00 997	3.075,00 998	3.075,00 999

SpinTools – Single point boring heads ER32 Set

- ▲ Suitable for $\varnothing 3.0 - \varnothing 88.1$ mm
- ▲ Scope of supply $\varnothing 9.75 - \varnothing 30.1$ mm
- ▲ with thro' coolant supply

Scope of supply:

- ▲ 1 tool kit
- ▲ 1 single point boring head (62332732)
- ▲ 4 boring bars
 - 62 345 015 $\varnothing 9.75 - \varnothing 15.1$ mm
 - 62 345 020 $\varnothing 14.75 - \varnothing 20.1$ mm
 - 62 345 024 $\varnothing 19.75 - \varnothing 25.1$ mm
 - 62 345 029 $\varnothing 24.75 - \varnothing 30.1$ mm
- ▲ 1 Torx Key – T7
- ▲ 1 Allen Key – SW5



D _{min} - D _{max} mm	Adapter
9,75 - 30,1	ER 32

62 332 ...
EUR W4
1.623,00 999

SpinTools – Boring tools with carbide cutting edge

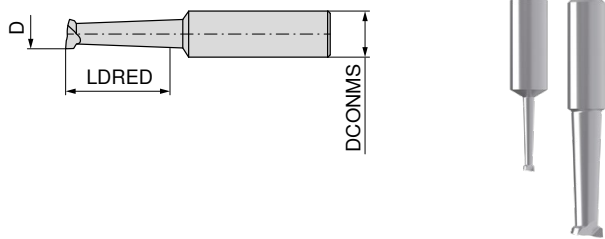

$D_{min} - D_{max}$ mm	LDRED mm	DCONMS _{h6} mm	62 346 ...	
			EUR	
			W4	
3,0 - 8,0	20	10	165,40	008
4,0 - 9,0	23	10	165,40	009
5,0 - 10,0	25	10	165,40	010
6,0 - 11,0	25	10	165,40	011
7,0 - 12,0	31	10	165,40	012

P	●
M	○
K	○
N	●
S	○
H	○
O	○

→ v_c Page 66

SpinTools – Steel boring bars

▲ with thro' coolant

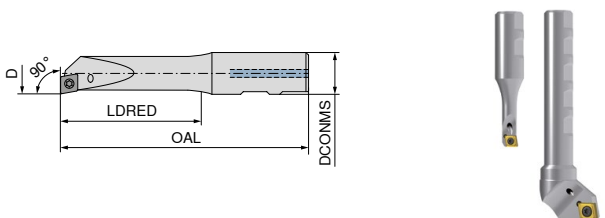

$D_{min} - D_{max}$ mm	OAL mm	LDRED mm	DCONMS _{h6} mm	Insert	62 345 ...	
					EUR	
					W4	
9,75 - 15,1	75	30	16	CC.. 0602	218,60	015
11,75 - 17,1	80	37	16	CC.. 0602	218,60	017
13,75 - 19,1	85	43	16	CC.. 0602	218,60	019
14,75 - 20,1	90	51	16	CC.. 0602	218,60	020
15,75 - 21,1	95	57	16	CC.. 0602	218,60	021
17,75 - 23,1	100	67	16	CC.. 0602	218,60	023
19,75 - 25,1	105	72	16	CC.. 0602	251,50	024
19,75 - 25,1	105	72	16	CC.. 09T3	251,50	025
21,75 - 27,1	110	77	16	CC.. 09T3	251,50	027
24,75 - 30,1	115	82	16	CC.. 0602	251,50	029
24,75 - 30,1	115	82	16	CC.. 09T3	251,50	030
27,75 - 33,1	115	82	16	CC.. 09T3	263,70	033
31,75 - 37,1	115	82	16	CC.. 09T3	263,70	037
34,75 - 40,1	115	82	16	CC.. 09T3	263,70	040
38,75 - 44,1	115	82	16	CC.. 09T3	281,50	044
42,75 - 48,1	115	82	16	CC.. 09T3	296,40	048
47,75 - 53,1	115	82	16	CC.. 09T3	330,70	053

→ Page 63
Find suitable indexable inserts here.

SpinTools – Adjustable boring bar bridge

▲ with thro' coolant

Scope of supply:
without insert holder

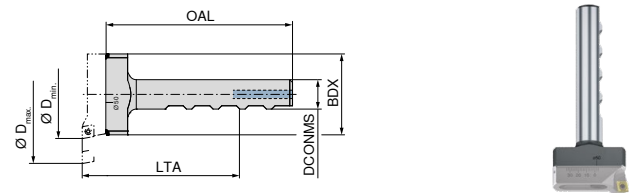

$D_{min} - D_{max}$ mm	OAL mm	BDX mm	LTA mm	DCONMS mm	62 375 ...	
					EUR	
					W4	
29,75 - 48,1	103	25	85	16	146,20	048
47,75 - 88,1	101	44	85	16	169,60	088

5

SpinTools – Tool holder for boring bar and bridge Multi-Head

Scope of supply:
without inserts
incl. mounting screws

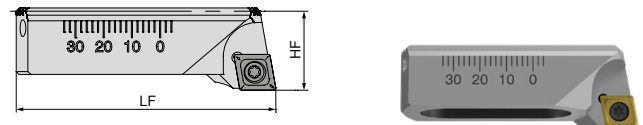

for	LF mm	HF mm	Insert	62 377 ...	
				EUR	
				W4	
62 375 048	28,2	12	CC.. 0602	258,20	048
62 375 088 / 62 376 ...	46,0	14	CC.. 0602	284,30	088
62 375 088 / 62 376 ...	46,0	14	CC.. 09T3	296,40	089

TORX® Screws	Key D	Flange screw	
62 950 ...	80 950 ...	62 950 ...	
EUR	EUR	EUR	
W7	Y7	W7	
Spare parts for Article no.			
62 377 048	4,16 022	10,05 109	3,79 225
62 377 088	4,16 022	10,05 109	3,79 225
62 377 089	5,04 023	11,96 113	3,79 225

→ Page 63
Find suitable indexable inserts here.

SpinTools – Boring bars with carbide shank

- ▲ With internal coolant supply
- ▲ LTA = max. overhang

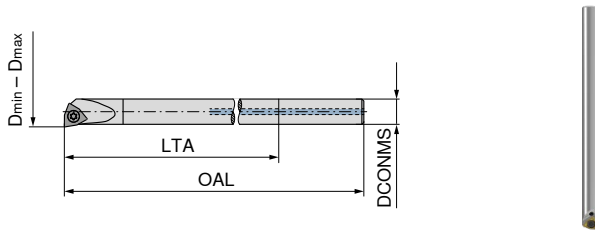

					62 341 ...	
$D_{min} - D_{max}$ mm	DCONMS _{h6} mm	OAL mm	LTA mm	Insert	EUR	
5,8 - 11,2	5	80	45	WC.. 0201..	326,00	011
7,8 - 13,2	6	100	60	WC.. 0201..	326,00	013



TORX® Screws



Key D

Spare parts

Insert	EUR	
WC.. 0201..	W7	021

62 950 ...

EUR	
W7	021
4,16	021

80 950 ...

EUR	
Y7	108
10,87	108

SpinTools – Boring tool extensions

- ▲ with thro' coolant

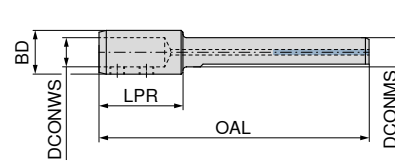

62 337 ...

DCONWS	DCONMS	BD	OAL	LPR	EUR	
mm	mm	mm	mm	mm	W4	
10	16	16	128		213,30	128
16	16	24	148	44	243,30	148



Clamping screw

62 950 ...

Spare parts for Article no.

Article no.	EUR	
62 337 128	W7	048
62 337 148	5,39	048
	6,26	049

→ Page 62
Find suitable indexable inserts here.

SpinTools – Reduction sleeves

- ▲ for boring bars and boring tools

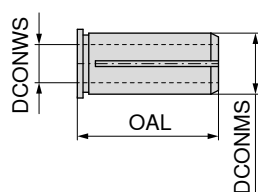

			62 335 ...	
DCONMS	DCONWS	OAL	EUR	
mm	mm	mm	W4	
16	4	37	100,60	104
16	5	37	100,60	105
16	6	37	100,60	106
16	8	37	100,60	108
16	9	37	100,60	109
16	10	37	100,60	110
16	11	37	100,60	111
16	12	37	100,60	112
16	13	37	100,60	113
16	14	37	100,60	114

SpinTools – High-speed boring head

- ▲ for overturning holder and high speed carbide shank
- ▲ With internal coolant supply
- ▲ D_{max.} = using a head with fine adjustment 0 – 2,7 mm

Scope of supply:

Boring head without boring shank, without inserts

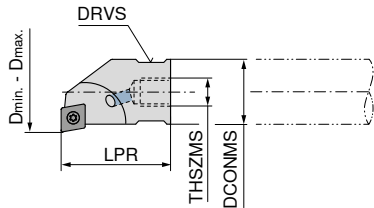

62 361 ...

D _{min} - D _{max} mm	LPR mm	THSZMS	DCONMS _{h6} mm	Insert	EUR W4	
8,75 - 14,1	18	M5	8	CC.. 0602	151,60	014
9,75 - 15,1	18	M5	9	CC.. 0602	151,60	015
10,75 - 16,1	23	M6	10	CC.. 0602	151,60	016
11,75 - 17,1	23	M6	11	CC.. 0602	151,60	017
12,75 - 18,1	23	M6	12	CC.. 0602	151,60	018
13,75 - 19,1	23	M6	13	CC.. 0602	151,60	019
14,75 - 20,1	23	M6	14	CC.. 0602	151,60	020
15,75 - 21,1	23	M6	14	CC.. 0602	151,60	021
16,75 - 22,1	27	M10	16	CC.. 0602	151,60	022
17,75 - 23,1	27	M10	16	CC.. 0602	151,60	023
19,75 - 25,1	27	M10	16	CC.. 0602	151,60	025
21,75 - 27,1	27	M10	16	CC.. 0602	154,50	027
24,75 - 30,1	27	M10	16	CC.. 0602	154,50	030
27,75 - 33,1	27	M10	16	CC.. 0602	154,50	033
31,75 - 37,1	27	M10	16	CC.. 0602	165,40	037
34,75 - 40,1	27	M10	16	CC.. 0602	179,00	040

SpinTools – High-speed carbide boring bars

- ▲ with threaded mounting stud made of high quality steel
- ▲ with thro' coolant
- ▲ Shank clamping length 35 mm

Scope of supply:

boring shank, without boring head

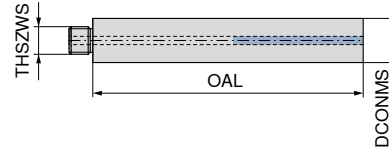

62 353 ...

DCONMS mm	OAL mm	THSZWS	EUR W4	
8	73	M5	321,70	008
9	80	M5	337,10	009
10	82	M6	360,80	010
11	89	M6	378,90	011
12	96	M6	395,70	012
13	103	M6	405,30	013
14	110	M6	488,90	014
16	120	M10	547,40	016



→ Page 73

Here you will find information about the working length.



62 950 ...

80 950 ...

Spare parts

Insert	EUR W7		EUR Y7	
CC.. 0602	4,16	022	10,05	109



→ Page 63

Find suitable indexable inserts here.



A detailed operating manual is available for download in the online shop next to the product.

SpinTools – Single point finish boring heads

- ▲ With thro' coolant supply
- ▲ Digital variant: please order the digital stick separately

Scope of supply:
without insert holder and inserts

STM

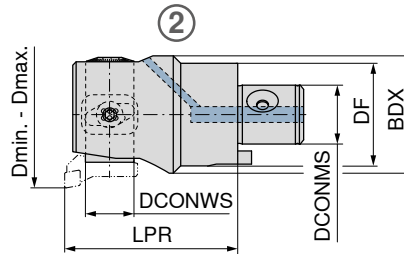
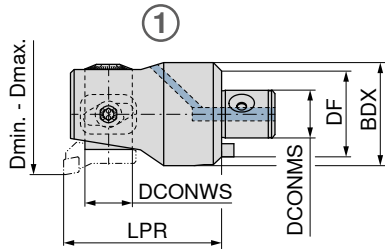

Analogue

Digital

D _{min} - D _{max} mm	D _{min} - D _{max} extended mm	Adapter	DCONMS mm	BDX mm	DF mm	LPR mm	DCONWS mm	WT kg	Fig.	62 303 ...		62 308 ...	
										EUR		EUR	
23,9 - 31,1	29,9 - 37,1	STM 11	11	22,5	20	40	11	0,08	1	800,60	031	944,20	031
30,9 - 40,1	37,9 - 47,1	STM 14	14	29,0	25	45	13	0,15	1	800,60	040	944,20	040
39,9 - 51,1	47,9 - 59,1	STM 18	18	37,0	32	65	17	0,38	1	828,00	051	966,00	051
50,9 - 67,1	64,9 - 81,1	STM 22	22	47,0	40	72	22	0,70	1	866,30	067	1.002,00	067
66,9 - 87,1	84,9 - 105,1	STM 28	28	59,0	50	82	30	1,32	2	933,20	087	1.059,00	087
86,9 - 116,1	104,9 - 134,1 (124,9 - 154,1)	STM 36	36	72,0	63	105	30	3,15	2	1.096,00	116	1.200,00	116

i For optimal stability when fine boring the main insert holder ranges are preferred over the extended range.

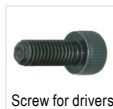

Screw for drivers

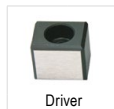

Driver



Fillister-head screw



Clamping screw ST

Spare parts for Article no.	62 950 ...		62 950 ...		62 950 ...		62 950 ...	
	EUR		EUR		EUR		EUR	
62 303 031 / 62 308 031	0,89	162	27,07	035	8,34	287	1,55	213
62 303 040 / 62 308 040	0,89	163	28,14	036	8,34	288	1,55	214
62 303 051 / 62 308 051	1,22	164	30,19	037	8,34	289	1,55	215
62 303 067 / 62 308 067	1,22	165	34,30	038	8,34	290	1,55	216
62 303 087 / 62 308 087	1,55	166	40,31	039	8,34	291	1,55	217
62 303 116 / 62 308 116	1,55	167	51,09	040	8,34	291	1,55	218

i → Page 50–56
Here you will find the suitable base adaptors.

i → Page 9
Here you will find a detailed system overview.

SpinTools – Digital Stick

- ▲ suitable for all SpinTools digital heads as well as for hi.flex Digital
- ▲ revised software for even more precise adjustment

Scope of supply:
incl. AAA Battery



62 309 ...

EUR
W4

317,10 00100

i A detailed operating manual is available for download in the online shop next to the product.

SpinTools – Insert holder

▲ for single point finish boring heads Art. 62 303 ..., 62 308 ...

Scope of supply:

incl. Torx clamping screw for inserts, without fixing bolt for holder

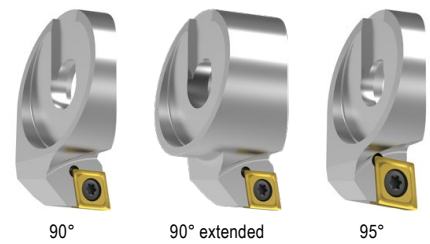
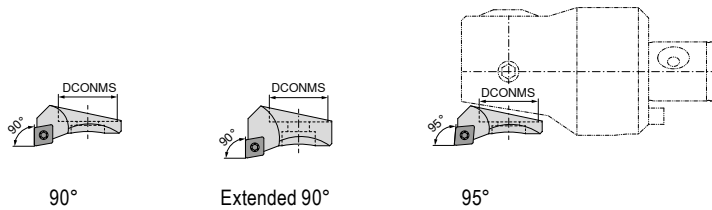

D _{min} - D _{max} mm	D _{min} - D _{max} extended mm	DCONMS mm	Insert
23,9 - 31,1	29,9 - 37,1	11	CC.. 0602
30,9 - 40,1	37,9 - 47,1	13	CC.. 0602
39,9 - 51,1	47,9 - 59,1	17	CC.. 0602
50,9 - 67,1	64,9 - 81,1	22	CC.. 0602
66,9 - 87,1	84,9 - 105,1	30	CC.. 0602
66,9 - 87,1		30	CC.. 09T3
86,9 - 116,1	104,9 - 134,1	30	CC.. 09T3
	124,9 - 154,1	30	CC.. 09T3

62 318 ...		62 318 ...		62 320 ...	
EUR		EUR		EUR	
W4		W4		W4	
165,40	031	199,50	037	184,50	031
184,50	040	218,60	047	200,90	040
200,90	051	240,50	059	221,40	051
218,60	067	261,00	081	229,60	067
239,10	087	281,50	105		
				261,00	087
239,10	116	281,50	134		
		329,30	154		

5

Spare parts

Insert		62 950 ...	80 950 ...
		EUR	EUR
CC.. 0602	M2,5x6	W7	Y7
CC.. 09T3	M4x9	022	023
		4,16	10,05
		5,04	11,96
		022	109
			113

→ Page 63
Find suitable indexable inserts here.

A detailed operating manual is available for download in the online shop next to the product.

SpinTools – High-speed carbide boring tools

▲ Shaft extension for single point finish boring heads Art. No. 62 303 ..., 62 308 ...

▲ with thro' coolant supply

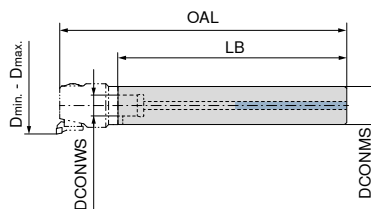

D _{min} - D _{max} mm	DCONWS mm	DCONMS mm	OAL mm	LB mm	WT kg
23,9 - 31,1	11	20	250	210	0,81
30,9 - 40,1	14	25	306	261	1,54
39,9 - 51,1	18	32	380	315	3,03

62 354 ...	
EUR	
W4	
1.650,00	020
2.256,00	025
3.530,00	032

SpinTools – Reverse adapter for back boring

▲ For insert holder article nos. 62 318 ... / 62 320 ...

Scope of supply:

Adapter including fixing bolt

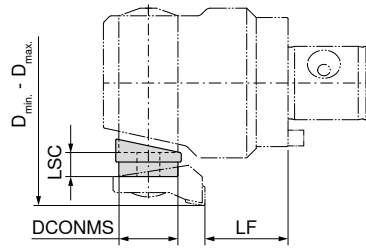

LSC mm	DCONMS mm	LF mm	D _{min} - D _{max} mm
6,5	11	13,0	37 - 44
8,0	11	13,0	40 - 47
6,5	13	12,6	44 - 53
10,0	13	12,6	51 - 60
6,5	17	31,3	53 - 64
10,0	17	31,3	60 - 71
6,5	22	31,2	68 - 80
12,0	22	31,2	75 - 91
10,0	30	29,0	87 - 107

62 321 ...

EUR	
W4	
257,00	044
257,00	051
257,00	053
257,00	060
257,00	064
257,00	071
266,50	080
266,50	091
275,90	107

Note left hand direction of spindle rotation when in use

A detailed operating manual is available for download in the online shop next to the product.

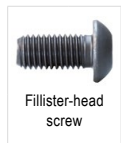

**Spare parts
for Article no.**

Article no.		EUR	
62 321 044	M4x12	8,66	278
62 321 051	M4x13	8,86	279
62 321 053	M5x14	8,66	280
62 321 060	M5x16	8,86	281
62 321 064	M6x15	8,66	282
62 321 071	M6x20	8,86	283
62 321 080	M8x20	8,66	284
62 321 091	M8x25	8,86	285
62 321 107	M10x30	10,05	286

62 950 ...

EUR	
W7	

Minimum diameter (Ø D1) during retraction for back boring

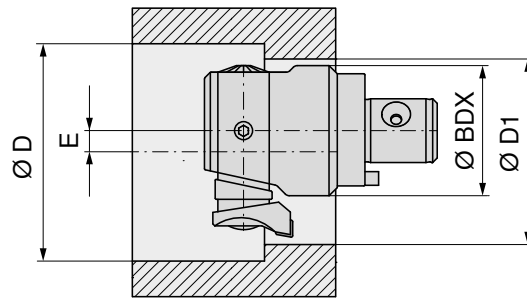

5

Minimum diameter (Ø D1) of the entry bore

$$\varnothing D1 = \frac{\varnothing BDX + \varnothing D}{2} + 1^*$$

*Safety margin

Minimum offset (E) for starting

$$E = \frac{\varnothing D - \varnothing D1}{2} + 0,5^*$$

Example

Single point finish boring head

62 303 031 (Ø BDX = 22,5 mm)

Reverse adapter

Selected

62 321 044 (Ø D_{min} - Ø D_{max} = 37 - 44 mm)

Ø D = 37 mm

Insert holder

62 318 031

$$\varnothing D1 = \frac{\varnothing 22,5 \text{ mm} + \varnothing 37 \text{ mm}}{2} + 1 \text{ mm} = 30,75 \text{ mm}$$

$$E = \frac{\varnothing 37 \text{ mm} - \varnothing 30,75 \text{ mm}}{2} + 0,5 \text{ mm} = 3,625 \text{ mm}$$

SpinTools – Single point finish boring heads

- ▲ With internal coolant supply
- ▲ extremely stable connection between insert holder and boring head

Scope of supply:

Boring head, without insert holder, pressure plate and support

STM

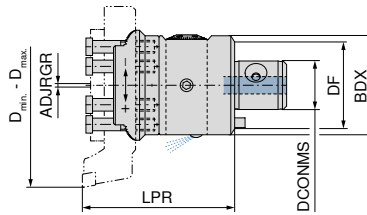

D _{min} - D _{max} mm	Adapter	DCONMS mm	BDX mm	DF mm	LPR mm	ADJRGR mm	WT kg	62 305 ...	
86 - 402	STM 36	36	72	63	120	± 1,25	2,94	EUR W4	2.425,00 302

Spare parts for Article no.	Cylindrical screw	Screw for drivers	Driver	Clamping screw ST
62 305 302	M8x45	M6x12	16x26,5x8	M8x60
	EUR W7 4,69 292	EUR W7 1,55 167	EUR W7 51,09 040	EUR W7 8,86 011

- **Page 50–56**
Here you will find the suitable base adaptors.
- A detailed operating manual is available for download in the online shop next to the product.
- **Page 9**
Here you will find a detailed system overview.

SpinTools – Boring set

- ▲ suitable for Ø 86 – Ø 402 mm
- ▲ supplied with Ø 86 – Ø 302 mm
- ▲ with thro' coolant

Scope of supply:

- ▲ 1 Case
- ▲ 1 single point finish boring head
 - 62 305 302
- ▲ 3 insert holders
 - 62 438 138 Ø 86 – Ø 138 mm
 - 62 438 220 Ø 136 – Ø 220 mm
 - 62 438 302 Ø 188 – Ø 302 mm
- ▲ 2 pressure plates and 2 supports
 - 62 950 149
 - 62 950 150
 - 62 950 152
 - 62 950 153
- ▲ 1 Allen Key – SW5
- ▲ 1 Torx Key – T15



D _{min} - D _{max} mm	Adapter	STM Modular	
86 - 302	STM 36	EUR W4	3.326,00 999

SpinTools – Tool holder

- ▲ for single point finish boring heads
- ▲ Approach angle 90°

Scope of supply:

incl. cover plate and support

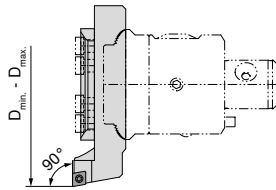

5

62 438 ...

D _{min} - D _{max} mm	Insert	EUR	
86 - 138	CC.. 09T3	W4	138
136 - 220	CC.. 09T3	526,00	220
188 - 302	CC.. 09T3	627,10	302
242 - 402	CC.. 09T3	786,90	402
		884,10	



TORX® Screws



Key D



Pressure plate



Support

Spare parts for Article no.	62 950 ...		80 950 ...		62 950 ...		62 950 ...	
	EUR		EUR		EUR		EUR	
62 438 138	W7		Y7		W7		W7	
62 438 220	5,04	023	11,96	113	91,96	152	68,19	149
62 438 302	5,04	023	11,96	113	103,90	153	76,92	150
62 438 402	5,04	023	11,96	113	103,90	153	76,92	150

→ Page 63
Find suitable indexable inserts here.

TwinKom – Base body

Scope of supply:

Clamping plate incl. adjustment and fixing screws
Order tool holder (+indexable insert) and indexable inserts separately

ABS

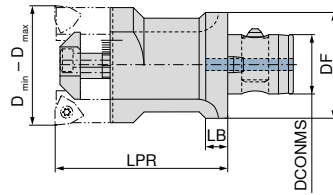

D _{min} - D _{max} mm	KOMET no.	DCONMS mm	DF mm	Adapter	LPR mm	LB mm	WT kg	long		short	
								EUR W4/6A	13289	EUR W4/6A	03290
24 - 32	G01 70552	13	25	ABS 25	45	6,0	0,11			472,90	03290
24 - 32	G01 71072	16	32	ABS 32	70	7,0	0,21	489,50	13289	472,90	04190
30 - 41	G01 70562	13	25	ABS 25	50		0,12			618,60	05389
30 - 41	G01 71132	16	32	ABS 32	85	7,5	0,30	489,50	14189		
39 - 53	G01 71022	16	32	ABS 32	60		0,29			632,90	15388
39 - 53	G01 71622	20	40	ABS 40	120	8,0	0,68	632,90	15388		
51 - 71	G01 71522	20	40	ABS 40	60		0,44			632,90	07188
51 - 71	G01 72122	28	50	ABS 50	135	10,0	1,24	659,30	17197		
64 - 91	G01 72022	28	50	ABS 50	70		0,82			684,60	09197
64 - 91	G01 72622	34	63	ABS 63	155	13,0	2,25	760,70	19196		
83 - 124	G01 72522	34	63	ABS 63	70		1,35			685,80	12496
83 - 124	G01 73122	46	80	ABS 80	155	16,5	3,80	779,40	12592		
109 - 167	G01 73032	46	80	ABS 80	90		3,10			992,20	16792 ¹⁾
109 - 167	G01 73042	46	80	ABS 80	175		6,20	1.107,00	16892 ¹⁾		
139 - 215	G01 73562	56	100	ABS 100	125		6,47			1.044,00	21591 ¹⁾
139 - 215	G01 73572	56	100	ABS 100	240		13,25	1.226,00	21691 ¹⁾		

1) Diameter range can only be achieved with TwinKom basic tool holder (radially + axially adjustable) and corresponding indexable insert!

Spare parts D _{min} - D _{max}		10 950 ...		62 950 ...		10 950 ...		
		EUR W7/6B	16500	EUR W7/6B	46900	EUR W7/6B	15800	
24 - 32	M2,5X5.SW1,3	0,85	16500	76,99	46900	M2x4,5 - T06	3,28	15800
30 - 41	M2,5X5.SW1,3	0,85	16500	86,77	47000	M2,5x5,3 - T08	3,05	15900
39 - 53	M4x8 - SW2	1,11	11100	85,67	47100	M2,5x7 - T08	3,05	16000
51 - 71	M4x10 - SW2	1,11	11200	90,01	47200	M3,5x9,4 - T10	3,05	16300
64 - 91	M6X12 SW3	1,13	16100	103,00	47300	M4,5x11,5 - T15	2,99	13500
83 - 124	M6X20 SW3	1,13	16200	105,20	47400	M5x12 - SW2,5	1,11	11000
109 - 167	M8X20.SW4	2,07	16600	132,30	47500			
139 - 215	M10X20 DIN 913	3,47	17500	149,70	47700	M6x20 Sw5	1,08	17600

Spare parts D _{min} - D _{max}		62 950 ...		62 950 ...		62 950 ...		
		EUR W7/6B	46000	EUR W7/6B	00000	EUR W7/6B	47800	
24 - 32	M3X16	0,81	46000			10,31	46200	
30 - 41	M4X20	1,13	45500			10,31	46300	
39 - 53	M5X25	1,13	45600			10,31	46400	
51 - 71	M6X30	1,13	45700			10,31	46500	
64 - 91	M8X35	1,13	45800			10,31	46600	
83 - 124	M8X45	1,23	45900			10,31	46700	
109 - 167	M10X50	2,07	46100	M5x16	1,13	00000	10,31	46800
139 - 215	M12x60	2,07	47600			11,60	47800	

A detailed operating manual is available for download in the online shop next to the product.

→ Page 10
Here you will find a detailed system overview.

TwinKom – Tool holder 90°

- ▲ radially adjustable
- ▲ Price per piece

Scope of supply:

including clamping screw
Order indexable inserts separately

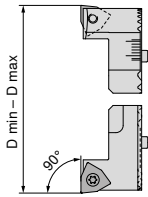

62 871 ...

D _{min} - D _{max} mm	KOMET no.	Insert	EUR W4/6A
24 - 32	G03 70330	WO.X 0403..	191,80 03200
30 - 41	G03 70141	WO.X 05T3..	191,80 04100
39 - 53	G03 70230	WO.X 05T3..	186,40 05300
51 - 71	G03 70240	WO.X 06T3..	195,80 07100
64 - 91	G03 70250	WO.X 0804..	207,80 09100
83 - 124	G03 70260	WO.X 1005..	225,20 12400

TwinKom – Tool holder 80°

- ▲ radially adjustable
- ▲ Price per piece

Scope of supply:

including clamping screw
Order indexable inserts separately

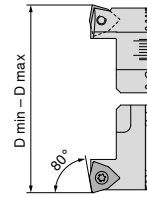

62 875 ...

D _{min} - D _{max} mm	KOMET no.	Insert	EUR W4/6A
24 - 32	G03 80310	WO.X 0403..	191,80 03200
30 - 41	G03 80021	WO.X 05T3..	191,80 04100
39 - 53	G03 80090	WO.X 05T3..	186,40 05300
51 - 71	G03 80100	WO.X 06T3..	195,80 07100
64 - 91	G03 80110	WO.X 0804..	207,80 09100
83 - 124	G03 80120	WO.X 1005..	225,20 12400



10 950 ...

Spare parts

D _{min} - D _{max}	EUR W7/6B
24 - 32	M2,2x5,5 - 06IP 2,99 10700
30 - 41	M2,5x7,2 - 08IP 2,99 10500
39 - 53	M2,5x7,2 - 08IP 2,99 10500
51 - 71	M3,5x7,3 - 10IP 2,99 10600
64 - 91	M4,5x9 - 15IP 2,66 12700
83 - 124	M4,5x9 - 15IP 2,66 12700

→ Page 60+61
Find suitable indexable inserts here.

Suitable ABS adapters can be found in → Catalogue – Clamping technology, Chapter 16, Adaptors and Accessories.

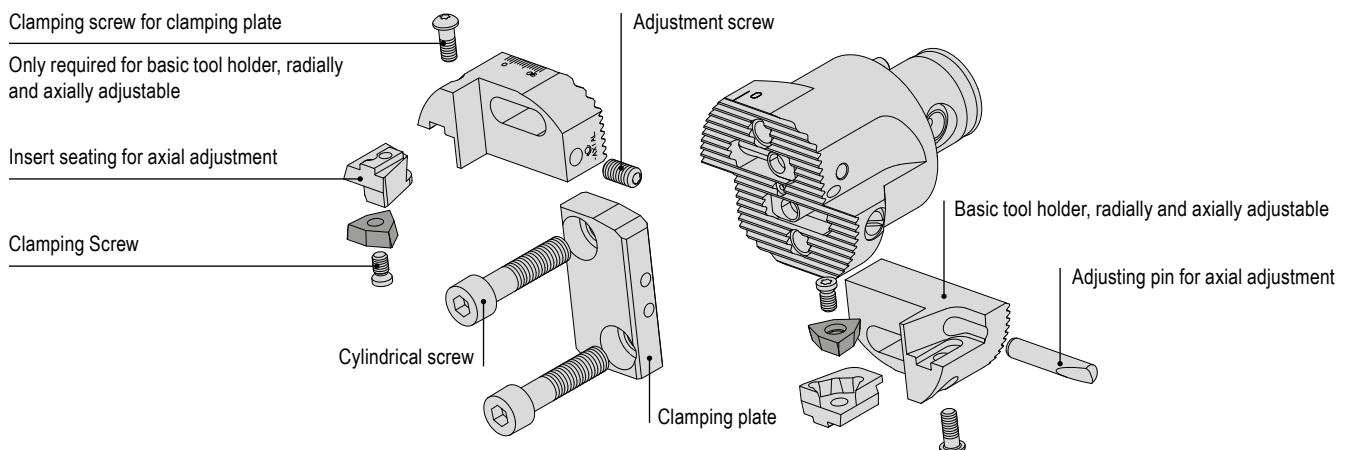

TwinKom – Basic tool holder, radially and axially adjustable

▲ Price per piece

Scope of supply:

Order indexable insert seats and indexable inserts separately

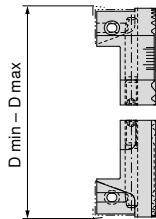

D _{min} - D _{max} mm	KOMET no.	62 872 ...
24 - 32	G03 70011	EUR 207,80 03200
30 - 41	G03 70021	EUR 207,80 04100
39 - 53	G03 70031	EUR 219,90 05300
51 - 71	G03 70041	EUR 226,70 07100
64 - 91	G03 70061	EUR 270,90 09100
83 - 124	G03 70071	EUR 332,50 12400
109 - 167	G03 70081	EUR 351,40 16700
139 - 215	G03 70091	EUR 496,10 21500

TwinKom – Indexable insert, 90°

▲ axially adjustable
▲ Price per piece

Scope of supply:

including clamping screw
Order indexable inserts separately

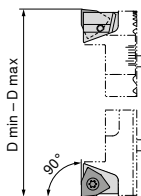

D _{min} - D _{max} mm	KOMET no.	Insert	62 873 ...
24 - 32	D54 60510	WO.X 0302..	EUR 132,20 03200
30 - 41	D54 60520	WO.X 0403..	EUR 150,20 04100
39 - 53	D54 60030	WO.X 05T3..	EUR 160,90 05300
51 - 71	D54 60040	WO.X 06T3..	EUR 174,40 07100
64 - 91	D54 60050	WO.X 0804..	EUR 179,80 09100
83 - 167	D54 60060	WO.X 1005..	EUR 198,40 12400
139 - 215	D54 60070	WO.X 1206..	EUR 223,90 21500

TwinKom – Indexable insert, 80°

▲ axially adjustable
▲ Price per piece

Scope of supply:

including clamping screw
Order indexable inserts separately

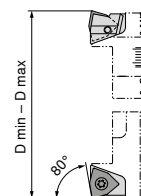

D _{min} - D _{max} mm	KOMET no.	Insert	62 874 ...
24 - 32	D54 60610	WO.X 0302..	EUR 132,20 03200
30 - 41	D54 60620	WO.X 0403..	EUR 150,20 04100
39 - 53	D54 60130	WO.X 05T3..	EUR 160,90 05300
51 - 71	D54 60140	WO.X 06T3..	EUR 174,40 07100
64 - 91	D54 60150	WO.X 0804..	EUR 179,80 09100
83 - 167	D54 60160	WO.X 1005..	EUR 198,40 16700
139 - 215	D54 60170	WO.X 1206..	EUR 223,90 21500

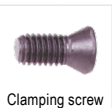

Clamping screw

Spare parts

D _{min} - D _{max}	10 950 ...
24 - 32	EUR 2,99 10000
30 - 41	EUR 2,99 10700
39 - 53	EUR 2,99 10800
51 - 71	EUR 3,05 16400
64 - 91	EUR 2,66 12700
83 - 167	EUR 2,66 12700
139 - 215	EUR 2,71 17400

SpinTools – Boring heads for roughing with 2 cutting edges

▲ with thro' coolant

Scope of supply:

Boring head incl. drive dog, fixing screws, spring rings, drive dog screw and stop pin

STM

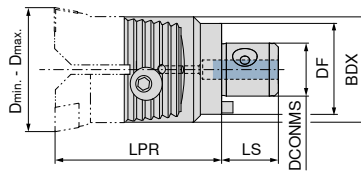

62 295 ...

D _{min} - D _{max} mm	Adapter	DCONMS mm	BDX mm	DF mm	LPR mm	LS mm	WT kg	EUR W4	
23,5 - 30,5	STM 11	11	20	20	40	13	0,05	347,10	030
29,5 - 40,1	STM 14	14	25	25	45	16	0,09	373,00	040
39,5 - 50,5	STM 18	18	32	32	65	20	0,25	403,10	050
49,5 - 66,5	STM 22	22	42	40	72	24	0,38	455,00	066
65,5 - 87,5	STM 28	28	55	50	82	30	0,59	532,90	087

5

Spare parts for Article no.

Article no.	Part	EUR W7	Part	EUR W7	Part	EUR W7
62 295 030	M4x8	2,95	298	Ø 4,3/7,3	0,89	311
62 295 040	M5x12	2,95	293	Ø 5,3/9,3	0,89	312
62 295 050	M6x16	2,95	294	Ø 6,4/10,2	0,89	313
62 295 066	M8x20	2,95	295	Ø 8,4/14,0	0,89	314
62 295 087	M10x25	3,30	296	Ø 10,5/17,0	0,89	315

Spare parts for Article no.

Article no.	Part	EUR W7	Part	EUR W7	
62 295 030	M2x2,5	0,89	162	5x8,5x3	27,07
62 295 040	M2,5x6	0,89	163	6x10,3x4	28,14
62 295 050	M3x8	1,22	164	8x15x5	30,19
62 295 066	M4x10	1,22	165	10x18,1x6	34,30
62 295 087	M5x10	1,55	166	12x20x6	40,31



→ Page 50–56

Here you will find the suitable base adaptors.



A detailed operating manual is available for download in the online shop next to the product.



→ Page 10

Here you will find a detailed system overview.

SpinTools – Pair of tool holders, standard, 90°

Scope of supply:

Adjustment screws, positioning pin, insert clamping screws

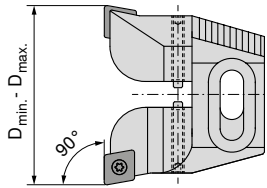

SpinTools – Pair of tool holders, standard, 70°

Scope of supply:

Adjustment screws, positioning pin, insert clamping screws

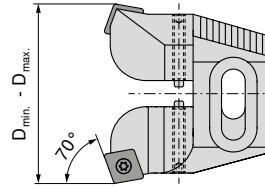

62 296 ...

D _{min} - D _{max} mm	Insert	EUR	
23,5 - 30,5	CC.. 0602	403,10	030
29,5 - 40,1	CC.. 0602	416,70	040
39,5 - 50,5	CC.. 09T3	446,70	050
49,5 - 66,5	CC.. 09T3	511,00	066
65,5 - 87,5	CN.. 1204	664,00	088
65,5 - 87,5	CC.. 1204	638,10	087

62 299 ...

D _{min} - D _{max} mm	Insert	EUR	
23,5 - 30,5	CC.. 0602	403,10	030
29,5 - 40,1	CC.. 0602	416,70	040
39,5 - 50,5	CC.. 09T3	446,70	050
49,5 - 66,5	CC.. 09T3	511,00	066
65,5 - 87,5	CN.. 1204	664,00	088
65,5 - 87,5	CC.. 1204	638,10	087

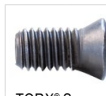

TORX® Screws

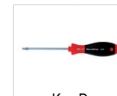

Key D

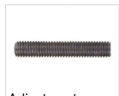

Adjustment screw

62 950 ...

80 950 ...

62 950 ...

Spare parts

D _{min} - D _{max}	Insert	EUR		EUR		EUR	
23,5 - 30,5	CC.. 0602	4,16	022	10,05	109	6,59	238
29,5 - 40,1	CC.. 0602	4,16	022	10,05	109	6,74	239
39,5 - 50,5	CC.. 09T3	5,04	023	11,96	113	7,13	240
49,5 - 66,5	CC.. 09T3	5,04	023	11,96	113	1,55	241
65,5 - 87,5	CC.. 1204	5,58	232	12,83	114	1,55	242



Shim

62 950 ...



Elbow lever screw

62 950 ...



Lever

62 950 ...



Carbide type C

62 950 ...

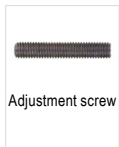

Adjustment screw

62 950 ...

Spare parts

D _{min} - D _{max}	Insert	EUR		EUR		
65,5 - 87,5	CN.. 1204	2,08	096	7,46	136	
				20,91	125	
				18,72	117	
					1,55	242



→ Page 63
Find suitable indexable inserts here.



A detailed operating manual is available for download in the online shop next to the product.

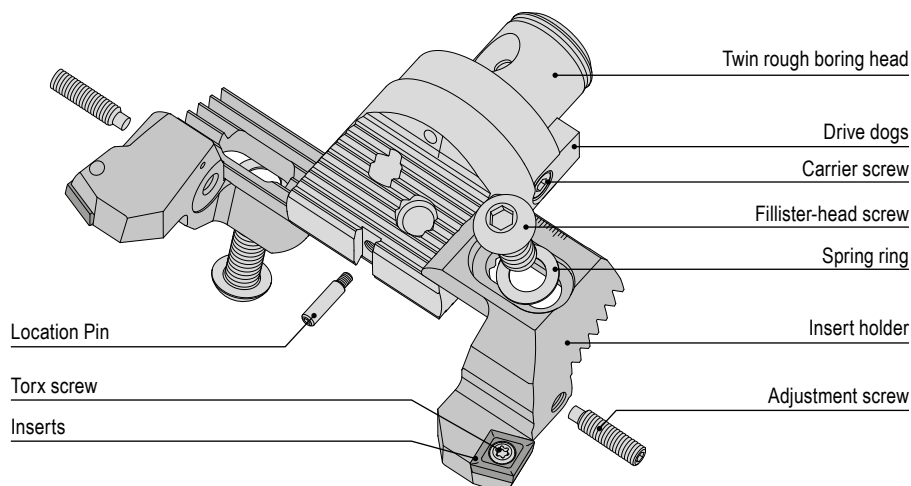

SpinTools – Pair of tool holders, 'Synchro', 90°

Scope of supply:

Insert clamping screws, synchronization screw

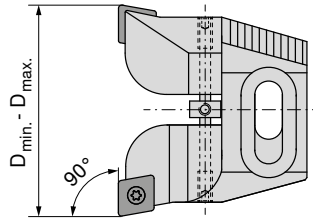

5

D _{min} - D _{max} mm	Insert
23,5 - 30,5	CC.. 0602
29,5 - 40,1	CC.. 0602
39,5 - 50,5	CC.. 09T3
49,5 - 66,5	CC.. 09T3
65,5 - 87,5	CC.. 1204

62 297 ...

EUR	
W4	
459,10	030
481,00	040
513,70	050
583,40	066
761,00	087

Spare parts for Article no.

Article no.	Screw	62 950 ...		62 950 ...		80 950 ...			
		EUR		EUR		EUR			
62 297 030	M2,5x6	4,16	022	M4x0,5x18	50,56	207	T07	10,05	109
62 297 040	M2,5x6	4,16	022	M4x0,5x23	51,38	208	T07	10,05	109
62 297 050	M4x9	5,04	023	M4x0,5x30	51,78	209	T15	11,96	113
62 297 066	M4x9	5,04	023	M6x40	53,29	210	T15	11,96	113
62 297 087	M5x10	5,58	232	M6x52	54,94	211	T20	12,83	114



TORX® Screws



Synchronization screw

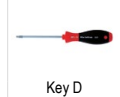

Key D

→ Page 63
Find suitable indexable inserts here.

A detailed operating manual is available for download in the online shop next to the product.

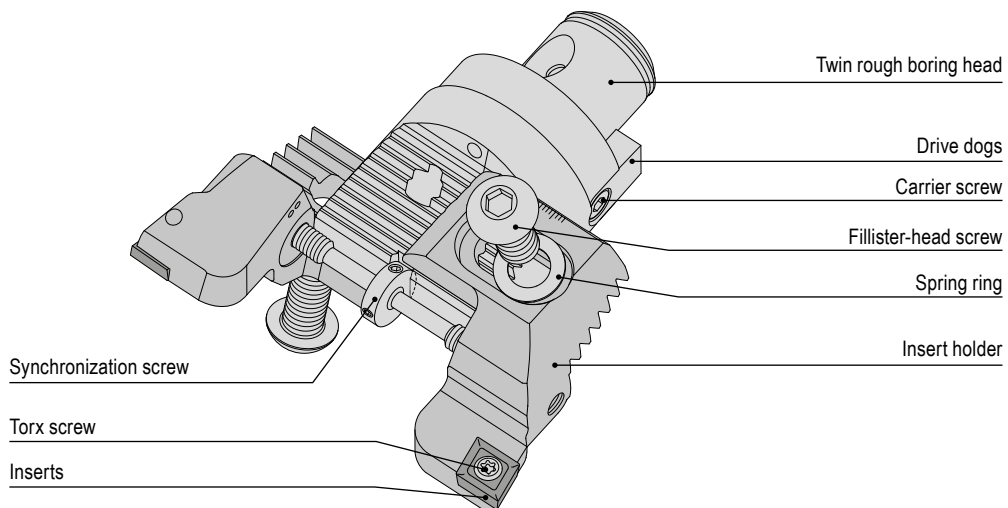

SpinTools – Base adapters ISO 7388-1 (DIN 69871)

STM

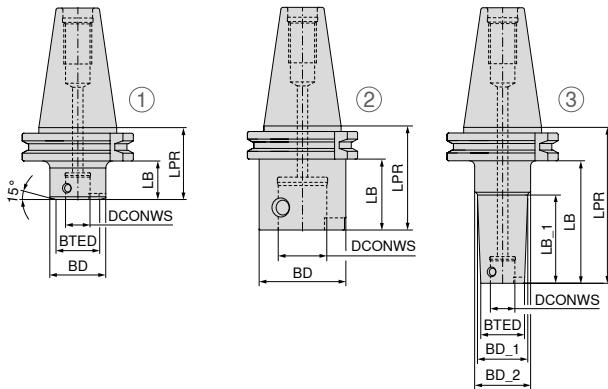

62 107 ...

	Adapter	Fig.	SZID	DCONWS	BTED	BD	BD_1	BD_2	LPR	LB	LB_1	WT	62 107 ...	
													mm	mm
short	SK 40	1	STM 11	11	20	32			40	20,9		0,91	359,40	111 ¹⁾
	SK 40	1	STM 14	14	25	32			40	20,9		0,93	359,40	114 ¹⁾
	SK 40	2	STM 18	18		32			40	20,9		0,89	359,40	118
	SK 40	2	STM 22	22		40			50	30,9		1,02	359,40	122
	SK 40	2	STM 28	28		50			50	30,9		1,11	359,40	128
	SK 40	2	STM 36	36		63			60	40,9		1,27	332,00	136
	SK 50	2	STM 28	28		50			50	30,9		2,92	425,00	428
	SK 50	2	STM 36	36		63			63	43,9		3,27	425,00	436
long	SK 40	3	STM 11	11	20		23	32	80	60,9	40,9	1,04	403,10	211 ¹⁾
	SK 40	3	STM 14	14	25		28	32	80	60,9	40,9	1,07	403,10	214 ¹⁾
	SK 40	2	STM 18	18		32			80	60,9		1,13	403,10	218
	SK 40	2	STM 22	22		40			100	80,9		1,47	403,10	222
	SK 40	2	STM 28	28		50			100	80,9		1,84	403,10	228
	SK 40	2	STM 36	36		63			120	100,9		2,68	403,10	236
	SK 50	2	STM 36	36		63			120	100,9		4,60	481,00	536

1) Note! BD/BD_1 is larger than BTED, which may lead to a limited bore depth!



O-Ring



Clamping screw
ST

Spare parts
DCONWS

DCONWS	9x1,5	12x1,5	16x1,5	19x2	25x2	33x2	M4x0,5x6	M5x0,5x7,5	M6x0,75x9,5	M8x0,75x12	M10x1x14,2	M12x1x18
11							9,53	026				
14							9,72	027				
18							10,40	028				
22							11,63	029				
28							13,34	030				
36							17,08	031				

i Suitable pull studs can be found in → Clamping technology catalogue, Chapter 16, Adapters and accessories.

i ABS base adapters can be found in → Clamping technology catalogue, Chapter 16, Adapters and accessories.

SpinTools – Base adapters ISO 7388-2 (JIS B 6339 / MAS-BT)

▲ form B available upon request

STM

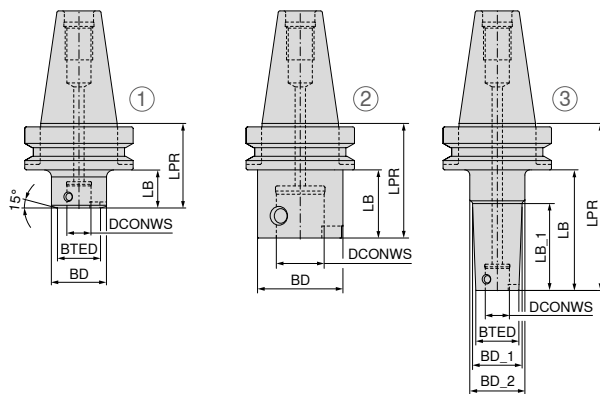

5

	Adapter	Fig.	SZID	DCONWS	BTED	BD	BD_1	BD_2	LPR	LB	LB_1	WT	62 112 ...	
													mm	mm
short	BT 30	2	STM 28	28		50			55			0,64	367,60	328
	BT 40	1	STM 11	11	20	32			50	23		1,09	359,40	111 ¹⁾
	BT 40	1	STM 14	14	25	32			50	23		1,08	359,40	114 ¹⁾
	BT 40	2	STM 18	18		32			50	23		1,06	359,40	118
	BT 40	2	STM 22	22		40			50	23		1,10	359,40	122
	BT 40	2	STM 28	28		50			50	23		1,14	359,40	128
	BT 40	2	STM 36	36		63			60	33		1,38	332,00	136
long	BT 50	2	STM 28	28		50			63	25		3,75	425,00	428
	BT 50	2	STM 36	36		63			63	25		3,78	425,00	436
	BT 40	3	STM 11	11	20		23	32	90	63	43	1,20	403,10	211 ¹⁾
	BT 40	3	STM 14	14	25		28	32	90	63	43	1,24	403,10	214 ¹⁾
	BT 40	2	STM 18	18		32			90	63		1,30	403,10	218
	BT 40	2	STM 22	22		40			100	73		1,57	403,10	222
	BT 40	2	STM 28	28		50			100	73		1,87	403,10	228
	BT 40	2	STM 36	36		63			120	93		2,78	403,10	236
	BT 50	2	STM 36	36		63			120	82		5,18	481,00	536

1) Note! BD/BD_1 is larger than BTED, which may lead to a limited bore depth!

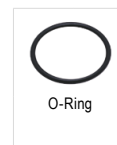

O-Ring



Clamping screw
ST

Spare parts
DCONWS

		62 950 ...		62 950 ...	
		EUR	W7	EUR	W7
11	9x1,5	2,08	254	M4x0,5x6	9,53 026
14	12x1,5	2,08	255	M5x0,5x7,5	9,72 027
18	16x1,5	2,08	256	M6x0,75x9,5	10,40 028
22	19x2	2,08	257	M8x0,75x12	11,63 029
28	25x2	2,08	258	M10x1x14,2	13,34 030
36	33x2	2,08	259	M12x1x18	17,08 031



Suitable pull studs can be found in → **Clamping technology catalogue, Chapter 16, Adapters and accessories.**



ABS base adapters can be found in → **Clamping technology catalogue, Chapter 16, Adapters and accessories.**

SpinTools – Base adapters HSK-A ISO 12164-1 (DIN 69893-1)

STM

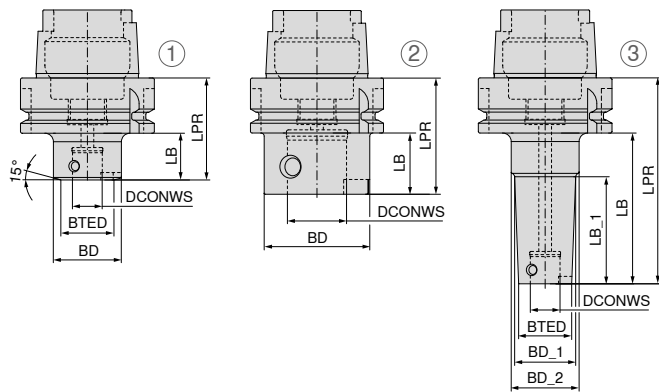

62 122 ...
EUR W4

	Adapter	Fig.	SZID	DCONWS	BTED	BD	BD_1	BD_2	LPR	LB	LB_1	WT		
				mm	mm	mm	mm	mm	mm	mm	mm	kg	EUR	
short	HSK-A 63	1	STM 11	11	20	32			50	24		0,77	425,00	111 ¹⁾
	HSK-A 63	1	STM 14	14	25	32			50	24		0,76	425,00	114 ¹⁾
	HSK-A 63	2	STM 18	18		32			50	24		0,74	425,00	118
	HSK-A 63	2	STM 22	22		40			50	24		0,79	425,00	122
	HSK-A 63	2	STM 28	28		50			55	24		0,91	425,00	128
	HSK-A 63	2	STM 36	36		63			65	34		1,10	385,40	136
	HSK-A 100	2	STM 28	28		50			63	34		2,32	493,30	428
	HSK-A 100	2	STM 36	36		63			70	34		2,61	493,30	436
long	HSK-A 63	3	STM 11	11	20		23	32	90	64	44	0,87	465,90	211 ¹⁾
	HSK-A 63	3	STM 14	14	25		28	32	90	64	44	0,93	465,90	214 ¹⁾
	HSK-A 63	2	STM 18	18		32			90	64		0,98	465,90	218
	HSK-A 63	2	STM 22	22		40			100	74		1,26	465,90	222
	HSK-A 63	2	STM 28	28		50			100	74		1,58	465,90	228
	HSK-A 63	2	STM 36	36		63			120	94		2,41	493,30	236

1) Note! BD/BD_1 is larger than BTED, which may lead to a limited bore depth!



O-Ring



Clamping screw
ST

Spare parts	DCONWS	62 950 ...			62 950 ...		
			EUR W7		EUR W7		
	11	9x1,5	2,08 254	M4x0,5x6	9,53	026	
	14	12x1,5	2,08 255	M5x0,5x7,5	9,72	027	
	18	16x1,5	2,08 256	M6x0,75x9,5	10,40	028	
	22	19x2	2,08 257	M8x0,75x12	11,63	029	
	28	25x2	2,08 258	M10x1x14,2	13,34	030	
	36	33x2	2,08 259	M12x1x18	17,08	031	

1 ABS base adapters can be found in → Clamping technology catalogue, Chapter 16, Adapters and accessories.

SpinTools – Reductions

▲ with thro' coolant

STM

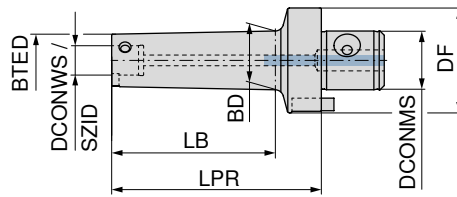





62 357 ...

Adapter	LPR	SZID	DCONMS	DCONWS	DF	BTED	BD	LB	WT	EUR	
	mm		mm	mm	mm	mm	mm	mm	kg	W4	
STM 14	30	STM 11	14	11	25	20	23	15	0,04	198,20	111
STM 18	30	STM 11	18	11	32	20	23	17	0,14	198,20	211
STM 18	30	STM 14	18	14	32	25	28	17	0,16	198,20	214
STM 22	30	STM 11	22	11	40	20	23	15	0,21	203,50	311
STM 22	30	STM 14	22	14	40	25	28	15	0,22	203,50	314
STM 22	30	STM 18	22	18	40	32	37	15	0,25	203,50	318
STM 28	40	STM 11	28	11	50	20	23	20	0,44	213,30	411
STM 28	40	STM 14	28	14	50	25	28	20	0,49	213,30	414
STM 28	40	STM 18	28	18	50	32	37	20	0,45	213,30	418
STM 28	40	STM 22	28	22	50	40	46	20	0,55	213,30	422
STM 36	40	STM 11	36	11	63	20	22	16	0,82	228,20	511
STM 36	70	STM 11	36	11	63	20	23	42	0,90	245,80	811
STM 36	95	STM 11	36	11	63	20	23	71	0,98	266,50	611
STM 36	115	STM 11	36	11	63	20	23	87	1,02	293,80	911
STM 36	135	STM 11	36	11	63	20	23	111	1,08	319,70	711
STM 36	40	STM 14	36	14	63	25	27	16	0,84	228,20	514
STM 36	80	STM 14	36	14	63	25	28	52	1,00	259,50	814
STM 36	120	STM 14	36	14	63	25	28	96	1,16	292,40	614
STM 36	145	STM 14	36	14	63	25	28	117	1,27	319,70	914
STM 36	170	STM 14	36	14	63	25	28	146	1,38	347,10	714
STM 36	40	STM 18	36	18	63	32	37	16	0,85	228,20	518
STM 36	100	STM 18	36	18	63	32	38	74	1,24	275,90	818
STM 36	150	STM 18	36	18	63	32	38	126	1,66	306,10	918
STM 36	207	STM 18	36	18	63	32	38	183	2,07	403,10	618
STM 36	40	STM 22	36	22	63	40	46	16	0,89	228,20	522
STM 36	120	STM 22	36	22	63	40	48	95	1,76	299,30	822
STM 36	183	STM 22	36	22	63	40	48	159	2,52	373,00	622
STM 36	263	STM 22	36	22	63	40	48	239	3,44	532,90	722
STM 36	40	STM 28	36	28	63	50	58	21	1,03	228,20	528
STM 36	140	STM 28	36	28	63	50	60	117	2,70	312,90	828
STM 36	233	STM 28	36	28	63	50	60	209	4,41	507,00	628
STM 36	333	STM 28	36	28	63	50	60	309	6,25	694,20	728

ABS reductions can be found in → **Clamping technology catalogue, Chapter 16, Adapters and accessories.**

Reductions – Spare Parts

		 O-Ring		 Screw for drivers		 Driver		 Clamping screw ST				
		62 950 ...		62 950 ...		62 950 ...		62 950 ...				
Spare parts for Article no.		EUR W7		EUR W7		EUR W7		EUR W7				
62 357 111	9x1,5	2,08	254	M2,5x6	0,89	163	6x10,3x4	28,14	036	M4x0,5x6	9,53	026
62 357 211	9x1,5	2,08	254	M3x8	1,22	164	8x15x5	30,19	037	M4x0,5x6	9,53	026
62 357 214	12x1,5	2,08	255	M3x8	1,22	164	8x15x5	30,19	037	M5x0,5x7,5	9,72	027
62 357 311	9x1,5	2,08	254	M4x10	1,22	165	10x18,1x6	34,30	038	M4x0,5x6	9,53	026
62 357 314	12x1,5	2,08	255	M4x10	1,22	165	10x18,1x6	34,30	038	M5x0,5x7,5	9,72	027
62 357 318	16x1,5	2,08	256	M4x10	1,22	165	10x18,1x6	34,30	038	M6x0,75x9,5	10,40	028
62 357 411	9x1,5	2,08	254	M5x10	1,55	166	12x20x6	40,31	039	M4x0,5x6	9,53	026
62 357 414	12x1,5	2,08	255	M5x10	1,55	166	12x20x6	40,31	039	M5x0,5x7,5	9,72	027
62 357 418	16x1,5	2,08	256	M5x10	1,55	166	12x20x6	40,31	039	M6x0,75x9,5	10,40	028
62 357 422	19x2	2,08	257	M5x10	1,55	166	12x20x6	40,31	039	M8x0,75x12	11,63	029
62 357 511	9x1,5	2,08	254	M6x12	1,55	167	16x26,5x8	51,09	040	M4x0,5x6	9,53	026
62 357 811	9x1,5	2,08	254	M6x12	1,55	167	16x26,5x8	51,09	040	M4x0,5x6	9,53	026
62 357 611	9x1,5	2,08	254	M6x12	1,55	167	16x26,5x8	51,09	040	M4x0,5x6	9,53	026
62 357 911	9x1,5	2,08	254	M6x12	1,55	167	16x26,5x8	51,09	040	M4x0,5x6	9,53	026
62 357 711	9x1,5	2,08	254	M6x12	1,55	167	16x26,5x8	51,09	040	M4x0,5x6	9,53	026
62 357 514	12x1,5	2,08	255	M6x12	1,55	167	16x26,5x8	51,09	040	M5x0,5x7,5	9,72	027
62 357 814	12x1,5	2,08	255	M6x12	1,55	167	16x26,5x8	51,09	040	M5x0,5x7,5	9,72	027
62 357 614	12x1,5	2,08	255	M6x12	1,55	167	16x26,5x8	51,09	040	M5x0,5x7,5	9,72	027
62 357 914	12x1,5	2,08	255	M6x12	1,55	167	16x26,5x8	51,09	040	M5x0,5x7,5	9,72	027
62 357 714	12x1,5	2,08	255	M6x12	1,55	167	16x26,5x8	51,09	040	M5x0,5x7,5	9,72	027
62 357 518	16x1,5	2,08	256	M6x12	1,55	167	16x26,5x8	51,09	040	M6x0,75x9,5	10,40	028
62 357 818	16x1,5	2,08	256	M6x12	1,55	167	16x26,5x8	51,09	040	M6x0,75x9,5	10,40	028
62 357 918	16x1,5	2,08	256	M6x12	1,55	167	16x26,5x8	51,09	040	M6x0,75x9,5	10,40	028
62 357 618	16x1,5	2,08	256	M6x12	1,55	167	16x26,5x8	51,09	040	M6x0,75x9,5	10,40	028
62 357 522	19x2	2,08	257	M6x12	1,55	167	16x26,5x8	51,09	040	M8x0,75x12	11,63	029
62 357 822	19x2	2,08	257	M6x12	1,55	167	16x26,5x8	51,09	040	M8x0,75x12	11,63	029
62 357 622	19x2	2,08	257	M6x12	1,55	167	16x26,5x8	51,09	040	M8x0,75x12	11,63	029
62 357 722	19x2	2,08	257	M6x12	1,55	167	16x26,5x8	51,09	040	M8x0,75x12	11,63	029
62 357 528	25x2	2,08	258	M6x12	1,55	167	16x26,5x8	51,09	040	M10x1x14,2	13,34	030
62 357 828	25x2	2,08	258	M6x12	1,55	167	16x26,5x8	51,09	040	M10x1x14,2	13,34	030
62 357 628	25x2	2,08	258	M6x12	1,55	167	16x26,5x8	51,09	040	M10x1x14,2	13,34	030
62 357 728	25x2	2,08	258	M6x12	1,55	167	16x26,5x8	51,09	040	M10x1x14,2	13,34	030

SpinTools – Extensions

▲ with thro' coolant

STM

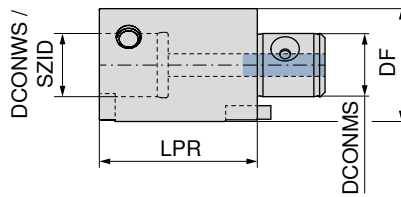

62 351 ...

Adapter	LPR mm	SZID	DCONWS mm	DF mm	DCONMS mm	WT kg	EUR W4	
STM 11	25	STM 11	11	20	11	0,06	187,30	111
STM 11	35	STM 11	11	20	11	0,09	187,30	211
STM 14	30	STM 14	14	25	14	0,11	187,30	114
STM 14	45	STM 14	14	25	14	0,17	187,30	214
STM 18	40	STM 18	18	32	18	0,23	199,50	118
STM 18	60	STM 18	18	32	18	0,35	199,50	218
STM 22	50	STM 22	22	40	22	0,45	213,30	122
STM 22	80	STM 22	22	40	22	0,73	213,30	222
STM 28	50	STM 28	28	50	28	0,71	213,30	128
STM 28	75	STM 28	28	50	28	1,07	228,20	228
STM 28	100	STM 28	28	50	28	1,44	240,50	328
STM 36	60	STM 36	36	63	36	1,33	228,20	136
STM 36	90	STM 36	36	63	36	2,02	252,70	236
STM 36	120	STM 36	36	63	36	2,72	281,50	336

5

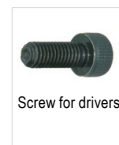

Spare parts DCONWS	62 950 ...		62 950 ...		62 950 ...		62 950 ...	
	EUR W7		EUR W7		EUR W7		EUR W7	
11	9x1,5	2,08 254	M2x2,5	0,89 162	5x8,5x3	27,07 035	M4x0,5x6	9,53 026
14	12x1,5	2,08 255	M2,5x6	0,89 163	6x10,3x4	28,14 036	M5x0,5x7,5	9,72 027
18	16x1,5	2,08 256	M3x8	1,22 164	8x15x5	30,19 037	M6x0,75x9,5	10,40 028
22	19x2	2,08 257	M4x10	1,22 165	10x18,1x6	34,30 038	M8x0,75x12	11,63 029
28	25x2	2,08 258	M5x10	1,55 166	12x20x6	40,31 039	M10x1x14,2	13,34 030
36	33x2	2,08 259	M6x12	1,55 167	16x26,5x8	51,09 040	M12x1x18	17,08 031

ABS extensions can be found in → Clamping technology catalogue, Chapter 16, Adapters and accessories.

SpinTools – ABS/STM adapters

- ▲ using this adapter, ABS core drilling and precision spindle systems can be accommodated reliably and precisely in STM base adapters
- ▲ with thro' coolant supply

STM

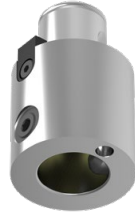
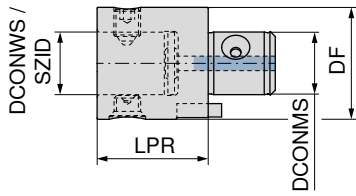

NEW

62 359 ...

Adapter	LPR mm	SZID	DCONWS mm	DF mm	DCONMS mm	EUR W4/6A
STM 14	35	ABS 25	13	25	14	279,10 02519
STM 18	40	ABS 32	16	32	18	280,90 03218
STM 22	45	ABS 40	20	40	22	321,60 04017
STM 28	50	ABS 50	28	50	28	349,00 05016
STM 36	60	ABS 63	34	63	36	379,10 06315

MicroKom – STM/ABS adapters

- ▲ using this adapter, STM core drilling and precision spindle systems can be accommodated reliably and precisely in ABS base adapters
- ▲ with thro' coolant supply

ABS

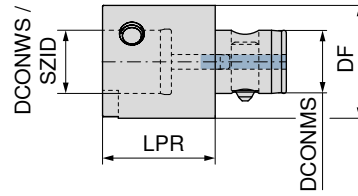

NEW

62 359 ...

Adapter	LPR mm	SZID	DCONWS mm	DF mm	DCONMS mm	EUR W4/6A
ABS 25	30	STM 14	14	25	13	279,10 02590
ABS 32	40	STM 18	18	32	16	280,90 03289
ABS 40	40	STM 22	22	40	20	321,60 04088
ABS 50	50	STM 28	28	50	28	349,00 05097
ABS 63	60	STM 36	36	63	34	379,10 06396



62 950 ...

62 950 ...

Spare parts DCONWS	EUR XX	EUR W7
13		28,14 036
16	12,08 13989	30,19 037
20		34,30 038
28		40,31 039
34		51,09 040



62 950 ...

Spare parts DCONWS	EUR W7
14	9,72 027
18	10,40 028
22	11,63 029
28	13,34 030
36	17,08 031

WOHX

Designation	L mm	S mm	D1 mm	IC mm
WOHX 02T0..	2,6	1,20	2	4

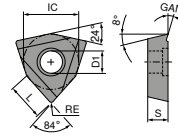

WOHX

-G12 BK2710	-G12 BK8440	-G12 K10
F WOHX	F WOHX	F WOHX
62 600 ...	62 600 ...	62 600 ...
EUR 1A/3#	EUR 1A/3#	EUR 1A/3#
32,80 10102	32,80 00102	26,95 20102

ISO	KOMET no.	RE mm
02T001EL	W00 04120.018440	0,1
02T001EL	W00 04120.012710	0,1
02T001FL	W00 04120.0121	0,1

P	•	•	
M	•	•	
K	•	•	
N			•
S	•		•
H		•	
O			•

→ v_c Page 65

Material group	Guideline recommendation	
	Grade	Chip groove
P	BK8440	-G12
M	BK8440	-G12
K	BK2710	-G12
N	K10	-G12
S	K10	-G12
H1.1	BK8440	-G12
O	K10	-G12

The guideline recommendation shown here is based on experience and serves only to make it easy to find the correct indexable insert for your application.

Additional indexable inserts can be found in our online shop at cuttingtools.ceratizit.com

TOGX

Designation	L mm	S mm	D1 mm	IC mm
TOGX 06T1..	6,64	1,80	2,2	4,0
TOGX 0902..	9,12	2,50	2,8	5,6
TOGX 1403..	13,62	3,00	3,8	8,2

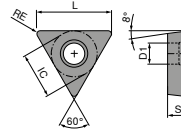

TOGX

ISO	KOMET no.	RE mm	-18 CK32		-14 CK3230		-14 BK60		-14 BK8430		-12 BK7710		-12 K10	
			62 607 ...	62 606 ...	62 601 ...	62 601 ...	62 601 ...	62 601 ...	62 601 ...	62 601 ...				
			EUR 1A/3#	EUR 1A/3#	EUR 1A/3#	EUR 1A/3#	EUR 1A/3#	EUR 1A/3#	EUR 1A/3#	EUR 1A/3#	EUR 1A/3#	EUR 1A/3#	EUR 1A/3#	EUR 1A/3#
06T102EN	W57 04140.0260	0,2			25,38 90206		25,28 30201							
06T102EN	W57 04140.028430	0,2												
06T102EN	W57 04140.023230	0,2		25,28 10201										
06T102EN	W57 04180.0432	0,4	25,28 20401											
06T102FN	W57 04120.027710	0,2								33,09 70201				
06T102FN	W57 04120.0223	0,2											25,38 50206	
090202EN	W57 14140.028430	0,2						27,75 33801						
090204EN	W57 14140.0460	0,4			27,80 70409									
090204EN	W57 14140.043230	0,4		27,75 11401										
090204EN	W57 14180.0432	0,4	27,75 21401											
090204FN	W57 14120.047710	0,4								35,96 70401				
090204FN	W57 14120.0423	0,4											27,80 50409	
140302EN	W57 26140.028430	0,2						39,23 34401						
140304EN	W57 26140.0460	0,4			39,27 70414									
140304EN	W57 26140.043230	0,4		39,23 12601										
140304EN	W57 26180.0432	0,4	39,23 22601											
140304FN	W57 26120.047710	0,4								55,37 71401				
140304FN	W57 26120.0423	0,4											45,03 50414	
P			●	●	●	○								
M			●	●	●	○								
K					●	○								
N										●			●	
S								●		○			●	
H								●		○				
O										○			●	

→ v_c Page 65

TOGX / TOEX / TOHX

Designation	L mm	S mm	D1 mm	IC mm	LE mm
TO.X 06T1..	6,64	1,80	2,2	4,0	1,8
TO.X 0902..	9,12	2,50	2,8	5,6	2,7
TO.X 1403..	13,62	3,00	3,8	8,2	2,7
TOHX 06T1..	6,50	1,80	2,2	4,0	1,0
TOHX 0902..	9,12	2,50	2,8	5,6	2,5
TOHX 1403..	13,62	3,00	3,8	8,2	4,5

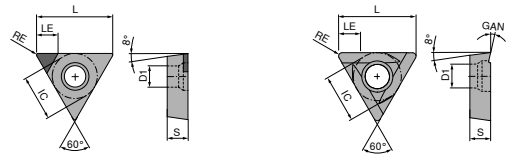

TOGX / TOEX / TOHX

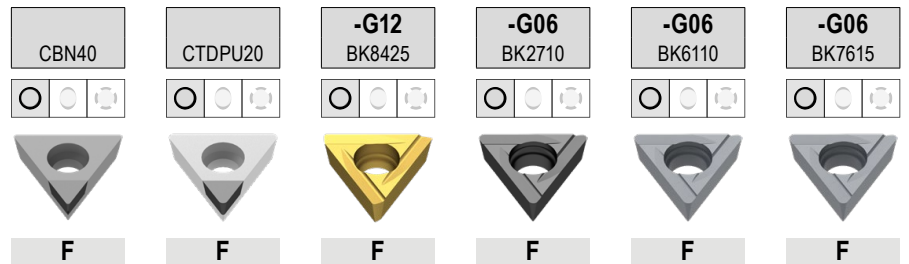

ISO	KOMET no.	RE mm	TOGX		DIAMOND TOEX		TOHX		TOHX		TOHX		TOHX	
			62 601 ...	62 601 ...	62 605 ...	62 605 ...	62 603 ...	62 603 ...	62 602 ...	62 602 ...	62 602 ...	62 602 ...	62 602 ...	62 602 ...
			EUR Y0	EUR Y0	EUR Y0	EUR Y0	EUR 1A/3#	EUR 1A/3#	EUR 1A/3#	EUR 1A/3#	EUR 1A/3#	EUR 1A/3#	EUR 1A/3#	
06T102FN	W30 04990.025510	0,2												
06T102TN	W30 04990.0240	0,2	77,47											
06T103EL	W30 04120.038425	0,3					24,90							
06T103EL	W30 04060.037615	0,3											30,90	
06T103EL	W30 04060.036110	0,3								27,80				
06T103EL	W30 04060.032710	0,3						26,21						
090204EL	W30 14120.048425	0,4					28,15							
090204EL	W30 14060.047615	0,4												
090204EL	W30 14060.046110	0,4								30,90				
090204EL	W30 14060.042710	0,4							29,64					
090204FN	W30 14990.045510	0,4			87,43									
090204TN	W30 14990.0440	0,4	85,96											
140304EL	W30 26120.048425	0,4					31,73							
140304EL	W30 26060.047615	0,4											37,58	
140304EL	W30 26060.046110	0,4								34,34				
140304EL	W30 26060.042710	0,4							33,36					
140304FN	W30 26990.045510	0,4			93,02									
140304TN	W30 26990.0440	0,4	93,02											
P							•	•	•					
M							•	•	•					
K							•	•	•				•	
N						•	○							
S							•	•						
H						•	○			•				
O							•							

→ v_c Page 65

Material group	Guideline recommendation	
	Grade	Chip groove
P	BK60	-14
M	BK2710	-G06
K	BK7615	-G06
N	BK7710	-12
S1.1 – S2.3	BK2710	-G06
S3.1 – S3.3	BK7710	-12
H	CBN40	
O	BK7710	-12

The guideline recommendation shown here is based on experience and serves only to make it easy to find the correct indexable insert for your application.

Additional indexable inserts can be found in our online shop at cuttingtools.ceratzit.com

WOEX / WOGX

Designation	L mm	S mm	D1 mm	IC mm
WO.X 0302..	3,2	2,30	2,30	5,00
WO.X 0403..	4,1	3,18	2,55	6,35
WO.X 05T3..	5,3	3,80	2,85	8,00
WO.X 06T3..	6,6	3,80	4,05	10,00
WO.X 0804..	7,9	4,80	4,90	12,00
WOEX 1005..	9,9	5,30	4,90	15,00
WOEX 1206..	11,6	6,00	5,95	17,60

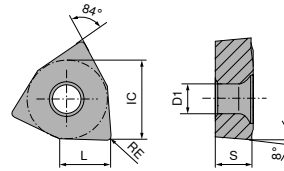

WOEX

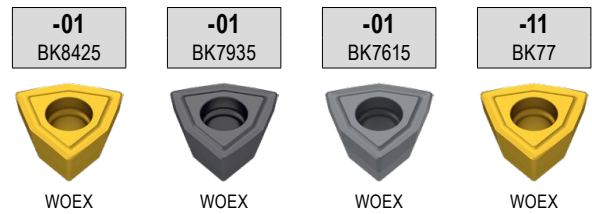

ISO	KOMET no.	RE mm	10 821 ...			
			EUR 1A/3#	EUR 1A/3#	EUR 1A/3#	EUR 1A/3#
030204	W29 10010.047935	0,4		15,75 50301		15,51 80311
030204	W29 10110.0477	0,4			24,90 05301	
030204	W29 10010.047615	0,4				
030204	W29 10010.048425	0,4	14,91 30301			
040304	W29 18010.047935	0,4		16,72 50401		
040304	W29 18110.0477	0,4				16,32 80411
040304	W29 18010.047615	0,4			25,01 05401	
040304	W29 18010.048425	0,4	15,84 30401			
05T304	W29 24010.047935	0,4		16,94 50501		
05T304	W29 24110.0477	0,4				16,47 80511
05T304	W29 24010.047615	0,4			26,10 05501	
05T304	W29 24010.048425	0,4	16,28 30501			
06T304	W29 34010.047935	0,4		19,25 50601		
06T304	W29 34110.0477	0,4				18,46 80611
06T304	W29 34010.047615	0,4			28,02 05601	
06T304	W29 34010.048425	0,4	18,19 30601			
080404	W29 42010.047935	0,4		24,26 50801		
080404	W29 42110.0477	0,4				23,65 80811
080404	W29 42010.047615	0,4			34,17 05801	
080404	W29 42010.048425	0,4	22,95 30801			
100504	W29 50010.047935	0,4		33,02 51001		
100504	W29 50110.0477	0,4				32,67 81011
100504	W29 50010.047615	0,4			38,15 06001	
100504	W29 50010.048425	0,4	31,31 31001			
120608	W29 58010.087935	0,8		38,42 53201		
120608	W29 58010.087615	0,8			47,03 08201	
120608	W29 58010.088425	0,8	36,35 31201			
P			●	●		
M			●	●		
K			●	●	●	
N			○	○		
S			●	●		●
H			○			○
O						○

→ v. Page 65

WOEX / WOGX

ISO	KOMET no.	RE mm	-01 BK6115		-02 BK6440		-15 BK8430		-11 BK7710	
			WOEX 10 821 ...	EUR 1A/3#	WOEX 10 821 ...	EUR 1A/3#	WOGX 10 821 ...	EUR 1A/3#	WOGX 10 821 ...	EUR 1A/3#
030204	W29 10150.048430	0,4								
030204	W29 10110.047710	0,4								
030204	W29 10010.046115	0,4		21,58	40301					
040304	W29 18150.048430	0,4								16,28 90311
040304	W29 18110.047710	0,4								
040304	W29 18010.046115	0,4		21,75	40401					17,22 90411
05T304	W29 24020.046440	0,4								
05T304	W29 24110.047710	0,4				21,75	25502			
05T304	W29 24150.048430	0,4								17,37 90511
05T304	W29 24010.046115	0,4		22,17	40501					
06T304	W29 34020.046440	0,4								
06T304	W29 34110.047710	0,4				24,05	25602			
06T304	W29 34150.048430	0,4								19,54 90611
06T304	W29 34010.046115	0,4		23,23	40601					
080404	W29 42020.046440	0,4								
080404	W29 42110.047710	0,4				29,95	25802			
080404	W29 42150.048430	0,4								24,90 90811
080404	W29 42010.046115	0,4		28,70	40801					
100504	W29 50020.046440	0,4								
100504	W29 50110.047710	0,4				33,76	26002			
100504	W29 50010.046115	0,4		33,89	41001					34,17 91011
120608	W29 58020.086440	0,8								
120608	W29 58010.086115	0,8		42,50	41201					
P			●			●			○	
M			●			●			○	
K			●						○	
N										●
S									●	○
H					○				●	○
O										○

→ v_c Page 65

Material group	Guideline recommendation	
	Grade / chip breaker	
P	BK8425 / -01	
M	BK7935 / -01	
K	BK7615 / -01	
N	BK7710 / -11	
S1.1 – S2.3	BK7935 / -01	
S3.1 – S3.3	BK7710 / -11	
O	BK7710 / -11	

Material group	Maximum feed values						
	WO.X 0302	WO.X 0403	WO.X 05T3	WO.X 06T3	WO.X 0804	WO.X 1005	WO.X 1206
a_p max.							
P	1,5	2,5	4,5	6,0	7,5	9,0	9,0
M	1,0	1,5	3,5	4,0	6,0	9,0	9,0
K	1,5	3,0	5,0	6,0	7,5	9,0	9,0
N	2,0	3,0	5,0	6,0	7,5	9,0	9,0
S	1,0	1,5	3,5	4,0	6,0	9,0	9,0
O	1,0	1,5	3,5	4,0	7,5	9,0	9,0

The guideline recommendation shown here is based on experience and serves only to make it easy to find the correct indexable insert for your application.

 Additional indexable inserts can be found in our online shop at cuttingtools.ceratizit.com

WCMT / WCGT

Designation	L mm	S mm	D1 mm	IC mm
WC.T 0201..	2,71	1,59	2,1	3,97

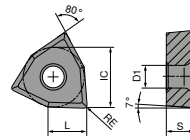

WCMT

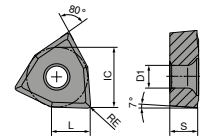

WCGT

WCMT / WCGT

	-SF30 CWC06	-SF20 CWN10	-SF16 CWP25
	F	F	F
	CERMET WCMT	WCGT	WCGT
	70 294 ...	70 295 ...	70 295 ...
	EUR X2	EUR X2	EUR X2
	15,19 850	77,71 850 77,71 852	34,66 500

ISO	RE mm
020102	0,2
020104	0,4

P	●	●	●
M	○	●	●
K	●	●	○
N	●	●	●
S		●	
H		●	
O			

→ v_c Page 66

Additional indexable inserts can be found in → **Chapter 9, Indexable insert turning tools**
or in our online shop at cuttingtools.ceratizit.com

CCGT

Designation	L mm	S mm	D1 mm	IC mm
CCGT 06..	6,4	2,38	2,8	6,35
CCGT 09..	9,7	3,97	4,4	9,52

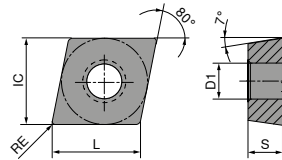

CCGT

	-SF20 CWN10	-SF15 CWC06	-SF14 CWC10
	F	F	F
	CCGT	CERMET CCGT	CERMET CCGT
	70 296 ...	70 296 ...	70 300 ...
	EUR X2	EUR X2	EUR X2
	52,42 300	33,66 850	16,89 903
	52,42 302	33,66 852	16,89 905
	56,70 304	36,63 854	21,87 911
	56,70 306	36,63 856	21,87 913

ISO	RE mm
060202L	0,2
060204L	0,4
09T302L	0,2
09T304L	0,4

P	●	●	●
M	●	○	●
K	●	●	●
N	●	●	●
S	●	●	●
H	●	●	●
O	●	●	●

→ v_c Page 66

Additional indexable inserts can be found in → **Chapter 9, Indexable insert turning tools**
or in our online shop at cuttingtools.ceratizit.com

Material examples for cutting data tables

	Material sub-group	Index	Composition / Structure / Heat treatment	Tensile strength N/mm ² / HB / HRC	Material number	Material designation	Material number	Material designation
P	Unalloyed steel	P.1.1	< 0,15 % C Annealed	420 N/mm ² / 125 HB	1.0401	C15	1.1141	Ck15
		P.1.2	< 0,45 % C Annealed	640 N/mm ² / 190 HB	1.1191	C45E	1.0718	9SMnPb28
		P.1.3	< 0,45 % C Tempered	840 N/mm ² / 250 HB	1.1191	C45E	1.0535	C55
		P.1.4	< 0,75 % C Annealed	910 N/mm ² / 270 HB	1.1223	C60R	1.0535	C55
		P.1.5	< 0,75 % C Tempered	1010 N/mm ² / 300 HB	1.1223	C60R	1.0727	45S20
	Low-alloy steel	P.2.1	Annealed	610 N/mm ² / 180 HB	1.7131	16MnCr5	1.6587	17CrNiMo6
		P.2.2	Tempered	930 N/mm ² / 275 HB	1.7131	16MnCr5	1.6587	17CrNiMo6
		P.2.3	Tempered	1010 N/mm ² / 300 HB	1.7225	42CrMo4	1.3505	100Cr6
		P.2.4	Tempered	1200 N/mm ² / 375 HB	1.7225	42CrMo4	1.3505	100Cr6
	High-alloy steel and high-alloy tool steel	P.3.1	Annealed	680 N/mm ² / 200 HB	1.4021	X20Cr13	1.4034	X46Cr13
		P.3.2	Hardened and tempered	1100 N/mm ² / 300 HB	1.2343	X38CrMoV5-1	1.4034	X46Cr13
		P.3.3	Hardened and tempered	1300 N/mm ² / 400 HB	1.2343	X38CrMoV5-1	1.4034	X46Cr13
	Stainless steel	P.4.1	Ferritic / martensitic Annealed	680 N/mm ² / 200 HB	1.4016	X6Cr17	1.2316	X36CrMo16
		P.4.2	Martensitic Tempered	1010 N/mm ² / 300 HB	1.4112	X90CrMoV18	1.2316	X36CrMo16
M	Stainless steel	M.1.1	Austenitic / austenitic-ferritic Quenched	610 N/mm ² / 180 HB	1.4301	X5CrNi18-10	1.4571	X6CrNiMoTi17-12-2
		M.2.1	Austenitic Tempered	300 HB	1.4841	X15CrNiSi25-21	1.4539	X1NiCrMoCu25-20-5
		M.3.1	Austenitic / ferritic (Duplex)	780 N/mm ² / 230 HB	1.4462	X2CrNiMoN22-5-3	1.4501	X2CrNiMoCuWN25-7-4
K	Grey cast iron	K.1.1	Pearlitic / ferritic	350 N/mm ² / 180 HB	0.6010	GG-10	0.6025	GG-25
		K.1.2	Pearlitic (martensitic)	500 N/mm ² / 260 HB	0.6030	GG-30	0.6045	GG-45
	Spherulitic graphite cast iron	K.2.1	Ferritic	540 N/mm ² / 160 HB	0.7040	GGG-40	0.7060	GGG-60
		K.2.2	Pearlitic	845 N/mm ² / 250 HB	0.7070	GGG-70	0.7080	GGG-80
	Malleable iron	K.3.1	Ferritic	440 N/mm ² / 130 HB	0.8035	GTW-35-04	0.8045	GTW-45
		K.3.2	Pearlitic	780 N/mm ² / 230 HB	0.8165	GTS-65-02	0.8170	GTS-70-02
N	Aluminium wrought alloy	N.1.1	Non-hardenable	60 HB	3.0255	Al99,5	3.3315	AlMg1
		N.1.2	Hardenable Age-hardened	340 N/mm ² / 100 HB	3.1355	AlCuMg2	3.2315	AlMgSi1
	Cast aluminium alloy	N.2.1	≤ 12 % Si, non-hardenable	250 N/mm ² / 75 HB	3.2581	G-AlSi12	3.2163	G-AlSi9Cu3
		N.2.2	≤ 12 % Si, hardenable Age-hardened	300 N/mm ² / 90 HB	3.2134	G-AlSi5Cu1Mg	3.2373	G-AlSi9Mg
		N.2.3	> 12 % Si, non-hardenable	440 N/mm ² / 130 HB		G-AlSi17Cu4Mg		G-AlSi18CuNiMg
	Copper and copper alloys (bronze/brass)	N.3.1	Free-machining alloys, PB > 1 %	375 N/mm ² / 110 HB	2.0380	CuZn39Pb2 (Ms58)	2.0410	CuZn44Pb2
		N.3.2	CuZn, CuSnZn	300 N/mm ² / 90 HB	2.0331	CuZn15	2.4070	CuZn28Sn1As
		N.3.3	CuSn, lead-free copper and electrolytic copper	340 N/mm ² / 100 HB	2.0060	E-Cu57	2.0590	CuZn40Fe
	Magnesium alloys	N.4.1	Magnesium and magnesium alloys	70 HB	3.5612	MgAl6Zn	3.5312	MgAl3Zn
	S	Heat-resistant alloys	S.1.1	Fe - basis Annealed	680 N/mm ² / 200 HB	1.4864	X12NiCrSi 36-16	1.4865
S.1.2			Fe - basis Age-hardened	950 N/mm ² / 280 HB	1.4980	X6NiCrTiMoVB25-15-2	1.4876	X10NiCrAlTi32-20
S.2.1			Ni or Co basis Annealed	840 N/mm ² / 250 HB	2.4631	NiCr20TiAl (Nimonic80A)	3.4856	NiCr22Mo9Nb
S.2.2			Ni or Co basis Age-hardened	1180 N/mm ² / 350 HB	2.4668	NiCr19Nb5Mo3 (Inconel 718)	2.4955	NiFe25Cr20NbTi
S.2.3			Ni or Co basis Cast	1080 N/mm ² / 320 HB	2.4765	CoCr20W15Ni	1.3401	G-X120Mn12
Titanium alloys		S.3.1	Pure titanium	400 N/mm ²	3.7025	Ti99,8	3.7034	Ti99,7
		S.3.2	Alpha + beta alloys Age-hardened	1050 N/mm ² / 320 HB	3.7165	TiAl6V4	Ti-6246	Ti-6Al-2Sn-4Zr-6Mo
S.3.3	Beta alloys	1400 N/mm ² / 410 HB	Ti555.3	Ti-5Al-5V-5Mo-3Cr	R56410	Ti-10V-2Fe-3Al		
H	Hardened steel	H.1.1	Hardened and tempered	46–55 HRC				
		H.1.2	Hardened and tempered	56–60 HRC				
		H.1.3	Hardened and tempered	61–65 HRC				
		H.1.4	Hardened and tempered	66–70 HRC				
	Chilled iron	H.2.1	Cast	400 HB				
Hardened cast iron	H.3.1	Hardened and tempered	55 HRC					
O	Non-metal materials	O.1.1	Plastics, duroplastic	≤ 150 N/mm ²				
		O.1.2	Plastics, thermoplastic	≤ 100 N/mm ²				
		O.2.1	Aramid fibre-reinforced	≤ 1000 N/mm ²				
		O.2.2	Glass/carbon-fibre reinforced	≤ 1000 N/mm ²				
		O.3.1	Graphite					

* Tensile strength

Cutting data standard values for indexable inserts – MicroKom tools

Index	Indexable inserts for ...																				
	MicroKom												TwinKom								
	62 800 ..., 62 810 ..., 62 815 ..., 62 820 ..., 62 840 ...												62 870 ...								
	K10	BK 2710	BK 60	BK 6110	BK 7615	BK 7710	BK 8425	BK 8430	BK 8440	CBN 40	CTDPU 20	CK 3230	CK 32	BK 6115	BK 6440	BK 7615	BK 77	BK 7710	BK 7935	BK 8425	BK 8430
v _c (m/min)												v _c (m/min)									
P.1.1		230	270	300			260	200	170			350	350	300	240				250	260	200
P.1.2		230	270	300			260	200	170			350	350	300	240				220	260	200
P.1.3		230	270	300			270	200	170			350	350	270	220				270	270	200
P.1.4		210	250	300			240	180	150			320	320	250	220				240	240	180
P.1.5		210	250	300			230	180	150			320	320	270	220				200	230	180
P.2.1		180	210	270			270	160	140			280	280	270	200				270	270	160
P.2.2		180	210	270			260	160	140			280	280	260	200				260	260	160
P.2.3		180	210	270			180	160	140			280	280	240	200				160	180	160
P.2.4		180	210	270			150	160	140			280	280	190	200				130	150	160
P.3.1		160	190	250			160	140	120			250	250	200	180				140	160	140
P.3.2		160	190	250			130	140	120			250	250	160	160				110	130	140
P.3.3		160	190	250			120	140	120			250	250	140	160				100	120	140
P.4.1		140	160	220			180	120	100			210	210	220	140				160	180	120
P.4.2		140	160	220			130	120	100			210	210	160	140				110	130	120
M.1.1		180	280	220			150	160	140			280	280	220	200				160	150	160
M.2.1		160	250	220			150	140	120			250	250	220	180				160	150	140
M.3.1		120	180	200			130	100	90			180	180	200	160				150	130	100
K.1.1		210	210	290	290		160	180	150					240		290			150	160	180
K.1.2		180	180	290	290		120	160	140					140		290			110	120	160
K.2.1		160	160	270	270		160	140	120					160		270			150	160	140
K.2.2		160	160	250	250		100	140	120					100		250			90	100	140
K.3.1		140	140	220	220		120	120	100					120		220			110	120	120
K.3.2		140	140	220	220		100	120	100					100		220			90	100	120
N.1.1	250					600	400					500						600	400	400	
N.1.2	250					500	400					500						500	400	400	
N.2.1	250					400	250					500						400	250	250	
N.2.2	250					300	250					500						300	250	250	
N.2.3	250					250	230					500						250	230	230	
N.3.1	230					400	200					450						400	200	200	
N.3.2	230					300	220					450						300	220	220	
N.3.3	230					300	330					450						300	330	330	
N.4.1	230					300	200					450						300	200	200	
S.1.1	20	60				60	60	60									50	60	50	60	60
S.1.2	20	50				60	50	50									40	60	40	50	50
S.2.1	20	60				60	60	60									50	60	50	60	60
S.2.2	20	50				60	50	50									40	60	40	50	50
S.2.3	20	30				60	30	30									30	60	30	30	30
S.3.1	60	100				80	100	100									70	80	70	100	100
S.3.2	30	80				80	80	80									60	80	60	80	80
S.3.3	30	50				80	50	50									40	80	40	50	50
H.1.1				100		80	100	100	90	160				100			40	80		100	100
H.1.2				80		40	80	80	70	185				80			30	40		80	80
H.1.3				50		40	50	50	40	215				50			20	40		50	50
H.1.4						40				240								40			
H.2.1				100		80	100	100	90					100			40	80		100	100
H.3.1				80		80	80	80	70					80			30	80		80	80
O.1.1	100					100						500					100	100			
O.1.2	100					100						500					100	100			
O.2.1												500									
O.2.2	100					100						300					100	100			
O.3.1	100					100						300					100	100			

5

→ v_c Page 65+66 → n_{max} Page 72+74 → LTA Page 72+74

The cutting data is significantly dependent on the external conditions, e.g. stability of the tool and workpiece clamping, material and machine type! The stated values are possible cutting data which have to be increased or reduced according to the application conditions! The specified values represent guideline cutting data that can be adjusted by approx. ± 20 % according to the usage conditions. It is essential to observe the v_c values of the type used, the maximum speeds of the system and the reduction of these maximum speeds depending on the type used overhang length (LTA).

Cutting data standard values for indexable inserts – SpinTools tools

Index	Indexable inserts for ...									Boring steel	Inserts Cutting insert
	62 295 ...					62 303 ..., 62 304 ..., 62 305 ..., 62 308 ..., 62 326 ..., 62 332 ..., 62 333 ..., 62 363 ..., 62 372 ..., 62 373 ...				62 346 ...	62 383 ..., 62 384 ...
	CTCP125 (HCX1125)	CTCP115 (HCX1115)	CTCP135 (HCR1135)	CTC2135 (CWN2135)	H10T (CWK15)	CWN10	CWP25	CWC06	CWC10	HM uncoated	Solid carbide TiN
	v _c (m/min)					v _c (m/min)				v _c (m/min)	v _c (m/min)
P.1.1	295	370	210	360		185	185	250	175	175	190
P.1.2	250	315	175	360		185	185	250	140	175	200
P.1.3	210	270	145	360		185	185	250	140	175	170
P.1.4	200	250	135	375		185	185	250	140	175	170
P.1.5	180	230	120	375		185	185	250	140	175	160
P.2.1	260	325	180	385		185	185	250	140	175	180
P.2.2	195	250	130	385		185	185	250	175	175	150
P.2.3	180	230	120	385		185	185	250	140	175	160
P.2.4	130	170	85	385		185	185	250	140	175	160
P.3.1	170	200	150	310		185	185	250	175	175	120
P.3.2	105	140	95	310		135	135	165	140	65	100
P.3.3	40	85	35	310		135	135	165	140	65	100
P.4.1	170	200	155	320		125	125	120	120	100	80
P.4.2	135	170	125	320		125	125	120	120	100	80
M.1.1			155	300		120	120	120	120	100	80
M.2.1			95	310		100	100	100	110	70	80
M.3.1			135	325		120	120	120	120	100	80
K.1.1	170	255			140	160	160	160	225	135	200
K.1.2	160	235			115	160	160	160	225	135	150
K.2.1	180	270			150	160	160	160	125	135	120
K.2.2	160	205			110	140	140	140	125	115	110
K.3.1	200	250			170	140	140	140	125	115	180
K.3.2	160	210			140	140	140	140	125	115	150
N.1.1					1400	400	400	400		250	300
N.1.2					1100	400	400	400		250	240
N.2.1					950	400	400	400		250	240
N.2.2					950	400	400	400		250	240
N.2.3					500	400	400	400		250	240
N.3.1					425	400	400	400		250	290
N.3.2					400	400	400	400		250	290
N.3.3					275	400	400	400		250	290
N.4.1					225						220
S.1.1				30		55					60
S.1.2				25		55					40
S.2.1				15		55					30
S.2.2				10		55					30
S.2.3				10		55					30
S.3.1				105		55					30
S.3.2				25		55					25
S.3.3						55					25
H.1.1						125					110
H.1.2						100					80
H.1.3						80					70
H.1.4											
H.2.1						170					70
H.3.1						125					70
O.1.1					130						240
O.1.2											240
O.2.1					105						180
O.2.2											180
O.3.1											180

 → v_c Page 65+66 → n_{max} Page 72+74 → LTA Page 72+74
 The cutting data is significantly dependent on the external conditions, e.g. stability of the tool and workpiece clamping, material and machine type! The stated values are possible cutting data which have to be increased or reduced according to the application conditions! The specified values represent guideline cutting data that can be adjusted by approx. ± 20 % according to the usage conditions. It is essential to observe the v_c values of the type used, the maximum speeds of the system and the reduction of these maximum speeds depending on the type used overhang length (LTA).

Cutting data standard values for precision adjustment heads – MicroKom

Index	62 820 ..., 62 840 ..., 62 800 ...				62 800 06089			● 1st choice		
	BluFlex 2, hi.flex				hi.flex micro			○ suitable		
	Fine machining with depth of cut $a_p = 0.1 - 0.2$ mm				Fine machining with depth of cut $a_p = 0.1 - 0.2$ mm			Emulsion	Compressed air	MMS
	Ø 0,5 – 5,6	Ø 5,6 – 8	Ø 8 – 12	Ø 12 – 365	Ø 0,5 – 8	Ø 8 – 12	Ø 12 – 60			
	f (mm/rev)				f (mm/rev)					
P.1.1	0,02–0,05	0,03–0,04	0,05–0,07	0,07–0,10	0,02–0,05	0,05–0,07	0,07–0,10	●	○	
P.1.2	0,02–0,05	0,03–0,04	0,05–0,07	0,08–0,12	0,02–0,05	0,05–0,07	0,08–0,12	●	○	
P.1.3	0,02–0,05	0,03–0,04	0,04–0,06	0,08–0,12	0,02–0,05	0,04–0,06	0,08–0,12	●	○	
P.1.4	0,02–0,05	0,03–0,04	0,04–0,06	0,07–0,10	0,02–0,05	0,04–0,06	0,07–0,10	●	○	
P.1.5	0,02–0,05	0,03–0,04	0,05–0,07	0,08–0,12	0,02–0,05	0,05–0,07	0,08–0,12	●	○	
P.2.1	0,02–0,05	0,03–0,04	0,04–0,06	0,08–0,12	0,02–0,05	0,04–0,06	0,08–0,12	●	○	
P.2.2	0,02–0,05	0,03–0,04	0,04–0,06	0,07–0,10	0,02–0,05	0,04–0,06	0,07–0,10	●	○	
P.2.3	0,02–0,05	0,02–0,03	0,04–0,06	0,07–0,10	0,02–0,05	0,04–0,06	0,07–0,10	●	○	
P.2.4	0,02–0,05	0,02–0,03	0,03–0,04	0,06–0,08	0,02–0,05	0,03–0,04	0,06–0,08	●	○	
P.3.1	0,02–0,05	0,02–0,03	0,04–0,06	0,06–0,08	0,02–0,05	0,04–0,06	0,06–0,08	●	○	
P.3.2	0,02–0,05	0,02–0,03	0,03–0,04	0,06–0,08	0,02–0,05	0,03–0,04	0,06–0,08	●	○	
P.3.3	0,02–0,05	0,02–0,03	0,03–0,04	0,06–0,08	0,02–0,05	0,03–0,04	0,06–0,08	●	○	
P.4.1	0,02–0,05	0,02–0,03	0,04–0,05	0,07–0,10	0,02–0,05	0,04–0,05	0,07–0,10	●	○	
P.4.2	0,02–0,05	0,02–0,03	0,03–0,04	0,06–0,08	0,02–0,05	0,03–0,04	0,06–0,08	●	○	
M.1.1	0,02–0,05	0,01–0,015	0,04–0,05	0,07–0,10	0,02–0,05	0,04–0,05	0,07–0,10	●	○	
M.2.1	0,02–0,05	0,01–0,015	0,03–0,04	0,06–0,08	0,02–0,05	0,03–0,04	0,06–0,08	●	○	
M.3.1	0,02–0,05	0,01–0,015	0,03–0,04	0,06–0,08	0,02–0,05	0,03–0,04	0,06–0,08	●	○	
K.1.1	0,02–0,05	0,04–0,05	0,06–0,08	0,11–0,15	0,02–0,05	0,06–0,08	0,11–0,15	○	●	
K.1.2	0,02–0,05	0,04–0,05	0,06–0,08	0,11–0,15	0,02–0,05	0,06–0,08	0,11–0,15	○	●	
K.2.1	0,02–0,05	0,03–0,04	0,06–0,08	0,11–0,15	0,02–0,05	0,06–0,08	0,11–0,15	○	●	
K.2.2	0,02–0,05	0,02–0,03	0,05–0,07	0,08–0,12	0,02–0,05	0,05–0,07	0,08–0,12	○	●	
K.3.1	0,02–0,05	0,03–0,04	0,06–0,08	0,11–0,15	0,02–0,05	0,06–0,08	0,11–0,15	○	●	
K.3.2	0,02–0,05	0,02–0,03	0,05–0,07	0,08–0,12	0,02–0,05	0,05–0,07	0,08–0,12	○	●	
N.1.1	0,02–0,05	0,01–0,02	0,04–0,06	0,07–0,10	0,02–0,05	0,04–0,06	0,07–0,10	●	○	
N.1.2	0,02–0,05	0,01–0,02	0,04–0,06	0,07–0,10	0,02–0,05	0,04–0,06	0,07–0,10	●	○	
N.2.1	0,02–0,05	0,04–0,05	0,06–0,08	0,08–0,12	0,02–0,05	0,06–0,08	0,08–0,12	●	○	
N.2.2	0,02–0,05	0,04–0,05	0,06–0,08	0,08–0,12	0,02–0,05	0,06–0,08	0,08–0,12	●	○	
N.2.3	0,02–0,05	0,04–0,05	0,06–0,08	0,08–0,12	0,02–0,05	0,06–0,08	0,08–0,12	●	○	
N.3.1	0,02–0,05	0,01–0,02	0,03–0,04	0,06–0,08	0,02–0,05	0,03–0,04	0,06–0,08	●	○	
N.3.2	0,02–0,05	0,01–0,02	0,03–0,04	0,06–0,08	0,02–0,05	0,03–0,04	0,06–0,08	●	○	
N.3.3	0,02–0,05	0,04–0,05	0,06–0,08	0,11–0,15	0,02–0,05	0,06–0,08	0,11–0,15	●	○	
N.4.1	0,02–0,05	0,01–0,02	0,03–0,04	0,06–0,08	0,02–0,05	0,03–0,04	0,06–0,08	●	○	
S.1.1	0,02–0,08	0,01–0,015	0,03–0,04	0,06–0,08	0,02–0,08	0,03–0,04	0,06–0,08	●	○	
S.1.2	0,02–0,08	0,01–0,015	0,02–0,03	0,04–0,06	0,02–0,08	0,02–0,03	0,04–0,06	●	○	
S.2.1	0,02–0,08	0,01–0,015	0,03–0,04	0,06–0,08	0,02–0,08	0,03–0,04	0,06–0,08	●	○	
S.2.2	0,02–0,08	0,01–0,015	0,02–0,03	0,04–0,06	0,02–0,08	0,02–0,03	0,04–0,06	●	○	
S.2.3	0,02–0,08	0,01–0,015	0,06–0,08	0,04–0,06	0,02–0,08	0,06–0,08	0,04–0,06	●	○	
S.3.1	0,02–0,08	0,01–0,015	0,03–0,04	0,06–0,08	0,02–0,08	0,03–0,04	0,06–0,08	●	○	
S.3.2	0,02–0,08	0,01–0,015	0,03–0,04	0,06–0,08	0,02–0,08	0,03–0,04	0,06–0,08	●	○	
S.3.3	0,02–0,08	0,01–0,015	0,01–0,02	0,03–0,04	0,02–0,08	0,01–0,02	0,03–0,04	●	○	
H.1.1	0,02–0,05		0,04–0,05	0,06–0,08	0,02–0,05	0,04–0,05	0,06–0,08		●	
H.1.2	0,02–0,05		0,04–0,05	0,06–0,08	0,02–0,05	0,04–0,05	0,06–0,08		●	
H.1.3	0,02–0,05		0,02–0,03	0,03–0,04	0,02–0,05	0,02–0,03	0,03–0,04		●	
H.1.4										
H.2.1	0,02–0,05		0,04–0,05	0,06–0,08	0,02–0,05	0,04–0,05	0,06–0,08		●	
H.3.1	0,02–0,05		0,04–0,05	0,06–0,08	0,02–0,05	0,04–0,05	0,06–0,08		●	
O.1.1	0,02–0,05		0,06–0,08	0,06–0,08	0,02–0,05	0,06–0,08	0,06–0,08	○	●	
O.1.2	0,02–0,05		0,06–0,08	0,06–0,08	0,02–0,05	0,06–0,08	0,06–0,08	○	●	
O.2.1										
O.2.2	0,02–0,05		0,06–0,08	0,07–0,10	0,02–0,05	0,06–0,08	0,07–0,10		●	
O.3.1	0,02–0,05		0,06–0,08	0,07–0,10	0,02–0,05	0,06–0,08	0,07–0,10		●	

5

→ v_c Page 65+66 → n_{max} Page 72+74 → LTA Page 72+74
 The cutting data is significantly dependent on the external conditions, e.g. stability of the tool and workpiece clamping, material and machine type! The specified values represent guideline cutting data that can be adjusted within the range according to the usage conditions! It is essential to observe the v_c values of the type used, the maximum speeds of the system and the reduction of these maximum speeds depending on the type used overhang length (LTA).

Cutting data standard values for precision adjustment heads – MicroKom

Index	62 815 ...		62 810 ...			● 1st choice		
	M03 Speed		FF precision adjustment head			○ suitable		
	Fine machining with depth of cut $a_p = 0.1 - 0.2$ mm		Fine machining with depth of cut $a_p = 0.1 - 0.2$ mm			Emulsion	Compressed air	MMS
	Ø 24,8 – 63	Ø 63 – 206	Ø 29,5 – 50	Ø 47 – 83	Ø 79 – 199			
f (mm/rev)		f (mm/rev)						
P.1.1	0,06–0,08	0,07–0,10	0,06–0,08	0,07–0,10	0,11–0,15	●	○	○
P.1.2	0,07–0,10	0,11–0,15	0,07–0,10	0,11–0,15	0,14–0,20	●	○	○
P.1.3	0,06–0,08	0,08–0,12	0,06–0,08	0,08–0,12	0,14–0,20	●	○	○
P.1.4	0,05–0,07	0,07–0,10	0,05–0,07	0,07–0,10	0,13–0,18	●	○	○
P.1.5	0,06–0,09	0,09–0,13	0,06–0,09	0,09–0,13	0,13–0,18	●	○	○
P.2.1	0,06–0,08	0,08–0,12	0,06–0,08	0,08–0,12	0,14–0,20	●	○	○
P.2.2	0,05–0,07	0,07–0,10	0,05–0,07	0,07–0,10	0,13–0,18	●	○	○
P.2.3	0,06–0,08	0,07–0,10	0,06–0,08	0,07–0,10	0,14–0,20	●	○	○
P.2.4	0,04–0,06	0,06–0,08	0,04–0,06	0,06–0,08	0,07–0,10	●	○	○
P.3.1	0,04–0,06	0,07–0,10	0,04–0,06	0,07–0,10	0,11–0,15	●	○	○
P.3.2	0,03–0,04	0,06–0,08	0,03–0,04	0,06–0,08	0,08–0,12	●	○	○
P.3.3	0,03–0,04	0,05–0,07	0,03–0,04	0,05–0,07	0,07–0,10	●	○	○
P.4.1	0,04–0,06	0,07–0,10	0,04–0,06	0,07–0,10	0,11–0,15	●	○	○
P.4.2	0,03–0,04	0,06–0,08	0,03–0,04	0,06–0,08	0,08–0,12	●	○	○
M.1.1	0,04–0,06	0,07–0,10	0,04–0,06	0,07–0,10	0,11–0,15	●	○	○
M.2.1	0,04–0,06	0,07–0,10	0,04–0,06	0,07–0,10	0,11–0,15	●	○	○
M.3.1	0,04–0,05	0,06–0,09	0,04–0,05	0,06–0,09	0,08–0,12	●	○	○
K.1.1	0,11–0,15	0,14–0,20	0,11–0,15	0,14–0,20	0,21–0,30	○	●	○
K.1.2	0,11–0,15	0,14–0,20	0,11–0,15	0,14–0,20	0,21–0,30	○	●	○
K.2.1	0,07–0,10	0,11–0,15	0,07–0,10	0,11–0,15	0,18–0,25	○	●	○
K.2.2	0,06–0,08	0,08–0,12	0,06–0,08	0,08–0,12	0,14–0,20	○	●	○
K.3.1	0,07–0,10	0,11–0,15	0,07–0,10	0,11–0,15	0,18–0,25	○	●	○
K.3.2	0,06–0,08	0,08–0,12	0,06–0,08	0,08–0,12	0,14–0,20	○	●	○
N.1.1	0,06–0,08	0,08–0,12	0,06–0,08	0,08–0,12	0,11–0,15	●	○	○
N.1.2	0,06–0,08	0,08–0,12	0,06–0,08	0,08–0,12	0,11–0,15	●	○	○
N.2.1	0,07–0,10	0,11–0,15	0,07–0,10	0,11–0,15	0,14–0,20	●	○	○
N.2.2	0,07–0,10	0,11–0,15	0,07–0,10	0,11–0,15	0,14–0,20	●	○	○
N.2.3	0,06–0,09	0,08–0,12	0,06–0,09	0,08–0,12	0,13–0,18	●	○	○
N.3.1	0,07–0,10	0,11–0,15	0,07–0,10	0,11–0,15	0,14–0,20	●	○	○
N.3.2	0,07–0,10	0,11–0,15	0,07–0,10	0,11–0,15	0,15–0,22	●	○	○
N.3.3	0,07–0,10	0,11–0,15	0,07–0,10	0,11–0,15	0,14–0,20	●	○	○
N.4.1	0,07–0,10	0,11–0,15	0,07–0,10	0,11–0,15	0,14–0,20	●	○	○
S.1.1	0,04–0,06	0,06–0,08	0,04–0,06	0,06–0,08	0,07–0,10	●	○	○
S.1.2	0,03–0,04	0,04–0,06	0,03–0,04	0,04–0,06	0,06–0,08	●	○	○
S.2.1	0,04–0,06	0,06–0,08	0,04–0,06	0,06–0,08	0,07–0,10	●	○	○
S.2.2	0,03–0,04	0,04–0,06	0,03–0,04	0,04–0,06	0,06–0,08	●	○	○
S.2.3	0,03–0,04	0,04–0,06	0,03–0,04	0,04–0,06	0,04–0,06	●	○	○
S.3.1	0,04–0,06	0,06–0,08	0,04–0,06	0,06–0,08	0,08–0,11	●	○	○
S.3.2	0,04–0,06	0,06–0,08	0,04–0,06	0,06–0,08	0,07–0,10	●	○	○
S.3.3	0,03–0,04	0,04–0,06	0,03–0,04	0,04–0,06	0,07–0,10	●	○	○
H.1.1	0,06–0,08	0,06–0,08	0,06–0,08	0,06–0,08	0,07–0,10		●	○
H.1.2	0,04–0,06	0,04–0,06	0,04–0,06	0,04–0,06	0,06–0,08		●	○
H.1.3	0,03–0,04	0,03–0,04	0,03–0,04	0,03–0,04	0,03–0,04		●	○
H.1.4								
H.2.1	0,04–0,05	0,04–0,06	0,04–0,05	0,04–0,06	0,07–0,10		●	○
H.3.1	0,04–0,05	0,04–0,06	0,04–0,05	0,04–0,06	0,06–0,08		●	○
O.1.1	0,06–0,08	0,06–0,08	0,06–0,08	0,06–0,08	0,06–0,08	○	●	○
O.1.2	0,06–0,08	0,06–0,08	0,06–0,08	0,06–0,08	0,06–0,08	○	●	○
O.2.1								
O.2.2	0,06–0,08	0,06–0,08	0,06–0,08	0,06–0,08	0,06–0,08		●	
O.3.1	0,06–0,08	0,06–0,08	0,06–0,08	0,06–0,08	0,06–0,08		●	

 → v_c Page 65+66 → n_{max} Page 72+74 → LTA Page 72+74
 The cutting data is significantly dependent on the external conditions, e.g. stability of the tool and workpiece clamping, material and machine type! The specified values represent guideline cutting data that can be adjusted within the range according to the usage conditions! It is essential to observe the v_c values of the type used, the maximum speeds of the system and the reduction of these maximum speeds depending on the type used overhang length (LTA).

Cutting data standard values for finish boring heads – SpinTools

Index	62 303 ..., 62 308 ...	62 305 ...	● 1st choice ○ suitable			62 382 ..., 62 386 ...	62 372 ..., 62 373 ...	62 326 ..., 62 332 ..., 62 333 ..., 62 363 ...	62 304 ...	● 1st choice ○ suitable		
	Single point finish boring head					Micro Boring Head	Multi-Head boring and fine boring head	Single point boring head	Fine boring head	Emulsion	Compressed air	MMS
	$a_p = 0,1 - 0,4$					$a_p = 0,1 - 0,2$	$a_p = 0,1 - 0,4$	$a_p = 0,1 - 0,4$	$a_p = 0,1 - 0,4$			
	$\varnothing 23,9-116,1 \quad \varnothing 86-402$					$\varnothing 0,3-19,1$	$\varnothing 2-320$	$\varnothing 3-88$	$\varnothing 14,7-24,1$			
f (mm/rev)					f (mm/rev)							
P.1.1	0,03-0,12	0,03-0,12	●	○		0,02	0,03-0,12	0,03-0,12	0,03-0,10	●	○	○
P.1.2	0,03-0,12	0,03-0,12	●	○		0,02	0,03-0,12	0,03-0,12	0,03-0,10	●	○	○
P.1.3	0,03-0,12	0,03-0,12	●	○		0,02	0,03-0,12	0,03-0,12	0,03-0,10	●	○	○
P.1.4	0,03-0,12	0,03-0,12	●	○		0,02	0,03-0,12	0,03-0,12	0,03-0,10	●	○	○
P.1.5	0,03-0,12	0,03-0,12	●	○		0,02	0,03-0,12	0,03-0,12	0,03-0,10	●	○	○
P.2.1	0,03-0,12	0,03-0,12	●	○		0,02	0,03-0,12	0,03-0,12	0,03-0,10	●	○	○
P.2.2	0,03-0,12	0,03-0,12	●	○		0,02	0,03-0,12	0,03-0,12	0,03-0,10	●	○	○
P.2.3	0,03-0,12	0,03-0,12	●	○		0,02	0,03-0,12	0,03-0,12	0,03-0,10	●	○	○
P.2.4	0,03-0,12	0,03-0,12	●	○		0,02	0,03-0,12	0,03-0,12	0,03-0,10	●	○	○
P.3.1	0,03-0,12	0,03-0,12	●	○		0,02	0,03-0,12	0,03-0,12	0,03-0,10	●	○	○
P.3.2	0,03-0,12	0,03-0,12	●	○		0,02	0,03-0,12	0,03-0,12	0,03-0,10	●	○	○
P.3.3	0,03-0,12	0,03-0,12	●	○		0,02	0,03-0,12	0,03-0,12	0,03-0,10	●	○	○
P.4.1	0,03-0,12	0,03-0,12	●	○		0,02	0,03-0,12	0,03-0,12	0,03-0,10	●	○	○
P.4.2	0,03-0,12	0,03-0,12	●	○		0,02	0,03-0,12	0,03-0,12	0,03-0,10	●	○	○
M.1.1	0,03-0,12	0,03-0,12	●	○		0,02	0,03-0,12	0,03-0,12	0,03-0,10	●	○	○
M.2.1	0,03-0,12	0,03-0,12	●	○		0,02	0,03-0,12	0,03-0,12	0,03-0,10	●	○	○
M.3.1	0,03-0,12	0,03-0,12	●	○		0,02	0,03-0,12	0,03-0,12	0,03-0,10	●	○	○
K.1.1	0,03-0,12	0,03-0,12	○	●		0,02	0,03-0,12	0,03-0,12	0,03-0,10	○	●	○
K.1.2	0,03-0,12	0,03-0,12	○	●		0,02	0,03-0,12	0,03-0,12	0,03-0,10	○	●	○
K.2.1	0,03-0,12	0,03-0,12	○	●		0,02	0,03-0,12	0,03-0,12	0,03-0,10	○	●	○
K.2.2	0,03-0,12	0,03-0,12	○	●		0,02	0,03-0,12	0,03-0,12	0,03-0,10	○	●	○
K.3.1	0,03-0,12	0,03-0,12	○	●		0,02	0,03-0,12	0,03-0,12	0,03-0,10	○	●	○
K.3.2	0,03-0,12	0,03-0,12	○	●		0,02	0,03-0,12	0,03-0,12	0,03-0,10	○	●	○
N.1.1	0,03-0,12	0,03-0,12	●	○		0,02	0,03-0,12	0,03-0,12	0,03-0,10	●	○	○
N.1.2	0,03-0,12	0,03-0,12	●	○		0,02	0,03-0,12	0,03-0,12	0,03-0,10	●	○	○
N.2.1	0,03-0,12	0,03-0,12	●	○		0,02	0,03-0,12	0,03-0,12	0,03-0,10	●	○	○
N.2.2	0,03-0,12	0,03-0,12	●	○		0,02	0,03-0,12	0,03-0,12	0,03-0,10	●	○	○
N.2.3	0,03-0,12	0,03-0,12	●	○		0,02	0,03-0,12	0,03-0,12	0,03-0,10	●	○	○
N.3.1	0,03-0,12	0,03-0,12	●	○		0,02	0,03-0,12	0,03-0,12	0,03-0,10	●	○	○
N.3.2	0,03-0,12	0,03-0,12	●	○		0,02	0,03-0,12	0,03-0,12	0,03-0,10	●	○	○
N.3.3	0,03-0,12	0,03-0,12	●	○		0,02	0,03-0,12	0,03-0,12	0,03-0,10	●	○	○
N.4.1	0,03-0,12	0,03-0,12	●	○		0,02	0,03-0,12	0,03-0,12	0,03-0,10	●	○	○
S.1.1	0,03-0,12	0,03-0,12	●	○		0,02	0,03-0,12	0,03-0,12	0,03-0,10	●	○	○
S.1.2	0,03-0,12	0,03-0,12	●	○		0,02	0,03-0,12	0,03-0,12	0,03-0,10	●	○	○
S.2.1	0,03-0,12	0,03-0,12	●	○		0,02	0,03-0,12	0,03-0,12	0,03-0,10	●	○	○
S.2.2	0,03-0,12	0,03-0,12	●	○		0,02	0,03-0,12	0,03-0,12	0,03-0,10	●	○	○
S.2.3	0,03-0,12	0,03-0,12	●	○		0,02	0,03-0,12	0,03-0,12	0,03-0,10	●	○	○
S.3.1	0,03-0,12	0,03-0,12	●	○		0,02	0,03-0,12	0,03-0,12	0,03-0,10	●	○	○
S.3.2	0,03-0,12	0,03-0,12	●	○		0,02	0,03-0,12	0,03-0,12	0,03-0,10	●	○	○
S.3.3	0,03-0,12	0,03-0,12	●	○		0,02	0,03-0,12	0,03-0,12	0,03-0,10	●	○	○
H.1.1	0,03-0,12	0,03-0,12	○	●		0,02	0,03-0,12	0,03-0,12	0,03-0,10	○	●	○
H.1.2	0,03-0,12	0,03-0,12	○	●		0,02	0,03-0,12	0,03-0,12	0,03-0,10	○	●	○
H.1.3	0,03-0,12	0,03-0,12	○	●		0,02	0,03-0,12	0,03-0,12	0,03-0,10	○	●	○
H.1.4												
H.2.1	0,03-0,12	0,03-0,12	○	●		0,02	0,03-0,12	0,03-0,12	0,03-0,10	○	●	○
H.3.1	0,03-0,12	0,03-0,12	○	●		0,02	0,03-0,12	0,03-0,12	0,03-0,10	○	●	○
O.1.1	0,03-0,12	0,03-0,12	○	●		0,02	0,03-0,12	0,03-0,12	0,03-0,10	○	●	○
O.1.2	0,03-0,12	0,03-0,12	○	●		0,02	0,03-0,12	0,03-0,12	0,03-0,10	○	●	○
O.2.1	0,03-0,12	0,03-0,12	○	●		0,02	0,03-0,12	0,03-0,12	0,03-0,10	○	●	○
O.2.2	0,03-0,12	0,03-0,12		●		0,02	0,03-0,12	0,03-0,12	0,03-0,10		●	
O.3.1	0,03-0,12	0,03-0,12		●		0,02	0,03-0,12	0,03-0,12	0,03-0,10		●	

5

→ v_c Page 65+66 → n_{max} Page 72+74 → LTA Page 72+74
 The cutting data is significantly dependent on the external conditions, e.g. stability of the tool and workpiece clamping, material and machine type! The specified values represent guideline cutting data that can be adjusted within the range (i.e. by $\pm 20\%$) according to the usage conditions! It is essential to observe the v_c values of the type used, the maximum speeds of the system and the reduction of these maximum speeds depending on the type used overhang length (LTA).

Cutting data standard values for boring heads for roughing – TwinKom

Index	62 870 ...							● 1st choice		
	Twin cutters							○ suitable		
	Cutting depth $a_p = 1 - 9$ mm							Emulsion	Compressed air	MMS
	Ø 24-32	Ø 30-41	Ø 39-53	Ø 51-71	Ø 64-91	Ø 83-124	Ø 109-215			
f (mm/rev)										
P.1.1	0,14-0,20	0,17-0,24	0,22-0,30	0,28-0,40	0,32-0,45	0,35-0,50	0,35-0,50	●	○	○
P.1.2	0,14-0,20	0,17-0,24	0,22-0,30	0,28-0,40	0,32-0,45	0,35-0,50	0,35-0,50	●	○	○
P.1.3	0,14-0,20	0,17-0,24	0,22-0,30	0,28-0,40	0,32-0,45	0,35-0,50	0,35-0,50	●	○	○
P.1.4	0,14-0,20	0,17-0,24	0,22-0,30	0,28-0,40	0,32-0,45	0,35-0,50	0,35-0,50	●	○	○
P.1.5	0,14-0,20	0,17-0,24	0,22-0,30	0,28-0,40	0,32-0,45	0,35-0,50	0,35-0,50	●	○	○
P.2.1	0,14-0,20	0,17-0,24	0,22-0,30	0,28-0,40	0,32-0,45	0,35-0,50	0,35-0,50	●	○	○
P.2.2	0,14-0,20	0,17-0,24	0,22-0,30	0,28-0,40	0,32-0,45	0,35-0,50	0,35-0,50	●	○	○
P.2.3	0,14-0,20	0,17-0,24	0,22-0,30	0,28-0,40	0,32-0,45	0,35-0,50	0,35-0,50	●	○	○
P.2.4	0,14-0,20	0,17-0,24	0,22-0,30	0,28-0,40	0,32-0,45	0,35-0,50	0,35-0,50	●	○	○
P.3.1	0,11-0,15	0,14-0,20	0,18-0,25	0,22-0,32	0,27-0,38	0,29-0,42	0,29-0,42	●	○	○
P.3.2	0,11-0,15	0,14-0,20	0,18-0,25	0,22-0,32	0,27-0,38	0,29-0,42	0,29-0,42	●	○	○
P.3.3	0,11-0,15	0,14-0,20	0,18-0,25	0,22-0,32	0,27-0,38	0,29-0,42	0,29-0,42	●	○	○
P.4.1	0,08-0,12	0,11-0,15	0,14-0,20	0,18-0,25	0,20-0,28	0,25-0,35	0,25-0,35	●	○	○
P.4.2	0,08-0,12	0,11-0,15	0,14-0,20	0,18-0,25	0,20-0,28	0,25-0,35	0,25-0,35	●	○	○
M.1.1	0,10-0,14	0,13-0,18	0,17-0,24	0,17-0,24	0,21-0,30	0,28-0,40	0,32-0,45	●	○	○
M.2.1	0,10-0,14	0,13-0,18	0,17-0,24	0,28-0,40	0,21-0,30	0,28-0,40	0,32-0,45	●	○	○
M.3.1	0,08-0,12	0,10-0,14	0,14-0,20	0,14-0,20	0,18-0,25	0,21-0,30	0,25-0,35	●	○	○
K.1.1	0,18-0,25	0,21-0,30	0,28-0,40	0,35-0,50	0,39-0,55	0,42-0,60	0,42-0,60	○	●	○
K.1.2	0,18-0,25	0,21-0,30	0,28-0,40	0,35-0,50	0,39-0,55	0,42-0,60	0,42-0,60	○	●	○
K.2.1	0,18-0,25	0,21-0,30	0,28-0,40	0,35-0,50	0,39-0,55	0,42-0,60	0,42-0,60	○	●	○
K.2.2	0,15-0,22	0,20-0,28	0,21-0,30	0,32-0,45	0,32-0,45	0,35-0,50	0,35-0,50	○	●	○
K.3.1	0,14-0,20	0,17-0,24	0,20-0,28	0,25-0,35	0,28-0,40	0,32-0,45	0,32-0,45	○	●	○
K.3.2	0,14-0,20	0,17-0,24	0,20-0,28	0,25-0,35	0,28-0,40	0,32-0,45	0,32-0,45	○	●	○
N.1.1	0,18-0,25	0,21-0,30	0,35-0,50	0,35-0,50	0,42-0,60	0,49-0,70	0,49-0,70	●	○	○
N.1.2	0,18-0,25	0,21-0,30	0,35-0,50	0,35-0,50	0,42-0,60	0,49-0,70	0,49-0,70	●	○	○
N.2.1	0,18-0,25	0,21-0,30	0,35-0,50	0,35-0,50	0,42-0,60	0,49-0,70	0,49-0,70	●	○	○
N.2.2	0,18-0,25	0,21-0,30	0,35-0,50	0,35-0,50	0,42-0,60	0,49-0,70	0,49-0,70	●	○	○
N.2.3	0,18-0,25	0,21-0,30	0,35-0,50	0,35-0,50	0,42-0,60	0,49-0,70	0,49-0,70	●	○	○
N.3.1	0,18-0,25	0,21-0,30	0,35-0,50	0,35-0,50	0,42-0,60	0,49-0,70	0,49-0,70	●	○	○
N.3.2	0,18-0,25	0,21-0,30	0,35-0,50	0,35-0,50	0,42-0,60	0,49-0,70	0,49-0,70	●	○	○
N.3.3	0,18-0,25	0,21-0,30	0,35-0,50	0,35-0,50	0,42-0,60	0,49-0,70	0,49-0,70	●	○	○
N.4.1	0,18-0,25	0,21-0,30	0,35-0,50	0,35-0,50	0,42-0,60	0,49-0,70	0,49-0,70	●	○	○
S.1.1	0,08-0,12	0,08-0,12	0,08-0,12	0,10-0,14	0,13-0,18	0,14-0,20	0,14-0,20	●	○	○
S.1.2	0,07-0,10	0,07-0,10	0,07-0,10	0,08-0,11	0,10-0,14	0,11-0,16	0,11-0,16	●	○	○
S.2.1	0,08-0,12	0,08-0,12	0,08-0,12	0,10-0,14	0,13-0,18	0,14-0,20	0,14-0,20	●	○	○
S.2.2	0,07-0,10	0,07-0,10	0,07-0,10	0,08-0,11	0,13-0,18	0,11-0,16	0,11-0,16	●	○	○
S.2.3	0,07-0,10	0,07-0,10	0,07-0,10	0,08-0,11	0,10-0,14	0,11-0,16	0,11-0,16	●	○	○
S.3.1	0,08-0,12	0,08-0,12	0,08-0,12	0,10-0,14	0,13-0,18	0,14-0,20	0,14-0,20	●	○	○
S.3.2	0,08-0,12	0,08-0,12	0,08-0,12	0,10-0,14	0,13-0,18	0,14-0,20	0,14-0,20	●	○	○
S.3.3	0,07-0,10	0,07-0,10	0,07-0,10	0,08-0,11	0,13-0,18	0,11-0,16	0,11-0,16	●	○	○
H.1.1										
H.1.2										
H.1.3										
H.1.4										
H.2.1										
H.3.1										
O.1.1	0,11-0,16	0,11-0,16	0,11-0,16	0,14-0,20	0,14-0,20	0,14-0,20	0,14-0,20	○	●	○
O.1.2	0,11-0,16	0,11-0,16	0,11-0,16	0,14-0,20	0,14-0,20	0,14-0,20	0,14-0,20	○	●	○
O.2.1										
O.2.2	0,06-0,08	0,06-0,08	0,07-0,10	0,07-0,10	0,08-0,12	0,08-0,12	0,10-0,14		●	
O.3.1	0,06-0,08	0,06-0,08	0,07-0,10	0,07-0,10	0,09-0,12	0,08-0,12	0,10-0,14		●	

 → v_c Page 65+66 → n_{max} Page 72+74 → LTA Page 72+74
 The cutting data is significantly dependent on the external conditions, e.g. stability of the tool and workpiece clamping, material and machine type! The specified values represent guideline cutting data that can be adjusted within the range according to the usage conditions! It is essential to observe the v_c values of the type used, the maximum speeds of the system and the reduction of these maximum speeds depending on the type used overhang length (LTA).

Cutting data standard values for boring heads for roughing – SpinTools

Index	62 295 ...			● 1st choice		
	Twin rough boring head			○ suitable		
	Cutting depth $a_p = 2.5 - 7$ mm			Emulsion	Compressed air	MMS
	Ø 23,5–40,5	Ø 40,5–66,5	Ø 66,5–87,5			
f (mm/rev)						
P.1.1	0,3–0,4	0,4–0,5	0,5–0,7	●	○	
P.1.2	0,3–0,4	0,4–0,5	0,5–0,7	●	○	
P.1.3	0,3–0,4	0,4–0,5	0,5–0,7	●	○	
P.1.4	0,3–0,4	0,4–0,5	0,5–0,7	●	○	
P.1.5	0,3–0,4	0,4–0,5	0,5–0,7	●	○	
P.2.1	0,3–0,4	0,4–0,5	0,5–0,7	●	○	
P.2.2	0,3–0,4	0,4–0,5	0,5–0,7	●	○	
P.2.3	0,3–0,4	0,4–0,5	0,5–0,7	●	○	
P.2.4	0,3–0,4	0,4–0,5	0,5–0,7	●	○	
P.3.1	0,3–0,4	0,4–0,5	0,5–0,7	●	○	
P.3.2	0,3–0,4	0,4–0,5	0,5–0,7	●	○	
P.3.3	0,3–0,4	0,4–0,5	0,5–0,7	●	○	
P.4.1	0,3–0,4	0,4–0,5	0,5–0,7	●	○	
P.4.2	0,3–0,4	0,4–0,5	0,5–0,7	●	○	
M.1.1	0,3–0,4	0,4–0,5	0,5–0,7	●	○	
M.2.1	0,3–0,4	0,4–0,5	0,5–0,7	●	○	
M.3.1	0,3–0,4	0,4–0,5	0,5–0,7	●	○	
K.1.1	0,3–0,4	0,4–0,5	0,5–0,7	○	●	
K.1.2	0,3–0,4	0,4–0,5	0,5–0,7	○	●	
K.2.1	0,3–0,4	0,4–0,5	0,5–0,7	○	●	
K.2.2	0,3–0,4	0,4–0,5	0,5–0,7	○	●	
K.3.1	0,3–0,4	0,4–0,5	0,5–0,7	○	●	
K.3.2	0,3–0,4	0,4–0,5	0,5–0,7	○	●	
N.1.1	0,3–0,4	0,4–0,5	0,5–0,7	●	○	
N.1.2	0,3–0,4	0,4–0,5	0,5–0,7	●	○	
N.2.1	0,3–0,4	0,4–0,5	0,5–0,7	●	○	
N.2.2	0,3–0,4	0,4–0,5	0,5–0,7	●	○	
N.2.3	0,3–0,4	0,4–0,5	0,5–0,7	●	○	
N.3.1	0,3–0,4	0,4–0,5	0,5–0,7	●	○	
N.3.2	0,3–0,4	0,4–0,5	0,5–0,7	●	○	
N.3.3	0,3–0,4	0,4–0,5	0,5–0,7	●	○	
N.4.1	0,3–0,4	0,4–0,5	0,5–0,7	●	○	
S.1.1	0,3–0,4	0,4–0,5	0,5–0,7	●	○	
S.1.2	0,3–0,4	0,4–0,5	0,5–0,7	●	○	
S.2.1	0,3–0,4	0,4–0,5	0,5–0,7	●	○	
S.2.2	0,3–0,4	0,4–0,5	0,5–0,7	●	○	
S.2.3	0,3–0,4	0,4–0,5	0,5–0,7	●	○	
S.3.1	0,3–0,4	0,4–0,5	0,5–0,7	●	○	
S.3.2	0,3–0,4	0,4–0,5	0,5–0,7	●	○	
S.3.3	0,3–0,4	0,4–0,5	0,5–0,7	●	○	
H.1.1	0,3–0,4	0,4–0,5	0,5–0,7	○	●	
H.1.2	0,3–0,4	0,4–0,5	0,5–0,7	○	●	
H.1.3	0,3–0,4	0,4–0,5	0,5–0,7	○	●	
H.1.4						
H.2.1	0,3–0,4	0,4–0,5	0,5–0,7	○	●	
H.3.1	0,3–0,4	0,4–0,5	0,5–0,7	○	●	
O.1.1	0,3–0,4	0,4–0,5	0,5–0,7	○	●	
O.1.2	0,3–0,4	0,4–0,5	0,5–0,7	○	●	
O.2.1	0,3–0,4	0,4–0,5	0,5–0,7	○	●	
O.2.2	0,3–0,4	0,4–0,5	0,5–0,7		●	
O.3.1	0,3–0,4	0,4–0,5	0,5–0,7		●	

5



 → v_c Page 65+66 → n_{max} Page 72+74 → LTA Page 72+74
 The cutting data is significantly dependent on the external conditions, e.g. stability of the tool and workpiece clamping, material and machine type! The specified values represent guideline cutting data that can be adjusted within the range according to the usage conditions! It is essential to observe the v_c values of the type used, the maximum speeds of the system and the reduction of these maximum speeds depending on the type used overhang length (LTA).

Fine boring tools

Maximum speed

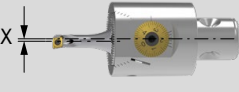
System / tool		Boring range	Maximum speed in slide centre position
		Ø (mm)	n_{max} in 1/min
	62 820 ... , 62 840 ... BluFlex 2	0,5–365	20.000
	62 800 ... hi.flex	0,5–365	17.500
	62 800 06089 hi.flex micro	0,5–60	30.000
	62 386 ... , 62 382 ... Micro Boring Head	0,3–19,1	30.000
	62 815 ... M03 Speed	24–39	40.000
		38–50	31.000
		49–63	24.000
		62–80	18.500
		79–103	15.000
		100–130	11.500
		128–168	10.000
	62 810 ... FF precision adjustment head	29,5–42	25.000
		39–50	18.000
		47–66	12.000
		58–83	9.000
		79–108	6.000
		100–141	4.000
		138–179	3.500
		178–199	3.000
	62 372 ... , 62 373 ... Multi-Head boring and fine boring head with bridge	88–164	900
		164–320	250
	62 305 ... Single point finish boring head with insert holder	86–138	1.150
		136–220	720
		188–302	520
		242–402	400

System / tool		Offset	
	Boring range	$X \leq 0,5 \text{ mm}$	$X > 0,5 \text{ mm}$
		Maximum speed n_{max} in 1/min	
Ø (mm)			
62 372 ... , 62 373 ... Multi-Head boring and fine boring head with boring bar	3–20	16.000	6.000
	20–48	12.000	4.000
62 326 ... , 62 332 ... , 62 333 ... , 62 363 ... Single point boring head with boring bar	48–88	8.000	2.000

System / tool		Unbalanced	Balanced
	Boring range	Maximum speed n_{max} in 1/min	
	Ø (mm)		
62 308 ... , 62 303 ... Single point finish boring head with insert holder	24–31	9.000	12.000
	31–40	7.500	10.000
	40–51	5.250	8.000
	51–67	4.000	6.500
	67–87	3.000	5.000
	87–116	2.500	4.000
	116–153	1.750	3.000

Selection of the maximum speed depending on the overhang length (LTA)

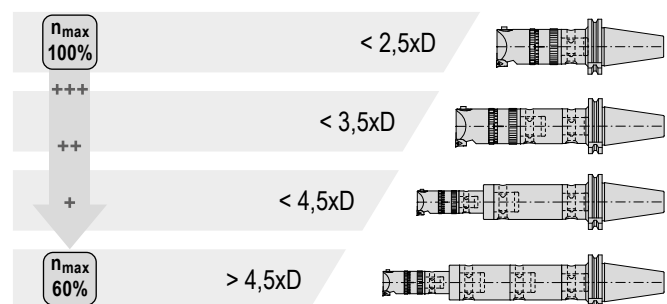

Scale accuracy

Large scale with 0.002 mm adjustment

How it works:

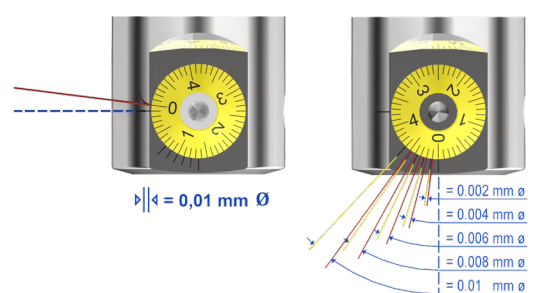

Fine boring tools

Maximum overhang length LTA at 35 mm shank clamping depth

LTA (mm)	High-speed boring head 62 361 ...																Fine boring head 62 304 ...			Boring bar 62 353 ...	
	014	015	016	017	018	019	020	021	022	023	025	027	030	033	037	040	017	020	024		
	56																				008
63																					009
70																					010
77																					011
84																					012
91																					013
98																					014
98																					016
112																					018
112																					118
112																					218
112																					
115																					
125																					
105																					
145																					
185																					

Selection of the cutting radius depending on the overhang length (LTA)

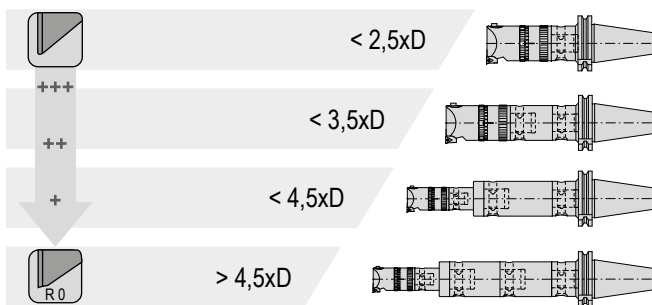

Selection of the cutting radius depending on the cutting depth a_p

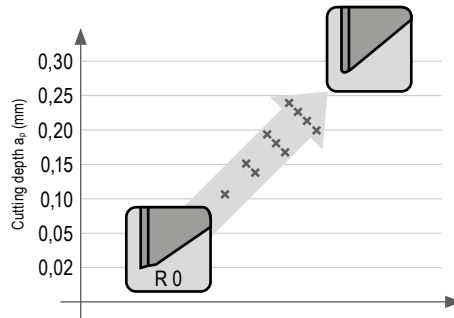

Influence of the cutting forces of the cutting edge radius on internal machining

Resulting force

$$F_{res} = \sqrt{F_a^2 + F_p^2} = \sqrt{F_c^2 + F_f^2 + F_p^2}$$

Tangential cutting force (F_c)

- ▲ pushes the tool down from the vertical central axis
- ▲ is influenced by the cutting depth and the chip thickness
- ▲ reduces the clearance angle

Passive cutting force (F_p)

- ▲ pushes the tool away from the horizontal central axis
- ▲ increases the risk of vibrations and causes dimensional inaccuracies

Feed force (F_f)

- ▲ acts in the machining direction of the tool

Active cutting force (F_a)

- ▲ determined by F_c and F_f

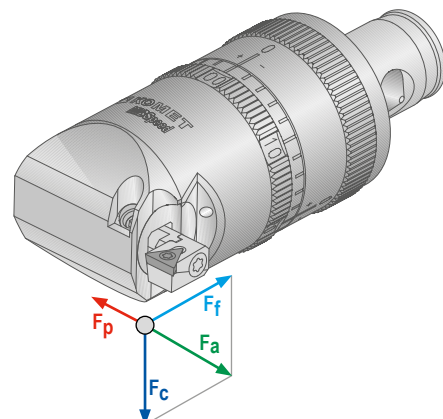
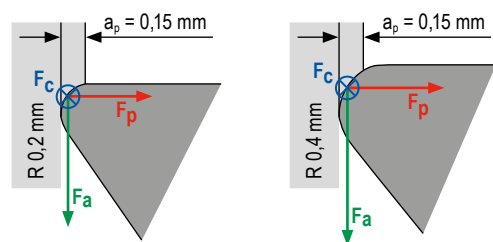

Counterboring tools

Maximum speed

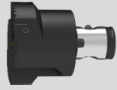
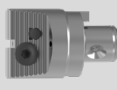
System / tool		Boring range	Maximum speed
		Ø (mm)	n _{max} in 1/min
	62 870 ... TwinKom	24–31	12.000
		31–40	10.000
		40–51	8.000
		51–68	6.500
	62 295 ... Twin rough boring head	67–87	5.000
		87–116	4.000
		116–153	3.000
		153–215	2.200

Selection of the maximum speed

depending on the overhang length (LTA)



TwinKom applications

in pre-cast / premachined holes

Roughing as a "true" two-edged cutter

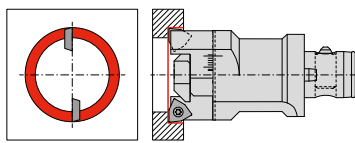

Axial adjustment required

Roughing with large allowance

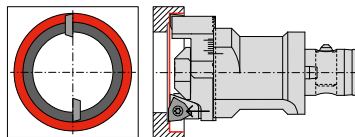

Roughing with large offset

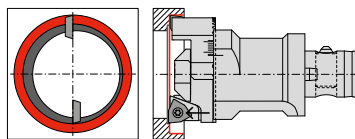

Roughing / Semi-Finishing

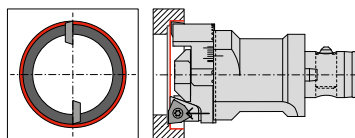

Cut distribution calculation

Example:
D2 (finished Ø) = 100 mm,
D1 (raw Ø) = 80 mm,
S (offset) = 3 mm

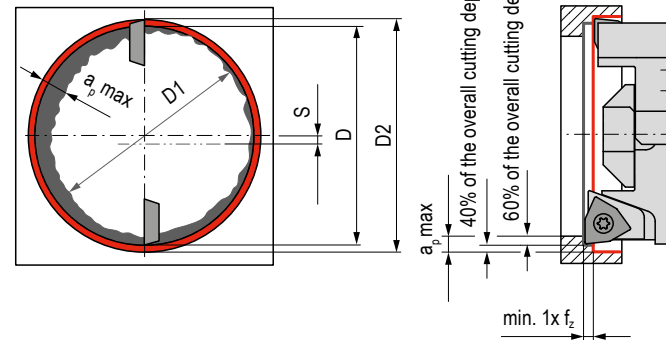

Calculation formula

$$D = D2 - \left[\frac{D2 - D1}{2} + S \right] \times 0,8$$

$$D = 100 - \left[\frac{100 - 80}{2} + 3 \right] \times 0,8 = 89,6 \text{ mm}$$

Feed rate guide values for surface finish quality

Roughness range R _z in µm	R _{th}	Corresponds to R _s	Roughness index	ISO 1302	Corner radius RE in mm and feed f in mm/rev						
					RE = 0,1	RE = 0,2	RE = 0,4	RE = 0,8	RE = 1,2	RE = 1,6	RE = 2,4
63–100	$\sqrt{R_{th63}}$	12,5–25	N11	$\frac{25}{\nabla}$	0,22*	0,32*	0,45*	0,63	0,78	0,9	1,1
40–63	$\sqrt{R_{th40}}$	6,3–12,5	N10	$\frac{12,5}{\nabla}$	0,18*	0,25*	0,36	0,51	0,62	0,72	0,88
31,5–40	$\sqrt{R_{th31,5}}$	4,9–6,3	N9	$\frac{6,3}{\nabla}$	0,16*	0,22*	0,32	0,45	0,55	0,63	0,78
25–31,5	$\sqrt{R_{th25}}$	4,0–4,9			0,14*	0,2*	0,28	0,4	0,49	0,57	0,69
16–25	$\sqrt{R_{th16}}$	2,5–4,0	N8	$\frac{3,2}{\nabla}$	0,11*	0,16	0,23	0,32	0,39	0,45	0,55
10–16	$\sqrt{R_{th10}}$	1,6–2,5			0,09	0,13	0,18	0,25	0,31	0,36	0,44
6,3–10	$\sqrt{R_{th6,3}}$	1,0–1,6	N7	$\frac{1,6}{\nabla}$	0,07	0,1	0,14	0,2	0,25	0,28	0,35
4–6,3	$\sqrt{R_{th4}}$	0,8–1,0			0,06	0,08	0,11	0,16	0,2	0,23	0,28
2,5–4	$\sqrt{R_{th2,5}}$	0,4–0,8	N5	$\frac{0,4}{\nabla}$	0,04	0,06	0,09	0,13	0,15	0,18	0,22
1,6–2,5	$\sqrt{R_{th1,6}}$	0,2–0,4			0,04	0,05	0,07	0,1	0,12	0,14	0,18
1–1,6	$\sqrt{R_{th1}}$	0,1–0,2	N3	$\frac{0,1}{\nabla}$	0,03	0,04	0,06	0,08	0,1	0,11	0,14







*Please ensure that the feed rate values used do not exceed the corner radius (RE).

 The feed rate values shown are recommended values and are based on purely theoretical calculations using the above-mentioned formula. These may however deviate in practice.

Insert

Selection of the rake angle

Recommendations for the usage of indexable inserts with ground chip breakers

	rounded 	Sharp 	chamfered 
	P	P	P
	M	M	M
	K	K	K
	N	N	N
	S	S	S
	H	H	H
	P	P	P
	M	M	M
	K	K	K
	N	N	N
	S	S	S
	H	H	H
	P	P	P
	M	M	M
	K	K	K
	N	N	N
	S	S	S
	H	H	H
	P	P	P
	M	M	M
	K	K	K
	N	N	N
	S	S	S
	H	H	H





 → Page 79
Here you will find a detailed chip groove description.

Number key

for MicroKom indexable inserts

W	2	9	2	4	0	1	0	.	0	4	8	4	2	5
	2	3	4	5	6	7	8		9	10	11	12	13	14

2-3 Type / shape

00	W...		84°	Regular version, periphery ground
29	W...		84°	Reinforced version
30	T...		60°	Periphery ground, clearance angle 8°
57	T...		60°	Periphery ground, clearance angle 11°
80	S...		90°	Periphery sintered

4-5 Size / IC

04	4,0 mm	18	6,2 mm 6,35 mm	28	8,9 mm	42	12,0 mm
10	4,8 mm 5,0 mm	20	7,0 mm 7,1 mm	32	9,52 mm 9,8 mm	46	13,2 mm
12	5,5 mm	24	8,0 mm	34	10,0 mm	50	15,0 mm
14	5,6 mm	26	8,2 mm	38	10,9 mm 11,1 mm	58	17,6 mm

6-7 Topography

Ground code

06	Left-hand cutting, 6°
12	Left-hand cutting, 12°
34	High-feed geometry, chamfered and rounded

Sintered code

01	Double grooves, cutting edge chamfered and rounded
02	Stepped geometry, cutting edge chamfered and rounded
03	Calotte geometry, cutting edge rounded
11	20° chip former, cutting edge rounded
12	Alu / finishing geometry
13	Shaft geometry, cutting edge rounded
14	Finishing topography
15	Semi-finishing topography
18	Finishing topography with wiper corner
32	Burr-minimised, periphery ground
33	Burr-minimised, periphery sintered

9-10 Corner radius

01	R 0,1	04	R 0,4
02	R 0,2	06	R 0,6
03	R 0,3	08	R 0,8

11-14 Grade

→ Page 80+81
Here you will find the detailed grade description.

Notes on drilling technology – TwinKom

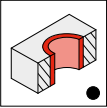
1.  Counterboring a through hole
▲ Possible without any problems

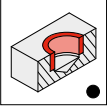
2.  Counterboring a blind hole
▲ Possible without any problems

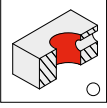
3.  Drilling through a transverse hole
▲ Reduce feed by up to 50%, if necessary
▲ Check for chip jamming on the periphery of the tool
▲ Use tough indexable inserts
▲ Use stable corner radius

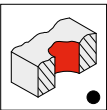
4.  Spot drilling uneven surfaces (casting surfaces)
▲ Feed must reduce by up to 40% when spot drilling
▲ Use tough indexable inserts
▲ Use stable corner radius

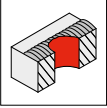
5.  Spot drilling a seam (forging/welding/casting seam)
▲ Reduce feed
▲ Use max. 3xD tools

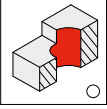
6.  Spot drilling an edge
▲ Reduce feed to 50%
▲ Use tough indexable inserts
▲ Use stable corner radius

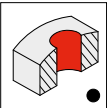
7.  Spot drilling convex surfaces
▲ Possible without any problems
▲ If necessary, reduce feed

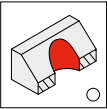
8.  Spot drilling angled surfaces
▲ From the interrupted cut, reduce the feed by up to 50%
▲ Use tough indexable inserts
▲ Use stable corner radius

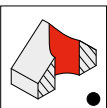
9.  Spot drilling a pointed contour
▲ Reduce the feed by up to 40% in the area where cutting is interrupted

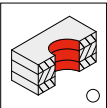
10.  Stack plate drilling
▲ Use holder with 80° positioning
▲ Good workpiece clamping required
▲ Max. gap size = 1 mm

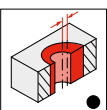
11.  Large hole offset
▲ Possible without any problems
▲ Axial-radial cut distribution, see graphic: Cut distribution

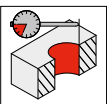
12.  Adjustable in diameter
▲ Possible without any problems

Problems / possible causes / solutions – Counterboring and fine boring

1. No chip breakage

- ▲ Cutting depth a_p too low for cutting edge topography used → If necessary, increase the cutting depth a_p
→ Use cutting edge topography for small to medium cutting depths
- ▲ Cutting depth a_p too big for cutting edge topography used → Reduce cutting depth a_p
→ Axial-radial cut distribution
→ Use cutting edge topography for larger cutting depths
- ▲ Feed/tooth too low → Increase feed/tooth
- ▲ RPM too high → Reduce RPM
- ▲ Cutting edges not same length axially → Correct axial offset: Use holder with axial length compensation

2. Chip jamming

- ▲ Unfavourable chip shape → Increase feed
→ Use cutting edge topography with chip breaker
→ Axial-radial cut distribution
→ See measures: 1. No chip breakage
- ▲ Workpiece clamping → In the case of through holes, check there is sufficient space for pecking behind the component
- ▲ Cooling lubricant pressure/quantity too low → Improve cooling lubricant pressure/quantity

3. Conical hole

- See measures: 1. No chip breakage

4. Poor surface quality

- ▲ Feed too high → Reduce feed
- ▲ Cutting speed too low → Increase cutting speed
- ▲ Cutting radius too small → Use indexable insert with a larger cutting radius
→ Use indexable insert with wiper geometry
- ▲ Rake angle of the indexable insert too small → Use indexable insert with positive cutting edge geometry
- ▲ Built-up edge → Use indexable insert with positive cutting edge geometry
→ Use indexable insert with wider chip breaker groove
- ▲ Unfavourable chip shape → See measures: 1. No chip breakage
→ See measures: 2. Chip jam

5. Vibration

- ▲ Tool design – high L/D ratio → If necessary, check tool design
→ If possible, consistently avoid the same boring bar \emptyset
→ If possible, stepped tool design; design tool to be as stable as possible
→ Check axial-radial cutting settings
→ Use vibration-optimised boring bar, if necessary
→ Use HMD damping element, if necessary
- ▲ Feed too high → Reduce feed
- ▲ Cutting speed too high → Reduce cutting speed,
see graphic: Selection of the cutting speed depending on the overhang length
- ▲ Depth of cut too big → Reduce depth of cut
→ Axial-radial cut distribution
- ▲ Cutting edge geometry too blunt → Use indexable insert with positive cutting edge geometry
→ Use indexable insert with wider chip breaker groove
- ▲ Cutting radius too big → Use indexable insert with a smaller cutting radius,
see graphic: Selection of the cutting radius depending on the overhang length and the depth of cut

Types of wear

Wear on clearance face



Abrasion on the flank: normal wear after a certain period of operation.

Cause

- ▲ Cutting speed too high
- ▲ Carbide grade does not have enough wear resistance
- ▲ Feed not adapted to application

Remedy

- ▲ Reduce cutting speed
- ▲ Select a carbide grade with high wear resistance
- ▲ Bring feed into the right relationship with cutting speed and cutting depth

Edge chipping

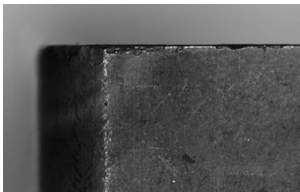

Increased mechanical stress on the cutting edge may result in carbide particles breaking off.

Cause

- ▲ Grade with too high a wear resistance
- ▲ Vibrations on tool or workpiece
- ▲ Feed rate or cutting depth is too high
- ▲ Built-up edge
- ▲ Interrupted cut
- ▲ Chip stroke

Remedy

- ▲ Use tougher grade
- ▲ Improve stability (tool, workpiece)
- ▲ Avoid built-up edges

Cratering



The outgoing hot chip is causing cratering of the cutting insert on the clamping surface.

Cause

- ▲ Cutting speed too high, feed too high
- ▲ Rake angle too low
- ▲ Grade does not have enough wear resistance
- ▲ Incorrectly supplied coolant

Remedy

- ▲ Reduce cutting speed and/or feed rate
- ▲ Choose carbide grades with greater wear-resistance
- ▲ Increase quantity and/or pressure of coolant, check supply
- ▲ Use a more crater-resistant grade

Plastic deformation

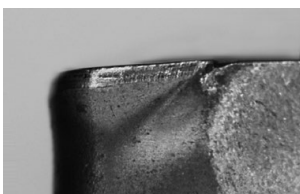

High machining temperature with simultaneous mechanical stress can lead to plastic deformation.

Cause

- ▲ Working temperature too high, softening of the base material
- ▲ Damage to the coating
- ▲ Grade does not have enough wear resistance
- ▲ Incorrectly supplied coolant

Remedy

- ▲ Reduce cutting speed
- ▲ Select more wear-resistant, more thermally stable carbide grade
- ▲ Make provisions for cooling / check supply

Built-up edge

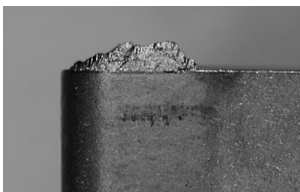

Material builds up on the cutting edge if the chip does not flow correctly due to the cutting temperature being too low.

Cause

- ▲ Cutting speed too low
- ▲ Rake angle too small
- ▲ Incorrect cutting material
- ▲ Missing coolant/lubrication

Remedy

- ▲ Increase cutting speed
- ▲ Increase rake angle
- ▲ Use TiN coating
- ▲ Make provisions for cooling / increase oil content of emulsion

Insert breakage

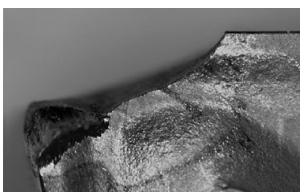

If a cutting insert is overloaded, insert breakage may occur.

Cause

- ▲ Cutting material overloaded (extreme values)
- ▲ Lack of stability
- ▲ Wedge angle too small
- ▲ Interference contours were not taken into account
- ▲ Interrupted cut

Remedy

- ▲ Use a tougher cutting material
- ▲ Use chamfer for edge protection
- ▲ Increase rounding of cutting edge
- ▲ Use more stable geometry
- ▲ Check cutting data
- ▲ Check interference contours

Chip breakers

-SF14	<ul style="list-style-type: none"> ▲ Rake angle 14° ▲ Specially developed chip breakers with remarkable chip control for a range of applications, from fine finishing to medium machining 	-11	<ul style="list-style-type: none"> ▲ Rake angle 20° ▲ Highly positive, minimally rounded chip breaker ▲ For soft cutting use ▲ Main application in aluminum
-SF15	<ul style="list-style-type: none"> ▲ Rake angle 15° ▲ Balanced geometry: high stability with high cutting edge sharpness ▲ Excellent chip control with minimum susceptibility to built-up edge formation ▲ Particularly good chip breakage with small and medium feeds ▲ Initial recommendation for machining C-steel, alloyed and stainless steels 	-12	<ul style="list-style-type: none"> ▲ Rake angle 30° ▲ Peripheral ground indexable insert with pressed chip breaker ▲ Highly positive, sharp and all-round cutting edge, therefore extremely smooth-cutting ▲ Peripheral ground flanks guarantee controlled chip formation and best surface quality at low cutting forces
-SF16	<ul style="list-style-type: none"> ▲ Rake angle 15° ▲ Balanced geometry: High stability for high cutting edge sharpness ▲ Large chip chamber, therefore good chip control at low feeds ▲ Initial recommendation for machining C-steel, alloyed and stainless steels 	-14	<ul style="list-style-type: none"> ▲ Rake angle 14° ▲ Peripheral ground, sintered topography ▲ Controlled chip formation in fine and extremely fine machining
-SF20	<ul style="list-style-type: none"> ▲ Rake angle 20° ▲ Particularly smooth cutting thanks to the extremely positive rake angle ▲ Excellent chip control with minimum susceptibility to built-up edge formation ▲ Perfect cutting performance thanks to the extremely positive rake angle, particularly with low depths of cut and feeds ▲ Initial recommendation for machining stainless steel, alloy steels, carbon steel and non-ferrous metals 	-15	<ul style="list-style-type: none"> ▲ Rake angle 15° ▲ Semi-finishing chip breaker; peripheral ground, sintered ▲ Controlled chip formation in fine and extremely fine machining
-SF30	<ul style="list-style-type: none"> ▲ Rake angle 15° ▲ Balanced geometry: High stability for high cutting edge sharpness ▲ Chip breaker geometry: Very good chip breakage for small and medium feeds ▲ Initial recommendation for machining C-steel, alloyed and stainless steels 	-18	<ul style="list-style-type: none"> ▲ Rake angle 14° ▲ Peripheral ground and sintered topography ▲ Controlled chip formation in fine and extremely fine machining ▲ Positive wiper geometry for maximum demands on surface quality
-01	<ul style="list-style-type: none"> ▲ Rake angle 12° ▲ All-round topography chamfered, rounded ▲ Very smooth-cutting thanks to positive cutting edge geometry ▲ Also suitable for less-powerful machines and unstable workpieces ▲ Easily controllable chip formation also in less solid materials 	-G06	<ul style="list-style-type: none"> ▲ Rake angle 6° ▲ For P / M / K materials ▲ High stability due to significant wedge angle
-02	<ul style="list-style-type: none"> ▲ Rake angle 0° ▲ Roughing topography, extremely stable (significant wedge angle) ▲ Excellent chip formation for chips that are difficult to control ▲ Only suitable for small cutting depths < 1.5 mm under certain circumstances 	-G12	<ul style="list-style-type: none"> ▲ Rake angle 12° ▲ For P / N / S materials ▲ Extremely smooth-cutting thanks to positive cutting edge geometry ▲ Extremely suitable for less-powerful machines and unstable workpieces ▲ Easily controllable chip formation also in less solid materials

Type

K10

- ▲ Carbide, uncoated
- ▲ ISO | **K10**
- ▲ Uncoated carbide grade for machining grey cast iron or non-ferrous metals, depending on the cutting edge geometry

BK7615

- ▲ Carbide, TiCN-Al₂O₃-coated
- ▲ ISO | **K15**
- ▲ Highly productive grade with extreme edge stability for wet and dry machining of all cast iron materials

BK2710

- ▲ Carbide, TiAlN-coated
- ▲ ISO | P10 | M10 | **K10**
- ▲ Extremely wear-resistant carbide grade for machining stainless steels, structural steels and tool steels as well as cast iron materials

BK77

- ▲ Carbide, TiN-coated
- ▲ ISO | **S10** | H10 | O10
- ▲ The wear-resistant carbide grade for machining aluminum alloys, superalloys and plastics at medium cutting speeds

BK60

- ▲ Carbide, TiC-TiCN-TiN-coated
- ▲ ISO | P25 | **M10**
- ▲ Multi-layer coating for long service life even in the upper cutting speed range

BK7710

- ▲ Carbide, TiB₂-coated
- ▲ ISO | **N10** | S10 | O10
- ▲ The wear-resistant grade with optimum cutting characteristics to prevent built-up edge formation for machining aluminium and titanium alloys

BK6110

- ▲ Carbide, TiCN-TiN-Al₂O₃-coated
- ▲ ISO | P10 | **K10**
- ▲ Wear-resistant carbide grade for machining cast iron and steel materials

BK7935

- ▲ Carbide, AlTiN-coated
- ▲ ISO | **P35** | **M30** | **K30** | N30 | **S30** | O30
- ▲ The tough carbide grade for machining stainless steel and acid-resistant steels as well as special alloys

BK6115

- ▲ Carbide, TiCN-TiN-Al₂O₃-coated
- ▲ ISO | **P20** | **K20** | H20
- ▲ High-quality, surface-treated coating for machining cast iron materials in normal to stable conditions and at high cutting speeds

BK8425

- ▲ Carbide, TiAlN/TiN-coated
- ▲ ISO | **P25** | **M25** | **K25**
- ▲ Universal grade with greater wear resistance thanks to innovative PVD multi-layer coating

BK6440

- ▲ Carbide, CVD-TiCN-Al₂O₃-TiN coated
- ▲ ISO | **M25** | **K35**
- ▲ Extremely tough standard grain grade; good wear resistance in steel and stainless steel materials, even in unfavourable cutting conditions / interrupted cut

BK8430

- ▲ Carbide, TiAlN/TiN-coated
- ▲ ISO | **P25** | **M25**
- ▲ Fine-grain grade with high wear resistance
- ▲ Extreme edge stability and maximum wear resistance in the middle and top speed range

BK8440

- ▲ Carbide, TiCN-TiN-coated
- ▲ ISO | **P35** | M10
- ▲ Very tough carbide grade for medium cutting speeds and interrupted cut

Type

CBN40	<ul style="list-style-type: none"> ▲ Cubic boron nitride, uncoated ▲ ISO H05 ▲ Uncoated cutting material made of cubic boron nitride for machining hardened steels over 45 HRC, heat-resistant nickel-based or cobalt-based alloys 	CWC06	<ul style="list-style-type: none"> ▲ Cermet, TiC/TiN-coated ▲ ISO P10 M10 K10 N10 ▲ Coated cermet grade for fine boring at high cutting speed and with a uniform cut
CK32	<ul style="list-style-type: none"> ▲ Cermet, uncoated ▲ ISO P10 M15 K05 N15 ▲ For fine and finish turning ▲ Less wear and greater cutting speed result in longer tool life and high surface quality ▲ Cutting material for high productivity in the top cutting speed range 	CWC10	<ul style="list-style-type: none"> ▲ Cermet, uncoated ▲ ISO P15 M10 K10 ▲ The uncoated cermet grade for finish machining of stainless and hardened steel ▲ Particularly wear-resistant due to high heat resistance
CK3230	<ul style="list-style-type: none"> ▲ Cermet, uncoated ▲ ISO P20 M20 K10 N20 ▲ Extremely tough behaviour with good wear resistance suitable for use also in interrupted cut 	CWN10	<ul style="list-style-type: none"> ▲ Carbide, TiN-coated ▲ ISO K10 ▲ The carbide grade for machining steels, stainless steels and non-ferrous metals
CTDPU20	<ul style="list-style-type: none"> ▲ Polycrystalline diamond cutting material with mixed grain, uncoated ▲ ISO N15 ▲ Outstanding wear resistance, even where Si content > 12 % and high proportion of abrasive reinforcements ▲ Used in plastics and fibre composites (GFK, CFK) 	CWP25	<ul style="list-style-type: none"> ▲ Carbide, uncoated ▲ ISO P25 M25 K25 N25 S25 ▲ Uncoated carbide grade for fine boring with large hole depths and small machining allowances

5

Coatings

TiN	<ul style="list-style-type: none"> ▲ TiN coating ▲ Maximum application temperature: 450 °C
-----	--