



Discover now!
The eCatalogue 2023
cutting.tools/en/int/ecatalogue



PRODUCT PORTFOLIO – INSIGHTS

Everything between machine spindle
and machine table

CERATIZIT is a high-technology engineering group specialised in cutting tools and hard material solutions.

Tooling a Sustainable Future

ceratizit.com



CERATIZIT
GROUP

Tooling a Sustainable Future

CERATIZIT: Your specialist for sustainable cutting tools and hard material solutions.

Are you looking for a reliable partner for your tooling and steel machining needs? CERATIZIT is not just a tool supplier, but a team of experts ready to support you with decades of experience and extensive industry knowledge.

Plus we are a sustainability-conscious partner dedicated to keeping your CO2 balance in check with a concrete strategy and mission to become sustainability leader in our industry.

For more than 100 years, CERATIZIT has been a pioneer in the field of ambitious hard-material solutions for machining and protection against wear. Therefore, we can promise unrivaled quality to our customers and provide them with the latest developments in the carbide sector. We are your cutting tools experts with everything from a single source.



Get in touch!



Maximum simplicity

One-click orders in the online shop

Search for products in the e-catalogue and add them to your basket with a single click or order them as usual from the shop at <http://cuttingtools.ceratizit.com>.



Sustainability is not a goal, it's a mission

Together for sustainability

Leading in sustainability by 2025

Our mission is just as clear as it is difficult to accomplish. By 2025, we aim to be the sustainability leader for the hard metals and cutting tool industry. To meet this ambitious objective and become truly sustainable, we are implementing an array of sustainability measures along the entire value chain. However, we're not just keeping our sustainability ethos in-house, it will help set new standards for cooperating with partners moving forward.



Climate neutral by 2025

We recognise our responsibility to be good stewards to the climate and are going to great lengths to keep our carbon footprint to a minimum. The United Nations' Sustainable Development Goals aim to achieve net-zero carbon emissions by 2050. We think we can do better and are striving to be net-zero by 2040.

- ▲ **By 2025:** Carbon neutral, emissions reduced by 35%
- ▲ **By 2030:** Combined reduction of 60%
- ▲ **By 2040:** Net zero, emissions reduced by 75%



Minimise the use of virgin raw materials

To reduce the mining of virgin raw materials, our goal is to increase the share of raw materials remaining in the carbide production chain to over 95% by 2030 (based on scrap recycling rates of sintered products).

Read more about our sustainability approach on our website:

<https://cutting.tools/int/en/sustainability>

A man with a full red beard and hair, wearing a grey polo shirt, is working in a factory. He is holding a metal part with a tool, possibly a screwdriver or a small wrench, and is focused on his work. In the background, there is a large industrial machine, likely a lathe or a mill. On a table in the foreground, there are several other metal parts, including a large cylindrical one and a smaller one with a flange. The overall scene is industrial and professional.

**JUST
OUR
THING**

An extensive selection of high-quality products.

Complex components for precise machining
CERATIZIT's portfolio of high-quality tools

- ▲ 65,000 high-quality tools exclusively for machining
- ▲ Extensive range covering everything from the spindle to the machine table
- ▲ Innovation guaranteed: 30% of our products are less than 5 years old
- ▲ The right tooling solution for every machining challenge:
standard, semi-standard and special solutions

The benefits at a glance: longer service lives, increased process security and enormous potential to make cost savings.

The machining solution

All your machining needs – from a single source

As your leader in steel machining, we:

- ▲ Offer customers a holistic machining solution
- ▲ Support customers as a reliable partner
- ▲ Provide the high-quality tools available whenever you need them



Specialists on hand to help With a solution at the ready-always.

Working together to achieve the best result

- ▲ Application engineers on site
- ▲ Project teams with experience in developing innovative tool solutions
- ▲ Global network of experts with specialist knowledge in machining and the digital sector

A man with grey hair and a beard, wearing a white shirt with a logo, is smiling and looking towards the camera while working on a CNC machine. The machine is a complex industrial tool with a large white protective enclosure. The background is a clean, industrial setting. The image is overlaid with large, semi-transparent geometric shapes in red and grey.

**JUST
OUR
THING**



Order today. Delivered tomorrow.

Where's your order? On the way to you straight away.

- ▲ No minimum order
- ▲ Order via the customer service centre
- ▲ Order around the clock in the online shop
- ▲ Order tracking
- ▲ 99% availability thanks to state-of-the-art logistics processes



GENAU UNSER DING

ToolScope

Tool & process monitoring: ToolScope

The monitoring and control system constantly records and visualises the machine signals during the manufacturing process.

cutting.tools/int/toolscope

Cockpit

Optimal use of your digital production data with Cockpit.

Significantly reduce the time needed to record data, identify problems and troubleshoot to increase overall efficiency of your manufacturing processes.

cutting.tools/int/cockpit



Tool Supply

Tailor-made solutions for procuring tools

Is establishing a smooth tool procurement process just too complex or time-consuming for your resources? Then let us do it for you! We take on the entire procurement and storage process; all you need to do is define the products and access rights. We also help you to identify what you need, choose the right system and perform the installation.

What are the advantages for you?

- ▲ Stock management based on your individual needs
- ▲ Tool procurement that's simplified and effective
- ▲ Always have the right tool at the right time – a critical factor in your success.

cutting.tools/in/en/tool-supply

CERATIZIT CUTTING TOOL SOLUTIONS

The CERATIZIT Cutting Tool Solutions Team presents the new tool catalogue with around 65,000 machining tools.

Whether turning, drilling, milling, grooving, boring, threading or clamping workpieces or tools, we offer a wide selection of innovative, state-of-the-art products for every area of application – with 99% delivery availability.



New developments and product enhancements come out every three months in our **UP2DATE** supplementary catalogue.

		PAGE
Solid drilling and bore machining	1 HSS drills	19
	2 Solid carbide drills	20–23
	3 Indexable insert drills	24+25
	4 Reamers and countersinks	26+27
	5 Spindle tools	28+29
Threading	6 Taps and thread formers	32+33
	7 Circular and thread milling cutters	34+35
	8 Thread turning tools	36+37





Turning

9	Indexable insert turning tools	40–42
10	Multifunction tools – EcoCut and FreeTurn	43
11	Grooving tools	44+45
12	Miniature turning tools	46
	Sliding head tools	47



Milling

13	HSS milling cutters	51
14	Solid carbide milling cutters	52–54
14	Exchangeable head systems	55
15	Milling tools with indexable inserts	56–59



Adapters

16	Rotating adapters	62–64
16	Static adapters	65



Workpiece clamping

	SoloClamp – single vice	68
	CentriClamp – centric vice	69
	PolyClamp – multiple vice	70
	Clamping variants	71

\ DRILLING TOOLS

THE EXPERTS IN EFFICIENT SOLID DRILLING AND BORE MACHINING



HSS drills



Reamers and
countersinks



Indexable insert
drilling tools



Solid carbide
drills



Spindle tools

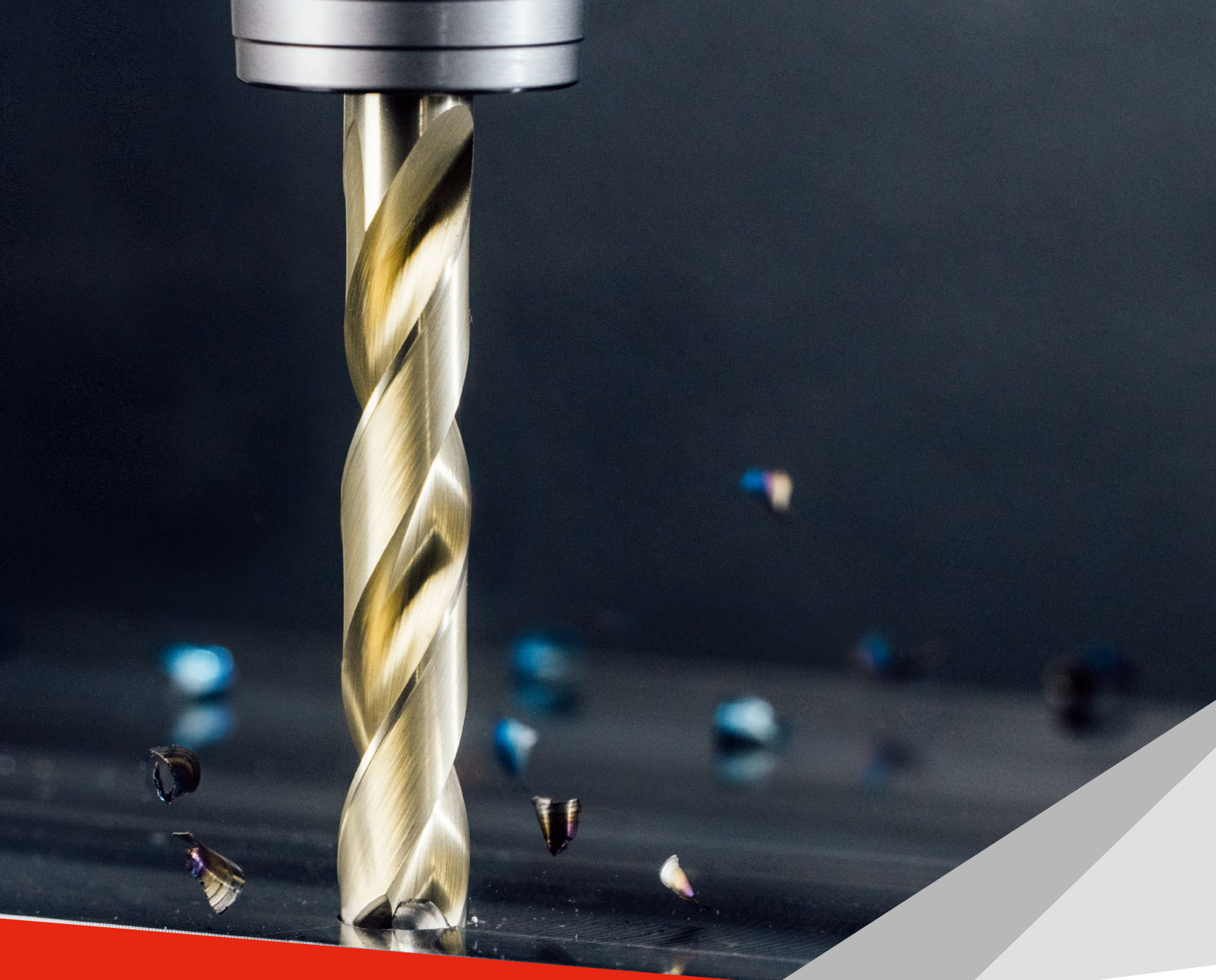

High-precision drilling, reaming, countersinking and boring is our speciality. With a diverse range of drilling tools and our in-depth knowledge of bore machining, we always have the perfect solution for your requirements.



HSS drills

Our range of HSS drilling tools leaves no user without options. We stock twist drills with diameters from 0.15 mm, centre drilling, stepped drilling and counterboring tools with different coatings for universal application in all common lengths and diameter ratios.

HSS-E-PM twist drill

The HSS-E-PM drill fills the gap between conventional HSS drills and solid carbide drills. Available in diameters from 0.4 mm to 25 mm and in lengths 3xD and 5xD.

Advantages

- ▲ Cone-shaped finish features high degree of cutting edge stability
- ▲ Specially designed for applications in higher-strength steels/materials
- ▲ High resistance to wear thanks to uniform structure of the HSS-PM
- ▲ Universal due to TiN coating

Benefits

- ▲ Longer tool life than conventional HSS drills
- ▲ Universal application
- ▲ More cutting data
- ▲ Increased process security
- ▲ Outstanding price/performance ratio



You can find our entire range of HSS drills in our main catalogue → Chapter 1 or online at: cuttingtools.ceratizit.com



Solid carbide drills

Our solid carbide high-performance drilling tools are the first choice for achieving outstanding performance in the drilling process. In addition to a long service life, these tools stand out due to their versatility, reliable chip removal and excellent self-centring. We also supply special tools for all material groups and to minimise machining time.

WTX – Ti

Solid carbide high-performance drill specialising in the machining of heat-resistant Super alloys, materials that are difficult to machine, as well as corrosion and acid-resistant stainless steels. Available in the diameter range from 3 mm to 20 mm in the lengths 3xD and 5xD.

Advantages

- ▲ Significant increase in process security through improved flute and core diameter geometry
- ▲ Increased tool stability due to stabilised cutting edges
- ▲ More wear resistant due to new coating technology with subsequent surface treatment
- ▲ Higher cutting speeds and feed rates can be achieved

Benefits

- ▲ Extended service life / tool life
- ▲ Maximum process security
- ▲ Increase in productivity
- ▲ Accurate positioning of holes
- ▲ Increased hole quality (roundness)



WTX – AL

DLC-coated solid carbide high-performance drill, specially designed for applications in aluminium, and other non-ferrous metals. Available in diameters from 2.5 mm to 20 mm and in lengths 5xD, 8xD and 12xD.

Advantages

- ▲ More wear resistant due to DLC coating
- ▲ Optimised chip clearance
- ▲ From 8xD only the head is coated in order to ensure better and safer chip removal
- ▲ High-gloss polished chip flutes avoid chip jams and/or ensure the safe removal of chips

Benefits

- ▲ Increase tool life
- ▲ Maximum process security
- ▲ Higher cutting rates can be achieved
- ▲ Specialised for use in non-ferrous metals



You can find our entire range of VHM drills in our main catalogue → Chapter 2 or online at: cuttingtools.ceratizit.com

WTX – Feed UNI

Three-edged solid carbide high-feed drill for increased productivity and hole quality. Available in diameters from 4 mm to 20 mm and in lengths 5xD, 8xD and 12xD.

Advantages

- ▲ Feed rates are two to three times higher compared to conventional double-edged solid carbide drills
- ▲ Suitable for any application
- ▲ Drill geometry enables high tool positioning accuracy
- ▲ Tried-and-tested DPX74S universal drill coating increases performance
- ▲ Reduced cutting pressure / cutting force distribution
- ▲ Low cutting temperature
- ▲ Extremely smooth flute surfaces (dropleless)

Benefits

- ▲ Extended service life / tool life
- ▲ Maximum process security
- ▲ Wide range of applications
- ▲ Increase in productivity
- ▲ Accurate positioning of holes
- ▲ Increased hole quality (roundness)



WTX – HFDS

Four-edged solid carbide high-feed drill for increased productivity and hole quality. Available in diameters from 3 mm to 20 mm and in lengths 3xD and 5xD.

Advantages

- ▲ Feed rates are two to three times higher compared to conventional double-edged solid carbide drills
- ▲ Specially designed for steel and cast iron machining
- ▲ Drill geometry enables high tool positioning accuracy
- ▲ Tried-and-tested DPX14S coating especially for steel increases performance
- ▲ Reduced cutting pressure / cutting force distribution
- ▲ Holes drilled to H7 quality
- ▲ Four cutting edges for maximum roundness and accuracy

Benefits

- ▲ Extended service life / tool life
- ▲ Maximum process security
- ▲ Increase in productivity
- ▲ Accurate positioning of holes
- ▲ Increased hole quality (roundness)



WTX – Micro / WTX – Micro deep hole drill

The solid carbide micro drills and micro deep hole drills in the WTX – Micro series are setting new standards in the production of very small holes and very small deep holes. Available in diameters from 0.8 mm to 2.90 mm and in lengths 5xD, 8xD, 12xD, 16xD, 20xD, 25xD and 30xD.

Advantages

- ▲ Specialised micro drills for universal application.
- ▲ Universally applicable due to the DPX74M Dragonskin Coating.
- ▲ Patented flute outlet increases process security
- ▲ 5xD can be used as a pilot drill and is suitable for this purpose.
- ▲ From 8xD upwards, the drills are only head coated to ensure optimised chip clearance.

Benefits

- ▲ Greater process security
- ▲ Can be used for any application
- ▲ High wear resistance
- ▲ Outstanding price/performance ratio



WPC – Change

The solid carbide indexable insert drill combines the advantages of a solid carbide drill with those of an indexable system. The modular system features a wear-resistant steel holder with thro' coolant and carbide replaceable cutting heads coated with PVD. Available in diameters from 14 mm to 30 mm and in lengths 3xD and 5xD.

Advantages

- ▲ Exchangeable insert drilling system at an attractive price
- ▲ Universal application
- ▲ Wear-resistant holder suitable for multiple uses
- ▲ Option to exchange the cutting edge in the machine

Benefits

- ▲ Sustainable and reduces tool costs due to reusable holder
- ▲ High process security
- ▲ Performance equals that of a carbide drill
- ▲ Easy handling



You can find our entire range of VHM drills in our main catalogue → Chapter 2 or online at: cuttingtools.ceratzit.com



Indexable insert drills

Exceptionally cost-effective and efficient: Our indexable insert drills achieve the very best results when machining large hole diameters. High cutting parameters, maximum chip volumes and universal application options increase your productivity many times over.

KUB Pentron

The KUB Pentron indexable insert drill is the all-rounder for process-secure drilling under various conditions. Available in diameters from 14 mm to 65 mm and in lengths 2xD, 3xD, 4xD and 5xD.

Advantages

- ▲ 20% higher cut and feed rate values compared with conventional indexable insert drills already on the market
- ▲ Large selection of indexable inserts available
- ▲ Four usable cutting edges made from the best substrates with customised coatings
- ▲ Wide selection of shank variants (ABS, cylindrical, PSC)
- ▲ Surface-treated, wear-resistant base body
- ▲ FEM-optimised chip flutes ensure good chip removal
- ▲ MMS-compatible
- ▲ Easy handling

Benefits

- ▲ Long service life
- ▲ High cutting rates reduce the machining time
- ▲ Consistent deflection for all materials and feeds
- ▲ Maximum process security
- ▲ Wide range of applications



MaxiDrill 900

The MaxiDrill 900 indexable insert drilling system is synonymous with high productivity in rough machining up to 5xD. Available in diameters from 12 mm to 63 mm and in lengths 2xD, 3xD, 4xD and 5xD.

Advantages

- ▲ Patented indexable insert guarantees excellent drilling performance
- ▲ Optimal radial force compensation ensures high tolerances and surface qualities
- ▲ Four usable cutting edges made from the best substrates with customised coatings
- ▲ Surface-treated, wear-resistant base body
- ▲ Easy handling due to use of just one centre plate

Benefits

- ▲ Long service life
- ▲ High cutting rates reduce the machining time
- ▲ Maximum process security
- ▲ Wide range of applications



KUB Trigon

The KUB Trigon indexable insert drilling system boasts high accuracy and exceptional performance even under unstable conditions. Available in diameters from 14 mm to 82 mm and in lengths 2xD, 3xD and 4xD.

Advantages

- ▲ Tight drilling tolerances up to IT 8 possible
- ▲ Achieves high surface quality
- ▲ Wide range of specialised indexable inserts
- ▲ Wear-resistant, surface-treated base body
- ▲ Cutting edge geometry ensures good centring
- ▲ Also ideal for use on less powerful machines

Benefits

- ▲ Long service life
- ▲ Eliminates potential rework on the hole
- ▲ Maximum process security
- ▲ Wide range of applications
- ▲ Combi shank allows clamping in Weldon and Whistle Notch adapters



You can find our entire range of indexable insert drills in our main catalogue → Chapter 3 or online at: cuttingtools.ceratizit.com



Reamers and countersinks

Our comprehensive product range includes reamers and countersinks that are suitable for universal application in all materials. From standard products to high-performance tools for customers with exacting requirements in terms of radial run-out accuracy, our product range is sure to have the ideal tool for your application.

HSS / solid carbide 90° countersinks with extremely irregular pitch

The 90° countersink with extremely irregular pitch delivers significantly higher performance than conventional countersinks on the market due to its reworked geometry, base material (HSS / solid carbide) and specialised coating. Available in diameters from 4.3 mm to 31 mm.

Advantages

- ▲ Specially updated HPC-TiN coating (or tried-and-tested TiN coating for HSS variant) for maximum service life and wear resistance
- ▲ Proven extremely irregular pitch guarantees very quiet running, resulting in especially round and chatter-free countersinks with the highest surface quality
- ▲ Greatly reduced axial and radial forces during machining
- ▲ Improved cutting edge geometry creates perfect balance between smooth cutting and durability
- ▲ Very attractive price

Benefits

- ▲ High process security and short cycle times mean short machining times, resulting in a significantly optimised manufacturing process and low production costs
- ▲ Wide range of applications for use with nearly any material, available in all standard dimensions (also as a set)



REAMAX TS

REAMAX TS is a versatile, modular reaming head system. Available in diameters from 18 mm to 65 mm and in lengths 3xD and 5xD.

Advantages

- ▲ All conventional materials can be machined
- ▲ Through and blind hole drilling possible with a single system
- ▲ Extremely small drilling tolerances can be achieved (from IT4)
- ▲ Machining depths up to 5xD
- ▲ High-speed machining at cutting speeds up to 300 m/min and feed rates up to 2.4 mm/rev
- ▲ Highest service life thanks to adjustability

Benefits

- ▲ Maximum flexibility: wide diameter range can be covered with a single system (Ø 18 mm–65 mm)
- ▲ User-friendliness: reaming heads can be quickly and easily changed in the machine
- ▲ Reduced tool costs and logistics expenditure
- ▲ Maximum cost effectiveness and process security for reaming operations



Fullmax

The Fullmax family is the most reliable and efficient reaming range in the mono-machining segment. Available in diameters from 2.96 mm to 20.05 mm in shorter and longer version.

Advantages

- ▲ All conventional materials can be machined due to specially developed chamfer geometries and coatings
- ▲ The ideal tool type for any material: UNI, VA, ALU, K, H
- ▲ Available in blind hole or through hole variant
- ▲ Ex-stock availability in H7 and 1/100 mm dimensions

Benefits

- ▲ Maximum machining performance for maximum efficiency
- ▲ Minimal costs per hole thanks to very high cutting rates and maximum tool life
- ▲ Delivers optimum surface quality and maximum dimensional, geometrical and positional accuracy
- ▲ Short variant:
 - Shorter projection length for maximum stability
 - Even longer service life and cutting rates achievable with high-quality fits
 - Ideal for use on sliding head lathes and machines with tight machine interiors
 - Even shorter machining times due to higher number of cuts
 - Even more attractive price for short hole depths



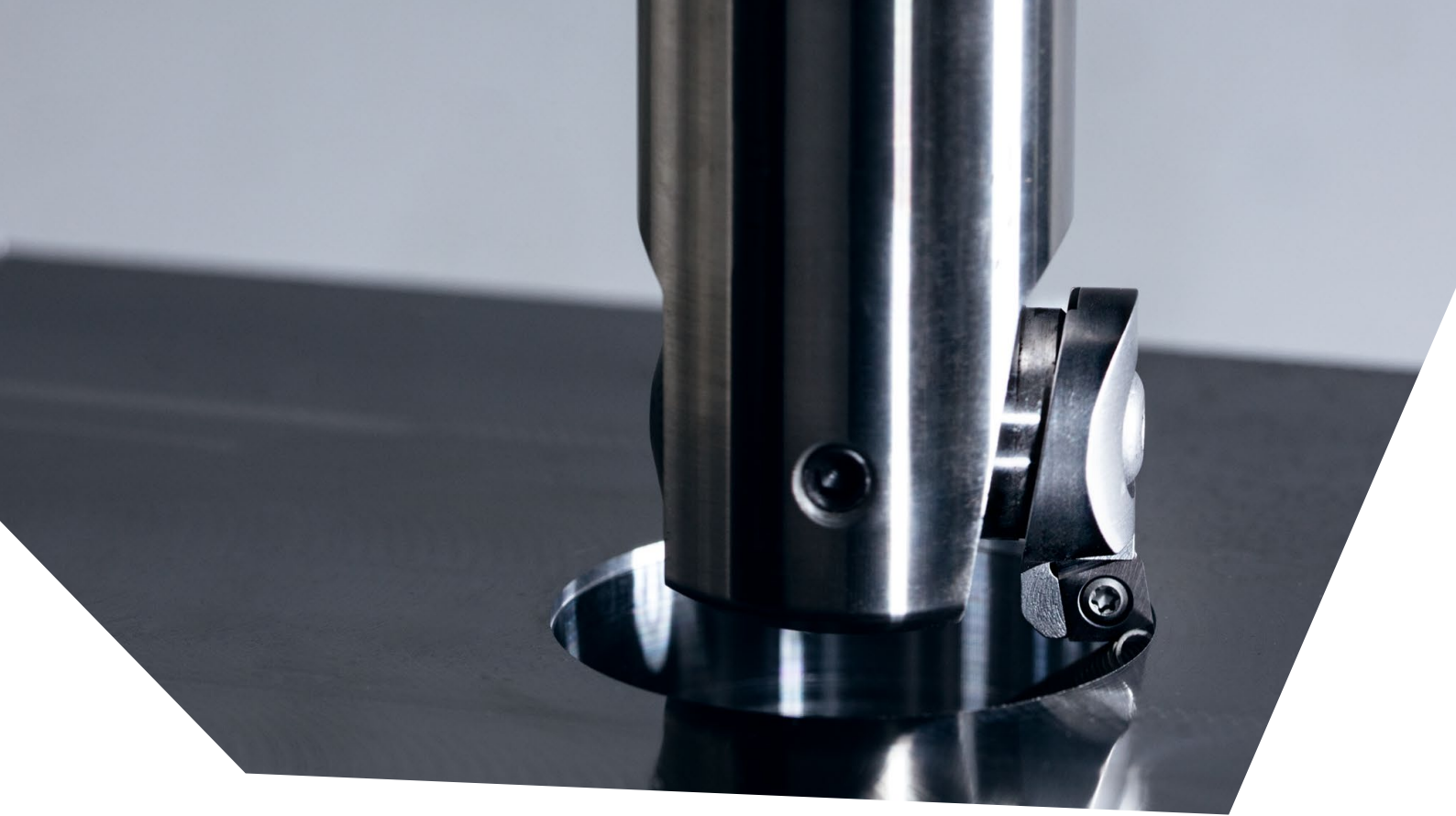

Spindle tools

We recommend our spindle tools for hole production with demanding requirements on dimensional and positional accuracy. As experts in efficient bore machining, we can offer a full range of spindle tools of the highest quality.

hi.flex digital

hi.flex digital is a high-precision, ultra-flexible fine spindle system with optional digital display and ABS interface.

Advantages

- ▲ Analogue adjustment of the diameter to be machined using a vernier scale and digital adjustment via the digital stick
- ▲ The fine adjustment allows for precise positioning
- ▲ Accessories fully compatible with the BluFlex 2 fine spindle system
- ▲ Advantages of the digital stick:
 - Micron-precise display resolution
 - Unit: mm/inch possible
 - Display can be rotated by 180°

Benefits

- ▲ Maximum flexibility: wide diameter range can be covered with a single system (\varnothing 0.5 mm–365 mm)
- ▲ User-friendly tool for precise fine drilling
- ▲ Maximum user friendliness: analogue and digital adjustment of the diameter to be machined



You can find our entire range of spindle tools in our main catalogue → Chapter 5 or online at: cuttingtools.ceratizit.com

hi.flex micro

The hi.flex system is continuing its success story, with the ultimate milestone in terms of precision, flexibility and user-friendliness now getting a well-deserved "little brother". This is an absolute must for every properly equipped production facility.

Advantages

- ▲ Very large boring range (0.5 mm–60 mm)
- ▲ Specially designed for small and very small fits
- ▲ Very high RPMs achievable thanks to its favourable mass ratio and symmetrically balanced design
- ▲ Radial balancing threads enable precision balancing to be carried out in the working position
- ▲ Specially designed boring bars tailored specifically to the respective application available as semi-standard
- ▲ Very attractive pricing
- ▲ Boring bar adapter for usage of UltraMini and EcoCut boring bars

Benefits

- ▲ Maximum user friendliness: Extremely simple handling
- ▲ Very flexible usage due to extremely lightweight, modular design



TwinKom G01 twin cutter

The innovative twin cutter range from TwinKom is particularly impressive thanks to its high performance and flexibility. A large selection of different holders and indexable inserts makes the range ideal for any application – even difficult machining tasks.

Advantages

- ▲ Unique on the market: A "true" twin cutter for roughing and semi-finishing
- ▲ Twin cutter with axially and radially adjustable or fixed insert holders
- ▲ Very large boring range (24 mm–335 mm)
- ▲ Significantly reduces axial cutting forces
- ▲ Available in short and long version
- ▲ When used as a stepped tool:
 - Can double the cutting width
 - Allows for easy machining even with a large offset to the pilot or tap hole
 - Enables rough and second-cut machining in one set-up (no additional tools required)

Benefits

- ▲ Can be used for nearly any material on the market due to wide selection of indexable inserts
- ▲ ABS: very flexible due to the modular design





\ THREADING WITH NO COMPROMISES

Our varied range of taps and thread formers covers all conceivable areas of application.

Whether you are looking for taps, thread formers, circular and thread milling cutters or thread turning tools, you are sure to find the perfect tool for your needs in our product range.



Thread turning tools



Taps and thread formers



Circular and thread milling cutters

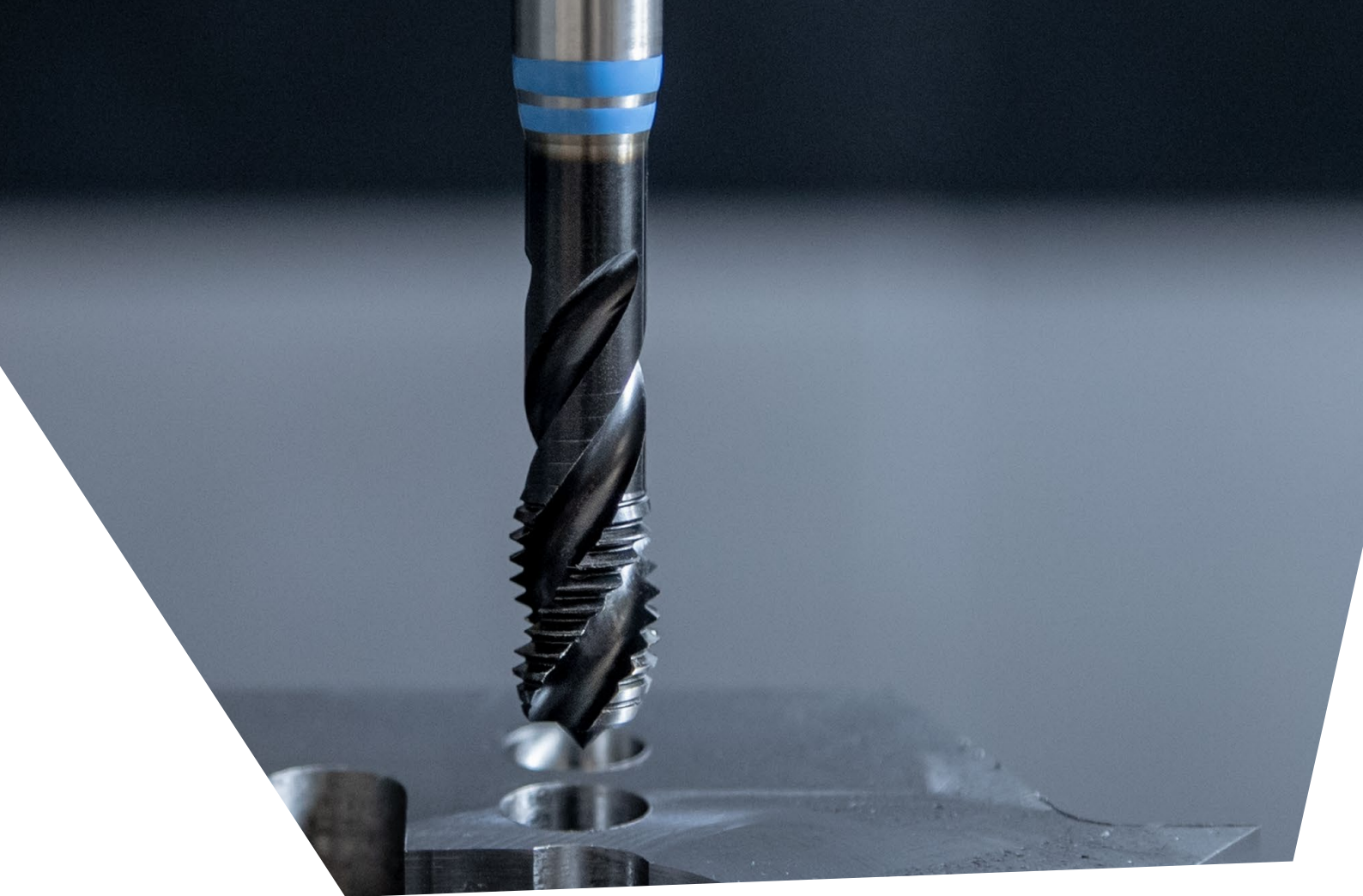

Taps and thread formers

Whether you are machining steel, stainless steel, cast iron or non-ferrous metals, our high-quality taps will allow you to create perfect internal threads, time and time again. We also offer a wide range of thread formers for manufacturing heavy-duty internal threads using non-cutting methods. Our varied product range is sure to impress.

Through hole – machine taps TruTap, right hand

HSS-E machine tap type TruTap UNI CNC is designed for through hole machining, thread type M, right-hand thread.

Advantages

- ▲ Suitable for synchronised CNC machining with minimum length compensation chuck, which can significantly increase the service life of the tool.
- ▲ High wear resistance with low friction properties despite high degree of toughness
- ▲ Suitable for application temperatures up to 450 °C

Benefits

- ▲ Long service lives
- ▲ Maximum reliability at a low price
- ▲ Wide range of applications thanks to the "TiN-GS" coating, many different materials can be machined in a process-secure manner.



Thread formers with carbide strips, DuoForm

The HSS-E thread formers with soldered-in carbide strips are especially suitable for usage on transfer lines. The flexible base body compensates for smaller alignment errors, while the carbide maximises the service life.

Advantages

- ▲ Maximised service life thanks to the innovative combination of the flexible HSS base support material and the wear-resistant, soldered-in carbide forming lobes
- ▲ Universal application in all ductile materials
- ▲ Reduction in tool costs

Benefits

- ▲ Long service lives
- ▲ Short machining times thanks to high cutting speeds
- ▲ Optimum usage on transfer lines
- ▲ For blind holes and through holes



Through and blind hole tap type DuoTap

Machine tap DuoTap made of HSS-E or HSS-PM cutting material for through and blind hole machining.

Advantages

- ▲ For blind and through holes up to 2xD
- ▲ Available in the lead forms C / D / E, without spiral point
- ▲ Straight flutes
- ▲ For steel, short chipping and hardened materials to 55 (62) HRC
- ▲ Also available with extra long version and through coolant

Benefits

- ▲ Long tool life
- ▲ For blind and through holes
- ▲ Wide material application field
- ▲ 2-in-1 tool for lower tool costs



Blind hole tap type CavTap SL

Machine tap CavTap SL for blind hole machining.

Advantages

- ▲ For blind holes up to 2xD
- ▲ Lead forms: C: 2-3 cutting leads, without spiral point and E: 1.5-2 cutting leads, without spiral point
- ▲ (15°, 25°, 30°) slow right hand helix
- ▲ For steel, titanium and titanium alloys and Inconel 718
- ▲ Suitable for synchronised machining, with extra-long version and through coolant
- ▲ Also suitable for difficult operating conditions such as cross holes

Benefits

- ▲ Highest process reliability at a low price
- ▲ Long tool life
- ▲ Wide material application field



You can find our entire range of taps and thread formers and in our main catalogue → Chapter 6 or online at: cuttingtools.ceratizit.com



Circular and thread milling cutters

Whether for small batch sizes with large threads or to reduce machining times in batch production, our wide range of circular and thread milling cutters, which are available as solid or modular, are sure to boost your production.

Solid carbide thread milling cutters 2xD, with and without chamfer facet

Steel threads are milled for reasons of repeatability and quality requirements. Thread milling cutters are also used for expensive workpieces in particular to enhance process security.

Advantages

- ▲ No chip issues, resulting in maximum process security
- ▲ Thread depths to the bottom of the hole possible
- ▲ One tool for blind hole and through hole machining
- ▲ Low cutting pressure, even with thin-walled workpieces
- ▲ Suitable for nearly any material

Benefits

- ▲ Optimised core rounding and taper for an improved service life and trueness to gauge
- ▲ Larger clearance face on countersunk part for excellent chip clearance (SFSE)
- ▲ Tools are precision-ground with a high grinding quality
- ▲ The Ti500 coating has been enhanced with a smoothing effect that improves chip clearance



You can find our entire range of circular and thread milling cutters in our main catalogue → Chapter 7 or online at: cuttingtools.ceratizit.com

Circular drill thread milling cutter

The circular thread milling cutter type H is specially designed for thread production in hardened and difficult-to-machine materials.

Advantages

- ▲ The tool is perfectly suited to hard machining.
- ▲ Drilling, countersinking and thread milling with a single tool
- ▲ Suitable for producing right-hand and left-hand threads
- ▲ Wear-resistant TiAlN coating
- ▲ Can produce blind and through holes
- ▲ Can produce different tolerances

Benefits

- ▲ Time saving: drilling, countersinking and thread milling with a single tool at high cutting speeds
- ▲ Wide range of applications: creates right-hand and left-hand threads and is suitable for through hole and blind hole threads
- ▲ The ultimate in thread quality: burr-free threads with high surface quality



MiniMill XL for slot, cut-off and finish milling

The teeth of the new MiniMill XL are cross-pitched from a width of 1.5 mm, optimising the behaviour of the cut-off milling head as it enters the material. This enables a smoother cut. Even with large overhangs and adverse conditions such as unstable parts, the strengths of the new inserts remain unaffected and increase both the tool life and performance.

Advantages

- ▲ Cross-pitched from 1.5 mm–6.0 mm (width)
- ▲ 12 cutting edges
- ▲ Milling depths up to 16.5 mm at a Ø of 50 mm
- ▲ Cutting edge widths from 0.5 mm–6.0 mm
- ▲ Cutting point with four driving slots (steel or carbide)

Benefits

- ▲ Reduces reworking costs
- ▲ Minimal chip issues
- ▲ Longer service life





Thread turning tools

As a specialist in thread manufacturing, we offer a wide range of thread turning tools, for usage on conventional and CNC machines. No matter what the application, our thread turning tools will ensure that you always have the chip under control.



You can find our entire range of thread turning tools in our main catalogue → Chapter 8 or online at: cuttingtools.ceratizit.com

Multi-tooth outer thread-turning insert HCN2525

Similar to full profile inserts, the core diameter can also be produced during thread machining with multi-tooth threading inserts. This ensures a burr-free thread. In addition, the higher number of teeth can increase productivity compared to full profile inserts; it can double it with two-tooth inserts and triple it with three-tooth inserts.

Advantages

- ▲ Higher productivity
- ▲ Fewer passes required for thread production
- ▲ Saves time during thread production

Benefits

- ▲ Longer service life thanks to fewer cuts
- ▲ Burr-free thread production
- ▲ Time savings





TURNING

SPECIALIST IN INDEXABLE INSERT TOOLS FOR TURNING AND GROOVING

Innovative, revolutionary and effective – our turning products are underpinned by many years of experience in the development and production of carbide tools. You will find everything you are looking for and more in our vast universe of turning tools.



Multifunction tools –
EcoCut and FreeTurn

Miniature turning tools



Indexable insert
turning tools



Grooving tools



Sliding head lathe tools



Indexable insert turning tools

You can rely on our range of indexable insert turning tools. State-of-the-art Dragonskin coating technology means that every indexable insert is an expert in its field. The innovative tool holders also ensure excellent stability and security for successful turning.

ISO-P grade update – CTCP115-P, CTCP125-P and CTCP135-P

An innovative CVD coating with the latest Dragonskin coating technology makes the indexable inserts ideally suited to versatile steel machining. In combination with a balanced carbide substrate, the new grades in the ISO-P category boast a wide application area with improved wear resistance.

Advantages

- ▲ Higher cutting speeds can be reached thanks to the latest Dragonskin coating technology, which features layering with an optimised microstructure.
- ▲ Longer tool life due to improved aluminium oxide layer
- ▲ Greater process security thanks to perfectly tailored combination of elevated-temperature hardness and toughness

Benefits

- ▲ Higher productivity due to increased cutting speeds
- ▲ Used cutting edges are clearly identified for greater efficiency.
- ▲ Easy to select the correct indexable insert

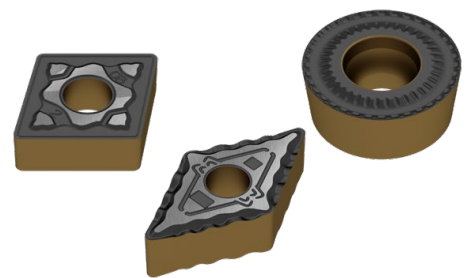

DirectCooling – MaxiLock-N and MaxiLock-S

The new tool holders with DirectCooling improve both your process security and the service life of the tool cutting edges with targeted cooling. The MaxiLock-S tool holder is suitable for a wide range of positive inserts. With the MaxiLock-N turning tool holder, we are now offering the option of DirectCooling for negative inserts as well.

Advantages

- ▲ Longer tool service lives
- ▲ Increased cooling effect
- ▲ Higher cutting parameters boost productivity
- ▲ Improved cooling and smearing effect
- ▲ Reduced tool wear
- ▲ Better surface quality

Benefits

- ▲ Optimized tool life due to lower temperatures in the cutting zone
- ▲ Chips are flushed out and deflected, improving process security
- ▲ Convenient, direct coolant transfer when using the VDI, BMT, PSC or HSK-T adapters

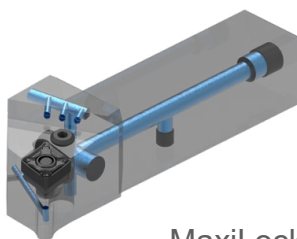

MaxiLock – N-DC

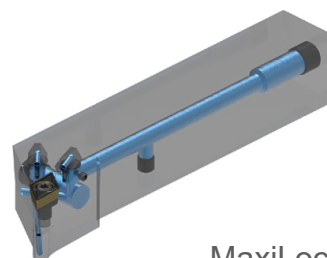

MaxiLock – S-DC



You can find our entire range of turning tools with indexable inserts in our main catalogue → Chapter 9 or online at: cuttingtools.ceratizit.com

X7 line – The CTPX710 and CTPX715 multi-application grade

The new X7 multi-application grade can be used in any application range and is only restricted by the chip breaker.

Different materials, different requirements – only one indexable insert!

Advantages

- ▲ Universal carbide grade for finish machining of super alloys, stainless steel, steel and non-ferrous metals.
- ▲ Highly wear-resistant PVD Dragonskin coating for long tool lives.
- ▲ Revolutionary smooth coating without defects for perfect chip removal.
- ▲ Perfect cutting edges due to thin and stable AlTiN coating

Benefits

- ▲ The grade is easy to select, giving you a better overview of your range of tools.
- ▲ Streamlines stock and reduces overstock.
- ▲ More flexible range of applications with just one grade.

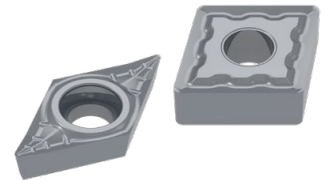

HardCut PCBN indexable inserts CTBH 1000C, CTBH 2000C, CTBH 3000C

Extreme demands are placed on tools used for hard machining. The cost and service life of tools play a significant role. Our new HardCut PCBN range provides the perfect solution – the specialist in machining hardened components.

Advantages

- ▲ Excellent surfaces, right from the first cut
- ▲ Suitable for hard machining 55-67 HRC
- ▲ End-to-end product range
- ▲ Simplified naming system
- ▲ High-performance coating with maximum temperature resistance

Benefits

- ▲ Maximum process security
- ▲ The right indexable insert for every type of machining
- ▲ The grade is easy to select, giving you a better overview of your range of tools.
- ▲ Maximises tool life

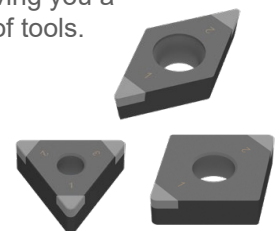

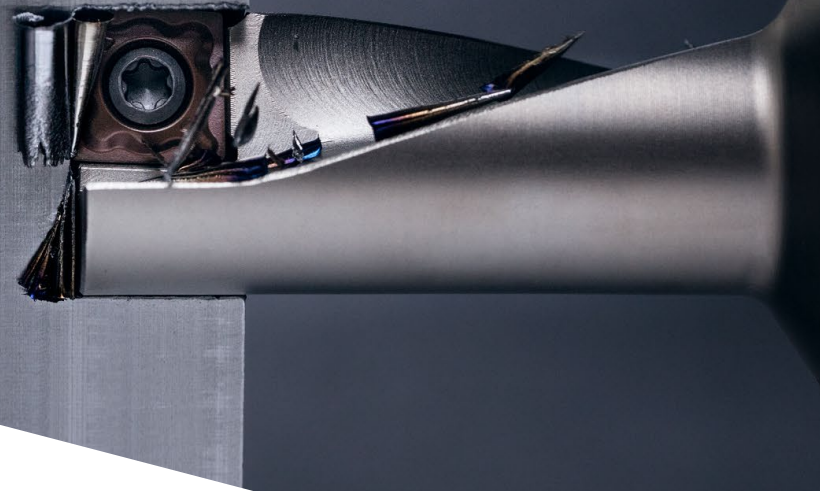

Multi-function tools

Drilling, turning and grooving with one system. Our multifunction tools are the Swiss army knives among the cutting tools. You only need one tool for multiple applications, saving valuable time and money.

FreeTurn

High Dynamic Turning (HDT) – The revolution in turning. Be part of the FreeTurn generation!

Advantages

- ▲ Improved chip control
- ▲ Several machining operations with one tool
- ▲ Fewer empty runs in the turning process
- ▲ Fewer tool changes
- ▲ The full circumference of the indexable insert is used

Benefits

- ▲ Increased flexibility
- ▲ Greater process security
- ▲ Cost-effective operation
- ▲ Effective use of the machine capacity
- ▲ Reduced tooling costs
- ▲ Reduction in storage costs / tool variety



EcoCut – CTCP425-P and CTCP435-P grade update

We have completed a grade update to ensure our successful EcoCut system remains a competitive multifunction tool. This update affects all indexable inserts with grades CTCP425-P and CTCP435-P.

Advantages

- ▲ Higher cutting speeds can be reached thanks to the latest Dragonskin coating technology, which features layering with an optimised microstructure.
- ▲ Longer tool life due to improved aluminium oxide layer
- ▲ Greater process security thanks to perfectly tailored combination of elevated-temperature hardness and toughness

Benefits

- ▲ Higher productivity due to increased cutting speeds
- ▲ Used cutting edges are clearly identified for greater efficiency

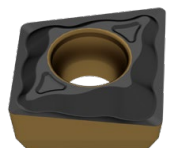

You can find our entire range of EcoCut turning tools in our main catalogue → Chapter 10 or online at: cuttingtools.ceratizit.com

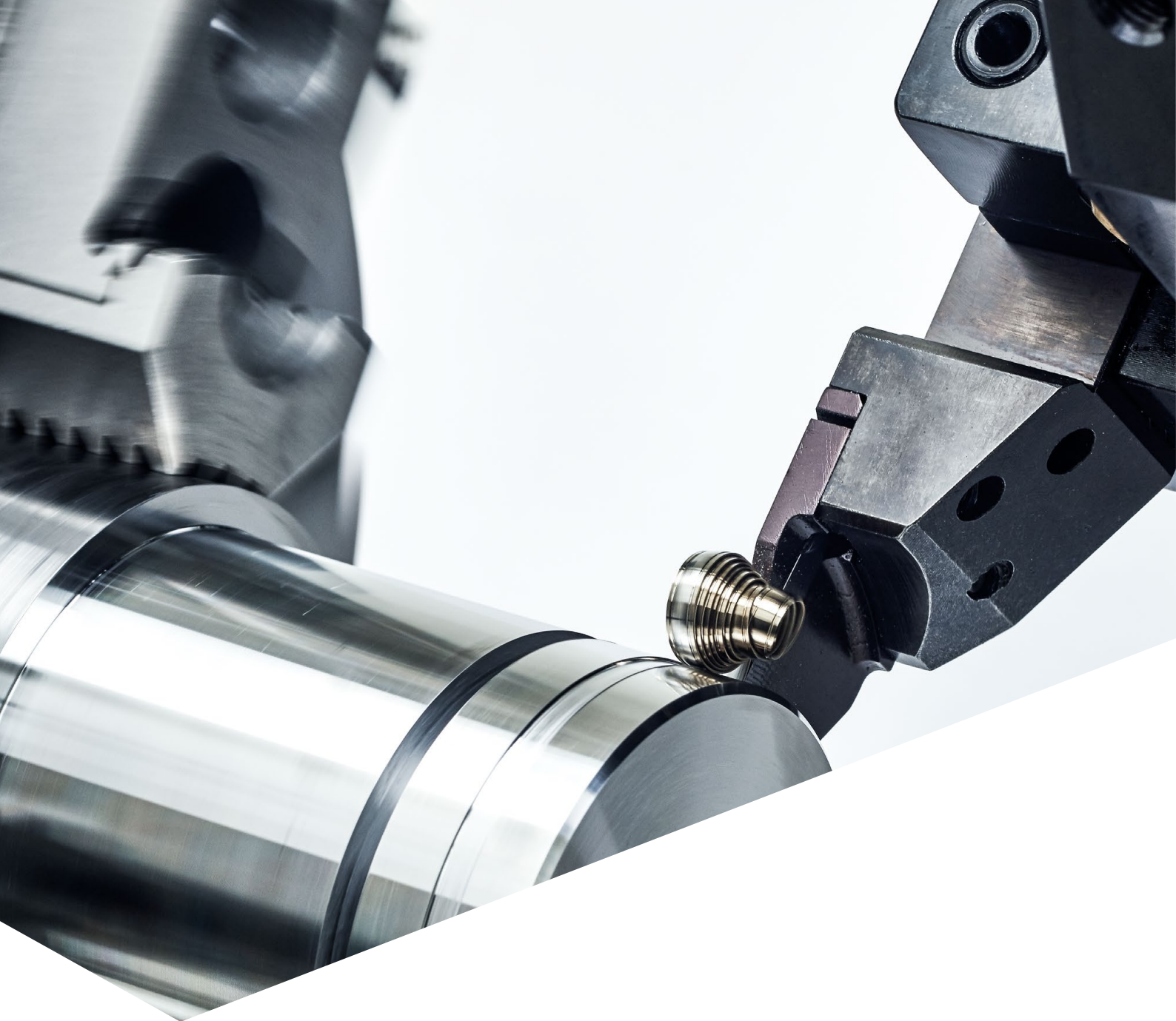

Grooving tools

Be in control with our grooving tools. The outstanding stability of the tool makes even difficult grooving tasks with unpredictable chip control or high temperatures easy to accomplish.



You can find our entire range of grooving tools in our main catalogue → Chapter 11 or online at: cuttingtools.ceratzit.com

SX system – The universal grooving tool

The SX grooving system was developed especially for demanding grooving, parting and longitudinal turning applications. Designed using the FEM method, this system combines high stability with optimum distribution of forces. The SX-DC tool holders also feature DirectCooling (DC) for a targeted coolant supply.

Advantages

- ▲ Range of chip breakers offer suitability for various applications
- ▲ Available as a modular or mono system
- ▲ Active tool holder
- ▲ DC for ideal chip flow and control

Benefits

- ▲ Quick changeover of parting blades
- ▲ Increased process security
- ▲ Long tool life



GX system with DirectCooling

The tried-and-tested GX grooving system is now available with targeted DirectCooling (DC) coolant supply. This results in greater process security and a longer tool life.

Advantages

- ▲ Clamping screw can be operated from above and below
- ▲ DC system with dual cooling (rake face and flank)
- ▲ Universal VDI clamping block for turning and grooving holders

Benefits

- ▲ Easy adjustment of the clamping screw (user-friendly)
- ▲ Process security, longer tool life and enhanced productivity
- ▲ No downtimes caused by long chips

MonoClamp – GX-DC

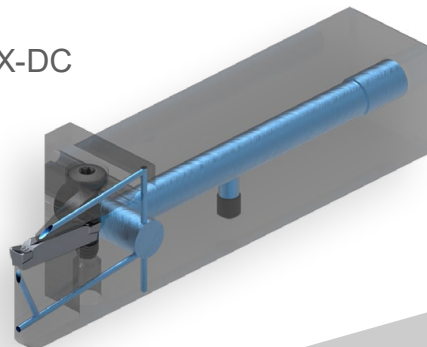



Miniature turning tools

A wide range of products for the smallest workpieces. Our miniature turning tools provide outstanding efficiency and maximum performance when machining profiles at small diameters.

UltraMini – Inserts for internal turning

UltraMini cutting inserts for various turning applications are available from \varnothing 0.5 mm. The inserts are fully ground from the shank to the cutting edge and so guarantee an unprecedented level of changeover precision.

Advantages

- ▲ High repeatability
- ▲ Thro' coolant supply
- ▲ More or less every contour can be machined
- ▲ Machining possible in virtually all materials
- ▲ Only two different tool holders are required for all cutting inserts

Benefits

- ▲ The inserts are fully ground from the shank to the cutting edge and so guarantee an unprecedented level of changeover precision.
- ▲ Wide range of applications and high flexibility
- ▲ Machining of small workpieces



You can find our entire range of miniature turning tools in our main catalogue → Chapter 12 or online at: cuttingtools.ceratzit.com

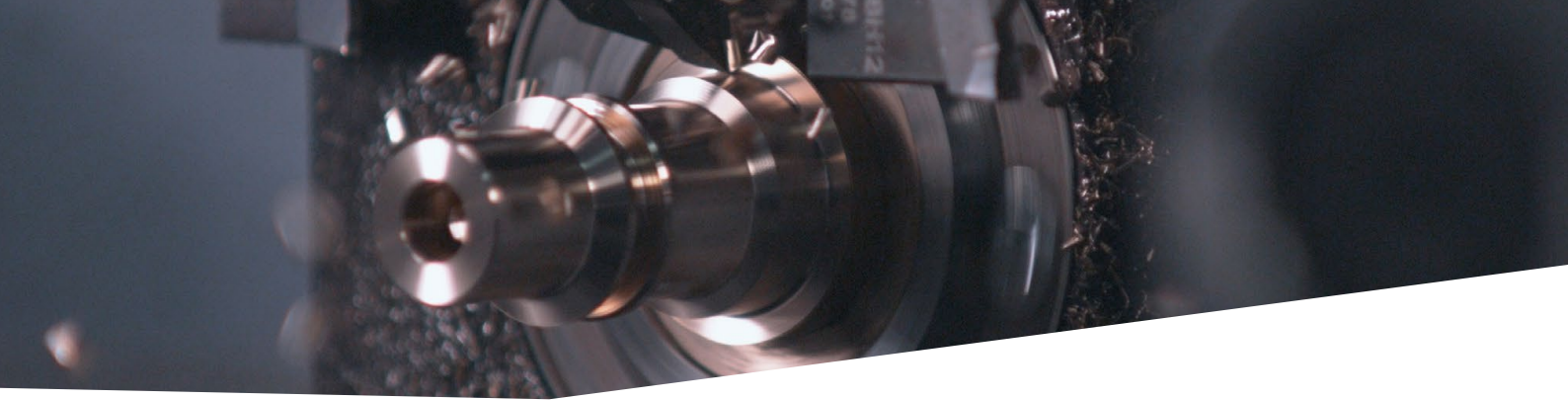

Sliding head lathe tools

As a tool specialist for sliding head tooling, we are able to provide a comprehensive range of products. We are sure to have the perfect tooling solution for your needs, so you can instantly get started with your sliding head tooling application.

XheadClamp

Fast tool change with high repeatability – this production requirement is met with the XheadClamp holder system. The system boasts a simple changeover process that saves users valuable time. In addition, the XheadClamp system sets standards in terms of flexibility and handling. It makes it quick and easy to precisely change the indexable insert, turning, grooving or threading insert, or to change to a different geometry.

Advantages

- ▲ High clamping forces
- ▲ Repeatability of less than $\pm 5.0 \mu\text{m}$
- ▲ All heads can be installed irrespective of system size
- ▲ No variable X and Y dimensions when changing the head
- ▲ Centre height is retained even when the insert size is changed

Benefits

- ▲ Quick and easy to change the heads with only one screw
- ▲ Tools can be adapted to the component
- ▲ Extremely fast indexable insert change thanks to exchangeable head
- ▲ Maximum flexibility by selecting from a wide range of exchangeable heads



VertiClamp

The VertiClamp system is mainly used for sliding head lathes. The vertical arrangement of the cutting edges saves space and ensures vertical alignment. The axial indexable insert system ensures that the insert seat is perfectly protected from chips and ensures a high degree of indexable insert changeover precision.

Advantages

- ▲ The connection between the indexable insert and tool holder guarantees optimum mounting.
- ▲ Both cutting edges remain intact even after insert breakage
- ▲ High degree of indexable insert changeover precision due to axial indexable insert system with defined stop
- ▲ Cutting forces are transmitted directly from the insert to the holder so screws are not impacted by shear forces.

Benefits

- ▲ Insert can be changed on both sides due to combi tool holder
- ▲ A wide range of indexable inserts and geometries increase flexibility
- ▲ Holders are also available with internal cooling



You can find our entire range of sliding head tools in our catalogue of sliding head solutions or online at: cuttingtools.ceratizit.com

\ MILLING

FOR ANY AREA OF APPLICATION

Let the chips fly! We offer a comprehensive range of milling tools – from HSS milling cutters for standard applications to solid carbide high performance tools, we have everything you need to perfect your milling process.



HSS milling cutters



Solid carbide milling cutters

Milling tools with indexable inserts

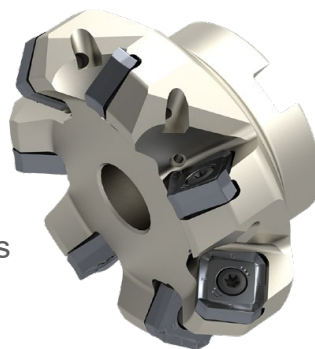

Exchangeable head system



HSS milling cutters

Our range of products includes HSS milling cutters for all common applications. These are available as uncoated or high-quality coated HSS milling cutters, which permit extremely high feed rates and cutting speeds. Milling tools made from powder metallurgically produced HSS are also available for the most demanding applications, while providing an extended tool life.

End mill HSS-E Co 8

HSS milling cutter with a good price-performance ratio. Available in diameters from 1.8 mm to 50 mm and in lengths short to extra-long.

Advantages

- ▲ High breakage resistance
- ▲ Available as form or angle milling cutter
- ▲ Sharpness makes it ideal for soft non-ferrous metals and plastics
- ▲ Resistant to impacts and vibrations

Benefits

- ▲ Inexpensive
- ▲ Can be used even under unstable conditions



You can find our entire range of HSS milling cutters in our main catalogue → Chapter 13 or online at: cuttingtools.ceratizit.com

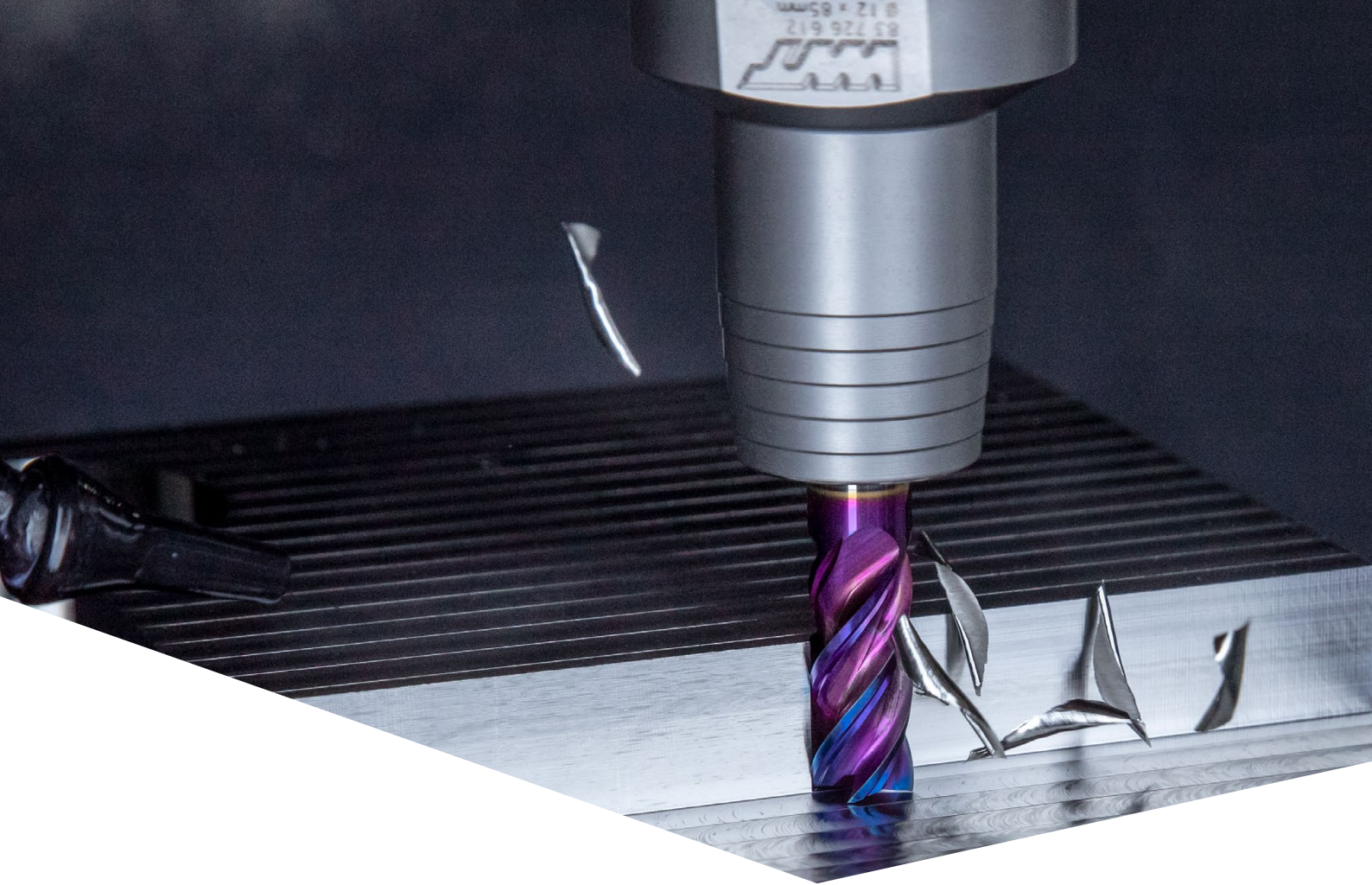

Solid carbide milling cutters

Our solid carbide milling tools ensure you always produce a quality component. As well as all standard tool types, we also stock a number of special milling cutters and special tools for high-performance machining of steel, stainless steel and aluminium.

SilverLine

The SilverLine solid carbide milling cutters are universal cutters and boast long service lives in virtually all materials. Available in diameters from 3 mm to 20 mm and in lengths short to extra-long.

Advantages

- ▲ Proven, tried-and-tested tool
- ▲ Outstanding price/performance ratio
- ▲ Suitable for processing virtually all materials
- ▲ Wet and dry machining possible

Benefits

- ▲ Increased process security
- ▲ Improved performance
- ▲ Increased stability
- ▲ Increased flexibility



AluLine

The AluLine milling cutters meet the most demanding requirements when machining aluminium and non-ferrous metals. This is all made possible thanks to the special geometry and the specifically tailored coating. Available in diameters from 2 mm to 25 mm and in lengths short to extra-long.

Advantages

- ▲ Economical and process-secure machining of aluminium and non-ferrous metals
- ▲ Versatile tool selection, a tool available for more or less every application
- ▲ Long service life, thanks to the ultra-smooth DLC coating
- ▲ Also suitable for dry machining

Benefits

- ▲ Maximum service life, even in abrasive materials
- ▲ Low adhesion of chips
- ▲ High cutting speeds and feed rates make for an economical machining process



BlueLine

Maximum performance and unbeatable portfolio for high-performance machining of hardened materials. Available in diameters from 0.1 mm to 20 mm and in lengths short to extra-long.

Advantages

- ▲ Powerful substrate, perfectly adapted to the machining of hardened materials
- ▲ High-performance coating with maximum temperature resistance
- ▲ Customised geometry for economical machining up to 65 HRC
- ▲ Extremely precise micro cutter to stay within the lowest tolerance

Benefits

- ▲ Economical machining of hardened materials up to 65 HRC
- ▲ Long service life due to perfectly coordinated substrate, geometry and coating
- ▲ Huge tool selection provides the right tool for every machining job



MonsterMill – TCR

The MonsterMill – TCR milling cutter is setting new standards in titanium machining and impresses thanks to its process security and long tool life. Available in diameters from 2 mm to 20 mm and in lengths long and extra-long.

Advantages

- ▲ The innovative Dragonskin coating reduces thermal loads and enables high levels of wear resistance
- ▲ A new type of high-performance substrate for extreme toughness and flexural strength
- ▲ Geometry is ideal for the material
- ▲ Also available as an uncoated version to prevent contamination of the material

Benefits

- ▲ Irregular pitch for extremely quiet running and high-quality surfaces
- ▲ High process security as polished chip spaces ensure secure, targeted chip transport

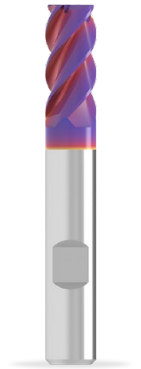

MonsterMill – HCR

The MonsterMill – HCR offers maximum performance for machining hardened materials from 54 to 70 HRC. Available in diameters from 0.2 mm to 12 mm and in lengths long and extra-long.

Advantages

- ▲ Ideal runout and high balance quality due to HA shank with h5 tolerance
- ▲ Outstanding surface quality thanks to polished cutting edge area
- ▲ Extremely wear-resistant and durable Dragonskin coating
- ▲ Specially prepared edges for optimum cutting action
- ▲ High-precision tools with tight tolerances

Benefits

- ▲ Ideal alternative to time-consuming grinding or eroding processes
- ▲ Economical machining of hardened materials up to 70 HRC
- ▲ Optimum chip clearance and long service life due to stable cutting edge geometry



CircularLine

CircularLine end mills are designed for the trochoidal milling process. This shortens machining times and extends the tool life. Available in diameters from 6 mm to 20 mm and in lengths short, long and extra-long.

Advantages

- ▲ Fine-pitch chip breaker produces short chips
- ▲ Universal tool with five or six cutting edges for very quiet running and a high material removal rate
- ▲ Wide selection of cutting edge types

Benefits

- ▲ Cutting depths up to 5xD can be achieved
- ▲ Also suitable for less powerful machines
- ▲ Higher chip volume possible than with HPC machining
- ▲ High process security due to short chips



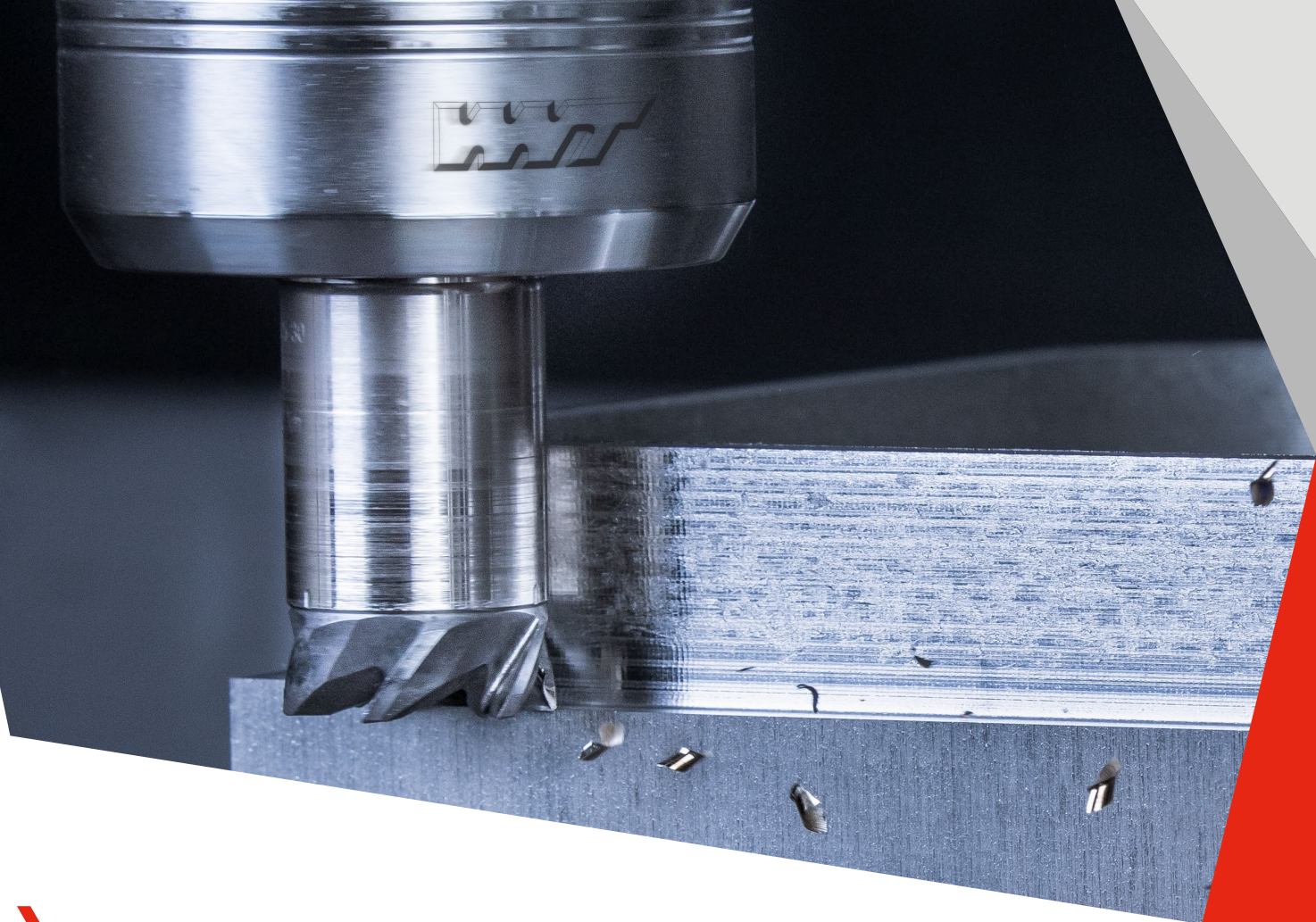

Exchangeable head system

Want to reduce your costs and find an alternative to mono tools? Then our exchangeable head systems are the perfect solution for you! These systems are stable, have very high radial run-out accuracy and offer you maximum flexibility as there is an exchangeable head to suit almost every application.

MultiLock

The exchangeable head system for professionals. Excellent performance thanks to perfectly adapted cutting data values on the interface and cutting edge geometry. Available in diameters from 12 mm to 25 mm.

Advantages

- ▲ High-precision interface
- ▲ Flat, stable interface with face contact
- ▲ Positive locking ensures stability
- ▲ Steel/carbide combination has a vibration-dampening effect

Benefits

- ▲ Longer tool service life
- ▲ High stability and very resource efficient
- ▲ Ensures high force absorption
- ▲ Optimum surface quality



You can find our entire range of exchangeable head systems in our main catalogue → Chapters 2, 4 and 14 or online at: cuttingtools.ceratizit.com



CERATIZIT \ Performance

Milling tools with indexable inserts

Our high-quality milling tools with indexable inserts will ensure that you are perfectly equipped to take on all possible milling operations, such as face, shoulder or high-feed milling. A range of systems for die production are the perfect addition to the comprehensive product portfolio.

Side and face milling cutter – MaxiMill Slot-SX system

Grooving, slotting, parting off – anyone who messes up while performing any of these operations may have the entire machining process and an unusable workpiece on their conscience. Powerful side and face milling cutters from CERATIZIT's new MaxiMill Slot-SX series with thro' coolant provide the highest levels of process security and optimum performance – even with diameters as large as 250 mm. Available in diameters from 63 mm to 315 mm.

Advantages

- ▲ Thro' coolant up to Ø250 mm
- ▲ Easy handling thanks to patented SX assembly key
- ▲ Indexable inserts from the SX grooving system + upgrade to M7 and M8 chip breakers

Benefits

- ▲ Greater process security and longer service lives can be achieved
- ▲ High surface quality and optimum chip control



Face milling – MaxiMill 273 system

The MaxiMill 273 universal face milling system boasts an extremely high level of efficiency that comes thanks to its indexable insert with 16 cutting edges per insert. The tool holders are available in all standard diameters and with a wide or narrow pitch. Available in diameters from 40 mm to 250 mm.

Advantages

- ▲ Extremely efficient due to 16-edge indexable insert
- ▲ Soft, quiet cut is gentle on the spindle
- ▲ Low power consumption
- ▲ Axial adjustable
- ▲ Outstanding surface quality thanks to integrated face cutting edge
- ▲ Masterfinish indexable insert for optimum surface quality

Benefits

- ▲ Universal application – rough and finish machining
- ▲ For wet and dry machining

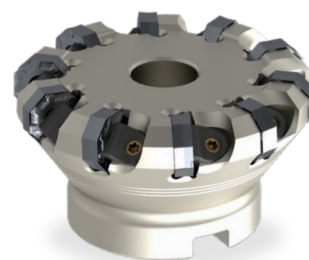

Face milling – MaxiMill 271 system

Efficiency, process security and flexibility. That's what MaxiMill 271 stands for. The extremely soft-cutting tool system can be used in a wide range of applications thanks to the narrow and wide holders, while the wiper insert also helps achieve first-class finishes. Plus, the system stands out thanks to the excellent wear properties of the cutting edge and also impresses with ideal chip formation and removal. Available in diameters from 32 mm to 250 mm.

Advantages

- ▲ High concentricity and axial running accuracy due to tight manufacturing tolerances and the precision periphery ground indexable inserts.
- ▲ Irregular pitch for extremely quiet running
- ▲ Perfect chip removal
- ▲ Positive indexable insert geometries for a soft cut
- ▲ Indexable inserts with Masterfinish geometries and Masterfinish indexable inserts
- ▲ Extensive range of indexable inserts
- ▲ Two holder versions can be used with a single indexable insert type – face milling version and high-feed version

Benefits

- ▲ Optimal surface quality
- ▲ Wide range of applications
- ▲ Excellent efficiency
- ▲ High process security



Shoulder milling – MaxiMill 491 system

Milling system with eight usable cutting edges per indexable insert, which produces an exact 90° profile. Available in diameters from 25 mm to 160 mm.

Advantages

- ▲ High concentricity and axial running accuracy due to tight manufacturing tolerances and the precision periphery ground indexable inserts.
- ▲ Irregular pitch for extremely quiet running
- ▲ Perfect chip control, reduction of chip jams
- ▲ Positive indexable insert geometries for a soft cut
- ▲ Indexable inserts with Masterfinish geometry
- ▲ Extensive range of indexable inserts

Benefits

- ▲ High surface quality
- ▲ High process security
- ▲ Wide range of applications
- ▲ Reduction in manufacturing costs

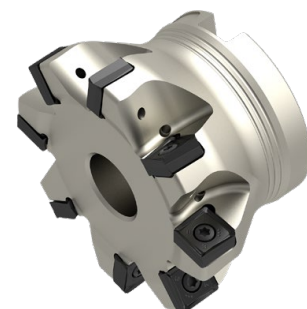

High-feed milling – MaxiMill HFC system

The high-feed milling system for extreme chip removal rates. Available in diameters from 16 mm to 160 mm.

Advantages

- ▲ Cutting depth of up to 3.3 mm
- ▲ Soft cut with positive geometry
- ▲ Stable indexable insert
- ▲ Irregular pitch for extremely quiet running
- ▲ Optimised chip spaces for excellent chip removal
- ▲ Easy handling thanks to large indexable insert
- ▲ Cutting forces are exerted primarily in the axial direction
- ▲ Minimal stress on the machine spindle

Benefits

- ▲ High chip volume
- ▲ Maximum process security
- ▲ Lower costs per part

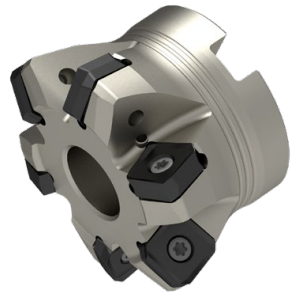

When it comes to tool clamping, it is better not to leave anything to chance. We can offer the perfect adapter for your customised machining applications, no matter how specific, with reliability guaranteed.



Rotating adapters

Static adapters

\ ADAPTERS

CLAMPING SOLUTIONS
FOR MACHINING





Rotating adapters

Reliability, radial run-out accuracy, repeatability and vibration damping – we have the perfect clamping solution for every rotating tool, whether for traditional standard applications or high-speed machining.

HyPower – Rough

The HyPower – Rough high pressure chuck guarantees robust roughing performance and is ideally suited to highly dynamic milling cutting operations.

Advantages

- ▲ Handles high-performance milling cutting operations at up to 33,000 revolutions per minute
- ▲ Maximum process security and service life thanks to award-winning industrial design
- ▲ Perfectly balanced combination of geometric and functional properties

Benefits

- ▲ Ideally suited to withstand high temperatures (80 °C – 210 °C) even during long milling cycles (> 240 minutes)
- ▲ Maximum process security, even for high-quality components



HyPower – Access 4.5°

The HyPower – Access 4.5° high pressure chuck ensures a high degree of flexibility when machining components critical to contours with its shrink-fit chuck contour.

Advantages

- ▲ Provides original shrink-fit chuck dimensions (DIN contour with 4.5°)
- ▲ Application-oriented system layout
- ▲ Perfectly balanced combination of geometric and functional properties
- ▲ Achieves best surface quality, stands out for maximum ease of handling

Benefits

- ▲ Maximum flexibility when machining components critical to contours
- ▲ Maximum process security and service life thanks to award-winning industrial design



Torsional vibration damper with ABS connection

Defined radial grooves in the flat surface of the ABS connection create the required degree of torsion freedom. This segmentation covers the entire circumference of the ABS connection and divides it into multiple axially rigid support segments. This efficiently prevents the drilling tool from being deflected by cutting forces.

Advantages

- ▲ Minimum noise level
- ▲ Low-vibration machining
- ▲ Increased process security
- ▲ Maximum service life

Benefits

- ▲ Optimised surface quality
- ▲ Reduced costs
- ▲ Less waste



HDC – Heavy Duty Chuck

The precision collet chuck for heavy machining, the focus of which is on excellent damping and a stable chuck body.

Advantages

- ▲ Optimum clamping force prevents the collet from turning in its seat
- ▲ Low vibrations due to stable base body design
- ▲ Maximum damping to counter vibrations
- ▲ Radial run-out accuracy of $\leq 3 \mu\text{m}$ at 3xD projection length

Benefits

- ▲ Versatile use for rough and finish machining
- ▲ Suitable for trochoidal milling
- ▲ Process-secure machining of high-strength or extremely tough materials



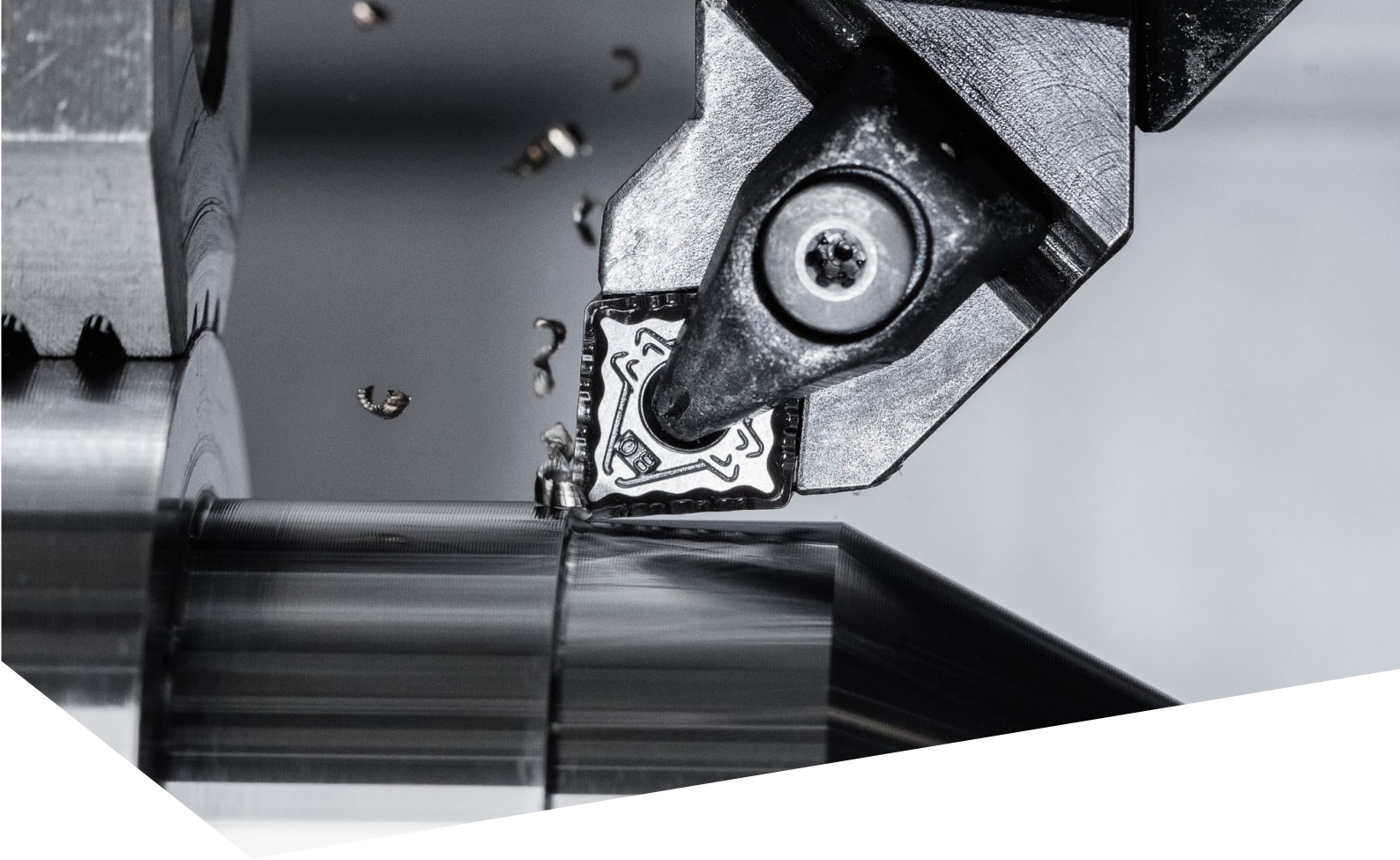

Static adapters

Whether VDI, BMT, HSK-T or PSC, our extensive standard range for static tool holders and driven tools on turning machines fulfils all and every requirement. Our manufacturing expertise means that we are even able to produce custom solutions for special applications.

PSC tool holder with DirectCooling

Tool holder with PSC interface for efficient turning.

Advantages

- ▲ Optimum cooling with fixed DirectCooling coolant nozzles
- ▲ Improved chip control
- ▲ Self-centring

Benefits

- ▲ Improved machining reliability
- ▲ Increased material removal
- ▲ Shorter machining times

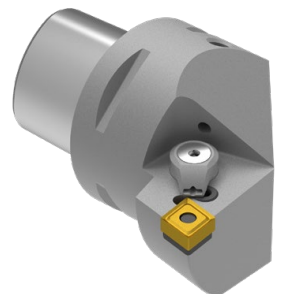

You can find our entire range of adapters in our main catalogue → Chapter 16 or online at: cuttingtools.ceratizit.com

\ WORKPIECE CLAMPING ALWAYS WELL PREPARED

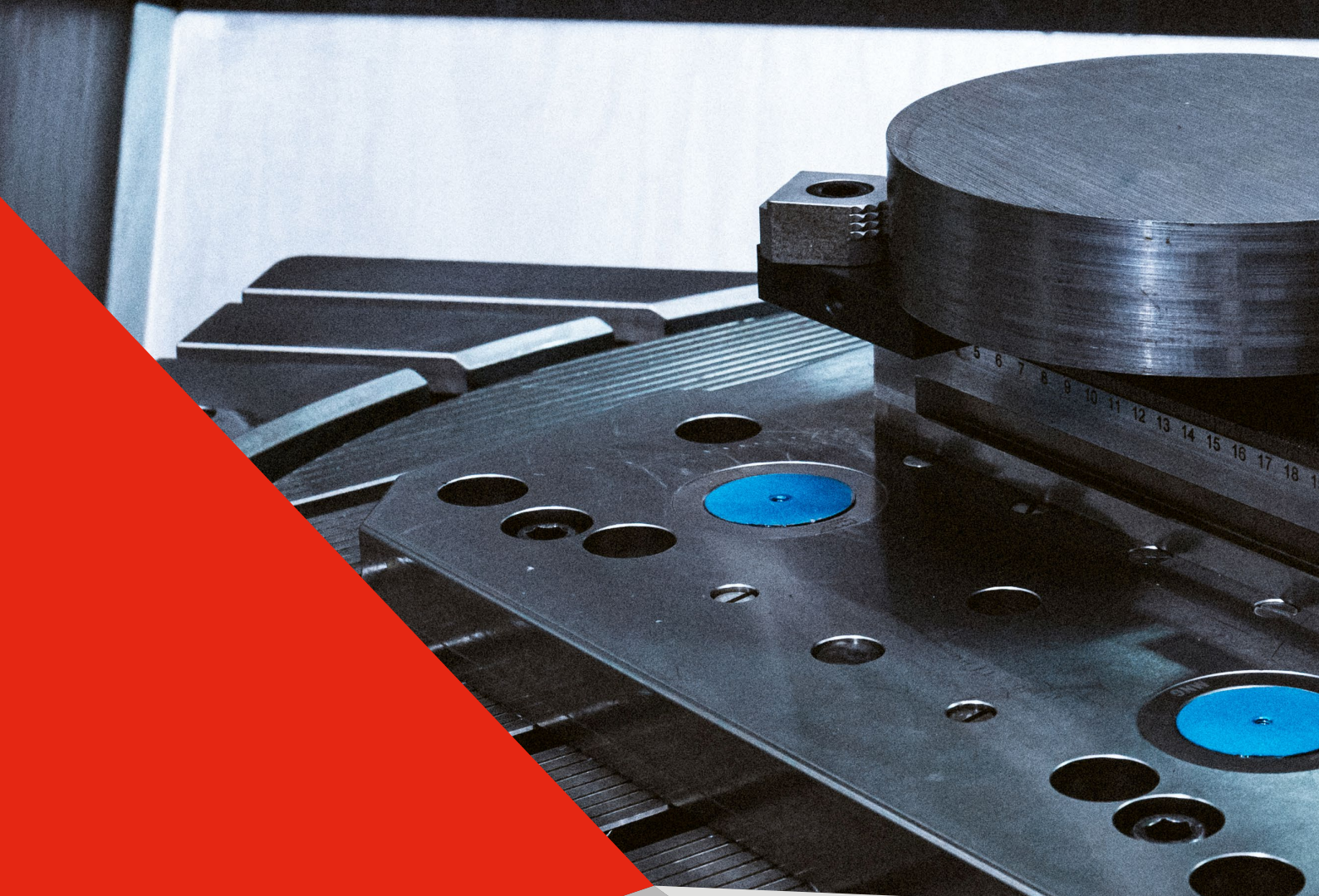

Are you looking for a reliable way of clamping workpieces with very different dimensions and shapes? Our effective workpiece clamping systems put in an impressive performance.

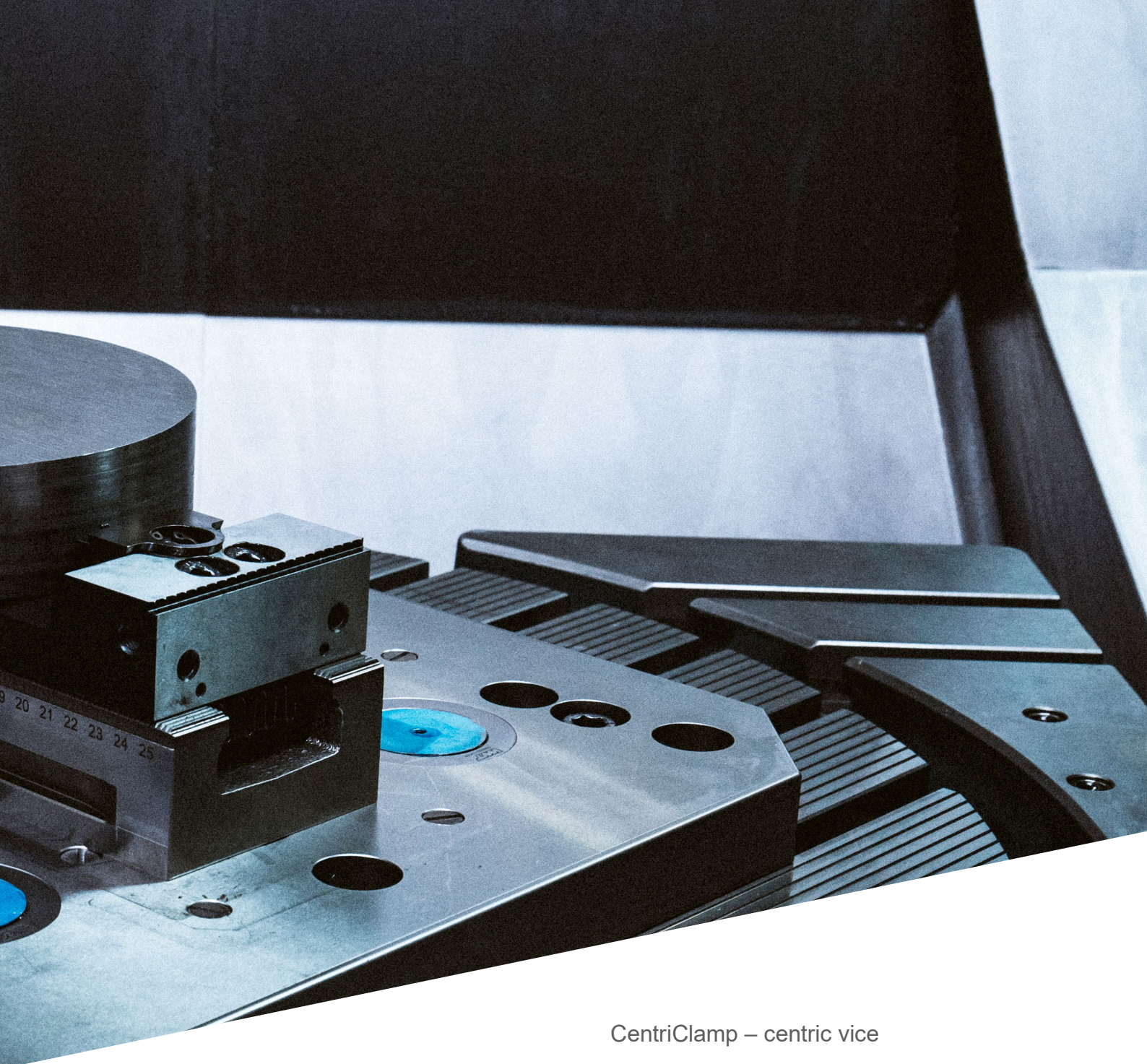

CentriClamp – centric vice

SoloClamp – single vice

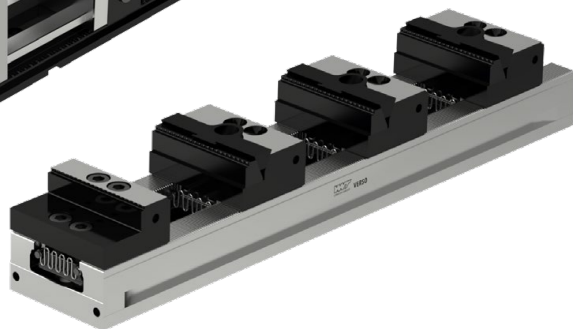
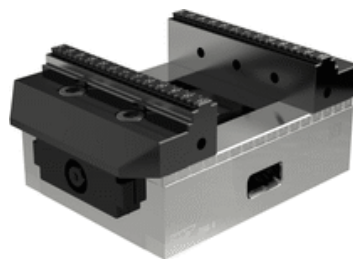

PolyClamp – multiple vice



Clamping variants

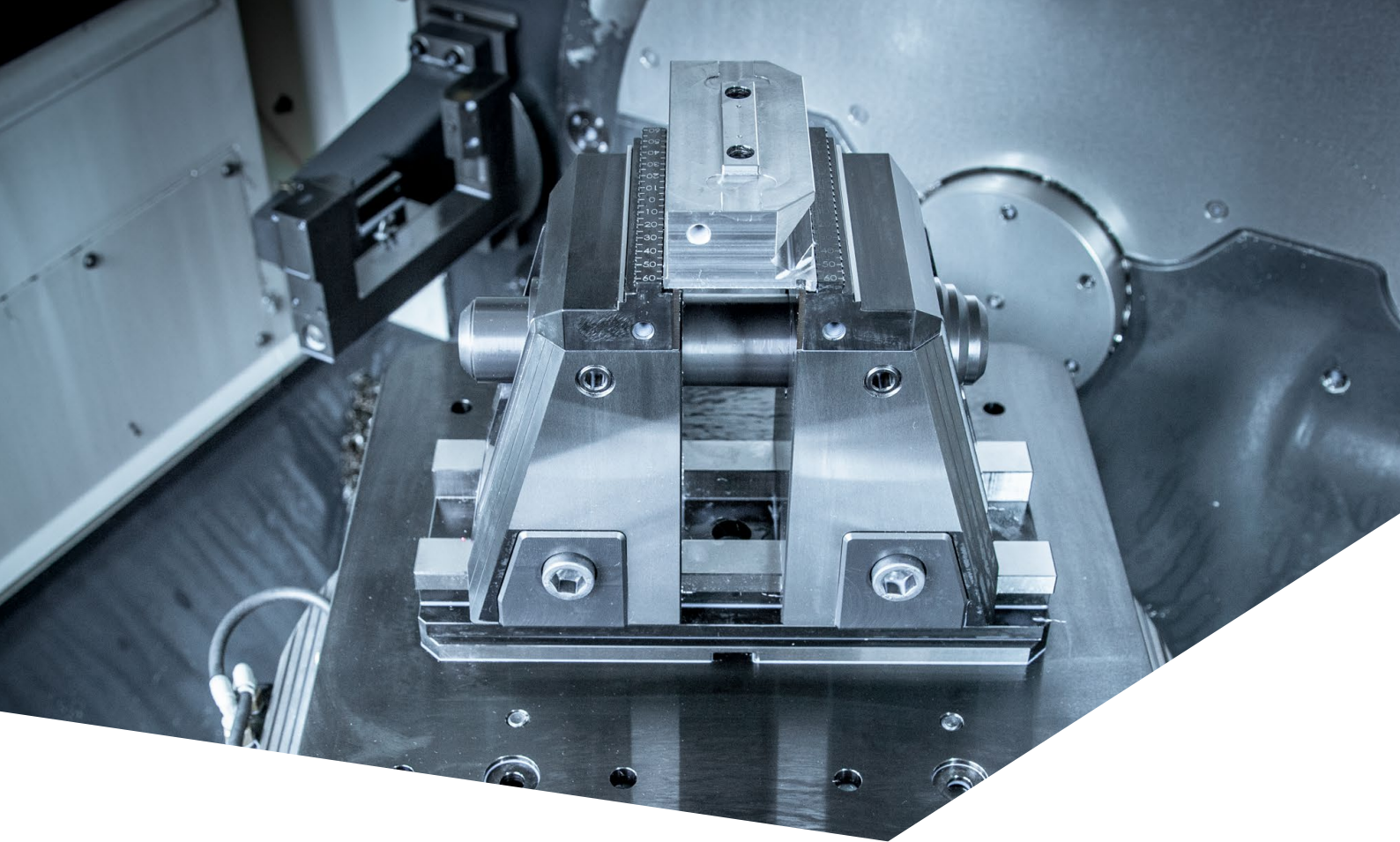

SoloClamp – single vice

SoloClamp – X5G-Z

The X5G-Z from CERATIZIT is a new, efficient and highly precise clamping system for machining centres. The five-axis clamping system impresses with its optimised accessibility from all sides.

Advantages

- ▲ Optimised against vibrations by internal elastomer damping
- ▲ Quick adjustment of clamping range with 130-mm base clamping stroke
- ▲ Shorter set-up times due to quick jaw change system

Benefits

- ▲ Easily extended to clamping range of 687 mm with fully encapsulated mechanical spindle
- ▲ Five and six-sided machining possible
- ▲ Easy handling



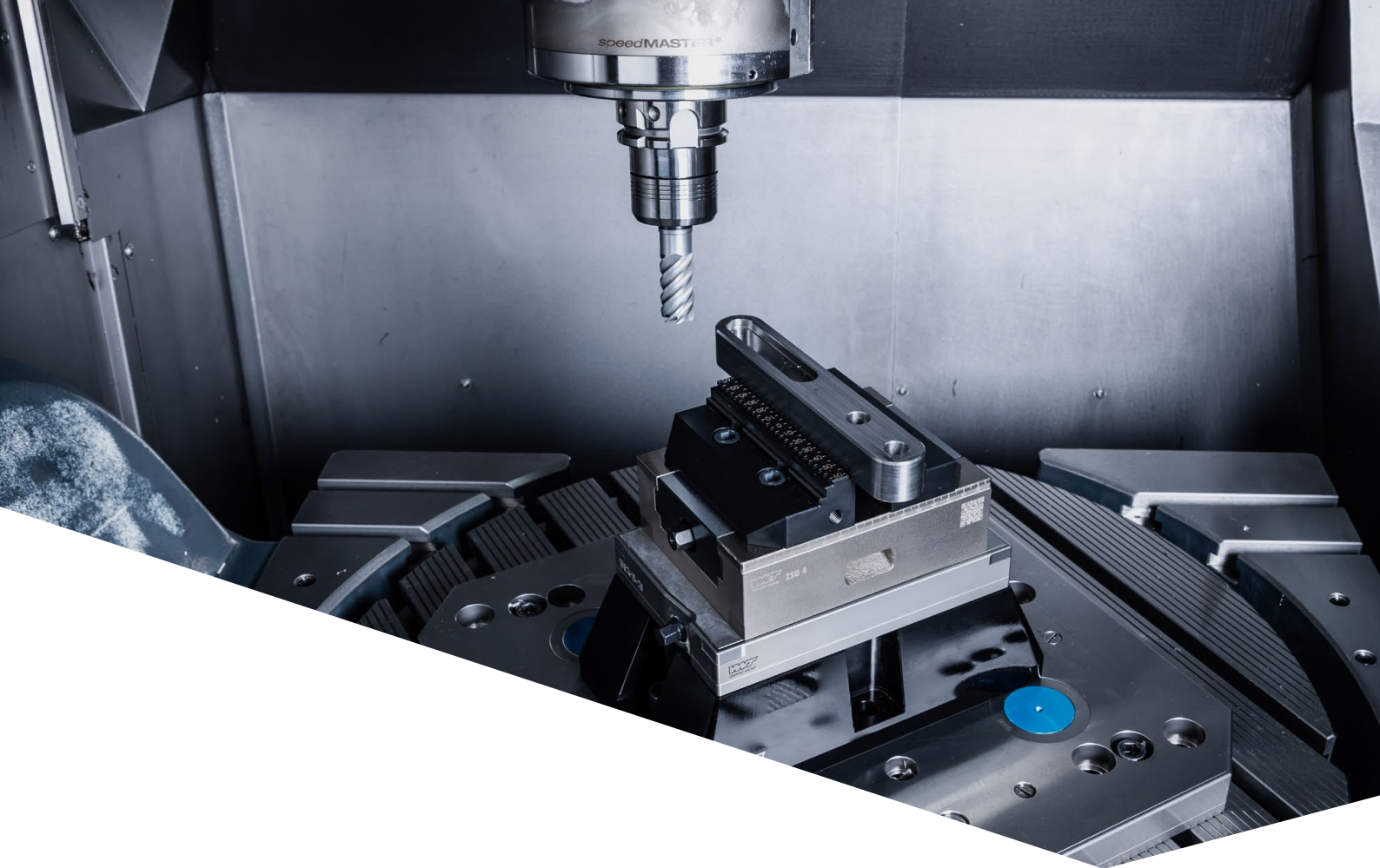

CentriClamp – centric vice

CentriClamp – ZSG 4

The new ZSG 4 retains all the cherished characteristics of its predecessor and raises the bar significantly with regard to user-friendliness and durability. Optimised handling and improved durability were top of the list in the update for the popular ZSG 4 centric vice from CERATIZIT.

Advantages

- ▲ Long service life due to nickel-plated base body
- ▲ Encapsulated spindle eliminates maintenance intervals
- ▲ High precision thanks to backlash-free mounting
- ▲ Jaws can be changed with just two screws

Benefits

- ▲ High process security due to closed system
- ▲ Easy maintenance and accessibility

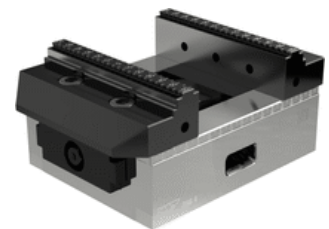

You can find our entire range of vices in our vice catalogue or online at cuttingtools.ceratizit.com

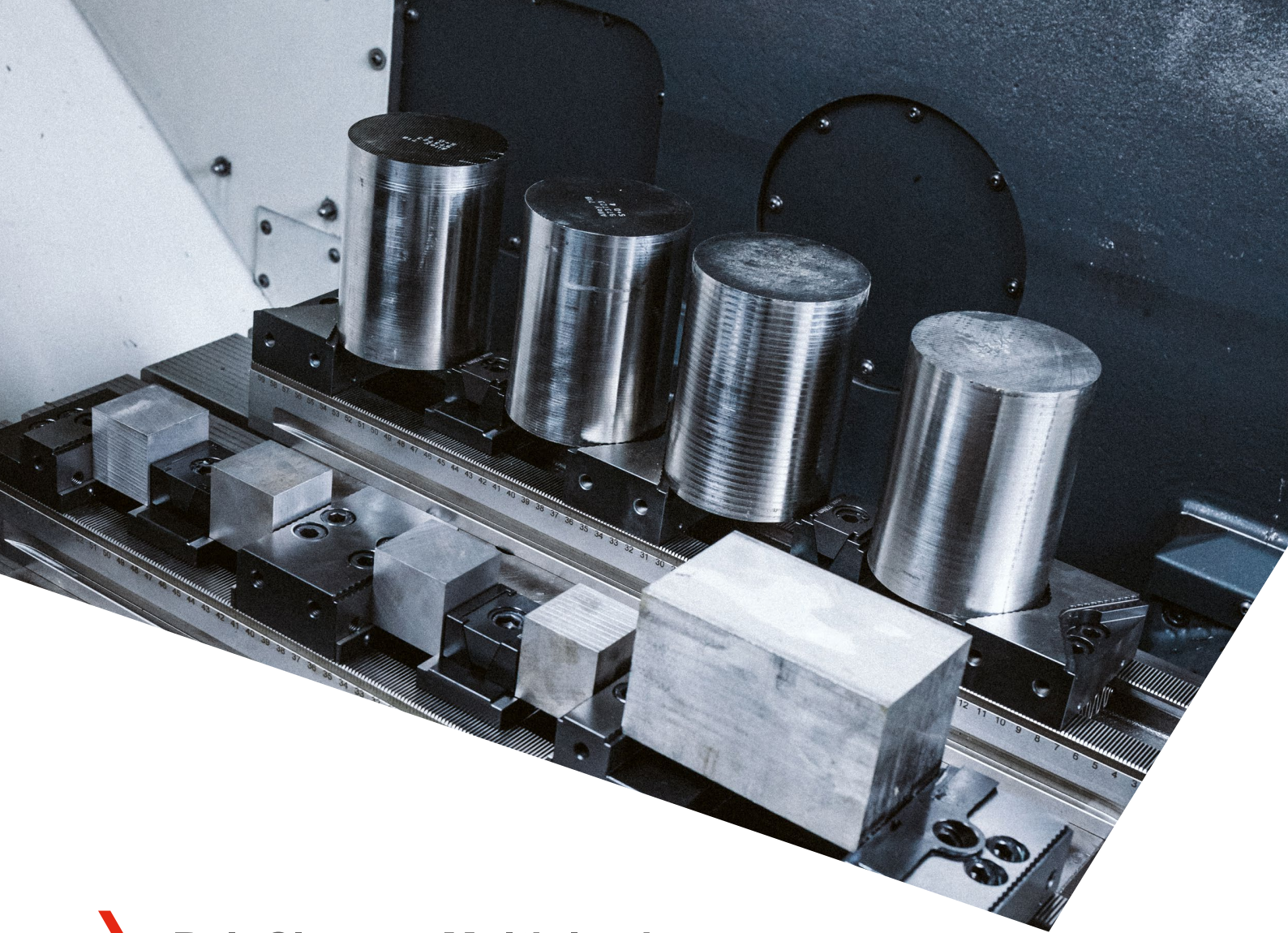

PolyClamp – Multiple vice

Anyone who is regularly required to load multi-axis machines with a wide variety of workpieces will be particularly appreciative of flexible part clamping. Even the trickiest of loading scenarios are overcome with ease thanks to the new PolyClamp – Verso.

PolyClamp – Verso

Advantages

- ▲ Hardened and ground teeth ensure the highest level of precision and dimensional stability
- ▲ Fast jaw changeover system for fixed and adjustable jaws
- ▲ Full modular range for all types of machining centres
- ▲ Multi-clamping with wedge grip elements

Benefits

- ▲ Extensive modular system jaw range
- ▲ Simple clamping bar extension with connecting element

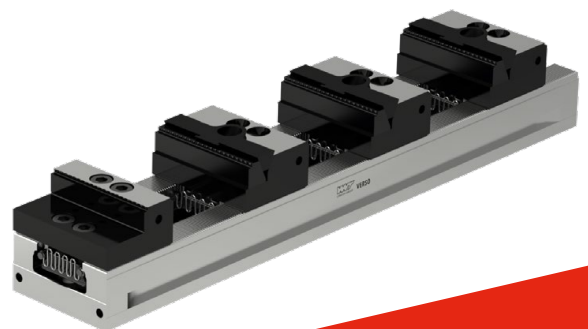

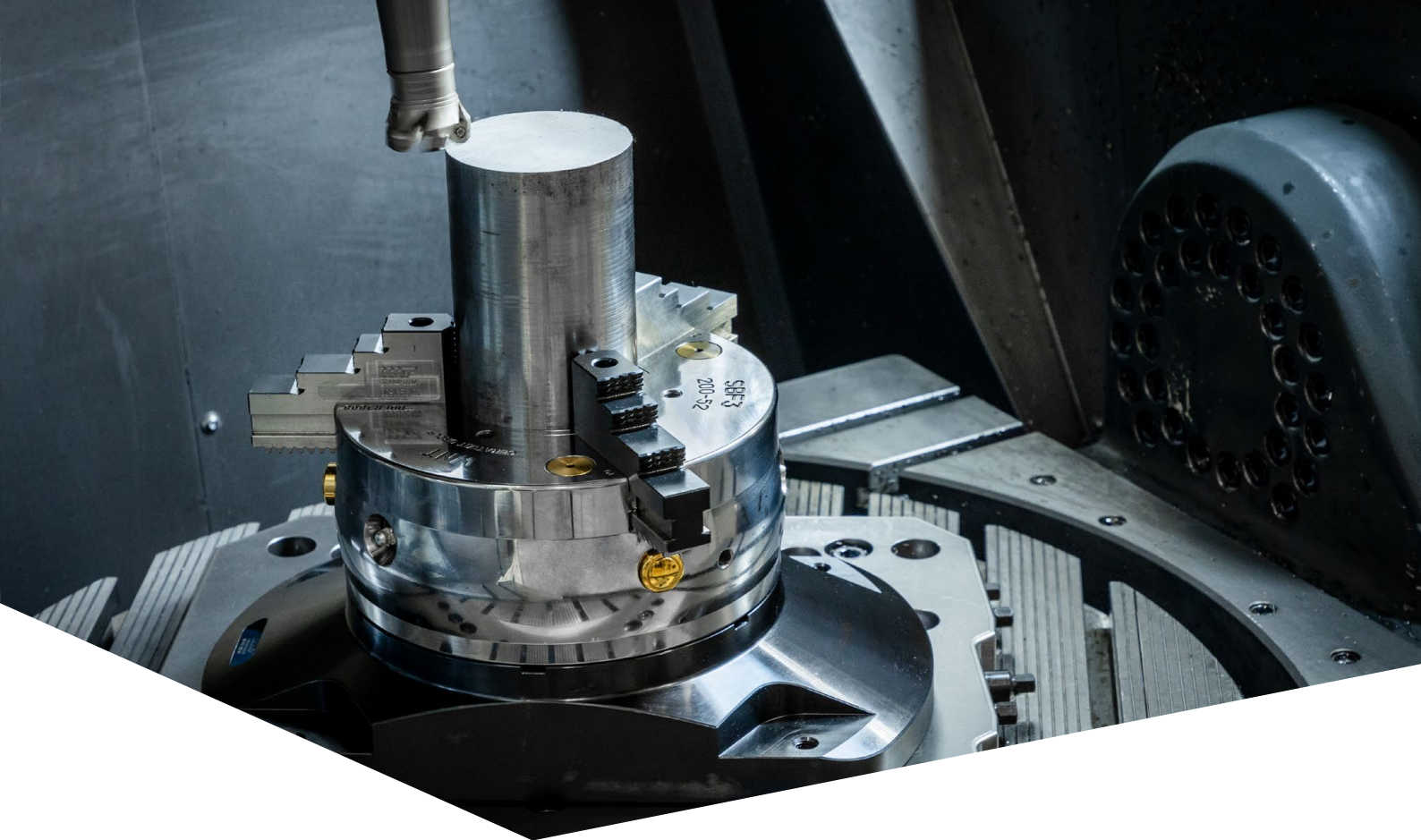

Clamping variants

The manual clamping chuck with SBF-3 quick jaw change system delivers optimum results when clamping round workpieces on machining centres. The optimised wedge bar drive and an improved lubrication system guarantee consistently high clamping forces.

SBF-3 stationary three-jaw chuck

Advantages

- ▲ High jaw change repeatability
- ▲ Flexible clamping of small and large workpieces thanks to angled toothed base jaws
- ▲ Optimised lubrication system guarantees consistently high clamping forces
- ▲ Long tool life due to functional parts that have been hardened and ground from all sides
- ▲ Modular protective sleeve system

Benefits

- ▲ Minimises set-up times and costs
- ▲ Process-secure clamping thanks to high clamping forces
- ▲ Maximum operating safety thanks to visual safety features



You can find our entire range of vices in our vice catalogue or online at cuttingtools.ceratizit.com



We reserve the right to make technical changes and product improvements.



Part of the Plansee Group