

UP **2** DATE

Stable roughing with turbo feeds!

Maximum process security including
for difficult-to-access components.

... OUR LATEST HIGHLIGHTS

- ▲ The **MaxiMill – Tangent** rough milling system compatible with actively vibration-damped shell mill adapters
- ▲ The **WTX – Micropilot** drill for extremely demanding machining operations on the smallest components with maximum precision
- ▲ Robust side and face milling cutter, the **MaxiMill – Slot-SNHX** for extra-soft cuts

CERATIZIT is a high-technology engineering group specialised in cutting tools and hard material solutions.

Tooling a Sustainable Future

ceratizit.com



Welcome!



It couldn't be easier

Ordering via the Online Shop

<https://cuttingtools.ceratizit.com>



On-site technical support

Your Local Technical Sales Engineer

Your customer number

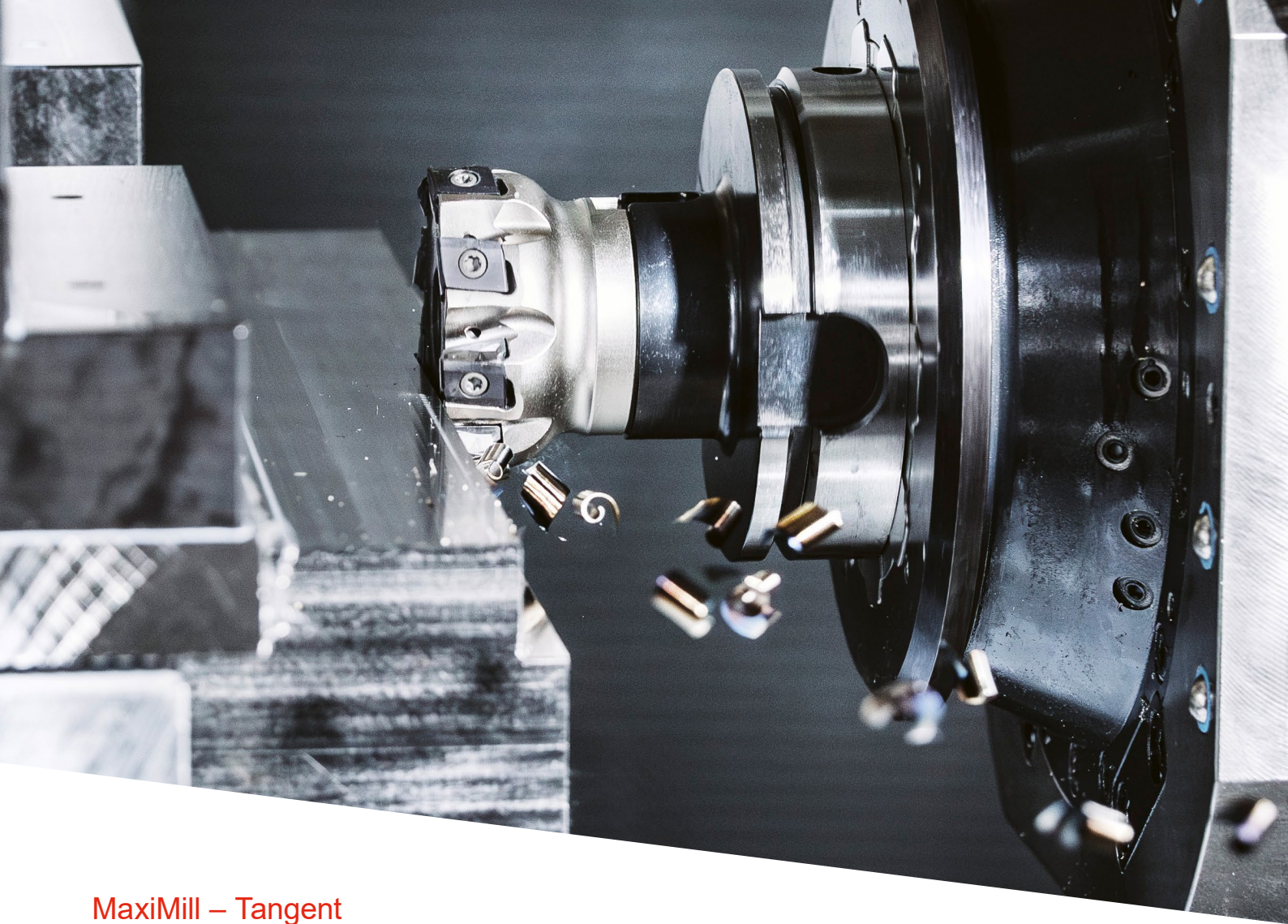

MaxiMill – Tangent

Stable roughing of steel and cast iron

CERATIZIT

Tangential indexable insert milling cutter with maximum tooth utilisation

The MaxiMill – Tangent guarantees the best cutting edge stability for turbo feeds

Do you know that? Do you have to process a component and can't see the process because of all the disruptive contours? Face milling cutters are completely out of the running, especially when long overhang lengths make stable, low-vibration machining impossible.

What might at first glance appear an insoluble dilemma, just needs the right tool – like the new **MaxiMill – Tangent**. This tangential indexable insert cutter shows its true colours when machining steel and cast iron components.



 → from page 37
You can find further information on the product here.

cts.ceratizit.com/en/maximill-tangent

The advantages of the MaxiMill – Tangent at a glance

- ▲ stable, soft-cutting system
- ▲ rugged design permits up to 50% greater feed rate per tooth
- ▲ wide variety of tool holders with different connections:
G (thread) / A (shell mill adapter) / C (cylindrical shank)
- ▲ maximum number of teeth on the milling body thanks to tangential clamping
- ▲ the best axial and concentric run-out properties due to precision-ground inserts and tight manufacturing tolerances for the tool holder
- ▲ reduced vibration thanks to irregular tooth pitch
- ▲ better accessibility allows for rapid tool change

... also compatible with actively vibration-damped adapter

→ for maximum process security including for difficult-to-access components



Ground indexable insert with extra-stable cutting edges

- ▲ Indexable inserts for diverse applications **P / K / S / M**
- ▲ 4 usable cutting edges
- ▲ Chip breakers: -F50 and -M50
- ▲ Precision-ground indexable inserts (size -09 and -13)
- ▲ Max. depth of cut:
 - with insert size -09 > 8 mm
 - with insert size -13 > 12 mm

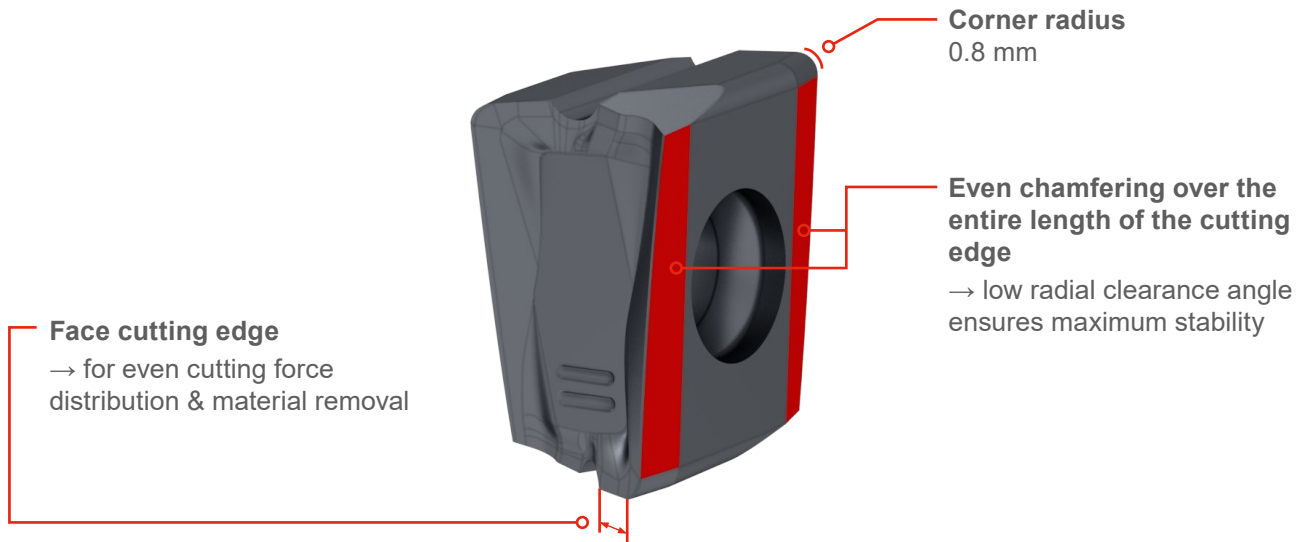

Maximum cutting edge stability



High feed rates possible

Increased tool life



Increase in performance & productivity

“

„Thanks to the super-stable design, the powerful, four-edged indexable inserts and tangential clamping by the **MaxiMill – Tangent**, we are now able to machine components with interference contours easily and economically – using the integrated feed turbo.“

Robert Frei, Product Manager Indexable Insert Milling Systems



”

WTX – Micropilot

Fewer tool changes, time and cost savings – with maximum precision

Our latest development, the WTX – Micropilot, makes the impossible possible. Whereas in the past, spot drilling on angled or curved surfaces would only have been possible with prior spot-facing for each milling cutter, now you only need one tool: the WTX – Micropilot. What if you want to produce a 90° countersink at the hole entrance, say? The WTX – Micropilot lets you do it in a single machining operation. So there is no need to change the tool, saving you time and money.

Perfectly adapted for use with our microdrill, the WTX – Micro (8xD – 30xD), the pilot drill is used up to a hole depth of 2.5xD. Its sophisticated end geometry with 160° point angle allows for clean plunging and avoids wandering by the main drill. The special Dragonskin coating ensures optimum chip evacuation and a longer tool life.



WNT



→ from page 12

You can find further information on the product here.



cts.ceratizit.com/en/wtx-micro

The advantages of the WTX – Micropilot:

- ▲ State-of-the-art: substrate, geometry, coating
- ▲ WTX – Micropilot (pilot drill) and WTX – Micro (deep hole drill) are perfectly attuned to one another
- ▲ Extremely tight tolerances ensure the deep hole drill does not wander
- ▲ Optimum chip evacuation thanks to sophisticated end geometry and DPX74M Dragonskin coating
- ▲ 90° countersink at the hole entrance possible (with flat drilling application)

▶ **Maximum productivity and process security thanks to optimised geometry and high-performance coating**

- ▲ Direct spot drilling of straight, angled and curved surfaces with an angle of inclination of up to 50°

▶ **Significant saving in time and money as there is no need for an additional tool – 2 instead of 3 process steps**



Direct spot drilling of convex and concave surfaces possible

Direct spot drilling of angled surfaces up to 50° or 90° countersink with flat drilling application



MaxiMill – Slot-SNHX

Robust side and face milling cutter system for soft cuts

CERATIZIT

MaxiMill – Slot-SNHX: Slot milling like a knife through butter

Fabricators who need to produce slots in steel, stainless steel, cast material or aluminium frequently have to battle with unstable machining processes. The solution to this long-standing problem can be found in soft-cutting side and face milling cutters that are suitable for universal application to meet varied challenges while saving on costs per cut. The **MaxiMill – Slot SNHX system** steps up to the mark here, thanks to its wide-ranging portfolio of tool holders and indexable inserts, effectively covering cutting widths from 6 mm to 16 mm and diameters from 50 mm to 200 mm.



→ from page 43

You can find further information on the product here.



cts.ceratizit.com/en/maximill-slot-snhx

Advantage/benefit

Cutter body

- ▲ Wide variety of tool holders with different connections: G (thread), A (shell mill adapter) and C (cylindrical shank)
- ▲ Cutting widths from 6 mm to 16 mm and diameters from 50 mm to 200 mm
- ▲ Excellent performance and process security via demand-driven thro' coolant
- ▲ Reduced risk of chip jams due to cut distribution
- ▲ No disruptive contours on the face due to tight manufacturing tolerances for the tool holder
- ▲ System easily adapts to special sizes and special tools

Indexable insert

- ▲ Reliable indexable inserts with wide range of applications **P / M / K / N**
- ▲ The best axial and concentric run-out properties due to precision-ground inserts
- ▲ Flat flute base and good clearance thanks to ground indexable inserts and adapted insert installation position in the tool holder
- ▲ Key feature of inserts and supports → ease of installation



L ●● left-hand insert

R ● right-hand insert

The new MaxiMill – Slot SNHX in tool life test

Application:	Reverse-side machining
Material:	SG-Iron 500 / EN-GJS 500
Tool:	MaxiMill – Slot-SNHX
a_p:	3 mm
a_e:	42 mm
Tool life:	600 pieces

- ▲ Better handling thanks to large indexable insert clamping screw
- ▲ Softer cut than competitors due to ground cutting edge
- ▲ Less time and effort for setting up due to improved service life and fewer indexable inserts

Number of finished parts

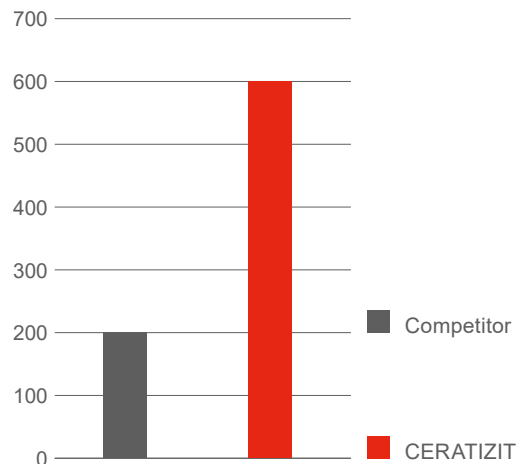

TEST RESULTS

Superior performance, tool life and ease of handling!



Pilot drill

WTX – Micropilot

Table of contents

WNT Solid carbide drilling

12–15 **WTX – Micropilot**

WNT Circular and Thread Milling

16–18 MonoThread – ZSGF

19 Product enhancement, MonoThread – SGF UNJF and UNJC

CERATIZIT Turning Tools

22–29 MaxiLock-D tool holder with DirectCooling

WNT Solid Carbide milling cutters

30–33 Milling cutter enhancement, HPC – UNI type ML

Rough milling system

MaxiMill – Tangent

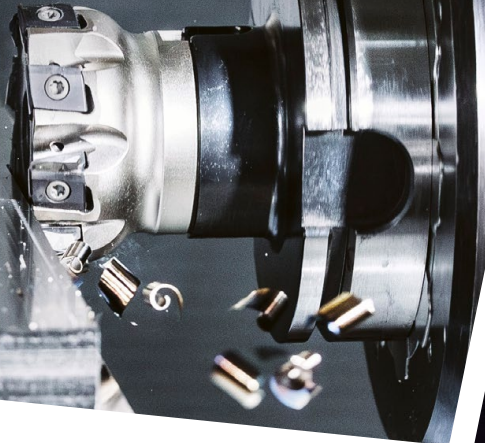

Side and face milling cutter system

MaxiMill – Slot-SNHX

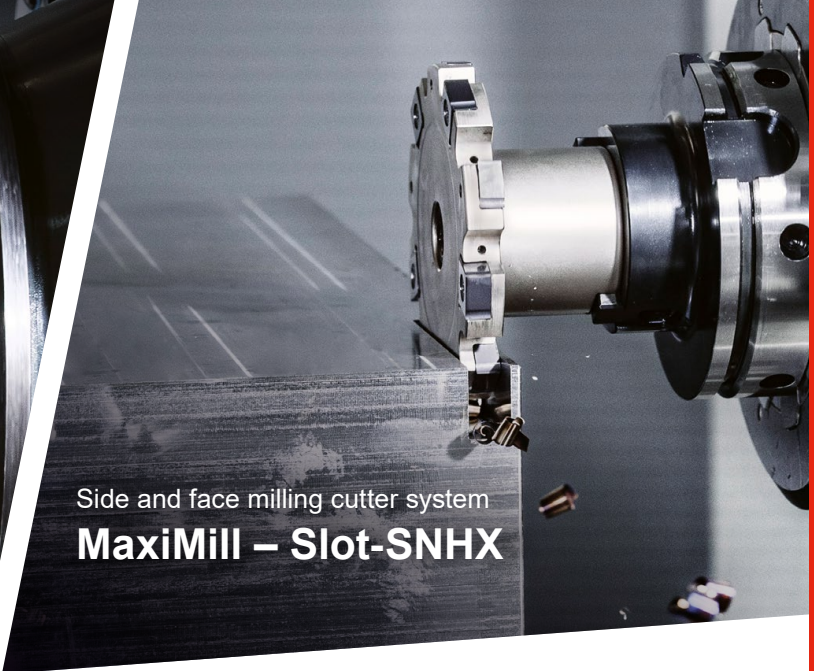

CERATIZIT Milling tools with indexable inserts

- 34–36 MaxiMill – HFCD
- 37–42 **MaxiMill – Tangent**
- 43–47 MaxiMill – Slot-SNHX

WNT Adapters and accessories

- 54–56 **Actively vibration-damped shell mill adapter**

WNT Workpiece clamping

- 58–60 MNG base plates
- 61–65 Addition, MNG Mini



Actively vibration-damped
shell mill adapter

WTX – Pilot drill 90°

- ▲ Specialised pilot drill for WTX – Micro deep hole drill (8xD–30xD)
- ▲ Direct spot drilling of angled and curved surfaces up to 50° angle of inclination possible
- ▲ 90° countersink at hole entrance can be achieved on flat spot drilling surface

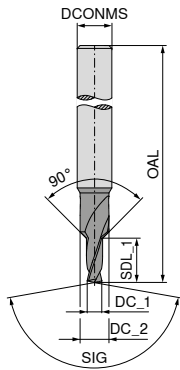
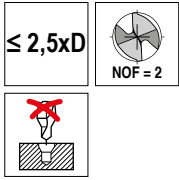

NEW

MICRO PILOT

DPX74M

DRAGONSKIN



SIG 160°

Solid carbide

10 692 ...

DC_1 _{m6}	DC_2	DCONMS _{h6}	OAL	SDL_1	
mm	mm	mm	mm	mm	
0,8	1,7	4	55	2,00	00800
0,9	1,7	4	55	2,25	00900
1,0	2,0	4	55	2,50	01000
1,1	2,0	4	55	2,75	01100
1,2	2,0	4	55	3,00	01200
1,3	2,5	4	55	3,25	01300
1,4	2,5	4	55	3,50	01400
1,5	3,0	4	55	3,75	01500
1,6	3,0	4	55	4,00	01600
1,7	3,0	4	55	4,25	01700
1,8	3,5	4	55	4,50	01800
1,9	3,5	4	55	4,75	01900
2,0	3,5	6	65	5,00	02000
2,1	3,5	6	65	5,25	02100
2,2	4,5	6	65	5,50	02200
2,3	4,5	6	65	5,75	02300
2,4	4,5	6	65	6,00	02400
2,5	4,5	6	65	6,25	02500
2,6	4,5	6	65	6,50	02600
2,7	5,0	6	65	6,75	02700
2,8	5,0	6	65	7,00	02800
2,9	5,0	6	65	7,25	02900

P	●
M	○
K	●
N	
S	●
H	
O	

→ v_c Page 13

→ Machining information: Page 14+15

Cutting data standard values – WTX – Micropilot

Material sub-group	Index	Tensile strength N/mm ² / HB / HRC	10 692 ... 2,5xD							
			without through coolant v _c (m/min)	f (mm/rev)						
				≤ Ø 1	> Ø 1–1,25	> Ø 1,25–1,5	> Ø 1,5–2	> Ø 2–2,5	> Ø 2,5–3	
P	Unalloyed steel	P.1.1	420 N/mm ² / 125 HB	70	0,010	0,013	0,015	0,019	0,022	0,025
		P.1.2	640 N/mm ² / 190 HB	60	0,010	0,013	0,015	0,019	0,022	0,025
		P.1.3	840 N/mm ² / 250 HB	60	0,010	0,013	0,015	0,019	0,022	0,025
		P.1.4	910 N/mm ² / 270 HB	60	0,010	0,013	0,015	0,019	0,022	0,025
		P.1.5	1010 N/mm ² / 300 HB	60	0,010	0,013	0,015	0,019	0,022	0,025
	Low-alloy steel	P.2.1	610 N/mm ² / 180 HB	70	0,010	0,013	0,015	0,019	0,022	0,025
		P.2.2	930 N/mm ² / 275 HB	60	0,010	0,013	0,015	0,019	0,022	0,025
		P.2.3	1010 N/mm ² / 300 HB	60	0,010	0,013	0,015	0,019	0,022	0,025
		P.2.4	1200 N/mm ² / 375 HB							
	High-alloy steel and high-alloy tool steel	P.3.1	680 N/mm ² / 200 HB	60	0,010	0,013	0,015	0,019	0,022	0,025
		P.3.2	1100 N/mm ² / 300 HB	50	0,010	0,013	0,015	0,019	0,022	0,025
		P.3.3	1300 N/mm ² / 400 HB							
	Stainless steel	P.4.1	680 N/mm ² / 200 HB	50	0,005	0,006	0,007	0,010	0,013	0,015
		P.4.2	1010 N/mm ² / 300 HB	35	0,005	0,006	0,007	0,010	0,013	0,015
M	Stainless steel	M.1.1	610 N/mm ² / 180 HB	40	0,005	0,006	0,007	0,010	0,013	0,015
		M.2.1	300 HB	40	0,005	0,006	0,007	0,010	0,013	0,015
		M.3.1	780 N/mm ² / 230 HB	40	0,005	0,006	0,007	0,010	0,013	0,015
K	Grey cast iron	K.1.1	350 N/mm ² / 180 HB	70	0,010	0,013	0,015	0,019	0,022	0,025
		K.1.2	500 N/mm ² / 260 HB	70	0,010	0,013	0,015	0,019	0,022	0,025
	Spherulitic graphite cast iron	K.2.1	540 N/mm ² / 160 HB	70	0,010	0,013	0,015	0,019	0,022	0,025
		K.2.2	845 N/mm ² / 250 HB	70	0,010	0,013	0,015	0,019	0,022	0,025
	Malleable iron	K.3.1	440 N/mm ² / 130 HB	70	0,010	0,013	0,015	0,019	0,022	0,025
		K.3.2	780 N/mm ² / 230 HB	70	0,010	0,013	0,015	0,019	0,022	0,025
N	Aluminium wrought alloy	N.1.1	60 HB							
		N.1.2	340 N/mm ² / 100 HB							
	Cast aluminium alloy	N.2.1	250 N/mm ² / 75 HB							
		N.2.2	300 N/mm ² / 90 HB							
		N.2.3	440 N/mm ² / 130 HB							
	Copper and copper alloys (bronze/brass)	N.3.1	375 N/mm ² / 110 HB							
		N.3.2	300 N/mm ² / 90 HB							
N.3.3	340 N/mm ² / 100 HB									
N.4.1	Magnesium alloys	70 HB								
S	Heat-resistant alloys	S.1.1	680 N/mm ² / 200 HB	15	0,005	0,006	0,007	0,010	0,013	0,015
		S.1.2	950 N/mm ² / 280 HB	15	0,005	0,006	0,007	0,010	0,013	0,015
		S.2.1	840 N/mm ² / 250 HB	10	0,005	0,006	0,007	0,010	0,013	0,015
		S.2.2	1180 N/mm ² / 350 HB	10	0,005	0,006	0,007	0,010	0,013	0,015
		S.2.3	1080 N/mm ² / 320 HB	10	0,005	0,006	0,007	0,010	0,013	0,015
	Titanium alloys	S.3.1	400 N/mm ²	30	0,005	0,006	0,007	0,010	0,013	0,015
		S.3.2	1050 N/mm ² / 320 HB	20	0,005	0,006	0,007	0,010	0,013	0,015
S.3.3	1400 N/mm ² / 410 HB									
H	Hardened steel	H.1.1	46–55 HRC							
		H.1.2	56–60 HRC							
		H.1.3	61–65 HRC							
		H.1.4	66–70 HRC							
	Chilled iron	H.2.1	400 HB							
Hardened cast iron	H.3.1	55 HRC								
O	Non-metal materials	O.1.1	≤ 150 N/mm ²							
		O.1.2	≤ 100 N/mm ²							
		O.2.1	≤ 1000 N/mm ²							
		O.2.2	≤ 1000 N/mm ²							
		O.3.1								

* Tensile strength



The cutting data depends extremely on the external conditions, the material and machine type. The indicated values are possible values which have to be increased or reduced according to the application conditions.

WTX – Micropilot application recommendation

General references

It is advisable to use the tool with external cooling. Be careful to ensure that the coolant is aimed directly at the tool tip. This will ensure that there is adequate cooling and effective chip evacuation. Apply our cutting data recommendations when using the tool.

1. Pilot hole in angled or curved surfaces

Produce pilot hole in one go up to a maximum hole depth of $2.5 \times D$. Angled or curved surfaces can be machined up to a max. inclination of 50° without prior spot-facing. Applying a countersink at the hole entrance is not possible on angled or curved surfaces.

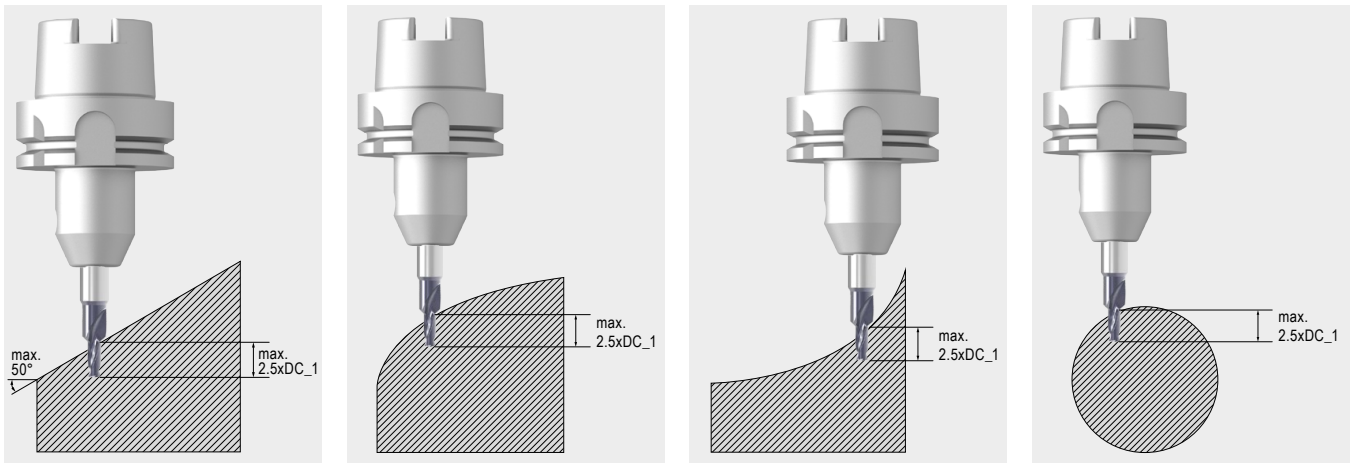

2. Pilot drill with 90° chamfer

Produce pilot hole in a single sweep. If required, a 90° chamfer can additionally be produced at the hole entrance (with flat drilling application) after the $2.5 \times D$ hole depth is reached.

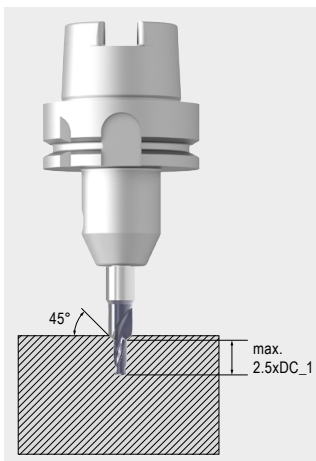

Calculating pilot hole depth with angled drilling application

With an angled drilling application, the remaining depth of the pilot hole will change depending on the angle of inclination. This can be determined using the formula below:

$$L = \text{SDL}_1 - (\text{DC}_1 \times \tan(\alpha))$$

- DC_1 = Cutting diameter
- SDL_1 = Step length (max. 2.5xDC_1)
- α = Component surface angle of inclination (max. 50°)
- L = Remaining pilot hole depth

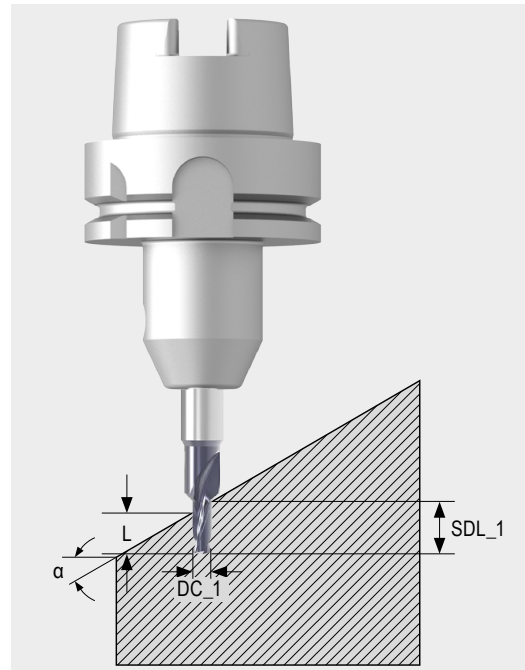

Calculating maximum hole depth with 90° countersink

The maximum hole depth incl. 90° countersink can be found using the formula below.

$$L = \left(\frac{\text{DC}_2 - \text{DC}_1}{2} \right) + \text{SDL}_1$$

- DC_1 = Cutting diameter
- DC_2 = Max. countersink diameter
- SDL_1 = Step length (max. 2.5xDC_1)
- L = Max. hole depth incl. countersink

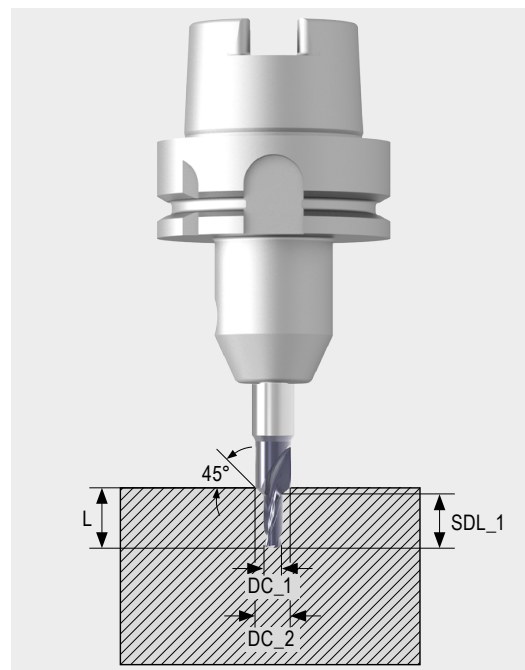

Tolerances and angles

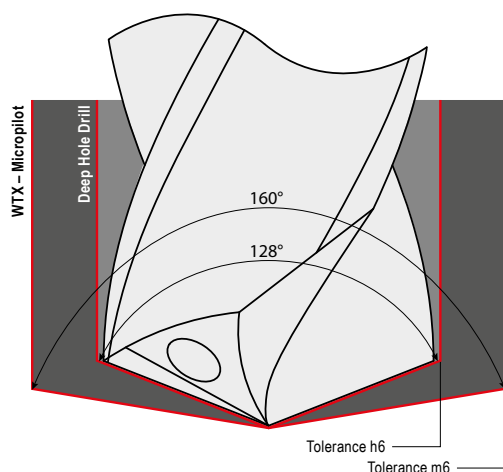

The following must apply to use the pilot and deep hole twist drill consecutively and without collisions:
 $\Delta D = \text{ØD (pilot hole)} - \text{ØD (deep hole)} > 0$

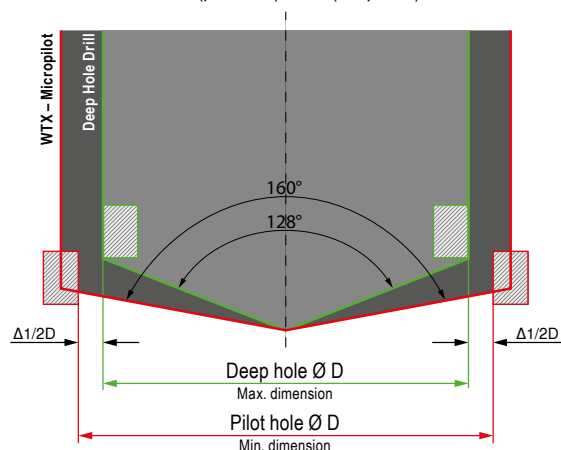

MonoThread – Circular shank thread milling cutter

▲ Profile corrected

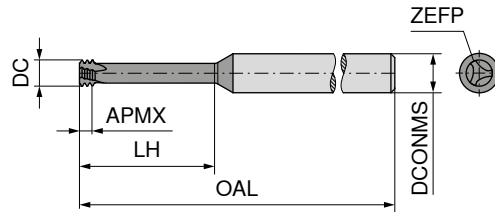
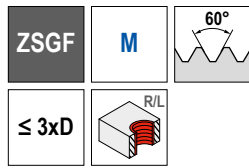

NEW
AITiN

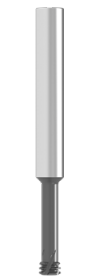

Solid carbide

50 545 ...

DC mm	Thread	TP mm	OAL mm	APMX mm	LH mm	DCONMS _{h6} mm	ZEFP	
1,53	M2	0,40	39	0,80	6,0	3	3	02000
2,37	M3	0,50	58	1,35	9,5	6	3	03000
3,10	M4	0,70	58	1,95	12,5	6	3	04000
3,80	M5	0,80	58	2,30	16,0	6	3	05000
4,65	M6	1,00	58	2,70	20,0	6	3	06000
6,00	M8	1,25	58	3,20	24,0	6	3	08000
7,80	M10	1,50	64	3,80	31,5	8	3	10000
9,00	M12	1,75	73	4,55	37,8	10	3	12000



NEW

50 550 ...

DC mm	Thread	TP mm	OAL mm	APMX mm	LH mm	DCONMS _{h6} mm	ZEFP	
1,53	M2	0,40	39	1,00	10,4	3	3	02000 ¹⁾
2,37	M3	0,50	39	1,30	12,5	3	3	03000
3,10	M4	0,70	58	1,80	16,7	6	3	04000
4,00	M5	0,80	58	2,10	20,8	6	3	05000
4,80	M6	1,00	58	2,55	25,0	6	3	06000
6,40	M8	1,25	64	3,15	33,5	8	3	08000
8,00	M10	1,50	76	3,85	41,5	8	3	10000

P	●
M	○
K	●
N	●
S	●
H	●
O	●

1) 5xD

→ v_c/f_z Page 21



→ Chapter 7 – Circular and Thread Milling

When calculating the feedrate for circular milling it is important to know whether contour feed v_t or feed on the center path v_{fm} is used.

MonoThread – Circular shank thread milling cutter

▲ Profile corrected

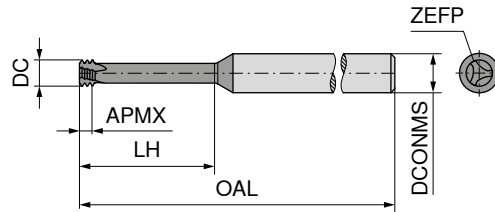
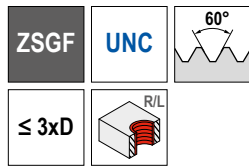

NEW
AITiN

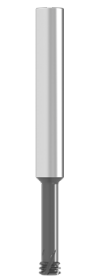

Solid carbide

50 557 ...

DC mm	Thread	TP mm	OAL mm	APMX mm	LH mm	DCONMS _{h6} mm	ZEFP	
3,678	UNC No.10-No.12	1,058	58	3,17	15,5	6	3	01000
4,697	UNC 1/4	1,27	58	3,81	19,0	6	3	01400
6,000	UNC 5/16	1,411	58	4,23	23,0	6	3	51600
7,345	UNC 3/8	1,588	64	4,76	30,2	8	3	03800
7,700	UNC 7/16	1,814	64	5,44	35,2	8	3	71600
9,376	UNC 1/2	1,954	73	5,86	40,1	10	3	01200
10,920	UNC 9/16	2,117	105	6,35	45,0	12	3	91600
11,419	UNC 5/8	2,309	105	6,93	50,0	12	3	05800
15,210	UNC 3/4	2,540	105	7,62	59,7	16	4	03400



NEW

50 559 ...

DC mm	Thread	TP mm	OAL mm	APMX mm	LH mm	DCONMS _{h6} mm	ZEFP	
4,696	UNF 1/4	0,907	58	2,72	19,0	6	3	01400
6,217	UNF 5/16, 3/8	1,058	64	3,17	24,0	8	3	51600
7,994	UNF 7/16	1,270	64	3,81	34,5	8	3	71600
11,993	UNF 5/8	1,411	105	4,23	49,0	12	4	05800

P	●
M	○
K	●
N	●
S	●
H	●
O	●

→ v_c/f_z Page 21



→ Chapter 7 – Circular and Thread Milling

When calculating the feedrate for circular milling it is important to know whether contour feed v_c or feed on the center path v_{fm} is used.

MonoThread – Circular shank thread milling cutter

▲ Profile corrected

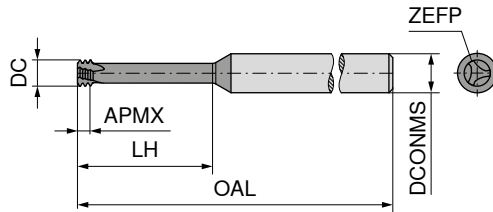
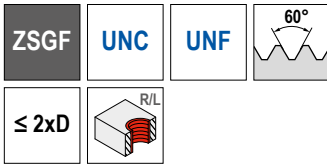

NEW
AlTiN

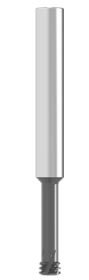

Solid carbide

50 568 ...

DC mm	Thread	TP mm	OAL mm	APMX mm	LH mm	DCONMS _{h6} mm	ZEFP	
1,400	UNC No.1 / UNF No.2	0,397	58	1,19	3,8	6	3	01200
1,646	UNC No.2 / UNF No.3	0,454	58	1,36	4,4	6	3	02300
1,901	UNC No.3 / UNF No.4	0,529	58	1,59	5,2	6	3	03400
2,034	UNC No.4	0,635	58	1,91	6,3	6	3	04000
2,416	UNC No.5 / UNF No.6	0,635	58	1,91	7,0	6	3	05600



NEW

50 569 ...

DC mm	Thread	TP mm	OAL mm	APMX mm	LH mm	DCONMS _{h6} mm	ZEFP	
7,790	G1/8	0,907	64	2,72	19,5	8	3	01800
10,015	G 1/4-3/8	1,337	73	4,01	30,0	10	4	01400
12,013	G 1/2-G7/8	1,814	84	5,44	37,0	12	4	01200
15,900	G 1-2	2,309	105	6,93	44,0	16	4	01000

P	●
M	○
K	●
N	●
S	●
H	●
O	●

→ v_c/f_z Page 21



→ Chapter 7 – Circular and Thread Milling

When calculating the feedrate for circular milling it is important to know whether contour feed v_f or feed on the center path v_{fm} is used.

MonoThread – Thread Milling Cutter

▲ Profile corrected

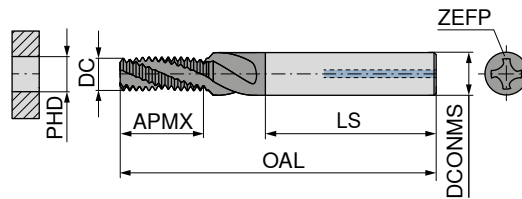
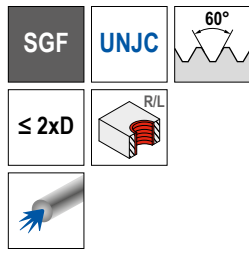

NEW
AITiN



Solid carbide

50 524 ...

DC mm	Thread	TP mm	OAL mm	APMX mm	LS mm	DCONMS _{h6} mm	ZEFP	PHD mm	
4,70	UNJC 1/4-20	0,907	55	14,27	36	6	4	5,6	01400
6,22	UNJC 5/16-18	1,411	62	16,32	36	8	4	7,0	05160
7,79	UNJC 3/8-16	1,588	74	20,01	40	10	4	8,6	03800
8,57	UNJC 7/16-14	1,814	79	22,87	45	12	4	10,0	07160
9,38	UNJC 1/2-13	1,270	79	26,75	45	12	5	11,5	01200



NEW

50 533 ...

DC mm	Thread	TP mm	OAL mm	APMX mm	LS mm	DCONMS _{h6} mm	ZEFP	PHD mm	
2,44	UNJF 6-40	0,635	42	7,42	28	4	3	2,95	06000
3,14	UNJF 8-36	0,706	49	8,91	36	6	3	3,50	08000
3,95	UNJF 10-32	0,794	55	9,97	36	6	3	4,10	10000
4,70	UNJF 1/4-28	0,907	55	14,27	36	6	4	5,60	01400
6,22	UNJF 5/16-24	1,058	62	16,59	36	8	4	7,00	05160
7,79	UNJF 3/8-24	1,058	74	19,77	40	10	4	8,60	03800
9,32	UNJF 7/16-20	1,270	79	22,39	45	12	5	10,00	07160
9,38	UNJF 1/2-20	1,270	79	25,34	45	12	5	11,50	01200
12,90	UNJF 5/8-18	1,411	102	33,59	48	16	5	14,50	05800

P	●
M	●
K	●
N	●
S	●
H	●
O	●

→ v_c/f_z Page 21



→ Chapter 7 – Circular and Thread Milling

When calculating the feedrate for circular milling it is important to know whether contour feed v_f or feed on the center path v_m is used.

Material examples for cutting data tables

	Material sub-group	Index	Composition / Structure / Heat treatment	Tensile strength N/mm ² / HB / HRC	Material number	Material designation	Material number	Material designation
P	Unalloyed steel	P.1.1	< 0,15 % C Annealed	420 N/mm ² / 125 HB	1.0401	C15	1.1141	Ck15
		P.1.2	< 0,45 % C Annealed	640 N/mm ² / 190 HB	1.1191	C45E	1.0718	9SMnPb28
		P.1.3	< 0,45 % C Tempered	840 N/mm ² / 250 HB	1.1191	C45E	1.0535	C55
		P.1.4	< 0,75 % C Annealed	910 N/mm ² / 270 HB	1.1223	C60R	1.0535	C55
		P.1.5	< 0,75 % C Tempered	1010 N/mm ² / 300 HB	1.1223	C60R	1.0727	45S20
	Low-alloy steel	P.2.1	Annealed	610 N/mm ² / 180 HB	1.7131	16MnCr5	1.6587	17CrNiMo6
		P.2.2	Tempered	930 N/mm ² / 275 HB	1.7131	16MnCr5	1.6587	17CrNiMo6
		P.2.3	Tempered	1010 N/mm ² / 300 HB	1.7225	42CrMo4	1.3505	100Cr6
		P.2.4	Tempered	1200 N/mm ² / 375 HB	1.7225	42CrMo4	1.3505	100Cr6
	High-alloy steel and high-alloy tool steel	P.3.1	Annealed	680 N/mm ² / 200 HB	1.4021	X20Cr13	1.4034	X46Cr13
		P.3.2	Hardened and tempered	1100 N/mm ² / 300 HB	1.2343	X38CrMoV5-1	1.4034	X46Cr13
		P.3.3	Hardened and tempered	1300 N/mm ² / 400 HB	1.2343	X38CrMoV5-1	1.4034	X46Cr13
	Stainless steel	P.4.1	Ferritic / martensitic Annealed	680 N/mm ² / 200 HB	1.4016	X6Cr17	1.2316	X36CrMo16
		P.4.2	Martensitic Tempered	1010 N/mm ² / 300 HB	1.4112	X90CrMoV18	1.2316	X36CrMo16
M	Stainless steel	M.1.1	Austenitic / austenitic-ferritic Quenched	610 N/mm ² / 180 HB	1.4301	X5CrNi18-10	1.4571	X6CrNiMoTi17-12-2
		M.2.1	Austenitic Tempered	300 HB	1.4841	X15CrNiSi25-21	1.4539	X1NiCrMoCu25-20-5
		M.3.1	Austenitic / ferritic (Duplex)	780 N/mm ² / 230 HB	1.4462	X2CrNiMoN22-5-3	1.4501	X2CrNiMoCuWN25-7-4
K	Grey cast iron	K.1.1	Pearlitic / ferritic	350 N/mm ² / 180 HB	0.6010	GG-10	0.6025	GG-25
		K.1.2	Pearlitic (martensitic)	500 N/mm ² / 260 HB	0.6030	GG-30	0.6045	GG-45
	Spherulitic graphite cast iron	K.2.1	Ferritic	540 N/mm ² / 160 HB	0.7040	GGG-40	0.7060	GGG-60
		K.2.2	Pearlitic	845 N/mm ² / 250 HB	0.7070	GGG-70	0.7080	GGG-80
	Malleable iron	K.3.1	Ferritic	440 N/mm ² / 130 HB	0.8035	GTW-35-04	0.8045	GTW-45
		K.3.2	Pearlitic	780 N/mm ² / 230 HB	0.8165	GTS-65-02	0.8170	GTS-70-02
N	Aluminium wrought alloy	N.1.1	Non-hardenable	60 HB	3.0255	Al99,5	3.3315	AlMg1
		N.1.2	Hardenable Age-hardened	340 N/mm ² / 100 HB	3.1355	AlCuMg2	3.2315	AlMgSi1
	Cast aluminium alloy	N.2.1	≤ 12 % Si, non-hardenable	250 N/mm ² / 75 HB	3.2581	G-AlSi12	3.2163	G-AlSi9Cu3
		N.2.2	≤ 12 % Si, hardenable Age-hardened	300 N/mm ² / 90 HB	3.2134	G-AlSi5Cu1Mg	3.2373	G-AlSi9Mg
		N.2.3	> 12 % Si, non-hardenable	440 N/mm ² / 130 HB		G-AlSi17Cu4Mg		G-AlSi18CuNiMg
	Copper and copper alloys (bronze/brass)	N.3.1	Free-machining alloys, PB > 1 %	375 N/mm ² / 110 HB	2.0380	CuZn39Pb2 (Ms58)	2.0410	CuZn44Pb2
		N.3.2	CuZn, CuSnZn	300 N/mm ² / 90 HB	2.0331	CuZn15	2.4070	CuZn28Sn1As
		N.3.3	CuSn, lead-free copper and electrolytic copper	340 N/mm ² / 100 HB	2.0060	E-Cu57	2.0590	CuZn40Fe
	Magnesium alloys	N.4.1	Magnesium and magnesium alloys	70 HB	3.5612	MgAl6Zn	3.5312	MgAl3Zn
S	Heat-resistant alloys	S.1.1	Fe - basis Annealed	680 N/mm ² / 200 HB	1.4864	X12NiCrSi 36-16	1.4865	G-X40NiCrSi38-18
		S.1.2	Fe - basis Age-hardened	950 N/mm ² / 280 HB	1.4980	X6NiCrTiMoVB25-15-2	1.4876	X10NiCrAlTi32-20
		S.2.1	Ni or Co basis Annealed	840 N/mm ² / 250 HB	2.4631	NiCr20TiAl (Nimonic80A)	3.4856	NiCr22Mo9Nb
		S.2.2	Ni or Co basis Age-hardened	1180 N/mm ² / 350 HB	2.4668	NiCr19Nb5Mo3 (Inconel 718)	2.4955	NiFe25Cr20NbTi
		S.2.3	Ni or Co basis Cast	1080 N/mm ² / 320 HB	2.4765	CoCr20W15Ni	1.3401	G-X120Mn12
	Titanium alloys	S.3.1	Pure titanium	400 N/mm ²	3.7025	Ti99,8	3.7034	Ti99,7
		S.3.2	Alpha + beta alloys Age-hardened	1050 N/mm ² / 320 HB	3.7165	TiAl6V4	Ti-6246	Ti-6Al-2Sn-4Zr-6Mo
S.3.3	Beta alloys	1400 N/mm ² / 410 HB	Ti555.3	Ti-5Al-5V-5Mo-3Cr	R56410	Ti-10V-2Fe-3Al		
H	Hardened steel	H.1.1	Hardened and tempered	46–55 HRC				
		H.1.2	Hardened and tempered	56–60 HRC				
		H.1.3	Hardened and tempered	61–65 HRC				
		H.1.4	Hardened and tempered	66–70 HRC				
	Chilled iron	H.2.1	Cast	400 HB				
Hardened cast iron	H.3.1	Hardened and tempered	55 HRC					
O	Non-metal materials	O.1.1	Plastics, duroplastic	≤ 150 N/mm ²				
		O.1.2	Plastics, thermoplastic	≤ 100 N/mm ²				
		O.2.1	Aramid fibre-reinforced	≤ 1000 N/mm ²				
		O.2.2	Glass/carbon-fibre reinforced	≤ 1000 N/mm ²				
		O.3.1	Graphite					

* Tensile strength

Cutting data standard values

Index	50 545 ..., 50 550 ..., 50 557 ..., 50 559 ..., 50 568 ..., 50 569 ...				50 524 ..., 50 533 ...			
	ZSGF	AITiN – Performance Solid carbide			SGF	AITiN – Performance Solid carbide		
		Ø 1,5 – 5,9	Ø 6,0 – 11,9	Ø 12,0 – 20,0		Ø 2,4 – 5,9	Ø 6,0 – 11,9	Ø 12,0 – 20,0
	v_c (m/min)	f_z (mm/tooth)			v_c (m/min)	f_z (mm/tooth)		
P.1.1	60–120	0,04–0,11	0,13–0,17	0,18–0,20	80–150	0,015–0,04	0,04–0,08	0,08–0,15
P.1.2	60–120	0,04–0,11	0,13–0,17	0,18–0,20	80–120	0,015–0,04	0,04–0,08	0,08–0,15
P.1.3	60–120	0,04–0,11	0,13–0,17	0,18–0,20	80–120	0,015–0,04	0,04–0,08	0,08–0,15
P.1.4	60–120	0,04–0,11	0,13–0,17	0,18–0,20	80–120	0,015–0,04	0,04–0,08	0,08–0,15
P.1.5	60–120	0,04–0,11	0,13–0,17	0,18–0,20	60–100	0,01–0,04	0,04–0,06	0,04–0,10
P.2.1	60–90	0,03–0,08	0,09–0,14	0,14–0,18	80–120	0,015–0,04	0,04–0,08	0,08–0,15
P.2.2	60–90	0,03–0,08	0,09–0,14	0,14–0,18	80–100	0,015–0,04	0,04–0,08	0,08–0,15
P.2.3	60–90	0,03–0,08	0,09–0,14	0,14–0,18	80–100	0,010–0,04	0,04–0,08	0,08–0,15
P.2.4	60–90	0,03–0,08	0,09–0,14	0,14–0,18	80–100	0,010–0,04	0,04–0,08	0,08–0,15
P.3.1	50–80	0,03–0,08	0,09–0,14	0,14–0,18	70–90	0,01–0,03	0,03–0,05	0,06–0,12
P.3.2	50–80	0,03–0,08	0,09–0,14	0,14–0,18	60–80	0,006–0,02	0,02–0,04	0,04–0,06
P.3.3	50–80	0,03–0,08	0,09–0,14	0,14–0,18	50–70	0,006–0,02	0,02–0,04	0,04–0,06
P.4.1	50–80	0,03–0,08	0,09–0,14	0,14–0,18	70–90	0,006–0,02	0,02–0,04	0,04–0,06
P.4.2	50–80	0,03–0,08	0,09–0,14	0,14–0,18	60–80	0,006–0,02	0,02–0,04	0,04–0,06
M.1.1	60–90	0,02–0,06	0,06–0,11	0,12–0,13	60–100	0,01–0,04	0,04–0,08	0,08–0,10
M.2.1	60–90	0,02–0,06	0,06–0,11	0,12–0,13	60–100	0,01–0,03	0,03–0,06	0,06–0,10
M.3.1	60–90	0,02–0,06	0,06–0,11	0,12–0,13	60–100	0,01–0,03	0,03–0,06	0,06–0,10
K.1.1	40–80	0,04–0,11	0,13–0,17	0,17–0,18	80–120	0,02–0,06	0,06–0,12	0,10–0,15
K.1.2	40–80	0,04–0,11	0,13–0,17	0,17–0,18	80–120	0,02–0,05	0,05–0,10	0,10–0,12
K.2.1	40–80	0,04–0,11	0,13–0,17	0,17–0,18	80–100	0,02–0,05	0,05–0,10	0,08–0,15
K.2.2	40–80	0,04–0,11	0,13–0,17	0,17–0,18	80–100	0,02–0,05	0,05–0,10	0,08–0,12
K.3.1	40–80	0,04–0,11	0,13–0,17	0,17–0,18	80–100	0,015–0,05	0,05–0,08	0,08–0,12
K.3.2	40–80	0,04–0,11	0,13–0,17	0,17–0,18	80–100	0,015–0,03	0,03–0,08	0,08–0,12
N.1.1	100–200	0,04–0,11	0,13–0,16	0,17–0,18	100–400	0,04–0,09	0,08–0,15	0,12–0,20
N.1.2	100–200	0,04–0,11	0,13–0,16	0,17–0,18	100–400	0,04–0,09	0,08–0,15	0,12–0,20
N.2.1	100–200	0,04–0,1	0,07–0,16	0,17–0,18	100–400	0,04–0,09	0,08–0,15	0,12–0,20
N.2.2	100–200	0,04–0,1	0,07–0,16	0,17–0,18	100–400	0,04–0,09	0,08–0,15	0,12–0,20
N.2.3	60–140	0,04–0,06	0,07–0,11	0,13–0,14	100–250	0,04–0,09	0,08–0,15	0,12–0,20
N.3.1	50–200	0,05–0,16	0,14–0,19	0,19–0,20	100–400	0,04–0,09	0,08–0,15	0,12–0,20
N.3.2	50–200	0,05–0,16	0,14–0,19	0,19–0,20	100–400	0,04–0,09	0,08–0,15	0,12–0,20
N.3.3	50–200	0,05–0,16	0,14–0,19	0,19–0,20	100–400	0,04–0,09	0,08–0,15	0,12–0,20
N.4.1	50–200	0,04–0,11	0,07–0,17	0,17–0,18	100–400	0,04–0,09	0,08–0,15	0,12–0,20
S.1.1	20–40	0,03–0,05	0,06–0,07	0,08	40–100	0,01–0,04	0,04–0,07	0,07–0,12
S.1.2	20–40	0,03–0,05	0,06–0,07	0,08				
S.2.1	20–40	0,03–0,05	0,06–0,07	0,08				
S.2.2	20–40	0,03–0,05	0,06–0,07	0,08				
S.2.3	20–40	0,03–0,05	0,06–0,07	0,08				
S.3.1	20–40	0,03–0,05	0,06–0,07	0,08	40–100	0,01–0,04	0,04–0,07	0,07–0,15
S.3.2	20–40	0,03–0,05	0,06–0,07	0,08				
S.3.3	20–40	0,03–0,05	0,06–0,07	0,08				
H.1.1								
H.1.2								
H.1.3								
H.1.4								
H.2.1								
H.3.1								
O.1.1	100–200	0,06–0,16	0,19–0,22	0,22–0,3	100–400	0,03–0,08	0,08–0,15	0,15–0,20
O.1.2	100–200	0,06–0,16	0,19–0,22	0,22–0,3	100–400	0,03–0,08	0,08–0,15	0,15–0,20
O.2.1	100–200	0,06–0,16	0,19–0,22	0,22–0,3	50–80	0,03–0,08	0,08–0,15	0,15–0,20
O.2.2	100–200	0,06–0,16	0,19–0,22	0,22–0,3	50–80	0,03–0,08	0,08–0,15	0,15–0,20
O.3.1	60–140	0,05–0,15	0,14–0,20	0,20–0,25				



The cutting data is strongly influenced by external conditions, such as the stability of the tool and workpiece clamping, material and type of machine. The specified values represent guideline cutting data that can be adjusted by approx. $\pm 20\%$ according to the usage conditions.

MaxiLock-D – DCLN 95° DC – Toolholder with top clamping

Scope of supply:

Tool holder with Torx key

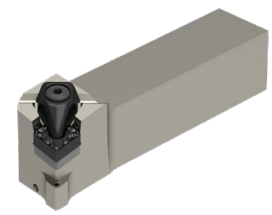
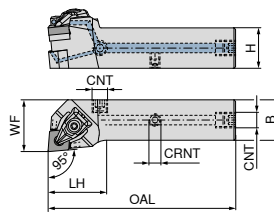

Illustrations show right-hand versions

NEW Left-hand **70 510 ...**
NEW Right-hand **70 510 ...**

ISO designation	H mm	B mm	OAL mm	LH mm	WF mm	CRNT	CNT	torque moment Nm	Insert	70 510 ...	70 510 ...
DCLN R/L 2020 X09 DC	20	20	94	25	25	M6	G1/8"	2	CN.. 0903	52000	52001
DCLN R/L 2020 X12 DC	20	20	101	32	25	M6	G1/8"	4	CN.. 1204	62000	62001
DCLN R/L 2525 X12 DC	25	25	116	32	32	M6	G1/8"	4	CN.. 1204	62500	62501
DCLN R/L 3225 X12 DC	32	25	132	32	32	M6	G1/8"	4	CN.. 1204	63200	63201
DCLN R/L 2525 X16 DC	25	25	122	38	32	M6	G1/8"	6,5	CN.. 1606	72500	72501
DCLN R/L 3232 X16 DC	32	32	142	42	40	M6	G1/8"	6,5	CN.. 1606	73200	73201
DCLN R/L 3232 X19 DC	32	32	142	42	40	M6	G1/8"	6,5	CN.. 1906	83200	83201
DCLN R/L 4040 X19 DC	40	40	167	42	50	M6	G1/8"	6,5	CN.. 1906	94000	94001



Clamping screw



Carbide type C



Grubscrew

70 950 ...

70 950 ...

70 950 ...

Spare parts for Article no.

70 510 52000 / 70 510 52001	M3x7 - IP	819	848	M6x6	86700
70 510 62000 / 70 510 62001	M4,5x12 - IP	820	810	M6x6	86700
70 510 62500 / 70 510 62501	M4,5x12 - IP	820	810	M6x6	86700
70 510 63200 / 70 510 63201	M4,5x12 - IP	820	810	M6x6	86700
70 510 72500 / 70 510 72501	M5x14 - IP	821	814	M6x6	86700
70 510 73200 / 70 510 73201	M5x14 - IP	821	814	M6x6	86700
70 510 83200 / 70 510 83201	M5x14 - IP	821	816	M6x6	86700
70 510 94000 / 70 510 94001	M5x14 - IP	821	816	M6x6	86700



XPress type



Key D

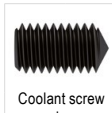

Coolant screw plug

70 950 ...

80 950 ...

70 950 ...

Spare parts for Article no.

70 510 52000 / 70 510 52001	823	T09 - IP	126	G 1/8"	294
70 510 62000 / 70 510 62001	824	T15 - IP	128	G 1/8"	294
70 510 62500 / 70 510 62501	824	T15 - IP	128	G 1/8"	294
70 510 63200 / 70 510 63201	824	T15 - IP	128	G 1/8"	294
70 510 72500 / 70 510 72501	825	T20 - IP	129	G 1/8"	294
70 510 73200 / 70 510 73201	825	T20 - IP	129	G 1/8"	294
70 510 83200 / 70 510 83201	826	T20 - IP	129	G 1/8"	294
70 510 94000 / 70 510 94001	826	T20 - IP	129	G 1/8"	294

MaxiLock-D – DCBN 75° DC – Toolholder with top clamping

Scope of supply:

Tool holder with Torx key

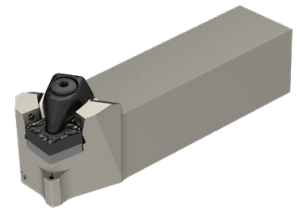
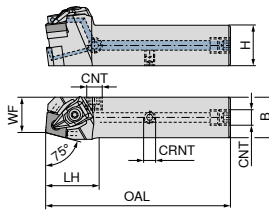

Illustrations show right-hand versions

NEW Left-hand **70 507 ...**
NEW Right-hand **70 507 ...**

ISO designation	H mm	B mm	OAL mm	LH mm	WF mm	CRNT	CNT	torque moment Nm	Insert	70 507 ...	70 507 ...
DCBN R/L 2525 X12 DC	25	25	114	30	22	M6	G1/8"	4	CN.. 1204	82500	82501
DCBN R/L 2525 X16 DC	25	25	120	36	22	M6	G1/8"	6,5	CN.. 1606	62500	62501

Spare parts for Article no.

Article no.	Clamping screw	Carbide type C	Grubscrew
70 507 82500 / 70 507 82501	M4,5x12 - IP 820	810 M6x6	86700
70 507 62500 / 70 507 62501	M5x14 - IP 821	814 M6x6	86700

Spare parts for Article no.

Article no.	XPress type	Key D	Coolant screw plug
70 507 82500 / 70 507 82501	824 T15 - IP	128 G 1/8"	294
70 507 62500 / 70 507 62501	825 T20 - IP	129 G 1/8"	294

MaxiLock-D – DDJN 93° DC – Toolholder with top clamping

Scope of supply:

Tool holder with Torx key

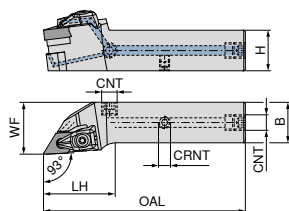

Illustrations show right-hand versions

NEW Left-hand **70 546 ...**
NEW Right-hand **70 546 ...**

ISO designation	H mm	B mm	OAL mm	LH mm	WF mm	CRNT	CNT	torque moment Nm	Insert	70 546 ...	70 546 ...
DDJN R/L 2020 X11 DC	20	20	99	30	25	M6	G1/8"	2	DN.. 1104	82000	82001
DDJN R/L 2525 X11 DC	25	25	114	30	32	M6	G1/8"	2	DN.. 1104	82500	82501
DDJN R/L 2020 X15 DC	20	20	109	40	25	M6	G1/8"	4	DN.. 1504 / 1506	72000	72001
DDJN R/L 2525 X15 DC	25	25	124	40	32	M6	G1/8"	4	DN.. 1504 / 1506	72500	72501
DDJN R/L 3225 X15 DC	32	25	140	40	32	M6	G1/8"	4	DN.. 1504 / 1506	73200	73201

When using DN.. 1504 indexable inserts, use insert seat article no. **70 950 40000**.

Spare parts for Article no.

Article no.	Clamping screw	Solid Carbide Seat D	Grubscrew
70 546 82000 / 70 546 82001	M3x7 - IP 819	808 M6x6	86700
70 546 82500 / 70 546 82501	M3x7 - IP 819	808 M6x6	86700
70 546 72000 / 70 546 72001	M4,5x12 - IP 820	811 M6x6	86700
70 546 72500 / 70 546 72501	M4,5x12 - IP 820	811 M6x6	86700
70 546 73200 / 70 546 73201	M4,5x12 - IP 820	811 M6x6	86700

Spare parts for Article no.

Article no.	XPress type	Key D	Coolant screw plug
70 546 82000 / 70 546 82001	835 T09 - IP	126 G 1/8"	294
70 546 82500 / 70 546 82501	835 T09 - IP	126 G 1/8"	294
70 546 72000 / 70 546 72001	824 T15 - IP	128 G 1/8"	294
70 546 72500 / 70 546 72501	824 T15 - IP	128 G 1/8"	294
70 546 73200 / 70 546 73201	824 T15 - IP	128 G 1/8"	294

MaxiLock-D – DSSN 45° DC – Toolholder with top clamping

Scope of supply:

Tool holder with Torx key

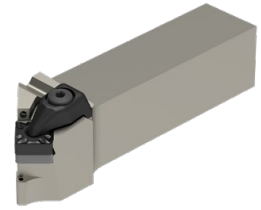
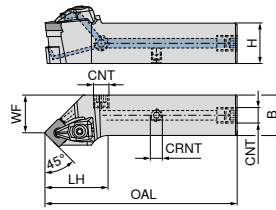

Illustrations show right-hand versions

NEW Left-hand **70 517 ...**
NEW Right-hand **70 517 ...**

ISO designation	H mm	B mm	OAL mm	LH mm	WF mm	CRNT	CNT	torque moment Nm	Insert	70 517 ...	70 517 ...
DSSN R/L 2020 X12 DC	20	20	104	35	16,7	M6	G1/8"	4	SN.. 1204	62000	62001
DSSN R/L 2525 X12 DC	25	25	119	35	24,2	M6	G1/8"	4	SN.. 1204	62500	62501
DSSN R/L 3225 X12 DC	32	25	135	35	24,2	M6	G1/8"	4	SN.. 1204	63200	63201



Spare parts for Article no.

70 517 62000 / 70 517 62001	M4,5x12 - IP	820	813	M6x6	86700
70 517 62500 / 70 517 62501	M4,5x12 - IP	820	813	M6x6	86700
70 517 63200 / 70 517 63201	M4,5x12 - IP	820	813	M6x6	86700

 Clamping screw	 Solid Carbide support S	 Grubscrew
70 950 ...	70 950 ...	70 950 ...

Spare parts for Article no.

70 517 62000 / 70 517 62001	824	T15 - IP	128	G 1/8"	294
70 517 62500 / 70 517 62501	824	T15 - IP	128	G 1/8"	294
70 517 63200 / 70 517 63201	824	T15 - IP	128	G 1/8"	294

 XPress type	 Key D	 Coolant screw plug
70 950 ...	80 950 ...	70 950 ...

MaxiLock-D – DSBN 75° DC – Toolholder with top clamping

Scope of supply:

Tool holder with Torx key

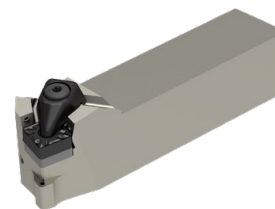
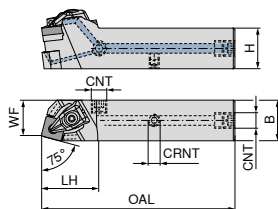

NEW

Right-hand

70 522 ...

ISO designation	H	B	OAL	LH	WF	CRNT	CNT	torque moment	Insert	
	mm	mm	mm	mm	mm			Nm		
DSBN R 2020 X12 DC	20	20	104	35	17,2	M6	G1/8"	4	SN.. 1204	62001
DSBN R 2525 X12 DC	25	25	119	35	22,2	M6	G1/8"	4	SN.. 1204	62501
DSBN R 2525 X15 DC	25	25	127	33	22,3	M6	G1/8"	6,5	SN.. 1506	72501
DSBN R 3232 X15 DC	32	32	142	42	26,1	M6	G1/8"	6,5	SN.. 1506	73201
DSBN R 3232 X19 DC	32	32	148	48	27,3	M6	G1/8"	6,5	SN.. 1906	83201
DSBN R 4040 X19 DC	40	40	173	48	35,3	M6	G1/8"	6,5	SN.. 1906	84001



70 950 ...

70 950 ...

70 950 ...

Spare parts for Article no.

70 522 62001	M4,5x12 - IP	820	813	M6x6	86700
70 522 62501	M4,5x12 - IP	820	813	M6x6	86700
70 522 72501	M5x14 - IP	821	833	M6x6	86700
70 522 73201	M5x14 - IP	821	833	M6x6	86700
70 522 83201	M5x14 - IP	821	817	M6x6	86700
70 522 84001	M5x14 - IP	821	817	M6x6	86700

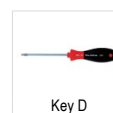

70 950 ...

80 950 ...

70 950 ...

Spare parts for Article no.

70 522 62001	824	T15 - IP	128	G 1/8"	294
70 522 62501	824	T15 - IP	128	G 1/8"	294
70 522 72501	825	T20 - IP	129	G 1/8"	294
70 522 73201	825	T20 - IP	129	G 1/8"	294
70 522 83201	826	T20 - IP	129	G 1/8"	294
70 522 84001	826	T20 - IP	129	G 1/8"	294

MaxiLock-D – DTJN 93° DC – Toolholder with top clamping

Scope of supply:

Tool holder with Torx key

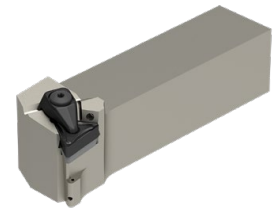
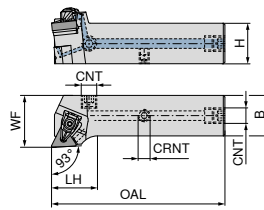

Illustrations show right-hand versions

NEW Left-hand **70 601 ...**
NEW Right-hand **70 601 ...**

ISO designation	H mm	B mm	OAL mm	LH mm	WF mm	CRNT	CNT	torque moment Nm	Insert	70 601 ...	70 601 ...
DTJN R/L 2020 X16 DC	20	20	92	23	25	M6	G1/8"	2	TNM. 1604	82000	82001
DTJN R/L 2525 X16 DC	25	25	107	23	32	M6	G1/8"	2	TNM. 1604	82500	82501

**Spare parts
for Article no.**

70 601 82000 / 70 601 82001	M3x7 - IP	819	847	M6x6	86700
70 601 82500 / 70 601 82501	M3x7 - IP	819	847	M6x6	86700



Clamping screw

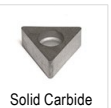

Solid Carbide
Seat T



Grubscrew

70 950 ...

70 950 ...

70 950 ...

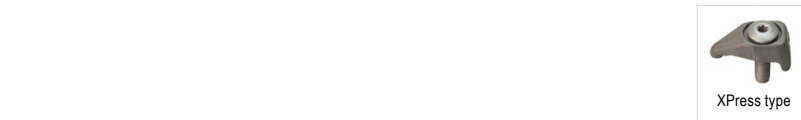

XPress type

70 950 ...

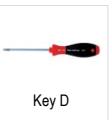

Key D

80 950 ...



Coolant screw
plug

70 950 ...

**Spare parts
for Article no.**

70 601 82000 / 70 601 82001	823	T09 - IP	126	G 1/8"	294
70 601 82500 / 70 601 82501	823	T09 - IP	126	G 1/8"	294

MaxiLock-D – DVJN 93° DC – Toolholder with top clamping

Scope of supply:

Tool holder with Torx key

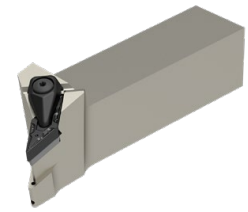
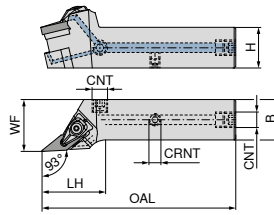

Illustrations show right-hand versions

NEW Left-hand **70 511 ...**
NEW Right-hand **70 511 ...**

ISO designation	H mm	B mm	OAL mm	LH mm	WF mm	CRNT	CNT	torque moment Nm	Insert	70 511 ...	70 511 ...
DVJN R/L 2020 X16 DC	20	20	104	35	25	M6	G1/8"	2	VN.. 1604	62000	62001
DVJN R/L 2525 X16 DC	25	25	119	35	32	M6	G1/8"	2	VN.. 1604	62500	62501

Spare parts for Article no.

70 511 62000 / 70 511 62001	M3x7 - IP	819	806	M6x6	86700
70 511 62500 / 70 511 62501	M3x7 - IP	819	806	M6x6	86700



Clamping screw



Solid Carbide Seat V



Grubscrew

70 950 ...

70 950 ...

70 950 ...

Spare parts for Article no.

70 511 62000 / 70 511 62001	835	T09 - IP	126	G 1/8"	294
70 511 62500 / 70 511 62501	835	T09 - IP	126	G 1/8"	294



XPress type

70 950 ...



Key D

80 950 ...



Coolant screw plug

70 950 ...

MaxiLock-D – DWLN 95° DC – Toolholder with top clamping

Scope of supply:

Tool holder with Torx key

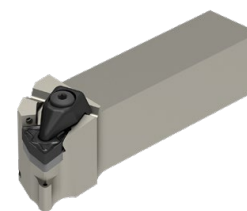
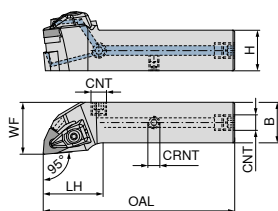

Illustrations show right-hand versions

NEW Left-hand **70 547 ...**
NEW Right-hand **70 547 ...**

ISO designation	H mm	B mm	OAL mm	LH mm	WF mm	CRNT	CNT	torque moment Nm	Insert	70 547 ...	70 547 ...
DWLN R/L 2020 X06 DC	20	20	94	25	25	M6	G1/8"	2	WN.. 0604	62000	62001
DWLN R/L 2525 X06 DC	25	25	109	25	32	M6	G1/8"	2	WN.. 0604	62500	62501
DWLN R/L 2020 X08 DC	20	20	100	31	25	M6	G1/8"	4	WN.. 0804	72000	72001
DWLN R/L 2525 X08 DC	25	25	118	34	32	M6	G1/8"	4	WN.. 0804	72500	72501



70 950 ...

70 950 ...

70 950 ...

Spare parts for Article no.

70 547 62000 / 70 547 62001	M3x7 - IP	819	807	M6x6	86700
70 547 62500 / 70 547 62501	M3x7 - IP	819	807	M6x6	86700
70 547 72000 / 70 547 72001	M4,5x12 - IP	820	812	M6x6	86700
70 547 72500 / 70 547 72501	M4,5x12 - IP	820	812	M6x6	86700

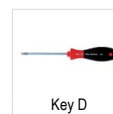

70 950 ...

80 950 ...

70 950 ...

Spare parts for Article no.

70 547 62000 / 70 547 62001	823	T09 - IP	126	G 1/8"	294
70 547 62500 / 70 547 62501	823	T09 - IP	126	G 1/8"	294
70 547 72000 / 70 547 72001	824	T15 - IP	128	G 1/8"	294
70 547 72500 / 70 547 72501	824	T15 - IP	128	G 1/8"	294

End milling cutter

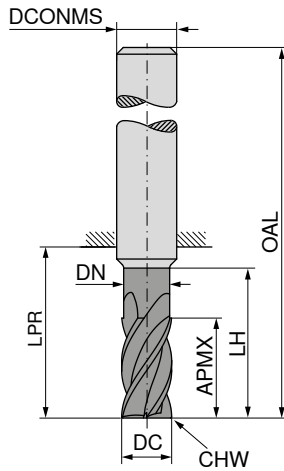
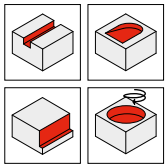
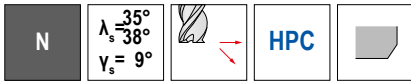

NEW
Ti1000



≈DIN 6527



54 071 ...

DC _{h10} mm	APMX mm	DN mm	LH mm	LPR mm	OAL mm	DCONMS _{h6} mm	CHW mm	ZEFP	
6	13	5,8	21	21	57	6	0,1	4	06300
8	21	7,7	27	27	63	8	0,2	4	08300
10	22	9,7	32	32	72	10	0,2	4	10300
12	26	11,6	38	38	83	12	0,3	4	12300
14	26	11,6	38	38	83	14	0,3	4	14300
16	36	15,5	44	44	92	16	0,3	4	16300
18	36	17,5	44	44	92	18	0,3	4	18300
20	41	19,5	54	54	104	20	0,3	4	20300

P	●
M	●
K	●
N	○
S	○
H	
O	

→ v_c/f_z Page 32+33

Material examples for cutting data tables

	Material sub-group	Index	Composition / Structure / Heat treatment	Tensile strength N/mm ² / HB / HRC	Material number	Material designation	Material number	Material designation
P	Unalloyed steel	P.1.1	< 0,15 % C Annealed	420 N/mm ² / 125 HB	1.0401	C15	1.1141	Ck15
		P.1.2	< 0,45 % C Annealed	640 N/mm ² / 190 HB	1.1191	C45E	1.0718	9SMnPb28
		P.1.3	< 0,45 % C Tempered	840 N/mm ² / 250 HB	1.1191	C45E	1.0535	C55
		P.1.4	< 0,75 % C Annealed	910 N/mm ² / 270 HB	1.1223	C60R	1.0535	C55
		P.1.5	< 0,75 % C Tempered	1010 N/mm ² / 300 HB	1.1223	C60R	1.0727	45S20
	Low-alloy steel	P.2.1	Annealed	610 N/mm ² / 180 HB	1.7131	16MnCr5	1.6587	17CrNiMo6
		P.2.2	Tempered	930 N/mm ² / 275 HB	1.7131	16MnCr5	1.6587	17CrNiMo6
		P.2.3	Tempered	1010 N/mm ² / 300 HB	1.7225	42CrMo4	1.3505	100Cr6
		P.2.4	Tempered	1200 N/mm ² / 375 HB	1.7225	42CrMo4	1.3505	100Cr6
	High-alloy steel and high-alloy tool steel	P.3.1	Annealed	680 N/mm ² / 200 HB	1.4021	X20Cr13	1.4034	X46Cr13
		P.3.2	Hardened and tempered	1100 N/mm ² / 300 HB	1.2343	X38CrMoV5-1	1.4034	X46Cr13
		P.3.3	Hardened and tempered	1300 N/mm ² / 400 HB	1.2343	X38CrMoV5-1	1.4034	X46Cr13
	Stainless steel	P.4.1	Ferritic / martensitic Annealed	680 N/mm ² / 200 HB	1.4016	X6Cr17	1.2316	X36CrMo16
		P.4.2	Martensitic Tempered	1010 N/mm ² / 300 HB	1.4112	X90CrMoV18	1.2316	X36CrMo16
M	Stainless steel	M.1.1	Austenitic / austenitic-ferritic Quenched	610 N/mm ² / 180 HB	1.4301	X5CrNi18-10	1.4571	X6CrNiMoTi17-12-2
		M.2.1	Austenitic Tempered	300 HB	1.4841	X15CrNiSi25-21	1.4539	X1NiCrMoCu25-20-5
		M.3.1	Austenitic / ferritic (Duplex)	780 N/mm ² / 230 HB	1.4462	X2CrNiMoN22-5-3	1.4501	X2CrNiMoCuWN25-7-4
K	Grey cast iron	K.1.1	Pearlitic / ferritic	350 N/mm ² / 180 HB	0.6010	GG-10	0.6025	GG-25
		K.1.2	Pearlitic (martensitic)	500 N/mm ² / 260 HB	0.6030	GG-30	0.6045	GG-45
	Spherulitic graphite cast iron	K.2.1	Ferritic	540 N/mm ² / 160 HB	0.7040	GGG-40	0.7060	GGG-60
		K.2.2	Pearlitic	845 N/mm ² / 250 HB	0.7070	GGG-70	0.7080	GGG-80
	Malleable iron	K.3.1	Ferritic	440 N/mm ² / 130 HB	0.8035	GTW-35-04	0.8045	GTW-45
		K.3.2	Pearlitic	780 N/mm ² / 230 HB	0.8165	GTS-65-02	0.8170	GTS-70-02
N	Aluminium wrought alloy	N.1.1	Non-hardenable	60 HB	3.0255	Al99,5	3.3315	AlMg1
		N.1.2	Hardenable Age-hardened	340 N/mm ² / 100 HB	3.1355	AlCuMg2	3.2315	AlMgSi1
	Cast aluminium alloy	N.2.1	≤ 12 % Si, non-hardenable	250 N/mm ² / 75 HB	3.2581	G-AlSi12	3.2163	G-AlSi9Cu3
		N.2.2	≤ 12 % Si, hardenable Age-hardened	300 N/mm ² / 90 HB	3.2134	G-AlSi5Cu1Mg	3.2373	G-AlSi9Mg
		N.2.3	> 12 % Si, non-hardenable	440 N/mm ² / 130 HB		G-AlSi17Cu4Mg		G-AlSi18CuNiMg
	Copper and copper alloys (bronze/brass)	N.3.1	Free-machining alloys, PB > 1 %	375 N/mm ² / 110 HB	2.0380	CuZn39Pb2 (Ms58)	2.0410	CuZn44Pb2
		N.3.2	CuZn, CuSnZn	300 N/mm ² / 90 HB	2.0331	CuZn15	2.4070	CuZn28Sn1As
		N.3.3	CuSn, lead-free copper and electrolytic copper	340 N/mm ² / 100 HB	2.0060	E-Cu57	2.0590	CuZn40Fe
	Magnesium alloys	N.4.1	Magnesium and magnesium alloys	70 HB	3.5612	MgAl6Zn	3.5312	MgAl3Zn
	S	Heat-resistant alloys	S.1.1	Fe - basis Annealed	680 N/mm ² / 200 HB	1.4864	X12NiCrSi 36-16	1.4865
S.1.2			Fe - basis Age-hardened	950 N/mm ² / 280 HB	1.4980	X6NiCrTiMoVB25-15-2	1.4876	X10NiCrAlTi32-20
S.2.1			Ni or Co basis Annealed	840 N/mm ² / 250 HB	2.4631	NiCr20TiAl (Nimonic80A)	3.4856	NiCr22Mo9Nb
S.2.2			Ni or Co basis Age-hardened	1180 N/mm ² / 350 HB	2.4668	NiCr19Nb5Mo3 (Inconel 718)	2.4955	NiFe25Cr20NbTi
S.2.3			Ni or Co basis Cast	1080 N/mm ² / 320 HB	2.4765	CoCr20W15Ni	1.3401	G-X120Mn12
Titanium alloys		S.3.1	Pure titanium	400 N/mm ²	3.7025	Ti99,8	3.7034	Ti99,7
		S.3.2	Alpha + beta alloys Age-hardened	1050 N/mm ² / 320 HB	3.7165	TiAl6V4	Ti-6246	Ti-6Al-2Sn-4Zr-6Mo
S.3.3	Beta alloys	1400 N/mm ² / 410 HB	Ti555.3	Ti-5Al-5V-5Mo-3Cr	R56410	Ti-10V-2Fe-3Al		
H	Hardened steel	H.1.1	Hardened and tempered	46–55 HRC				
		H.1.2	Hardened and tempered	56–60 HRC				
		H.1.3	Hardened and tempered	61–65 HRC				
		H.1.4	Hardened and tempered	66–70 HRC				
	Chilled iron	H.2.1	Cast	400 HB				
Hardened cast iron	H.3.1	Hardened and tempered	55 HRC					
O	Non-metal materials	O.1.1	Plastics, duroplastic	≤ 150 N/mm ²				
		O.1.2	Plastics, thermoplastic	≤ 100 N/mm ²				
		O.2.1	Aramid fibre-reinforced	≤ 1000 N/mm ²				
		O.2.2	Glass/carbon-fibre reinforced	≤ 1000 N/mm ²				
		O.3.1	Graphite					

* Tensile strength

Cutting data standard values – End mill

Index	Type short / long		54 071 ...														
	v _c (m/min)	a _{p,max} x DC	Ø DC (mm) =														
			3			4			5			6			8		
			a _p 0,1–0,2 x DC	a _p 0,3–0,4 x DC	a _p 0,6–1,0 x DC	a _p 0,1–0,2 x DC	a _p 0,3–0,4 x DC	a _p 0,6–1,0 x DC	a _p 0,1–0,2 x DC	a _p 0,3–0,4 x DC	a _p 0,6–1,0 x DC	a _p 0,1–0,2 x DC	a _p 0,3–0,4 x DC	a _p 0,6–1,0 x DC	a _p 0,1–0,2 x DC	a _p 0,3–0,4 x DC	a _p 0,6–1,0 x DC
f _z (mm)																	
P.1.1	210	1,0	0,028	0,022	0,014	0,038	0,030	0,019	0,049	0,039	0,025	0,060	0,048	0,030	0,080	0,064	0,040
P.1.2	200	1,0	0,028	0,022	0,014	0,038	0,030	0,019	0,049	0,039	0,025	0,060	0,048	0,030	0,080	0,064	0,040
P.1.3	200	1,0	0,028	0,022	0,014	0,038	0,030	0,019	0,049	0,039	0,025	0,060	0,048	0,030	0,080	0,064	0,040
P.1.4	190	1,0	0,028	0,022	0,014	0,038	0,030	0,019	0,049	0,039	0,025	0,060	0,048	0,030	0,080	0,064	0,040
P.1.5	190	1,0	0,028	0,022	0,014	0,038	0,030	0,019	0,049	0,039	0,025	0,060	0,048	0,030	0,080	0,064	0,040
P.2.1	200	1,0	0,028	0,022	0,014	0,038	0,030	0,019	0,049	0,039	0,025	0,060	0,048	0,030	0,080	0,064	0,040
P.2.2	190	1,0	0,022	0,018	0,011	0,030	0,024	0,015	0,038	0,030	0,019	0,046	0,037	0,023	0,062	0,050	0,031
P.2.3	180	1,0	0,028	0,022	0,014	0,038	0,030	0,019	0,049	0,039	0,025	0,060	0,048	0,030	0,080	0,064	0,040
P.2.4	170	1,0	0,022	0,018	0,011	0,030	0,024	0,015	0,038	0,030	0,019	0,046	0,037	0,023	0,062	0,050	0,031
P.3.1	180	1,0	0,028	0,022	0,014	0,038	0,030	0,019	0,049	0,039	0,025	0,060	0,048	0,030	0,080	0,064	0,040
P.3.2	170	1,0	0,028	0,022	0,014	0,038	0,030	0,019	0,049	0,039	0,025	0,060	0,048	0,030	0,080	0,064	0,040
P.3.3	140	1,0	0,028	0,022	0,014	0,038	0,030	0,019	0,049	0,039	0,025	0,060	0,048	0,030	0,080	0,064	0,040
P.4.1	100	1,0	0,017	0,014	0,009	0,024	0,019	0,012	0,031	0,025	0,016	0,038	0,030	0,019	0,052	0,042	0,026
P.4.2	80	1,0	0,017	0,014	0,009	0,024	0,019	0,012	0,031	0,025	0,016	0,038	0,030	0,019	0,052	0,042	0,026
M.1.1	100	1,0	0,017	0,014	0,009	0,024	0,019	0,012	0,031	0,025	0,016	0,038	0,030	0,019	0,052	0,042	0,026
M.2.1	100	1,0	0,017	0,014	0,009	0,024	0,019	0,012	0,031	0,025	0,016	0,038	0,030	0,019	0,052	0,042	0,026
M.3.1	100	1,0	0,017	0,014	0,009	0,024	0,019	0,012	0,031	0,025	0,016	0,038	0,030	0,019	0,052	0,042	0,026
K.1.1	200	1,0	0,037	0,030	0,019	0,048	0,038	0,024	0,060	0,048	0,030	0,070	0,056	0,035	0,094	0,075	0,047
K.1.2	180	1,0	0,037	0,030	0,019	0,048	0,038	0,024	0,060	0,048	0,030	0,070	0,056	0,035	0,094	0,075	0,047
K.2.1	190	1,0	0,028	0,022	0,014	0,038	0,030	0,019	0,049	0,039	0,025	0,060	0,048	0,030	0,080	0,064	0,040
K.2.2	170	1,0	0,028	0,022	0,014	0,038	0,030	0,019	0,049	0,039	0,025	0,060	0,048	0,030	0,080	0,064	0,040
K.3.1	180	1,0	0,028	0,022	0,014	0,038	0,030	0,019	0,049	0,039	0,025	0,060	0,048	0,030	0,080	0,064	0,040
K.3.2	160	1,0	0,028	0,022	0,014	0,038	0,030	0,019	0,049	0,039	0,025	0,060	0,048	0,030	0,080	0,064	0,040
N.1.1																	
N.1.2																	
N.2.1																	
N.2.2																	
N.2.3																	
N.3.1	350	1,0	0,037	0,030	0,019	0,048	0,038	0,024	0,060	0,048	0,030	0,070	0,056	0,035	0,094	0,075	0,047
N.3.2	350	1,0	0,037	0,030	0,019	0,048	0,038	0,024	0,060	0,048	0,030	0,070	0,056	0,035	0,094	0,075	0,047
N.3.3	280	1,0	0,037	0,030	0,019	0,048	0,038	0,024	0,060	0,048	0,030	0,070	0,056	0,035	0,094	0,075	0,047
N.4.1																	
S.1.1	30	1,0	0,015	0,012	0,008	0,020	0,016	0,010	0,025	0,020	0,013	0,030	0,024	0,015	0,040	0,032	0,020
S.1.2	30	1,0	0,015	0,012	0,008	0,020	0,016	0,010	0,025	0,020	0,013	0,030	0,024	0,015	0,040	0,032	0,020
S.2.1	30	1,0	0,015	0,012	0,008	0,020	0,016	0,010	0,025	0,020	0,013	0,030	0,024	0,015	0,040	0,032	0,020
S.2.2	30	1,0	0,015	0,012	0,008	0,020	0,016	0,010	0,025	0,020	0,013	0,030	0,024	0,015	0,040	0,032	0,020
S.2.3	30	1,0	0,015	0,012	0,008	0,020	0,016	0,010	0,025	0,020	0,013	0,030	0,024	0,015	0,040	0,032	0,020
S.3.1	90	1,0	0,028	0,022	0,014	0,038	0,030	0,019	0,049	0,039	0,025	0,060	0,048	0,030	0,080	0,064	0,040
S.3.2	50	1,0	0,017	0,014	0,009	0,024	0,019	0,012	0,031	0,025	0,016	0,038	0,030	0,019	0,052	0,042	0,026
S.3.3																	
H.1.1																	
H.1.2																	
H.1.3																	
H.1.4																	
H.2.1																	
H.3.1																	
O.1.1																	
O.1.2																	
O.2.1																	
O.2.2																	
O.3.1																	

 Plunging angle for ramping and helical milling: 3°

Index	54 071 ...												● 1st choice		
	Ø DC (mm) =												○ suitable		
	10			12			16			20			Emulsion	Compressed air	MQL
	a_p 0,1-0,2 x DC	a_p 0,3-0,4 x DC	a_p 0,6-1,0 x DC	a_p 0,1-0,2 x DC	a_p 0,3-0,4 x DC	a_p 0,6-1,0 x DC	a_p 0,1-0,2 x DC	a_p 0,3-0,4 x DC	a_p 0,6-1,0 x DC	a_p 0,1-0,2 x DC	a_p 0,3-0,4 x DC	a_p 0,6-1,0 x DC			
f_z (mm)															
P.1.1	0,100	0,080	0,050	0,120	0,096	0,060	0,150	0,120	0,075	0,170	0,136	0,085	●	○	○
P.1.2	0,100	0,080	0,050	0,120	0,096	0,060	0,150	0,120	0,075	0,170	0,136	0,085	●	○	○
P.1.3	0,100	0,080	0,050	0,120	0,096	0,060	0,150	0,120	0,075	0,170	0,136	0,085	●	○	○
P.1.4	0,100	0,080	0,050	0,120	0,096	0,060	0,150	0,120	0,075	0,170	0,136	0,085	●	○	○
P.1.5	0,100	0,080	0,050	0,120	0,096	0,060	0,150	0,120	0,075	0,170	0,136	0,085	●	○	○
P.2.1	0,100	0,080	0,050	0,120	0,096	0,060	0,150	0,120	0,075	0,170	0,136	0,085	●	○	○
P.2.2	0,078	0,062	0,039	0,094	0,075	0,047	0,118	0,094	0,059	0,134	0,107	0,067	●	○	○
P.2.3	0,100	0,080	0,050	0,120	0,096	0,060	0,150	0,120	0,075	0,170	0,136	0,085	●	○	○
P.2.4	0,078	0,062	0,039	0,094	0,075	0,047	0,118	0,094	0,059	0,134	0,107	0,067	●	○	○
P.3.1	0,100	0,080	0,050	0,120	0,096	0,060	0,150	0,120	0,075	0,170	0,136	0,085	●	○	○
P.3.2	0,100	0,080	0,050	0,120	0,096	0,060	0,150	0,120	0,075	0,170	0,136	0,085	●	○	○
P.3.3	0,100	0,080	0,050	0,120	0,096	0,060	0,150	0,120	0,075	0,170	0,136	0,085	●	○	○
P.4.1	0,066	0,053	0,033	0,080	0,064	0,040	0,101	0,081	0,051	0,115	0,092	0,058	●		
P.4.2	0,066	0,053	0,033	0,080	0,064	0,040	0,101	0,081	0,051	0,115	0,092	0,058	●		
M.1.1	0,066	0,053	0,033	0,080	0,064	0,040	0,101	0,081	0,051	0,115	0,092	0,058	●		
M.2.1	0,066	0,053	0,033	0,080	0,064	0,040	0,101	0,081	0,051	0,115	0,092	0,058	●		
M.3.1	0,066	0,053	0,033	0,080	0,064	0,040	0,101	0,081	0,051	0,115	0,092	0,058	●		
K.1.1	0,116	0,093	0,058	0,140	0,112	0,070	0,173	0,138	0,087	0,196	0,157	0,098	●	○	○
K.1.2	0,116	0,093	0,058	0,140	0,112	0,070	0,173	0,138	0,087	0,196	0,157	0,098	●	○	○
K.2.1	0,100	0,080	0,050	0,120	0,096	0,060	0,150	0,120	0,075	0,170	0,136	0,085	●	○	○
K.2.2	0,100	0,080	0,050	0,120	0,096	0,060	0,150	0,120	0,075	0,170	0,136	0,085	●	○	○
K.3.1	0,100	0,080	0,050	0,120	0,096	0,060	0,150	0,120	0,075	0,170	0,136	0,085	●	○	○
K.3.2	0,100	0,080	0,050	0,120	0,096	0,060	0,150	0,120	0,075	0,170	0,136	0,085	●	○	○
N.1.1															
N.1.2															
N.2.1															
N.2.2															
N.2.3															
N.3.1	0,116	0,093	0,058	0,140	0,112	0,070	0,173	0,138	0,087	0,196	0,157	0,098	●		
N.3.2	0,116	0,093	0,058	0,140	0,112	0,070	0,173	0,138	0,087	0,196	0,157	0,098	●		
N.3.3	0,116	0,093	0,058	0,140	0,112	0,070	0,173	0,138	0,087	0,196	0,157	0,098	●		
N.4.1															
S.1.1	0,050	0,040	0,025	0,060	0,048	0,030	0,075	0,060	0,038	0,084	0,067	0,042	●		
S.1.2	0,050	0,040	0,025	0,060	0,048	0,030	0,075	0,060	0,038	0,084	0,067	0,042	●		
S.2.1	0,050	0,040	0,025	0,060	0,048	0,030	0,075	0,060	0,038	0,084	0,067	0,042	●		
S.2.2	0,050	0,040	0,025	0,060	0,048	0,030	0,075	0,060	0,038	0,084	0,067	0,042	●		
S.2.3	0,050	0,040	0,025	0,060	0,048	0,030	0,075	0,060	0,038	0,084	0,067	0,042	●		
S.3.1	0,100	0,080	0,050	0,120	0,096	0,060	0,150	0,120	0,075	0,170	0,136	0,085	●		
S.3.2	0,066	0,053	0,033	0,080	0,064	0,040	0,101	0,081	0,051	0,115	0,092	0,058	●		
S.3.3															
H.1.1															
H.1.2															
H.1.3															
H.1.4															
H.2.1															
H.3.1															
O.1.1															
O.1.2															
O.2.1															
O.2.2															
O.3.1															

MaxiMill – HFCD high-feed screw-in cutter

▲ Programmed radius r3D = 2.0 mm

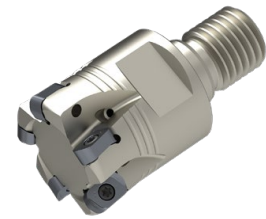
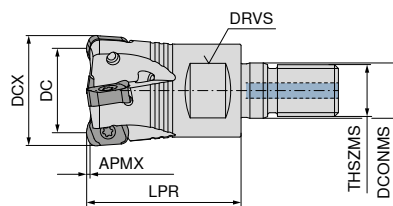
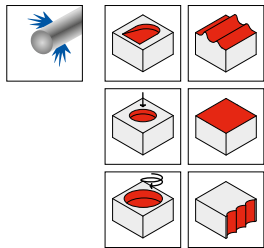

NEW

50 357 ...

Designation	DC mm	DCX mm	ZNF	APMX mm	LPR mm	DCONMS mm	THSZMS	DRVS mm	RPMX 1/min.	torque moment Nm	Insert	
GHFCD.16.R.02-06	10	16	2	0,8	27	8,5	M8	10	23500	1,2	XNEU 06T3..	01602
GHFCD.20.R.03-06	14	20	3	0,8	33	10,5	M10	15	20200	1,2	XNEU 06T3..	02003
GHFCD.25.R.04-06	19	25	4	0,8	35	12,5	M12	17	18100	1,2	XNEU 06T3..	02504
GHFCD.32.R.05-06	26	32	5	0,8	35	17,0	M16	24	17300	1,2	XNEU 06T3..	03205
GHFCD.35.R.06-06	29	35	6	0,8	35	17,0	M16	24	16100	1,2	XNEU 06T3..	03506
GHFCD.42.R.06-06	36	42	6	0,8	35	17,0	M16	24	14100	1,2	XNEU 06T3..	04206

MaxiMill – HFCD high-feed end mill

▲ Programmed radius r3D = 2.0 mm

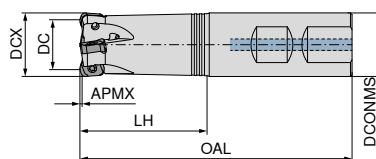
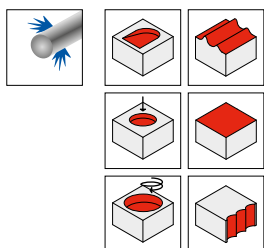

NEW

NEW

50 356 ...

50 356 ...

Designation	DC mm	DCX mm	ZNF	APMX mm	OAL mm	LH mm	DCONMS _{h6} mm	RPMX 1/min.	torque moment Nm	Insert		
CHFCD.16.R.02-06-B-40	10	16	2	0,8	89	40	16	21700	1,2	XNEU 06T3..		11602
CHFCD.16.R.02-06-A-40	10	16	2	0,8	89	40	16	21700	1,2	XNEU 06T3..	01602	
CHFCD.16.R.02-06-A-40-200	10	16	2	0,8	200	40	16	12300	1,2	XNEU 06T3..	21602	
CHFCD.20.R.03-06-B-50	14	20	3	0,8	101	50	20	17000	1,2	XNEU 06T3..		12003
CHFCD.20.R.03-06-A-50	14	20	3	0,8	101	50	20	17000	1,2	XNEU 06T3..	02003	
CHFCD.20.R.03-06-A-50-225	14	20	3	0,8	225	50	20	8700	1,2	XNEU 06T3..	22003	
CHFCD.25.R.04-06-B-50	19	25	4	0,8	107	50	25	15400	1,2	XNEU 06T3..		12504
CHFCD.25.R.04-06-A-50	19	25	4	0,8	107	50	25	15400	1,2	XNEU 06T3..	02504	
CHFCD.25.R.04-06-A-50-225	19	25	4	0,8	225	50	25	7100	1,2	XNEU 06T3..	22504	
CHFCD.32.R.05-06-B25-50	26	32	5	0,8	107	50	25	14400	1,2	XNEU 06T3..		13205
CHFCD.32.R.05-06-A25-50	26	32	5	0,8	107	50	25	14400	1,2	XNEU 06T3..	03205	
CHFCD.32.R.05-06-A25-50-225	26	32	5	0,8	225	50	25	6400	1,2	XNEU 06T3..	23205	

MaxiMill – HFCD high-feed face mill

▲ Programmed radius r3D = 2.0 mm

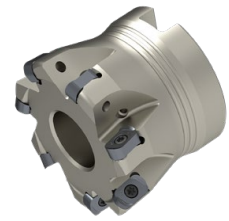
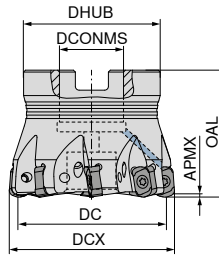
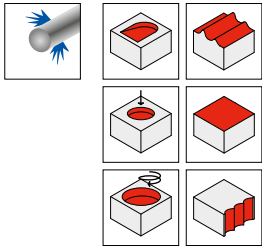





NEW

50 358 ...

Designation	DC mm	DCX mm	ZNF	APMX mm	OAL mm	DCONMS _{H6} mm	DHUB mm	RPMX 1/min.	torque moment Nm	Insert	
AHFCD.32.R.05-06	26	32	5	0,8	40	16	38	17300	1,2	XNEU 06T3..	03205
AHFCD.35.R.05-06	29	35	5	0,8	40	16	38	16100	1,2	XNEU 06T3..	03505
AHFCD.40.R.06-06	34	40	6	0,8	40	16	38	14600	1,2	XNEU 06T3..	04006
AHFCD.42.R.06-06	36	42	6	0,8	40	16	38	14100	1,2	XNEU 06T3..	04206
AHFCD.50.R.07-06	44	50	7	0,8	40	22	43	12500	1,2	XNEU 06T3..	05007
AHFCD.52.R.08-06	46	52	8	0,8	40	22	43	12200	1,2	XNEU 06T3..	05208
AHFCD.63.R.09-06	57	63	9	0,8	40	22	48	10800	1,2	XNEU 06T3..	06309
AHFCD.66.R.10-06	60	66	10	0,8	40	22	48	10500	1,2	XNEU 06T3..	06610

Spare parts
Insert

XNEU 06T3..

				
TORX® blade	Key D	Molykote	Clamping screw	Torque screwdriver
80 950 ...	80 950 ...	70 950 ...	70 950 ...	80 950 ...
033	110	303	13800	192

XNEU

Designation	IC mm	D1 mm	INSL mm	r3D mm	S mm
XNEU 06T3..	6,05	2,8	9,65	2	3,0

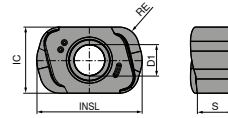

XNEU

NEW	NEW	NEW	NEW	NEW
-M50 CTCP230	-M50 CTPP235	-F50 CTPM240	-M50 CTPM240	-F50 CTPM245
DRAGONSKIN	DRAGONSKIN	DRAGONSKIN	DRAGONSKIN	DRAGONSKIN
XNEU	XNEU	XNEU	XNEU	XNEU
51 261 ...	51 261 ...	51 260 ...	51 261 ...	51 260 ...
01800	11800	41800	41800	41801

ISO	RE mm
06T318SER	1,8

P	●	●	○	○	●
M	●	○	●	●	●
K	○	○	●	●	●
N	○	○	○	○	○
S	○	○	○	○	○
H	○	○	○	○	○
O	○	○	○	○	○

XNEU

NEW	NEW	NEW	NEW	NEW
-F50 CTCM245	-R50 CTCK215	-R50 CTPK220	-F40 CTC5240	-F40 CTCS245
DRAGONSKIN	DRAGONSKIN	DRAGONSKIN	DRAGONSKIN	DRAGONSKIN
XNEU	XNEU	XNEU	XNEU	XNEU
51 260 ...	51 262 ...	51 262 ...	51 259 ...	51 259 ...
91801	51800	61800	11801	51801

ISO	RE mm
06T318ER	1,8
06T318SER	1,8

P	●	●	○	○	●
M	●	○	●	●	●
K	○	○	●	●	●
N	○	○	○	○	○
S	○	○	○	○	○
H	○	○	○	○	○
O	○	○	○	○	○

MaxiMill – Tangent-09 screw-in cutter

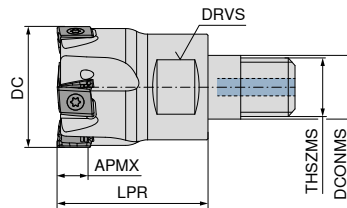
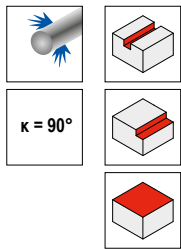

NEW

50 355 ...

Designation	DC mm	ZNF	APMX mm	LPR mm	DCONMS mm	THSZMS	DRVS mm	RPMX 1/min.	torque moment Nm	Insert	
GTANG.25.R.03-09-M12	25	3	8	35	12,5	M12	17	39600	2,2	LN.U 0904	02503
GTANG.25.R.04-09-M12	25	4	8	35	12,5	M12	17	39600	2,2	LN.U 0904	02504
GTANG.32.R.04-09-M16	32	4	8	40	17,0	M16	24	35000	2,2	LN.U 0904	03204
GTANG.32.R.05-09-M16	32	5	8	40	17,0	M16	24	35000	2,2	LN.U 0904	03205

MaxiMill – Tangent-09 end mill

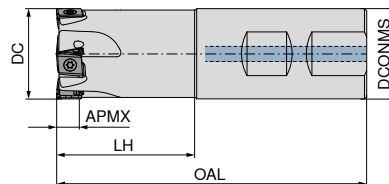
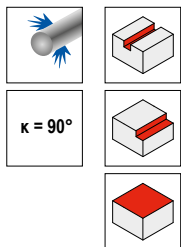

NEW



50 354 ...

Designation	DC mm	ZNF	APMX mm	OAL mm	LH mm	DCONMS _{h6} mm	RPMX 1/min.	torque moment Nm	Insert	
CTANG.25.R.03-09-B-43-100	25	3	8	100	43	25	39600	2,2	LN.U 0904	02503
CTANG.25.R.04-09-B-43-100	25	4	8	100	43	25	39600	2,2	LN.U 0904	02504
CTANG.32.R.04-09-B-49-110	32	4	8	110	49	32	35000	2,2	LN.U 0904	03204
CTANG.32.R.05-09-B-49-110	32	5	8	110	49	32	35000	2,2	LN.U 0904	03205
CTANG.40.R.04-09-B32-49-110	40	4	8	110	49	32	31300	2,2	LN.U 0904	04004
CTANG.40.R.06-09-B32-49-110	40	6	8	110	49	32	31300	2,2	LN.U 0904	04006

MaxiMill – Tangent-09 face mill

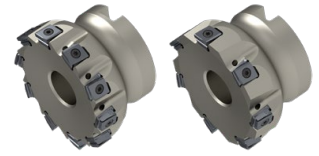
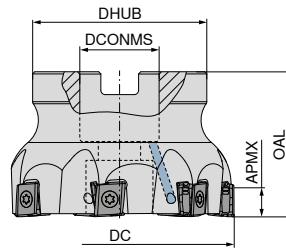
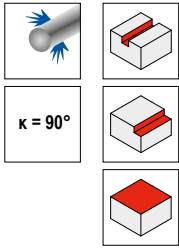

NEW

NEW

Designation	DC mm	ZNF	APMX mm	OAL mm	DHUB mm	DCONMS _{H6} mm	RPMX 1/min.	torque moment Nm	Insert	50 353 ...	50 353 ...
ATANG.40.R.04-09-A16	40	4	8	40	38	16	31300	2,2	LN.U 0904		04004
ATANG.40.R.06-09-A16	40	6	8	40	38	16	31300	2,2	LN.U 0904	04006	
ATANG.50.R.05-09-A22	50	5	8	40	43	22	28000	2,2	LN.U 0904		05005
ATANG.50.R.07-09-A22	50	7	8	40	43	22	28000	2,2	LN.U 0904	05007	
ATANG.63.R.07-09-A22	63	7	8	40	48	22	25000	2,2	LN.U 0904		06307
ATANG.63.R.10-09-A22	63	10	8	40	48	22	25000	2,2	LN.U 0904	06310	
ATANG.80.R.08-09-A27	80	8	8	50	58	27	21000	2,2	LN.U 0904		08008
ATANG.80.R.11-09-A27	80	11	8	50	58	27	21000	2,2	LN.U 0904	08011	

Spare parts
Insert
LN.U 0904

Key D	Molykote	Clamping screw	Torque screwdriver
80 950 ...	70 950 ...	70 950 ...	80 950 ...
119	303	710	193

LNHU

Designation	D1 mm	L mm	BS mm	S mm	W1 mm
LNHU 0904..	3,45	9,3	1	4,8	8

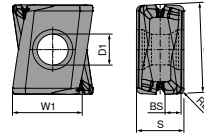

LNHU

ISO	RE mm	NEW	NEW	NEW	NEW	NEW	NEW	
090404	0,4	-M50 CTCP230	-M50 CTPP235	-M50 CTPM240	-M50 CTCM245	-M50 CTCK215	-M50 CTPK220	-F40 CTC5240
		DRAGONSKIN	DRAGONSKIN	DRAGONSKIN	DRAGONSKIN	DRAGONSKIN	DRAGONSKIN	DRAGONSKIN
		LNHU	LNHU	LNHU	LNHU	LNHU	LNHU	LNHU
		51 257 ...	51 257 ...	51 257 ...	51 257 ...	51 257 ...	51 257 ...	51 258 ...
		00400	10400	40400	40401	50400	60400	10401
P		●	●	○	●			
M			○	●	●			
K		○	○			●	●	
N								
S					○			●
H								
O								

MaxiMill – Tangent-13 screw-in cutter

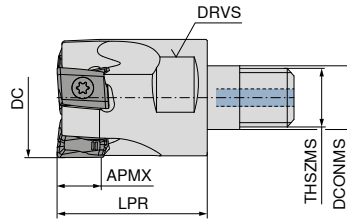
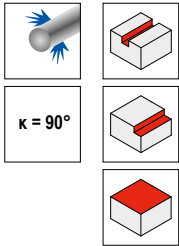

NEW

50 352 ...

Designation	DC mm	ZNF	APMX mm	LPR mm	DCONMS mm	THSZMS	DRVS mm	RPMX 1/min.	torque moment Nm	Insert	
GTANG.32.R.03-13-M16	32	3	12	35	17	M16	24	25000	5,0	LN.U 1306	03203
GTANG.40.R.04-13-M16	40	4	12	40	17	M16	27	22500	5,0	LN.U 1306	04004

MaxiMill – Tangent-13 end mill

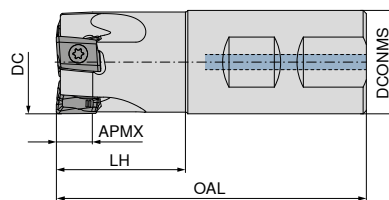
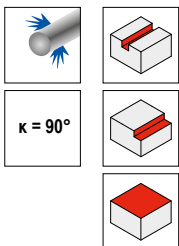

NEW

50 351 ...

Designation	DC mm	ZNF	APMX mm	OAL mm	LH mm	DCONMS _{h6} mm	RPMX 1/min.	torque moment Nm	Insert	
CTANG.32.R.03-13-B32-40	32	3	12	96	40	32	25000	5,0	LN.U 1306	03203
CTANG.40.R.04-13-B32-50	40	4	12	110	50	32	22500	5,0	LN.U 1306	04004

LNHU

Designation	D1 mm	L mm	BS mm	S mm	W1 mm
LNHU 1306..	4,5	13,3	1,5	7,0	10,2

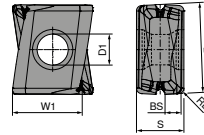

LNHU

		NEW	NEW	NEW	NEW	NEW	NEW	NEW
		-M50 CTCP230	-M50 CTPP235	-F50 CTPM240	-F50 CTCM245	-M50 CTCK215	-M50 CTPK220	-F50 CTC5240
		DRAGONSKIN	DRAGONSKIN	DRAGONSKIN	DRAGONSKIN	DRAGONSKIN	DRAGONSKIN	DRAGONSKIN
		LNHU	LNHU	LNHU	LNHU	LNHU	LNHU	LNHU
		51 255 ...	51 255 ...	51 256 ...	51 256 ...	51 255 ...	51 255 ...	51 256 ...
ISO	RE mm	00800	10800	40800	40801	50800	60800	10801
130608	0,8							
P		●	●	○	●			
M			○	●	●			
K		○	○			●	●	
N								
S					○			●
H								
O								

MaxiMill – Slot-SNHX screw-in multipurpose milling cutter



$\kappa = 90^\circ$

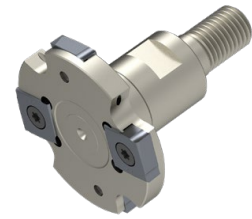
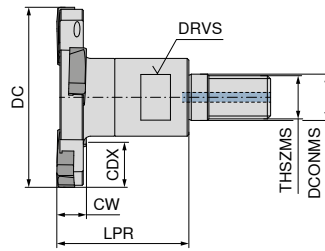

NEW

50 373 ...

Designation	DC mm	CW mm	CDX mm	LPR mm	DCONMS mm	THSZMS	DRVS mm	ZNF	Insert	
GSLOT.50.R.04-SN13-06-DC-M12	50	6	13	35	12,5	M12	17	4	SNHX 1303..	05006
GSLOT.63.R.06-SN13-06-DC-M12	63	6	18	35	12,5	M12	17	6	SNHX 1303..	06306
GSLOT.80.R.08-SN13-06-DC-M16	80	6	21	35	17,0	M16	24	8	SNHX 1303..	08006
GSLOT.50.R.04-SN13-08-DC-M12	50	8	13	35	12,5	M12	17	4	SNHX 1304..	05008
GSLOT.63.R.06-SN13-08-DC-M12	63	8	18	35	12,5	M12	17	6	SNHX 1304..	06308
GSLOT.80.R.08-SN13-08-DC-M16	80	8	21	35	17,0	M16	24	8	SNHX 1304..	08008

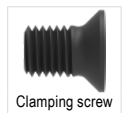

Clamping screw

50 950 ...

Spare parts
for Article no.

50 373 05006 / 50 373 06306	00500
50 373 05008 / 50 373 06308	00600
50 373 08006	00500
50 373 08008	00600

MaxiMill – Slot-SNHX cylindrical shank saw



$\kappa = 90^\circ$

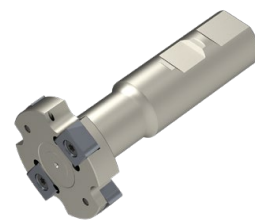
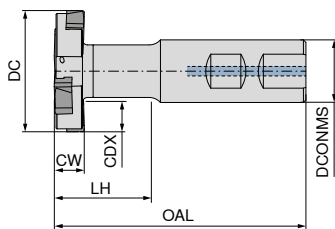

NEW

50 372 ...

Designation	DC mm	CW mm	CDX mm	OAL mm	LH mm	DCONMS mm	ZNF	Insert	
CSLOT.50.R.04-SN13-06-DC-B20-42	50	6	13	95	42	20	4	SNHX 1303..	05006
CSLOT.63.R.06-SN13-06-DC-B25-41	63	6	18	100	41	25	6	SNHX 1303..	06306
CSLOT.80.R.08-SN13-06-DC-B32-48	80	6	22	110	48	32	8	SNHX 1303..	08006
CSLOT.100.R.10-SN13-06-DC-B40-52	100	6	29	125	52	40	10	SNHX 1303..	10006
CSLOT.50.R.04-SN13-08-DC-B20-42	50	8	13	95	42	20	4	SNHX 1304..	05008
CSLOT.63.R.06-SN13-08-DC-B25-41	63	8	18	100	41	25	6	SNHX 1304..	06308
CSLOT.80.R.08-SN13-08-DC-B32-48	80	8	22	110	48	32	8	SNHX 1304..	08008
CSLOT.100.R.10-SN13-08-DC-B40-52	100	8	29	125	52	40	10	SNHX 1304..	10008
CSLOT.50.R.04-SN13-10-DC-B20-42	50	10	13	95	42	20	4	SNHX 1305..	05010
CSLOT.63.R.06-SN13-10-DC-B25-41	63	10	18	100	41	25	6	SNHX 1305..	06310
CSLOT.80.R.08-SN13-10-DC-B32-48	80	10	22	110	48	32	8	SNHX 1305..	08010
CSLOT.100.R.10-SN13-10-DC-B40-52	100	10	29	125	52	40	10	SNHX 1305..	10010
CSLOT.50.R.04-SN13-12-DC-B20-42	50	12	13	95	42	20	4	SNHX 1307..	05012
CSLOT.63.R.06-SN13-12-DC-B25-41	63	12	18	100	41	25	6	SNHX 1307..	06312
CSLOT.80.R.08-SN13-12-DC-B32-48	80	12	22	110	48	32	8	SNHX 1307..	08012
CSLOT.100.R.10-SN13-12-DC-B40-52	100	12	29	125	52	40	10	SNHX 1307..	10012

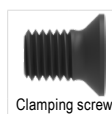

Clamping screw

50 950 ...

**Spare parts
for Article no.**

50 372 05006 / 50 372 06306	00500
50 372 05008 / 50 372 06308	00600
50 372 05010 / 50 372 06310	00700
50 372 05012 / 50 372 06312	00800
50 372 08006 / 50 372 10006	00500
50 372 08008 / 50 372 10008	00600
50 372 08010 / 50 372 10010	00700
50 372 08012 / 50 372 10012	00800

MaxiMill – Slot-SNHX slot milling and parting off cutter



$\kappa = 90^\circ$

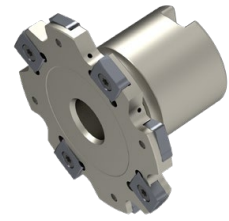
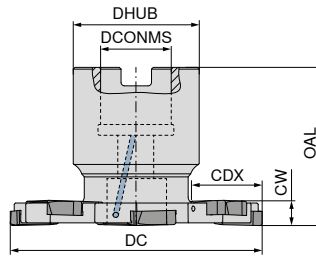

NEW

50 374 ...

Designation	DC mm	CW mm	CDX mm	OAL mm	DCONMS mm	DHUB mm	ZNF	Insert	
ASLOT.80.R.08-SN13-06-DC-A22	80	6	22,0	50	22	40	8	SNHX 1303..	08006
ASLOT.100.R.10-SN13-06-DC-A27	100	6	25,0	50	27	48	10	SNHX 1303..	10006
ASLOT.125.R.12-SN13-06-DC-A32	125	6	31,5	50	32	58	12	SNHX 1303..	12506
ASLOT.160.R.16-SN13-06-DC-A40	160	6	41,5	50	40	70	16	SNHX 1303..	16006
ASLOT.200.R.18-SN13-06-DC-A40	200	6	52,0	50	40	88	18	SNHX 1303..	20006
ASLOT.80.R.08-SN13-08-DC-A22	80	8	22,0	50	22	40	8	SNHX 1304..	08008
ASLOT.100.R.10-SN13-08-DC-A27	100	8	25,0	50	27	48	10	SNHX 1304..	10008
ASLOT.125.R.12-SN13-08-DC-A32	125	8	31,5	50	32	58	12	SNHX 1304..	12508
ASLOT.160.R.16-SN13-08-DC-A40	160	8	41,5	50	40	70	16	SNHX 1304..	16008
ASLOT.200.R.18-SN13-08-DC-A40	200	8	52,0	50	40	88	18	SNHX 1304..	20008
ASLOT.80.R.08-SN13-10-DC-A22	80	10	22,0	50	22	40	8	SNHX 1305..	08010
ASLOT.100.R.10-SN13-10-DC-A27	100	10	25,0	50	27	48	10	SNHX 1305..	10010
ASLOT.125.R.12-SN13-10-DC-A32	125	10	31,5	50	32	58	12	SNHX 1305..	12510
ASLOT.160.R.16-SN13-10-DC-A40	160	10	41,5	50	40	70	16	SNHX 1305..	16010
ASLOT.200.R.18-SN13-10-DC-A40	200	10	52,0	50	40	88	18	SNHX 1305..	20010
ASLOT.80.R.08-SN13-12-DC-A22	80	12	22,0	50	22	40	8	SNHX 1307..	08012
ASLOT.100.R.10-SN13-12-DC-A27	100	12	25,0	50	27	48	10	SNHX 1307..	10012
ASLOT.125.R.12-SN13-12-DC-A32	125	12	31,5	50	32	58	12	SNHX 1307..	12512
ASLOT.160.R.16-SN13-12-DC-A40	160	12	41,5	50	40	70	16	SNHX 1307..	16012
ASLOT.200.R.18-SN13-12-DC-A40	200	12	52,0	50	40	88	18	SNHX 1307..	20012
ASLOT.80.R.08-SN13-14-DC-A22	80	14	22,0	50	22	40	8	SNHX 1309..	08014
ASLOT.100.R.10-SN13-14-DC-A27	100	14	25,0	50	27	48	10	SNHX 1309..	10014
ASLOT.125.R.12-SN13-14-DC-A32	125	14	31,5	50	32	58	12	SNHX 1309..	12514
ASLOT.160.R.16-SN13-14-DC-A40	160	14	41,5	50	40	70	16	SNHX 1309..	16014
ASLOT.200.R.18-SN13-14-DC-A40	200	14	52,0	50	40	88	18	SNHX 1309..	20014
ASLOT.80.R.08-SN13-16-DC-A22	80	16	22,0	50	22	40	8	SNHX 1309..	08016
ASLOT.100.R.10-SN13-16-DC-A27	100	16	25,0	50	27	48	10	SNHX 1309..	10016
ASLOT.125.R.12-SN13-16-DC-A32	125	16	31,5	50	32	58	12	SNHX 1309..	12516
ASLOT.160.R.16-SN13-16-DC-A40	160	16	41,5	50	40	70	16	SNHX 1309..	16016
ASLOT.200.R.18-SN13-16-DC-A40	200	16	52,0	50	40	88	18	SNHX 1309..	20016



Clamping screw

50 950 ...

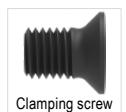

Clamping screw

50 950 ...

**Spare parts
for Article no.**

50 374 08006	01000	00500
50 374 08008	01000	00600
50 374 08010	01000	00700
50 374 08012	01000	00800
50 374 08014 / 50 374 08016	01000	00900
50 374 10006	01100	00500
50 374 10008	01100	00600
50 374 10010	01100	00700
50 374 10012	01100	00800
50 374 10014 / 50 374 10016	01100	00900
50 374 12506	01200	00500
50 374 12508	01200	00600
50 374 12510	01200	00700
50 374 12512	01200	00800
50 374 12514 / 50 374 12516	01200	00900
50 374 16006 / 50 374 20006	01300	00500
50 374 16008 / 50 374 20008	01300	00600
50 374 16010 / 50 374 20010	01300	00700
50 374 16012 / 50 374 20012	01300	00800
50 374 16014 / 50 374 16016	01300	00900
50 374 20014 / 50 374 20016	01300	00900

SNHX

Designation	IC mm	D1 mm	L mm	S mm
SNHX 1303..	13	5,3	13	3,2
SNHX 1304..	13	5,3	13	4,5
SNHX 1305..	13	5,3	13	5,4
SNHX 1307..	13	5,3	13	7,0
SNHX 1309..	13	5,3	13	9,0

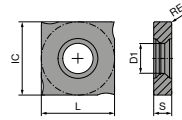

SNHX

ISO	RE mm	51 263 ...	51 264 ...	51 265 ...	51 266 ...	51 267 ...
130308EL	0,8	10800				
130308ER	0,8	11800				
130408EL	0,8		10800			
130408ER	0,8		11800			
130508EL	0,8			10800		
130508ER	0,8			11800		
130708EL	0,8				10800	
130708ER	0,8				11800	
130908EL	0,8					10800
130908ER	0,8					11800
P		●	●	●	●	●
M		○	○	○	○	○
K		○	○	○	○	○
N						
S						
H						
O						

SNHX

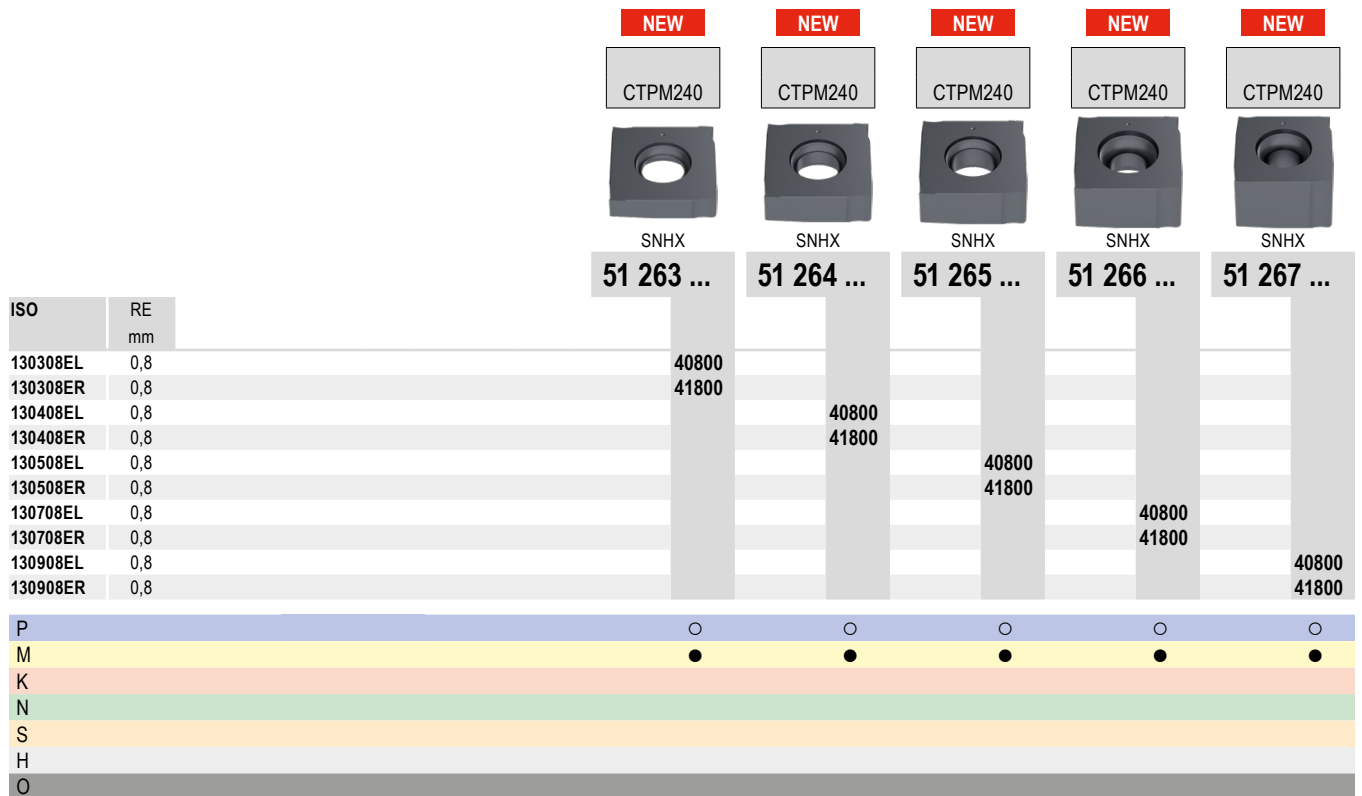

SNHX

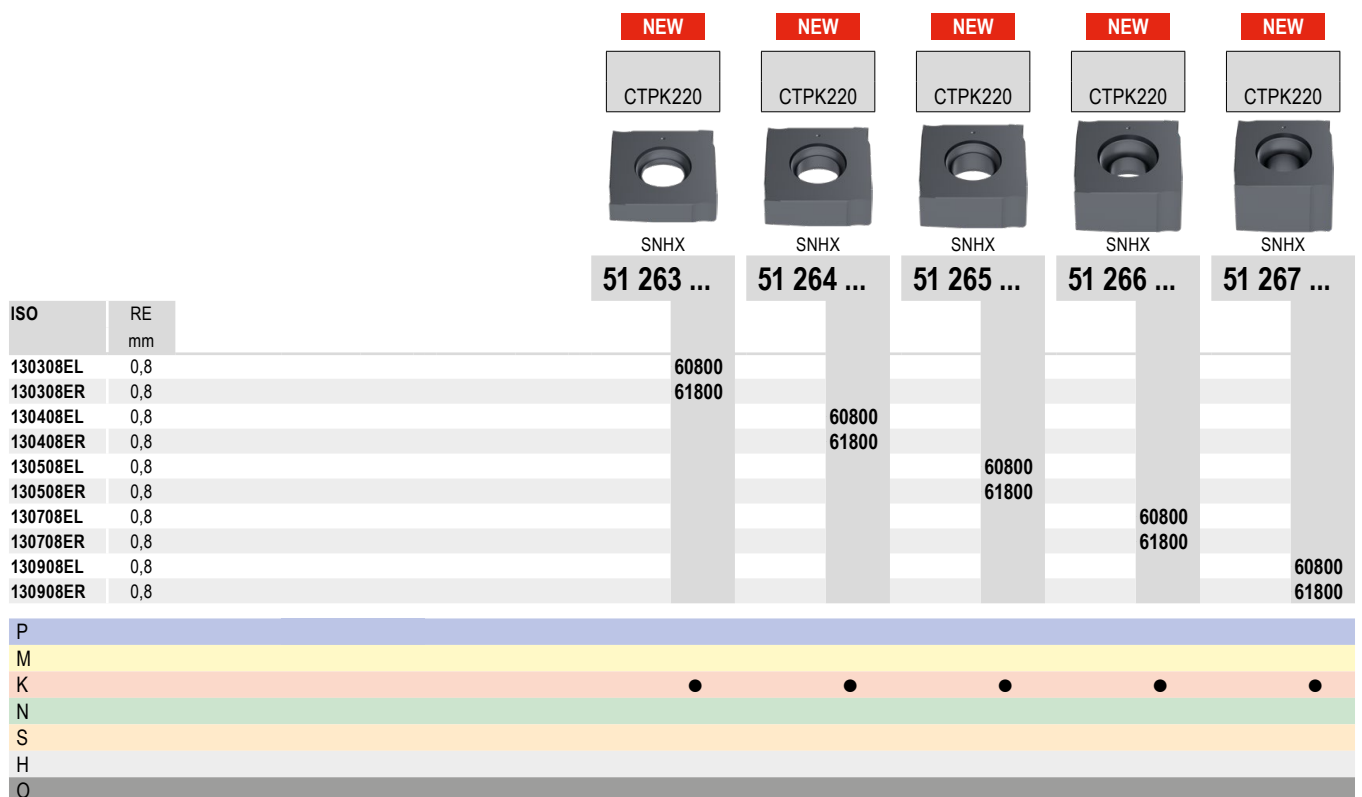

Material examples for cutting data tables

	Material sub-group	Index	Composition / Structure / Heat treatment	Tensile strength N/mm ² / HB / HRC	Material number	Material designation	Material number	Material designation
P	Unalloyed steel	P.1.1	< 0,15 % C Annealed	420 N/mm ² / 125 HB	1.0401	C15	1.1141	Ck15
		P.1.2	< 0,45 % C Annealed	640 N/mm ² / 190 HB	1.1191	C45E	1.0718	9SMnPb28
		P.1.3	< 0,45 % C Tempered	840 N/mm ² / 250 HB	1.1191	C45E	1.0535	C55
		P.1.4	< 0,75 % C Annealed	910 N/mm ² / 270 HB	1.1223	C60R	1.0535	C55
		P.1.5	< 0,75 % C Tempered	1010 N/mm ² / 300 HB	1.1223	C60R	1.0727	45S20
	Low-alloy steel	P.2.1	Annealed	610 N/mm ² / 180 HB	1.7131	16MnCr5	1.6587	17CrNiMo6
		P.2.2	Tempered	930 N/mm ² / 275 HB	1.7131	16MnCr5	1.6587	17CrNiMo6
		P.2.3	Tempered	1010 N/mm ² / 300 HB	1.7225	42CrMo4	1.3505	100Cr6
		P.2.4	Tempered	1200 N/mm ² / 375 HB	1.7225	42CrMo4	1.3505	100Cr6
	High-alloy steel and high-alloy tool steel	P.3.1	Annealed	680 N/mm ² / 200 HB	1.4021	X20Cr13	1.4034	X46Cr13
		P.3.2	Hardened and tempered	1100 N/mm ² / 300 HB	1.2343	X38CrMoV5-1	1.4034	X46Cr13
		P.3.3	Hardened and tempered	1300 N/mm ² / 400 HB	1.2343	X38CrMoV5-1	1.4034	X46Cr13
	Stainless steel	P.4.1	Ferritic / martensitic Annealed	680 N/mm ² / 200 HB	1.4016	X6Cr17	1.2316	X36CrMo16
		P.4.2	Martensitic Tempered	1010 N/mm ² / 300 HB	1.4112	X90CrMoV18	1.2316	X36CrMo16
M	Stainless steel	M.1.1	Austenitic / austenitic-ferritic Quenched	610 N/mm ² / 180 HB	1.4301	X5CrNi18-10	1.4571	X6CrNiMoTi17-12-2
		M.2.1	Austenitic Tempered	300 HB	1.4841	X15CrNiSi25-21	1.4539	X1NiCrMoCu25-20-5
		M.3.1	Austenitic / ferritic (Duplex)	780 N/mm ² / 230 HB	1.4462	X2CrNiMoN22-5-3	1.4501	X2CrNiMoCuWN25-7-4
K	Grey cast iron	K.1.1	Pearlitic / ferritic	350 N/mm ² / 180 HB	0.6010	GG-10	0.6025	GG-25
		K.1.2	Pearlitic (martensitic)	500 N/mm ² / 260 HB	0.6030	GG-30	0.6045	GG-45
	Spherulitic graphite cast iron	K.2.1	Ferritic	540 N/mm ² / 160 HB	0.7040	GGG-40	0.7060	GGG-60
		K.2.2	Pearlitic	845 N/mm ² / 250 HB	0.7070	GGG-70	0.7080	GGG-80
	Malleable iron	K.3.1	Ferritic	440 N/mm ² / 130 HB	0.8035	GTW-35-04	0.8045	GTW-45
		K.3.2	Pearlitic	780 N/mm ² / 230 HB	0.8165	GTS-65-02	0.8170	GTS-70-02
N	Aluminium wrought alloy	N.1.1	Non-hardenable	60 HB	3.0255	Al99,5	3.3315	AlMg1
		N.1.2	Hardenable Age-hardened	340 N/mm ² / 100 HB	3.1355	AlCuMg2	3.2315	AlMgSi1
	Cast aluminium alloy	N.2.1	≤ 12 % Si, non-hardenable	250 N/mm ² / 75 HB	3.2581	G-AlSi12	3.2163	G-AlSi9Cu3
		N.2.2	≤ 12 % Si, hardenable Age-hardened	300 N/mm ² / 90 HB	3.2134	G-AlSi5Cu1Mg	3.2373	G-AlSi9Mg
		N.2.3	> 12 % Si, non-hardenable	440 N/mm ² / 130 HB		G-AlSi17Cu4Mg		G-AlSi18CuNiMg
	Copper and copper alloys (bronze/brass)	N.3.1	Free-machining alloys, PB > 1 %	375 N/mm ² / 110 HB	2.0380	CuZn39Pb2 (Ms58)	2.0410	CuZn44Pb2
		N.3.2	CuZn, CuSnZn	300 N/mm ² / 90 HB	2.0331	CuZn15	2.4070	CuZn28Sn1As
		N.3.3	CuSn, lead-free copper and electrolytic copper	340 N/mm ² / 100 HB	2.0060	E-Cu57	2.0590	CuZn40Fe
	Magnesium alloys	N.4.1	Magnesium and magnesium alloys	70 HB	3.5612	MgAl6Zn	3.5312	MgAl3Zn
S	Heat-resistant alloys	S.1.1	Fe - basis Annealed	680 N/mm ² / 200 HB	1.4864	X12NiCrSi 36-16	1.4865	G-X40NiCrSi38-18
		S.1.2	Fe - basis Age-hardened	950 N/mm ² / 280 HB	1.4980	X6NiCrTiMoVB25-15-2	1.4876	X10NiCrAlTi32-20
		S.2.1	Ni or Co basis Annealed	840 N/mm ² / 250 HB	2.4631	NiCr20TiAl (Nimonic80A)	3.4856	NiCr22Mo9Nb
		S.2.2	Ni or Co basis Age-hardened	1180 N/mm ² / 350 HB	2.4668	NiCr19Nb5Mo3 (Inconel 718)	2.4955	NiFe25Cr20NbTi
		S.2.3	Ni or Co basis Cast	1080 N/mm ² / 320 HB	2.4765	CoCr20W15Ni	1.3401	G-X120Mn12
	Titanium alloys	S.3.1	Pure titanium	400 N/mm ²	3.7025	Ti99,8	3.7034	Ti99,7
		S.3.2	Alpha + beta alloys Age-hardened	1050 N/mm ² / 320 HB	3.7165	TiAl6V4	Ti-6246	Ti-6Al-2Sn-4Zr-6Mo
S.3.3	Beta alloys	1400 N/mm ² / 410 HB	Ti555.3	Ti-5Al-5V-5Mo-3Cr	R56410	Ti-10V-2Fe-3Al		
H	Hardened steel	H.1.1	Hardened and tempered	46–55 HRC				
		H.1.2	Hardened and tempered	56–60 HRC				
		H.1.3	Hardened and tempered	61–65 HRC				
		H.1.4	Hardened and tempered	66–70 HRC				
	Chilled iron	H.2.1	Cast	400 HB				
Hardened cast iron	H.3.1	Hardened and tempered	55 HRC					
O	Non-metal materials	O.1.1	Plastics, duroplastic	≤ 150 N/mm ²				
		O.1.2	Plastics, thermoplastic	≤ 100 N/mm ²				
		O.2.1	Aramid fibre-reinforced	≤ 1000 N/mm ²				
		O.2.2	Glass/carbon-fibre reinforced	≤ 1000 N/mm ²				
		O.3.1	Graphite					

* Tensile strength

Cutting data standard values for MaxiMill – Slot-SNHX

Index	CTPP235		CTPM240		CTPK220	
	DRAGONSKIN					
Cutting Material hard (v _{c↑}) → tough (v _{c↓})						
v _c (m/min)						
P.1.1	246	137	226	141		
P.1.2	208	121	188	126		
P.1.3	172	106	152	112		
P.1.4	160	101	140	107		
P.1.5	143	94	123	100		
P.2.1	214	123	194	128		
P.2.2	157	100	137	106		
P.2.3	143	94	123	100		
P.2.4	98	76	78	83		
P.3.1	121	97	126	105		
P.3.2	108	83	112	95		
P.3.3	96	69	98	85		
P.4.1	121	97	126	105		
P.4.2	114	90	119	100		
M.1.1	121	97	126	105		
M.2.1	108	83	112	95		
M.3.1	117	93	121	102		
K.1.1	160	110			320	190
K.1.2	150	110			170	100
K.2.1	150	110			210	130
K.2.2	150	110			140	90
K.3.1					200	120
K.3.2					170	100
N.1.1						
N.1.2						
N.2.1						
N.2.2						
N.2.3						
N.3.1						
N.3.2						
N.3.3						
N.4.1						
S.1.1						
S.1.2						
S.2.1						
S.2.2						
S.2.3						
S.3.1						
S.3.2						
S.3.3						
H.1.1						
H.1.2						
H.1.3						
H.1.4						
H.2.1						
H.3.1						
O.1.1						
O.1.2						
O.2.1						
O.2.2						
O.3.1						

average chip thickness
h_m in mm

Feed per tooth
f_z in mm

Feed rate
v_f in mm/min

$$h_m = \frac{f_z}{2} \sqrt{\frac{a_e}{DC}}$$

$$f_z = h_m \sqrt{\frac{DC}{a_e}}$$

$$v_f = f_z \times ZNF \times n$$

DC = Ø of the disc cutters

ZNF = Number of teeth of the cutter

Reference tool 50 374 12506 – ASLOT.125.R.12-SN13-06-DC-A32				
a _e	10	20	30	
h _m	f _z in mm			
P	0,11	0,39	0,28	0,22
M	0,08	0,28	0,20	0,16
K	0,13	0,46	0,33	0,27
N				
S				
H				
O				

ASLOT.125.R.12-SN13-06-DC-A32

Tool tooth count (Z)	12
Effective tooth count (Z/2)	6

The cutting data is strongly influenced by external conditions, such as the stability of the tool and workpiece clamping, material and type of machine. The specified values represent guideline cutting data that can be adjusted by approx. ±20% according to the usage conditions.

Cutting data standard values

Index	CTCP230		CTPP235		CTPM240		CTPM245		CTCM245		CTCK215		CTC5240		CTCS245	
	DRAGONSKIN															
	Cutting Material hard (v _c ↑) → tough (v _c ↓) v _c (m/min)															
P.1.1	286	150	246	137	226	141	244	139	279	134						
P.1.2	242	133	208	121	188	126	207	124	242	119						
P.1.3	202	118	172	106	152	112	173	109	208	104						
P.1.4	189	112	160	101	140	107	161	104	196	99						
P.1.5	169	105	143	94	123	100	144	97	179	92						
P.2.1	249	136	214	123	194	128	212	126	247	121						
P.2.2	185	111	157	100	137	106	158	103	193	98						
P.2.3	169	105	143	94	123	100	144	97	179	92						
P.2.4	118	85	98	76	78	83	101	78	136	73						
P.3.1	140	87	121	97	126	105	155	107	175	122						
P.3.2	90	55	108	83	112	95	143	93	163	108						
P.3.3	40	22	96	69	98	85	131	79	151	94						
P.4.1	140	87	121	97	126	105	155	107	175	122						
P.4.2	115	71	114	90	119	100	149	100	169	115						
M.1.1			121	97	126	105	155	107	175	122						
M.2.1			108	83	112	95	143	93	163	108						
M.3.1			117	93	121	102	152	103	172	118						
K.1.1	310	190	160	110							360	210				
K.1.2	160	100	150	110							220	130				
K.2.1	200	120	150	110							230	140				
K.2.2	130	80	150	110							160	100				
K.3.1	190	115									250	150				
K.3.2	160	100									210	130				
N.1.1																
N.1.2																
N.2.1																
N.2.2																
N.2.3																
N.3.1																
N.3.2																
N.3.3																
N.4.1																
S.1.1									80				80		64	
S.1.2									70				70		56	
S.2.1									35				35		28	
S.2.2									25				25		20	
S.2.3									30				30		24	
S.3.1									80				80		64	
S.3.2									50				50		40	
S.3.3									40				40		32	
H.1.1																
H.1.2																
H.1.3																
H.1.4																
H.2.1																
H.3.1																
O.1.1																
O.1.2																
O.2.1																
O.2.2																
O.3.1																

The cutting data is strongly influenced by external conditions, such as the stability of the tool and workpiece clamping, material and type of machine. The specified values represent guideline cutting data that can be adjusted by approx. ±20% according to the usage conditions.

MaxiMill HFCD-06 system

Machining strategy

Programmed radius $r3D = 2.0\text{ mm}$

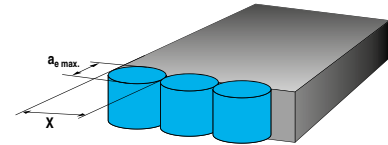
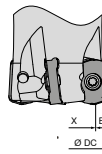
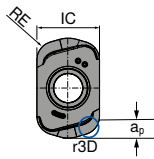

Cutting depth and remaining material			Cutting width for flat surfaces			Cutting depth when plunging				
IC in mm	RE in mm	$a_{p\text{ max}}$ in mm	DCX in mm	X in mm	B in mm	$a_{e\text{ max}}$ in mm	f_z in mm		X	
							initial	min.	max.	
6,05	1,8	0,8	16–66	$DCX - (2 \times B)$	4,3	5,3	0,10	0,08	0,15	$< 0,7 \times DCX$



DCX mm	circular Helical plunging (helical plunging into solid material)		
	D_{min} mm	D_{max} mm	$\alpha_{R\text{ max}}$ °
16	29	31	1,2°
20	36	39	1°
25	45	49	0,9°
32	59	63	0,65°
35	64	69	0,6°
40	74	79	0,5°
42	78	83	0,45°
50	94	99	0,35°
52	98	103	0,35°
63	120	125	0,3°
66	126	131	0,25°



DCX mm	axial		Angled
	Plunging		
	X_{max} mm	$\alpha_{R\text{ max}}$ °	
16	0,25	0,2	1,5°
20			1,4°
25			1,1°
32			0,9°
35			0,7°
40			0,65°
42			0,6°
50			0,5°
52			0,45°
63			0,4°
66	0,35°		

Starting Parameter



XNEU 06

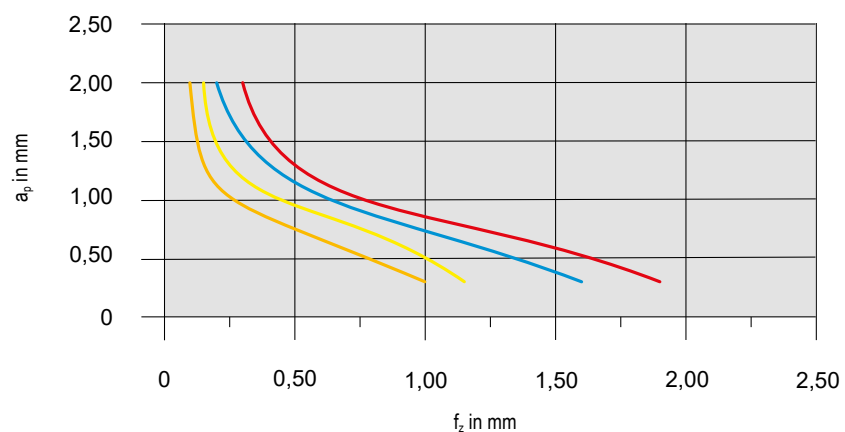

Material			Inserts		v_c in m/min	Cooling
Steel	P.2.2	40CrMnMoS 8-6	XNEU 06T318SR-M50	CTPP235	200	Dry
Stainless steel	M.1.1	X6CrNiMoTi 1712 2	XNEU 06T318SR-F50	CTPM240	180	Dry
Cast iron	K.1.1	EN-GJL-250 (GG25)	XNEU 06T318SR-R50	CTCK215	250	Dry
Heat-resistant	S.2.2	Inconel 718	XNEU 06T318ER-F40	CTC5240	35	Emulsion

Detailed information on cutting speed for each grade can be found on → page 49+50
From $v_c > 400\text{ m/min}$, the tool must be balanced!

System MaxiMill – Tangent-09

Machining strategy

LNHU 09 – DC/a_e Ratio (Dry machining at a_{p max.})

DC	ZNF	5%	10%	15%	20%	25%	30%	35%	40%	45%	50%	55%	60%	65%	70%	75%	80%	85%	90%	95%	100%			
25	3	P																						
		M																						
		K																						
	4	P																						
		M																						
		K																						
32	4	P																						
		M																						
		K																						
	5	P																						
		M																						
		K																						
40	4	P																						
		M																						
		K																						
	6	P																						
		M																						
		K																						
50	5	P																						
		M																						
		K																						
	7	P																						
		M																						
		K																						
63	7	P																						
		M																						
		K																						
	10	P																						
		M																						
		K																						
80	8	P																						
		M																						
		K																						
	11	P																						
		M																						
		K																						

Starting Parameter



LNHU 09

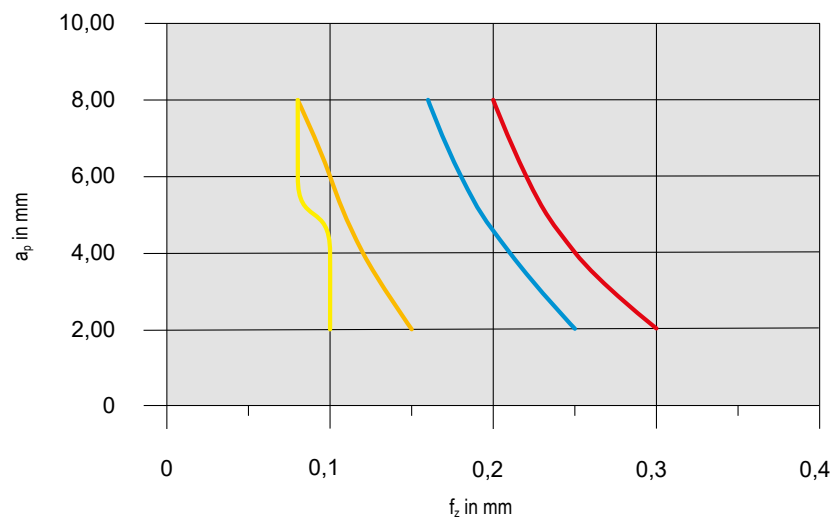

Material			Inserts		v _c in m/min	Cooling
Steel	P.2.2	40CrMnMoS 8-6	LNHU 090404-M50	CTPP235	200	Dry
Stainless steel	M.1.1	X6CrNiMoTi 1712 2	LNHU 090404-M50	CTPM240	120	Emulsion
Cast iron	K.1.1	EN-GJL-250 (GG25)	LNHU 090404-M50	CTCK215	250	Dry
Heat-resistant	S.2.2	Inconel 718	LNHU 090404-F40	CTC5240	35	Emulsion



Detailed information on cutting speed for each grade can be found on → page 49+50

From v_c > 400 m/min, the tool must be balanced!

System MaxiMill – Tangent-13

Machining strategy

LNHU 13 – DC/a_e Ratio (Dry machining at a_{p max.})

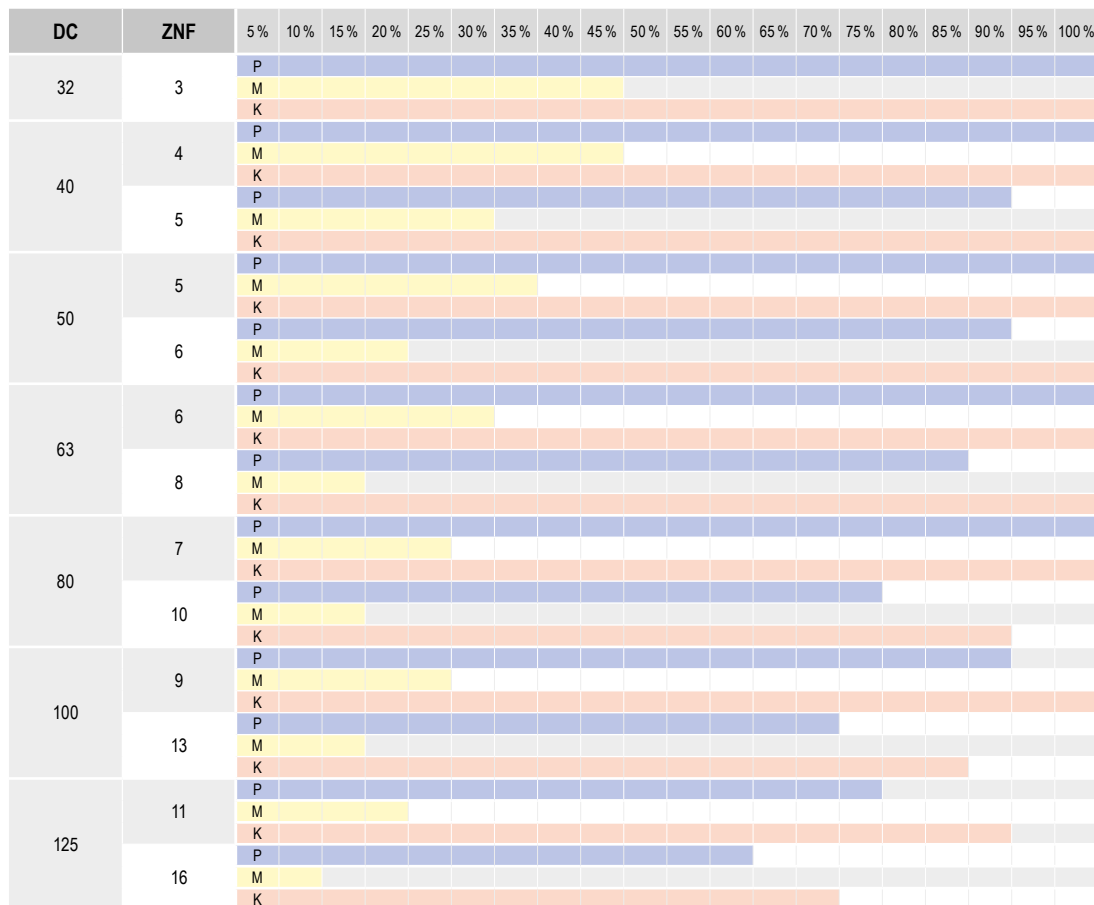

Starting Parameter



LNHU 13

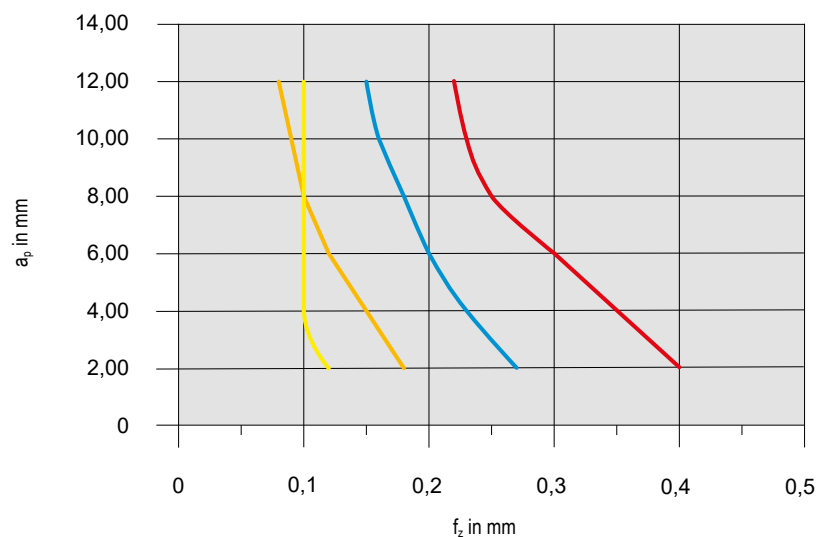

Material			Inserts		v _c in m/min	Cooling
Steel	P.2.2	40CrMnMoS 8-6	LNHU 130608-M50	CTPP235	200	Dry
Stainless steel	M.1.1	X6CrNiMoTi 1712 2	LNHU 130608-F50	CTPM240	120	Emulsion
Cast iron	K.1.1	EN-GJL-250 (GG25)	LNHU 130608-M50	CTCK215	250	Dry
Heat-resistant	S.2.2	Inconel 718	LNHU 130608-F50	CTC5240	35	Emulsion



Detailed information on cutting speed for each grade can be found on → page 49+50

From v_c > 400 m/min, the tool must be balanced!

Actively vibration-damped shell mill adapter

- ▲ The specially mounted damping core enables perfect machining results even with longer tool overhangs
- ▲ Reduction in machining times due to optimum machining parameters
- ▲ Damped machining and therefore perfect surface qualities
- ▲ Protection of the machine spindle and increased tool service life
- ▲ Screwed drive dogs
- ▲ Also available with Balluff chip **on request**

Scope of supply:

Base body with retaining screw and drive dog

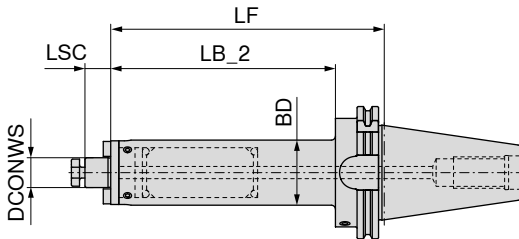

AD
G 2,5 n_{max} 25000

84 752 ...

Adapter	DCONWS	LB_2	LF	BD	LSC	
	mm	mm	mm	mm	mm	
SK 40	16	180,9	200	39	17	51679
SK 40	22	180,9	200	48	19	52279
SK 50	16	180,9	200	39	17	51678
SK 50	22	180,9	200	48	19	52278
SK 50	27	180,9	200	58	21	52778



Screw for drivers



Driver



Cross screw



clamping screw

83 950 ...

83 950 ...

83 367 ...

83 950 ...

Spare parts

DCONWS

16	M3x8	296	8x9x17,5	120	M8	016	M8x25	113
22	M4x12	297	10x11x20,5	121	M10	022	M10x25	124
27	M5x12	136	12x13x24,3	122	M12	027	M12x30	125

Accessories



→ 58, 60



→ 284

Pull stud

Others

Accessories can be found in the clamping technology catalogue
→ **Chapter 16, Adaptors and accessories**

Actively vibration-damped shell mill adapter

- ▲ The specially mounted damping core enables perfect machining results even with longer tool overhangs
- ▲ Reduction in machining times due to optimum machining parameters
- ▲ Damped machining and therefore perfect surface qualities
- ▲ Protection of the machine spindle and increased tool service life
- ▲ Screwed drive dogs
- ▲ Also available with Balluff chip **on request**

Scope of supply:

Base body with retaining screw and drive dog

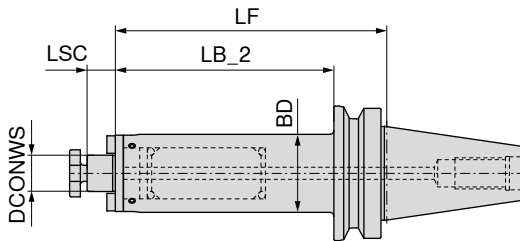

AD
G 2,5 n_{max} 25000

84 752 ...

Adapter	DCONWS	LB_2	LF	BD	LSC	
	mm	mm	mm	mm	mm	
BT 40	16	173,0	200	39	17	51669
BT 40	22	173,0	200	48	19	52269
BT 50	16	162,5	200	39	17	51668
BT 50	22	162,0	200	48	19	52268
BT 50	27	162,0	200	58	21	52768



Screw for drivers



Driver



Cross screw



clamping screw

83 950 ...

83 950 ...

83 367 ...

83 950 ...

Spare parts

DCONWS

16	M3x8	296	8x9x17,5	120	M8	016	M8x25	113
22	M4x12	297	10x11x20,5	121	M10	022	M10x25	124
27	M5x12	136	12x13x24,3	122	M12	027	M12x30	125

Accessories



→ 110+111



→ 284

Pull stud

Others

Accessories can be found in the clamping technology catalogue
→ **Chapter 16, Adaptors and accessories**

Actively vibration-damped shell mill adapter

- ▲ The specially mounted damping core enables perfect machining results even with longer tool overhangs
- ▲ Reduction in machining times due to optimum machining parameters
- ▲ Damped machining and therefore perfect surface qualities
- ▲ Protection of the machine spindle and increased tool service life
- ▲ Screwed drive dogs
- ▲ Also available with Balluff chip **on request**

Scope of supply:

Base body with retaining screw and drive dog

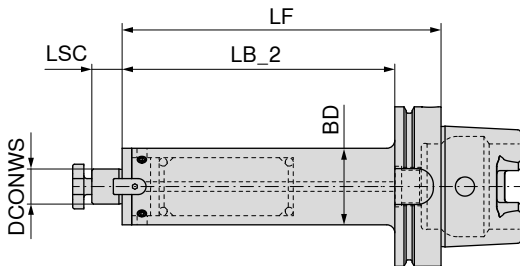

AD
G 2,5 n_{max} 25000

84 752 ...

Adapter	DCONWS	LB_2	LF	BD	LSC	
	mm	mm	mm	mm	mm	
HSK-A 63	16	174	200	39	17	51657
HSK-A 63	22	174	200	48	19	52257
HSK-A 100	16	171	200	39	17	51655
HSK-A 100	22	171	200	48	19	52255
HSK-A 100	27	171	200	58	21	52755

Spare parts

DCONWS

16	296	120	016	113
22	297	121	022	124
27	136	122	027	125

Screw for drivers	Driver	Cross screw	clamping screw
83 950 ...	83 950 ...	83 367 ...	83 950 ...

Accessories



Pull stud

Others

Accessories can be found in the clamping technology catalogue
→ **Chapter 16, Adapters and accessories**

Sustainability is not a goal, it's a mission.

We have an ambitious sustainability mission that will affect and change the entire supply chain. But we can only achieve true sustainability together. That's why our mission goes beyond our own scope:

We want to enable our customers to produce more sustainably with our products and services. With our ambitious mission, we want to make an important contribution to tackling the climate crisis.

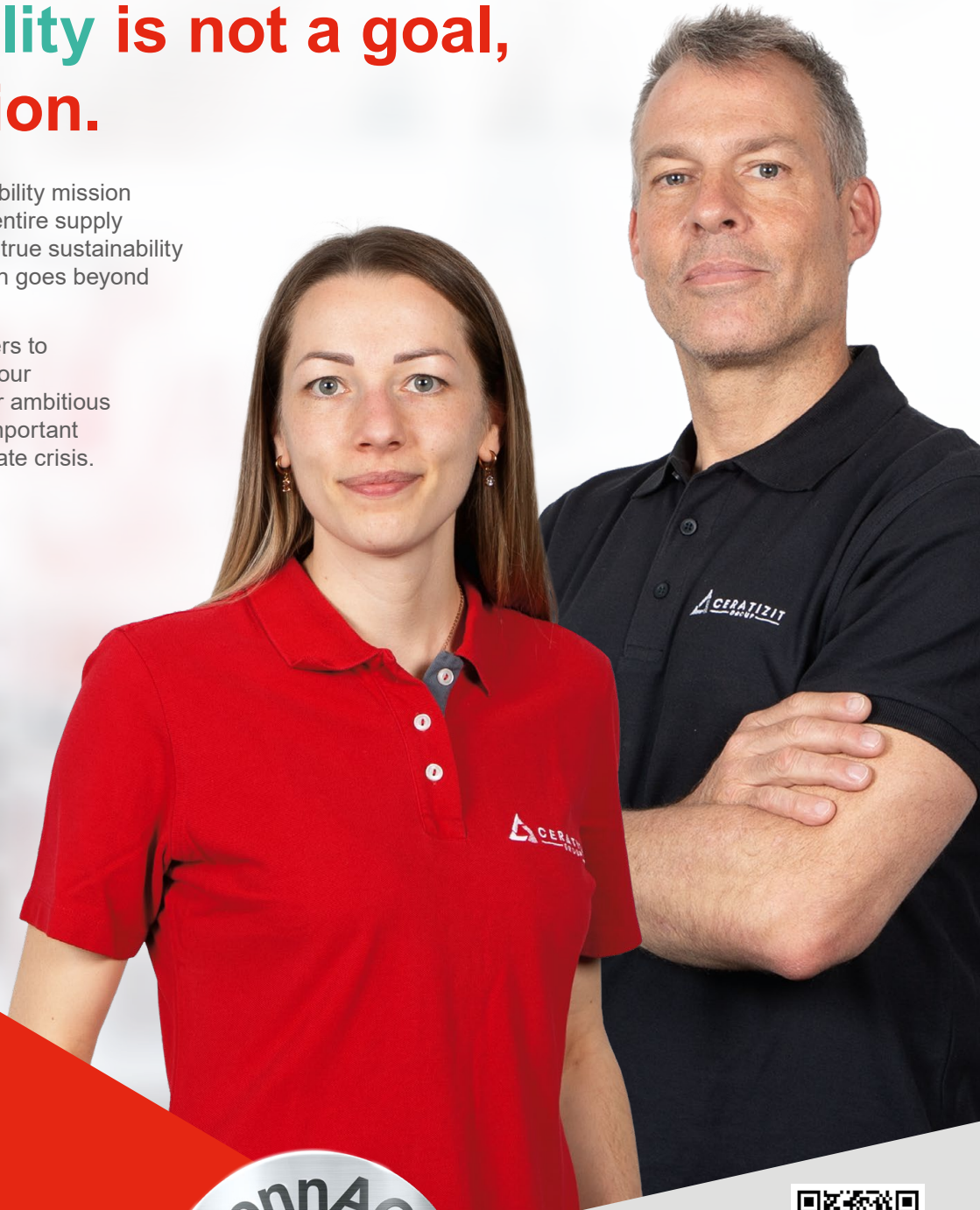

Mission #1:
Climate neutral by 2025



Mission #2:
Minimise the use of
virgin raw materials



cutting.tools/int/en/sustainability

CERATIZIT is a high-technology engineering group specialised in cutting tools and hard material solutions.

Tooling a Sustainable Future

ceratizit.com



CERATIZIT
GROUP

MNG mini – Base plate, rectangular, 52 x 52 mm

▲ Order mounting bolts separately

MNG mini 52 x 52

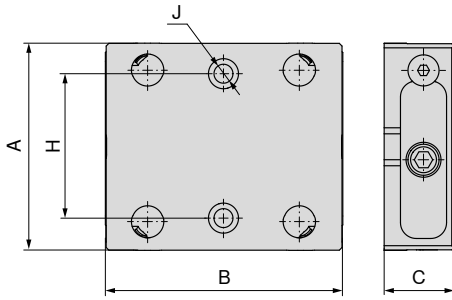

NEW

80 915 ...

Size	A mm	B mm	C _{±0,005} mm	H _{±0,01} mm	J _{F7} mm	WT kg
52 x 52	80	100	27	50	12	1,36

75200

MNG mini – Base plate, rectangular, 96 x 96 mm

▲ Order mounting bolts separately

MNG mini 96 x 96

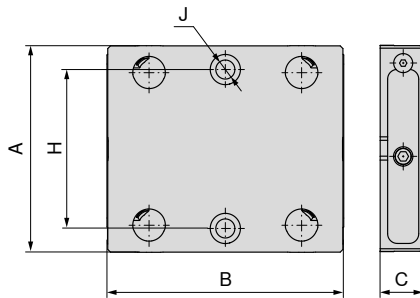

NEW

80 915 ...

Size	A mm	B mm	C _{±0,005} mm	H _{±0,01} mm	J _{F7} mm	WT kg
96 x 96	130	148	27	100	12	3,59

79600

MNG mini – combi-insert, 52 x 52 mm and 96 x 96 mm

▲ Order mounting bolts separately

MNG mini	52 x 52	96 x 96
----------	---------	---------

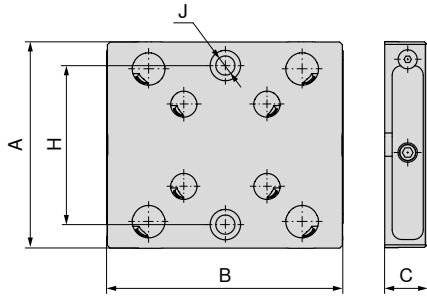

NEW

80 915 ...

Size	A mm	B mm	C _{±0.005} mm	H _{±0.01} mm	J _{F7} mm	WT kg
52 x 52 / 96 x 96	130	148	27	100	12	3,43

75900

MNG mini – combi-5-axis-increase, 52 x 52 mm and 96 x 96 mm

▲ Order mounting bolts separately

MNG mini	52 x 52	96 x 96
----------	---------	---------

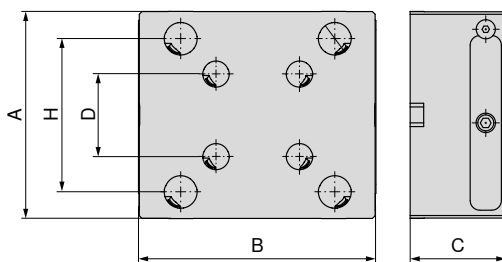

NEW

80 915 ...

A mm	B mm	C mm	D mm	H mm
130	148	60	52	96
130	148	100	52	96

56000

51000

MNG mini underside dimensions

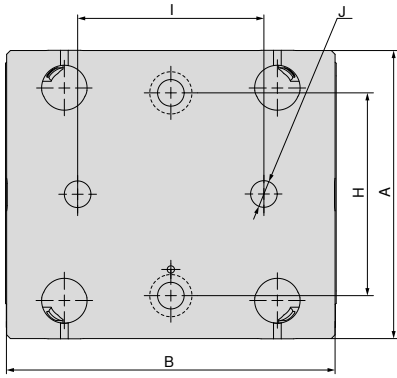

Base plate, rectangular, 52 x 52 mm

A	B	H	I _{±0.01}	J _{H7}
mm	mm	mm	mm	mm
80	100	50	40	12

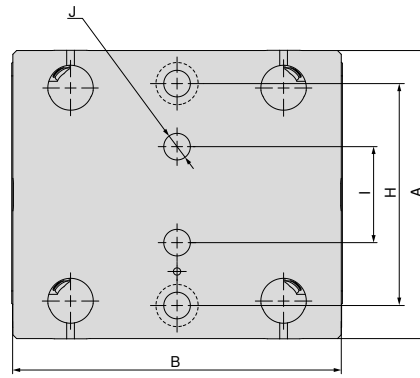

Base plate, rectangular, 96 x 96 mm

A	B	H	I _{±0.01}	J _{H7}
mm	mm	mm	mm	mm
130	148	100	50	12

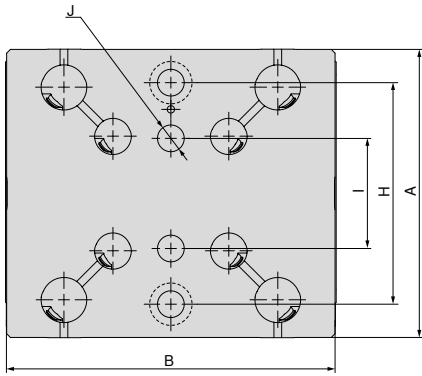

Combi-insert 1-sided,
52 x 52 mm and 96 x 96 mm

A	B	H	I _{±0.01}	J _{H7}
mm	mm	mm	mm	mm
130	148	100	50	12

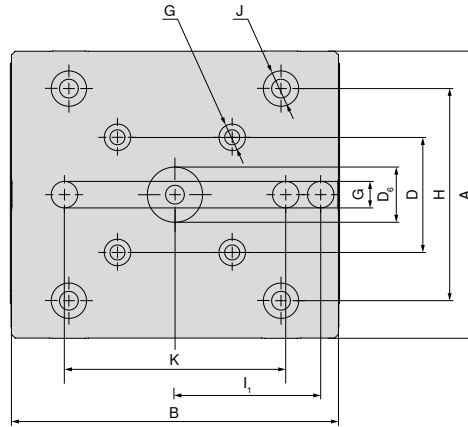

Combi-5-axis-increase,
52 x 52 mm and 96 x 96 mm

A	B	D	D _{6 H7}	G _{H7}	H	I _{1 ±0.01}	J _{H7}	K
mm	mm	mm	mm	mm	mm	mm	mm	mm
130	148	52	25	12	96	66	16	100

MNG mini mounting bolt set

Scope of supply:

Set contains four mounting bolts

MNG mini 96 x 96

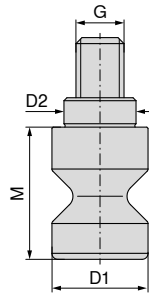

NEW

80 915 ...

D ₁ h6	D ₂ h6	M	G	TQX	Clamping force	for
mm	mm	mm	mm	Nm	kN	
20	16	22	M10	18	15	96 x 96

51100

Expansion aid

MNG mini



NEW

80 915 ...

D ₁	M
mm	mm
15	40

51300

Clamping Screw Set for T-slot for MNG mini

Scope of supply:

Clamping screw and T-Nuts

MNG mini



NEW

80 915 ...

for slot width	G	
mm		
14	M12	62400
16	M12	62600
18	M12	62800

Mounting bolt set – LANG / HWR

Scope of supply:

Set contains four mounting bolts

**MNG
mini**

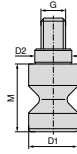

NEW

80 915 ...

TQX Nm	Clamping force kN	D ₁ h6 mm	D ₂ h6 mm	M mm	for	
18	15	15	12	22	52 x 52	51500
18	15	19	16	22	96 x 96	51400

Alignment/centering set for T-slots

▲ A = groove spacing

Scope of supply:

1 Terminal block, 2 T-nuts, 2 screws, 2 washers for width 12 mm, without clamping strip!

**MNG
mini**



NEW

80 915 ...

for slot width mm	A mm	G	
12	35	M10	82200
14	35	M10	82400
16	35	M10	82600
18	40	M10	82800

Workpiece supports overview – Verso

Workpiece supports, offset

▲ Price for 2 pieces

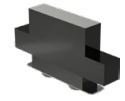
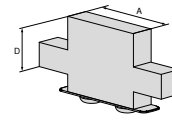

For vice width	A	A ₁	D	D ₁	D ₂	E	M	M ₁	M ₂
90	40		22						

NEW

80 914 70300	NCG	H5G / -S / -Z	X5G-Z / -S	ESG 4	ESG 5	HDG 2	ZSG 4	ZSG mini	DSG 4	Verso	HSG
										●	

Workpiece supports, offset

▲ Price for 2 pieces

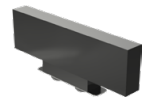
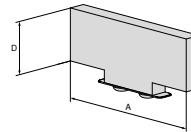

For vice width	A	A ₁	D	D ₁	D ₂	E	M	M ₁	M ₂
90	90		22						

NEW

80 914 72500	NCG	H5G / -S / -Z	X5G-Z / -S	ESG 4	ESG 5	HDG 2	ZSG 4	ZSG mini	DSG 4	Verso	HSG
										●	

MNG – base plate 4-sided with indexing, 330 x 400 mm

- ▲ MNG – Mechanical zero point clamping system
- ▲ Stainless and vacuum-hardened
- ▲ Insertion force 20 kN on each clamping bolt
- ▲ 15 x M12 mounting holes for T-slot spacing 50, 63, 100, 125 mm
- ▲ 2 x locating holes Ø18 G7 for positioning
- ▲ 1 x locating hole Ø12 F7 for positioning

MNG

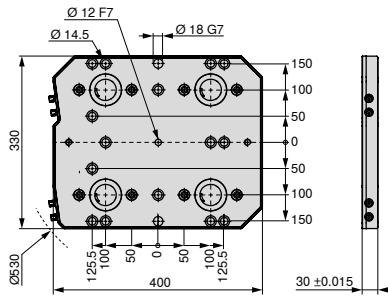

NEW

80 899 ...

Size	WT
330x400 mm	28

64200¹⁾

1) Not ex-stock

MNG – base plate 6-sided with indexing, 400 x 400 mm

- ▲ MNG – Mechanical Zero-point Clamping System
- ▲ Stainless and vacuum-hardened
- ▲ Insertion force 20 kN on the clamping bolt
- ▲ 14 x mounting holes for M16, for T-slot spacing 63, 80, 100, 125 mm
- ▲ 2 x mounting holes for M12
- ▲ 2 x mating holes Ø18 G7 for positioning
- ▲ 1 x mating holes Ø12 F7 for positioning

MNG

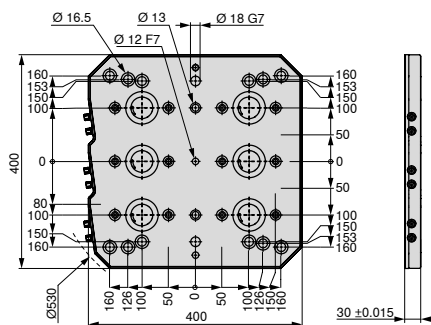

NEW

80 899 ...

Size	WT
400x400 mm	33

64300¹⁾

1) Not ex-stock

MNG – base plate 6-sided with indexing, 400 x 530 mm

- ▲ MNG – Mechanical zero point clamping system
- ▲ Stainless and vacuum-hardened
- ▲ Insertion force 20 kN on each clamping bolt
- ▲ 24 x M12 mounting holes for T-slot spacing 63, 100, 125 mm
- ▲ 2 x locating holes Ø18 G7 for positioning
- ▲ 1 x locating hole Ø12 F7 for positioning

MNG

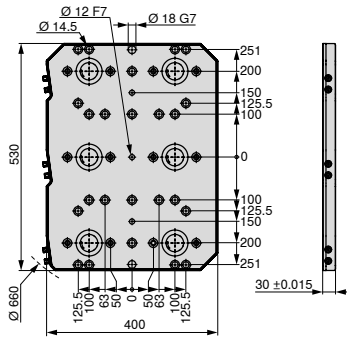

NEW

80 899 ...

Size	WT kg
400x530 mm	45

64400¹⁾

1) Not ex-stock

MNG – base plate 10-sided with indexing, 496.5 x 532 mm

- ▲ MNG – Mechanical Zero-point Clamping System
- ▲ Stainless and vacuum-hardened
- ▲ Insertion force 20 kN on the clamping bolt
- ▲ 27 x mounting holes M12 for T-slot spacing 50, 63, 100, 125 mm and star slots 45°
- ▲ 2 x mating holes Ø18 G7 for positioning
- ▲ 1 x mating holes Ø12 F7 for positioning

MNG

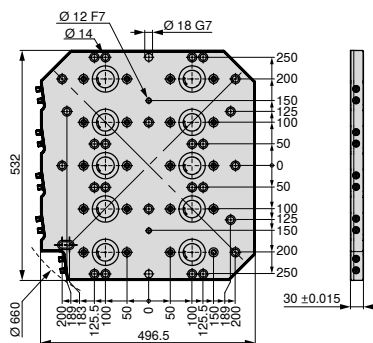

NEW

80 899 ...

Size	WT kg
496,5x532 mm	54

64500¹⁾

1) Not ex-stock

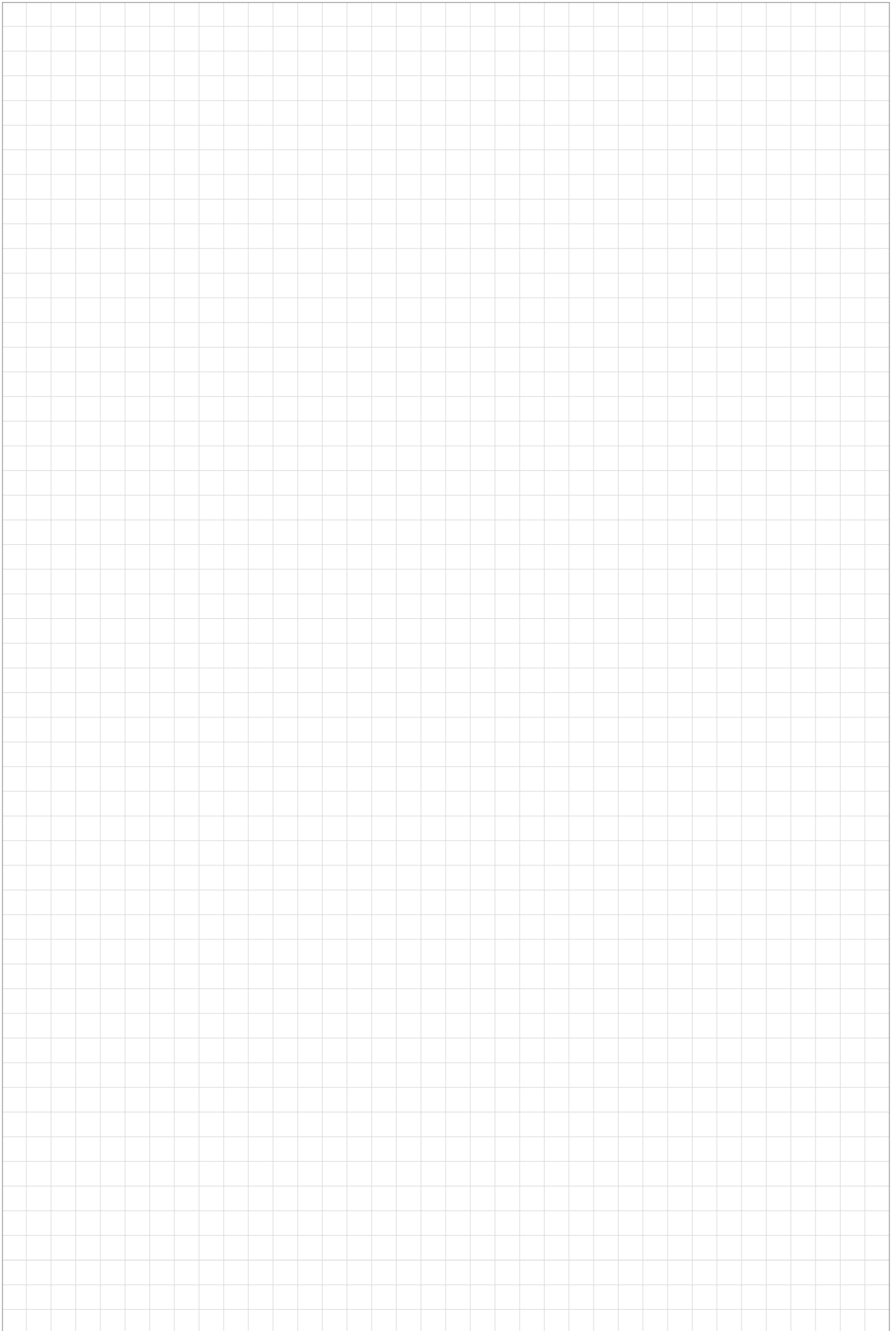



Part of the Plansee Group

We reserve the right to make technical changes and product improvements.

02/2025 - 94 221 00265