

UP **2** DATE

Machining titanium the easy way!

MaxiMill – 211-DC with DirectCooling

Faster. Longer. Safer.

... ADDITIONAL PRODUCT HIGHLIGHTS

- ▲ **Cermet grade CTEP110-P:**
Be amazed with our Coating update
for finish turning
- ▲ Precise aluminum machining complex
small components with the new
Micro milling cutters AluLine – Micro

CERATIZIT is a high-technology engineering group specialised in cutting tools and hard material solutions.

Tooling a Sustainable Future

ceratizit.com



Welcome!



It couldn't be easier

Ordering via the Online Shop

<https://cuttingtools.ceratizit.com>



On-site technical support

Your Local Technical Sales Engineer

Your customer number



Precision cooling strategy

with the additively manufactured
MaxiMill – 211-DC milling system

CERATIZIT

The ideal nozzle position for decisive added value when machining titanium and other heat-resistant materials

Want to achieve maximum process security despite high cutting speeds while working efficiently?

We offer you these exact advantages in a single tool – our 3D-printed MaxiMill – 211-DC indexable insert milling system manufactured here at CERATIZIT. The patented shoulder mill stands out for its decisive added value when machining titanium and other heat-resistant materials, thanks to an **optimum DirectCooling supply on the indexable insert flanks**. Because these materials in particular require the most effective possible cooling with emulsion to achieve a good machining result.



 → from page 44
You can find further information on the product here.

cts.ceratizit.com/en/maximill-211-dc



CERATIZIT

The cool way to machine titanium alloys

Optimising the flank cooling system for machining titanium and super alloys was a top priority for the base body of the MaxiMill – 211-DC. So our developers at CERATIZIT came up with a concept that wouldn't have been possible with conventional machining processes. The aim was to deliver as much coolant as possible straight to the cutting edge. This called for a highly complex design that was feasible thanks to additive manufacturing.



3D-printed tool holder with perfectly positioned coolant channels

Advantage/benefit

- ▲ Optimum DirectCooling supply on the indexable insert flanks
- ▲ Indexable insert geometry and nozzle position perfectly tailored to DirectCooling

Less wear to indexable inserts
Enables higher machining parameters

→ Lowers tool costs
→ Optimises production time

The perfect combination: an ideal nozzle position with matching insert geometry

Produced with additive manufacturing, the base body of the milling cutter on the MaxiMill – 211-DC opens up scope for the complexity required for flank cooling. This creates the perfect combination of geometric and functional properties – the ideal nozzle position, paired with an **insert geometry that is precisely tailored** for cooling – guaranteeing full-coverage wetting of the coolant on the indexable insert cutting surface.

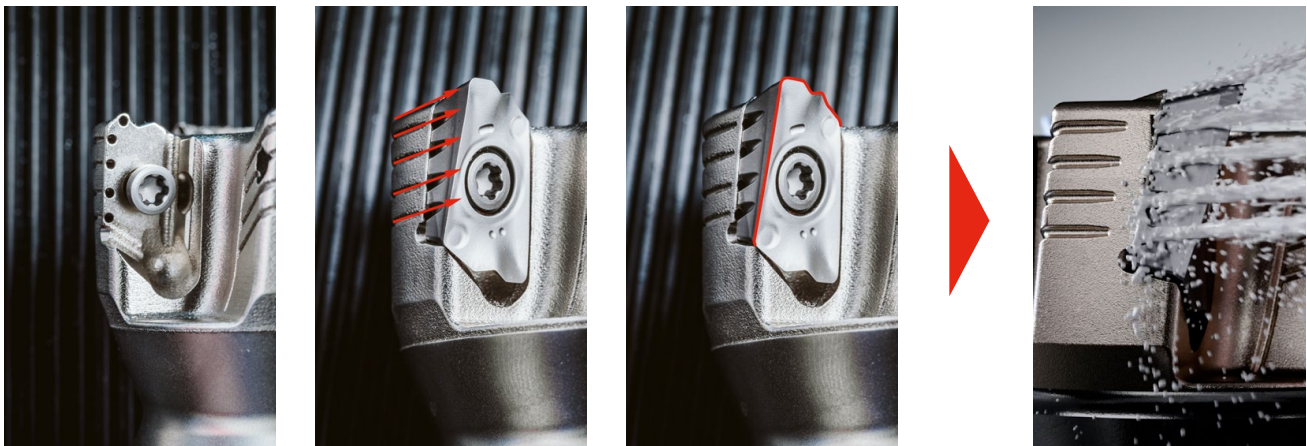

Test report: Service life [min] compared to standard tools

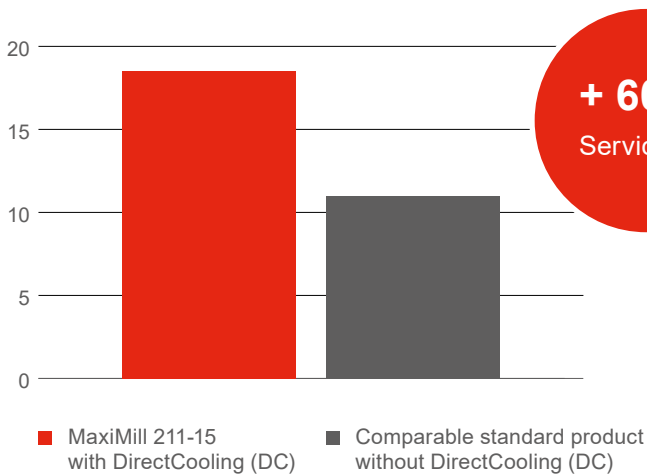

Machine: GROB G1050
Workpiece: TiAl6V4
Tool: MaxiMill – 211-DC
 v_c : 65 m/min.
 a_p : 6 mm / a_e 18 mm / f_z 0,13 mm
Coolant pressure: 80 bar

“

Having that extra time on the service life really takes the pressure off for our customers when machining titanium and super alloys. Plus, they benefit from a reliable process – with significantly lower tool usage.

Manuel Höfferer, Application Manager Aerospace & Defence

”





Small-scale aluminium machining

with AluLine – Micro



WNT

Micro cutter for complex micro components

AluLine – Micro: with DLC coating and minimal tolerances

Workpieces are getting smaller all the time – from the medtech sector, to the latest smartphones, through to elegant watch cases. This means the tools used to make these components are going miniature as well. So we decided to completely redesign the micro cutters in our AluLine – Micro range and adapt them to the industry's requirements.



→ from page 34

You can find further information on the product here.



cts.ceratizit.com/en/aluline-micro

Advantages of the AluLine – Micro cutters

- ▲ Latest geometry
- ▲ Polish grinding for uniform cutting edges and optimal chip removal
- ▲ Wear-resistant, thin and ultra-smooth DLC coating
- ▲ Outstanding price-performance ratio
- ▲ Extensive, integrated range up to overhang lengths of 12xD
- ▲ Also suitable for shrinking with shank diameter of 4 mm
- ▲ Smallest tolerances, for maximum contour quality on the component (3 μm at diameter of 0.2 mm)

Large portfolio of micro tools for machining aluminium

We offer a range of tool variants for AluLine – Micro:

- ▲ Radius and torus cutters, plus end mills with corner chamfer
- ▲ Various shank versions and geometries
- ▲ Diameters ranging from 0.2 mm to 3.0 mm
- ▲ Overhang lengths from 3xD to 12xD

With this product range, CNC machinists can be confident they have the right tool for most micro-cutting jobs involving aluminium alloys, copper and other non-ferrous metals.

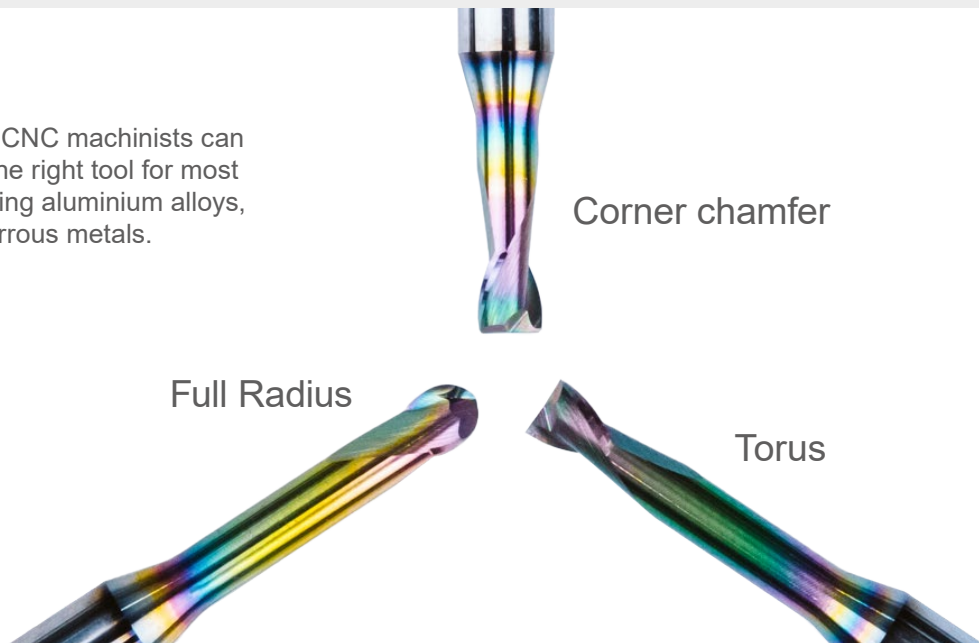

Cermet cutting material grades take finish turning to the next level



CERATIZIT

Coating update for cermet CTEP110-P grade

Cermet cutting inserts are a top choice for those looking to lower their costs when finishing steel. These cutting inserts are more heat-resistant than those made of carbide, so CNC Machinists can use higher cutting data and shorten their processes. Other stand-out features include dimensional accuracy and long service lives, especially when the cutting inserts are equipped with a powerful DRAGONSKIN coating including insert detection – which is exactly what the new cermet inserts from CERATIZIT do.

 → from page 14
You can find further information on the product here.



cts.ceratzit.com/en/cermet-inserts

Why choose cermet?

Cermet offers a number of advantages over carbide in certain applications, creating the conditions for very high cutting speeds in combination with long service lives – while delivering extremely smooth surfaces on the workpiece.

Efficient production thanks to all-round package with optimised characteristics

Advantages of the CTEP110-P cermet cutting material with a new coating:

- ▲ Unique multilayer CVD coating
- ▲ Gold-coloured indicator layer for insert detection
- ▲ Improved texture and grain sizes of TiCN- & Al₂O₃ layers
- ▲ Special post-treatment process
- ▲ Optimised chip breakers
- ▲ Perfect match between chip breakers and grade

- 
- Cutting edges utilised to best possible extent
 - Reduced surface roughness
 - High wear resistance
 - Maximum cutting speed
 - Perfect chip control
 - Improved service life
 - Lower parts per cost (CPP)



Tool change before tool breakage

Thanks to the newly updated coating with insert detection, wear is more readily identified simply by taking a quick look at the cutting edges. This lets you utilise each individual cutting edge on the indexable insert to the best possible extent while avoiding tedious tool breakages.

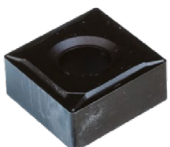

Predecessor insert with coating / without insert detection

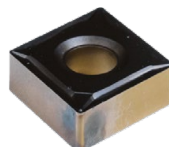

CTEP110-P with coating upgrade and insert detection

Table of contents

WNT Solid carbide drilling

12+13 WTX Speed VA 8xD

CERATIZIT Turning Tools

14–22 CTEP110-P cermet indexable inserts

23–25 ISO turning inserts

CERATIZIT Grooving Tools

30–33 GX35 system

WNT Solid Carbide milling cutters

34–42 AluLine – Micro cutter



Micro cutter
AluLine – Micro





Cermet indexable inserts CTEP110-P

CERATIZIT Milling tools with indexable inserts

44–47 **MaxiMill – 211-DC**

CERATIZIT Adapters and accessories

48–53 HyPower – high pressure chucks

54–56 Shell mill adapter with reduced flange diameter

57–60 Cylindrical shank adapter (Weldon)

61 BMT tool holders

WNT Workpiece clamping

62 **CentriClamp – ZSG mini – clamping tower**

63 MNG mini – 4-sided clamping tower

64 Verso system jaws



Shoulder milling system **MaxiMill – 211-DC**

WTX – High Speed Drill, DIN 6537

- ▲ For corrosion and acid-resistant steels
- ▲ Developed for high cutting speeds
- ▲ Three guide lands for low friction

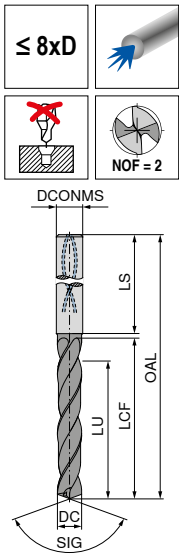

NEW
Speed VA
Ti800



SIG 135°
Solid carbide

10 701 ...

DC _{h7} mm	DCONMS _{h6} mm	OAL mm	LCF mm	LU mm	LS mm	
3,0	6	72	34	29	36	03000
3,1	6	72	34	29	36	03100
3,2	6	72	34	29	36	03200
3,3	6	72	34	29	36	03300
3,4	6	72	34	29	36	03400
3,5	6	72	34	29	36	03500
3,6	6	72	34	29	36	03600
3,7	6	72	34	29	36	03700
3,8	6	81	43	36	36	03800
3,9	6	81	43	36	36	03900
4,0	6	81	43	36	36	04000
4,1	6	81	43	36	36	04100
4,2	6	81	43	36	36	04200
4,3	6	81	43	36	36	04300
4,4	6	81	43	36	36	04400
4,5	6	81	43	36	36	04500
4,6	6	81	43	36	36	04600
4,8	6	95	57	48	36	04800
5,0	6	95	57	48	36	05000
5,1	6	95	57	48	36	05100
5,2	6	95	57	48	36	05200
5,3	6	95	57	48	36	05300
5,4	6	95	57	48	36	05400
5,5	6	95	57	48	36	05500
5,6	6	95	57	48	36	05600
5,7	6	95	57	48	36	05700
5,8	6	95	57	48	36	05800
5,9	6	95	57	48	36	05900
6,0	6	95	57	48	36	06000
6,1	8	114	76	64	36	06100
6,2	8	114	76	64	36	06200
6,3	8	114	76	64	36	06300
6,4	8	114	76	64	36	06400
6,5	8	114	76	64	36	06500
6,6	8	114	76	64	36	06600
6,8	8	114	76	64	36	06800
6,9	8	114	76	64	36	06900
7,0	8	114	76	64	36	07000
7,5	8	114	76	64	36	07500
7,8	8	114	76	64	36	07800
8,0	8	114	76	64	36	08000
8,1	10	142	95	80	40	08100
8,2	10	142	95	80	40	08200
8,3	10	142	95	80	40	08300
8,5	10	142	95	80	40	08500

10 701 ...

DC _{h7} mm	DCONMS _{h6} mm	OAL mm	LCF mm	LU mm	LS mm	
8,8	10	142	95	80	40	08800
9,0	10	142	95	80	40	09000
9,3	10	142	95	80	40	09300
9,5	10	142	95	80	40	09500
9,8	10	142	95	80	40	09800
10,0	10	142	95	80	40	10000
10,2	12	162	114	96	45	10200
10,5	12	162	114	96	45	10500
10,8	12	162	114	96	45	10800
11,0	12	162	114	96	45	11000
11,5	12	162	114	96	45	11500
11,8	12	162	114	96	45	11800
12,0	12	162	114	96	45	12000
12,2	14	178	133	112	45	12200
12,5	14	178	133	112	45	12500
12,8	14	178	133	112	45	12800
13,0	14	178	133	112	45	13000
13,5	14	178	133	112	45	13500
13,8	14	178	133	112	45	13800
14,0	14	178	133	112	45	14000
14,5	16	203	152	128	48	14500
15,0	16	203	152	128	48	15000
15,5	16	203	152	128	48	15500
16,0	16	203	152	128	48	16000
16,5	18	222	171	144	48	16500
17,0	18	222	171	144	48	17000
17,5	18	222	171	144	48	17500
18,0	18	222	171	144	48	18000

P	●
M	●
K	●
N	○
S	●
H	
O	

→ v_c Page 13

Cutting data standard values – WTX – Speed VA

	Material sub-group	Index	Tensile strength N/mm ² / HB / HRC	10 701 ...					
				with through coolant					
				8xD					
				Ø 3–5	Ø 5–8	Ø 8–12	Ø 12–16	Ø 16–20	
				v _c (m/min)	f (mm/rev)				
P	Unalloyed steel	P.1.1	420 N/mm ² / 125 HB	165	0,12	0,17	0,23	0,28	0,31
		P.1.2	640 N/mm ² / 190 HB	160	0,11	0,16	0,22	0,26	0,30
		P.1.3	840 N/mm ² / 250 HB	150	0,11	0,15	0,20	0,25	0,28
		P.1.4	910 N/mm ² / 270 HB	145	0,10	0,15	0,19	0,24	0,27
		P.1.5	1010 N/mm ² / 300 HB	135	0,10	0,14	0,18	0,23	0,26
	Low-alloy steel	P.2.1	610 N/mm ² / 180 HB	165	0,14	0,20	0,27	0,33	0,37
		P.2.2	930 N/mm ² / 275 HB	150	0,13	0,18	0,24	0,30	0,34
		P.2.3	1010 N/mm ² / 300 HB	135	0,11	0,16	0,22	0,27	0,30
		P.2.4	1200 N/mm ² / 375 HB	105	0,11	0,15	0,19	0,24	0,27
	High-alloy steel and high-alloy tool steel	P.3.1	680 N/mm ² / 200 HB	115	0,11	0,16	0,22	0,27	0,30
		P.3.2	1100 N/mm ² / 300 HB	90	0,10	0,13	0,18	0,22	0,25
		P.3.3	1300 N/mm ² / 400 HB	90	0,08	0,11	0,14	0,17	0,19
	Stainless steel	P.4.1	680 N/mm ² / 200 HB	70	0,08	0,11	0,14	0,18	0,20
		P.4.2	1010 N/mm ² / 300 HB	70	0,08	0,11	0,14	0,18	0,20
M	Stainless steel	M.1.1	610 N/mm ² / 180 HB	80	0,09	0,13	0,18	0,22	0,25
		M.2.1	300 HB	75	0,08	0,11	0,15	0,19	0,21
		M.3.1	780 N/mm ² / 230 HB	75	0,08	0,11	0,15	0,19	0,21
K	Grey cast iron	K.1.1	350 N/mm ² / 180 HB	150	0,15	0,24	0,33	0,41	0,47
		K.1.2	500 N/mm ² / 260 HB	125	0,14	0,20	0,27	0,33	0,37
	Spherulitic graphite cast iron	K.2.1	540 N/mm ² / 160 HB	200	0,15	0,22	0,31	0,38	0,43
		K.2.2	845 N/mm ² / 250 HB	125	0,14	0,20	0,27	0,33	0,37
	Malleable iron	K.3.1	440 N/mm ² / 130 HB	115	0,15	0,21	0,29	0,35	0,40
		K.3.2	780 N/mm ² / 230 HB	100	0,12	0,17	0,23	0,28	0,32
N	Aluminium wrought alloy	N.1.1	60 HB						
		N.1.2	340 N/mm ² / 100 HB						
	Cast aluminium alloy	N.2.1	250 N/mm ² / 75 HB						
		N.2.2	300 N/mm ² / 90 HB						
		N.2.3	440 N/mm ² / 130 HB						
	Copper and copper alloys (bronze/brass)	N.3.1	375 N/mm ² / 110 HB						
		N.3.2	300 N/mm ² / 90 HB	145	0,14	0,20	0,27	0,33	0,37
N.3.3	340 N/mm ² / 100 HB								
N.4.1	Magnesium alloys	70 HB							
S	Heat-resistant alloys	S.1.1	680 N/mm ² / 200 HB	35	0,07	0,10	0,14	0,17	0,19
		S.1.2	950 N/mm ² / 280 HB	25	0,05	0,07	0,10	0,12	0,14
		S.2.1	840 N/mm ² / 250 HB	25	0,05	0,07	0,10	0,12	0,14
		S.2.2	1180 N/mm ² / 350 HB	20	0,06	0,09	0,12	0,15	0,17
		S.2.3	1080 N/mm ² / 320 HB	20	0,05	0,07	0,10	0,12	0,14
	Titanium alloys	S.3.1	400 N/mm ²						
		S.3.2	1050 N/mm ² / 320 HB	35	0,08	0,11	0,15	0,18	0,20
S.3.3	1400 N/mm ² / 410 HB	30	0,06	0,09	0,12	0,15	0,17		
H	Hardened steel	H.1.1	46–55 HRC						
		H.1.2	56–60 HRC						
		H.1.3	61–65 HRC						
		H.1.4	66–70 HRC						
	Chilled iron	H.2.1	400 HB						
Hardened cast iron	H.3.1	55 HRC							
O	Non-metal materials	O.1.1	≤ 150 N/mm ²						
		O.1.2	≤ 100 N/mm ²						
		O.2.1	≤ 1000 N/mm ²						
		O.2.2	≤ 1000 N/mm ²						
		O.3.1							

* Tensile strength



The cutting data depends extremely on the external conditions, the material and machine type. The indicated values are possible values which have to be increased or reduced according to the application conditions.

CNMG

Designation	L mm	S mm	D1 mm	IC mm
CNMG 1204..	12,9	4,76	5,16	12,7

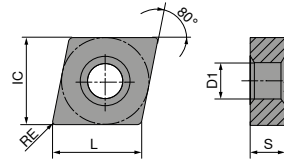

CNMG

ISO	RE mm
120404EN	0,4
120408EN	0,8
120412EN	1,2

P	●	●
M	○	○
K	○	○
N		
S		
H		
O		

NEW	NEW
-CF20 CTEP110-P	-TFQ CTEP110-P
DRAGONSKIN	DRAGONSKIN
F CERMET CNMG	F CERMET CNMG
76 101 ...	76 110 ...
02801	02801
03001	03001
	03201

DNMG

Designation	L mm	S mm	D1 mm	IC mm
DNMG 1104..	11,6	4,76	3,81	9,52
DNMG 1506..	15,5	6,35	5,16	12,70

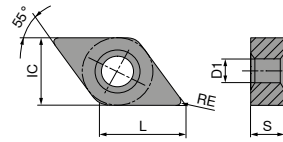

DNMG

ISO	RE mm
110404EN	0,4
110408EN	0,8
150604EN	0,4
150608EN	0,8
150612EN	1,2

P	●	●
M	○	○
K	○	○
N		
S		
H		
O		

NEW	NEW
-CF20 CTEP110-P	-TFQ CTEP110-P
DRAGONSKIN	DRAGONSKIN
○ ○ ○	○ ○ ○
F CERMET DNMG	F CERMET DNMG
76 102 ...	76 153 ...
00401	
00601	
02801	02801
03001	03001
03201	

TNMG

Designation	L mm	S mm	D1 mm	IC mm
TNMG 1604..	16,5	4,76	3,81	9,52

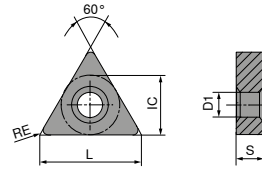

TNMG

NEW

-CF20
CTEP110-P

DRAGONSKIN

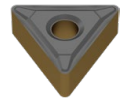

F
CERMET
TNMG

76 149 ...

ISO	RE mm	
160404EN	0,4	01601
160408EN	0,8	01801
160412EN	1,2	02001
P		●
M		○
K		○
N		
S		
H		
O		

WNMG

Designation	L mm	S mm	D1 mm	IC mm
WNMG 0604..	6,5	4,76	3,81	9,52
WNMG 0804..	8,6	4,76	5,16	12,70

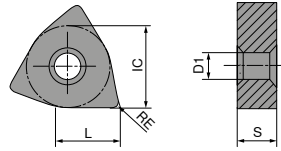

WNMG

ISO	RE mm
060404EN	0,4
060408EN	0,8
080404EN	0,4
080408EN	0,8

P	●	●
M	○	○
K	○	○
N		
S		
H		
O		

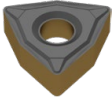
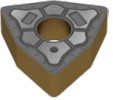
NEW	NEW
-CF20 CTEP110-P	-TFQ CTEP110-P
DRAGONSKIN	DRAGONSKIN
○ ○ ○	○ ○ ○
	
F CERMET WNMG	F CERMET WNMG
76 171 ...	76 177 ...
00401	
00601	00601
01801	01601
	01801

CCGT / CCMT

Designation	L mm	S mm	D1 mm	IC mm
CC.T 0602..	6,4	2,38	2,8	6,35
CC.T 09T3..	9,7	3,97	4,4	9,52
CC.T 1204..	12,9	4,76	5,5	12,70

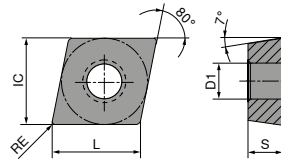

CCGT / CCMT

ISO	RE mm
060202EN	0,2
060204EN	0,4
09T302EN	0,2
09T304EN	0,4
09T308EN	0,8
120404EN	0,4
P	
M	
K	
N	
S	
H	
O	

NEW	NEW
-CF05 CTEP110-P	-CF55 CTEP110-P
DRAGONSKIN	DRAGONSKIN
F CERMET CCGT	F CERMET CCMT
76 247 ...	76 248 ...
00201	
00401	00401
01401	
01601	01601
01801	01801
02001	02801
●	●
○	○
○	○

DCGT / DCMT

Designation	L mm	S mm	D1 mm	IC mm
DC.T 0702..	7,75	2,38	2,8	6,35
DC.T 11T3..	11,60	3,97	4,4	9,52

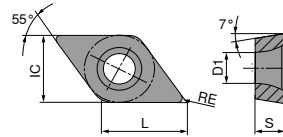

DCGT / DCMT

ISO	RE mm
070201EN	0,1
070202EN	0,2
070204EN	0,4
11T302EN	0,2
11T304EN	0,4
11T308EN	0,8

P	●	●
M	○	○
K	○	○
N		
S		
H		
O		

NEW

-CF05
CTEP110-P

DRAGONSKIN

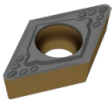
F
CERMET
DCGT

76 245 ...

NEW

-CF55
CTEP110-P

DRAGONSKIN

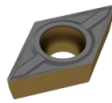
F
CERMET
DCMT

76 246 ...

00101	
00201	00201
00401	00401
01401	
01601	01601
01801	01801

SCGT / SCMT

Designation	L mm	S mm	D1 mm	IC mm
SC.T 09T3..	9,52	3,97	4,4	9,52

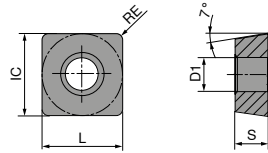

SCGT / SCMT

NEW	NEW
-CF05 CTEP110-P	-CF55 CTEP110-P
DRAGONSKIN	DRAGONSKIN
F CERMET SCGT	F CERMET SCMT
76 261 ...	76 260 ...
00401	00401
00601	00601

ISO	RE mm
09T304EN	0,4
09T308EN	0,8

P	●	●
M	○	○
K	○	○
N		
S		
H		
O		

TCGT / TCMT

Designation	L mm	S mm	D1 mm	IC mm
TC.T 1102..	11,0	2,38	2,8	6,35
TC.T 16T3..	16,5	3,97	4,4	9,52

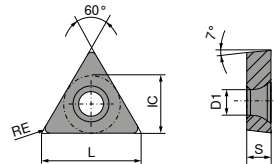

TCGT / TCMT

ISO	RE mm	76 272 ...	76 266 ...
110202EN	0,2	01401	
110204EN	0,4	01601	01601
110208EN	0,8	01801	
16T304EN	0,4	02801	
16T308EN	0,8		03001
P		●	●
M		○	○
K		○	○
N			
S			
H			
O			

NEW

-CF05
CTEP110-P

DRAGONSKIN

F
CERMET
TCGT

76 272 ...

NEW

-CF55
CTEP110-P

DRAGONSKIN

F
CERMET
TCMT

76 266 ...

VC GT / VC MT

Designation	L mm	S mm	D1 mm	IC mm
VC.T 1103..	11,1	3,18	2,9	6,35
VC.T 1604..	16,6	4,76	4,4	9,52

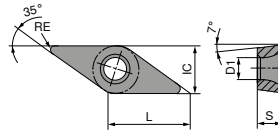

VC GT / VC MT

ISO	RE mm	76 276 ...	76 292 ...
110301EN	0,1	01201	
110302EN	0,2	01401	
110304EN	0,4	01601	01601
160404EN	0,4	02801	02801
160408EN	0,8	03001	03001
P		●	●
M		○	○
K		○	○
N			
S			
H			
O			

NEW

-CF05
CTEP110-P

DRAGONSKIN

F
CERMET
VC GT

76 276 ...

NEW

-CF55
CTEP110-P

DRAGONSKIN

F
CERMET
VC MT

76 292 ...

RCMT

Designation	S mm	D1 mm	IC mm
RCMT 0803..	3,18	3,4	8

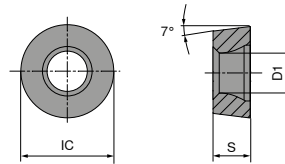

RCMT

NEW

-M23
CTCP115-P

DRAGONSKIN



M
RCMT

74 121 ...

ISO	RE mm
0803M0SN	4

21300

P	●
M	○
K	○
N	
S	
H	
O	

TCGT

Designation	L mm	S mm	D1 mm	IC mm
TCGT 16T3..	16,5	3,97	4,4	9,52

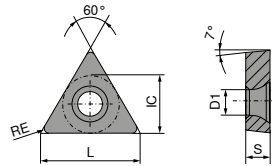

TCGT

-27
CTPX715

DRAGONSKIN



M
TCGT

70 276 ...

ISO	RE mm
16T302FN	0,2

72600

P	●
M	●
K	○
N	●
S	●
H	
O	○

VCGT

Designation	L mm	S mm	D1 mm	IC mm
VCGT 1604..	16,6	4,76	4,4	9,52

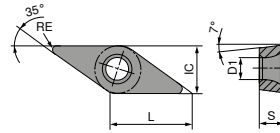

VCGT

-25P CTPX710	-27 CTPX715
DRAGONSKIN	DRAGONSKIN
M VCGT	M VCGT
70 282 ...	70 280 ...
72600	72600
	73200







ISO	RE mm
160402FN	0,2
160412FN	1,2





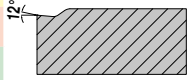

P	●	●
M	●	●
K		○
N	●	●
S	●	●
H		
O		○

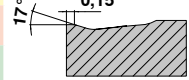
				CTEP110-P				
				DRAGONSKIN	CTCP115-P	CTPX710-25P	CTPX715-27	
				DRAGONSKIN	DRAGONSKIN			
	Material sub-group	Index	Tensile strength N/mm ² / HB / HRC					
P	Unalloyed steel	P.1.1	420 N/mm ² / 125 HB	500	P.1.1	370	340	275
		P.1.2	640 N/mm ² / 190 HB	440	P.1.2	315	300	235
		P.1.3	840 N/mm ² / 250 HB	380	P.1.3	270	260	200
		P.1.4	910 N/mm ² / 270 HB	360	P.1.4	250	250	190
		P.1.5	1010 N/mm ² / 300 HB	330	P.1.5	230	235	170
	Low-alloy steel	P.2.1	610 N/mm ² / 180 HB	450	P.2.1	325	300	240
		P.2.2	930 N/mm ² / 275 HB	360	P.2.2	250	250	185
		P.2.3	1010 N/mm ² / 300 HB	330	P.2.3	230	235	170
		P.2.4	1200 N/mm ² / 375 HB	250	P.2.4	170	190	125
	High-alloy steel and high-alloy tool steel	P.3.1	680 N/mm ² / 200 HB	380	P.3.1	200	150	140
		P.3.2	1100 N/mm ² / 300 HB	310	P.3.2	140	95	80
		P.3.3	1300 N/mm ² / 400 HB	230	P.3.3	85	35	25
	Stainless steel	P.4.1	680 N/mm ² / 200 HB	380	P.4.1	200	155	140
		P.4.2	1010 N/mm ² / 300 HB	340	P.4.2	170	130	110
M	Stainless steel	M.1.1	610 N/mm ² / 180 HB	380	M.1.1		150	140
		M.2.1	300 HB		M.2.1		90	80
		M.3.1	780 N/mm ² / 230 HB		M.3.1		130	120
K	Grey cast iron	K.1.1	350 N/mm ² / 180 HB	450	K.1.1	255		200
		K.1.2	500 N/mm ² / 260 HB	340	K.1.2	235		160
	Spherulitic graphite cast iron	K.2.1	540 N/mm ² / 160 HB	480	K.2.1	270		190
		K.2.2	845 N/mm ² / 250 HB	380	K.2.2	205		150
	Malleable iron	K.3.1	440 N/mm ² / 130 HB	460	K.3.1	250		210
		K.3.2	780 N/mm ² / 230 HB	280	K.3.2	210		180
N	Aluminium wrought alloy	N.1.1	60 HB		N.1.1		1840	1750
		N.1.2	340 N/mm ² / 100 HB		N.1.2		1600	1500
	Cast aluminium alloy	N.2.1	250 N/mm ² / 75 HB		N.2.1		1250	1200
		N.2.2	300 N/mm ² / 90 HB		N.2.2		1250	1200
		N.2.3	440 N/mm ² / 130 HB		N.2.3		750	700
	Copper and copper alloys (bronze/brass)	N.3.1	375 N/mm ² / 110 HB		N.3.1		650	625
		N.3.2	300 N/mm ² / 90 HB		N.3.2		630	600
Magnesium alloys	N.3.3	340 N/mm ² / 100 HB		N.3.3		500	475	
	N.4.1	70 HB		N.4.1		340	325	
S	Heat-resistant alloys	S.1.1	680 N/mm ² / 200 HB		S.1.1		110	40
		S.1.2	950 N/mm ² / 280 HB		S.1.2		85	30
		S.2.1	840 N/mm ² / 250 HB		S.2.1		75	30
		S.2.2	1180 N/mm ² / 350 HB		S.2.2		45	25
		S.2.3	1080 N/mm ² / 320 HB		S.2.3		45	20
	Titanium alloys	S.3.1	400 N/mm ²		S.3.1		100	110
		S.3.2	1050 N/mm ² / 320 HB		S.3.2		60	70
S.3.3	1400 N/mm ² / 410 HB		S.3.3		45	50		
H	Hardened steel	H.1.1	46–55 HRC		H.1.1			
		H.1.2	56–60 HRC		H.1.2			
		H.1.3	61–65 HRC		H.1.3			
		H.1.4	66–70 HRC		H.1.4			
	Chilled iron	H.2.1	400 HB		H.2.1			
Hardened cast iron	H.3.1	55 HRC		H.3.1				
O	Non-metal materials	O.1.1	≤ 150 N/mm ²		O.1.1			140
		O.1.2	≤ 100 N/mm ²		O.1.2			
		O.2.1	≤ 1000 N/mm ²		O.2.1			150
		O.2.2	≤ 1000 N/mm ²		O.2.2			
		O.3.1			O.3.1			



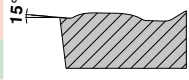

* Tensile strength

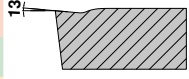



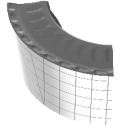

Standard chip breakers / application notes

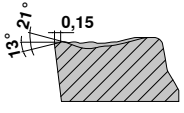
Negative		Model	Smooth cut	Irregular cutting depth	Interrupted cut	Sectional illustration		Geometry	
						a _p mm	f mm		
Main application steel and cast iron, secondary application stainless steels	-CF / -CF20	 F	CTEP110-P / TCM10			 12°	0,30–1,50	0,07–0,25	CN.. DN.. TN.. WN..
	<ul style="list-style-type: none"> ▲ Fine finishing ▲ Sharp cutting edge for low cutting forces ▲ Good chip control even at small depths of cut 		CTEP110-P / TCM10						
Main application steel and cast iron, secondary application stainless steels	-TFQ	 F	CTEP110-P / CTCP115-P	CTCP115-P / CTCP125-P		 17° 0,15	0,50–5,00	0,10–0,60	CN.. DN.. WN..
	<ul style="list-style-type: none"> ▲ Wiper geometry ▲ Finishing to medium machining ▲ Very high feeds ▲ High surface quality 		CTEP110-P	CTCP115-P / CTCP125-P					

Positive		Model	Smooth cut	Irregular cutting depth	Interrupted cut	Sectional illustration		Geometry	
						a _p mm	f mm		
Main application steel and cast iron, secondary application stainless steels and super alloys	-CF05	 F	CTEP110-P / TCM407	TCM10 / TCM407		 15°	0,20–1,30	0,06–0,25	CC.. DC.. SC.. TC.. VC..
	<ul style="list-style-type: none"> ▲ Fine finishing ▲ For all common steel materials, stainless steels and GGG ▲ Good swarf control ▲ High surface quality 		CTEP110-P	TCM10 / TCM407					
Main application steel and cast iron, secondary application stainless steels and super alloys	-CF55	 F M	CTEP110-P	TCM10 / CTEP110-P		 13°	0,20–1,30	0,06–0,25	CC.. DC.. SC.. TC.. VC..
	<ul style="list-style-type: none"> ▲ Finishing to medium machining ▲ Suitable for general and stainless steels ▲ Low cutting forces ▲ Good swarf control ▲ High surface quality 		CTEP110-P	CTEP110-P					

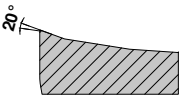
Standard chip breakers / application notes

Positive		Model	Smooth cut	Irregular cutting depth	Interrupted cut	Sectional illustration		Geometry
						a _p mm	f mm	
Main application steel and cast iron, secondary application stainless steels and super alloys	-M23	  	CTCP115-P / CTCP125-P	CTCP125-P	CTCP125-P		RC..	
	▲ Soft cutting geometry with outstanding chip breaking behaviour at low cutting depths in finish machining		CTCP115-P / CTCP125-P	CTCP125-P	CTCP125-P			
					0,30–4,0	1,0–0,45		

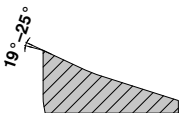
Positive									
Main application non-ferrous metals, secondary application stainless steels, steels, super alloys, cast iron	-25P	 	CTPX710	CTPX710			CC.. DC.. SC.. VC..		
	▲ Sharp cutting edge		CTPX710	CTPX710					
	▲ Good swarf control on soft aluminium alloys		CTPX710 / H216T	CTPX710 / H216T	CTPX710 / H216T				
	▲ Low adhesion		CTPX710	CTPX710					
					0,50–4,50	0,05–0,60			
Main application non-ferrous metals, secondary application stainless steels, steels, super alloys, cast iron	-27	  	CTPX715	CTPX715			CC.. DC.. RC.. SC.. TC.. VC..		
	▲ The universal Alu geometry		CTPX715	CTPX715					
	▲ Sharp cutting edge		CTPX715 / H216T	CTPX715 / H216T					
	▲ Extremely positive rake angle		CTPX715 / H216T	CTPX715 / H216T	CTPX715 / H216T				
	▲ Low adhesion		CTPX715	CTPX715					
	▲ High feed rates								
					1,00–10,00	0,10–0,75			

Grade description

CTEP110-P

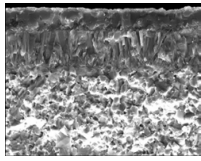

ISO | P10 | M10 | K05

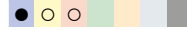

Specifications:

Composition: Co/Ni 12.2%; additives 26.4%; Ti(C,N) balance | Grain size: 0.8-1.0 μm | Hardness: HV₃₀ 1650 | Layer system: CVD TiCN-Al₂O₃ + TiN cover layer

Recommended use:

Coated cermet grade with reserves of toughness for finish machining at high cutting speeds.

CTCP115-P

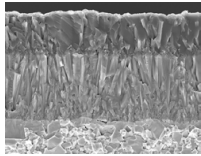

ISO | P15 | K25

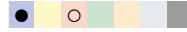

Specification:

Composition: Co 5.5%; mixed carbides 6.4%; WC balance | Grain size: 1 μm | Hardness: HV₃₀ 1530 | Layer system: CVD TiCN-Al₂O₃

Usage recommendation:

The wear-resistant high-performance grade for steel machining with stable conditions and a continuous cut.

CTPX710

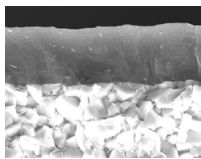

ISO | P10 | M10 | K10 | N10 | S15



Specification:

Composition: Co 6.0%; WC balance | Grain size: 0.8 μm | Hardness: HV₃₀ 1820 | Layer system: PVD AlTiN

Usage recommendation:

The universal carbide grade for the most demanding machining requirements on multiple materials.

CTPX715

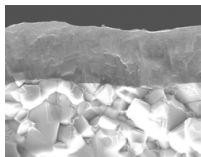

ISO | P15 | M15 | K15 | N15 | S20 | O10



Specification:

Composition: Co 6.0%; WC balance | Grain size: 1 μm | Hardness: HV₃₀ 1650 | Layer system: PVD AlTiN

Usage recommendation:

The universal carbide grade for the most demanding machining requirements on multiple materials.

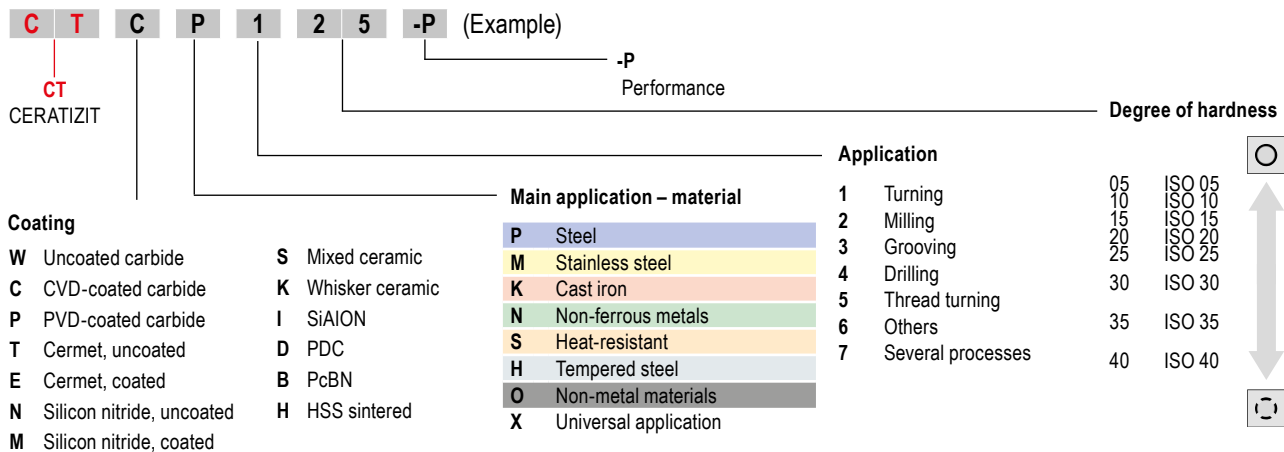

Insert GX 35

▲ For parting and grooving

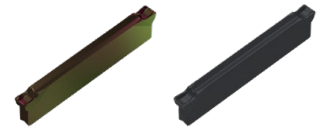
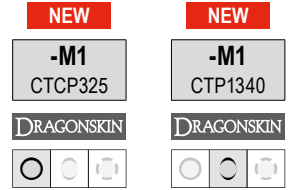
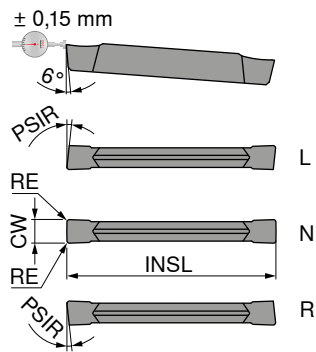
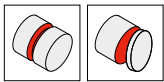

Designation	IH	INSL mm	CW $\pm 0,15$ mm	RE $\pm 0,15$ mm	PSIR °	for tool holder
GX 35-E3.00 L 6	L	35	3	0,2	6	-GX35
GX 35-E3.00 N 0.20	N	35	3	0,2		-GX35
GX 35-E3.00 R 6	R	35	3	0,2	6	-GX35

70 390 ...	70 390 ...
92300	62300
93300	63300
94300	64300

P	●	●
M	○	●
K	●	●
N		○
S	○	●
H		
O		○

→ v_c Page 33

 **Note:** reduce feed rate by 20–50 % with R/L version!
→ Page 33

MonoClamp – Radial Monoholder GX-DC 35

Scope of supply:

Mono holder incl. key and clamping screw

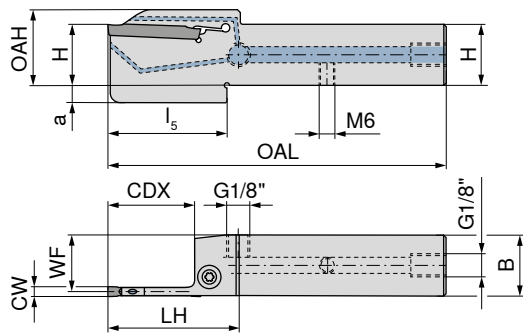

Illustrations show right-hand versions

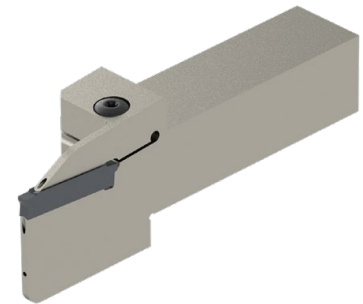

NEW

Left-hand

NEW

Right-hand

70 869 ...

70 869 ...

ISO designation	H mm	B mm	CW mm	WF mm	OAH mm	OAL mm	LH mm	l ₅ mm	CDX mm	a mm	for grooving inserts	70 869 ...	70 869 ...
E20 R/L 0034S3-2020X-S-DC-GX35	20	20	3	18,75	31	117	55	48	34	10	GX 35-E3.00	32001	32000
E25 R/L 0034S3-2525X-S-DC-GX35	25	25	3	23,75	36	132	55	48	34	10	GX 35-E3.00	32501	32500

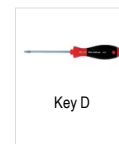

Key D

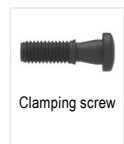

Clamping screw

80 950 ...

70 950 ...

Spare parts
for grooving inserts
GX 35-E3.00

T20 - IP

129

M6x22 - 20IP

92200



→ Chapter 16 Adapters and accessories
Here you will find the suitable base adaptors.

Material examples for cutting data tables

	Material sub-group	Index	Composition / Structure / Heat treatment	Tensile strength N/mm ² / HB / HRC	Material number	Material designation	Material number	Material designation
P	Unalloyed steel	P.1.1	< 0,15 % C Annealed	420 N/mm ² / 125 HB	1.0401	C15	1.1141	Ck15
		P.1.2	< 0,45 % C Annealed	640 N/mm ² / 190 HB	1.1191	C45E	1.0718	9SMnPb28
		P.1.3	< 0,45 % C Tempered	840 N/mm ² / 250 HB	1.1191	C45E	1.0535	C55
		P.1.4	< 0,75 % C Annealed	910 N/mm ² / 270 HB	1.1223	C60R	1.0535	C55
		P.1.5	< 0,75 % C Tempered	1010 N/mm ² / 300 HB	1.1223	C60R	1.0727	45S20
	Low-alloy steel	P.2.1	Annealed	610 N/mm ² / 180 HB	1.7131	16MnCr5	1.6587	17CrNiMo6
		P.2.2	Tempered	930 N/mm ² / 275 HB	1.7131	16MnCr5	1.6587	17CrNiMo6
		P.2.3	Tempered	1010 N/mm ² / 300 HB	1.7225	42CrMo4	1.3505	100Cr6
		P.2.4	Tempered	1200 N/mm ² / 375 HB	1.7225	42CrMo4	1.3505	100Cr6
	High-alloy steel and high-alloy tool steel	P.3.1	Annealed	680 N/mm ² / 200 HB	1.4021	X20Cr13	1.4034	X46Cr13
		P.3.2	Hardened and tempered	1100 N/mm ² / 300 HB	1.2343	X38CrMoV5-1	1.4034	X46Cr13
		P.3.3	Hardened and tempered	1300 N/mm ² / 400 HB	1.2343	X38CrMoV5-1	1.4034	X46Cr13
	Stainless steel	P.4.1	Ferritic / martensitic Annealed	680 N/mm ² / 200 HB	1.4016	X6Cr17	1.2316	X36CrMo16
		P.4.2	Martensitic Tempered	1010 N/mm ² / 300 HB	1.4112	X90CrMoV18	1.2316	X36CrMo16
M	Stainless steel	M.1.1	Austenitic / austenitic-ferritic Quenched	610 N/mm ² / 180 HB	1.4301	X5CrNi18-10	1.4571	X6CrNiMoTi17-12-2
		M.2.1	Austenitic Tempered	300 HB	1.4841	X15CrNiSi25-21	1.4539	X1NiCrMoCu25-20-5
		M.3.1	Austenitic / ferritic (Duplex)	780 N/mm ² / 230 HB	1.4462	X2CrNiMoN22-5-3	1.4501	X2CrNiMoCuWN25-7-4
K	Grey cast iron	K.1.1	Pearlitic / ferritic	350 N/mm ² / 180 HB	0.6010	GG-10	0.6025	GG-25
		K.1.2	Pearlitic (martensitic)	500 N/mm ² / 260 HB	0.6030	GG-30	0.6045	GG-45
	Spherulitic graphite cast iron	K.2.1	Ferritic	540 N/mm ² / 160 HB	0.7040	GGG-40	0.7060	GGG-60
		K.2.2	Pearlitic	845 N/mm ² / 250 HB	0.7070	GGG-70	0.7080	GGG-80
	Malleable iron	K.3.1	Ferritic	440 N/mm ² / 130 HB	0.8035	GTW-35-04	0.8045	GTW-45
		K.3.2	Pearlitic	780 N/mm ² / 230 HB	0.8165	GTS-65-02	0.8170	GTS-70-02
N	Aluminium wrought alloy	N.1.1	Non-hardenable	60 HB	3.0255	Al99,5	3.3315	AlMg1
		N.1.2	Hardenable Age-hardened	340 N/mm ² / 100 HB	3.1355	AlCuMg2	3.2315	AlMgSi1
	Cast aluminium alloy	N.2.1	≤ 12 % Si, non-hardenable	250 N/mm ² / 75 HB	3.2581	G-AlSi12	3.2163	G-AlSi9Cu3
		N.2.2	≤ 12 % Si, hardenable Age-hardened	300 N/mm ² / 90 HB	3.2134	G-AlSi5Cu1Mg	3.2373	G-AlSi9Mg
		N.2.3	> 12 % Si, non-hardenable	440 N/mm ² / 130 HB		G-AlSi17Cu4Mg		G-AlSi18CuNiMg
	Copper and copper alloys (bronze/brass)	N.3.1	Free-machining alloys, PB > 1 %	375 N/mm ² / 110 HB	2.0380	CuZn39Pb2 (Ms58)	2.0410	CuZn44Pb2
		N.3.2	CuZn, CuSnZn	300 N/mm ² / 90 HB	2.0331	CuZn15	2.4070	CuZn28Sn1As
		N.3.3	CuSn, lead-free copper and electrolytic copper	340 N/mm ² / 100 HB	2.0060	E-Cu57	2.0590	CuZn40Fe
	Magnesium alloys	N.4.1	Magnesium and magnesium alloys	70 HB	3.5612	MgAl6Zn	3.5312	MgAl3Zn
	S	Heat-resistant alloys	S.1.1	Fe - basis Annealed	680 N/mm ² / 200 HB	1.4864	X12NiCrSi 36-16	1.4865
S.1.2			Fe - basis Age-hardened	950 N/mm ² / 280 HB	1.4980	X6NiCrTiMoVB25-15-2	1.4876	X10NiCrAlTi32-20
S.2.1			Ni or Co basis Annealed	840 N/mm ² / 250 HB	2.4631	NiCr20TiAl (Nimonic80A)	3.4856	NiCr22Mo9Nb
S.2.2			Ni or Co basis Age-hardened	1180 N/mm ² / 350 HB	2.4668	NiCr19Nb5Mo3 (Inconel 718)	2.4955	NiFe25Cr20NbTi
S.2.3			Ni or Co basis Cast	1080 N/mm ² / 320 HB	2.4765	CoCr20W15Ni	1.3401	G-X120Mn12
Titanium alloys		S.3.1	Pure titanium	400 N/mm ²	3.7025	Ti99,8	3.7034	Ti99,7
		S.3.2	Alpha + beta alloys Age-hardened	1050 N/mm ² / 320 HB	3.7165	TiAl6V4	Ti-6246	Ti-6Al-2Sn-4Zr-6Mo
S.3.3	Beta alloys	1400 N/mm ² / 410 HB	Ti555.3	Ti-5Al-5V-5Mo-3Cr	R56410	Ti-10V-2Fe-3Al		
H	Hardened steel	H.1.1	Hardened and tempered	46–55 HRC				
		H.1.2	Hardened and tempered	56–60 HRC				
		H.1.3	Hardened and tempered	61–65 HRC				
		H.1.4	Hardened and tempered	66–70 HRC				
	Chilled iron	H.2.1	Cast	400 HB				
Hardened cast iron	H.3.1	Hardened and tempered	55 HRC					
O	Non-metal materials	O.1.1	Plastics, duroplastic	≤ 150 N/mm ²				
		O.1.2	Plastics, thermoplastic	≤ 100 N/mm ²				
		O.2.1	Aramid fibre-reinforced	≤ 1000 N/mm ²				
		O.2.2	Glass/carbon-fibre reinforced	≤ 1000 N/mm ²				
		O.3.1	Graphite					

* Tensile strength

Cutting data values for grooving inserts

Index	GX	
	CTCP325	CTP1340
	DRAGONSKIN	
	v_c (m/min)	
P.1.1	220	180
P.1.2	195	150
P.1.3	170	125
P.1.4	165	115
P.1.5	150	100
P.2.1	200	155
P.2.2	160	110
P.2.3	150	100
P.2.4	120	70
P.3.1	150	110
P.3.2	95	75
P.3.3	45	40
P.4.1	150	110
P.4.2	125	95
M.1.1	150	110
M.2.1	95	80
M.3.1	135	100
K.1.1	170	150
K.1.2	150	125
K.2.1	160	140
K.2.2	145	120
K.3.1	210	170
K.3.2	140	120
N.1.1		300
N.1.2		200
N.2.1		300
N.2.2		200
N.2.3		150
N.3.1		300
N.3.2		300
N.3.3		200
N.4.1		200
S.1.1	35	35
S.1.2	30	30
S.2.1	20	20
S.2.2	15	15
S.2.3	15	15
S.3.1		85
S.3.2		40
S.3.3		30
H.1.1		
H.1.2		
H.1.3		
H.1.4		
H.2.1		
H.3.1		
O.1.1		130
O.1.2		
O.2.1		105
O.2.2		
O.3.1		

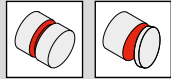
GX-M1	
Groove width CW (mm)	
	Parting / Grooving
	Feed rate f (mm/rev.)
3	0,10–0,20

References for Parting off

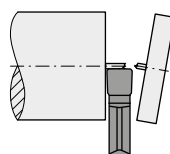

From \varnothing 5 mm on, reduce feed “f” by approx. 50 %. No parting across centre (risk of breakage).

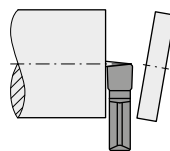

For parting pip-free, use R or L inserts. In order to minimize lateral deflection reduce feed by approx. 20–50 %.

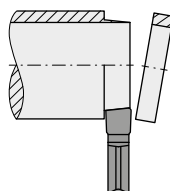

In order to prevent ring formation, use R or L inserts. Reduce feed “f” because of lateral deflection by approx. 20–50 %.

References for grooving

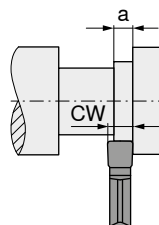

When grooving with an axial displacement the width „a” should amount to at least 70 % of the grooving width „CW”.

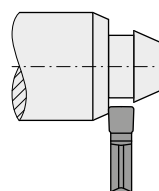

When grooving oblique surfaces the feed should be reduced by approx. 20–50 % until fully engaged.



The cutting data is strongly influenced by external conditions, such as the stability of the tool and workpiece clamping, material and type of machine. The specified values represent guideline cutting data that can be adjusted by approx. $\pm 20\%$ according to the usage conditions.

AluLine – Micro-end milling cutter

The specialist for machining non-ferrous metals

▲ T_x = maximum engagement depth

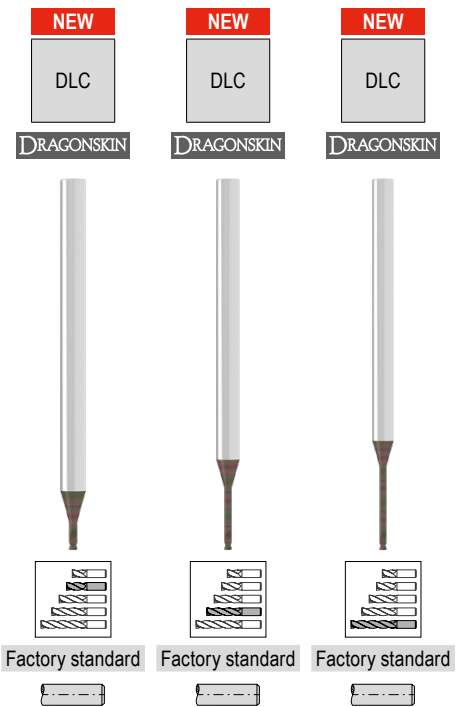
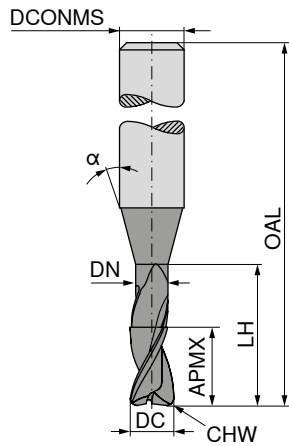
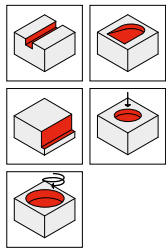
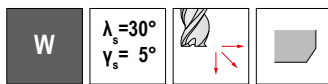

53 900 ...	53 900 ...	53 900 ...
02101		
02201		
	02301	
	02401	
03101		
03201		
	03301	
	03401	
04101		
04201		
	04301	
	04401	
05101		
05100		
05201		
05200		
	05300	
	05301	
	05400	
	05401	
06101		
06201		
	06301	
	06401	
08101		
08201		
	08301	
	08401	
10101		
10100		
10200		
10201		
	10300	
	10301	
	10400	
	10401	
		10500
		10501
12101		
12201		
	12301	
	12401	

DC _{0,01}	APMX	DN	LH	OAL	LPR	α°	DCONMS _{ns}	T_x	CHW	ZEPF
mm	mm	mm	mm	mm	mm		mm		mm	
0,2	0,2	0,18	0,6	45	17	15	4	3 x DC	0,02	2
0,2	0,2	0,18	1,0	45	17	15	4	5 x DC	0,02	2
0,2	0,2	0,18	1,6	45	17	15	4	8 x DC	0,02	2
0,2	0,2	0,18	2,0	50	22	15	4	10 x DC	0,02	2
0,3	0,3	0,28	0,9	45	17	15	4	3 x DC	0,03	2
0,3	0,3	0,28	1,5	45	17	15	4	5 x DC	0,03	2
0,3	0,3	0,28	2,4	50	22	15	4	8 x DC	0,03	2
0,3	0,3	0,28	3,0	50	22	15	4	10 x DC	0,03	2
0,4	0,4	0,37	1,2	45	17	15	4	3 x DC	0,04	2
0,4	0,4	0,37	2,0	45	17	15	4	5 x DC	0,04	2
0,4	0,4	0,37	3,2	50	22	15	4	8 x DC	0,04	2
0,4	0,4	0,37	4,0	50	22	15	4	10 x DC	0,04	2
0,5	0,5	0,45	1,5	45	17	15	4	3 x DC	0,05	2
0,5	0,5	0,45	1,5	45	17	15	3	3 x DC	0,05	2
0,5	0,5	0,45	2,5	45	17	15	4	5 x DC	0,05	2
0,5	0,5	0,45	2,5	45	17	15	3	5 x DC	0,05	2
0,5	0,5	0,45	4,0	45	17	15	3	8 x DC	0,05	2
0,5	0,5	0,45	4,0	50	22	15	4	8 x DC	0,05	2
0,5	0,5	0,45	5,0	50	22	15	3	10 x DC	0,05	2
0,5	0,5	0,45	5,0	50	22	15	4	10 x DC	0,05	2
0,6	0,6	0,58	2,0	45	17	15	4	3,3 x DC	0,06	2
0,6	0,6	0,58	3,0	50	22	15	4	5 x DC	0,06	2
0,6	0,6	0,58	5,0	50	22	15	4	8,3 x DC	0,06	2
0,6	0,6	0,58	6,0	50	22	15	4	10 x DC	0,06	2
0,8	0,8	0,77	2,5	45	17	15	4	3,1 x DC	0,08	2
0,8	0,8	0,77	4,0	50	22	15	4	5 x DC	0,08	2
0,8	0,8	0,77	6,5	50	22	15	4	8,1 x DC	0,08	2
0,8	0,8	0,77	8,0	50	22	15	4	10 x DC	0,08	2
1,0	1,0	0,95	3,0	45	17	15	4	3 x DC	0,10	2
1,0	1,0	0,95	3,0	45	17	15	3	3 x DC	0,10	2
1,0	1,0	0,95	5,0	45	17	15	3	5 x DC	0,10	2
1,0	1,0	0,95	5,0	50	22	15	4	5 x DC	0,10	2
1,0	1,0	0,95	8,0	50	22	15	3	8 x DC	0,10	2
1,0	1,0	0,95	8,0	50	22	15	4	8 x DC	0,10	2
1,0	1,0	0,95	10,0	50	22	15	3	10 x DC	0,10	2
1,0	1,0	0,95	10,0	55	27	15	4	10 x DC	0,10	2
1,0	1,0	0,95	12,0	55	27	15	3	12 x DC	0,10	2
1,0	1,0	0,95	12,0	55	27	15	4	12 x DC	0,10	2
1,2	1,2	1,15	3,0	45	17	15	4	2,5 x DC	0,10	2
1,2	1,2	1,15	6,0	50	22	15	4	5 x DC	0,10	2
1,2	1,2	1,15	10,0	55	27	15	4	8,3 x DC	0,10	2
1,2	1,2	1,15	12,0	55	27	15	4	10 x DC	0,10	2

P			
M			
K			
N		•	•
S			
H			
O			

AluLine – Micro-end milling cutter

The specialist for machining non-ferrous metals

▲ T_x = maximum engagement depth

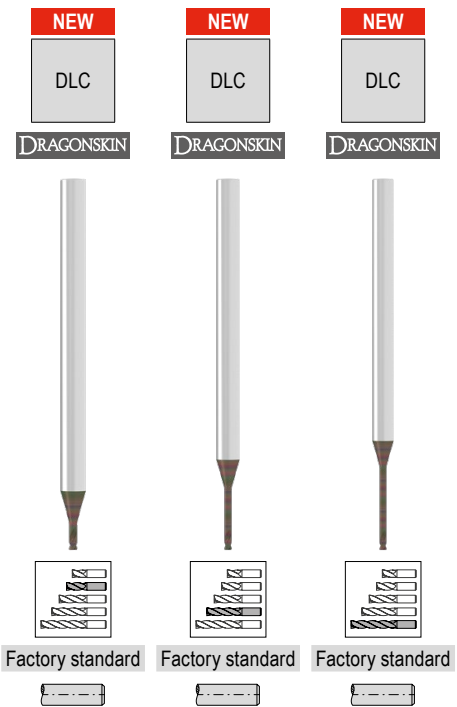
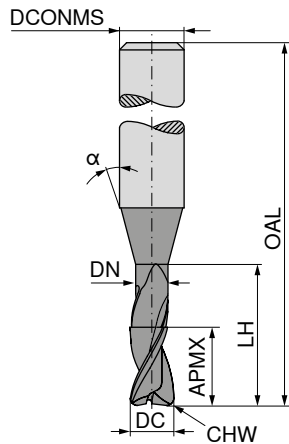
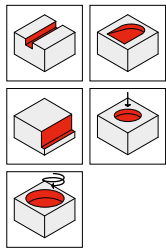
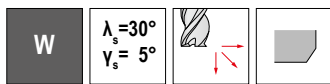

DC _{0,01}	APMX	DN	LH	OAL	LPR	α°	DCONMS _{ns}	T _x	CHW	ZEPF
mm	mm	mm	mm	mm	mm		mm		mm	
1,3	1,3	1,25	4,0	45	17	15	4	3,1 x DC	0,10	2
1,3	1,3	1,25	7,0	50	22	15	4	5,4 x DC	0,10	2
1,3	1,3	1,25	11,0	55	27	15	4	8,5 x DC	0,10	2
1,3	1,3	1,25	13,0	55	27	15	4	10 x DC	0,10	2
1,5	1,5	1,44	5,0	50	22	15	4	3,3 x DC	0,10	2
1,5	1,5	1,44	5,0	45	17	15	3	3,3 x DC	0,10	2
1,5	1,5	1,44	7,5	50	22	15	3	5 x DC	0,10	2
1,5	1,5	1,44	7,5	50	22	15	4	5 x DC	0,10	2
1,5	1,5	1,44	12,0	55	27	15	3	8 x DC	0,10	2
1,5	1,5	1,44	12,0	55	27	15	4	8 x DC	0,10	2
1,5	1,5	1,44	15,0	55	27	15	3	10 x DC	0,10	2
1,5	1,5	1,44	15,0	60	32	15	4	10 x DC	0,10	2
1,6	1,6	1,52	5,0	50	22	15	4	3,1 x DC	0,10	2
1,6	1,6	1,52	8,0	50	22	15	4	5 x DC	0,10	2
1,6	1,6	1,52	13,0	55	27	15	4	8,1 x DC	0,10	2
1,6	1,6	1,52	16,0	60	32	15	4	10 x DC	0,10	2
1,8	1,8	1,72	5,5	50	22	15	4	3,1 x DC	0,10	2
1,8	1,8	1,72	9,0	50	22	15	4	5 x DC	0,10	2
1,8	1,8	1,72	14,5	55	27	15	4	8,1 x DC	0,10	2
1,8	1,8	1,72	18,0	60	32	15	4	10 x DC	0,10	2
2,0	2,0	1,92	6,0	50	22	15	4	3 x DC	0,10	2
2,0	2,0	1,92	6,0	45	17	15	3	3 x DC	0,10	2
2,0	2,0	1,92	10,0	50	22	15	4	5 x DC	0,10	2
2,0	2,0	1,92	10,0	50	22	15	3	5 x DC	0,10	2
2,0	2,0	1,92	14,0	55	27	15	3	7 x DC	0,10	2
2,0	2,0	1,92	14,0	55	27	15	4	7 x DC	0,10	2
2,0	2,0	1,92	16,0	55	27	15	3	8 x DC	0,10	2
2,0	2,0	1,92	16,0	60	32	15	4	8 x DC	0,10	2
2,0	2,0	1,92	20,0	60	32	15	3	10 x DC	0,10	2
2,0	2,0	1,92	20,0	60	32	15	4	10 x DC	0,10	2
2,3	2,3	2,22	7,0	50	22	15	4	3 x DC	0,10	2
2,3	2,3	2,22	11,5	55	27	15	4	5 x DC	0,10	2
2,3	2,3	2,22	18,5	60	32	15	4	8 x DC	0,10	2
2,3	2,3	2,22	20,0	60	32	15	4	8,7 x DC	0,10	2
2,3	2,3	2,22	23,0	65	37	15	4	10 x DC	0,10	2
3,0	3,0	2,90	9,0	50	22	15	4	3 x DC	0,10	2
3,0	3,0	2,90	15,0	55	27	15	4	5 x DC	0,10	2
3,0	3,0	2,90	24,0	65	37	15	4	8 x DC	0,10	2
3,0	3,0	2,90	30,0	70	42	15	4	10 x DC	0,10	2

53 900 ...	53 900 ...	53 900 ...
13101		
	13201	
	13301	
	13401	
15101		
15100		
15200		
15201		
	15300	
	15301	
	15400	
	15401	
16101		
16201		
	16301	
	16401	
18101		
18201		
	18301	
	18401	
20101		
20100		
20201		
20200		
	20300	
	20301	
	20400	
	20401	
	20500	
	20501	
23101		
23201		
	23301	
	23401	
	23501	
30101		
30201		
	30301	
	30401	

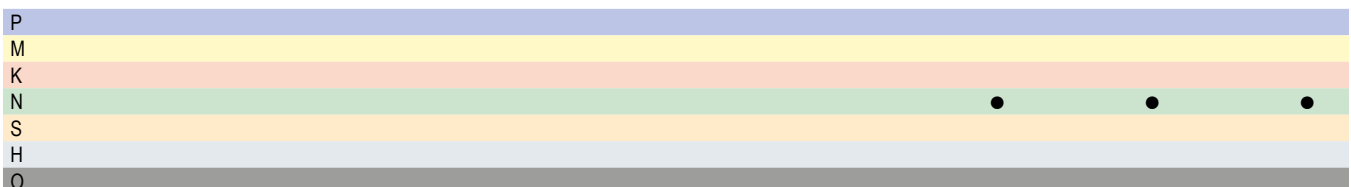

AluLine – Micro-ball nosed cutter

The specialist for machining non-ferrous metals

▲ Radius accuracy: ± 0,01 mm

▲ T_x = maximum engagement depth

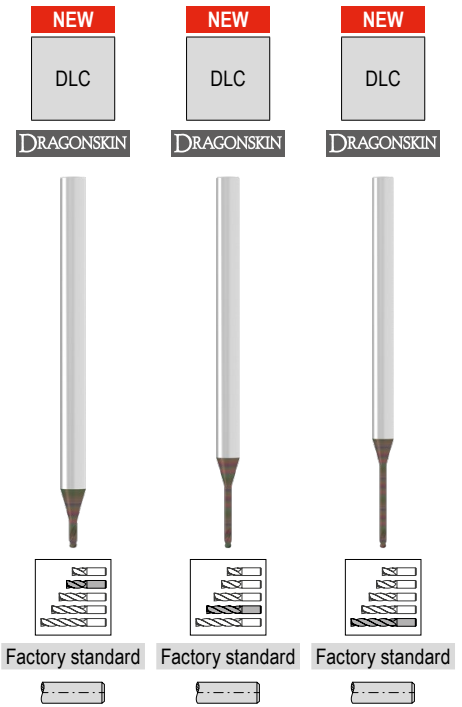
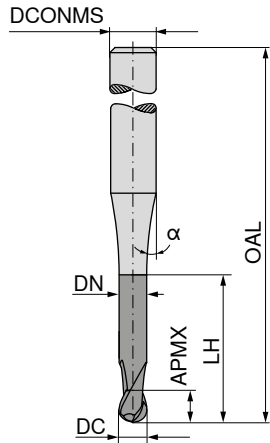
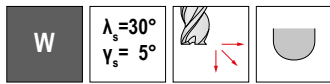

DC _{±0,01}	APMX	DN	LH	OAL	LPR	α°	DCONMS _{±5}	T _x	ZEFP
mm	mm	mm	mm	mm	mm		mm		
0,2	0,2	0,18	0,6	45	17	15	4	3 x DC	2
0,2	0,2	0,18	1,0	45	17	15	4	5 x DC	2
0,2	0,2	0,18	1,6	45	17	15	4	8 x DC	2
0,2	0,2	0,18	2,0	50	22	15	4	10 x DC	2
0,3	0,3	0,28	0,9	45	17	15	4	3 x DC	2
0,3	0,3	0,28	1,5	45	17	15	4	5 x DC	2
0,3	0,3	0,28	2,4	50	22	15	4	8 x DC	2
0,3	0,3	0,28	3,0	50	22	15	4	10 x DC	2
0,4	0,4	0,37	1,2	45	17	15	4	3 x DC	2
0,4	0,4	0,37	2,0	45	17	15	4	5 x DC	2
0,4	0,4	0,37	3,2	50	22	15	4	8 x DC	2
0,4	0,4	0,37	4,0	50	22	15	4	10 x DC	2
0,5	0,5	0,45	1,5	45	17	15	4	3 x DC	2
0,5	0,5	0,45	1,5	45	17	15	3	3 x DC	2
0,5	0,5	0,45	2,5	45	17	15	4	5 x DC	2
0,5	0,5	0,45	2,5	45	17	15	3	5 x DC	2
0,5	0,5	0,45	4,0	45	17	15	3	8 x DC	2
0,5	0,5	0,45	4,0	50	22	15	4	8 x DC	2
0,5	0,5	0,45	5,0	50	22	15	3	10 x DC	2
0,5	0,5	0,45	5,0	50	22	15	4	10 x DC	2
0,6	0,6	0,58	2,0	45	17	15	4	3,3 x DC	2
0,6	0,6	0,58	3,0	50	22	15	4	5 x DC	2
0,6	0,6	0,58	5,0	50	22	15	4	8,3 x DC	2
0,6	0,6	0,58	6,0	50	22	15	4	10 x DC	2
0,8	0,8	0,77	2,5	45	17	15	4	3,1 x DC	2
0,8	0,8	0,77	4,0	50	22	15	4	5 x DC	2
0,8	0,8	0,77	6,5	50	22	15	4	8,1 x DC	2
0,8	0,8	0,77	8,0	50	22	15	4	10 x DC	2
1,0	1,0	0,95	3,0	45	17	15	4	3 x DC	2
1,0	1,0	0,95	3,0	45	17	15	3	3 x DC	2
1,0	1,0	0,95	5,0	45	17	15	3	5 x DC	2
1,0	1,0	0,95	5,0	50	22	15	4	5 x DC	2
1,0	1,0	0,95	8,0	50	22	15	3	8 x DC	2
1,0	1,0	0,95	8,0	50	22	15	4	8 x DC	2
1,0	1,0	0,95	10,0	50	22	15	3	10 x DC	2
1,0	1,0	0,95	10,0	55	27	15	4	10 x DC	2
1,0	1,0	0,95	12,0	55	27	15	3	12 x DC	2
1,0	1,0	0,95	12,0	55	27	15	4	12 x DC	2
1,2	1,2	1,15	3,0	45	17	15	4	2,5 x DC	2
1,2	1,2	1,15	6,0	50	22	15	4	5 x DC	2
1,2	1,2	1,15	10,0	55	27	15	4	8,3 x DC	2

53 903 ...	53 903 ...	53 903 ...
02101		
02201		
	02301	
	02401	
03101		
03201		
	03301	
	03401	
04101		
04201		
	04301	
	04401	
05101		
05100		
05201		
05200		
	05300	
	05301	
	05400	
	05401	
06101		
06201		
	06301	
	06401	
08101		
08201		
	08301	
	08401	
10101		
10100		
10200		
10201		
	10300	
	10301	
	10400	
	10401	
		10500
		10501
12101		
12201		
	12301	

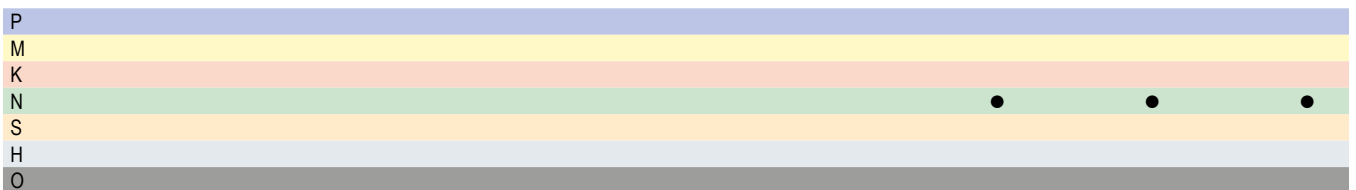

AluLine – Micro-ball nosed cutter

The specialist for machining non-ferrous metals

▲ Radius accuracy: ± 0,01 mm

▲ T_x = maximum engagement depth

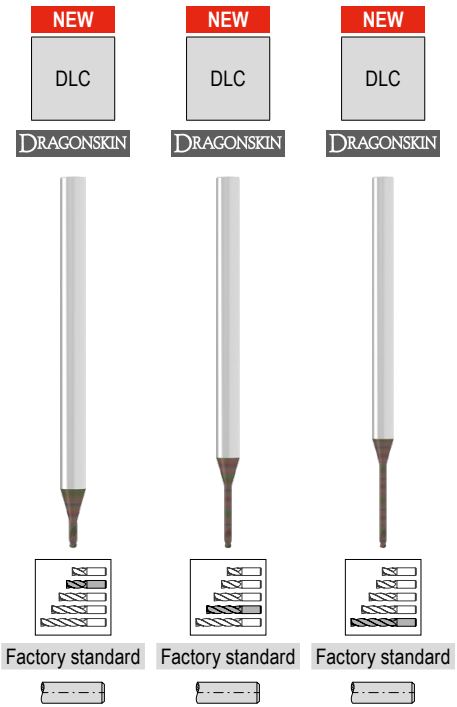
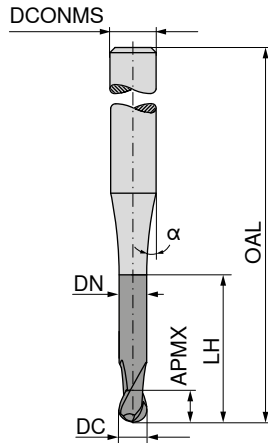
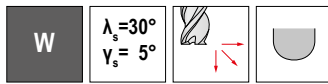

DC _{±0.01}	APMX	DN	LH	OAL	LPR	α°	DCONMS _{±0.05}	T _x	ZEFP	53 903 ...	53 903 ...	53 903 ...
mm	mm	mm	mm	mm	mm		mm					
1,2	1,2	1,15	12,0	55	27	15	4	10 x DC	2			
1,3	1,3	1,25	4,0	45	17	15	4	3,1 x DC	2			12401
1,3	1,3	1,25	7,0	50	22	15	4	5,4 x DC	2	13101		13201
1,3	1,3	1,25	11,0	55	27	15	4	8,5 x DC	2			13301
1,3	1,3	1,25	13,0	55	27	15	4	10 x DC	2			13401
1,5	1,5	1,44	5,0	50	22	15	4	3,3 x DC	2	15101		
1,5	1,5	1,44	5,0	45	17	15	3	3,3 x DC	2	15100		
1,5	1,5	1,44	7,5	50	22	15	3	5 x DC	2	15200		
1,5	1,5	1,44	7,5	50	22	15	4	5 x DC	2	15201		
1,5	1,5	1,44	12,0	55	27	15	3	8 x DC	2			15400
1,5	1,5	1,44	12,0	55	27	15	4	8 x DC	2			15401
1,5	1,5	1,44	15,0	55	27	15	3	10 x DC	2			15300
1,5	1,5	1,44	15,0	60	32	15	4	10 x DC	2			15301
1,6	1,6	1,52	5,0	50	22	15	4	3,1 x DC	2	16101		
1,6	1,6	1,52	8,0	50	22	15	4	5 x DC	2	16201		
1,6	1,6	1,52	13,0	55	27	15	4	8,1 x DC	2			16301
1,6	1,6	1,52	16,0	60	32	15	4	10 x DC	2			16401
1,8	1,8	1,72	5,5	50	22	15	4	3,1 x DC	2	18101		
1,8	1,8	1,72	9,0	50	22	15	4	5 x DC	2	18201		
1,8	1,8	1,72	14,5	55	27	15	4	8,1 x DC	2			18301
1,8	1,8	1,72	18,0	60	32	15	4	10 x DC	2			18401
2,0	2,0	1,92	6,0	50	22	15	4	3 x DC	2	20101		
2,0	2,0	1,92	6,0	45	17	15	3	3 x DC	2	20100		
2,0	2,0	1,92	10,0	50	22	15	4	5 x DC	2	20201		
2,0	2,0	1,92	10,0	50	22	15	3	5 x DC	2	20200		
2,0	2,0	1,92	14,0	55	27	15	3	7 x DC	2			20300
2,0	2,0	1,92	14,0	55	27	15	4	7 x DC	2			20301
2,0	2,0	1,92	16,0	55	27	15	3	8 x DC	2			20400
2,0	2,0	1,92	16,0	60	32	15	4	8 x DC	2			20401
2,0	2,0	1,92	20,0	60	32	15	3	10 x DC	2			20500
2,0	2,0	1,92	20,0	60	32	15	4	10 x DC	2			20501
2,3	2,3	2,22	7,0	50	22	15	4	3 x DC	2	23101		
2,3	2,3	2,22	11,5	55	27	15	4	5 x DC	2	23201		
2,3	2,3	2,22	18,5	60	32	15	4	8 x DC	2			23301
2,3	2,3	2,22	20,0	60	32	15	4	8,7 x DC	2			23401
2,3	2,3	2,22	23,0	65	37	15	4	10 x DC	2			23501
3,0	3,0	2,90	9,0	50	22	15	4	3 x DC	2	30101		
3,0	3,0	2,90	15,0	55	27	15	4	5 x DC	2	30201		
3,0	3,0	2,90	24,0	65	37	15	4	8 x DC	2			30301
3,0	3,0	2,90	30,0	70	42	15	4	10 x DC	2			30401

P												
M												
K												
N										•	•	•
S												
H												
O												

AluLine – Micro-torus cutter

The specialist for machining non-ferrous metals

▲ T_x = maximum engagement depth

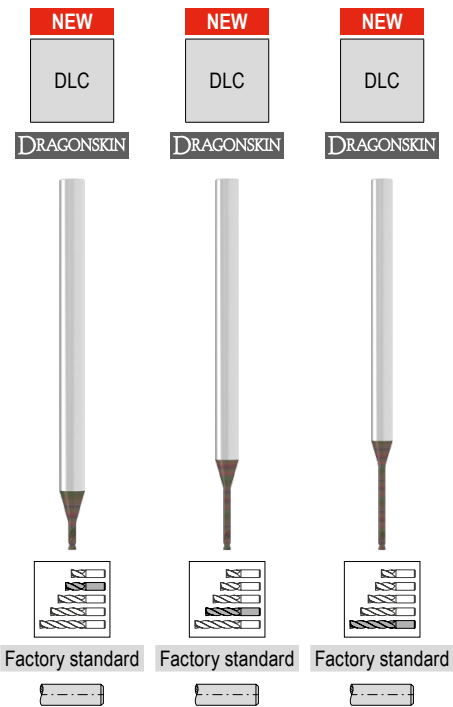
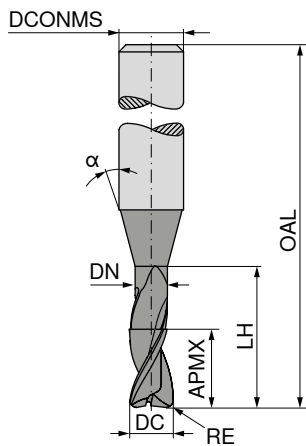
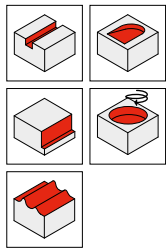
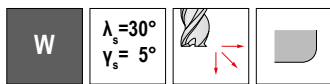

DC _{-0.01}	RE _{±0.01}	APMX	DN	LH	OAL	LPR	α°	DCONMS _{h5}	T _x	ZEFP
mm	mm	mm	mm	mm	mm	mm		mm		
0,2	0,02	0,2	0,18	0,6	45	17	15	4	3 x DC	2
0,2	0,02	0,2	0,18	1,0	45	17	15	4	5 x DC	2
0,2	0,02	0,2	0,18	1,6	45	17	15	4	8 x DC	2
0,2	0,02	0,2	0,18	2,0	50	22	15	4	10 x DC	2
0,3	0,03	0,3	0,28	0,9	45	17	15	4	3 x DC	2
0,3	0,03	0,3	0,28	1,5	45	17	15	4	5 x DC	2
0,3	0,03	0,3	0,28	2,4	50	22	15	4	8 x DC	2
0,3	0,03	0,3	0,28	3,0	50	22	15	4	10 x DC	2
0,4	0,04	0,4	0,37	1,2	45	17	15	4	3 x DC	2
0,4	0,04	0,4	0,37	2,0	45	17	15	4	5 x DC	2
0,4	0,04	0,4	0,37	3,2	50	22	15	4	8 x DC	2
0,4	0,04	0,4	0,37	4,0	50	22	15	4	10 x DC	2
0,5	0,05	0,5	0,45	1,5	45	17	15	4	3 x DC	2
0,5	0,05	0,5	0,45	1,5	45	17	15	3	3 x DC	2
0,5	0,05	0,5	0,45	2,5	45	17	15	4	5 x DC	2
0,5	0,05	0,5	0,45	2,5	45	17	15	3	5 x DC	2
0,5	0,05	0,5	0,45	4,0	45	17	15	3	8 x DC	2
0,5	0,05	0,5	0,45	4,0	50	22	15	4	8 x DC	2
0,5	0,05	0,5	0,45	5,0	50	22	15	3	10 x DC	2
0,5	0,05	0,5	0,45	5,0	50	22	15	4	10 x DC	2
0,6	0,06	0,6	0,58	2,0	45	17	15	4	3,3 x DC	2
0,6	0,06	0,6	0,58	3,0	50	22	15	4	5 x DC	2
0,6	0,06	0,6	0,58	4,2	50	22	15	4	7 x DC	2
0,6	0,06	0,6	0,58	5,0	50	22	15	4	8,3 x DC	2
0,6	0,06	0,6	0,58	6,0	50	22	15	4	10 x DC	2
0,8	0,08	0,8	0,77	2,5	45	17	15	4	3,1 x DC	2
0,8	0,08	0,8	0,77	4,0	50	22	15	4	5 x DC	2
0,8	0,08	0,8	0,77	6,5	50	22	15	4	8,1 x DC	2
0,8	0,08	0,8	0,77	8,0	50	22	15	4	10 x DC	2
1,0	0,10	1,0	0,95	3,0	45	17	15	4	3 x DC	2
1,0	0,10	1,0	0,95	3,0	45	17	15	3	3 x DC	2
1,0	0,10	1,0	0,95	5,0	45	17	15	3	5 x DC	2
1,0	0,10	1,0	0,95	5,0	50	22	15	4	5 x DC	2
1,0	0,10	1,0	0,95	8,0	50	22	15	3	8 x DC	2
1,0	0,10	1,0	0,95	8,0	50	22	15	4	8 x DC	2
1,0	0,10	1,0	0,95	10,0	50	22	15	3	10 x DC	2
1,0	0,10	1,0	0,95	10,0	55	27	15	4	10 x DC	2
1,0	0,10	1,0	0,95	12,0	55	27	15	3	12 x DC	2
1,0	0,10	1,0	0,95	12,0	55	27	15	4	12 x DC	2
1,2	0,12	1,2	1,15	3,0	45	17	15	4	2,5 x DC	2
1,2	0,12	1,2	1,15	6,0	50	22	15	4	5 x DC	2
1,2	0,12	1,2	1,15	10,0	55	27	15	4	8,3 x DC	2

53 901 ...	53 901 ...	53 901 ...
02101		
02201		
	02301	
	02401	
03101		
03201		
	03301	
	03401	
04101		
04201		
	04301	
	04401	
05101		
05100		
05201		
05200		
	05300	
	05301	
	05400	
	05401	
06101		
06201		
	06301	
	06401	
	06501	
08101		
08201		
	08301	
	08401	
10101		
10100		
10200		
10201		
	10300	
	10301	
	10400	
	10401	
		10500
		10501
12101		
12201		
	12301	

P			
M			
K			
N	•	•	•
S			
H			
O			

AluLine – Micro-torus cutter

The specialist for machining non-ferrous metals

▲ T_x = maximum engagement depth

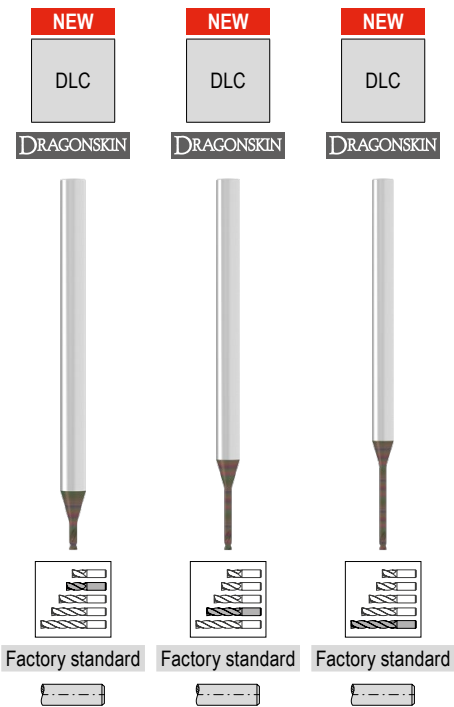
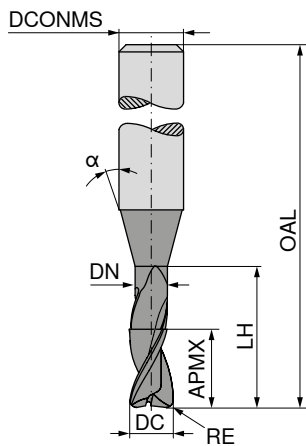
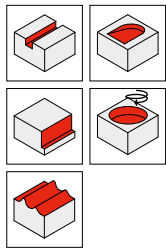
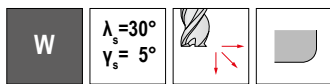

DC _{-0,01} mm	RE _{±0,01} mm	APMX mm	DN mm	LH mm	OAL mm	LPR mm	α°	DCONMS _{h5} mm	T _x	ZEFP
1,2	0,12	1,2	1,15	12,0	55	27	15	4	10 x DC	2
1,3	0,13	1,3	1,25	4,0	45	17	15	4	3,1 x DC	2
1,3	0,13	1,3	1,25	7,0	50	22	15	4	5,4 x DC	2
1,3	0,13	1,3	1,25	11,0	55	27	15	4	8,5 x DC	2
1,3	0,13	1,3	1,25	13,0	55	27	15	4	10 x DC	2
1,5	0,15	1,5	1,44	5,0	50	22	15	4	3,3 x DC	2
1,5	0,15	1,5	1,44	5,0	45	17	15	3	3,3 x DC	2
1,5	0,15	1,5	1,44	7,5	50	22	15	3	5 x DC	2
1,5	0,15	1,5	1,44	7,5	50	22	15	4	5 x DC	2
1,5	0,15	1,5	1,44	12,0	55	27	15	3	8 x DC	2
1,5	0,15	1,5	1,44	12,0	55	27	15	4	8 x DC	2
1,5	0,15	1,5	1,44	15,0	55	27	15	3	10 x DC	2
1,5	0,15	1,5	1,44	15,0	60	32	15	4	10 x DC	2
1,6	0,16	1,6	1,52	5,0	50	22	15	4	3,1 x DC	2
1,6	0,16	1,6	1,52	8,0	50	22	15	4	5 x DC	2
1,6	0,16	1,6	1,52	13,0	55	27	15	4	8,1 x DC	2
1,6	0,16	1,6	1,52	16,0	60	32	15	4	10 x DC	2
1,8	0,18	1,8	1,72	5,5	50	22	15	4	3,1 x DC	2
1,8	0,18	1,8	1,72	9,0	50	22	15	4	5 x DC	2
1,8	0,18	1,8	1,72	14,5	55	27	15	4	8,1 x DC	2
1,8	0,18	1,8	1,72	18,0	60	32	15	4	10 x DC	2
2,0	0,20	2,0	1,92	6,0	50	22	15	4	3 x DC	2
2,0	0,20	2,0	1,92	6,0	45	17	15	3	3 x DC	2
2,0	0,20	2,0	1,92	10,0	50	22	15	4	5 x DC	2
2,0	0,20	2,0	1,92	10,0	50	22	15	3	5 x DC	2
2,0	0,20	2,0	1,92	14,0	55	27	15	3	7 x DC	2
2,0	0,20	2,0	1,92	14,0	55	27	15	4	7 x DC	2
2,0	0,20	2,0	1,92	16,0	55	27	15	3	8 x DC	2
2,0	0,20	2,0	1,92	16,0	60	32	15	4	8 x DC	2
2,0	0,20	2,0	1,92	20,0	60	32	15	3	10 x DC	2
2,0	0,20	2,0	1,92	20,0	60	32	15	4	10 x DC	2
2,3	0,23	2,3	2,22	7,0	50	22	15	4	3 x DC	2
2,3	0,23	2,3	2,22	11,5	55	27	15	4	5 x DC	2
2,3	0,23	2,3	2,22	14,0	55	27	15	4	6,1 x DC	2
2,3	0,23	2,3	2,22	18,5	60	32	15	4	8 x DC	2
2,3	0,23	2,3	2,22	20,0	60	32	15	4	8,7 x DC	2
2,3	0,23	2,3	2,22	23,0	65	37	15	4	10 x DC	2
3,0	0,30	3,0	2,90	9,0	50	22	15	4	3 x DC	2
3,0	0,30	3,0	2,90	15,0	55	27	15	4	5 x DC	2
3,0	0,30	3,0	2,90	24,0	65	37	15	4	8 x DC	2
3,0	0,30	3,0	2,90	30,0	70	42	15	4	10 x DC	2

53 901 ...	53 901 ...	53 901 ...
13101		12401
		13201
		13301
		13401
15101		
15100		
15200		
15201		
		15300
		15301
		15400
		15401
16101		
16201		
		16301
		16401
18101		
18201		
		18301
		18401
20101		
20100		
20201		
20200		
		20300
		20301
		20400
		20401
		20500
		20501
23101		
23201		
		23301
		23401
		23501
		23601
30101		
30201		
		30301
		30401

P			
M			
K			
N		•	•
S			
H			
O			

Material examples for cutting data tables

	Material sub-group	Index	Composition / Structure / Heat treatment	Tensile strength N/mm ² / HB / HRC	Material number	Material designation	Material number	Material designation
P	Unalloyed steel	P.1.1	< 0,15 % C Annealed	420 N/mm ² / 125 HB	1.0401	C15	1.1141	Ck15
		P.1.2	< 0,45 % C Annealed	640 N/mm ² / 190 HB	1.1191	C45E	1.0718	9SMnPb28
		P.1.3	< 0,45 % C Tempered	840 N/mm ² / 250 HB	1.1191	C45E	1.0535	C55
		P.1.4	< 0,75 % C Annealed	910 N/mm ² / 270 HB	1.1223	C60R	1.0535	C55
		P.1.5	< 0,75 % C Tempered	1010 N/mm ² / 300 HB	1.1223	C60R	1.0727	45S20
	Low-alloy steel	P.2.1	Annealed	610 N/mm ² / 180 HB	1.7131	16MnCr5	1.6587	17CrNiMo6
		P.2.2	Tempered	930 N/mm ² / 275 HB	1.7131	16MnCr5	1.6587	17CrNiMo6
		P.2.3	Tempered	1010 N/mm ² / 300 HB	1.7225	42CrMo4	1.3505	100Cr6
		P.2.4	Tempered	1200 N/mm ² / 375 HB	1.7225	42CrMo4	1.3505	100Cr6
	High-alloy steel and high-alloy tool steel	P.3.1	Annealed	680 N/mm ² / 200 HB	1.4021	X20Cr13	1.4034	X46Cr13
		P.3.2	Hardened and tempered	1100 N/mm ² / 300 HB	1.2343	X38CrMoV5-1	1.4034	X46Cr13
		P.3.3	Hardened and tempered	1300 N/mm ² / 400 HB	1.2343	X38CrMoV5-1	1.4034	X46Cr13
	Stainless steel	P.4.1	Ferritic / martensitic Annealed	680 N/mm ² / 200 HB	1.4016	X6Cr17	1.2316	X36CrMo16
		P.4.2	Martensitic Tempered	1010 N/mm ² / 300 HB	1.4112	X90CrMoV18	1.2316	X36CrMo16
M	Stainless steel	M.1.1	Austenitic / austenitic-ferritic Quenched	610 N/mm ² / 180 HB	1.4301	X5CrNi18-10	1.4571	X6CrNiMoTi17-12-2
		M.2.1	Austenitic Tempered	300 HB	1.4841	X15CrNiSi25-21	1.4539	X1NiCrMoCu25-20-5
		M.3.1	Austenitic / ferritic (Duplex)	780 N/mm ² / 230 HB	1.4462	X2CrNiMoN22-5-3	1.4501	X2CrNiMoCuWN25-7-4
K	Grey cast iron	K.1.1	Pearlitic / ferritic	350 N/mm ² / 180 HB	0.6010	GG-10	0.6025	GG-25
		K.1.2	Pearlitic (martensitic)	500 N/mm ² / 260 HB	0.6030	GG-30	0.6045	GG-45
	Spherulitic graphite cast iron	K.2.1	Ferritic	540 N/mm ² / 160 HB	0.7040	GGG-40	0.7060	GGG-60
		K.2.2	Pearlitic	845 N/mm ² / 250 HB	0.7070	GGG-70	0.7080	GGG-80
	Malleable iron	K.3.1	Ferritic	440 N/mm ² / 130 HB	0.8035	GTW-35-04	0.8045	GTW-45
		K.3.2	Pearlitic	780 N/mm ² / 230 HB	0.8165	GTS-65-02	0.8170	GTS-70-02
N	Aluminium wrought alloy	N.1.1	Non-hardenable	60 HB	3.0255	Al99,5	3.3315	AlMg1
		N.1.2	Hardenable Age-hardened	340 N/mm ² / 100 HB	3.1355	AlCuMg2	3.2315	AlMgSi1
	Cast aluminium alloy	N.2.1	≤ 12 % Si, non-hardenable	250 N/mm ² / 75 HB	3.2581	G-AlSi12	3.2163	G-AlSi9Cu3
		N.2.2	≤ 12 % Si, hardenable Age-hardened	300 N/mm ² / 90 HB	3.2134	G-AlSi5Cu1Mg	3.2373	G-AlSi9Mg
		N.2.3	> 12 % Si, non-hardenable	440 N/mm ² / 130 HB		G-AlSi17Cu4Mg		G-AlSi18CuNiMg
	Copper and copper alloys (bronze/brass)	N.3.1	Free-machining alloys, PB > 1 %	375 N/mm ² / 110 HB	2.0380	CuZn39Pb2 (Ms58)	2.0410	CuZn44Pb2
		N.3.2	CuZn, CuSnZn	300 N/mm ² / 90 HB	2.0331	CuZn15	2.4070	CuZn28Sn1As
		N.3.3	CuSn, lead-free copper and electrolytic copper	340 N/mm ² / 100 HB	2.0060	E-Cu57	2.0590	CuZn40Fe
	Magnesium alloys	N.4.1	Magnesium and magnesium alloys	70 HB	3.5612	MgAl6Zn	3.5312	MgAl3Zn
	S	Heat-resistant alloys	S.1.1	Fe - basis Annealed	680 N/mm ² / 200 HB	1.4864	X12NiCrSi 36-16	1.4865
S.1.2			Fe - basis Age-hardened	950 N/mm ² / 280 HB	1.4980	X6NiCrTiMoVB25-15-2	1.4876	X10NiCrAlTi32-20
S.2.1			Ni or Co basis Annealed	840 N/mm ² / 250 HB	2.4631	NiCr20TiAl (Nimonic80A)	3.4856	NiCr22Mo9Nb
S.2.2			Ni or Co basis Age-hardened	1180 N/mm ² / 350 HB	2.4668	NiCr19Nb5Mo3 (Inconel 718)	2.4955	NiFe25Cr20NbTi
S.2.3			Ni or Co basis Cast	1080 N/mm ² / 320 HB	2.4765	CoCr20W15Ni	1.3401	G-X120Mn12
Titanium alloys		S.3.1	Pure titanium	400 N/mm ²	3.7025	Ti99,8	3.7034	Ti99,7
		S.3.2	Alpha + beta alloys Age-hardened	1050 N/mm ² / 320 HB	3.7165	TiAl6V4	Ti-6246	Ti-6Al-2Sn-4Zr-6Mo
S.3.3	Beta alloys	1400 N/mm ² / 410 HB	Ti555.3	Ti-5Al-5V-5Mo-3Cr	R56410	Ti-10V-2Fe-3Al		
H	Hardened steel	H.1.1	Hardened and tempered	46–55 HRC				
		H.1.2	Hardened and tempered	56–60 HRC				
		H.1.3	Hardened and tempered	61–65 HRC				
		H.1.4	Hardened and tempered	66–70 HRC				
	Chilled iron	H.2.1	Cast	400 HB				
Hardened cast iron	H.3.1	Hardened and tempered	55 HRC					
O	Non-metal materials	O.1.1	Plastics, duroplastic	≤ 150 N/mm ²				
		O.1.2	Plastics, thermoplastic	≤ 100 N/mm ²				
		O.2.1	Aramid fibre-reinforced	≤ 1000 N/mm ²				
		O.2.2	Glass/carbon-fibre reinforced	≤ 1000 N/mm ²				
		O.3.1	Graphite					

* Tensile strength

Cutting data standard values – AluLine – micro cutter

Index	T _x ≤ 3xDC			53 900 ... / 53 901 ... / 53 903 ...									● 1st choice ○ suitable		
	v _c (mm)	a _{p,max} x DC	a _{e,max} x DC	Ø DC (mm) =									Emulsion	Compressed air	MQL
				0,2	> Ø 0,2 ≤ Ø 0,4	> Ø 0,4 ≤ Ø 0,6	> Ø 0,6 ≤ Ø 0,8	> Ø 0,8 ≤ Ø 1,0	> Ø 1,0 ≤ Ø 1,2	> Ø 1,2 ≤ Ø 1,5	> Ø 1,5 ≤ Ø 2,0	> Ø 2,0 ≤ Ø 3,0			
				f _z (mm)											
N.1.1	400	0,15	1,0	0,0085	0,0115	0,0140	0,0170	0,0200	0,0230	0,0280	0,0350	0,0500	●	○	○
N.1.2	400	0,15	1,0	0,0085	0,0115	0,0140	0,0170	0,0200	0,0230	0,0280	0,0350	0,0500	●	○	○
N.2.1	400	0,15	1,0	0,0085	0,0115	0,0140	0,0170	0,0200	0,0230	0,0280	0,0350	0,0500	●	○	○
N.2.2	300	0,15	1,0	0,0085	0,0115	0,0140	0,0170	0,0200	0,0230	0,0280	0,0350	0,0500	●	○	○
N.2.3	200	0,15	1,0	0,0085	0,0115	0,0140	0,0170	0,0200	0,0230	0,0280	0,0350	0,0500	●	○	○
N.3.1	140	0,08	1,0	0,0050	0,0065	0,0080	0,0100	0,0115	0,0130	0,0160	0,0210	0,0300	●	○	○
N.3.2	100	0,08	1,0	0,0050	0,0065	0,0080	0,0100	0,0115	0,0130	0,0160	0,0210	0,0300	●	○	○
N.3.3	150	0,08	1,0	0,0050	0,0065	0,0080	0,0100	0,0115	0,0130	0,0160	0,0210	0,0300	●	○	○
N.4.1															



Plunging angle for ramping and helical milling: 3°

Index	T _x > 3xDC – 5xDC			53 900 ... / 53 901 ... / 53 903 ...									● 1st choice ○ suitable		
	v _c (mm)	a _{p,max} x DC	a _{e,max} x DC	Ø DC (mm) =									Emulsion	Compressed air	MQL
				0,2	> Ø 0,2 ≤ Ø 0,4	> Ø 0,4 ≤ Ø 0,6	> Ø 0,6 ≤ Ø 0,8	> Ø 0,8 ≤ Ø 1,0	> Ø 1,0 ≤ Ø 1,2	> Ø 1,2 ≤ Ø 1,5	> Ø 1,5 ≤ Ø 2,0	> Ø 2,0 ≤ Ø 3,0			
				f _z (mm)											
N.1.1	320	0,12	1,0	0,0085	0,0115	0,0140	0,0170	0,0200	0,0230	0,0280	0,0350	0,0500	●	○	○
N.1.2	320	0,12	1,0	0,0085	0,0115	0,0140	0,0170	0,0200	0,0230	0,0280	0,0350	0,0500	●	○	○
N.2.1	320	0,12	1,0	0,0085	0,0115	0,0140	0,0170	0,0200	0,0230	0,0280	0,0350	0,0500	●	○	○
N.2.2	240	0,12	1,0	0,0085	0,0115	0,0140	0,0170	0,0200	0,0230	0,0280	0,0350	0,0500	●	○	○
N.2.3	160	0,12	1,0	0,0085	0,0115	0,0140	0,0170	0,0200	0,0230	0,0280	0,0350	0,0500	●	○	○
N.3.1	110	0,064	1,0	0,0050	0,0065	0,0080	0,0100	0,0115	0,0130	0,0160	0,0210	0,0300	●	○	○
N.3.2	80	0,064	1,0	0,0050	0,0065	0,0080	0,0100	0,0115	0,0130	0,0160	0,0210	0,0300	●	○	○
N.3.3	120	0,064	1,0	0,0050	0,0065	0,0080	0,0100	0,0115	0,0130	0,0160	0,0210	0,0300	●	○	○
N.4.1															



Plunging angle for ramping and helical milling: 2°

Index	T _x > 5xDC – 7xDC			53 900 ... / 53 901 ... / 53 903 ...									● 1st choice ○ suitable		
	v _c (mm)	a _{p,max} x DC	a _{e,max} x DC	Ø DC (mm) =									Emulsion	Compressed air	MQL
				0,2	> Ø 0,2 ≤ Ø 0,4	> Ø 0,4 ≤ Ø 0,6	> Ø 0,6 ≤ Ø 0,8	> Ø 0,8 ≤ Ø 1,0	> Ø 1,0 ≤ Ø 1,2	> Ø 1,2 ≤ Ø 1,5	> Ø 1,5 ≤ Ø 2,0	> Ø 2,0 ≤ Ø 3,0			
				f _z (mm)											
N.1.1	240	0,105	1,0	0,0085	0,0115	0,0140	0,0170	0,0200	0,0230	0,0280	0,0350	0,0500	●	○	○
N.1.2	240	0,105	1,0	0,0085	0,0115	0,0140	0,0170	0,0200	0,0230	0,0280	0,0350	0,0500	●	○	○
N.2.1	240	0,105	1,0	0,0085	0,0115	0,0140	0,0170	0,0200	0,0230	0,0280	0,0350	0,0500	●	○	○
N.2.2	180	0,105	1,0	0,0085	0,0115	0,0140	0,0170	0,0200	0,0230	0,0280	0,0350	0,0500	●	○	○
N.2.3	120	0,105	1,0	0,0085	0,0115	0,0140	0,0170	0,0200	0,0230	0,0280	0,0350	0,0500	●	○	○
N.3.1	85	0,056	1,0	0,0050	0,0065	0,0080	0,0100	0,0115	0,0130	0,0160	0,0210	0,0300	●	○	○
N.3.2	60	0,056	1,0	0,0050	0,0065	0,0080	0,0100	0,0115	0,0130	0,0160	0,0210	0,0300	●	○	○
N.3.3	90	0,056	1,0	0,0050	0,0065	0,0080	0,0100	0,0115	0,0130	0,0160	0,0210	0,0300	●	○	○
N.4.1															



Plunging angle for ramping and helical milling: 2°

Cutting data standard values – AluLine – micro cutter

Index	T _r > 7xDC – 9xDC			53 900 ... / 53 901 ... / 53 903 ...									● 1st choice ○ suitable		
	v _c (mm)	a _{p,max} x DC	a _{e,max} x DC	Ø DC (mm) =									Emulsion	Compressed air	MQL
				0,2	> Ø 0,2 ≤ Ø 0,4	> Ø 0,4 ≤ Ø 0,6	> Ø 0,6 ≤ Ø 0,8	> Ø 0,8 ≤ Ø 1,0	> Ø 1,0 ≤ Ø 1,2	> Ø 1,2 ≤ Ø 1,5	> Ø 1,5 ≤ Ø 2,0	> Ø 2,0 ≤ Ø 3,0			
				f _z (mm)											
N.1.1	160	0,09	1,0	0,0085	0,0115	0,0140	0,0170	0,0200	0,0230	0,0280	0,0350	0,0500	●	○	○
N.1.2	160	0,09	1,0	0,0085	0,0115	0,0140	0,0170	0,0200	0,0230	0,0280	0,0350	0,0500	●	○	○
N.2.1	160	0,09	1,0	0,0085	0,0115	0,0140	0,0170	0,0200	0,0230	0,0280	0,0350	0,0500	●	○	○
N.2.2	120	0,09	1,0	0,0085	0,0115	0,0140	0,0170	0,0200	0,0230	0,0280	0,0350	0,0500	●	○	○
N.2.3	80	0,09	1,0	0,0085	0,0115	0,0140	0,0170	0,0200	0,0230	0,0280	0,0350	0,0500	●	○	○
N.3.1	55	0,048	1,0	0,0050	0,0065	0,0080	0,0100	0,0115	0,0130	0,0160	0,0210	0,0300	●	○	○
N.3.2	40	0,048	1,0	0,0050	0,0065	0,0080	0,0100	0,0115	0,0130	0,0160	0,0210	0,0300	●	○	○
N.3.3	60	0,048	1,0	0,0050	0,0065	0,0080	0,0100	0,0115	0,0130	0,0160	0,0210	0,0300	●	○	○
N.4.1															



Plunging angle for ramping and helical milling = 1°

Index	T _r > 9xDC – 12xDC			53 900 ... / 53 901 ... / 53 903 ...									● 1st choice ○ suitable		
	v _c (mm)	a _{p,max} x DC	a _{e,max} x DC	Ø DC (mm) =									Emulsion	Compressed air	MQL
				0,2	> Ø 0,2 ≤ Ø 0,4	> Ø 0,4 ≤ Ø 0,6	> Ø 0,6 ≤ Ø 0,8	> Ø 0,8 ≤ Ø 1,0	> Ø 1,0 ≤ Ø 1,2	> Ø 1,2 ≤ Ø 1,5	> Ø 1,5 ≤ Ø 2,0	> Ø 2,0 ≤ Ø 3,0			
				f _z (mm)											
N.1.1	120	0,075	1,0	0,0085	0,0115	0,0140	0,0170	0,0200	0,0230	0,0280	0,0350	0,0500	●	○	○
N.1.2	120	0,075	1,0	0,0085	0,0115	0,0140	0,0170	0,0200	0,0230	0,0280	0,0350	0,0500	●	○	○
N.2.1	120	0,075	1,0	0,0085	0,0115	0,0140	0,0170	0,0200	0,0230	0,0280	0,0350	0,0500	●	○	○
N.2.2	90	0,075	1,0	0,0085	0,0115	0,0140	0,0170	0,0200	0,0230	0,0280	0,0350	0,0500	●	○	○
N.2.3	60	0,075	1,0	0,0085	0,0115	0,0140	0,0170	0,0200	0,0230	0,0280	0,0350	0,0500	●	○	○
N.3.1	40	0,04	1,0	0,0050	0,0065	0,0080	0,0100	0,0115	0,0130	0,0160	0,0210	0,0300	●	○	○
N.3.2	30	0,04	1,0	0,0050	0,0065	0,0080	0,0100	0,0115	0,0130	0,0160	0,0210	0,0300	●	○	○
N.3.3	45	0,04	1,0	0,0050	0,0065	0,0080	0,0100	0,0115	0,0130	0,0160	0,0210	0,0300	●	○	○
N.4.1															



Plunging angle for ramping and helical milling = 1°

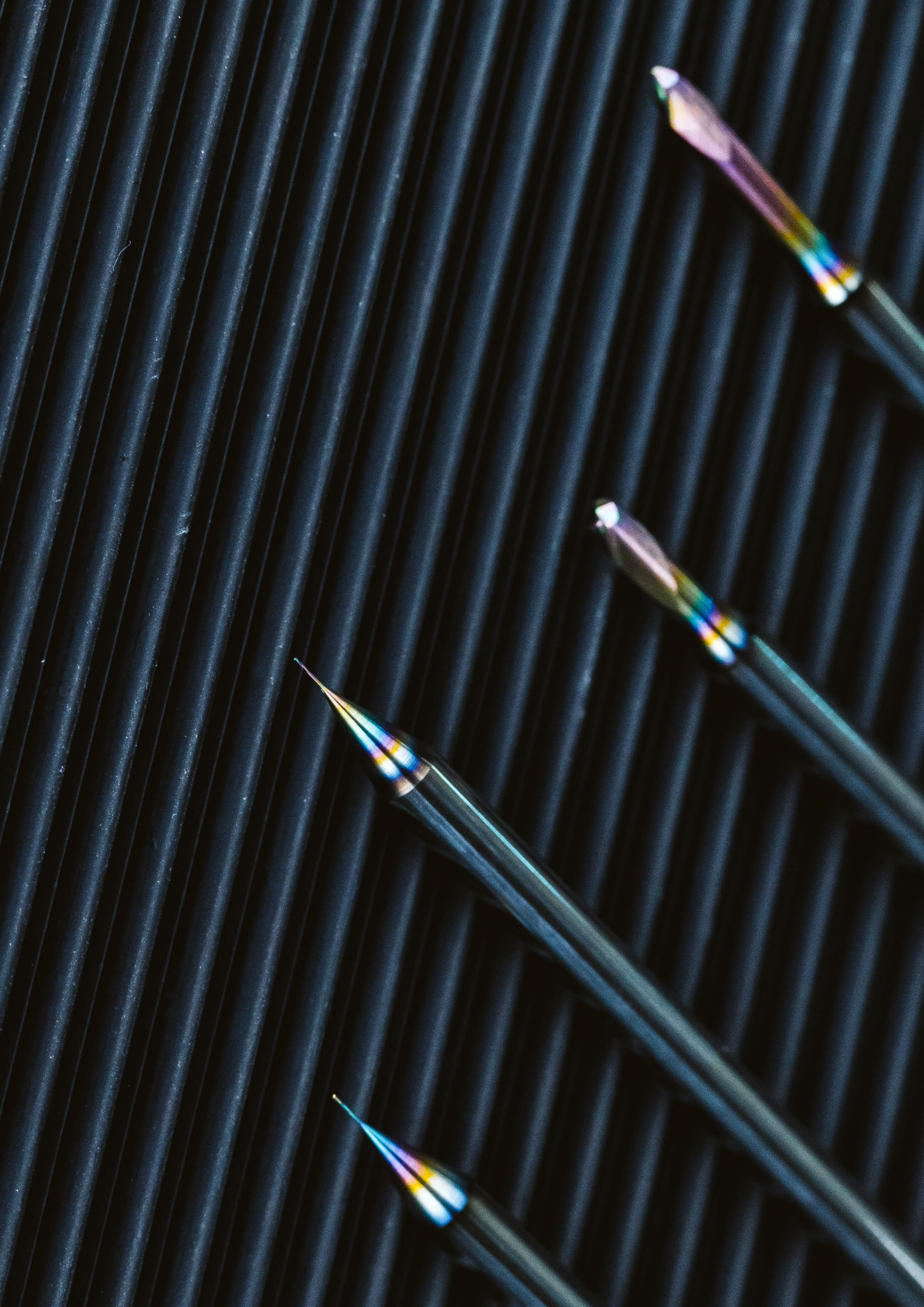

MaxiMill – 211-15-DC Shell mill

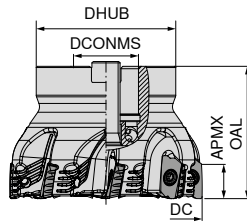
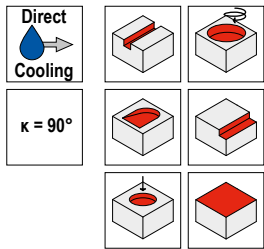

NEW

50 798 ...

Designation	DC mm	ZNF	APMX mm	OAL mm	DCONMS _{H6} mm	DHUB mm	RPMX 1/min.	torque moment Nm	Insert	
A211.40.R.04-15-DCA R08	40	4	14	45	16	38	18000	3,2	XDKT 1505..	04004
A211.40.R.04-15-DCA R40	40	4	14	45	16	38	18000	3,2	XDKT 1505..	24004
A211.50.R.05-15-DCA R40	50	5	14	45	22	45	15000	3,2	XDKT 1505..	25005
A211.50.R.05-15-DCA R08	50	5	14	45	22	45	15000	3,2	XDKT 1505..	05005
A211.63.R.06-15-DCA R40	63	6	14	50	22	48	14000	3,2	XDKT 1505..	26306
A211.63.R.06-15-DCA R08	63	6	14	50	22	48	14000	3,2	XDKT 1505..	06306
A211.80.R.08-15-DCA R08	80	8	14	55	27	58	12000	3,2	XDKT 1505..	08008
A211.80.R.08-15-DCA R40	80	8	14	55	27	58	12000	3,2	XDKT 1505..	28008

Spare parts
DC

40 - 80

TORX® blade	Key D	Molykote	Clamping screw	Torque screwdriver
80 950 ...	80 950 ...	70 950 ...	70 950 ...	80 950 ...
054	128	303	839	193

XDKT

Designation	IC mm	D1 mm	L mm	BS mm	S mm
XDKT 150508..	9,3	4,4	14,8	1,6	5,56
XDKT 150532..	9,3	4,4	14,8	1,9	5,56
XDKT 150540..	9,3	4,4	14,8	1,2	5,56

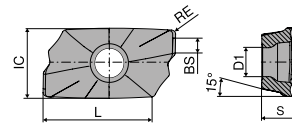



XDKT





XDKT

ISO	RE mm
150508ER	0,8
150532ER	3,2
150540ER	4,0

P		
M		
K		
N		
S		
H		
O		

NEW	NEW
-F40 CTCS245	-F40 CTC5240
DRAGONSKIN	DRAGONSKIN
	
F XDKT	F XDKT
51 165 ...	51 165 ...
50801	10801
53201	13201
54001	14001

Cutting data standard values

			CTC5240		CTCS245		
			DRAGONSKIN		DRAGONSKIN		
							
			Cutting Material hard (v _c ↑) → tough (v _c ↓)				
			v _c (m/min)				
Material sub-group	Index	Tensile strength N/mm ² * / HB / HRC					
P	Unalloyed steel	P.1.1	420 N/mm ² / 125 HB				
		P.1.2	640 N/mm ² / 190 HB				
		P.1.3	840 N/mm ² / 250 HB				
		P.1.4	910 N/mm ² / 270 HB				
		P.1.5	1010 N/mm ² / 300 HB				
	Low-alloy steel	P.2.1	610 N/mm ² / 180 HB				
		P.2.2	930 N/mm ² / 275 HB				
		P.2.3	1010 N/mm ² / 300 HB				
		P.2.4	1200 N/mm ² / 375 HB				
	High-alloy steel and high-alloy tool steel	P.3.1	680 N/mm ² / 200 HB				
		P.3.2	1100 N/mm ² / 300 HB				
		P.3.3	1300 N/mm ² / 400 HB				
	Stainless steel	P.4.1	680 N/mm ² / 200 HB				
		P.4.2	1010 N/mm ² / 300 HB				
M	Stainless steel	M.1.1	610 N/mm ² / 180 HB				
		M.2.1	300 HB				
		M.3.1	780 N/mm ² / 230 HB				
K	Grey cast iron	K.1.1	350 N/mm ² / 180 HB				
		K.1.2	500 N/mm ² / 260 HB				
	Spherulitic graphite cast iron	K.2.1	540 N/mm ² / 160 HB				
		K.2.2	845 N/mm ² / 250 HB				
	Malleable iron	K.3.1	440 N/mm ² / 130 HB				
		K.3.2	780 N/mm ² / 230 HB				
N	Aluminium wrought alloy	N.1.1	60 HB				
		N.1.2	340 N/mm ² / 100 HB				
	Cast aluminium alloy	N.2.1	250 N/mm ² / 75 HB				
		N.2.2	300 N/mm ² / 90 HB				
		N.2.3	440 N/mm ² / 130 HB				
	Copper and copper alloys (bronze/brass)	N.3.1	375 N/mm ² / 110 HB				
		N.3.2	300 N/mm ² / 90 HB				
		N.3.3	340 N/mm ² / 100 HB				
	Magnesium alloys	N.4.1	70 HB				
S	Heat-resistant alloys	S.1.1	680 N/mm ² / 200 HB	80	64		
		S.1.2	950 N/mm ² / 280 HB	70	56		
		S.2.1	840 N/mm ² / 250 HB	35	28		
		S.2.2	1180 N/mm ² / 350 HB	25	20		
		S.2.3	1080 N/mm ² / 320 HB	30	24		
	Titanium alloys	S.3.1	400 N/mm ²	80	64		
		S.3.2	1050 N/mm ² / 320 HB	50	40		
		S.3.3	1400 N/mm ² / 410 HB	40	32		
H	Hardened steel	H.1.1	46–55 HRC				
		H.1.2	56–60 HRC				
		H.1.3	61–65 HRC				
		H.1.4	66–70 HRC				
	Chilled iron	H.2.1	400 HB				
	Hardened cast iron	H.3.1	55 HRC				
O	Non-metal materials	O.1.1	≤ 150 N/mm ²				
		O.1.2	≤ 100 N/mm ²				
		O.2.1	≤ 1000 N/mm ²				
		O.2.2	≤ 1000 N/mm ²				
		O.3.1					

* Tensile strength



The cutting data is strongly influenced by external conditions, such as the stability of the tool and workpiece clamping, material and type of machine. The specified values represent guideline cutting data that can be adjusted by approx. ±20% according to the usage conditions.

System MaxiMill 211-15

Machining strategy

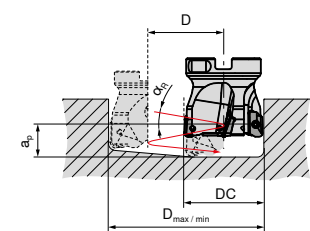

① Helical plunging

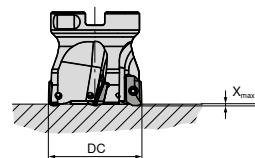

② Axial ramping

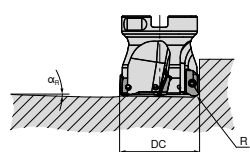

③ Angled ramping



DC mm	Maximum speed related to projection length		
	$l_a = 2 \times \varnothing$ mm	$l_a = 3 \times \varnothing$ mm	$l_a = 5 \times \varnothing$ mm
25	26560	19520	13320
32	24160	16720	9520
40	22160	14400	7200
50	20320	12320	4880
63	18640	10320	2960
80	17040	8480	
100	15680	6720	
125	14320		
160	13200		

DC mm	① Helical plunging		② Axial ramping	③ Angled ramping
		RE = 0,8 mm	X_{max}	α_R
25	α_R	7,5 °		
	$D_{max.}$	48 mm	2,7 mm	9,5 °
	$D_{min.}$	37 mm		
32	α_R	5 °		
	$D_{max.}$	62 mm	2,5 mm	6,8 °
	$D_{min.}$	47 mm		
40	α_R	3,2 °		
	$D_{max.}$	78 mm	2,5 mm	5,1 °
	$D_{min.}$	63 mm		
50	α_R	2,5 °		
	$D_{max.}$	98 mm	2,5 mm	2,5 °
	$D_{min.}$	86 mm		
63	α_R	1,5 °		
	$D_{max.}$	124 mm	2,5 mm	2,5 °
	$D_{min.}$	111 mm		
80	α_R	1,3 °		
	$D_{max.}$	158 mm	2,5 mm	2,0 °
	$D_{min.}$	147 mm		
100	α_R	1,1 °		
	$D_{max.}$	198 mm	2,5 mm	1,5 °
	$D_{min.}$	190 mm		
125	α_R	0,9 °		
	$D_{max.}$	248 mm	2,5 mm	0,9 °
	$D_{min.}$	240 mm		
160	α_R	0,6 °		
	$D_{max.}$	318 mm	2,5 mm	0,7 °
	$D_{min.}$	310 mm		

$D_{max.}$ in mm = largest diameter for flat bottom hole
 $D_{min.}$ in mm = Smallest diameter for flat bottom surface
 a_p in mm = $D \times \pi \times \tan(\alpha_R) =$ Pitch
 l_a in mm = Overhang length

Starting Parameter

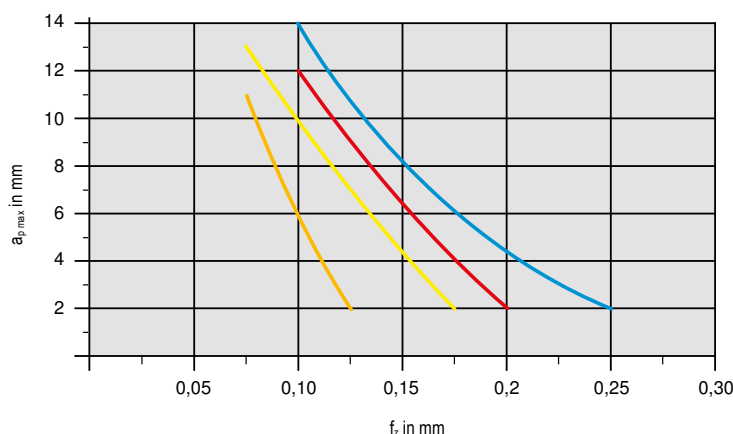

Material	Inserts		v_c in m/min	Cooling		
Steel	P.2.2	40CrMnMoS 8-6	XDKT150508SR-M50	CTCP230	200	Dry
Stainless steel	M.1.1	X6CrNiMoTi 1712 2	XDKT150508SR-F50	CTPM240	180	Dry
Cast iron	K.1.1	EN-GJL-250 (GG25)	XDKT150508SR-R50	CTCK215	250	Dry
Heat-resistant	S.2.2	Inconel 718	XDKT150508ER-F40	CTC5240	35	Emulsion

① Detailed information on cutting speed for each grade can be found on → page 46
 From $v_c > 400$ m/min, the tool must be balanced!

HyPower – Rough

- ▲ High pressure chuck – especially for milling
- ▲ Ideal for HSC and HPC applications
- ▲ High temperature resistance
- ▲ Also available with Balluff chip on request

Scope of supply:

Base body with backstop screw and pressure screw

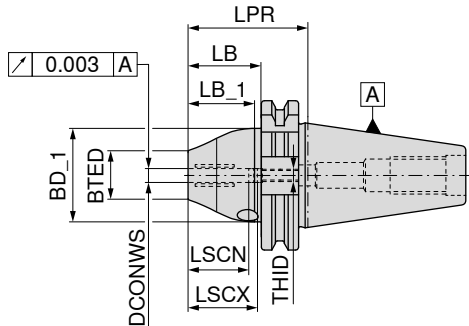

NEW



AD/B
G 2,5 n_{max} 25000

84 254 ...

Adapter	DCONWS mm	LPR mm	BTED mm	BD_1 mm	LB_1 mm	LB mm	LSCX mm	LSCN mm	THID	
SK 40	25	110	38	57,0	65,3	90,9	57	47	M10X1	12579
SK 40	32	115	38	62,5	65,5	95,9	61	51	M12X1	13279



80 397 ...



83 950 ...





83 950 ...

Spare parts

DCONWS						
25	SW5	050	M10x12	55000	M10x1x13,5 - SW5	421
32	SW5	050	M10x12	55000	M12x1x13,5 - SW5	422

Accessories

 → 282	 → 58, 60	 → 284
Reduction sleeve	Pull stud	Others

Accessories can be found in the clamping technology catalogue → Chapter 16, Adapters and accessories

HyPower – Rough

- ▲ High pressure chuck – especially for milling
- ▲ Ideal for HSC and HPC applications
- ▲ High temperature resistance
- ▲ Also available with Balluff chip on request

Scope of supply:

Base body with backstop screw and pressure screw

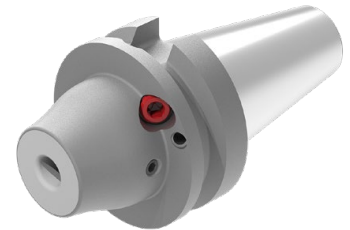
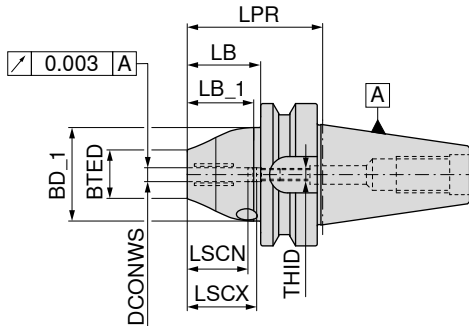

AD
G 2,5 n_{max} 25000

84 254 ...



AD/B
G 2,5 n_{max} 25000

84 254 ...

Adapter	DCONWS mm	LPR mm	BTED mm	BD_1 mm	LB_1 mm	LB mm	LSCX mm	LSCN mm	THID
BT 30	6	54	26	46	29,0	34	37	27	M5
BT 30	8	54	28	46	29,0	34	37	27	M6
BT 30	10	54	30	50	23,5	34	41	31	M8X1
BT 30	12	54	32	50	23,5	34	46	36	M10X1
BT 30	16	69	38	55	38,5	49	49	39	M12X1
BT 30	20	69	38	58	38,5	49	51	41	M12X1
BT 40	25	100	38	57	44,6	75	57	47	M16X1
BT 40	32	105	38	62	50,0	80	61	51	M16X1

10670
10870
11070
11270
11670
12070

12569
13269



Clamping key – T

80 397 ...

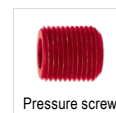

Pressure screw

83 950 ...

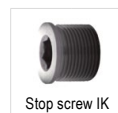



Stop screw IK

83 950 ...

Spare parts

DCONWS					
6	SW5	050	M10x12	55000	M5x12,5 - SW2,5 418
8	SW5	050	M10x12	55000	M6x12,5 - SW3 419
10	SW5	050	M10x12	55000	M8x1x13,5 - SW3 420
12	SW5	050	M10x12	55000	M10x1x13,5 - SW5 421
16	SW5	050	M10x12	55000	M12x1x13,5 - SW5 422
20	SW5	050	M10x12	55000	M12x1x13,5 - SW5 422
25	SW5	050	M10x12	55000	M16x1x13,5 - SW8 424
32	SW5	050	M10x12	55000	M16x1x13,5 - SW8 424

Accessories

 → 282	 → 110+111	 → 284
Reduction sleeve	Pull stud	Others
Accessories can be found in the clamping technology catalogue → Chapter 16, Adaptors and accessories		

HyPower – Rough

- ▲ High pressure chuck – especially for milling
- ▲ Ideal for HSC and HPC applications
- ▲ High temperature resistance
- ▲ Also available with Balluff chip on request

Scope of supply:

Base body with backstop screw and pressure screw

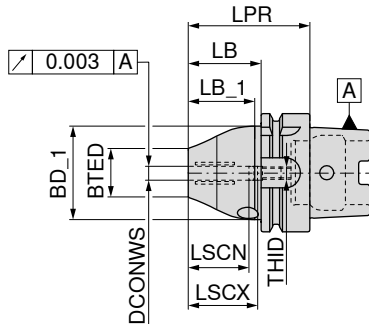

AD
G 2,5 n_{max} 25000

84 254 ...

Adapter	DCONWS mm	LPR mm	BTED mm	BD_1 mm	LB_1 mm	LB mm	LSCX mm	LSCN mm	THID	
HSK-A 63	25	95	38	57,0	45,0	69	57	47	M10X1	12557
HSK-A 63	32	110	38	62,5	56,6	84	61	51	M10X1	13257
HSK-A 100	25	95	38	70,0	62,2	66	57	47	M10X1	12555
HSK-A 100	32	100	38	75,0	67,2	71	61	51	M10X1	13255

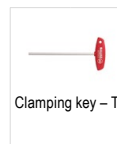

Clamping key – T

80 397 ...



Pressure screw

83 950 ...

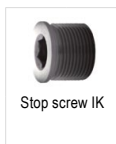



Stop screw IK

83 950 ...

Spare parts

DCONWS						
25	SW5	050	M10x12	55000	M10x1x13,5 - SW5	421
32	SW5	050	M10x12	55000	M10x1x13,5 - SW5	421

Accessories

 → 282	 → 156	 → 284
Reduction sleeve	Coolant transfer pipe	Others
Accessories can be found in the clamping technology catalogue → Chapter 16, Adaptors and accessories		

HyPower – Access 4.5°

- ▲ High pressure chuck with slim contour, original dimensions of a 4.5° shrink contour
- ▲ Especially for reaming and drilling applications
- ▲ Ideal for tool and die production
- ▲ Also available with Balluff chip on request

Scope of supply:

Base body with backstop screw and pressure screw

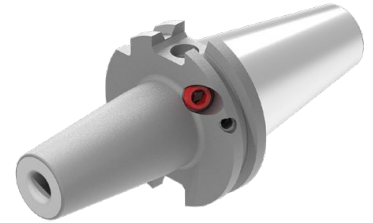
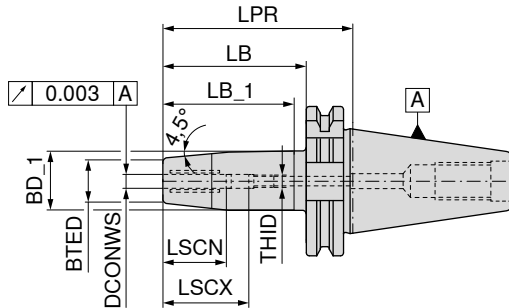

NEW



AD/B
G 2,5 n_{max} 25000

84 255 ...

Adapter	DCONWS mm	LPR mm	BTED mm	BD_1 mm	LB_1 mm	LB mm	LSCX mm	LSCN mm	THID	
SK 40	6	120	21	27	48,9	100,9	37	27	M5	20679
SK 40	8	120	21	27	48,9	100,9	37	27	M6	20879
SK 40	10	120	24	32	61,6	100,9	41	31	M8X1	21079
SK 40	12	120	24	32	61,6	100,9	46	36	M10X1	21279
SK 40	16	120	34	56,2	100,9	49	39	M12X1	21679	
SK 40	20	120	33	42	68,9	100,9	51	41	M16X1	22079

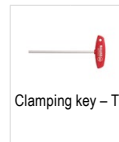

Clamping key – T

80 397 ...



Pressure screw

83 950 ...





Stop screw IK

83 950 ...

Spare parts

DCONWS						
6	SW5	050	M10x12	55000	M5x12,5 - SW2,5	418
8	SW5	050	M10x12	55000	M6x12,5 - SW3	419
10	SW5	050	M10x12	55000	M8x1x13,5 - SW3	420
12	SW5	050	M10x12	55000	M10x1x13,5 - SW5	421
16	SW5	050	M10x12	55000	M12x1x13,5 - SW5	422
20	SW5	050	M10x12	55000	M16x1x13,5 - SW8	424

Accessories

 → 282	 → 58, 60	 → 284
Reduction sleeve	Pull stud	Others
Accessories can be found in the clamping technology catalogue → Chapter 16, Adaptors and accessories		

HyPower – Access 4.5°

- ▲ High pressure chuck with slim contour, original dimensions of a 4.5° shrink contour
- ▲ Especially for reaming and drilling applications
- ▲ Ideal for tool and die production
- ▲ Also available with Balluff chip on request

Scope of supply:

Base body with backstop screw and pressure screw

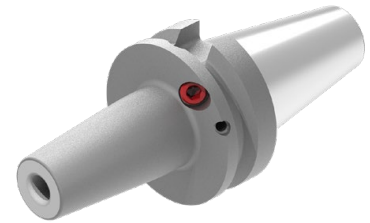
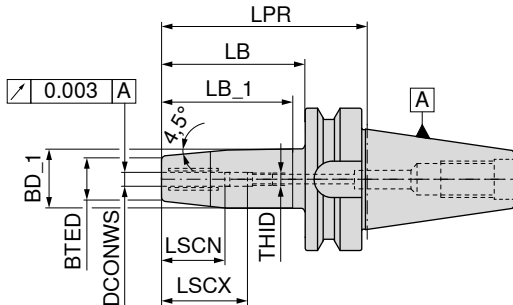

NEW



AD

G 2,5 n_{max} 25000

84 255 ...

NEW



AD/B

G 2,5 n_{max} 25000

84 255 ...

Adapter	DCONWS	LPR	BTED	BD_1	LB_1	LB	LSCX	LSCN	THID		
	mm	mm	mm	mm	mm	mm	mm	mm	mm		
BT 30	6	85	21	27	57,7	65	37	27	M5		10670
BT 30	8	85	21	27	57,7	65	37	27	M6		10870
BT 30	10	85	24	32	57,7	65	41	31	M8X1		11070
BT 30	12	85	24	32	57,7	65	46	36	M10X1		11270
BT 30	16	85	27	34	57,2	65	49	39	M10X1		11670
BT 30	20	85	33	42	57,5	65	51	41	M10X1		12070
BT 40	6	120	21	27	48,9	95	37	27	M5		20669
BT 40	8	120	21	27	48,9	95	37	27	M6		20869
BT 40	10	120	24	32	61,6	95	41	31	M8X1		21069
BT 40	12	120	24	32	61,6	95	46	36	M10X1		21269
BT 40	16	120	27	34	56,2	95	49	39	M12X1		21669
BT 40	20	120	33	42	68,9	95	51	41	M16X1		22069

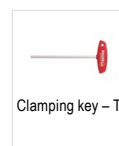

80 397 ...



83 950 ...

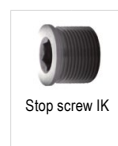



83 950 ...

Spare parts
DCONWS

6	SW5	050	M10x12	55000		
6	SW5	050	M10x12	55000	M5x12,5 - SW2,5	418
8	SW5	050	M10x12	55000		
8	SW5	050	M10x12	55000	M6x12,5 - SW3	419
10	SW5	050	M10x12	55000	M8x1x13,5 - SW3	420
10	SW5	050	M10x12	55000		
12	SW5	050	M10x12	55000	M10x1x13,5 - SW5	421
12	SW5	050	M10x12	55000		
16	SW5	050	M10x12	55000	M10x1x13,5 - SW5	421
16	SW5	050	M10x12	55000		
20	SW5	050	M10x12	55000		
20	SW5	050	M10x12	55000	M10x1x13,5 - SW5	421

Accessories

	→ 282		→ 110+111		→ 284
Reduction sleeve		Pull stud		Others	

Accessories can be found in the clamping technology catalogue → Chapter 16, Adaptors and accessories

HyPower – Access 4.5°

- ▲ High pressure chuck with slim contour, original dimensions of a 4.5° shrink contour
- ▲ Especially for reaming and drilling applications
- ▲ Ideal for tool and die production
- ▲ Also available with Balluff chip on request

Scope of supply:

Base body with backstop screw and pressure screw

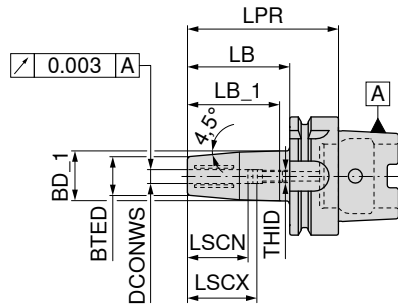

NEW



AD
G 2,5 n_{max} 25000

84 255 ...

Adapter	DCONWS	LPR	BTED	BD_1	LB_1	LB	LSCX	LSCN	THID	
	mm	mm	mm	mm	mm	mm	mm	mm	mm	
HSK-A 63	6	120	21	27	48,9	94	37	27	M5	20657
HSK-A 63	8	120	21	27	48,9	94	37	27	M6	20857
HSK-A 63	10	120	24	32	61,6	94	41	31	M8X1	21057
HSK-A 63	12	120	24	32	61,6	94	46	36	M10X1	21257
HSK-A 63	16	120	27	34	56,2	94	49	39	M12X1	21657
HSK-A 63	20	120	33	42	68,9	94	51	41	M16X1	22057
HSK-A 100	6	120	21	27	48,9	91	37	27	M5	20655
HSK-A 100	8	120	21	27	48,9	91	37	27	M6	20855
HSK-A 100	10	120	24	32	61,6	91	41	31	M8X1	21055
HSK-A 100	12	120	24	32	61,6	91	46	36	M10X1	21255
HSK-A 100	16	120	27	34	56,2	91	49	39	M12X1	21655
HSK-A 100	20	120	33	42	68,9	91	51	41	M16X1	22055



80 397 ...

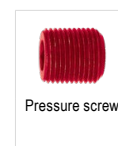

83 950 ...

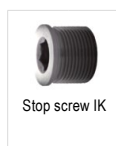

83 950 ...

Spare parts for Article no.

84 255 20657	SW5	050	M10x10	55100	M5x12,5 - SW2,5	418
84 255 20857	SW5	050	M10x10	55100	M6x12,5 - SW3	419
84 255 21057	SW5	050	M10x10	55100	M8x1x13,5 - SW3	420
84 255 21257	SW5	050	M10x10	55100	M10x1x13,5 - SW5	421
84 255 21657	SW5	050	M10x10	55100	M12x1x13,5 - SW5	422
84 255 22057	SW5	050	M10x10	55100	M16x1x13,5 - SW8	424
84 255 20655	SW5	050	M10x12	55000	M5x12,5 - SW2,5	418
84 255 20855	SW5	050	M10x12	55000	M6x12,5 - SW3	419
84 255 21055	SW5	050	M10x12	55000	M8x1x13,5 - SW3	420
84 255 21255	SW5	050	M10x12	55000	M10x1x13,5 - SW5	421
84 255 21655	SW5	050	M10x12	55000	M12x1x13,5 - SW5	422
84 255 22055	SW5	050	M10x12	55000	M16x1x13,5 - SW8	424

Accessories

 → 282	 → 156	 → 284
Reduction sleeve	Coolant transfer pipe	Others

Accessories can be found in the clamping technology catalogue → **Chapter 16, Adaptors and accessories**

Shell mill adapter with reduced flange diameter

- ▲ Screwed drive dogs
- ▲ also available with Balluff chip on request

Scope of supply:

Base body with retaining screw and drive dog

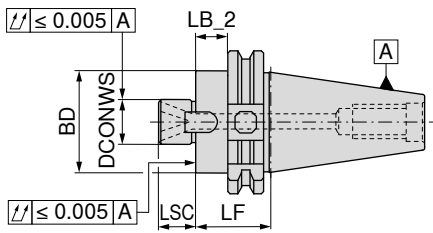

AD
G 2,5 n_{max} 25000

82 315 ...

	Adapter	DCONWS mm	LB_2 mm	LF mm	BD mm	LSC mm	
medium length	SK 40	22	81	100	38	19	22279
	SK 40	27	81	100	48	21	22779
	SK 50	22	81	100	38	19	22278
	SK 50	27	81	100	48	21	22778
long	SK 40	22	111	130	38	19	32279
	SK 40	27	111	130	48	21	32779
	SK 50	22	111	130	38	19	32278
	SK 50	27	111	130	48	21	32778



These shell mill adapters have been specially developed for MaxiMill 211-KN porcupine cutters. Now they can be clamped perfectly, thanks to the adapted flange diameters.



Screw for drivers



Driver



clamping screw

83 950 ...

83 950 ...

83 950 ...

Spare parts
DCONWS

22	M4x8	51700	10x7x20,5	51500	M10x25	124
27	M5x8	51800	12x9x24,3	51600	M12x30	125

Shell mill adapter with reduced flange diameter

- ▲ Screwed drive dogs
- ▲ also available with Balluff chip on request

Scope of supply:

Base body with retaining screw and drive dog

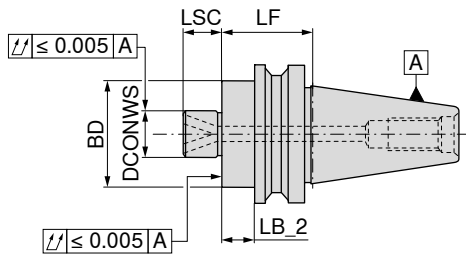

AD
G 2,5 n_{max} 25000

82 315 ...

	Adapter	DCONWS mm	BD mm	LB_2 mm	LF mm	LSC mm	
medium length	BT 40	22	38	73	100	19	22269
	BT 40	27	48	73	100	21	22769
	BT 50	22	38	62	100	19	22268
	BT 50	27	48	62	100	21	22768
long	BT 40	22	38	103	130	19	32269
	BT 40	27	48	103	130	21	32769
	BT 50	22	38	92	130	19	32268
	BT 50	27	48	92	130	21	32768

1 These shell mill adapters have been specially developed for MaxiMill 211-KN porcupine cutters. Now they can be clamped perfectly, thanks to the adapted flange diameters.



Screw for drivers



Driver



clamping screw

83 950 ...

83 950 ...

83 950 ...

Spare parts
DCONWS

22	M4x8	51700	10x7x20,5	51500	M10x25	124
27	M5x8	51800	12x9x24,3	51600	M12x30	125

Shell mill adapter with reduced flange diameter

- ▲ Screwed drive dogs
- ▲ also available with Balluff chip on request

Scope of supply:

Base body with retaining screw and drive dog

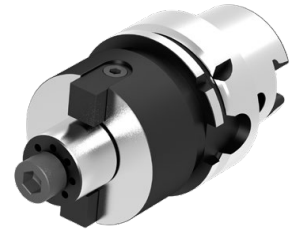
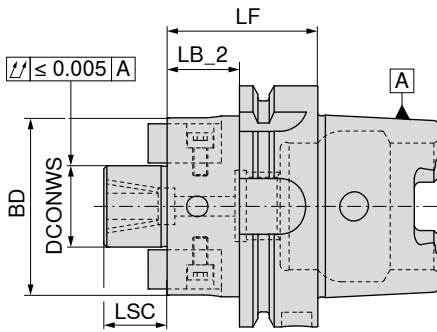

G 2,5 n_{max} 25000

82 315 ...

	Adapter	DCONWS mm	LB_2 mm	LF mm	BD mm	LSC mm	
medium length	HSK-A 63	22	74	100	38	19	22257
	HSK-A 63	27	74	100	48	21	22757
	HSK-A 100	22	71	100	38	19	22255
	HSK-A 100	27	71	100	48	21	22755
long	HSK-A 63	22	104	130	38	19	32257
	HSK-A 63	27	104	130	48	21	32757
	HSK-A 100	22	101	130	38	19	32255
	HSK-A 100	27	101	130	48	21	32755

1 These shell mill adapters have been specially developed for MaxiMill 211-KN porcupine cutters. Now they can be clamped perfectly, thanks to the adapted flange diameters.



Screw for drivers



Driver



clamping screw

83 950 ...

83 950 ...

83 950 ...

Spare parts
DCONWS

22	M4x8	51700	10x7x20,5	51500	M10x25	124
27	M5x8	51800	12x9x24,3	51600	M12x30	125

Cylindrical shank adapter (Weldon)

- ▲ For shanks according to DIN 6535 HB / 1835 B with lateral clamping flat
- ▲ also available with Balluff chip **on request**

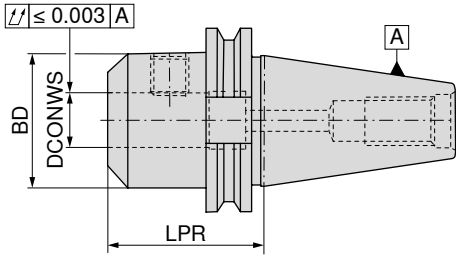

AD/Be
G 2,5 n_{max} 25000

82 404 ...

	Adapter	DCONWS _{H4} mm	LPR mm	BD mm	
short	SK 40	6	50	25	106
	SK 40	8	50	28	108
	SK 40	10	50	35	110
	SK 40	12	50	42	112
	SK 40	14	50	44	114
	SK 40	16	63	48	116
	SK 40	18	63	50	118
	SK 40	20	63	52	120
	SK 40	25	100	65	125 ¹⁾
	SK 40	32	100	72	13200 ¹⁾
	SK 50	6	63	25	30600
	SK 50	8	63	28	30800
	SK 50	10	63	35	31000
	SK 50	12	63	42	31200
	SK 50	14	63	44	31400
	SK 50	16	63	48	31600
	SK 50	18	63	50	31800
	SK 50	20	63	52	32000
	SK 50	25	80	65	32500 ¹⁾
	SK 50	32	100	72	33200 ¹⁾
SK 50	40	120	90	34000	
medium length	SK 40	40	120	80	54000 ¹⁾

1) Version with two grub screws

Accessories



→ 58, 60



→ 284

Pull stud

Others

Accessories can be found in the clamping technology catalogue
→ **Chapter 16, Adapters and accessories**

Cylindrical shank adapter (Weldon)

- ▲ For shanks according to DIN 6535 HB / 1835 B with lateral clamping flat
- ▲ also available with Balluff chip **on request**

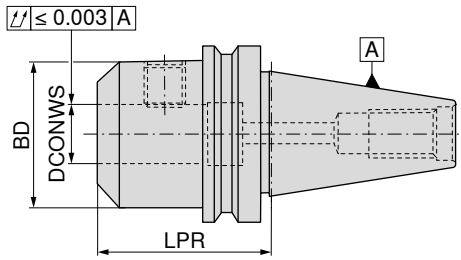

AD/Be
G 2,5 n_{max} 25000

82 504 ...

	Adapter	DCONWS _{H4}	LPR	BD	
		mm	mm	mm	
short	BT 40	6	50	25	106
	BT 40	8	50	28	108
	BT 40	10	63	35	110
	BT 40	12	63	42	112
	BT 40	14	63	44	114
	BT 40	16	63	48	116
	BT 40	18	63	50	118
	BT 40	20	63	52	120
	BT 40	25	100	65	125 ¹⁾
	BT 40	32	100	72	13200 ¹⁾
	BT 40	40	120	90	14000
	BT 50	6	63	25	30600
	BT 50	8	63	28	30800
	BT 50	10	80	35	31000
	BT 50	12	80	42	31200
	BT 50	14	80	44	31400
	BT 50	16	80	48	31600
	BT 50	18	80	50	31800
	BT 50	20	80	52	32000
	BT 50	25	100	65	32500 ¹⁾
BT 50	32	105	72	33200 ¹⁾	
BT 50	40	120	90	34000	

1) Version with two grub screws

Accessories



→ 58, 60



→ 284

Pull stud

Others

Accessories can be found in the clamping technology catalogue
→ **Chapter 16, Adapters and accessories**

Cylindrical shank adapter (Weldon)

- ▲ For shanks according to DIN 6535 HB / 1835 B with lateral clamping flat
- ▲ also available with Balluff chip **on request**

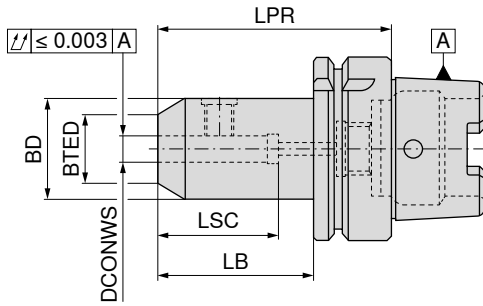

G 2,5 n_{max} 25000

82 404 ...

	Adapter	DCONWS	LPR	BD	BTED	LB	LSC	
		mm	mm	mm	mm	mm	mm	
short	HSK-A 63	6	65	25	15	39	34	10657
	HSK-A 63	8	65	28	20	39	34	10857
	HSK-A 63	10	65	35	25	39	39	11057
	HSK-A 63	12	80	42	30	54	44	11257
	HSK-A 63	14	80	44	32	54	44	11457
	HSK-A 63	16	80	48	36	54	47	11657
	HSK-A 63	18	80	50	38	54	47	11857
	HSK-A 63	20	80	52	40	54	49	12057
	HSK-A 63	25	110	65	45	84	54	12557
	HSK-A 63	32	110	72	52	84	58	13257
	HSK-A 63	40	125	80	60	99	71	14057
	HSK-A 100	6	80	25	15	51	34	10655
	HSK-A 100	8	80	28	20	51	34	10855
	HSK-A 100	10	80	35	25	51	39	11055
	HSK-A 100	12	80	42	30	51	44	11255
	HSK-A 100	14	80	44	32	51	44	11455
	HSK-A 100	16	100	48	36	71	47	11655
	HSK-A 100	18	100	50	38	71	47	11855
	HSK-A 100	20	100	52	40	71	49	12055
	HSK-A 100	25	100	65	45	71	54	12555
HSK-A 100	32	100	72	52	71	58	13255	
HSK-A 100	40	110	80	60	81	68	14055	

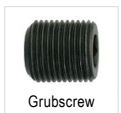

Grubscrew

62 950 ...

Spare parts

DCONWS

6	006
8	008
10	010
12	012
14	012
16	016
18	016
20	020
25	025
32	032
40	032

Cylindrical shank adapter (Weldon)

- ▲ For shanks according to DIN 6535 HB / 1835 B with lateral clamping flat
- ▲ also available with Balluff chip **on request**

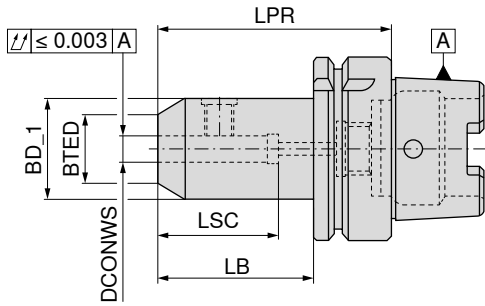

NEW



NEW



G 2,5 n_{max} 25000

G 2,5 n_{max} 25000

82 740 ...

82 741 ...

	Adapter	DCONWS _{H5}	LPR	BTED	BD_1	LB	LSC		
		mm	mm	mm	mm	mm	mm		
short	HSK-A 63	40	120	60	80	94	68		
	HSK-A 63	40	120	60	80	94	68	14057	14057



The M3 screws with WAF 1.5 mm supplied can be used to seal the two additional coolant holes.

Accessories



→ 156



→ 284

Coolant transfer pipe

Others

Accessories can be found in the clamping technology catalogue
→ **Chapter 16, Adapters and accessories**

HAAS/Doosan – BMT 65 – Axial square section tool holder

▲ directly screwed version

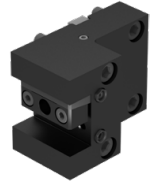
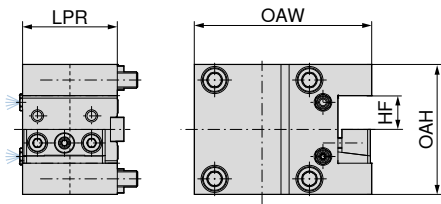

NEW

Left-hand

82 483 ...

Adapter	Hole pattern	HF mm	LPR mm	OAH mm	OAW mm
BMT 65	70 x 73	25	75	97	131

00008

HAAS/Doosan – BMT 65 – Combi tool holder

▲ directly screwed version

▲ double-sided version

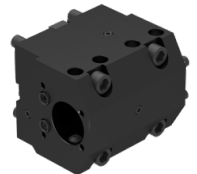
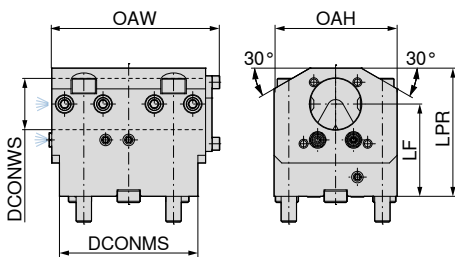

NEW



IC

82 483 ...

Adapter	Hole pattern	DCONWS mm	LF mm	OAH mm	LPR mm	OAW mm	DCONMS mm
BMT 65	70 x 73	40	72	96	106	132	103

03009

CentriClamp – ZSG mini – 6-sided clamping tower

Scope of supply:

6-sided clamping tower incl. ZSG mini L-80 mm without system jaws

**ZSG
mini**

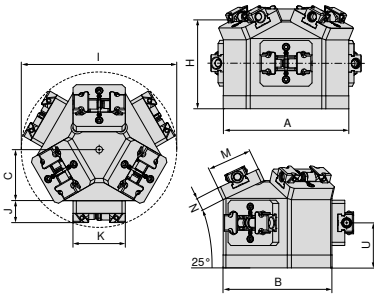

NEW

80 912 ...

A	B	C	H	I	J	K	M	N	U	WT
mm	mm	mm	mm	mm	mm	mm	mm	mm	mm	kg
193,24	169,40	78	135,7	236	33,7	80	70,4	20	70	13,5

55000

Underside dimensions of ZSG mini – 6-sided clamping tower

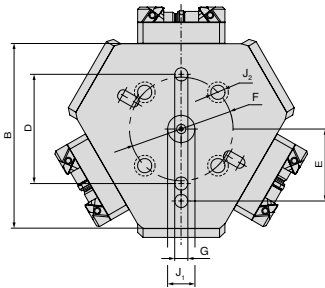

B	D ±0.015	E ±0.015	Ø F	G H7	J1 H7	Ø J2
mm	mm	mm	mm	mm	mm	mm
169,40	100	66	95	12	25	13

MNG mini – 4-sided clamping tower

- ▲ Incl. 4 x MNG mini zero point clamping systems
- ▲ Order mounting bolts separately
- ▲ Material: hard-anodised aluminium

**MNG
mini**

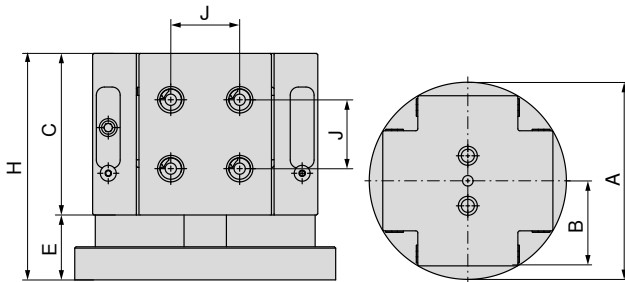

NEW

80 915 ...

A	B	C	E	H	J ± 0.015	WT
mm	mm	mm	mm	mm	mm	kg
197	85	122	49	171	52	12

54000



Suitable for: ESG 5 – 80 L-130 / ZSG 4 – 80 L-130 / ZSG mini – 70 L-80 / ZSG mini – 70 L-100

Underside dimensions of MNG mini – 4-sided clamping tower

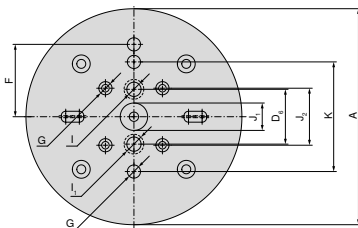

A	D ₆	F ± 0.015	G $H7$	I $H7$	I ₁ $H7$	J ₁ $H7$	J ₂ ± 0.015	K ± 0.015
mm	mm	mm	mm	mm	mm	mm	mm	mm
197	50	66	12	13	19	25	52	100

System accessories overview

Protection plugs

- ▲ Protective cover to shield changeover interface
- ▲ Price per piece

**MNG
mini**



NEW

80 915 ...

D ₁
mm
16

51900

System jaws overview

Insert jaws, round, grip 3 mm

- ▲ Price per piece
- ▲ For adapter jaws **80 914 34000**

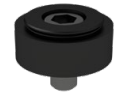
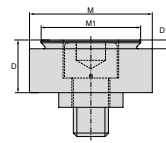

NEW

For vice width	A	A ₁	D	D ₁	D ₂	E	M	M ₁	M ₂		NCG	H5G / -S / -Z	X5G-Z / -S	ESG 4	ESG 5	HDG 2	ZSG 4	ZSG mini	DSG 4	Verso	HSG	
			18	3			42	34		80 914 34500											●	

Indexable jaw, fixed VS, grip 3 mm

- ▲ Price per piece
- ▲ VS = Larger clamping range

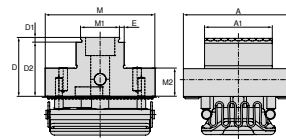

NEW

For vice width	A	A ₁	D	D ₁	D ₂	E	M	M ₁	M ₂		NCG	H5G / -S / -Z	X5G-Z / -S	ESG 4	ESG 5	HDG 2	ZSG 4	ZSG mini	DSG 4	Verso	HSG	
90	65	40	35	3	32	2,6	64	28	17	80 914 34400											●	
90	90		35	3	32	2,6	64	28	17	80 914 34300											●	

Support, hard for milling over

- ▲ Price per piece

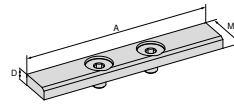

NEW

For vice width	A	A ₁	D	D ₁	D ₂	E	M	M ₁	M ₂		NCG	H5G / -S / -Z	X5G-Z / -S	ESG 4	ESG 5	HDG 2	ZSG 4	ZSG mini	DSG 4	Verso	HSG	
90	40		5,4				15			80 914 51200											●	
90	90		5,4				15			80 914 51100											●	

Sustainability is not a goal, it's a mission.

We have an ambitious sustainability mission that will affect and change the entire supply chain. But we can only achieve true sustainability together. That's why our mission goes beyond our own scope:

We want to enable our customers to produce more sustainably with our products and services. With our ambitious mission, we want to make an important contribution to tackling the climate crisis.



Mission #1:
Climate neutral by 2025



Mission #2:
Minimise the use of
virgin raw materials



cutting.tools/int/en/sustainability

CERATIZIT is a high-technology engineering group specialised in cutting tools and hard material solutions.

Tooling a Sustainable Future

ceratizit.com



CERATIZIT
GROUP

