

Vollbohren und Bohrungsbearbeitung

1 HSS-Bohrer

2 VHM-Bohrer

3 Wendeplattenbohrer

4 Reibahlen und Senker

5 Ausspindelwerkzeuge

Gewindebearbeitung

6 Gewindebohrer und -former

7 Zirkular- und Gewindefräser

8 Gewindedrehwerkzeuge

8

Drehbearbeitung

9 Wendeplattendrehwerkzeuge

10 Multifunktionswerkzeuge –  
EcoCut und FreeTurn

11 Stechwerkzeuge

12 Miniaturdrehwerkzeuge

Fräsbearbeitung

13 HSS-Fräser

14 VHM-Fräser

15 Wendeplattenfräswerkzeuge

Spanntechnik

16 Werkzeugaufnahmen  
und Zubehör

17 Werkstückspannung

18 Materialbeispiele und  
Artikel-Nr.-Verzeichnis

## Inhaltsverzeichnis

Symbolerklärung	5
Toolfinder	4+5
Produktprogramm	6–42
Unterlegplatten	43
Technische Informationen	
Schnittdaten	44+45
Gewindedrehverfahren	46
Steigungswinkel	47
Bezeichnungsschlüssel	48+49
Problembhebung	50
Sortenbeschreibung und Profilerklärung	51

## WNT \ Performance

Premium-Qualitätswerkzeuge für höchste Performance.

Die Premium-Qualitätswerkzeuge aus der Produktlinie **WNT Performance** wurden für spezielle Anwendungen konzipiert und zeichnen sich durch ihre herausragende Leistungsfähigkeit aus. Wenn Sie in Ihrer Fertigung höchste Ansprüche an die Performance stellen und allerbeste Ergebnisse erzielen wollen, dann empfehlen wir Ihnen die Premiumwerkzeuge aus dieser Produktlinie.

## Toolfinder

### MiniCut



Vollprofil  
Teilprofil      Teilprofil      Teilprofil

→ Kapitel 12 – Miniaturdrehwerkzeuge

### UltraMini



Vollprofil  
Teilprofil      Vollprofil  
Teilprofil      Teilprofil      Teilprofil

→ Kapitel 12 – Miniaturdrehwerkzeuge

### VertiClamp

→ Langdrehkatalog

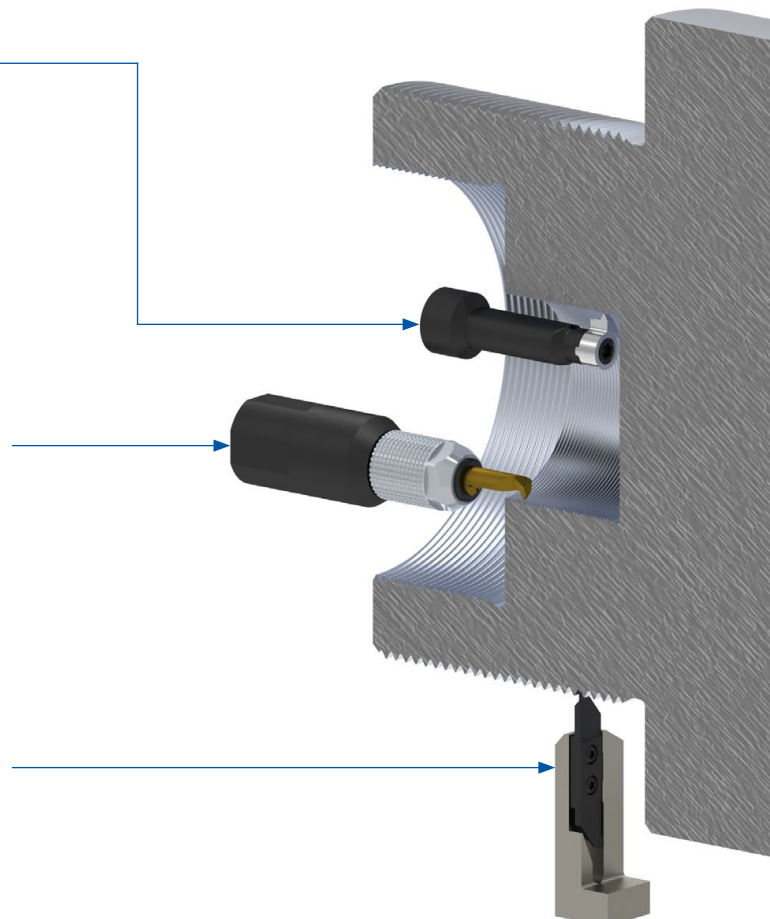

# Symbolerklärung

## Flankenwinkel

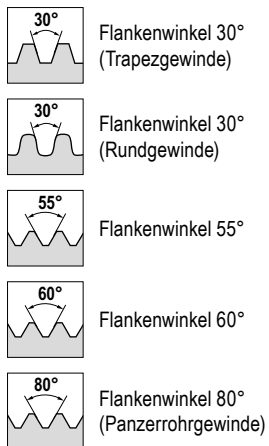

- TP / TPI = Steigung
- NT = Zähnezahl
- = **Hauptanwendung**
- = Nebenanwendung

## Gewinde

<b>M</b>	Metrisches ISO-Regelgewinde DIN 13	<b>UNEF</b>	Amerikanisches Unified-Gewinde (extra fein) BS 1580 (ASME B 1.1)
<b>MF</b>	Metrisches ISO-Feingewinde DIN 13	<b>NPT</b>	Amerikanisches Rohrgewinde ANSI / ASME B 1.20.3
<b>BSW</b>	Britisches Whitworth-Gewinde BS 84	<b>Tr</b>	Trapezgewinde DIN 103
<b>UN</b>	Amerikanisches Unified-Gewinde BS 1580 (ASME B 1.1)	<b>Rd</b>	Rundgewinde DIN 405
<b>UNC</b>	Amerikanisches Unified-Gewinde (grob) BS 1580 (ASME B 1.1)	<b>Pg</b>	Panzerrohr-Gewinde DIN 40430
<b>UNF</b>	Amerikanisches Unified-Gewinde (fein) BS 1580 (ASME B 1.1)		

### Standard-Außen-Gewindedrehen

Vollprofil

<b>M</b>	<b>BSW</b>	<b>UN</b>	<b>UNC</b>	<b>UNF</b>	<b>UNEF</b>	<b>NPT</b>	<b>Tr</b>	<b>Rd</b>	<b>Pg</b>
6+7	11+12	15+16	15+16	15+16	15+16	19	21	24	26

Teilprofil

60°	55°	M
28	30	10

Passende Halter finden Sie auf → Seite 32+33

### Standard-Innen-Gewindedrehen

Vollprofil

<b>M</b>	<b>BSW</b>	<b>UN</b>	<b>UNC</b>	<b>UNF</b>	<b>UNEF</b>	<b>NPT</b>	<b>Tr</b>	<b>Rd</b>	<b>Pg</b>
8+9	13+14	17+18	17+18	17+18	17+18	20	22	25	27

Teilprofil

60°	55°
29	31

Passende Halter finden Sie auf → Seite 34–36

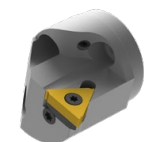

### Innen-Gewindedrehen mit MaxiChange – unserem Wechselkopfsystem

→ Kapitel 9 – Wendeplattendrehwerkzeuge

### Mini 06

Vollprofil

<b>M</b>	<b>BSW</b>	<b>M</b>
37	37	39

Teilprofil

60°	55°	60°	55°
38	38	39+40	40+41

Passende Halter finden Sie auf → Seite 42



Informationen zu den verschiedenen Gewindeprofilen finden Sie auf → Seite 51.

# Rechte Außengewindedrehplatte

▲ Vollprofil

▲ Sorte CCN7525 für universellen Einsatz mit gesintertem Spanbrecher

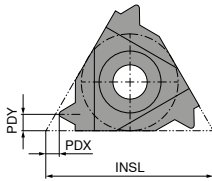
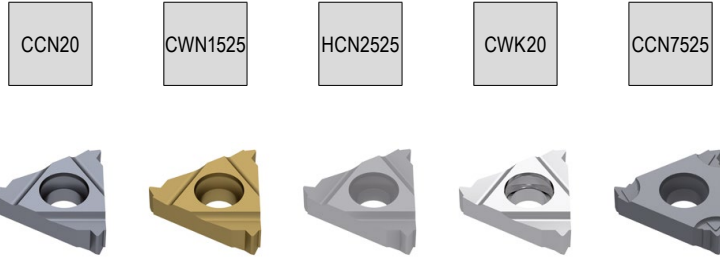

Bezeichnung	TP mm	INSL mm	PDX mm	PDY mm	ER 71 220 ...		ER 71 220 ...		ER 71 220 ...		ER 71 220 ...		ER 71 220 ...	
					EUR X3		EUR X3		EUR X3		EUR Y1		EUR X3	
11 ER 0,35	0,35	11	0,8	0,4	23,72	204								
11 ER 0,4	0,40	11	0,7	0,4	23,72	206								
11 ER 0,45	0,45	11	0,7	0,4	23,72	208								
11 ER 0,5	0,50	11	0,6	0,6	23,72	209								
11 ER 0,6	0,60	11	0,6	0,6	23,72	210								
11 ER 0,7	0,70	11	0,6	0,6	23,72	211								
11 ER 0,75	0,75	11	0,6	0,6	23,72	212								
11 ER 0,8	0,80	11	0,6	0,6	23,72	213								
11 ER 1,0	1,00	11	0,7	0,7	22,17	214								
11 ER 1,25	1,25	11	0,8	0,9	22,17	216								
11 ER 1,5	1,50	11	0,8	1,0	22,17	218								
11 ER 1,75	1,75	11	0,8	1,1	22,17	220								
16 ER 0,35	0,35	16	0,8	0,4	23,72	234		28,84	734	15,49	634			
16 ER 0,4	0,40	16	0,7	0,4	23,72	236		28,84	736	15,49	636			
16 ER 0,45	0,45	16	0,7	0,4	23,72	238				15,49	638			
16 ER 0,5	0,50	16	0,6	0,6	23,72	240	19,91	140	21,87	740	15,49	640	21,87	940
16 ER 0,7	0,70	16	0,6	0,6	23,72	241	21,32	141	23,16	741	15,49	641		
16 ER 0,75	0,75	16	0,6	0,6	23,72	242	19,91	142	21,87	742	15,49	642	21,87	942
16 ER 0,8	0,80	16	0,6	0,6	23,72	243	19,91	143	21,87	743	15,49	643	21,87	943
16 ER 1,0	1,00	16	0,7	0,7	22,17	244	19,19	144	21,32	744	13,98	644	21,32	944
16 ER 1,25	1,25	16	0,8	0,9	22,17	246	19,19	146	21,32	746	13,98	646	21,32	946
16 ER 1,5	1,50	16	0,8	1,0	22,17	248	19,19	148	21,32	748	13,98	648	21,32	948
16 ER 1,75	1,75	16	0,9	1,2	22,17	250	19,19	150	21,32	750	13,98	650		
16 ER 2,0	2,00	16	1,0	1,3	22,17	252	19,19	152	21,32	752	13,98	652	21,32	952
16 ER 2,5	2,50	16	1,1	1,5	22,17	254	19,19	154	21,32	754	13,98	654	21,32	954
16 ER 3,0	3,00	16	1,2	1,6	22,17	256	19,19	156	21,32	756	13,98	656	21,32	956
22 ER 3,5	3,50	22	1,6	2,3	33,24	270	29,84	170	32,82	770				
22 ER 4,0	4,00	22	1,6	2,3	33,24	272	31,40	172	33,96	772				
22 ER 4,5	4,50	22	1,7	2,4	33,24	274	33,66	174	36,63	774				
22 ER 5,0	5,00	22	1,7	2,5	33,24	276	33,66	176	36,63	776				
22 ER 5,5	5,50	22	1,7	2,6			33,66	178						
22 ER 5,5	5,50	22	1,9	2,7	33,24	278								
22 EN 5,5	5,50	22	2,3	11,0	41,91	282 <sup>1)</sup>								
22 ER 6,0	6,00	22	1,9	2,7			33,66	180	36,63	780				
22 ER 6,0	6,00	22	2,0	2,9	33,24	280								
22 EN 6,0	6,00	22	2,6	11,0	41,91	284 <sup>1)</sup>								
P						●		●		○				●
M						●		○		●		○		●
K						●		●		○		●		●
N								●		○		●		
S						○				○		○		●
H						○				○				○
O								○						

1) Ausführung neutral (N) – für Rechts- und Linksgewindeherstellung einsetzbar. Neutraler Klemmhalter mit Kennzeichnung (U) erforderlich.

# Linke Außengewindedrehplatte

▲ Vollprofil

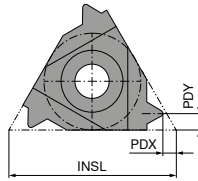
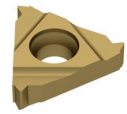
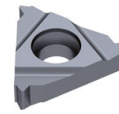

Bezeichnung	TP mm	INSL mm	PDX mm	PDY mm	EL	
					71 222 ... EUR X3	71 222 ... EUR X3
11 EL 0,35	0,35	11	0,8	0,4	23,72	204
11 EL 0,4	0,40	11	0,7	0,4	23,72	206
11 EL 0,45	0,45	11	0,7	0,4	23,72	208
11 EL 0,5	0,50	11	0,6	0,6	23,72	209
11 EL 0,6	0,60	11	0,6	0,6	23,72	210
11 EL 0,7	0,70	11	0,6	0,6	23,72	211
11 EL 0,75	0,75	11	0,6	0,6	23,72	212
11 EL 0,8	0,80	11	0,6	0,6	23,72	213
11 EL 1,0	1,00	11	0,7	0,7	22,17	214
11 EL 1,25	1,25	11	0,8	0,9	22,17	216
11 EL 1,5	1,50	11	0,8	1,0	22,17	218
11 EL 1,75	1,75	11	0,8	1,1	22,17	220
16 EL 0,35	0,35	16	0,8	0,4	23,72	234
16 EL 0,4	0,40	16	0,7	0,4	23,72	236
16 EL 0,45	0,45	16	0,7	0,4	23,72	238
16 EL 0,5	0,50	16	0,6	0,6	23,72	240
16 EL 0,7	0,70	16	0,6	0,6	23,72	241
16 EL 0,75	0,75	16	0,6	0,6	23,72	242
16 EL 0,8	0,80	16	0,6	0,6	23,72	243
16 EL 1,0	1,00	16	0,7	0,7	22,17	244
16 EL 1,25	1,25	16	0,8	0,9	22,17	246
16 EL 1,5	1,50	16	0,8	1,0	22,17	248
16 EL 1,75	1,75	16	0,9	1,2	22,17	250
16 EL 2,0	2,00	16	1,0	1,3	22,17	252
16 EL 2,5	2,50	16	1,1	1,5	22,17	254
16 EL 3,0	3,00	16	1,2	1,6	22,17	256
22 EL 3,5	3,50	22	1,6	2,3	33,24	270
22 EL 4,0	4,00	22	1,6	2,3	33,24	272
22 EL 4,5	4,50	22	1,7	2,4	33,24	274
22 EL 5,0	5,00	22	1,7	2,5	33,24	276
22 EL 5,5	5,50	22	1,9	2,7	33,24	278
22 EL 6,0	6,00	22	2,0	2,9	33,24	280

P	●	●
M	●	○
K	●	●
N		●
S	○	
H	○	
O		○

→ v. Seite 45

# Rechte Innengewindedrehplatte

▲ Vollprofil

▲ Sorte CCN7525 für universellen Einsatz mit gesintertem Spanbrecher

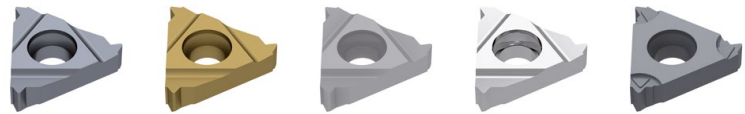
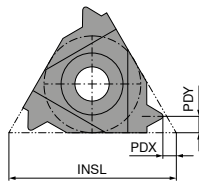
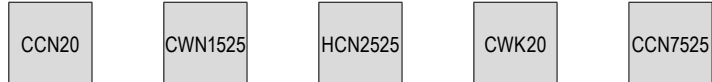

Bezeichnung	TP mm	INSL mm	PDX mm	PDY mm	IR 71 224 ...		IR 71 224 ...		IR 71 224 ...		IR 71 224 ...		IR 71 224 ...	
					EUR X3		EUR X3		EUR X3		EUR Y1		EUR X3	
11 IR 0,35	0,35	11	0,8	0,3	23,72	204								
11 IR 0,4	0,40	11	0,8	0,4	23,72	206								
11 IR 0,45	0,45	11	0,8	0,4	23,72	208								
11 IR 0,5	0,50	11	0,6	0,6	23,72	210								
11 IR 0,7	0,70	11	0,6	0,6	23,72	211								
11 IR 0,75	0,75	11	0,6	0,6	23,72	212							26,16	912
11 IR 0,8	0,80	11	0,6	0,6	23,72	213			29,55	713			21,32	914
11 IR 1,0	1,00	11	0,6	0,6										
11 IR 1,0	1,00	11	0,6	0,7	22,17	214	19,19	114	21,32	714				
11 IR 1,25	1,25	11	0,8	0,9	22,17	216								
11 IR 1,5	1,50	11	0,8	0,9									21,32	918
11 IR 1,5	1,50	11	0,8	1,0	22,17	218	19,19	118	21,32	718				
11 IR 1,75	1,75	11	0,9	1,1	22,17	220								
11 IR 2,0	2,00	11	0,8	0,9			19,19	122	21,32	722				
11 IR 2,0	2,00	11	0,9	1,1	22,17	222								
11 IR 2,5	2,50	11	0,8	1,2			21,75	124	23,72	724				
11 IR 2,5	2,50	11	0,9	1,1	22,17	224								
16 IR 0,35	0,35	16	0,8	0,4	23,72	234					15,49	634		
16 IR 0,4	0,40	16	0,7	0,4	23,72	236					15,49	636		
16 IR 0,45	0,45	16	0,7	0,4	23,72	238					15,49	638		
16 IR 0,5	0,50	16	0,6	0,6	23,72	240					15,49	640		
16 IR 0,7	0,70	16	0,6	0,6	23,72	241					15,49	641		
16 IR 0,75	0,75	16	0,6	0,6	23,72	242	23,99	142	26,16	742	15,49	642		
16 IR 0,8	0,80	16	0,6	0,6	23,72	243					15,49	643		
16 IR 1,0	1,00	16	0,6	0,7			19,19	144	21,32	744			21,32	944
16 IR 1,0	1,00	16	0,7	0,7	22,17	244					13,98	644		
16 IR 1,25	1,25	16	0,8	0,9	22,17	246			22,30	746	13,98	646	22,30	946
16 IR 1,5	1,50	16	0,8	1,0	22,17	248	19,19	148	21,32	748	13,98	648	21,32	948
16 IR 1,75	1,75	16	0,9	1,2	22,17	250			26,16	750	13,98	650		
16 IR 2,0	2,00	16	1,0	1,3	22,17	252	19,19	152	21,32	752	13,98	652	21,32	952
16 IR 2,5	2,50	16	1,1	1,5	22,17	254	19,19	154	21,32	754	13,98	654	21,32	954
16 IR 3,0	3,00	16	1,1	1,5	22,17	256	19,19	156	21,32	756	13,98	656	21,32	956
22 IR 3,5	3,50	22	1,6	2,3	33,24	270	31,40	170	33,96	770				
22 IR 4,0	4,00	22	1,6	2,3	33,24	272	31,40	172	33,96	772				
22 IR 4,5	4,50	22	1,6	2,4			33,66	174	36,63	774				
22 IR 4,5	4,50	22	1,7	2,4	33,24	274								
22 IR 5,0	5,00	22	1,6	2,3			33,66	176						
22 IR 5,0	5,00	22	1,7	2,5	33,24	276								
22 IR 5,5	5,50	22	1,6	2,3			34,10	178						
22 IR 5,5	5,50	22	1,9	2,7	33,24	278								
22 IN 5,5	5,50	22	2,3	11,0	41,91	282 <sup>1)</sup>								
22 IR 6,0	6,00	22	1,6	2,4			33,66	180						
22 IR 6,0	6,00	22	2,0	2,9	33,24	280								
22 IN 6,0	6,00	22	2,6	11,0	41,91	284 <sup>1)</sup>								
P					●		●		○				●	
M					●		○		●		○		●	
K					●		●		○		●		●	
N							●		○		●			
S					○				○		○		●	
H					○				○				○	
O								○						

1) Ausführung neutral (N) – für Rechts- und Linksgewindeherstellung einsetzbar. Neutraler Klemmhalter mit Kennzeichnung (U) erforderlich.

# Linke Innengewindedrehplatte

▲ Vollprofil

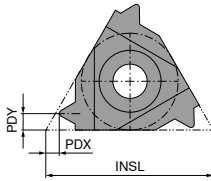
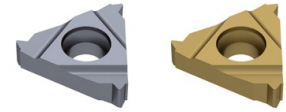

Bezeichnung	TP mm	INSL mm	PDX mm	PDY mm	IL	
					71 226 ... EUR X3	71 226 ... EUR X3
11 IL 0,35	0,35	11	0,8	0,3	23,72	204
11 IL 0,4	0,40	11	0,8	0,4	23,72	206
11 IL 0,45	0,45	11	0,8	0,4	23,72	208
11 IL 0,5	0,50	11	0,6	0,6	23,72	210
11 IL 0,7	0,70	11	0,6	0,6	23,72	211
11 IL 0,75	0,75	11	0,6	0,6	23,72	212
11 IL 0,8	0,80	11	0,6	0,6	23,72	213
11 IL 1,0	1,00	11	0,6	0,7	22,17	214
11 IL 1,25	1,25	11	0,8	0,9	22,17	216
11 IL 1,5	1,50	11	0,8	1,0	22,17	218
11 IL 1,75	1,75	11	0,9	1,1	22,17	220
11 IL 2,0	2,00	11	0,9	1,1	22,17	222
11 IL 2,5	2,50	11	0,9	1,1	22,17	224
16 IL 0,35	0,35	16	0,8	0,4	23,72	234
16 IL 0,4	0,40	16	0,7	0,4	23,72	236
16 IL 0,45	0,45	16	0,7	0,4	23,72	238
16 IL 0,5	0,50	16	0,6	0,6	23,72	240
16 IL 0,7	0,70	16	0,6	0,6	23,72	241
16 IL 0,75	0,75	16	0,6	0,6	23,72	242
16 IL 0,8	0,80	16	0,6	0,6	23,72	243
16 IL 1,0	1,00	16	0,6	0,7		
16 IL 1,0	1,00	16	0,7	0,7	22,17	244
16 IL 1,25	1,25	16	0,8	0,9	22,17	246
16 IL 1,5	1,50	16	0,8	1,0	22,17	248
16 IL 1,75	1,75	16	0,9	1,2	22,17	250
16 IL 2,0	2,00	16	1,0	1,3	22,17	252
16 IL 2,5	2,50	16	1,1	1,5	22,17	254
16 IL 3,0	3,00	16	1,2	1,6	22,17	256
22 IL 3,5	3,50	22	1,6	2,3	41,63	270
22 IL 4,0	4,00	22	1,6	2,3	41,63	272
22 IL 4,5	4,50	22	1,7	2,4	41,63	274
22 IL 5,0	5,00	22	1,7	2,5	41,63	276
22 IL 5,5	5,50	22	1,9	2,7	41,63	278
22 IL 6,0	6,00	22	2,0	2,9	41,63	280
P					●	●
M					●	○
K					●	●
N						●
S					○	
H					○	
O						○

8

→ v. Seite 45



# Rechte Außengewindedrehplatte

▲ Mehrzahlplatten

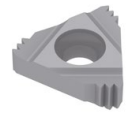
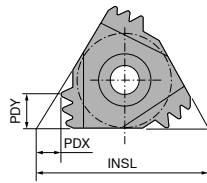

ER

**71 221 ...**

EUR  
X3

Bezeichnung	TP mm	INSL mm	PDX mm	PDY mm	NT
16 ER 1,0 3M	1,0	16	1,7	2,5	3
16 ER 1,5 2M	1,5	16	1,5	2,3	2

700  
702

P	○
M	●
K	○
N	○
S	○
H	○
O	○

→ v<sub>c</sub> Seite 45

# Rechte Außengewindedrehplatte

▲ Vollprofil

▲ Sorte CCN7525 für universellen Einsatz mit gesintertem Spanbrecher

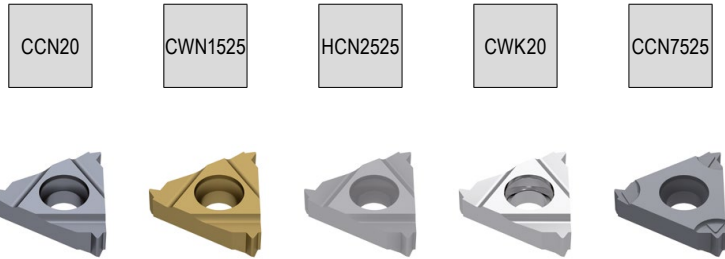
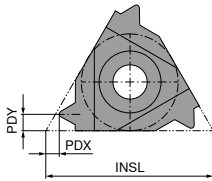

Bezeichnung	TPI 1/"	INSL mm	PDX mm	PDY mm	ER 71 228 ...		ER 71 228 ...		ER 71 228 ...		ER 71 228 ...		ER 71 228 ...	
					EUR X3		EUR X3		EUR X3		EUR Y1		EUR X3	
11 ER 72	72,0	11	0,7	0,4	27,97	202								
11 ER 60	60,0	11	0,7	0,4	27,97	204								
11 ER 56	56,0	11	0,7	0,4	27,97	206								
11 ER 48	48,0	11	0,6	0,6	27,97	208								
11 ER 40	40,0	11	0,6	0,6	27,97	210								
11 ER 36	36,0	11	0,6	0,6	27,97	212								
11 ER 32	32,0	11	0,6	0,6	27,97	214								
11 ER 28	28,0	11	0,6	0,7	25,71	216								
11 ER 26	26,0	11	0,7	0,8	25,71	218								
11 ER 24	24,0	11	0,7	0,8	25,71	220								
11 ER 22	22,0	11	0,8	0,9	25,71	222								
11 ER 20	20,0	11	0,8	0,9	25,71	224								
11 ER 19	19,0	11	0,8	1,0	25,71	226								
11 ER 18	18,0	11	0,8	1,0	25,71	228								
11 ER 16	16,0	11	0,9	1,1	25,71	230								
11 ER 14	14,0	11	0,9	1,1	25,71	232								
16 ER 40	40,0	16	0,6	0,6	27,97	240					18,19	640		
16 ER 36	36,0	16	0,6	0,6	27,97	242					18,19	642		
16 ER 32	32,0	16	0,6	0,6	27,97	244					18,19	644		
16 ER 28	28,0	16	0,6	0,7	25,71	246	24,71	146	26,99	746	16,76	646		
16 ER 26	26,0	16	0,7	0,7					30,11	748				
16 ER 26	26,0	16	0,7	0,8	25,71	248					16,76	648		
16 ER 24	24,0	16	0,7	0,8	25,71	250					16,76	650		
16 ER 22	22,0	16	0,8	0,9	25,71	252					16,76	652		
16 ER 20	20,0	16	0,8	0,9	25,71	254			30,11	754	16,76	654		
16 ER 19	19,0	16	0,8	1,0	25,71	256	22,17	156	24,44	756	16,76	656	24,44	956
16 ER 18	18,0	16	0,8	1,0	25,71	258					16,76	658		
16 ER 16	16,0	16	0,9	1,1	25,71	260	27,42	160	29,40	760	16,76	660		
16 ER 14	14,0	16	1,0	1,2	25,71	262	22,17	162	24,44	762	16,76	662	24,44	962
16 ER 12	12,0	16	1,1	1,4	25,71	264	27,42	164	29,40	764	16,76	664		
16 ER 11	11,0	16	1,1	1,5	25,71	266	22,17	166	24,44	766	16,76	666	24,44	966
16 ER 10	10,0	16	1,1	1,5	25,71	268					16,76	668		
16 ER 9	9,0	16	1,2	1,7	25,71	270					16,76	670		
16 ER 8	8,0	16	1,2	1,5	25,71	272					16,76	672		
22 ER 7	7,0	22	1,6	2,3	39,76	280								
22 ER 6	6,0	22	1,6	2,3	39,76	282								
22 ER 5	5,0	22	1,7	2,4	39,76	284								
22 EN 4,5	4,5	22	2,3	11,0	42,76	290 <sup>1)</sup>								
22 EN 4	4,0	22	1,8	11,0	42,76	292 <sup>1)</sup>								
P						●	●	○				●		
M						●	○	●	○		●	●		
K						●	●	○	●		●	●		
N							●	○			●			
S						○		○	○		○		●	
H						○		○					○	
O							○							

1) Ausführung neutral (N) – für Rechts- und Linksgewindeherstellung einsetzbar. Neutraler Klemmhalter mit Kennzeichnung (U) erforderlich.

# Linke Außengewindedrehplatte

▲ Vollprofil

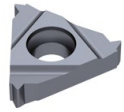
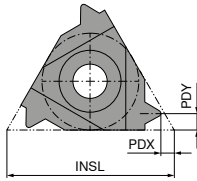

EL

71 229 ...

Bezeichnung	TPI 1/"	INSL mm	PDX mm	PDY mm	EL	
					EUR X3	
11 EL 72	72	11	0,7	0,4	32,11	202
11 EL 60	60	11	0,7	0,4	32,11	204
11 EL 56	56	11	0,7	0,4	32,11	206
11 EL 48	48	11	0,6	0,6	32,11	208
11 EL 40	40	11	0,6	0,6	32,11	210
11 EL 36	36	11	0,6	0,6	32,11	212
11 EL 32	32	11	0,6	0,6	32,11	214
11 EL 28	28	11	0,6	0,7	30,11	216
11 EL 26	26	11	0,7	0,8	30,11	218
11 EL 24	24	11	0,7	0,8	30,11	220
11 EL 22	22	11	0,8	0,9	30,11	222
11 EL 20	20	11	0,8	0,9	30,11	224
11 EL 19	19	11	0,8	1,0	30,11	226
11 EL 18	18	11	0,8	1,0	30,11	228
11 EL 16	16	11	0,9	1,1	30,11	230
11 EL 14	14	11	0,9	1,1	25,71	232
16 EL 40	40	16	0,6	0,6	32,11	240
16 EL 36	36	16	0,6	0,6	32,11	242
16 EL 32	32	16	0,6	0,6	32,11	244
16 EL 28	28	16	0,6	0,7	30,11	246
16 EL 26	26	16	0,7	0,8	30,11	248
16 EL 24	24	16	0,7	0,8	30,11	250
16 EL 22	22	16	0,8	0,9	30,11	252
16 EL 20	20	16	0,8	0,9	30,11	254
16 EL 19	19	16	0,8	1,0	30,11	256
16 EL 18	18	16	0,8	1,0	30,11	258
16 EL 16	16	16	0,9	1,1	30,11	260
16 EL 14	14	16	1,0	1,2	25,71	262
16 EL 12	12	16	1,1	1,4	30,11	264
16 EL 11	11	16	1,1	1,5	25,71	266
16 EL 10	10	16	1,1	1,5	34,38	268
16 EL 9	9	16	1,2	1,7	34,38	270
16 EL 8	8	16	1,2	1,5	34,38	272
22 EL 7	7	22	1,6	2,3	46,59	280
22 EL 6	6	22	1,6	2,3	46,59	282
22 EL 5	5	22	1,7	2,4	47,60	284

P	●
M	●
K	●
N	
S	○
H	○
O	

→ v, Seite 45

# Rechte Innengewindedrehplatte

▲ Vollprofil

▲ Sorte CCN7525 für universellen Einsatz mit gesintertem Spanbrecher

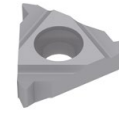
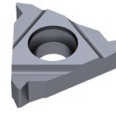
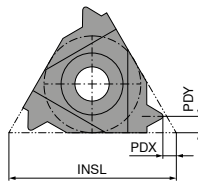

Bezeichnung	TPI	INSL mm	PDX mm	PDY mm	IR 71 230 ...		IR 71 230 ...		IR 71 230 ...		IR 71 230 ...	
					EUR X3		EUR X3		EUR X3		EUR X3	
11 IR 48	48	11	0,6	0,6	27,97	206						
11 IR 40	40	11	0,6	0,6	27,97	208						
11 IR 36	36	11	0,6	0,6	27,97	210						
11 IR 32	32	11	0,6	0,6	27,97	212						
11 IR 28	28	11	0,6	0,7	25,71	214						
11 IR 26	26	11	0,7	0,8	25,71	216						
11 IR 24	24	11	0,7	0,8	25,71	218						
11 IR 22	22	11	0,8	0,9	25,71	220						
11 IR 20	20	11	0,8	0,9	25,71	222						
11 IR 19	19	11	0,8	1,0	25,71	224	23,60	124	25,86	724		
11 IR 19	19	11	0,8	0,9							25,86	924
11 IR 18	18	11	0,8	1,0	25,71	226						
11 IR 16	16	11	0,9	1,1	25,71	228						
11 IR 14	14	11	0,9	1,1	25,71	230	23,60	130	25,86	730		
11 IR 14	14	11	0,8	0,9							25,86	930
16 IR 40	40	16	0,6	0,6	27,97	240						
16 IR 36	36	16	0,6	0,6	27,97	242						
16 IR 32	32	16	0,6	0,6	27,97	244						
16 IR 28	28	16	0,6	0,7	25,71	246						
16 IR 26	26	16	0,7	0,8	25,71	248						
16 IR 24	24	16	0,7	0,8	25,71	250						
16 IR 22	22	16	0,8	0,9	25,71	252						
16 IR 20	20	16	0,8	0,9	25,71	254						
16 IR 19	19	16	0,8	1,0	25,71	256						
16 IR 18	18	16	0,8	1,0	25,71	258						
16 IR 16	16	16	0,9	1,1	25,71	260						
16 IR 14	14	16	1,0	1,2	25,71	262	22,17	162	30,11	760	24,44	962
16 IR 12	12	16	1,1	1,4	25,71	264			24,44	762		
16 IR 11	11	16	1,1	1,5	25,71	266	22,17	166	24,44	766	24,44	966
16 IR 10	10	16	1,1	1,5	25,71	268						
16 IR 9	9	16	1,2	1,7	25,71	270						
16 IR 8	8	16	1,2	1,5	25,71	272						
22 IR 7	7	22	1,6	2,3	40,22	280						
22 IR 6	6	22	1,6	2,3	40,22	282						
22 IR 5	5	22	1,7	2,4	40,22	284						
P					●	●	○	●	○	●	○	●
M					●	○	●	●	○	●	○	●
K					●	●	○	○	○	○	○	○
N							●	○	○	○	○	○
S					○	○	○	○	○	○	○	○
H					○	○	○	○	○	○	○	○
O							○					

→ v<sub>c</sub> Seite 45

# Linke Innengewindedrehplatte

▲ Vollprofil

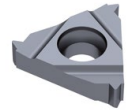
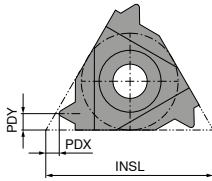

IL  
**71 231 ...**

Bezeichnung	TPI 1/"	INSL mm	PDX mm	PDY mm	EUR	
					X3	
11 IL 48	48	11	0,6	0,6	32,11	206
11 IL 40	40	11	0,6	0,6	32,11	208
11 IL 36	36	11	0,6	0,6	30,11	210
11 IL 32	32	11	0,6	0,6	30,11	212
11 IL 28	28	11	0,6	0,7	30,11	214
11 IL 26	26	11	0,7	0,8	30,11	216
11 IL 24	24	11	0,7	0,8	30,11	218
11 IL 22	22	11	0,8	0,9	30,11	220
11 IL 20	20	11	0,8	0,9	30,11	222
11 IL 19	19	11	0,8	1,0	30,11	224
11 IL 18	18	11	0,8	1,0	30,11	226
11 IL 16	16	11	0,9	1,1	30,11	228
11 IL 14	14	11	0,9	1,1	25,71	230
16 IL 40	40	16	0,6	0,6	32,11	240
16 IL 36	36	16	0,6	0,6	32,11	242
16 IL 32	32	16	0,6	0,6	32,11	244
16 IL 28	28	16	0,6	0,7	30,11	246
16 IL 26	26	16	0,7	0,8	30,11	248
16 IL 24	24	16	0,7	0,8	30,11	250
16 IL 22	22	16	0,8	0,9	30,11	252
16 IL 20	20	16	0,8	0,9	30,11	254
16 IL 19	19	16	0,8	1,0	30,11	256
16 IL 18	18	16	0,8	1,0	30,11	258
16 IL 16	16	16	0,9	1,1	30,11	260
16 IL 14	14	16	1,0	1,2	25,71	262
16 IL 12	12	16	1,1	1,4	30,11	264
16 IL 11	11	16	1,1	1,5	25,71	266
16 IL 10	10	16	1,1	1,5	34,38	268
16 IL 9	9	16	1,2	1,7	34,38	270
16 IL 8	8	16	1,2	1,5	34,38	272
22 IL 7	7	22	1,6	2,3	46,59	280
22 IL 6	6	22	1,6	2,3	46,59	282
22 IL 5	5	22	1,7	2,4	46,59	284

P	●
M	●
K	●
N	
S	○
H	○
O	

→ v. Seite 45

# Rechte Außengewindedrehplatte

▲ Vollprofil

▲ Sorte CCN7525 für universellen Einsatz mit gesintertem Spanbrecher

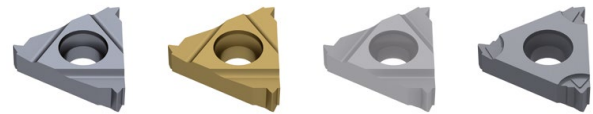
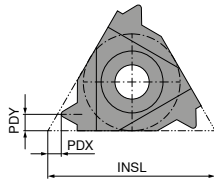

Bezeichnung	TPI 1/''	INSL mm	PDX mm	PDY mm	ER 71 264 ...		ER 71 264 ...		ER 71 264 ...		ER 71 264 ...	
					EUR X3		EUR X3		EUR X3		EUR X3	
11 ER 72	72,0	11	0,8	0,4	28,13	202						
11 ER 64	64,0	11	0,8	0,4	28,13	204						
11 ER 56	56,0	11	0,7	0,4	28,13	206						
11 ER 48	48,0	11	0,6	0,6	28,13	208						
11 ER 44	44,0	11	0,6	0,6	28,13	210						
11 ER 40	40,0	11	0,6	0,6	28,13	212						
11 ER 36	36,0	11	0,6	0,6	28,13	214						
11 ER 32	32,0	11	0,6	0,6	28,13	216						
11 ER 28	28,0	11	0,6	0,7	25,71	218						
11 ER 27	27,0	11	0,7	0,8	25,71	220						
11 ER 24	24,0	11	0,7	0,8	25,71	222						
11 ER 20	20,0	11	0,8	0,9	25,71	224						
11 ER 18	18,0	11	0,8	1,0	25,71	226						
11 ER 16	16,0	11	0,9	1,1	25,71	228						
11 ER 14	14,0	11	0,9	1,1	25,71	230						
16 ER 72	72,0	16	0,8	0,4	27,97	232						
16 ER 64	64,0	16	0,8	0,4	27,97	234						
16 ER 56	56,0	16	0,7	0,4	27,97	236						
16 ER 48	48,0	16	0,6	0,6	27,97	238						
16 ER 44	44,0	16	0,6	0,6	27,97	240						
16 ER 40	40,0	16	0,6	0,6	27,97	242						
16 ER 36	36,0	16	0,6	0,6	27,97	244						
16 ER 32	32,0	16	0,6	0,6	27,97	246			31,68	746		
16 ER 28	28,0	16	0,6	0,7	25,71	248			29,40	748		
16 ER 27	27,0	16	0,7	0,8	25,71	250						
16 ER 24	24,0	16	0,7	0,8	25,71	252	24,71	152	26,99	752		
16 ER 20	20,0	16	0,8	0,9	25,71	254	23,60	154	25,86	754	25,86	954
16 ER 18	18,0	16	0,8	1,0	25,71	256	24,71	156	26,99	756		
16 ER 16	16,0	16	0,9	1,1	25,71	258	23,60	158	25,86	758	25,86	958
16 ER 14	14,0	16	1,0	1,2	25,71	260	24,71	160	26,99	760		
16 ER 13	13,0	16	1,0	1,3	25,71	262						
16 ER 12	12,0	16	1,1	1,4	25,71	264	24,71	164	26,99	764		
16 ER 11,5	11,5	16	1,1	1,5	25,71	266						
16 ER 11	11,0	16	1,1	1,5	25,71	268	28,13	168				
16 ER 10	10,0	16	1,1	1,5	25,71	270						
16 ER 9	9,0	16	1,2	1,7	25,71	272						
16 ER 8	8,0	16	1,2	1,6	25,71	274						
16 ER 8	8,0	16	1,1	1,1							30,11	974
16 ER 8	8,0	16	1,1	1,5			28,13	174				
22 ER 7	7,0	22	1,6	2,3	40,22	276						
22 ER 6	6,0	22	1,6	2,3	40,22	278						
22 ER 5	5,0	22	1,7	2,5	40,22	280						
22 EN 4,5	4,5	22	2,0	11,0	42,76	282 <sup>1)</sup>						
22 EN 4	4,0	22	2,0	11,0	42,76	284 <sup>1)</sup>						
P					●		●		○		●	
M					●		○		●		●	
K					●		●		○		●	
N							●		○			
S					○				○		●	
H					○				○		○	
O									○			

1) Ausführung neutral (N) – für Rechts- und Linksgewindeherstellung einsetzbar. Neutraler Klemmhalter mit Kennzeichnung (U) erforderlich.

# Linke Außengewindedrehplatte

▲ Vollprofil



CCN20

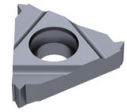
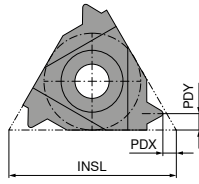

EL

71 266 ...

Bezeichnung	TPI 1/"	INSL mm	PDX mm	PDY mm	EUR	
					X3	
11 EL 72	72,0	11	0,8	0,4	32,94	202
11 EL 64	64,0	11	0,8	0,4	32,94	204
11 EL 56	56,0	11	0,7	0,4	32,94	206
11 EL 48	48,0	11	0,6	0,6	32,94	208
11 EL 44	44,0	11	0,6	0,6	32,94	210
11 EL 40	40,0	11	0,6	0,6	32,94	212
11 EL 36	36,0	11	0,6	0,6	32,94	214
11 EL 32	32,0	11	0,6	0,6	32,94	216
11 EL 28	28,0	11	0,6	0,7	32,94	218
11 EL 27	27,0	11	0,7	0,8	32,94	220
11 EL 24	24,0	11	0,7	0,8	32,94	222
11 EL 20	20,0	11	0,8	0,9	32,94	224
11 EL 18	18,0	11	0,8	1,0	32,94	226
11 EL 16	16,0	11	0,9	1,1	32,94	228
11 EL 14	14,0	11	0,9	1,1	32,94	230
16 EL 72	72,0	16	0,8	0,4	32,11	232
16 EL 64	64,0	16	0,8	0,4	32,11	234
16 EL 56	56,0	16	0,7	0,4	32,11	236
16 EL 48	48,0	16	0,6	0,6	32,11	238
16 EL 44	44,0	16	0,6	0,6	32,11	240
16 EL 40	40,0	16	0,6	0,6	32,11	242
16 EL 36	36,0	16	0,6	0,6	32,11	244
16 EL 32	32,0	16	0,6	0,6	32,11	246
16 EL 28	28,0	16	0,6	0,7	30,11	248
16 EL 27	27,0	16	0,7	0,8	30,11	250
16 EL 24	24,0	16	0,7	0,8	30,11	252
16 EL 20	20,0	16	0,8	0,9	30,11	254
16 EL 18	18,0	16	0,8	1,0	30,11	256
16 EL 16	16,0	16	0,9	1,1	30,11	258
16 EL 14	14,0	16	1,0	1,2	30,11	260
16 EL 13	13,0	16	1,0	1,3	30,11	262
16 EL 12	12,0	16	1,1	1,4	25,71	264
16 EL 11,5	11,5	16	1,1	1,5	34,38	266
16 EL 11	11,0	16	1,1	1,5	34,38	268
16 EL 10	10,0	16	1,1	1,5	34,38	270
16 EL 9	9,0	16	1,2	1,7	34,38	272
16 EL 8	8,0	16	1,2	1,6	34,38	274
22 EL 7	7,0	22	1,6	2,3	46,59	276
22 EL 6	6,0	22	1,6	2,3	46,59	278
22 EL 5	5,0	22	1,7	2,5	46,59	280

P	●
M	●
K	●
N	
S	○
H	○
O	

→ v<sub>c</sub> Seite 45

# Rechte Innengewindedrehplatte

▲ Vollprofil

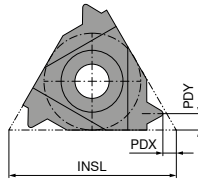
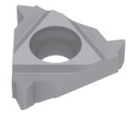
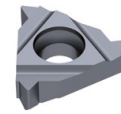

Bezeichnung	TPI 1/"	INSL mm	PDX mm	PDY mm	IR	
					71 268 ... EUR X3	71 268 ... EUR X3
11 IR 72	72,0	11	0,8	0,3	28,13	202
11 IR 64	64,0	11	0,8	0,4	28,13	204
11 IR 56	56,0	11	0,7	0,4	28,13	206
11 IR 48	48,0	11	0,6	0,6	28,13	208
11 IR 44	44,0	11	0,6	0,6	28,13	210
11 IR 40	40,0	11	0,6	0,6	28,13	212
11 IR 36	36,0	11	0,6	0,6	28,13	214
11 IR 32	32,0	11	0,6	0,6	28,13	216
11 IR 28	28,0	11	0,6	0,7	25,71	218
11 IR 27	27,0	11	0,7	0,8	25,71	220
11 IR 24	24,0	11	0,7	0,8	25,71	222
11 IR 20	20,0	11	0,8	0,9	25,71	224
11 IR 18	18,0	11	0,8	1,0	25,71	226
11 IR 16	16,0	11	0,9	1,1	25,71	228
11 IR 14	14,0	11	1,0	1,1	25,71	230
16 IR 72	72,0	16	0,8	0,3	27,97	232
16 IR 64	64,0	16	0,8	0,4	27,97	234
16 IR 56	56,0	16	0,7	0,4	27,97	236
16 IR 48	48,0	16	0,6	0,6	27,97	238
16 IR 44	44,0	16	0,6	0,6	27,97	240
16 IR 40	40,0	16	0,6	0,6	27,97	242
16 IR 36	36,0	16	0,6	0,6	27,97	244
16 IR 32	32,0	16	0,6	0,6	27,97	246
16 IR 28	28,0	16	0,6	0,7	25,71	248
16 IR 27	27,0	16	0,7	0,8	25,71	250
16 IR 24	24,0	16	0,7	0,8	25,71	252
16 IR 20	20,0	16	0,8	0,9	25,71	254
16 IR 18	18,0	16	0,8	1,0	25,71	256
16 IR 16	16,0	16	0,9	1,1	25,71	258
16 IR 14	14,0	16	1,0	1,2	25,71	260
16 IR 13	13,0	16	1,0	1,3	25,71	262
16 IR 12	12,0	16	1,1	1,4	25,71	264
16 IR 11,5	11,5	16	1,1	1,5	25,71	266
16 IR 11	11,0	16	1,1	1,5	25,71	268
16 IR 10	10,0	16	1,1	1,5	25,71	270
16 IR 9	9,0	16	1,2	1,7	25,71	272
16 IR 8	8,0	16	1,2	1,6	25,71	274
16 IR 8	8,0	16	1,1	1,5		30,11 774
22 IR 7	7,0	22	1,6	2,3	40,22	276
22 IR 6	6,0	22	1,6	2,3	40,22	278
22 IR 5	5,0	22	1,7	2,5	40,22	280
22 IN 4,5	4,5	22	2,0	11,0	42,76	282 <sup>1)</sup>
22 IN 4	4,0	22	2,0	11,0	42,76	284 <sup>1)</sup>

P	●	○
M	●	●
K	●	○
N		○
S	○	○
H	○	○
O		

1) Ausführung neutral (N) – für Rechts- und Linksgewindeherstellung einsetzbar. Neutraler Klemhalter mit Kennzeichnung (U) erforderlich.



# Linke Innengewindedrehplatte

▲ Vollprofil



CCN20

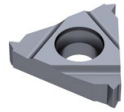
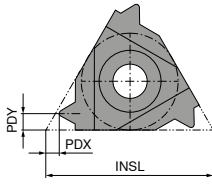

IL  
71 270 ...

Bezeichnung	TPI 1/"	INSL mm	PDX mm	PDY mm	71 270 ...	
					EUR X3	
11 IL 72	72,0	11	0,8	0,3	32,94	202
11 IL 64	64,0	11	0,8	0,4	32,94	204
11 IL 56	56,0	11	0,7	0,4	32,94	206
11 IL 48	48,0	11	0,6	0,6	32,94	208
11 IL 44	44,0	11	0,6	0,6	32,94	210
11 IL 40	40,0	11	0,6	0,6	32,94	212
11 IL 36	36,0	11	0,6	0,6	32,94	214
11 IL 32	32,0	11	0,6	0,6	32,94	216
11 IL 28	28,0	11	0,6	0,7	32,94	218
11 IL 27	27,0	11	0,7	0,8	32,94	220
11 IL 24	24,0	11	0,7	0,8	32,94	222
11 IL 20	20,0	11	0,8	0,9	32,94	224
11 IL 18	18,0	11	0,8	1,0	32,94	226
11 IL 16	16,0	11	0,9	1,1	32,94	228
11 IL 14	14,0	11	0,9	1,1	32,94	230
16 IL 72	72,0	16	0,8	0,3	32,94	232
16 IL 64	64,0	16	0,8	0,4	32,94	234
16 IL 56	56,0	16	0,7	0,4	32,94	236
16 IL 48	48,0	16	0,6	0,6	32,94	238
16 IL 44	44,0	16	0,6	0,6	32,94	240
16 IL 40	40,0	16	0,6	0,6	32,94	242
16 IL 36	36,0	16	0,6	0,6	32,94	244
16 IL 32	32,0	16	0,6	0,6	32,94	246
16 IL 28	28,0	16	0,6	0,7	32,94	248
16 IL 27	27,0	16	0,7	0,8	32,94	250
16 IL 24	24,0	16	0,7	0,8	32,94	252
16 IL 20	20,0	16	0,8	0,9	32,94	254
16 IL 18	18,0	16	0,8	1,0	32,94	256
16 IL 16	16,0	16	0,9	1,1	32,94	258
16 IL 14	14,0	16	1,0	1,2	32,94	260
16 IL 13	13,0	16	1,0	1,3	32,94	262
16 IL 12	12,0	16	1,1	1,4	32,94	264
16 IL 11,5	11,5	16	1,1	1,5	32,94	266
16 IL 11	11,0	16	1,1	1,5	32,94	268
16 IL 10	10,0	16	1,1	1,5	32,94	270
16 IL 9	9,0	16	1,2	1,7	32,94	272
16 IL 8	8,0	16	1,2	1,6	32,94	274
22 IL 7	7,0	22	1,6	2,3	32,94	276
22 IL 6	6,0	22	1,6	2,3	32,94	278
22 IL 5	5,0	22	1,7	2,5	32,94	280

P	●
M	●
K	●
N	
S	○
H	○
O	

→ v<sub>c</sub> Seite 45

## Rechte Außengewindedrehplatte

▲ Vollprofil

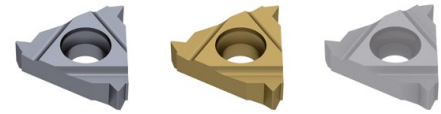
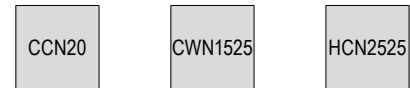
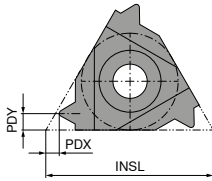
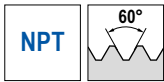

Bezeichnung	TPI 1/"	INSL mm	PDX mm	PDY mm
16 ER 27	27,0	16	0,7	0,8
16 ER 18	18,0	16	0,8	1,0
16 ER 14	14,0	16	0,9	1,2
16 ER 11,5	11,5	16	1,1	1,5
16 ER 8	8,0	16	1,3	1,8

ER 71 256 ...		ER 71 256 ...		ER 71 256 ...	
EUR		EUR		EUR	
X3		X3		X3	
28,84	240			32,55	742
28,84	242			29,84	744
28,84	244	27,42	144	29,84	744
28,84	246	29,69	146	32,55	746
28,84	248				

P	●	●	○
M	●	○	●
K	●	●	○
N		●	○
S	○		○
H	○		○
O		○	

→ v<sub>c</sub> Seite 45

8

## Linke Außengewindedrehplatte

▲ Vollprofil

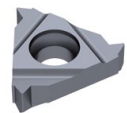
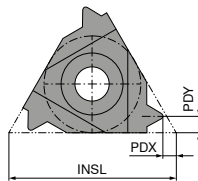

Bezeichnung	TPI 1/"	INSL mm	PDX mm	PDY mm
16 EL 27	27,0	16	0,7	0,8
16 EL 18	18,0	16	0,8	1,0
16 EL 14	14,0	16	0,9	1,2
16 EL 11,5	11,5	16	1,1	1,5
16 EL 8	8,0	16	1,3	1,8

EL 71 258 ...	
EUR	
X3	
33,54	240
33,54	242
33,54	244
33,54	246
33,54	248

P	●
M	●
K	●
N	
S	○
H	○
O	

→ v<sub>c</sub> Seite 45

# Rechte Innengewindedrehplatte

▲ Vollprofil  
▲ Sorte CCN7525 für universellen Einsatz mit gesinterterem Spanbrecher

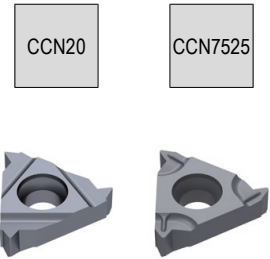
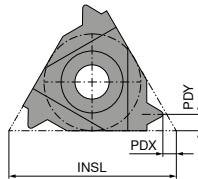

Bezeichnung	TPI	INSL	PDX	PDY
	1/''	mm	mm	mm
11 IR 27	27,0	11	0,7	0,8
11 IR 18	18,0	11	0,8	1,0
11 IR 14	14,0	11	0,9	1,1
16 IR 27	27,0	16	0,7	0,8
16 IR 18	18,0	16	0,8	1,0
16 IR 14	14,0	16	0,9	1,2
16 IR 11,5	11,5	16	1,1	1,5
16 IR 8	8,0	16	1,3	1,8

IR		IR	
71 260 ...		71 260 ...	
EUR		EUR	
X3		X3	
28,84	210		
28,84	212		
28,84	214		
28,84	240		
28,84	242		
28,84	244	34,38	944
28,84	246	34,81	946
28,84	248		

P	●	●
M	●	●
K	●	●
N		
S	○	●
H	○	○
O		

→ v<sub>c</sub> Seite 45

# Linke Innengewindedrehplatte

▲ Vollprofil

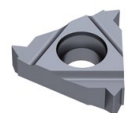
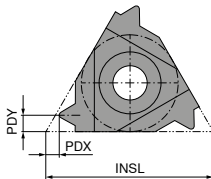
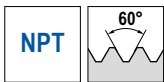

Bezeichnung	TPI	INSL	PDX	PDY
	1/''	mm	mm	mm
11 IL 27	27,0	11	0,7	0,8
11 IL 18	18,0	11	0,8	1,0
11 IL 14	14,0	11	0,9	1,1
16 IL 27	27,0	16	0,7	0,8
16 IL 18	18,0	16	0,8	1,0
16 IL 14	14,0	16	0,9	1,2
16 IL 11,5	11,5	16	1,1	1,5
16 IL 8	8,0	16	1,3	1,8

IL	
71 262 ...	
EUR	
X3	
33,54	210
33,54	212
33,54	214
33,54	240
33,54	242
33,54	244
33,54	246
33,54	248

P	●
M	●
K	●
N	
S	○
H	○
O	

→ v<sub>c</sub> Seite 45

# Rechte Außengewindedrehplatte

- ▲ Vollprofil
- ▲ Trapezgewinde DIN 103

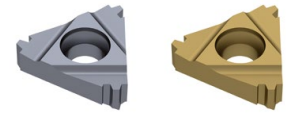
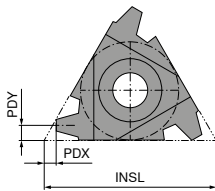

Bezeichnung	TP mm	INSL mm	PDX mm	PDY mm	ER			
					71 232 ... EUR X3	71 232 ... EUR X3		
16 ER 1,5	1,5	16	1,0	1,1	31,12	240		
16 ER 2,0	2,0	16	1,1	1,3	31,12	242		
16 ER 2,0	2,0	16	1,0	1,3			29,27	142
16 ER 3,0	3,0	16	1,3	1,5	31,12	244	27,85	144
22 ER 4,0	4,0	22	1,8	1,9			39,76	170
22 ER 4,0	4,0	22	1,7	1,9	42,91	270		
22 ER 5,0	5,0	22	2,0	2,4			43,76	172
22 ER 5,0	5,0	22	2,1	2,5	44,74	272		
22 ER 6,0	6,0	22	2,3	2,7	46,59	274 <sup>1)</sup>		
22 EN 6,0	6,0	22	2,0	11,0	46,59	276 <sup>2)</sup>		
22 EN 7,0	7,0	22	2,3	11,0	48,45	278 <sup>2)</sup>		
P							●	●
M							●	○
K							●	●
N								●
S							○	
H							○	
O								○

- erfordert speziellen Halter oder einen selbstständig modifizierten Standardhalter
- Ausführung neutral (N) – für Rechts- und Linksgewindeherstellung einsetzbar. Neutraler Klemmhalter mit Kennzeichnung (U) erforderlich.

→ v. Seite 45

# Linke Außengewindedrehplatte

- ▲ Vollprofil
- ▲ Trapezgewinde DIN 103

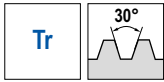

CCN20

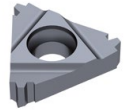
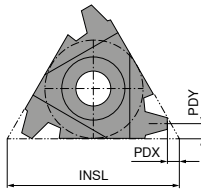

Bezeichnung	TP	INSL	PDX	PDY
	mm	mm	mm	mm
16 EL 1,5	1,5	16	1,0	1,1
16 EL 2,0	2,0	16	1,1	1,3
16 EL 3,0	3,0	16	1,3	1,5
22 EL 4,0	4,0	22	1,7	1,9
22 EL 5,0	5,0	22	2,1	2,5
22 EL 6,0	6,0	22	2,3	2,7

EL

**71 234 ...**

EUR	
X3	
36,09	240
36,09	242
36,09	244
50,28	270
52,56	272
54,69	274 <sup>1)</sup>

P	●
M	●
K	●
N	●
S	○
H	○
O	○

1) erfordert speziellen Halter oder einen selbstständig modifizierten Standardhalter

→ v<sub>c</sub> Seite 45

# Rechte Innengewindedrehplatte

- ▲ Vollprofil
- ▲ Trapezgewinde DIN 103



CCN20

CWN1525

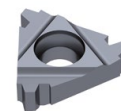
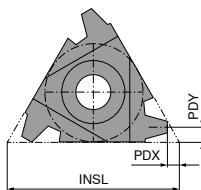

Bezeichnung	TP	INSL	PDX	PDY
	mm	mm	mm	mm
11 IR 1,5	1,5	11	0,815	0,9
16 IR 1,5	1,5	16	1,000	1,1
16 IR 2,0	2,0	16	1,100	1,3
16 IR 3,0	3,0	16	1,300	1,5
22 IR 4,0	4,0	22	1,800	1,9
22 IR 4,0	4,0	22	1,700	1,9
22 IR 5,0	5,0	22	2,000	2,4
22 IR 5,0	5,0	22	2,100	2,5
22 IR 6,0	6,0	22	2,300	2,7
22 IN 6,0	6,0	22	2,000	11,0
22 IN 7,0	7,0	22	2,300	11,0

IR		IR	
71 236 ...		71 236 ...	
EUR		EUR	
X3		X3	
30,82	210		
30,82	240		
30,82	242		
30,82	244	31,84	144
42,91	270	41,91	170
44,74	272	43,46	172
46,59	274 <sup>1)</sup>		
46,59	276 <sup>2)</sup>		
48,45	278 <sup>2)</sup>		

P	●	●
M	●	○
K	●	●
N	●	●
S	○	○
H	○	○
O	○	○

1) erfordert speziellen Halter oder einen selbstständig modifizierten Standardhalter

→ v<sub>c</sub> Seite 45

2) Ausführung neutral (N) – für Rechts- und Linksgewindeherstellung einsetzbar. Neutraler Klemhalter mit Kennzeichnung (U) erforderlich.

# Linke Innengewindedrehplatte

- ▲ Vollprofil
- ▲ Trapezgewinde DIN 103

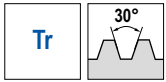

CCN20

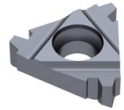
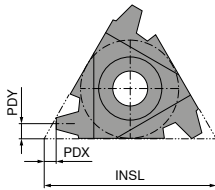

Bezeichnung	TP mm	INSL mm	PDX mm	PDY mm	IL		
					71 238 ...	EUR	
11 IL 1,5	1,5	11	0,8	0,9	X3	210	
16 IL 1,5	1,5	16	1,0	1,1	36,09	240	
16 IL 2,0	2,0	16	1,1	1,3	36,09	242	
16 IL 3,0	3,0	16	1,3	1,5	36,09	244	
22 IL 4,0	4,0	22	1,7	1,9	50,28	270	
22 IL 5,0	5,0	22	2,1	2,5	50,28	272	
22 IL 6,0	6,0	22	2,3	2,7	52,56	274 <sup>1)</sup>	
P							●
M							●
K							●
N							○
S							○
H							○
O							○

1) erfordert speziellen Halter oder einen selbstständig modifizierten Standardhalter

## Rechte Außengewindedrehplatte

- ▲ Vollprofil
- ▲ Rundgewinde DIN 405

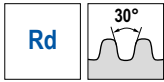

CCN20

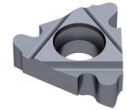
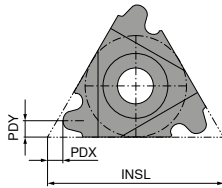

Bezeichnung	TPI	INSL	PDX	PDY	ER	
					71 248 ...	
16 ER 10	10	16	1,1	1,2	EUR X3	240
16 ER 8	8	16	1,4	1,3	30,82	242
16 ER 6	6	16	1,5	1,7	30,82	246
22 ER 6	6	22	1,5	1,7	43,05	270
22 ER 4	4	22	2,2	2,3	46,59	272

  

P	●
M	●
K	●
N	
S	○
H	○
O	

→ v<sub>c</sub> Seite 45

## Linke Außengewindedrehplatte

- ▲ Vollprofil
- ▲ Rundgewinde DIN 405

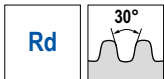

CCN20

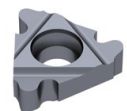
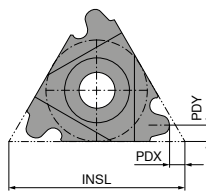

Bezeichnung	TPI	INSL	PDX	PDY	EL	
					71 250 ...	
16 EL 10	10	16	1,1	1,2	EUR X3	240
16 EL 8	8	16	1,4	1,3	35,96	242
16 EL 6	6	16	1,5	1,7	35,96	246
22 EL 6	6	22	1,5	1,7	50,43	270
22 EL 4	4	22	2,2	2,3	54,69	272

  

P	●
M	●
K	●
N	
S	○
H	○
O	

→ v<sub>c</sub> Seite 45

# Rechte Innengewindedrehplatte

- ▲ Vollprofil
- ▲ Rundgewinde DIN 405

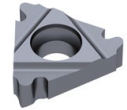
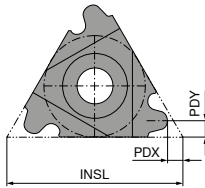
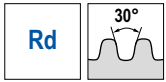

Bezeichnung	TPI 1/"	INSL mm	PDX mm	PDY mm	IR	
					71 252 ...	
16 IR 10	10	16	1,1	1,2	EUR X3	240
16 IR 8	8	16	1,4	1,4	30,82	242
16 IR 6	6	16	1,4	1,5	30,82	246
22 IR 6	6	22	1,5	1,7	43,05	270
22 IR 4	4	22	2,2	2,3	46,59	272

  

P	●
M	●
K	●
N	●
S	○
H	○
O	○

→ v<sub>c</sub> Seite 45

# Linke Innengewindedrehplatte

- ▲ Vollprofil
- ▲ Rundgewinde DIN 405

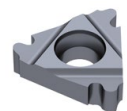
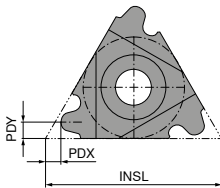
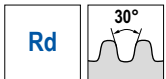

Bezeichnung	TPI 1/"	INSL mm	PDX mm	PDY mm	IL	
					71 254 ...	
16 IL 10	10	16	1,1	1,2	EUR X3	240
16 IL 8	8	16	1,4	1,4	28,84	242
16 IL 6	6	16	1,4	1,5	28,84	246
22 IL 6	6	22	1,5	1,7	40,48	270
22 IL 4	4	22	2,2	2,3	43,63	272

P	●
M	●
K	●
N	●
S	○
H	○
O	○

→ v<sub>c</sub> Seite 45



## Rechte Außengewindedrehplatte

- ▲ Vollprofil
- ▲ Panzerrohrgewinde DIN 40430

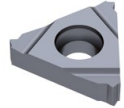
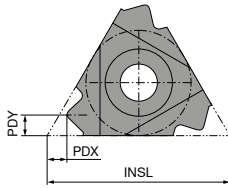
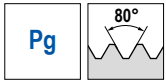

Bezeichnung	TPI	INSL	PDX	PDY	ER	
					71 240 ...	
16 ER 20	20	16	0,8	0,8	EUR X3	240
16 ER 18	18	16	0,8	0,9	30,82	242
16 ER 16	16	16	0,8	1,0	30,82	244

  

P	●
M	●
K	●
N	●
S	○
H	○
O	○

→ v. Seite 45

## Linke Außengewindedrehplatte

- ▲ Vollprofil
- ▲ Panzerrohrgewinde DIN 40430

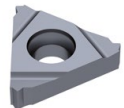
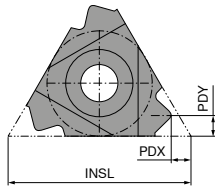
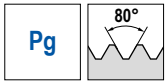

Bezeichnung	TPI	INSL	PDX	PDY	EL	
					71 242 ...	
16 EL 20	20	16	0,8	0,8	EUR X3	240
16 EL 18	18	16	0,8	0,9	33,96	242
16 EL 16	16	16	0,8	1,0	33,96	244

  

P	●
M	●
K	●
N	●
S	○
H	○
O	○

→ v. Seite 45

## Rechte Innengewindedrehplatte

- ▲ Vollprofil
- ▲ Panzerrohrgewinde DIN 40430

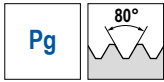

CCN20

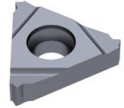
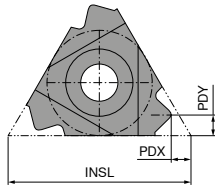

Bezeichnung	TPI	INSL	PDX	PDY	IR	
					71 244 ...	
11 IR 18	18	11	0,8	0,9	EUR X3 30,82	238
16 IR 18	18	16	0,8	0,9	30,82	242
16 IR 16	16	16	0,8	1,0	30,82	244

P	●
M	●
K	●
N	●
S	○
H	○
O	○

→ v<sub>c</sub> Seite 45

## Linke Innengewindedrehplatte

- ▲ Vollprofil
- ▲ Panzerrohrgewinde DIN 40430



CCN20

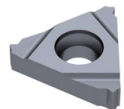
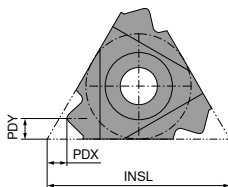

Bezeichnung	TPI	INSL	PDX	PDY	IL	
					71 246 ...	
11 IL 18	18	11	0,8	0,9	EUR X3 33,96	238
16 IL 18	18	16	0,8	0,9	33,96	242
16 IL 16	16	16	0,8	1,0	33,96	244

P	●
M	●
K	●
N	●
S	○
H	○
O	○

→ v<sub>c</sub> Seite 45

# Rechte Außengewindedrehplatte

▲ Teilprofil

▲ Sorte CCN7525 für universellen Einsatz mit gesintertem Spanbrecher

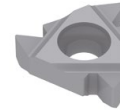
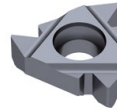
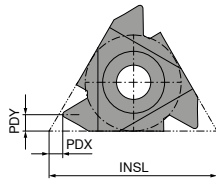

Bezeichnung	TP mm	INSL mm	PDX mm	PDY mm	ER 71 206 ...		ER 71 206 ...		ER 71 206 ...		ER 71 206 ...	
					EUR X3		EUR X3		EUR X3		EUR X3	
16 ER A60	0,5 - 1,5	16	0,8	0,9	23,88	240	21,32	140	23,60	740	23,60	940
16 ER AG60	0,5 - 3	16	1,2	1,7	24,59	244	20,45	144	22,58	744	22,58	944
16 ER G60	1,75 - 3	16	1,2	1,7	24,59	242	23,16	142	25,16	742	25,16	942
22 EN U60	5,5 - 8	22	0,9	11,0	38,35	272 <sup>1)</sup>						
22 ER N60	3,5 - 5	22	1,7	2,5	38,35	270	39,34	170				
P					●	●	○	○	○	○	○	○
M					●	○	○	○	○	○	○	○
K					●	○	○	○	○	○	○	○
N						●			○			
S					○				○			●
H					○				○			○
O							○					

1) Ausführung neutral (N) – für Rechts- und Linksgewindeherstellung einsetzbar. Neutraler Klemhalter mit Kennzeichnung (U) erforderlich.

→ v<sub>c</sub> Seite 45

# Linke Außengewindedrehplatte

▲ Teilprofil

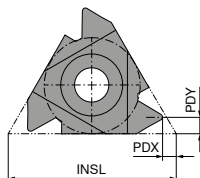

Bezeichnung	TP mm	INSL mm	PDX mm	PDY mm	EL 71 208 ...	
					EUR X3	
16 EL A60	0,5 - 1,5	16	0,8	0,9	26,16	240
16 EL AG60	0,5 - 3	16	1,2	1,7	27,57	244
16 EL G60	1,75 - 3	16	1,2	1,7	27,57	242
22 EL N60	3,5 - 5	22	1,7	2,5	44,74	270
P						●
M						●
K						●
N						
S						○
H						○
O						

→ v<sub>c</sub> Seite 45

# Rechte Innengewindedrehplatte

▲ Teilprofil  
▲ Sorte CCN7525 für universellen Einsatz mit gesintertem Spanbrecher

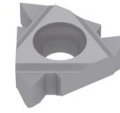
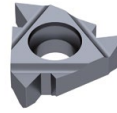
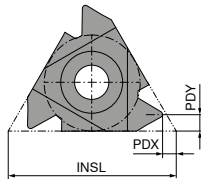

Bezeichnung	TP mm	INSL mm	PDX mm	PDY mm	IR 71 210 ...		IR 71 210 ...		IR 71 210 ...		IR 71 210 ...	
					EUR X3		EUR X3		EUR X3		EUR X3	
11 IR A60	0,5 - 1,5	11	0,8	0,9	23,88	210	21,75	110				
16 IR A60	0,5 - 1,5	16	0,8	0,9	23,88	240	26,30	140				
16 IR AG60	0,5 - 3	16	1,2	1,7	24,59	244	21,75	144	23,88	744	23,88	944
16 IR G60	1,75 - 3	16	1,2	1,7	24,59	242	23,16	142				
22 IN U60	5,5 - 8	22	0,9	11,0	38,35	272 <sup>1)</sup>						
22 IR N60	3,5 - 5	22	1,7	2,5	38,35	270	37,09	170				
P					●		●		○		●	
M					●		○		●		●	
K					●		●		○		●	
N							●		○			
S					○				○		○	
H					○				○		○	
O							○					

1) Ausführung neutral (N) – für Rechts- und Linksgewindeherstellung einsetzbar. Neutraler Klemmhalter mit Kennzeichnung (U) erforderlich. → v. Seite 45

8

# Linke Innengewindedrehplatte

▲ Teilprofil

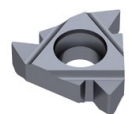
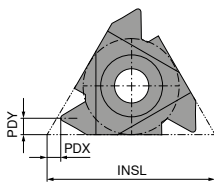

Bezeichnung	TP mm	INSL mm	PDX mm	PDY mm	IL 71 212 ...	
					EUR X3	
11 IL A60	0,5 - 1,5	11	0,8	0,9	26,16	210
16 IL A60	0,5 - 1,5	16	0,8	0,9	26,16	240
16 IL AG60	0,5 - 3	16	1,2	1,7	27,57	244
16 IL G60	1,75 - 3	16	1,2	1,7	27,57	242
22 IL N60	3,5 - 5	22	1,7	2,5	44,74	270
P						●
M						●
K						●
N						
S						○
H						○
O						

→ v. Seite 45

# Rechte Außengewindedrehplatte

▲ Teilprofil

▲ Sorte CCN7525 für universellen Einsatz mit gesintertem Spanbrecher

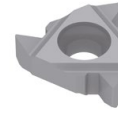
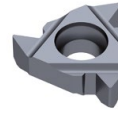
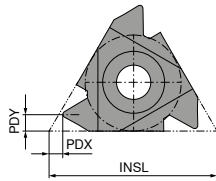

Bezeichnung	TPI 1/"	INSL mm	PDX mm	PDY mm	ER 71 200 ...		ER 71 200 ...		ER 71 200 ...		ER 71 200 ...	
					EUR X3		EUR X3		EUR X3		EUR X3	
16 ER A55	48 - 16	16	0,8	0,9	24,99	240	25,58	140	27,27	740	27,27	940
16 ER AG55	48 - 8	16	1,2	1,7	26,71	244	23,16	144	25,16	744	25,16	944
16 ER G55	14 - 8	16	1,2	1,7	26,71	242	25,58	142	27,69	742	27,69	942
22 ER N55	7 - 5	22	1,7	2,5	41,63	270	41,91	170	45,58	770		
22 EN U55	4,5 - 3,25	22	0,9	11,0	41,63	272 <sup>1)</sup>						
P					●	●	○	●	○	○	●	●
M					●	○	○	●	○	○	●	●
K					●	○	○	○	○	○	○	○
N						●	○	○	○	○	○	○
S					○	○	○	○	○	○	○	○
H					○	○	○	○	○	○	○	○
O							○					

1) Ausführung neutral (N) – für Rechts- und Linksgewindeherstellung einsetzbar. Neutraler Klemmhalter mit Kennzeichnung (U) erforderlich.

→ v<sub>c</sub> Seite 45

# Linke Außengewindedrehplatte

▲ Teilprofil

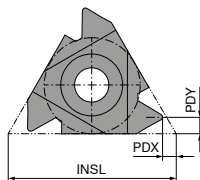

Bezeichnung	TPI 1/"	INSL mm	PDX mm	PDY mm	EL 71 202 ...	
					EUR X3	
16 EL A55	48 - 16	16	0,8	0,9	28,69	240
16 EL AG55	48 - 8	16	1,2	1,7	31,12	244
16 EL G55	14 - 8	16	1,2	1,7	31,12	242
22 EL N55	7 - 5	22	1,7	2,5	48,59	270
P						●
M						●
K						●
N						○
S						○
H						○
O						○

→ v<sub>c</sub> Seite 45

# Rechte Innengewindedrehplatte

▲ Teilprofil  
▲ Sorte CCN7525 für universellen Einsatz mit gesintertem Spanbrecher

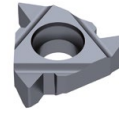
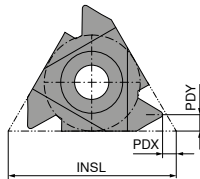

Bezeichnung	TPI 1/"	INSL mm	PDX mm	PDY mm	IR 71 204 ...		IR 71 204 ...		IR 71 204 ...	
					EUR X3		EUR X3		EUR X3	
11 IR A55	48 - 16	11	0,8	0,9	24,99	210				
16 IR A55	48 - 16	16	0,8	0,9	24,99	240				
16 IR AG55	48 - 8	16	1,2	1,7	26,71	244				
16 IR G55	14 - 8	16	1,2	1,7	26,71	242	25,58	142	27,69	942
22 IN U55	4,5 - 3,25	22	0,9	11,0	41,63	272 <sup>1)</sup>				
22 IR N55	7 - 5	22	1,7	2,5	41,63	270				
P						●		●		●
M						●		○		●
K						●		●		●
N								●		
S						○				●
H						○				○
O								○		

1) Ausführung neutral (N) – für Rechts- und Linksgewindeherstellung einsetzbar. Neutraler Klemhalter mit Kennzeichnung (U) erforderlich.

→ v. Seite 45

8

# Linke Innengewindedrehplatte

▲ Teilprofil

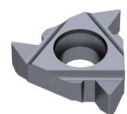
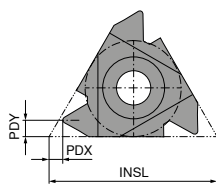

Bezeichnung	TPI 1/"	INSL mm	PDX mm	PDY mm	IL 71 203 ...	
					EUR X3	
11 IL A55	48 - 16	11	0,8	0,9	28,69	210
16 IL A55	48 - 16	16	0,8	0,9	28,69	240
16 IL AG55	48 - 8	16	1,2	1,7	31,12	244
16 IL G55	14 - 8	16	1,2	1,7	31,12	242
22 IL N55	7 - 5	22	1,7	2,5	48,59	270
P						●
M						●
K						●
N						
S						○
H						○
O						

→ v. Seite 45

# Standard-Außengewindeklemmhalter

▲ Klemmhalter mit Steigungswinkel  $\beta = 1,5^\circ$

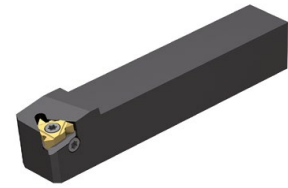
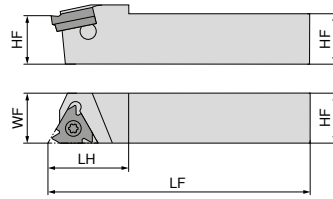

Abbildungen zeigen rechte Ausführung

ISO-Bezeichnung	HF mm	WF mm	LF mm	LH mm	Wendeplatte	Anzugsmoment Nm	links		rechts	
							71 281 ... EUR Y2	908 2) 910 2) 912 2)	71 280 ... EUR Y2	908 2) 910 2) 912 2)
SE R/L 08 08 H11	8	11	100	16	11 ..	1,3	86,11	908 2)	86,11	908 2)
SE R/L 10 10 H11	10	12	100	18	11 ..	1,3	91,80	910 2)	91,80	910 2)
SE R/L 12 12 K11	12	12	125	20	11 ..	1,3	96,54	912 2)	96,54	912 2)
SE R/L 12 12 F16	12	16	80	22	16 ..	3,5	100,60	012	100,60	012
SE R/L 16 16 H16	16	16	100	25	16 ..	3,5	123,80	016	123,80	016
SE R/L 20 20 K16	20	20	125	30	16 ..	3,5	123,80	020	123,80	020
SE R/L 25 25 M16	25	25	150	30	16 ..	3,5	142,00	025	142,00	025
SE R/L 32 32 P16	32	32	170	30	16 ..	3,5	155,50	032	155,50	032
SE R/L 25 25 M22	25	25	150	32	22 ..	10	155,50	125	155,50	125
SE R 32 32 P22	32	32	170	34	22 ..	10			162,40	132
SE R 32 32 P22U	32	21	170	32	22 .N	10			162,40	232 1)

- 1) Neutrale Wendeplatte mit Kennzeichnung (N) erforderlich
- 2) ohne Unterlegplatte

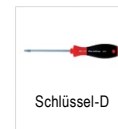

Ersatzteile für Artikel-Nr.	71 950 ...		71 950 ...		71 950 ...		80 950 ...		71 950 ...				
	EUR Y2		EUR Y2		EUR Y2		EUR Y7		EUR Y2				
71 280 908 / 71 281 908							T08	10,05	110	1,41	230		
71 280 910 / 71 281 910							T08	10,05	110	1,41	230		
71 280 912 / 71 281 912							T08	10,05	110	1,41	230		
71 280 012	ER 16 / IL 16	16,39	101	ER 16 / IL 16	12,16	121	1,41	234	T10	11,78	112	1,41	231
71 281 012	EL 16 / IR 16	16,39	108	EL 16 / IR 16	11,07	129	1,41	234	T10	11,78	112	1,41	231
71 280 016	ER 16 / IL 16	16,39	101	ER 16 / IL 16	12,16	121	1,41	234	T10	11,78	112	1,41	231
71 281 016	EL 16 / IR 16	16,39	108	EL 16 / IR 16	11,07	129	1,41	234	T10	11,78	112	1,41	231
71 280 020	ER 16 / IL 16	16,39	101	ER 16 / IL 16	12,16	121	1,41	234	T10	11,78	112	1,41	231
71 281 020	EL 16 / IR 16	16,39	108	EL 16 / IR 16	11,07	129	1,41	234	T10	11,78	112	1,41	231
71 280 025	ER 16 / IL 16	16,39	101	ER 16 / IL 16	12,16	121	1,41	234	T10	11,78	112	1,41	231
71 281 025	EL 16 / IR 16	16,39	108	EL 16 / IR 16	11,07	129	1,41	234	T10	11,78	112	1,41	231
71 280 032	ER 16 / IL 16	16,39	101	ER 16 / IL 16	12,16	121	1,41	234	T10	11,78	112	1,41	231
71 281 032	EL 16 / IR 16	16,39	108	EL 16 / IR 16	11,07	129	1,41	234	T10	11,78	112	1,41	231
71 280 125				ER 22 / IL 22	17,63	137	2,13	235	T20	12,83	114	2,13	232
71 281 125				EL 22 / IR 22	17,63	145	2,13	235	T20	12,83	114	2,13	232
71 280 132				ER 22 / IL 22	17,63	137	2,13	235	T20	12,83	114	2,13	232
71 280 232				ER 22U / IL 22U	17,63	153	2,13	235	T20	12,83	114	2,13	232

Unterlegplatten zur Steigungswinkelkorrektur finden Sie auf → Seite 43.

# Außengewindeklemmhalter

▲ Klemmhalter mit Steigungswinkel  $\beta = 1,5^\circ$

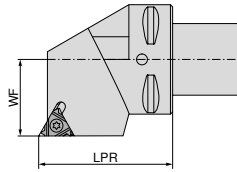

Abbildungen zeigen rechte Ausführung

ISO-Bezeichnung	Aufnahme	LPR mm	WF mm	Wendeplatte	Anzugsmoment Nm	links		rechts	
						84 191 ...	84 190 ...	84 191 ...	84 190 ...
PSC40 SE R/L 27050-16.IK	PSC 40	50	27	16 ..	3,5	EUR Y8 308,20	412	EUR Y8 308,20	412
PSC40 SE R/L 27050-22.IK	PSC 40	50	27	22 ..	10	308,20	422	308,20	422
PSC50 SE R/L 35060-16.IK	PSC 50	60	35	16 ..	3,5	340,70	512	340,70	512
PSC50 SE R/L 35060-22.IK	PSC 50	60	35	22 ..	10	340,70	522	340,70	522
PSC63 SE R/L 45065-16.IK	PSC 63	65	45	16 ..	3,5	390,70	612	390,70	612
PSC63 SE R/L 45065-22.IK	PSC 63	65	45	22 ..	10	390,70	622	390,70	622
PSC80 SE R/L 55080-22.IK	PSC 80	80	55	22 ..	10	412,30	822	412,30	822

Ersatzteile für Artikel-Nr.		71 950 ...		71 950 ...		71 950 ...		80 950 ...		71 950 ...	
		EUR Y2		EUR Y2		EUR Y2		EUR Y7		EUR Y2	
84 190 412	ER 16 / IL 16	16,39	101	12,16	121	1,41	234	11,78	112	1,41	231
84 191 412	EL 16 / IR 16	16,39	108	11,07	129	1,41	234	11,78	112	1,41	231
84 190 422				17,63	137	2,13	235	12,83	114	2,13	232
84 191 422				17,63	145	2,13	235	12,83	114	2,13	232
84 190 512	ER 16 / IL 16	16,39	101	12,16	121	1,41	234	11,78	112	1,41	231
84 191 512	EL 16 / IR 16	16,39	108	11,07	129	1,41	234	11,78	112	1,41	231
84 190 522				17,63	137	2,13	235	12,83	114	2,13	232
84 191 522				17,63	145	2,13	235	12,83	114	2,13	232
84 190 612	ER 16 / IL 16	16,39	101	12,16	121	1,41	234	11,78	112	1,41	231
84 191 612	EL 16 / IR 16	16,39	108	11,07	129	1,41	234	11,78	112	1,41	231
84 190 622				17,63	137	2,13	235	12,83	114	2,13	232
84 191 622				17,63	145	2,13	235	12,83	114	2,13	232
84 190 822	ER 22 / IL 22	17,63	137	17,63	137	2,13	235	12,83	114	2,13	232
84 191 822	EL 22 / IR 22	17,63	145	17,63	145	2,13	235	12,83	114	2,13	232

Unterlegplatten zur Steigungswinkelkorrektur finden Sie auf → Seite 43.



# Standard-Innengewindeklemmhalter

▲ Klemmhalter mit Steigungswinkel  $\beta = 1,5^\circ$

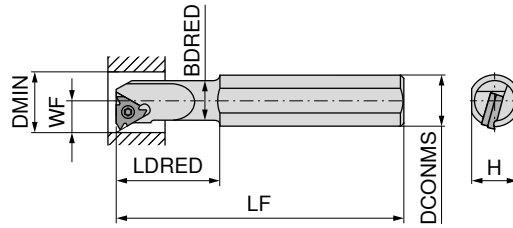

Abbildungen zeigen rechte Ausführung



ISO-Bezeichnung	H mm	LF mm	LDRED mm	DCONMS mm	BDRED mm	WF mm	DMIN mm	Wendeplatte	Anzugsmoment Nm	links		rechts	
										71 283 ...	71 282 ...	71 283 ...	71 282 ...
SI R 0010 H11	9,0	100	25	10	9,5	7,4	12	11 ..	1,3	EUR Y2		EUR Y2	
SI R/L 0010 K11	14,0	125	25	16	10,0	7,4	12	11 ..	1,3	108,40	010 <sup>1)</sup>	142,00	011 <sup>1)</sup>
SI R 0013 L11	14,0	140	32	16	12,0	8,9	15	11 ..	1,3			108,40	010 <sup>1)</sup>
												116,10	013 <sup>1)</sup>
SI R/L 0013 M16	14,0	150	32	16	13,0	10,2	16	16 ..	3,5	118,20	015 <sup>1)</sup>	118,20	015 <sup>1)</sup>
SI R/L 0016 P16	18,0	170	40	20	15,0	11,7	19	16 ..	3,5	118,20	016 <sup>1)</sup>	118,20	016 <sup>1)</sup>
SI R/L 0020 P16	18,0	170	40	20	19,5	13,7	24	16 ..	3,5	139,30	020	139,30	020
SI R 0025 R16	22,6	200	40	25	24,5	16,2	29	16 ..	3,5			169,00	026
SI R/L 0032 S16	28,8	250	50	32	31,5	19,7	36	16 ..	3,5	182,60	032	182,60	032
SI R 0040 T16	36,0	300	50	40	39,5	23,7	44	16 ..	3,5			270,40	040
SI R 0020 P22	18,0	170	40	20	19,5	15,6	24	22 ..	10			131,70	120 <sup>1)</sup>
SI R/L 0025 R22	22,6	200	40	25	24,5	18,1	29	22 ..	10	169,00	126	169,00	126
SI R 0032 S22	28,8	250	50	32	31,5	21,6	38	22 ..	10			187,90	132
SI R 0040 T22	36,0	300	60	40	39,5	25,6	46	22 ..	10			277,30	140
SI R 0032 S22U	28,8	250	60	32	31,5	24,4	38	22..N	10			158,20	133 <sup>2)</sup>

1) ohne Unterlegplatte

2) Neutrale Wendeplatte mit Kennzeichnung (N) erforderlich

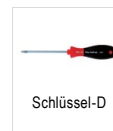

Ersatzteile für Artikel-Nr.	71 950 ...		71 950 ...		71 950 ...		80 950 ...		71 950 ...		
	EUR Y2		EUR Y2		EUR Y2		EUR Y7		EUR Y2		
71 282 011							T08	10,05	110	1,41	230
71 282 010 / 71 283 010							T08	10,05	110	1,41	230
71 282 013							T08	10,05	110	1,41	230
71 282 015 / 71 283 015							T10	11,78	112	2,12	236
71 282 016 / 71 283 016							T10	11,78	112	2,12	236
71 282 020	EL 16 / IR 16	16,39 108	EL 16 / IR 16	11,07 129	1,41	234	T10	11,78	112	1,41	231
71 283 020	ER 16 / IL 16	16,39 101	ER 16 / IL 16	12,16 121	1,41	234	T10	11,78	112	1,41	231
71 282 026	EL 16 / IR 16	16,39 108	EL 16 / IR 16	11,07 129	1,41	234	T10	11,78	112	1,41	231
71 282 032	EL 16 / IR 16	16,39 108	EL 16 / IR 16	11,07 129	1,41	234	T10	11,78	112	1,41	231
71 283 032	ER 16 / IL 16	16,39 101	ER 16 / IL 16	12,16 121	1,41	234	T10	11,78	112	1,41	231
71 282 040	EL 16 / IR 16	16,39 108	EL 16 / IR 16	11,07 129	1,41	234	T10	11,78	112	1,41	231
71 282 120					1,41	234	T20	12,83	114	2,13	237
71 282 126			EL 22 / IR 22	17,63 145	2,13	235	T20	12,83	114	2,13	232
71 283 126			ER 22 / IL 22	17,63 137	2,13	235	T20	12,83	114	2,13	232
71 282 132			EL 22 / IR 22	17,63 145	2,13	235	T20	12,83	114	2,13	232
71 282 140			EL 22 / IR 22	17,63 145	2,13	235	T20	12,83	114	2,13	232
71 282 133			AL 22U / IR 22U	17,63 161	2,13	235	T20	12,83	114	2,13	232

Unterlegplatten zur Steigungswinkelkorrektur finden Sie auf → Seite 43.

# Standard-Innengewindeklemmhalter mit innerer Kühlmittelzufuhr

▲ Klemmhalter mit Steigungswinkel  $\beta = 1,5^\circ$

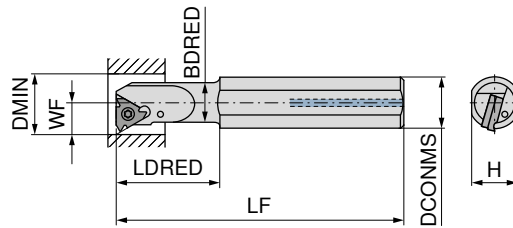

Abbildungen zeigen rechte Ausführung



ISO-Bezeichnung	H mm	LF mm	LDRED mm	DCONMS mm	BDRED mm	WF mm	DMIN mm	Wendeplatte	Anzugsmoment Nm	links		rechts	
										71 283 ...	71 282 ...	71 283 ...	71 282 ...
SI R 0010 M11CB	9,0	150	25	10	9,5	7,4	12	11 ..	1,3	EUR Y2		EUR Y2	510 <sup>2)</sup>
SI R 0012 P11CB	11,0	170	30	12	11,5	8,4	15	11 ..	1,3			452,00	512 <sup>2)</sup>
SI R/L 0010 K11B	14,0	125	25	16	10,0	7,4	12	11 ..	1,3	129,90	310	129,90	310
SI R/L 0013 M16B	14,0	150	32	16	13,0	10,2	16	16 ..	3,5	142,00	315	142,00	315
SI R 0016 P16B	18,0	170	40	20	16,0	11,7	19	16 ..	3,5			142,00	316
SI R 0020 P16B	18,0	170	40	20	19,5	13,7	24	16 ..	3,5			166,20	320 <sup>1)</sup>
SI R/L 0032 S16B	28,8	250	50	32	31,5	19,7	36	16 ..	3,5	205,50	332 <sup>1)</sup>	205,50	332 <sup>1)</sup>

- 1) mit Unterlegplatte
- 2) Ausführung aus Hartmetall

Ersatzteile für Artikel-Nr.	Unterlage Mehrzahn		Unterlage		Schraube-U		Schlüssel-D		Klemmschraube	
	71 950 ...	71 950 ...	71 950 ...	71 950 ...	71 950 ...	71 950 ...	80 950 ...	71 950 ...	80 950 ...	71 950 ...
71 282 510	EUR Y2		EUR Y2		EUR Y2		EUR Y7		EUR Y2	
71 282 512							10,05	110	1,41	230
71 282 310 / 71 283 310							10,05	110	1,41	230
71 282 315 / 71 283 315							11,78	112	2,12	236
71 282 316							11,78	112	2,12	236
71 282 320	EL 16 / IR 16	16,39 108	EL 16 / IR 16	11,07 129	1,41	234	11,78	112	1,41	231
71 282 332	EL 16 / IR 16	16,39 108	EL 16 / IR 16	11,07 129	1,41	234	11,78	112	1,41	231
71 283 332	ER 16 / IL 16	16,39 101	ER 16 / IL 16	12,16 121	1,41	234	11,78	112	1,41	231

Unterlegplatten zur Steigungswinkelkorrektur finden Sie auf → Seite 43.

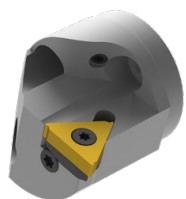

Kennen Sie schon unser Wechselkopfsystem MaxiChange?

Nutzen Sie unsere Gewindedrehplatten für das Wechselkopfsystem.

Neugierig? Weitere Informationen und Produkte finden Sie im → Kapitel 9 – Wendeplattendrehwerkzeuge

# Innengewindeklemmhalter

▲ Klemmhalter mit Steigungswinkel  $\beta = 1,5^\circ$

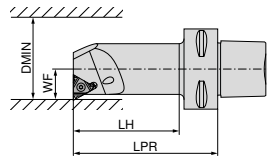

Abbildungen zeigen rechte Ausführung

ISO-Bezeichnung	Aufnahme	WF mm	LPR mm	LH mm	DMIN mm	Wendeplatte	Anzugsmoment Nm	links		rechts	
								84 197 ...		84 196 ...	
PSC40 SI R/L 12060-16.IK	PSC 40	12	60	37	20	16 ..	3,5	EUR Y8 431,20	410	EUR Y8 431,20	410
PSC40 SI R/L 14060-16.IK	PSC 40	14	60	38	25	16 ..	3,5	431,20	412	431,20	412
PSC40 SI R/L 17070-16.IK	PSC 40	17	70	48	32	16 ..	3,5	431,20	414	431,20	414
PSC40 SI R/L 22090-16.IK	PSC 40	22	90	69	40	16 ..	3,5	431,20	416	431,20	416
PSC40 SI R/L 27080-16.IK	PSC 40	27	80	60	50	16 ..	3,5	431,20	418	431,20	418
PSC40 SI R/L 15065-22.IK	PSC 40	15	65	42	25	22 ..	10	431,20	420	431,20	420
PSC40 SI R/L 19070-22.IK	PSC 40	19	70	48	32	22 ..	10	431,20	422	431,20	422
PSC40 SI R/L 22090-22.IK	PSC 40	22	90	69	40	22 ..	10	431,20	424	431,20	424
PSC40 SI R/L 27080-22.IK	PSC 40	27	80	60	50	22 ..	10	431,20	426	431,20	426
PSC50 SI R/L 12060-16.IK	PSC 50	12	60	35	20	16 ..	3,5	480,00	510	480,00	510
PSC50 SI R/L 14060-16.IK	PSC 50	14	60	36	25	16 ..	3,5	480,00	512	480,00	512
PSC50 SI R/L 17070-16.IK	PSC 50	17	70	47	32	16 ..	3,5	480,00	514	480,00	514
PSC50 SI R/L 22090-16.IK	PSC 50	22	90	68	40	16 ..	3,5	480,00	516	480,00	516
PSC50 SI R/L 27105-16.IK	PSC 50	27	105	84	50	16 ..	3,5	480,00	518	480,00	518
PSC50 SI R/L 15065-22.IK	PSC 50	15	65	41	25	22 ..	10	480,00	520	480,00	520
PSC50 SI R/L 19070-22.IK	PSC 50	19	70	47	32	22 ..	10	480,00	522	480,00	522
PSC50 SI R/L 22090-22.IK	PSC 50	22	90	68	40	22 ..	10	480,00	524	480,00	524
PSC50 SI R/L 27105-22.IK	PSC 50	27	105	84	50	22 ..	10	480,00	526	480,00	526
PSC63 SI R/L 14070-16.IK	PSC 63	14	70	42	25	16 ..	3,5	551,60	610	551,60	610
PSC63 SI R/L 17075-16.IK	PSC 63	17	75	48	32	16 ..	3,5	551,60	612	551,60	612
PSC63 SI R/L 22090-16.IK	PSC 63	22	90	64	40	16 ..	3,5	551,60	614	551,60	614
PSC63 SI R/L 27105-16.IK	PSC 63	27	105	80	50	16 ..	3,5	551,60	616	551,60	616
PSC63 SI R/L 19075-22.IK	PSC 63	19	75	48	32	22 ..	10	551,60	620	551,60	620
PSC63 SI R/L 22090-22.IK	PSC 63	22	90	64	40	22 ..	10	551,60	622	551,60	622
PSC63 SI R/L 27105-22.IK	PSC 63	27	105	80	50	22 ..	10	551,60	624	551,60	624



Ersatzteile	Wendeplatte	71 950 ...		71 950 ...		71 950 ...		80 950 ...		71 950 ...	
		EUR		EUR		EUR		EUR		EUR	
16 ..	rechts	Y2	108	Y2	129	Y2	234	Y7	112	Y2	231
16 ..	links	16,39	101	11,07	121	1,41	234	11,78	112	1,41	231
22 ..	links	16,39		12,16	137	2,13	235	12,83	114	2,13	232
22 ..	rechts			17,63	145	2,13	235	12,83	114	2,13	232

Unterlegplatten zur Steigungswinkelkorrektur finden Sie auf → Seite 43.

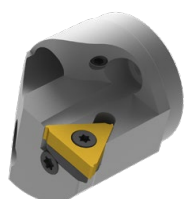

Kennen Sie schon unser Wechselkopfsystem MaxiChange?

Nutzen Sie unsere Gewindedrehplatten für das Wechselkopfsystem.

Neugierig? Weitere Informationen und Produkte finden Sie im → Kapitel 9 – Wendeplattendrehwerkzeuge

## Rechte Innengewindedrehplatte – Mini Größe 06

▲ Vollprofil

▲ Gewindeherstellung ab Durchmesser 6 mm

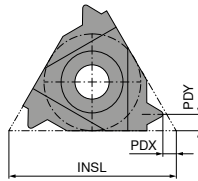
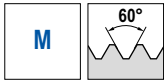

Bezeichnung	TP mm	PDX mm	PDY mm	INSL mm
06 IR 0,5	0,50	0,9	0,5	6
06 IR 0,75	0,75	0,8	0,5	6
06 IR 1,0	1,00	0,7	0,6	6
06 IR 1,25	1,25	0,6	0,6	6

IR 71 271 ...		IR 71 224 ...	
EUR		EUR	
X3		X3	
29,40	110	31,68	35700
29,40	112	31,68	36100
29,40	114	31,68	36500
29,40	116	31,68	36700

P	●	○
M	●	●
K	●	○
N	○	○
S	○	●
H	○	○
O	○	○

→ v. Seite 45

8

## Rechte Innengewindedrehplatte – Mini Größe 06

▲ Vollprofil

▲ Gewindeherstellung ab Durchmesser 6 mm

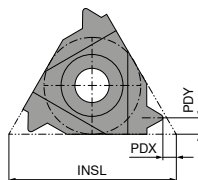

Bezeichnung	TPI 1/"	PDX mm	PDY mm	INSL mm
06 IR 26	26	0,7	0,6	6
06 IR 22	22	0,6	0,6	6
06 IR 20	20	0,6	0,7	6
06 IR 18	18	0,6	0,7	6

IR 71 230 ...		IR 71 230 ...	
EUR		EUR	
X3		X3	
29,40	13500	31,68	33500
29,40	13100	31,68	33100
29,40	12900	31,68	32900
29,40	12500	31,68	32500

P	●	○
M	●	●
K	●	○
N	○	○
S	○	●
H	○	○
O	○	○

→ v. Seite 45

## Rechte Innengewindedrehplatte – Mini Größe 06

- ▲ Teilprofil
- ▲ Gewindeherstellung ab Durchmesser 6 mm

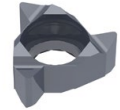
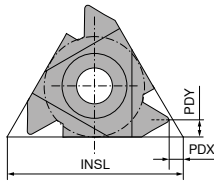

Bezeichnung	TP mm	INSL mm	PDX mm	PDY mm
06 IR A60	0,5 - 1,25	6	0,6	0,6

	IR 71 274 ...	IR 71 272 ...
P	●	○
M	●	●
K	●	○
N	○	○
S	○	●
H	○	○
O	○	○

IR 71 274 ...	IR 71 272 ...
EUR X3 29,40	EUR X3 31,68
210	30000

→ v. Seite 45

## Rechte Innengewindedrehplatte – Mini Größe 06

- ▲ Teilprofil
- ▲ Gewindeherstellung ab Durchmesser 6 mm

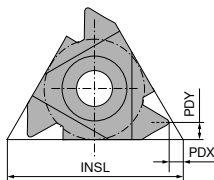

Bezeichnung	TPI 1/"	INSL mm	PDX mm	PDY mm
06 IR A55	48 - 20	6	0,5	0,6

	IR 71 272 ...	IR 71 272 ...
P	●	○
M	●	●
K	●	○
N	○	○
S	○	●
H	○	○
O	○	○

IR 71 272 ...	IR 71 272 ...
EUR X3 29,40	EUR X3 31,68
10100	30100

→ v. Seite 45

## Rechte Innengewindedrehplatte – Mini Größe 08

- ▲ Vollprofil
- ▲ Gewindeherstellung ab Durchmesser 8 mm

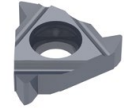
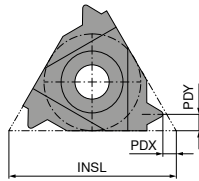
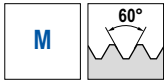

Bezeichnung	TP mm	PDX mm	PDY mm	INSL mm
08 IR 0,5	0,50	0,6	0,5	8
08 IR 0,75	0,75	0,6	0,5	8
08 IR 1,0	1,00	0,6	0,6	8
08 IR 1,25	1,25	0,6	0,7	8
08 IR 1,5	1,50	0,6	0,7	8
08 IR 1,75	1,75	0,6	0,8	8
08 IN 2,0	2,00	0,9	4,0	8

IR		IR	
71 224 ...		71 224 ...	
EUR		EUR	
X3		X3	
31,68	14300	31,68	34300
31,68	13700	31,68	33700
31,68	13300	31,68	33300
31,68	13100	31,68	33100
31,68	12900	31,68	32900
31,68	12700	31,68	32700
31,68	12500 <sup>1)</sup>	31,68	32500 <sup>1)</sup>

P	●	○
M	●	●
K	●	○
N	○	○
S	○	●
H	○	○
O	○	○

1) Ausführung neutral (N)

→ v. Seite 45

## Neutrale Innengewindedrehplatte – Mini Größe 08

- ▲ Teilprofil
- ▲ Gewindeherstellung ab Durchmesser 8 mm

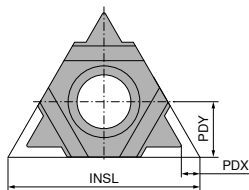

Bezeichnung	TP mm	INSL mm	PDX mm	PDY mm
08 IN M60	1,75 - 2,0	8	0,8	4

IN		IN	
71 273 ...		71 273 ...	
EUR		EUR	
X3		X3	
31,68	10800	31,68	30800

P	●	○
M	●	●
K	●	○
N	○	○
S	○	●
H	○	○
O	○	○

→ v. Seite 45

## Rechte Innengewindedrehplatte – Mini Größe 08

- ▲ Teilprofil
- ▲ Gewindeherstellung ab Durchmesser 8 mm

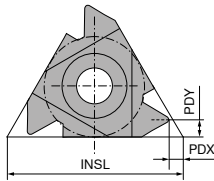

Bezeichnung	TP mm	PDX mm	PDY mm	INSL mm
08 IR A60	0,5 - 1,25	0,6	0,6	8
08 IR A60	0,5 - 1,5	0,6	0,7	8

IR		IR	
71 272 ...	71 272 ...	71 272 ...	71 272 ...
EUR X3	EUR X3	EUR X3	EUR X3
31,68	10600	31,68	30600

P	●	○
M	●	●
K	●	○
N	○	○
S	○	●
H	○	○
O	○	○

→ v<sub>c</sub> Seite 45

## Neutrale Innengewindedrehplatte – Mini Größe 08

- ▲ Teilprofil
- ▲ Gewindeherstellung ab Durchmesser 8 mm

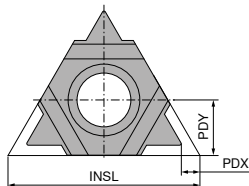

Bezeichnung	TPI 1/"	INSL mm	PDX mm	PDY mm
08 IN M55	14 - 11	8	0,9	4

IN		IN	
71 273 ...	71 273 ...	71 273 ...	71 273 ...
EUR X3	EUR X3	EUR X3	EUR X3
31,68	10900	31,68	30900

P	●	○
M	●	●
K	●	○
N	○	○
S	○	●
H	○	○
O	○	○

→ v<sub>c</sub> Seite 45

# Rechte Innengewindedrehplatte – Mini Größe 08

▲ Teilprofil

▲ Gewindeherstellung ab Durchmesser 8 mm

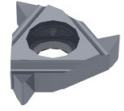
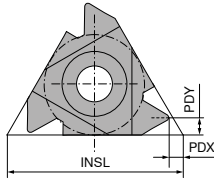

Bezeichnung	TPI 1/"	INSL mm	PDX mm	PDY mm	IR		IR	
					71 272 ...	71 272 ...	71 272 ...	71 272 ...
08 IR A55	48 - 16	8	0,6	0,7	EUR X3 31,68	10700	EUR X3 31,68	30700
P					●		○	
M					●		●	
K					●		○	
N					○			
S							●	
H							○	
O							○	

→ v<sub>c</sub> Seite 45



## Rechte Innengewindeklemmhalter – Mini Größe 06

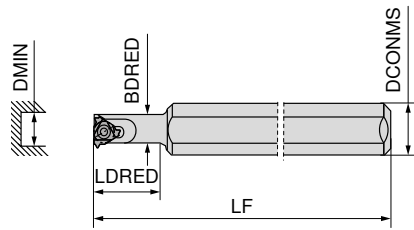

ISO-Bezeichnung	LF mm	LDRED mm	DCONMS mm	BDRED mm	DMIN mm	Wendeplatte	Anzugsmoment Nm
SI R 0005 H06	100	12	12	5,1	6	06 ..	0,6
SI R 0005 H06 C	100	26	6	5,1	6	06 ..	0,6

rechts  
**71 282 ...**

EUR  
Y2  
144,70 00500  
270,10 10500<sup>1)</sup>

1) Schaft aus Vollhartmetall mit Innenkühlung

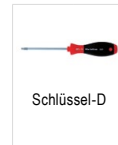

**80 950 ...**

**71 950 ...**

EUR  
Y7

EUR  
Y2

Ersatzteile  
für Artikel-Nr.

71 282 00500	T06	10,87	108	2,64	23800
71 282 10500	T06	10,87	108	2,64	23800

## Rechte Innengewindeklemmhalter – Mini Größe 08

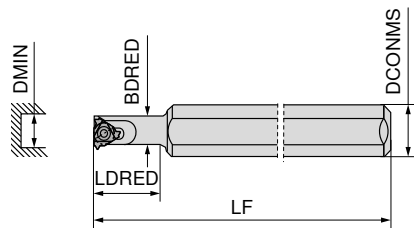

rechts  
**71 282 ...**

EUR  
Y2  
144,70 00700  
162,40 00800<sup>1)</sup>  
339,10 10700<sup>2)</sup>

ISO-Bezeichnung	LF mm	LDRED mm	DCONMS mm	BDRED mm	DMIN mm	Wendeplatte	Anzugsmoment Nm
SI R 0007 K08	125	18	16	6,6	7,8	08 ..	0,6
SI R 0008 K08U	125	21	16	7,3	9,0	08 .N	0,6
SI R 0007 K08CB	125	31	8	6,6	7,8	08 ..	0,6

- 1) Neutrale Wendeplatte mit Kennzeichnung (N) erforderlich
- 2) Schaft aus Vollhartmetall mit Innenkühlung



**80 950 ...**

**71 950 ...**

EUR  
Y7

EUR  
Y2

Ersatzteile  
für Artikel-Nr.

71 282 00700	T06	10,87	108	2,78	23900
71 282 00800	T06	10,87	108	2,78	23900
71 282 10700	T06	10,87	108	2,78	23900

## Unterlegplatten für Standard-Gewindeschneidplatten

- ▲ Den erforderlichen Korrekturwinkel  $\alpha$  ( $\pm$ ) errechnen Sie anhand der Formel auf Seite 47.
- ▲ Unten angeführt finden Sie dann die entsprechenden Korrekturplatten.



Steigungswinkel $\beta$	Korrekturwinkel $\alpha$	AE 16 ER 16 / IL 16		AI 16 EL 16 / IR 16		AE 22 ER 22 / IL 22		AI 22 EL 22 / IR 22		AE 22 U ER 22 / IL 22		AI 22 U EL 22 / IR 22		AE 16 M ER 16 / IL 16		AI 16 M EL 16 / IR 16	
		71 950 ...		71 950 ...		71 950 ...		71 950 ...		71 950 ...		71 950 ...		71 950 ...		71 950 ...	
		EUR	Y2	EUR	Y2	EUR	Y2	EUR	Y2	EUR	Y2	EUR	Y2	EUR	Y2	EUR	Y2
+ 4,5°	+ 3°	13,91	118	13,91	126	22,32	134	22,32	142	22,32	150 <sup>1)</sup>	22,32	158 <sup>1)</sup>				
+ 3,5°	+ 2°	13,91	119	13,91	127	22,32	135	22,32	143	22,32	151 <sup>1)</sup>	22,32	159 <sup>1)</sup>				
+ 2,5°	+ 1°	13,91	120	13,91	128	22,32	136	22,32	144	22,32	152 <sup>1)</sup>	22,32	160 <sup>1)</sup>				
+ 1,5°	0°	12,16	121	11,07	129	17,63	137	17,63	145	17,63	153 <sup>1)</sup>	17,63	161 <sup>1)</sup>	16,39	101	16,39	108
+ 0,5°	- 1°	13,91	122	13,91	130	22,32	138	22,32	146	22,32	154 <sup>1)</sup>	22,32	162 <sup>1)</sup>				
0°	- 1,5°	13,91	123	13,91	131	22,32	139	22,32	147								
- 0,5°	- 2°	13,91	124	13,91	132	22,32	140	22,32	148	22,32	156 <sup>1)</sup>	22,32	164 <sup>1)</sup>				
- 1,5°	- 3°	13,91	125	13,91	133	22,32	141	22,32	149	22,32	157 <sup>1)</sup>	22,32	165 <sup>1)</sup>				

1) Ausführung neutral für Klemmhalter mit Kennzeichnung (U).

## Flankenfreiwinkel und effektiver Steigungswinkel

Der Neigungswinkel  $\lambda$  der Schneidkanten stellt in Übereinstimmung mit dem Gewindesteigungswinkel  $\beta$  an den beiden Gewindeflanken gleiche Span- und Seitenfreiwinkel sicher.

8

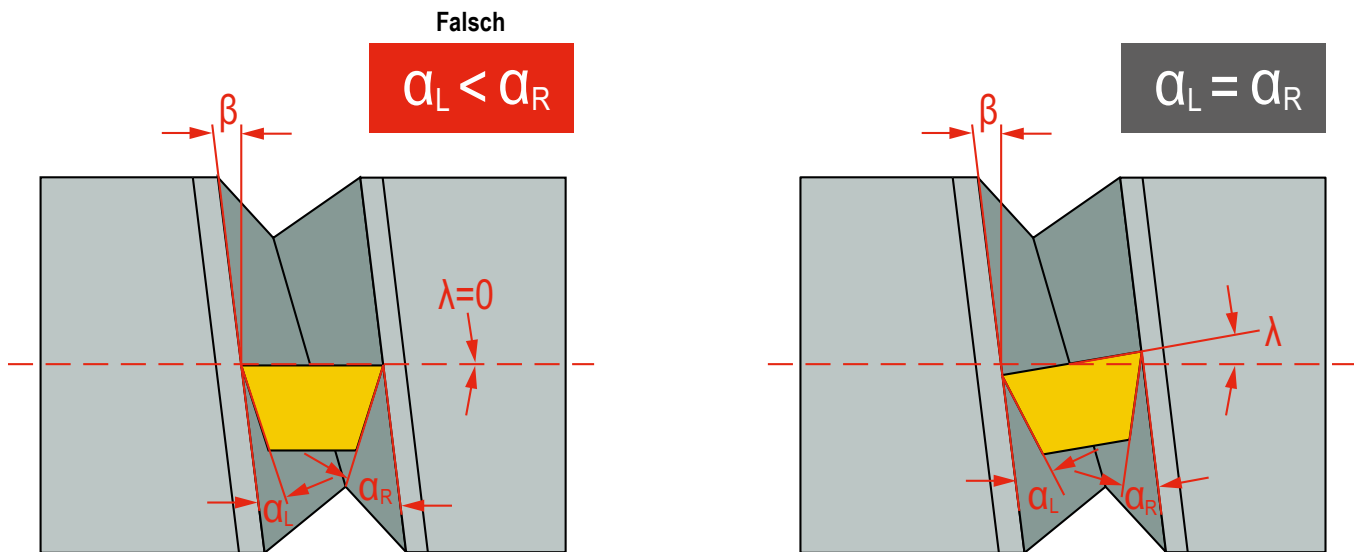

$\alpha$  = seitlicher Freiwinkel

$\lambda$  = Steigungswinkel

$\beta$  = effektiver Neigungswinkel wird erreicht, indem die geeignete Unterlegplatte eingesetzt wird

# Materialbeispiele zu den Schnittdatentabellen

	Werkstoffuntergruppe	Index	Zusammensetzung / Gefüge / Wärmebehandlung	Festigkeit N/mm <sup>2</sup> / HB / HRC	Werkstoff- nummer	Werkstoff- bezeichnung	Werkstoff- nummer	Werkstoff- bezeichnung
P	Unlegierter Stahl	P.1.1	< 0,15 % C geglüht	420 N/mm <sup>2</sup> / 125 HB	1.0401	C15	1.1141	Ck15
		P.1.2	< 0,45 % C geglüht	640 N/mm <sup>2</sup> / 190 HB	1.1191	C45E	1.0718	9SMnPb28
		P.1.3	< 0,45 % C vergütet	840 N/mm <sup>2</sup> / 250 HB	1.1191	C45E	1.0535	C55
		P.1.4	< 0,75 % C geglüht	910 N/mm <sup>2</sup> / 270 HB	1.1223	C60R	1.0535	C55
		P.1.5	< 0,75 % C vergütet	1010 N/mm <sup>2</sup> / 300 HB	1.1223	C60R	1.0727	45S20
	Niedriglegierter Stahl	P.2.1	geglüht	610 N/mm <sup>2</sup> / 180 HB	1.7131	16MnCr5	1.6587	17CrNiMo6
		P.2.2	vergütet	930 N/mm <sup>2</sup> / 275 HB	1.7131	16MnCr5	1.6587	17CrNiMo6
		P.2.3	vergütet	1010 N/mm <sup>2</sup> / 300 HB	1.7225	42CrMo4	1.3505	100Cr6
		P.2.4	vergütet	1200 N/mm <sup>2</sup> / 375 HB	1.7225	42CrMo4	1.3505	100Cr6
	Hochlegierter Stahl und hochlegierter Werkzeugstahl	P.3.1	geglüht	680 N/mm <sup>2</sup> / 200 HB	1.4021	X20Cr13	1.4034	X46Cr13
		P.3.2	gehärtet und angelassen	1100 N/mm <sup>2</sup> / 300 HB	1.2343	X38CrMoV5-1	1.4034	X46Cr13
		P.3.3	gehärtet und angelassen	1300 N/mm <sup>2</sup> / 400 HB	1.2343	X38CrMoV5-1	1.4034	X46Cr13
	Nichtrostender Stahl	P.4.1	ferritisch / martensitisch geglüht	680 N/mm <sup>2</sup> / 200 HB	1.4016	X6Cr17	1.2316	X36CrMo16
		P.4.2	martensitisch vergütet	1010 N/mm <sup>2</sup> / 300 HB	1.4112	X90CrMoV18	1.2316	X36CrMo16
M	Nichtrostender Stahl	M.1.1	austenitisch / austenitisch-ferritisch abgeschreckt	610 N/mm <sup>2</sup> / 180 HB	1.4301	X5CrNi18-10	1.4571	X6CrNiMoTi17-12-2
		M.2.1	austenitisch vergütet	300 HB	1.4841	X15CrNiSi25-21	1.4539	X1NiCrMoCu25-20-5
		M.3.1	austenitisch / ferritisch (Duplex) abgeschreckt	780 N/mm <sup>2</sup> / 230 HB	1.4462	X2CrNiMoN22-5-3	1.4501	X2CrNiMoCuWN25-7-4
K	Grauguss	K.1.1	perlitisch / ferritisch	350 N/mm <sup>2</sup> / 180 HB	0.6010	GG-10	0.6025	GG-25
		K.1.2	perlitisch (martensitisch)	500 N/mm <sup>2</sup> / 260 HB	0.6030	GG-30	0.6045	GG-45
	Gusseisen mit Kugelgraphit	K.2.1	ferritisch	540 N/mm <sup>2</sup> / 160 HB	0.7040	GGG-40	0.7060	GGG-60
		K.2.2	perlitisch	845 N/mm <sup>2</sup> / 250 HB	0.7070	GGG-70	0.7080	GGG-80
	Temperguss	K.3.1	ferritisch	440 N/mm <sup>2</sup> / 130 HB	0.8035	GTW-35-04	0.8045	GTW-45
		K.3.2	perlitisch	780 N/mm <sup>2</sup> / 230 HB	0.8165	GTS-65-02	0.8170	GTS-70-02
N	Aluminium-Knetlegierung	N.1.1	nicht aushärtbar	60 HB	3.0255	Al99,5	3.3315	AlMg1
		N.1.2	aushärtbar ausgehärtet	340 N/mm <sup>2</sup> / 100 HB	3.1355	AlCuMg2	3.2315	AlMgSi1
	Aluminium-Gusslegierung	N.2.1	≤ 12 % Si, nicht aushärtbar	250 N/mm <sup>2</sup> / 75 HB	3.2581	G-AlSi12	3.2163	G-AlSi9Cu3
		N.2.2	≤ 12 % Si, aushärtbar ausgehärtet	300 N/mm <sup>2</sup> / 90 HB	3.2134	G-AlSi5Cu1Mg	3.2373	G-AlSi9Mg
		N.2.3	> 12 % Si, nicht aushärtbar	440 N/mm <sup>2</sup> / 130 HB		G-AlSi17Cu4Mg		G-AlSi18CuNiMg
	Kupfer und Kupferlegierungen (Bronze / Messing)	N.3.1	Automatenlegierungen, PB > 1 %	375 N/mm <sup>2</sup> / 110 HB	2.0380	CuZn39Pb2 (Ms58)	2.0410	CuZn44Pb2
		N.3.2	CuZn, CuSnZn	300 N/mm <sup>2</sup> / 90 HB	2.0331	CuZn15	2.4070	CuZn28Sn1As
		N.3.3	CuSn, bleifreies Kupfer und Elektrolytkupfer	340 N/mm <sup>2</sup> / 100 HB	2.0060	E-Cu57	2.0590	CuZn40Fe
	Magnesiumlegierungen	N.4.1	Magnesium und Magnesiumlegierungen	70 HB	3.5612	MgAl6Zn	3.5312	MgAl3Zn
	S	Warmfeste Legierungen	S.1.1	Fe-Basis geglüht	680 N/mm <sup>2</sup> / 200 HB	1.4864	X12NiCrSi 36-16	1.4865
S.1.2			ausgehärtet	950 N/mm <sup>2</sup> / 280 HB	1.4980	X6NiCrTiMoVB25-15-2	1.4876	X10NiCrAlTi32-20
S.2.1			geglüht	840 N/mm <sup>2</sup> / 250 HB	2.4631	NiCr20TiAl (Nimonic80A)	3.4856	NiCr22Mo9Nb
S.2.2			Ni- oder Co-Basis ausgehärtet	1180 N/mm <sup>2</sup> / 350 HB	2.4668	NiCr19Nb5Mo3 (Inconel 718)	2.4955	NiFe25Cr20NbTi
S.2.3			gegossen	1080 N/mm <sup>2</sup> / 320 HB	2.4765	CoCr20W15Ni	1.3401	G-X120Mn12
Titanlegierungen		S.3.1	Reintitan	400 N/mm <sup>2</sup>	3.7025	Ti99,8	3.7034	Ti99,7
		S.3.2	Alpha- + Beta-Legierungen ausgehärtet	1050 N/mm <sup>2</sup> / 320 HB	3.7165	TiAl6V4	Ti-6246	Ti-6Al-2Sn-4Zr-6Mo
		S.3.3	Beta-Legierungen	1400 N/mm <sup>2</sup> / 410 HB	Ti555.3	Ti-5Al-5V-5Mo-3Cr	R56410	Ti-10V-2Fe-3Al
H	Gehärteter Stahl	H.1.1	gehärtet und angelassen	46–55 HRC				
		H.1.2	gehärtet und angelassen	56–60 HRC				
		H.1.3	gehärtet und angelassen	61–65 HRC				
		H.1.4	gehärtet und angelassen	66–70 HRC				
	Hartguss	H.2.1	gegossen	400 HB				
Gehärtetes Gusseisen	H.3.1	gehärtet und angelassen	55 HRC					
O	Nichtmetallische Werkstoffe	O.1.1	Kunststoffe, duroplastisch	≤ 150 N/mm <sup>2</sup>				
		O.1.2	Kunststoffe, thermoplastisch	≤ 100 N/mm <sup>2</sup>				
		O.2.1	aramidfaserverstärkt	≤ 1000 N/mm <sup>2</sup>				
		O.2.2	glas-/kohlefaserverstärkt	≤ 1000 N/mm <sup>2</sup>				
		O.3.1	Graphit					

\* Zugfestigkeit

## Schnittdatenrichtwerte

Index	CCN1525	CCN2520	CWN1525	HCN2525	CCN7525	CCN20	CWK20
	Mini	Mini					
	v <sub>c</sub> (m/min)						
P.1.1	80	120	120	120	120	120	
P.1.2	80	120	120	120	120	120	
P.1.3	80	120	120	120	120	120	
P.1.4	80	80	80	90	80	80	
P.1.5	70	80	80	90	80	80	
P.2.1	50	80	80	90	80	80	
P.2.2	50	80	80	90	80	80	
P.2.3	50	80	80	90	80	80	
P.2.4	50	80	80	90	80	80	
P.3.1	50	50	60	70	50	50	
P.3.2	50	50	60	70	50	50	
P.3.3	50	50	60	70	50	50	
P.4.1	50	50	60	70	50	50	
P.4.2	50	50	60	70	50	50	
M.1.1	40	90	60	110	90	60	40
M.2.1	40	90	60	110	90	60	40
M.3.1	40	90	60	110	90	60	40
K.1.1	60	120	90	140	120	120	80
K.1.2	60	120	90	140	120	120	80
K.2.1	60	100	80	120	100	100	70
K.2.2	60	100	80	120	100	100	70
K.3.1	50	100	80	110	100	100	70
K.3.2	50	100	80	110	100	100	70
N.1.1	500		600	700			150
N.1.2	300		600	700			150
N.2.1	120		250	280			120
N.2.2	120		250	280			120
N.2.3	120		250	280			120
N.3.1	110		150	190			100
N.3.2	150		150	190			100
N.3.3	150		150	190			100
N.4.1	300		300	220			150
S.1.1		25		20	25	20	20
S.1.2		25		20	25	20	20
S.2.1		25		20	25	20	20
S.2.2		25		20	25	20	20
S.2.3		25		20	25	20	20
S.3.1		35		30	35	30	30
S.3.2		35		30	35	30	30
S.3.3		35		30	35	30	30
H.1.1		35		30	35	30	
H.1.2		35		30	35	30	
H.1.3		35		30	35	30	
H.1.4		35		30	35	30	
H.2.1		25		20	25	20	
H.3.1		25		20	25	20	
O.1.1	150		200				
O.1.2	150		200				
O.2.1	150		200				
O.2.2	150		200				
O.3.1	150		200				

8



Die Schnittdaten sind sehr stark von den äußeren Bedingungen, wie zum Beispiel Stabilität der Werkzeug- und Werkstückspannung, Material und Maschinentyp abhängig! Die angegebenen Werte stellen mögliche Schnittdaten dar, welche je nach Einsatzbedingungen nach oben oder unten korrigiert werden müssen!

## Gewindedrehverfahren

### Außen-Rechtsgewinde

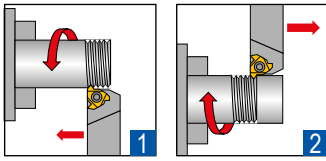

### Außen-Linksgewinde

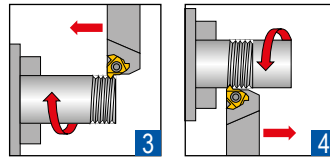

### Innen-Rechtsgewinde

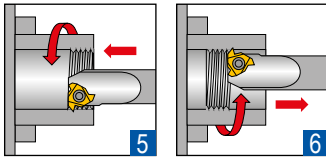

### Innen-Linksgewinde

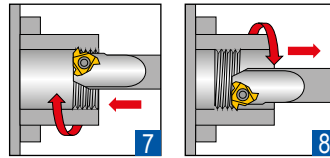

**i** Die Bearbeitungsfälle 2, 4, 6 und 8 erfordern negative Unterlegplatten! Diese Platten finden Sie auf → Seite 43.

## Gewindezustellmethoden

### Radiale Zustellung

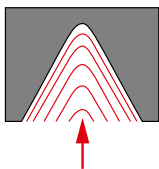

- ▲ bei Steigungen kleiner als 1,5 mm
- ▲ für kurzspanende Werkstoffe
- ▲ für die Bearbeitung gehärteter Werkstoffe
- ▲ einfache und schnelle Zustellungsmethode

### Zustellung entlang der Flanke

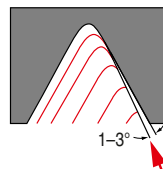

- ▲ bei Steigungen größer als 1,5 mm
- ▲ bei radialer Zustellung ist die effektive Schneidkantenlänge zu groß, was zum Rattern führen kann
- ▲ bei TRAPEZ und ACME ist das Spannen an drei Flanken für den Spanfluss von Nachteil

### Wechelseitige Zustellung

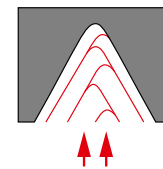

- ▲ bei größeren Steigungen
- ▲ bei langspanenden Werkstoffen
- ▲ gleichmäßiger Verschleiß der Schneidkanten
- ▲ komplizierter Programmiervorgang notwendig

## Empfohlene Anzahl der Schnitte und Schnitttiefen

### Standard Gewindeplatten

Steigung (TP/TPI)	mm	0,50	0,75	1,00	1,25	1,50	1,75	2,00	2,50	3,00	3,50	4,00	4,50	5,00	5,50	6,00	8,00
	Gang/Zoll	48	32	24	20	16	14	12	10	8	7	6	5,5	5	4,5	4	3
Anzahl der Durchgänge		4-6	4-7	4-8	5-9	6-10	7-12	7-12	8-14	9-16	10-18	11-18	11-19	12-20	12-20	12-20	15-24
Anzahl der Durchgänge	(CCN7525)	3-4	3-4	3-5	4-6	5-6	6-8	6-8	8-10								
Anzahl der Durchgänge	Mini Platten	6-9	6-11	6-12	8-14	9-15	11-18	11-18									

### Mehrzahn-Gewindeplatten

Standard	Platte	Plattengröße		Steigung (TP)	Zähnezahl (NT)	Bezeichnung	Durchgänge	Schnitttiefe pro Durchgang		
		IC	L mm					1	2	3
ISO außen	M	3/8"	16	1,0 mm	3	3 ER 1.0 ISO 3M	2	0,38	0,25	
ISO außen	M	3/8"	16	1,5 mm	2	3 ER 1.5 ISO 2M	3	0,42	0,30	0,20

# Steigungswinkel

## Wichtige Angaben zur Standard-Unterlegplatte

- ▲ der Steigungswinkel sollte immer über Berechnung oder mithilfe des untenstehenden Diagramms ermittelt werden.
- ▲ die Gewindeklemmhalter haben einen 1,5° geneigten Plattensitz und eine Unterlegplatte ohne Winkelkorrektur. Somit haben die Klemmhalter im Auslieferungszustand einen Steigungswinkel  $\beta$  von 1,5°.



Ohne die entsprechende Korrektur des Steigungswinkels kann es passieren, dass

- ▲ das Profil verzerrt wird.
- ▲ die Wendeplatte aufsitzt – zu wenig Freiwinkel hat.
- ▲ die Standzeit der Wendeplatte stark minimiert wird.

## Methode 1: Berechnung

Berechnung des Steigungswinkels  $\beta$ :

$$\beta = \frac{20 \times TP}{DMIN}$$

20 = konstant  
 $\beta$  = Steigungswinkel (°)  
 TP = Steigung (mm)  
 DMIN = Nenndurchmesser (mm)

Für Trapez:  
 $\frac{15 \times TP}{DMIN}$

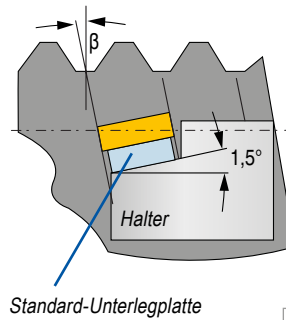

Beispielberechnung

Außengewinde M24 x 1,5  
 Vorschub in Richtung Futter  
 DMIN = Nenn-Ø: M24 = 24 mm  
 TP = Steigung: 1,5 mm

$$\beta = \frac{20 \times 1,5 \text{ mm}}{24 \text{ mm}}$$

$$\beta = 1,25^\circ$$

## Methode 2: Diagramm

Vom Flanken-Ø im Diagramm wird eine Linie senkrecht nach oben gezogen, bis diese sich mit der Linie der Steigung des zu erzeugenden Gewindes kreuzt. In der farblich gekennzeichneten Region, in der man sich nun befindet, zeigt es am Rand des Diagramms den entsprechenden Faktor an.

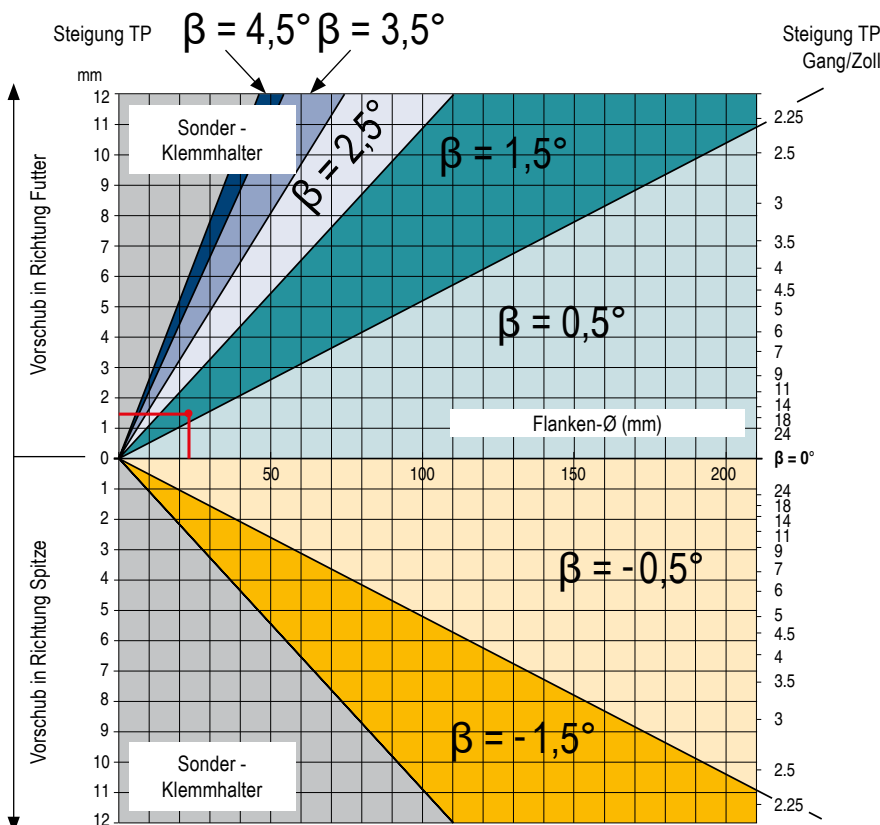

errechneter Steigungswinkel $\beta$ -Wert	Korrekturwinkel $\alpha$
0,0°–0,49°	-1,5°
0,5°–0,99°	-1°
1,0°–1,99°	0°
2,0°–2,99°	+1°
3,0°–3,99°	+2°
4,0°–4,99°	+3°
0,0°–(-0,49°)	-2°
-0,5°–(-1,5°)	-3°

## Bezeichnungsschlüssel – Wendeschneidplatten

16		E		R	
Plattengröße		Platte		Schneidenausführung	
L	I.C.	E	außen	R	rechts
06	5/32"	I	innen	L	links
08	3/16"			N	neutral
11	1/4"				
16	3/8"				
22	1/2"				



Beispiel

**16 ER AG 60**

16er rechts – Außenplatte mit einer Steigung von 0,5–3,0 mm

## Bezeichnungsschlüssel – Halter

SE		R		1212	
Halter		Schneidenausführung		Schaftquerschnitt	
SE	außen	R	rechts	Beispiel	
SI	innen	L	links	Außenhalter	1212 = 12 mm x 12 mm
				quadratischer Schaft	
				Innenhalter	0020 = 20 mm
				Bohrstange	Durchmesser



Beispiel

**SE R 1212 F 16**rechter Außenhalter mit 12 x 12 mm quadratischem Schaft,  
Gesamtlänge von 80 mm, nur für eine 16er Gewindeschneidplatte geeignet

## AG 60

### Steigung (TP/TPI)

Vollprofil		mm	G/Z
		0,35	72-4
Teilprofil		mm	G/Z
A		0,5-1,5	48-16
AG		0,5-3,0	48-8
M		1,7-2,0	14-11
G		1,75-3,0	14-8
N		3,5-5,0	7-5
U		5,5-8,0	4,5-3,5

Flankenwinkel  
55°  
60°

### Zähnezahl (NT)

<b>2M</b>	Mehrzahnplatte mit 2 Zähnen
<b>3M</b>	Mehrzahnplatte mit 3 Zähnen

## F

### Gesamtlänge

	mm
F	80
H	100
K	125
L	140
M	150
P	170
R	200
S	250
T	300

## 16

### Plattengröße

L	I.C.
06	5/32"
08	3/16"
11	1/4"
16	3/8"
22	1/2"

### Eigenschaften

<b>B</b>	mit Innenkühlung
<b>C</b>	mit Hartmetallschaft
<b>U</b>	neutraler Halter



## Problembeseitigung

### Ausbröckelung

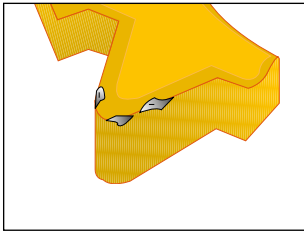

#### Ursachen

- ▲ tritt häufig bei rostfreien Werkstückstoffen auf
- ▲ Hartmetallsorte falsch

#### Maßnahmen

- ▲ Überhang des Werkzeugs vermeiden
- ▲ prüfen, ob die Gewindeschneidplatte richtig festgeklemmt ist
- ▲ Vibrationen vermeiden
- ▲ eine zähere Hartmetall-Qualität benutzen

### Kolkverschleiß

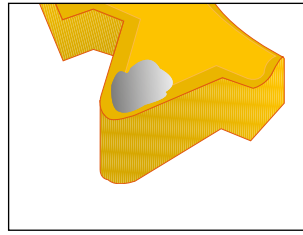

#### Ursachen

- ▲ tritt häufig bei rostfreien Werkstückstoffen auf
- ▲ Schnittgeschwindigkeit zu hoch
- ▲ Hartmetallsorte falsch

#### Maßnahmen

- ▲ Kühlflüssigkeit auftragen
- ▲ Schnitttiefe reduzieren
- ▲ eine härtere Hartmetall-Qualität benutzen

### Aufbauschneiden

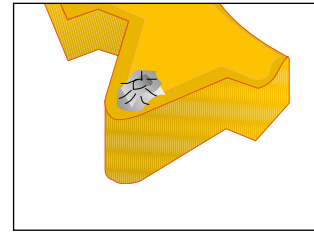

#### Ursachen

- ▲ Schnittgeschwindigkeit zu niedrig
- ▲ Hartmetallsorte falsch

#### Maßnahmen

- ▲ Kühlflüssigkeit auftragen
- ▲ Schnittgeschwindigkeit erhöhen
- ▲ eine zähere Hartmetall-Qualität benutzen

### Wärmerisse

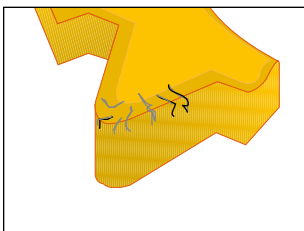

#### Ursachen

- ▲ zu wenig Kühlschmiermittel
- ▲ Schnittgeschwindigkeit zu hoch
- ▲ Hartmetallsorte falsch

#### Maßnahmen

- ▲ Kühlflüssigkeit auftragen
- ▲ Schnittgeschwindigkeit minimieren
- ▲ eine zähere Hartmetall-Qualität benutzen

### Verformung

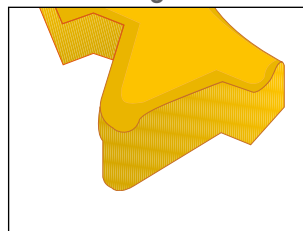

#### Ursachen

- ▲ Zustellung zu groß
- ▲ zu wenig Kühlschmiermittel
- ▲ Schnittgeschwindigkeit zu hoch
- ▲ Hartmetallsorte falsch

#### Maßnahmen

- ▲ Kühlflüssigkeit auftragen
- ▲ Schnitttiefe reduzieren
- ▲ Schnittgeschwindigkeit minimieren
- ▲ eine härtere Hartmetall-Qualität benutzen

### Brechen

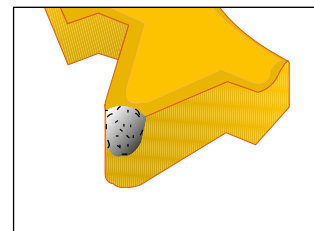

#### Ursachen

- ▲ Zustellung zu groß
- ▲ zu wenig Kühlschmiermittel
- ▲ plastische Verformung
- ▲ instabil
- ▲ Steigungswinkel nicht passend
- ▲ Hartmetallsorte falsch

#### Maßnahmen

- ▲ Schnitttiefe reduzieren
- ▲ Maschine und Werkzeugstabilität prüfen
- ▲ Schnittgeschwindigkeit reduzieren
- ▲ Steigungswinkel beachten
- ▲ eine zähere Hartmetall-Qualität benutzen

## Sortenbeschreibung

### Universal

**CCN7525**

- ▲ Hartmetall, TiAlN-beschichtet
- ▲ ISO | P25 | M25 | K25 | S25 | H25
- ▲ Die universelle Hartmetallsorte mit gesintertem Spanbrecher für mittlere bis hohe Schnittgeschwindigkeiten

**CCN2520**

- ▲ Hartmetall, TiAlN-beschichtet
- ▲ ISO | P25 | M25 | K25 | S25 | H25
- ▲ Die beschichtete Hartmetallsorte für die Zerspanung von rostfreien Stählen bei mittleren bis hohen Schnittgeschwindigkeiten

**CCN1525**

- ▲ Hartmetall, TiN-beschichtet
- ▲ ISO | P25 | M25 | K25 | N25 | O25
- ▲ Die beschichtete Hartmetallsorte für die Bearbeitung von Stählen und rostfreien Stählen bei niedrigen Schnittgeschwindigkeiten

### NE-Metalle

**CWK20**

- ▲ Hartmetall, unbeschichtet
- ▲ ISO | M10 | K10 | N10 | S10
- ▲ Die verschleißfeste Hartmetallsorte für die Bearbeitung von Aluminium und anderen NE-Metallen

### Stahl

**CCN20**

- ▲ Hartmetall, TiAlN-beschichtet
- ▲ ISO | P20 | M20 | K20 | S20 | H20
- ▲ Die Allround-Hartmetallsorte für die Bearbeitung von Stählen bei niedrigen Schnittgeschwindigkeiten

**CWN1525**

- ▲ Hartmetall, TiN-beschichtet
- ▲ ISO | P25 | M25 | K25 | N25 | O25
- ▲ Die universelle Hartmetallsorte für die Bearbeitung von Stählen und NE-Metallen bei niedrigen Schnittgeschwindigkeiten

### Rostfrei

**HCN2525**

- ▲ Hartmetall, TiAlN-beschichtet
- ▲ ISO | P25 | M25 | K25 | N25 | S25 | H25
- ▲ Die beschichtete Hartmetallsorte für die Zerspanung von rostfreien Stählen bei hohen Schnittgeschwindigkeiten
- ▲ Auch für exotische Materialien geeignet

## Profilklärung

### Vollprofil

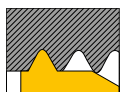

- ▲ Kerndurchmesser muss nicht auf fertigen Kerndurchmesser gebracht werden
- ▲ eine Mindestzustellung von 0,07 mm ist erforderlich
- ▲ Platte kann nur für eine Steigung verwendet werden

- Vorteile:**
- ▲ qualitativ hochwertiges Gewinde
  - ▲ keine Gratbildung
  - ▲ kein Nachbearbeiten
  - ▲ z. T. höhere Standzeiten

### Teilprofil



- ▲ Kerndurchmesser muss auf Fertigmaß vorbearbeitet werden
- ▲ eine Mindestzustellung von 0,07 mm ist erforderlich

- Vorteile:**
- ▲ mit einer Gewindeschneidplatte können mehrere Steigungen gefertigt werden
  - ▲ Gewindeschneidplatte somit universell einsetzbar
  - ▲ geringe Lagerhaltung

### Mehrzahn-Gewindeschneidplatte



- ▲ Kerndurchmesser muss nicht auf fertigen Kerndurchmesser gebracht werden
- ▲ eine Mindestzustellung von 0,07 mm ist erforderlich
- ▲ Platte kann nur für eine Steigung verwendet werden

- Vorteile:**
- ▲ weniger Durchgänge erforderlich
  - ▲ zeitreduzierende Gewindeherstellung

**Achtung:** ▲ auf genügend Gewindeauslauf achten

### Mini-Gewindeschneidplatte



- ▲ ab einem min. Kernlochdurchmesser von  $\varnothing 6$  mm bzw.  $\varnothing 8$  mm



- Vorteile:**
- ▲ spezielle Schneidstoffe für niedrige Schnittgeschwindigkeiten
  - ▲ 3 Schneiden bei Minianwendungen